



Plumb Supply

COMPANY

2017

Plumbing Products

Vol. 3

BRANCH LOCATIONS

	Location	Address	Phone	Fax
Iowa	Ames	2408 E Lincoln Way Ames, IA 50010	515-233-5737	515-233-5539
	Cedar Rapids	4700 J St. SW Cedar Rapids, IA 52404	319-366-7891	319-366-8758
	Davenport	4601 Grand Ave Davenport, IA 52807	563-391-0240	563-391-0695
	Des Moines	1622 NE 51st Ave Des Moines, IA 50306	515-262-9511	515-262-9790
	Dubuque	600 Cedar Cross Rd Dubuque, IA 52003	563-556-2827	563-556-5693
	Fort Dodge	1565 Cardinal Ave Fort Dodge, IA 50501	515-573-8161	515-573-7558
	Iowa City	1925 Boyrum St. Iowa City, IA 52240	319-351-1004	319-354-3169
	Iowa City Showroom	214 Southgate Ave Iowa City, IA 52240	319-351-5010	319-351-4995
	Le Mars	436 2nd Ave NE Le Mars, IA 51031	712-546-8129	515-957-5334
	Marshalltown	207 Iowa Ave E Marshalltown, IA 50158	641-753-2847	641-753-2856
	Mason City	45 19th St. SW Mason City, IA 50401	641-423-0164	641-423-0462
	Muscatine	1418 S Houser Muscatine, IA 52761	563-264-8655	563-264-5898
	North Cedar Rapids	1716 Blairs Ferry Rd NE Cedar Rapids, IA 52402	319-393-1441	319-393-1211
	Ottumwa	420 Gateway Dr Ottumwa, IA 52501	641-682-8357	641-628-2307
	Pella	208 SE 9th St. Pella, IA 50219	641-620-1406	641-620-8204
	Red Oak	1949 G Ave Red Oak, IA 51566	712-623-4841	712-623-4843
	Spirit Lake	3010 Hwy 9 W Spirit Lake, IA 51360	712-336-0787	712-336-3609
	Waterloo	3338 W Airline Hwy Waterloo, IA 50703	319-236-1511	319-236-0218
	Waukee	920 Frontier Ave Waukee IA 50263	515-987-2802	515-987-3579
	Kansas . . Missouri .	Lenexa	14936 W 101st Terrace Lenexa, KS 66215	913-782-7455
Branson		110 Warehouse Rd Branson, MO 65616	417-335-4554	417-335-4572
Columbia		2412 Bus Loop 70 E Columbia, MO 65201	573-875-3131	573-449-8738
Columbia HVAC		1112 Smith St. Columbia MO 65201	573-874-5661	573-874-5677
Columbia Showroom		1729 W Broadway Columbia, MO 65203	573-445-4481	573-446-2058
Hannibal		4385 Paris Gravel Rd Hannibal, MO 63401	573-221-0142	573-221-0148
Jefferson City		912 W McCarty Jefferson City, MO 65109	573-415-9173	573-634-7260
Jefferson City Showroom		2027 Christy Dr Jefferson City, MO 65101	573-634-4515	573-634-6017
Kirkville		405 W Hickory St. Kirkville, MO 63501	660-665-2626	660-665-9997
Laurie		203 S Main Laurie, MO 65038	573-374-8899	573-374-8893
Liberty		2108 Kara Ct. Suite D Liberty, MO 64068	816-335-3020	813-781-8555
Marshall		735 N Miami Marshall, MO 65340	660-886-5151	660-886-5854
Mexico		622 E Liberty Mexico, MO 65265	573-581-6842	573-581-7712
Moberly		518 Johnson Moberly, MO 65270	660-263-1280	660-263-0929
Osage Beach		924 Hwy 42 Osage Beach, MO 65065	573-348-2253	573-348-2443
Rolla		11208 Twitty Dr Rolla, MO 65401	573-364-5211	573-341-5446
Springfield		2234 E Olive Court Springfield, MO 65802	417-865-8770	417-865-1056
Warrensburg		133 Railroad Warrensburg, MO 64093	660-429-3555	660-429-3581
Washington		205 E 8th St. Washington, MO 63090	636-239-1969	636-239-2045



Plumbing • HVAC • PVF

General Conditions

This price service has been designed to assist you in estimating your jobs. It is our sincere desire to maintain the necessary inventory to satisfy your requirements, but we do not stock all of the items in this catalog.

All orders are subject to approval by our credit department, and the possession of this price service is not to be construed as an offer to sell.

All prices are subject to change without notice and due to market conditions over which we have no control, cannot be guaranteed. Orders will be accepted on the basis of the market price prevailing at the time of shipment.

We cannot be held responsible for any errors or omissions in the price service.

Taxes

Sales tax will be added to all invoices unless you have furnished us with a Sales Tax Exemption Certificate for your purchases.

Return Goods

Materials may be returned for credit with prior approval and authorization from our office. Any material claimed defective that is covered by factory warranty must be accompanied by the necessary warranty information. When authorization to return goods is requested, the date of the purchase and our invoice number must be given to either our salesperson or the office.

Special Materials or Non-Stock Orders

Orders for non-stock or special items cannot be cancelled or returned for credit without factory approval. If approval is obtained, credit will be allowed for the net salvage value allowed by the factory.

Warranty

The products we sell are guaranteed only to the extent of the manufacturer's warranty. No allowances will be made for labor, damage or kindred claims, and Plumb Supply Company cannot be held liable for any product liability claims, freight shortages or other claims over which we have no control.



Table of Contents

Appliances

Disposers.....	1
----------------	---

Commercial Specialty Fixtures

Commercial Specialty Fixtures.....	12
------------------------------------	----

Drains, Carriers, & Sumps

Cast Iron Roof Drains.....	13
Closet Carriers.....	16
Lavatory Carriers.....	18
Urinal Carriers.....	19
Cast Iron Floor Drains.....	20
Cleanouts.....	32
Equalizer Chambers & End Caps.....	37
Grease Traps.....	39
Interceptors.....	41
Plastic Floor Drains.....	42
Sewage Ejectors.....	51
Sumps - Pits & Septic Tanks.....	56
Sump Pumps.....	66
Trench Drains.....	85

Faucets & Valves

Bar Faucets.....	88
Body Sprays.....	118
Commercial.....	124
Self-Closing Faucets.....	137
Commercial Shower Faucets.....	139
Lavatory Faucets - Commercial.....	143
Commercial - Institutional Faucets.....	148
Commercial.....	163
Commercial - Institutional Faucets.....	169
Commercial.....	172
Commercial - Institutional Faucets.....	173
Digital Shower Trim.....	175
Faucet Accessories.....	178
Faucet Handles.....	181
Flush Valves.....	191
Generic Replacement Parts.....	204



Table of Contents

Faucets & Valves (Continued)

Hot Water Dispensers.....	208
Kitchen Faucets & Accessories.....	210
Soap Dispensers.....	227
Kitchen Faucets & Accessories.....	229
Soap Dispensers.....	238
Kitchen Faucets & Accessories.....	239
Soap Dispensers.....	257
Kitchen Faucets & Accessories.....	259
Soap Dispensers.....	270
Kitchen Faucets & Accessories.....	271
Soap Dispensers.....	277
Kitchen Faucets & Accessories.....	278
Lavatory - Single Hole.....	291
Lavatory Faucets - Single Hole.....	298
Lavatory - Single Hole.....	312
Lavatory Faucets - 4" Center.....	324
Lavatory - Centerset.....	334
Lavatory - Widespread.....	341
Laundry/Utility Faucets.....	377
Personal Showers & Accessories.....	384
Delta Faucet Repair Parts.....	419
Rough-In Valves.....	422
Shower Heads, Arms & Flanges.....	441
Shower Faucets.....	474
Steam Generator Components.....	559
Tub & Shower Faucets.....	561
Tub Faucets.....	601
Tub Spouts.....	647
Peerless Faucets.....	662
Wall Hydrants.....	666
Yard Hydrants.....	672

Fire Safety

Fire Safety.....	675
------------------	-----

Pipe Fittings

Aqua-PEX Fittings.....	676
Black Steel Fittings.....	689
Brass Fittings.....	695



Table of Contents

Pipe Fittings (Continued)

Brass Flare Fittings.....	701
Brass OD Compression Fittings.....	703
Cast Iron Fittings.....	706
Chrome-Plated Fittings.....	707
Chrome-Plated Nipples.....	707
Copper Grooved CTS Fittings.....	709
Copper Pressure Fittings.....	710
Copper Ftgs-Cleaned&Bagged.....	725
Copper DWV Fittings.....	727
CPVC Schedule 80 Fittings.....	731
CPVC (CTS) Fittings.....	734
Dielectric Unions.....	736
Extra-Heavy Fittings.....	738
Flexible Couplings.....	741
Flexible Gas Fittings.....	746
Flo Control PVC Fittings.....	752
Galvanized Steel Fittings.....	753
Geothermal Fittings.....	757
Grooved Fittings.....	758
Insert Fittings.....	766
Iron & Carbon Steel Fittings & Nipples.....	770
John Guest Fittings.....	772
Lav Waste Fittings.....	773
Orion Rionfuse Fittings.....	775
Polysulfone Push-Fittings.....	776
ProPress System.....	777
PVC - DWV Fittings.....	788
PVC Schedule 40 Fittings.....	798
PVC Schedule 80 Fittings.....	805
PVC Sewer Fittings.....	810
Rigid Couplings & Repair Clamps.....	813
Sharkbite Fittings.....	815
Soil No-Hub Fittings.....	816
Soil SV Fittings.....	821
TecTite Fittings.....	829
Viega-PEX Fittings.....	831
Viega Manifolds.....	836
Viega PEX Tools.....	838
Watts-PEX Fittings.....	839
Watts Quick Connect Fittings.....	846



Table of Contents

Pipe Fittings (Continued)

Weld Fittings.....	847
304SS/316SS 150# FTGS.....	850
304/316 SS 150# Nipples.....	854
Socket Weld 304SS/316SS/L 3000# FTGS.....	857
Forged Carbon Steel Fittings.....	859
316SS Compression Fittings.....	864
Zurn-PEX Fittings.....	865

Lavatories

Bathroom Sink Accessories.....	871
Pedestal Lavatories.....	872
Top-Mount Lavatories.....	886
Under-Mount Lavatories.....	906
Vessel Bowl Lavatories.....	922
Wall Hung Lavatories.....	929

Cleaners & Lubricants

Cleaners.....	936
Lubricants.....	940

Pipe

Acid Waste Pipe.....	945
Aluminum Tubing.....	946
Black Steel Pipe.....	949
Cast Iron Pipe & Fittings.....	951
Copper Pipe.....	952
CPVC Pipe.....	955
Flexible Gas Pipe.....	958
Gas Flex Connectors.....	960
Galvanized Steel Pipe.....	962
PEX Tubing.....	963
PEX Tubing - Radiant.....	971
Polyethylene Pipe.....	973
PVC Pipe.....	977
Stainless Steel Pipe.....	979
Underground Gas Pipe & Ftgs.....	980
Vinyl Tubing.....	986



Table of Contents

Piping Supplies & Accessories

Anchors.....	989
Cable Ties.....	998
DWV Pipe Hangers.....	1002
Duct Hangers.....	1003
Flashings.....	1004
Flow Meters.....	1008
Hanger Straps.....	1010
Heating Cables.....	1015
Innerlynx Modular Seal.....	1016
Pipe Pier.....	1017
Plastic Hangers.....	1018
Potable Water Expansion.....	1024
Pipe Cutting Oil.....	1026
Pipe Sleeving.....	1028
Pressure Gauges.....	1029
Sealants, Cements & Lubricants.....	1032
Soldering & Brazing.....	1052
Spacer Caps.....	1084
Stainless Steel Clamps.....	1086
Steel Hangers.....	1087
Struts.....	1096
Strut Hangers.....	1099
Threaded Rods, Bolts, Nuts, & Gaskets.....	1103
Tubing Brackets.....	1110
Vacuum Breakers.....	1115

Plumbing Miscellaneous

Access Panels.....	1117
Adhesives & Sealants.....	1121
Boxes.....	1124
Caulk.....	1133
Chemicals.....	1138
Cleanouts & Covers.....	1146
Concrete Mix & Gravel.....	1151
Fire Caulk & Fire Rated Boxes.....	1153
Ice Maker Kits.....	1158
Knock Out Test Caps.....	1162
Lavatory Insulation Kits.....	1163
Log Lighters.....	1166



Table of Contents

Plumbing Miscellaneous (Continued)

Pans.....	1169
Putty.....	1172
Shock Arrestors.....	1177
Stud Guards.....	1181
Test Plugs & Balls.....	1184
Vents.....	1195

Showers

Pan Lining/Solvent/Sheet Lead.....	1202
Showers.....	1203
Shower Bases & Accessories.....	1223
Shower Bases.....	1224
Shower Bases & Accessories.....	1225
Shower Doors.....	1234
Shower Rods.....	1239
Shower Walls.....	1242

Sinks

Bar/Entertainment Cast Iron Sinks.....	1253
Bar/Entertainment Stainless Steel Sinks.....	1256
Bar/Entertainment Composite Sinks.....	1275
Commercial Stainless Steel Sinks.....	1278
Copper Sinks.....	1290
Kitchen Cast Iron Sinks.....	1291
Kitchen Fireclay Sinks.....	1315
Kitchen Composite Sinks.....	1318
Kitchen Sink Accessories.....	1339
Kitchen Stainless Steel Sinks.....	1347
Kitchen Sink Accessories.....	1365
Kitchen Stainless Steel Sinks.....	1366
Floor Sinks.....	1398
Mop & Utility Sinks.....	1399

Supplies & Fittings

Adapters.....	1418
Bath Supplies.....	1420
Closet Kits.....	1421
Closet Supplies.....	1425



Table of Contents

Supplies & Fittings (Continued)

Dishwasher Supply Hoses.....	1429
Escutcheons.....	1434
Lavatory Kits.....	1440
Lavatory Supplies.....	1444
Nuts & Washers.....	1450
Stops - Angle.....	1452
Stops - Straight.....	1460
Washing Machine Supply Hoses.....	1465
Water Heater Supply Hoses.....	1466
Water Heater Supply Hose.....	1468

Toilets

Bidet's & Bidet Faucets.....	1469
Bolts & Caps.....	1471
Bowl Wax.....	1477
Closet Flanges, Spuds, & Flush Ells.....	1481
Commercial Closets.....	1493
Closet Bowls.....	1500
Closet Tanks.....	1515
Elongated Closets.....	1530
Gaskets.....	1556
Macerating Toilet Systems.....	1564
One-Piece Closets.....	1565
Round Front Closets.....	1576
Tank Parts.....	1588

Toilet Seats

Commercial Toilet Seats.....	1609
Residential Plastic Toilet Seats.....	1614
Residential Wood Toilet Seats.....	1623

Tools

Drill Bits.....	1629
Flaring Tools.....	1643
Flashlights.....	1646
Hammers.....	1653
Hand Sewer Machines.....	1655
Hole Saws.....	1662



Table of Contents

Tools (Continued)

HVAC Testing Tools.....	1670
Knives & Replacement Blades.....	1680
Levels.....	1687
Miscellaneous Tools.....	1692
Pipe Cutters - Copper.....	1712
Pipe Cutters - PEX.....	1718
Pipe Cutters - Plastic.....	1719
Pipe Cutters - Soil Pipe.....	1725
Pipe Cutters - Steel.....	1726
Pipe Taps.....	1728
Pipe Threaders.....	1730
Pliers & Wire Strippers.....	1733
Power Sewer Machines.....	1742
Power Tools.....	1745
Refrigeration Tools.....	1778
Rulers & Tape Measures.....	1787
Saws & Blades.....	1791
Screwdrivers & Bits.....	1809
Sheet Metal Tools.....	1827
Shovels.....	1838
Trouble Lights/Extension Cords.....	1840
Wrenches.....	1843

Tub Showers

Fiberglass Tub Showers.....	1857
Tub Shower Doors.....	1862
Vikrell - Sterling Tub Showers.....	1864

Tubs

Airbaths.....	1868
Soaking Tubs.....	1879
Tub Walls.....	1905

Tubular, Strainers, Bathwastes & Drains

Bath Wastes.....	1907
Bath Waste.....	1924
Disposer Flanges.....	1925
Disposer Kits.....	1929



Table of Contents

Tubular, Strainers, Bathwastes & Drains (Continued)

Disposer Flanges.....	1930
Extension Tubes & Elbows.....	1931
Grid Drains & PO Plug Drains.....	1934
J-Bends.....	1943
P-Traps.....	1944
S-Traps.....	1949
Shower Drains.....	1950
Sink Strainers.....	1958
Sink Wastes.....	1972
Tailpieces.....	1975
Washers, Nuts & Stoppers.....	1978

Urinals

Urinals.....	1983
--------------	------

Valves

Backflow Valves.....	1993
Backwater Valves.....	2002
Ball Valves - Potable.....	2009
Ball Valves - Non-Potable.....	2016
Ball Valves - Potable.....	2017
Ball Valves - Non-Potable.....	2018
Butterfly Valves - Non-Potable.....	2023
Check Valves - Potable.....	2026
Check Valves - Non-Potable.....	2028
Gas Stop Valves.....	2034
Gate Valves - Non-Potable.....	2036
Gate Valves.....	2039
Globe Valves.....	2040
Hose Bibbs.....	2041
Meter Valves.....	2044
Relief Valves.....	2046
Sillcock Valves.....	2052
Stop Valves.....	2053
Valves - Miscellaneous.....	2055
Wye Strainers.....	2061



Table of Contents

Vanity Cabinets & Hardware

Miscellaneous Accessories.....	2063
Towel Bars & Rings.....	2069
Bath Accessories.....	2077
Towel Bars & Rings.....	2081
Paper & Tissue Holders.....	2095
Robe Hooks.....	2105
Misc Accessories.....	2114
Grab Bars.....	2118
Medicine Cabinets & Mirrors.....	2130
Vanities.....	2137
Vanity Tops.....	2144

Water Heaters

Commercial Electric Water Heaters.....	2145
Commercial Gas Water Heaters.....	2146
Indirect Water Heaters.....	2149
Residential Electric Water Heaters.....	2150
Residential Gas Water Heaters.....	2155
Tankless Water Heaters.....	2163
Water Heater Accessories.....	2172

Water Fountains & Coolers

Water Fountains & Coolers.....	2174
--------------------------------	------

Water Systems

Enviroplug - Bentonite.....	2204
Jet Pumps.....	2205
Submersible Pumps.....	2208
Water Service Accessories.....	2211
Water System Accessories.....	2218
Water System Tanks.....	2223

Water Treatment

Reverse Osmosis Systems.....	2224
Water Conditioners.....	2226
Water Filter Cartridges.....	2227
Water Softeners.....	2234
Water Treatment Chemicals.....	2237



Table of Contents

Water Works

Miscellaneous Water Works.....	2239
Water Meters.....	2240
Water Service Fittings.....	2242
Water Service Stops.....	2247

Whirlpools

Whirlpools.....	2251
-----------------	------

Work Wear

Gloves, Ear Plugs, Goggles, ETC.....	2271
Work Gear.....	2278
Heated Gear.....	2279
Safety Glasses.....	2283
Shoe Covers.....	2286

Repair Parts

American Standard Repair Parts.....	2290
Basco Repair Parts.....	2291
Bell & Gossett Repair Parts.....	2292
Bradley Washfountain Repair Parts.....	2294
Chicago Faucet Repair Parts.....	2295
Dearborn Brass Repair Parts.....	2298
Delta Faucet Repair Parts.....	2299
Elkay Repair Parts.....	2316
Empire Comfort Repair Parts.....	2318
Fenner Drives Repair Parts.....	2319
Franklin Electric Repair Parts.....	2320
General Filter Repair Parts.....	2321
Gerber Repair Parts.....	2322
Hi-Velocity (Energy Savings Products) Repair Parts.....	2323
Hydron Module Repair Parts.....	2324
Honeywell Repair Parts.....	2325
Jones Stephens Repair Parts.....	2328
Kohler Repair Parts.....	2329
Malco Repair Parts.....	2341
McDonnell & Miller Repair Parts.....	2342
Moen Repair Parts.....	2343
EL Mustee Repair Parts.....	2347



Table of Contents

Repair Parts (Continued)

Navien Repair Parts.....	2348
Reznor Repair Parts.....	2349
Rinnai Repair Parts.....	2352
Ruud Water Heater Repair Parts.....	2354
Schwank Repair Parts.....	2359
Sloan Repair Parts.....	2360
Speakman Repair Parts.....	2368
T & S Brass Repair Parts.....	2369
Taco Repair Parts.....	2370
Thermolec Repair Parts.....	2371
Triangle Tube Repair Parts.....	2372
Union Brass Repair Parts.....	2373
Ruud Heating & AC Repair Parts.....	2374
Water Right Repair Parts.....	2401
Watts Regulator Repair Parts.....	2402
Weil McLain Repair Parts.....	2403
Westinghouse/Philco Repair Parts.....	2408
Woodford Repair Parts.....	2411
Zoeller Repair Parts.....	2414

Disposers

Waste Disposers

KaDette™ Continuous Feed Disposal

- Split phase motor
- PVC Grind chamber
- Galvanized steel grind wheel with stainless steel impellers
- Manual reset overload protector
- 1-Year full warranty



Part #	Mfg #	Description	Price
106549	KCDB250G	1/2 hp Continuous Feed	

Superba® Batch Feed Disposal

- SoundSeal™ technology helps maintain a quiet kitchen environment
- MultiGrind® technology grinds food in two stages
- Jam-Sensor™ circuit technology (KCDS100T)
- Manual reset overload protector
- 7-Year limited warranty



Part #	Mfg #	Description	Price
106185	KBDS100T	1 hp Batch Feed	

Superba® Continuous Feed Disposal

- SoundSeal™ technology helps maintain a quiet kitchen environment
- MultiGrind® technology grinds food in two stages
- Jam-Sensor™ circuit technology (KCDS100T)
- Manual reset overload protector
- 5-Year limited warranty



Part #	Mfg #	Description	Price
119129	KCDI075B	3/4 hp Continuous Feed	
106183	KCDS075T	3/4 hp Continuous Feed	
106184	KCDS100T	1 hp Continuous Feed	



Disposers

Disposals

Whirlpool Gold® Continuous-Feed Disposal

- 1,725 rpm
- ABS grind chamber, galv steel grinding wheel & shredder ring
- Stainless steel swivel impellers
- XE - Stainless steel sink flange with 1-piece plastic stopper
- Overload protector with manual reset
- 1-Year full warranty



GC1000XE



GC2000PE



GC2000XE

Part #	Mfg #	Description	Price
106181	GC1000XE	1/3 hp	
106182	GC2000XE	1/2 hp	
113309	GC5000XE	3/4 hp	

Disposal Installation Accessories

Part #	Mfg #	Description	Price
130928	4211615	Splash Guard Gasket	
138619	8174328A	Mounting Assembly for GC1000/GC2000	
147388	8174355A	Mounting Assembly for GC5000XEA	

Appliances

Disposers

Garbage Disposers

GX Series Garbage Disposal

- VORTEX™ motor
- Universal Xpress Mount™
- Power cord preinstalled
- SoundSHIELD™ insulation
- Compact design
- Continuous feed
- Manual reset button
- 6-Year Limited Warranty



Part #	Mfg #	Description	Price
188748	GX50C	1/2 HP	
188746	GX75C	3/4 HP	

GX Pro Series Garbage Disposal

- VORTEX™ motor
- Universal Xpress Mount™
- Power cord preinstalled
- Compact design
- Continuous feed
- 2-Year Limited Warranty



Part #	Mfg #	Description	Price
188750	GXP33C	1/3 HP	
188749	GXP50C	1/2 HP	

*Lifeshine® Anti-Tarnish Lifetime Finish

www.plumbsupply.com • Serving our Customers Since 1946 • www.waterconcepts.net

Disposers

Garbage Disposal

Badger Garbage Disposals

- Dura-Drive® Induction Motor
- Galvanized Steel Construction
- InSinkErator We Come To You® In-Home Full Service Limited Warranty Covers parts and labor
- Made in the USA
- Quick Lock® Sink Mount allows for easy installation and garbage disposal replacement

Part #	Mfg #	Description	Price
102419	Badger-5-XP	Badger 5-XP 3/4 HP Disposal	
005590	Badger-5	Badger 5 1/2 HP Disposal	
005589	Badger 1	Badger 1 1/3 HP Disposal	

Contractor 333 Garbage Disposal

- 3/4 HP Dura-Drive® Induction Motor
- Stainless Steel Drive Components
- Quick Lock® mounting for fast, easy installation

Part #	Mfg #	Description	Price
005659	333	333 Contractor 3/4 HP Disposal	

Pro Series Food Waste Disposal

- Auto-Reverse Grind System Feature
- SoundSeal® technology delivers quieter performance.
- MultiGrind® technology

Part #	Mfg #	Description	Price
175312	Pro-750	Pro 750 3/4 HP Disposal	
210788	Pro-1000L	Pro 1000LP 1.0 HP Disposal	
160835	Pro-1100X	Pro 1100XL 1.1 HP Disposal	

Septic Assist Disposal

- SoundSeal® Technology delivers Quiet, allowing you to hold a conversation with voices in the same room
- MultiGrind® Technology delivers two st and allows you to more efficiently grind items like bones
- 3/4 Horsepower Dura-Drive® Induction Motor is engineered to specifications used for appliance motors, provides quiet operation and long life
- Features Bio-Charge® Injection Technology that utilizes a natural microorganism to help break down food waste
- Helps break down food waste (fats, grease, proteins and starches)
- Deodorizes to help control sink and drain odors
- Safe for drain fields, pipes and the environment
- 40 oz. Stainless Steel Grind Chamber and Components for durability
- Made in the USA
- InSinkErator 4-Year We Come To You® In-Home Full Service Limited Warranty Covers parts and labor
- Quick Lock® Sink Mount allows for easy installation and disposer replacement
- Power cord not included



Part #	Mfg #	Description	Price
196532	Septic	Septic Assist 3/4 HP Disposer	

Insinkerator Parts and Accessories



Part #	Mfg #	Description	Price
105430	08302	RSB-00 Removable Sound Baffle	
092209	09008	CRD-00 Power Cord Assembly	
048156	3173DA	Mounting Assembly	
123321	QLM-00	Quick Lock Mounting Assembly	



Part #	Mfg #	Description	Price
128560	09959	DMG-00 Deluxe Mounting Gasket	
005652	1010A	Mounting Gasket	
005655	1470	Discharge Gasket - Fits all models	
005653	70368	Mounting Gasket - Fits continuous feed models	
025715	70966	Baffle Gasket	

Appliances

Disposers

Insinkerator Parts and Accessories (Continued)

Gasket

Part #	Mfg #	Description	Price
128559	SMG-00	Standard Mounting Gasket	



4310

Stopper



5032

Part #	Mfg #	Description	Price
005663	4310	Plastic Stopper Assembly - Fits All Continuous Feed Models	
005666	5032	Stopper Assembly f/333SS	

Switch



STS-00

Part #	Mfg #	Description	Price
045272	STS-00	Sinktop Switch Dual, Chrome/White Buttons Included	
066102	STC-SN	Sink Top Button Only, Satin Nickel	
117437	STC-ORB	Sink Top Button Only Rubbed Bronze	Oil
203616	STC-MB	Sink Top Button Only Matte Black	

Wrench



Part #	Mfg #	Description	Price
128561	08305	WRN-00 JamBuster® Wrenchette	

Disposers

Disposers

Legend Series 9930 Disposer

- High-speed 2,600 rpm permanent magnet motor
- 115V, 60Hz
- Stainless steel, rust free grinding components
- Sound insulated for quiet operation
- Continuous feed
- Safe for properly sized septic tanks
- Professional 3-bolt mount system
- 5-Year in-home service warranty
- Lifetime corrosion warranty



Part #	Mfg #	Description	Price
106093	9930	1/2 hp	

On/Off Fiber Optic Controller for Garbage Disposer

- Conveniently operates the disposer with a press of a button
- Remote switch has no wiring connections or code restrictions
- Requires 3/8" drill hole



Part #	Mfg #	Finish	Price
140037	FRC4016	Fiber Optic Controller Base Unit	
140038	FOS4017-SN	Satin Nickel	
140041	FOS4017-CHBL	Chrome & Black	

Disposers

Garbage Disposal Cords

- 16/3 Gauge wire



Part #	Mfg #	Description	Price
041966	E25-015	3' Straight Plug Disposal Cord	
109985	E25-016	6' Straight Plug Disposal Cord	

Garbage Disposal Wiring Kits

- Complete with (3) wire nuts and connector coupling
- 16/3 Gauge wire



Part #	Mfg #	Description	Price
132623	E25-115	Kit for 3' Cord w/Straight Plug	
132624	E25-116	Kit for 6' Cord w/Straight Plug	

Disposers

Extension/Replacement Cords

Power Supply Cord

- For disposals, appliances, power tools, etc.



Appliances

Part #	Mfg #	Description	Price
126207	13974	3' 16/3 SJTWA	

Disposers

Waste Disposer Parts

"Classic Touch" Waste Disposer Air Switch

- Can be used with all continuous feed waste disposers
- UL Approved
- 1-3/8" Mounting hole
- Air actuated - no tools required



Part #	Mfg #	Finish	Price
101372	MT951CPB	Pol Chrome	
063585	MT951BRN	Brushed Nickel	
083101	MT951BRS	Brushed Stainless	
082563	MT951ORB	Oil Rubbed Bronze	
095043	MT951VB	Venetian Bronze™	

*PVD Finish

www.plumbsupply.com • Serving our Customers Since 1946 • www.waterconcepts.net



Disposer Switches

Disposer Switches

Waste Disposal Air Switch

- Air activated
- Work with all continuous feed waste disposers with power cords
- UL Approved



Part #	Mfg #	Finish	Price
115920	2822-ORB	Oil Rubbed Bronze	
115918	2822-SN	Satin Nickel	

Appliances

Disposers

Decorator Disposer Parts
Decorator Plastic Disposer Flange
Drain Assembly 3-1/2" Bowl



Part #	Mfg #	Color	Price
003237	D9BC	Biscuit	
061816	D9BL	Black	
003236	D9BNE	Bone	

Commercial Specialty Fixtures

Safety Fixtures

Laboratory Swing Activated Facewash Fixture

- Space saving design
- Chrome-plated brass pipe and fittings
- Exceeds minimum water flow of 3 gpm at 30 psi
- One step activation meets ANSI standard Z358.1-2009



Part #	Mfg #	Description	Price
075737	S19-270E	Facewash Fixture	

Halo Wall-Mounted Eyewash Station with Plastic Bowl

- Galvanized steel supply and waste pipes protected with BradTect® safety yellow coating
- Includes universal identification sign and inspection tag
- Exceeds minimum water flow of 0.4 gpm at 30 psi
- Barrier-free design
- Complies with ANSI standard Z358.1



Part #	Mfg #	Description	Price
147462	S19224EW	Eyewash Station w/Plastic Bowl	

Halo Combination Drench Shower/Eyewash Fixture with Plastic Bowl & Showerhead

- SpinTec™ showerhead provides consistent distribution of water
- Galvanized steel protected with BradTect® safety yellow coating
- Includes universal identification sign and inspection tag
- Drench shower exceeds minimum water flow of 20 gpm at 30 psi
- Eyewash exceeds minimum water flow of 0.4 gpm at 30 psi
- Complies with ANSI standard Z358.1



Part #	Mfg #	Description	Price
147465	S19314EW	Eyewash, Plastic Bowl, & Showerhead	

Halo Eye-Face Wash, Plastic Showerhead (No Bowl)

- SpinTec™ showerhead provides consistent distribution of water
- Galvanized steel protected with BradTect® safety yellow coating
- Includes universal identification sign and inspection tag
- Drench shower exceeds minimum water flow of 20 gpm at 30 psi
- Eye-Face Wash exceeds minimum water flow of 3 GPM at 30 PSI
- Complies with ANSI standard Z358.1



Part #	Mfg #	Description	Price
147467	S19314GG	Eye-Face wash, Plastic Showerhead (No Bowl)	

Commercial Specialty Fixtures

Cast Iron Roof Drains

Roof Drains

RD-100 Series Large Area Roof Drain

- Epoxy-coated cast iron
- Includes flashing clamp with integral gravel stop, self-locking polyethylene dome, and no hub (standard) outlet
- Options:
 - Suffix B = Sump receiver
 - Suffix D = Under deck clamp
 - Suffix F = Adjustable extension flange
 - Suffix K = Ductile iron dome
 - Suffix R = 2" External water dam
 - Suffix W = Adjustable internal water dam



Part #	Mfg #	Description	Price
046410	RD-102	For 2" Pipe	
073212	RD-102-B-D	For 2" Pipe	
046792	RD-102-D	For 2" Pipe	
128371	RD-102-F	For 2" Pipe	
128393	RD-102-F-K	For 2" Pipe	
128397	RD-102-F-K-W	For 2" Pipe	
128377	RD-102-F-W	For 2" Pipe	
128407	RD-102-W	For 2" Pipe	
046142	RD-103	For 3" Pipe	
073219	RD-103-B-D	For 3" Pipe	
073224	RD-103-B-D-F-K -W	For 3" Pipe	
073220	RD-103-B-D-K	For 3" Pipe	
073221	RD-103-B-D-W	For 3" Pipe	
046793	RD-103-D	For 3" Pipe	
079955	RD-103-D-F	For 3" Pipe	
127561	RD-103-D-F-K-R	For 3" Pipe	
110615	RD-103-D-F-W- K80	For 3" Pipe	
128372	RD-103-F	For 3" Pipe	
100373	RD-103-F-D-K	For 3" Pipe	
109045	RD-103-F-D-K8 0	For 3" Pipe	
109046	RD-103-F-D-K8 0-R	For 3" Pipe	
128394	RD-103-F-K	For 3" Pipe	
128400	RD-103-F-K-W	For 3" Pipe	
128379	RD-103-F-W	For 3" Pipe	
079154	RD-103-W	For 3" Pipe	
046413	RD-104	For 4" Pipe	
046418	RD-104-B-D-F	For 4" Pipe	
050486	RD-104-B-D-F-K	For 4" Pipe	
070376	RD-104-B-D-F-K -W	For 4" Pipe	
073241	RD-104-B-D-F- W	For 4" Pipe	

Roof Drains (Continued)

RD-100 Series Large Area Roof Drain

Part #	Mfg #	Description	Price
073240	RD-104-B-D-W	For 4" Pipe	
046794	RD-104-D	For 4" Pipe	
100381	RD-104-D-F-K- W	For 4" Pipe	
110616	RD-104-D-F-W- K80	For 4" Pipe	
071018	RD-104-D-K	For 4" Pipe	
128373	RD-104-F	For 4" Pipe	
100375	RD-104-F-D-K	For 4" Pipe	
109044	RD-104-F-D-K8 0-R	For 4" Pipe	
106140	RD-104-F-K	For 4" Pipe	
106141	RD-104-F-K-R	For 4" Pipe	
128401	RD-104-F-K-W	For 4" Pipe	
128380	RD-104-F-W	For 4" Pipe	
067786	RD-104-K	For 4" Pipe	
067787	RD-104-R	For 4" Pipe	
079156	RD-104-W	For 4" Pipe	
128374	RD-105-F	For 5" Pipe	
128396	RD-105-F-K	For 5" Pipe	
128402	RD-105-F-K-W	For 5" Pipe	
128382	RD-105-F-W	For 5" Pipe	
128409	RD-105-W	For 5" Pipe	
046414	RD-106	For 6" Pipe	
128375	RD-106-F	For 6" Pipe	
109043	RD-106-F-D-K8 0-R	For 6" Pipe	
106142	Rd-106-F-K	For 6" Pipe	
106143	RD-106-F-K-R	For 6" Pipe	
128403	RD-106-F-K-W	For 6" Pipe	
128384	RD-106-F-W	For 6" Pipe	
072117	RD-106-K	For 6" Pipe	
079158	RD-106-W	For 6" Pipe	

Cast Iron Roof Drains

High Volume Roof Drain

- Epoxy-coated cast iron roof drain with flashing clamp and integral gravel stop
- Self-locking ductile iron dome
- No hub (standard) outlet
- Options:
 - Suffix D = Underdeck clamp
 - Suffix F = Adjustable extension flange
 - Suffix K = Ductile iron dome
 - Suffix K80 - Aluminum dome
 - Suffix W = Adjustable internal water dam



Part #	Mfg #	Description	Price
093419	RD-304-D	For 4" Pipe	
093421	RD-304-D-F	For 4" Pipe	
067167	RD-308-B-D-F-K	For 8" Pipe	
128413	RD-308-D	For 8" Pipe	
128460	RD-308-D-K	For 8" Pipe	
109040	RD-308-F-D-K80	For 8" Pipe	
128442	RD-308-D-W	For 8" Pipe	
128376	RD-308-F	For 8" Pipe	
106144	RD-308-F-K	For 8" Pipe	
128404	RD-308-F-K-W	For 8" Pipe	
128385	RD-308-F-W	For 8" Pipe	
128411	RD-308-W	For 8" Pipe	
100385	RD-308-W-F-D-K	For 8" Pipe	
100379	RD-310-F-D-K	For 10" Pipe	
100386	RD-310-W-F-D-K	For 10" Pipe	

Downspout Nozzle

- Cast nickel bronze
- Anchor flange
- Countersunk mounting holes



Part #	Mfg #	Description	Price
081019	RD-943-NH	For 3" Pipe, No-Hub Connection	
079163	RD-944-NH	For 4" Pipe, No-Hub Connection	
076950	RD-946-NH	For 6" Pipe, No-Hub Connection	
077687	RD-948-NH	For 8" Pipe, No-Hub Connection	

Components for Roof Drains

B2 Cast Iron Body

- For FD-340, FD-360, FD-450, FD-460, RD-100
- Options:
 - Suffix P = Push-on outlet



Part #	Mfg #	Connection	Price
046109	B2-2	2" No-Hub	
046124	B2-3	3" No-Hub	
046143	B2-3P	3" Push-On	
046131	B2-4	4" No-Hub	
046144	B2-4P	4" Push-On	
046138	B2-5	5" No-Hub	
046139	B2-6	6" No-Hub	

B15 Cast Iron Body

- Fits RD-300

Part #	Mfg #	Description	Price
066713	B15-4	4" No-Hub	
066715	B15-6	6" No-Hub	
066717	B15-8	8" No-Hub	
066718	B15-10	10" No-Hub	

Body Collar & Clamp for Floor Drains

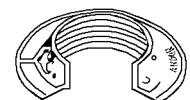

Part #	Mfg #	Description	Price
046170	B3-XYC	Reversible Clamp Collar for FD-100, FD-300; FC-1 Hardware Included	

Sediment Bucket for Floor Drain

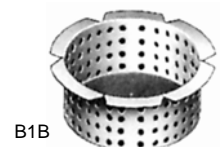

Part #	Mfg #	Description	Price
046312	B1B	For FD-100, FD-160, FD-200, FD-390-E	
046313	B2B	For FD-340, FD-450, FD-460	
046314	B3B	For FD-300, FD-320, FD-330, FD-390	
076469	SB-11	Bucket for 8" x 8" Floor Sink	

Drains, Carriers, & Sumps

Cast Iron Roof Drains

Roof Drain Component

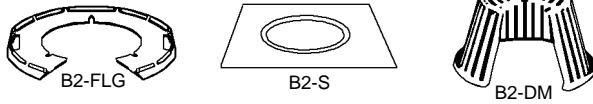

Part #	Mfg #	Description	Price
066719	B15-DC	Deck Clamp	
066720	B15-FLG	Flashing Clamp	
073377	B2-DC	Deck Clamp for RD-100 Roof Drain	
046270	B2-DM	Poly Dome for B2 Body	
046272	B2-KDM-80	Aluminum Dome, for RD100/RD300	
100020	B3-KDM	RD-200 Ductile Iron Dome	
047214	B2-W	Water Level Regulator Flange w/Nipple	
073379	B15-F	Adjustable Extension Flange	
066725	B15-W	Water Level Regulator Flange w/Nipple	
046347	34B	Gasketed Brass CO Plug	
073378	B2-F	Adjustable Extension Flange	
046310	B2-S	24" x 24" Sump Receiver for RD-100	
066724	B15-S	Sump Receiver	
085643	WD-GASKET	25' Roll Gasket	
046269	B2-FLG	Flashing Ring & Gravel Stop for RD-100, RD-150 Series	
047228	B2-R	External Water Dam	

Hardware Pack

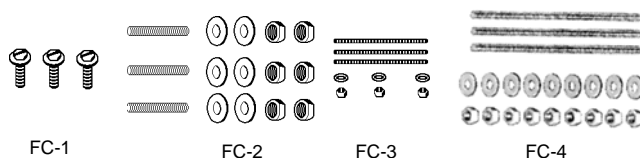

Part #	Mfg #	Description	Price
046190	FC-1	Cap Screw w/Integral Washer	
046191	FC-2	Bolts, Washers & Nuts for Roof Drain	
046192	FC-3	Bolts, Washers & Nuts for Deck Clamps	
046193	FC-4	Bolts, Washers & Nuts for Extensions	
066726	FC-6	Hardware Pack for RD-300 Flashing Clamp	
066727	FC-7	Hardware Pack for RD-300 Deck Clamp	
066728	FC-8	Hardware Pack for RD-300 Extension	

Closet Carriers

Industry Standard Closet Carriers

Industry Standard Single Horizontal Adjustable Closet Carrier

- 4" No-hub waste and 2" no-hub vent connections
- Epoxy-coated cast iron compression seal faceplate assembly
- Adjustable epoxy-coated cast iron foot supports
- Adjustable for standard and wheelchair height
- Adjustable ABS nipple with integral test cap and neoprene bowl gasket, plated hardware and chrome cap nuts
- Suffix XH = Extra-heavy 500 lbs carrier (ASME A112.6.1M) with 3/4" - 10" stainless steel studs



Part #	Mfg #	Description	Price
046399	ISCA-101-L	LH Carrier	
046398	ISCA-101-R	RH Carrier	

Industry Standard Back-to-Back Horizontal Adjustable Closet Carrier

- 4" No-hub waste and 2" no-hub vent connections
- Epoxy-coated cast iron compression seal faceplate assembly
- Adjustable epoxy-coated cast iron foot supports
- Adjustable for standard and wheelchair height
- Adjustable ABS nipple with integral test cap and neoprene bowl gasket, plated hardware and chrome cap nuts
- Suffix XH = Extra-heavy 500 lbs carrier (ASME A112.6.1M) with 3/4" - 10" stainless steel studs



Part #	Mfg #	Description	Price
046400	CA-101-D	Back-to-Back	
046397	CA-100-DPF	Back-to-Back Horiz Fitting	
080991	ISCA-101-D-XH	X-Heavy Carrier	

Industry Standard Single Vertical Adjustable Closet Carrier

- 4" No-hub waste and 2" no-hub vent connections
- Epoxy-coated cast iron fitting
- Adjustable epoxy-coated cast iron foot supports
- Adjustable ABS nipple with integral test cap and neoprene bowl gasket, plated hardware and chrome cap nuts
- Suffix XH = Extra-heavy 500 lbs carrier (ASME A112.6.1M) with 3/4" - 10" stainless steel studs



Part #	Mfg #	Description	Price
047573	CA-121	Single Carrier	

Industry Standard Back-to-Back Vertical Adjustable Closet Carrier

- 4" No-hub waste and 2" no-hub vent connections
- Epoxy-coated cast iron fitting
- 4" No-hub side inlet(s)
- Adjustable epoxy-coated cast iron foot supports
- Adjustable ABS nipple with integral test cap and neoprene bowl gasket, plated hardware and chrome cap nuts
- Suffix XH = Extra-heavy 500 lb carrier (ASWE A112.6.1M) with 3/4" - 10" stainless steel studs



Part #	Mfg #	Description	Price
058952	ISCA-121-D	Back-to-Back Carrier	
080995	CA-121-D-XH	Back-to-Back X-Heavy Carrier	

Industry Standard Back-to-Back Vertical Adjustable Closet Carrier with Side Inlet

- 4" No-hub waste and 2" no-hub vent connections
- Epoxy-coated cast iron fitting
- 4" No-hub side inlet(s)
- Adjustable epoxy-coated cast iron foot supports
- Adjustable ABS nipple with integral test cap and neoprene bowl gasket, plated hardware and chrome cap nuts
- Suffix XH = Extra-heavy 500 lbs carrier (ASWE A112.6.1M) with 3/4" - 10" stainless steel studs



Part #	Mfg #	Description	Price
056404	ISCA-131-D	Back-to-Back Carrier, Side Inlet	

Drains, Carriers, & Sumps

Closet Carriers

Industry Standard Closet Carriers (Continued)

Industry Standard Back-to-Back Vertical Adjustable Closet Carrier with Side Inlet

Part #	Mfg #	Description	Price
080996	CA-131-D-XH	Back-to-Back X-Heavy Carrier, Side Inlet	

Industry Standard Single Vertical Adjustable Closet Carrier with Side Inlet

- 4" No-hub waste and 2" no-hub vent connections
- 4" No-hub side inlet(s)
- Adjustable epoxy-coated cast iron foot supports
- Adjustable for standard and wheelchair height
- Adjustable ABS nipple with integral test cap and neoprene bowl gasket, plated hardware and chrome cap nuts
- Suffix XH = Extra-heavy 500 lbs carrier (ASWE A112.6.1M) with 3/4" - 10" stainless steel studs



Part #	Mfg #	Description	Price
056399	CA-131-L	Single LH Side Inlet	
080998	CA-131-L-XH	X-Heavy Single RH Side Inlet	
055272	CA-131-R	Single RH Side Inlet	
080999	CA-131-R-XH	X-Heavy Single RH Side Inlet	
064722	ISCA-131-2	Back-to-Back Carrier	
081000	CA-131-2-XH	Back-to-Back Carrier, (2) Side Inlets	
086306	ISCA-131-L/R/2	Carrier Fitting Only, less Faceplate	

Carrier Parts

Part #	Mfg #	Description	Price
078051	IS-FP-1	Industry Standard Faceplate Assembly	
079633	IS-FP-1-XH	Industry Standard XH Faceplate Assembly	
105974	RPC-1	SS Carpet Marker	
061546	CA-1	Neoprene Wall Hung Closet Gasket	
069554	CA-100-PFH	(4) Chrome-Plated Cap Nuts	
046395	CA-100-LPF	Left-Hand Horizontal Fitting	
080211	CA-100-LPF-A	Left-Hand Horizontal Fitting w/Auxiliary Connection	
067334	CA-100-PN8-61	8" Threaded ABS Nipple	

Carrier Parts (Continued)

Part #	Mfg #	Description	Price
067306	CA-100-PN24-61	24" Threaded ABS Nipple	
046394	CA-100-RPF	Right-Hand Horizontal Fitting	
080212	CA-100-RPF-A	Right-Hand Horizontal Fitting w/Auxiliary Connection	
079631	CA-N8-61	8" Smooth Nipple for IS-FP-1	
079632	CA-N24-61	24" Smooth Nipple for IS-FP-1	
047572	CA-120-PF	Vertical Fitting for ISCA-121	

Lavatory Carriers

Lavatory & Sink Carriers

Floor Mounted Lavatory Carrier with Concealed Arms

- Heavy gauge steel uprights with integral welded feet
- Adjustable epoxy-coated cast iron arms with leveling screws and basin locking device, upper tie rod and plated hardware
- Suffix D = Back-to-back carrier



Part #	Mfg #	Description	Price
097611	WCA-411	Lavatory Carrier	
108987	WCA-411-WC	Lavatory Carrier	
129655	WCA-411-D	Lavatory Carrier	

Specify CA-411-WC for 27" x 20" lavatories

Wall-Mount Lavatory Carrier

- Concealed arm

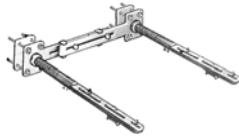

Part #	Mfg #	Description	Price
047571	CA-461	Concealed Arms w/Back Plate	

Floor-Mount Concealed Arm Track Lavatory Carrier

- Epoxy-coated heavy gauge steel offset uprights with welded feet
- Steel cross plate with integral mounting brackets
- Sliding adjustable arm brackets
- Adjustable cast iron concealed arms with mounting clips, leveling screws and basin locking device



Part #	Mfg #	Description	Price
046315	TCA-411	Single Floor-Mount Lavatory Carrier	

Urinal Carriers

Urinal Carriers

Floor-Mount Urinal Carrier



Part #	Mfg #	Description	Price
046318	CA-311	Single Plate	
046319	CA-321	With Bearing Plate	

Cast Iron Floor Drains

Floor Drains

Floor Drain with Round Strainer

- Epoxy-coated cast iron floor drain with anchor flange
- Reversible clamping collar with primary and secondary weepholes
- Adjustable round nickel bronze strainer
- No hub (standard) outlet
- Options:
 - Suffix A5 = 5" Diameter strainer
 - Suffix A6 = 6" Diameter strainer
 - Suffix A7 = 7" Diameter strainer
 - Suffix A8 = 8" Diameter strainer
 - Suffix P = Push-On Outlet



Part #	Mfg #	Description	Price
046362	FD-102-A5	For 2" Pipe	
046359	FD-102-P-A5	For 2" Pipe	
047700	FD-102-A6	For 2" Pipe	
072715	FD-102-P-A6	For 2" Pipe	
072718	FD-102-A7	For 2" Pipe	
072719	FD-102-P-A7	For 2" Pipe	
072722	FD-102-A8	For 2" Pipe	
072723	FD-102-P-A8	For 2" Pipe	
046363	FD-103-A5	For 3" Pipe	
072714	FD-103-P-A6	For 3" Pipe	
062369	FD-103-A7	For 3" Pipe	
048308	FD-103-P-A7	For 3" Pipe	
072724	FD-103-A8	For 3" Pipe	
072725	FD-103-P-A8	For 3" Pipe	
046365	FD-104-A5	For 4" Pipe	
072717	FD-104P-A6	For 4" Pipe	
072720	FD-104-A7	For 4" Pipe	
072721	FD-104-P-A7	For 4" Pipe	
072726	FD-104-A8	For 4" Pipe	
072728	FD-104-P-A8	For 4" Pipe	

Floor Drain with Extended Rim Strainer

- Epoxy-coated cast iron floor drain with anchor flange
- Reversible clamping collar with primary and secondary weepholes
- Adjustable round nickel bronze extended rim strainer
- No hub (standard) outlet
- Options:
 - Suffix P = Push-On outlet
 - Suffix ER7 = 7" Diameter strainer



Part #	Mfg #	Description	Price
072747	FD-102-ER7	For 2" Pipe	
072748	FD-102-P-ER7	For 2" Pipe	

Floor Drains (Continued)

Floor Drain with Extended Rim Strainer

Part #	Mfg #	Description	Price
072750	FD-104-ER7	For 4" Pipe	
072751	FD-104-P-ER7	For 4" Pipe	

Floor Drain with Square Strainer

- Epoxy-coated cast iron floor drain with anchor flange
- Reversible clamping collar with primary and secondary weepholes
- Adjustable square nickel bronze strainer
- No hub (standard) outlet
- Options:
 - Suffix M5 = 5" x 5" Strainer
 - Suffix M6 = 6" x 6" Strainer



Part #	Mfg #	Description	Price
072752	FD-102-M5	For 2" Pipe	
104073	FD-102-M8	For 2" Pipe	
072753	FD-103-M5	For 3" Pipe	
076863	FD-103-M6	For 3" Pipe	
072755	FD-104-M5	For 4" Pipe	

On-Grade Adjustable Floor Drain

- On-grade epoxy-coated cast iron floor drain with anchor flange and weepholes
- Adjustable round nickel bronze strainer
- No hub (standard) outlet
- Options:
 - Suffix A5 = 5" Diameter strainer
 - Suffix A6 = 6" Diameter strainer
 - Suffix P = Push-on outlet



Part #	Mfg #	Description	Price
048855	FD-202-A5	For 2" Pipe	
046367	FD-202-P-A5	For 2" Pipe	
048858	FD-202-A6	For 2" Pipe	
048856	FD-203-A5	For 3" Pipe	
046368	FD-203-P-A5	For 3" Pipe	
048859	FD-203-A6	For 3" Pipe	
048857	FD-204-A5	For 4" Pipe	
046369	FD-204-P-A5	For 4" Pipe	
048860	FD-204-A6	For 4" Pipe	

Drains, Carriers, & Sumps

Cast Iron Floor Drains

On-Grade Adjustable Floor Drain with Square Heavy-Duty Strainer

- On-grade epoxy-coated cast iron floor drain with anchor flange and weepholes
- Adjustable square nickel bronze strainer
- No hub (standard) outlet
- Options:
 - Suffix M5 = 5" Square strainer
 - Suffix P = Push-on outlet



Part #	Mfg #	Description	Price
046409	FD-202-P-M51	For 2" Pipe	
106626	FD-203-P-M51	For 3" Pipe	

Area Drains

Area Drain with 8" Fixed Top

- Epoxy-coated cast iron area drain with anchor flange, weepholes
- 8" Fixed top with ductile iron grate
- No hub (standard) outlet
- Options:
 - Suffix P = Push-on
 - Suffix 5 = Sediment bucket



Part #	Mfg #	Description	Price
070846	FD-322-P-Y	For 2" Pipe	
050036	FD-322-P-Y-5	For 2" Pipe	
070845	FD-323-P-Y	For 3" Pipe	
050037	FD-323-P-Y-5	For 3" Pipe	
050038	FD-324-P-Y-5	For 4" Pipe	

Area Drain with 12" Fixed Top

- Epoxy-coated cast iron area drain with anchor flange, weepholes
- 12" Fixed top with ductile iron grate
- No hub (standard) outlet
- Options:
 - Suffix P = Push-on outlet
 - Suffix 5 = Sediment bucket



Part #	Mfg #	Description	Price
070253	FD-343-P-Y-5	For 3" Pipe	
122645	FD-343-Y-5	For 3" Pipe	
075858	FD-344-P-Y-5	For 4" Pipe	
077739	FD-344-Y-5	For 4" Pipe	

Iowa Garage Drain

- Epoxy-coated cast iron garage drain with anchor flange
- 8" dia Fixed top with ductile iron grate
- Sediment bucket with weepholes
- No hub (standard) outlet
- Options:
 - Suffix P = Push-on outlet



Part #	Mfg #	Description	Price
107737	FD-813-P	For 3" Pipe	
102192	FD-814-P	For 4" Pipe	

Components for Floor Drains

Area Drain Top Assembly



Part #	Mfg #	Description	Price
049895	FD-320-Y-4	8" Dia Ductile Iron, Fixed	
046383	FD-340-4	12" Dia Ductile Iron, Adj	
070245	FD-340-Y-4	12" Dia Ductile Iron, Fixed	
076460	FD-360-4	15" Dia Ductile Iron, Adj	

Grate/Top Assembly

Part #	Mfg #	Description	Price
046202	G-1	4" x 9" Oval NB Funnel	

B3 Cast Iron Body

- For FD-100, FD-310, FD-320, FD-330, RD-200
- Options:
 - Suffix P = Push-on outlet



Part #	Mfg #	Connection	Price
046148	B3-2	2" No-Hub	
046152	B3-2P	2" Push-On	
046149	B3-3	3" No-Hub	
046153	B3-3P	3" Push-On	
046150	B3-4	4" No-Hub	
046154	B3-4P	4" Push-On	

Cast Iron Floor Drains

B4-34 Cast Iron Body

- Fits CO-200, CO-1200, FD-200, FD-300, FD-1200
- Options:
 - Suffix P = Push-on outlet



Part #	Mfg #	Connection	Price
046163	B4-34-2	2" No-Hub	
046166	B4-34-2P	2" Push-On	
046164	B4-34-3	3" No-Hub	
046167	B4-34-3P	3" Push-On	
046165	B4-34-4	4" No-Hub	
046169	B4-34-4P	4" Push-On	

Adjustable Strainer

Part #	Mfg #	Description	Price
046171	A5-1	5" Dia Strainer	
046173	A6-1	6" Dia Strainer	
046174	A7-1	7" Dia Strainer	
046175	A8-1	8" Dia Strainer	
049891	ER7-1	7" Dia Nickel Bronze Extended Rim	
046182	M5-1	5" Sq Strainer	
046184	M6-1	6" Sq Strainer	
046185	M8-1	8" Sq Strainer	
046188	L6-1	6" Sq HD Strainer	

Cast Iron Floor Drains

Specialty Cast Iron Drains

Specialty Cast Iron Bell Trap Cesspool with Hinged Strainer

- Complete inside caulk

Part #	Size	Price
015963	9" x 9" x 3"	

Specialty Cast Iron Deep Seal Floor Drain with Plug

Part #	Size	Price
014338	3"	

Cast Iron Floor Drains

Floor Drains

Des Moines Pattern Floor Drain

- Bolt down lid
- Integral trap



Part #	Mfg #	Description	Price
014337	D71-003	3" w/Trap	
015867	D71-004	Strainer	

Cast Iron Floor Drain with Trap

- Throat of drain is threaded for backwater device D70-050



Part #	Mfg #	Description	Price
013794	D70-001	2" Drain, Concealed Cleanout	

Cast Iron Area Drain



Part #	Mfg #	Description	Price
185361	D77-003	3", No Hub	

Floor Drain Accessories

Bell for Bell Trap

- Cast Iron



Part #	Mfg #	Description	Price
222931	D76252	12" x 12"	

6-3/4" Strainer, Less Hinge

- For 9" x 9" bell trap



Part #	Mfg #	Description	Price
189083	D76207L	6-3/4" for 9" x 9"	

Perforated Sewer Strainer w/ Legs

- For hub openings in clay sewer pipe



Part #	Mfg #	Description	Price
222194	D59130	12-1/4"	

Drain King

- Insert in drain line opening
- Turn water on
- Automatically seals drain and powerful water pulses loosen and clear drain



D18186



D18750

Part #	Mfg #	Size	Price
046572	D18-186	1-1/2" - 3"	
049516	D18-034	3" - 4"	
059988	D18-750	3" - 6"	



Cast Iron Floor Drains

Underground Floor Drains

Trap Guard® Floor Drain with Mechanical Hub Joint for Cast Iron

- 5" Nickel bronze round top

Part #	Mfg #	Size	Price
108676	T35630-F-CI	3" Adj	

Drains, Carriers, & Sumps

Cast Iron Floor Drains

Commercial Flashing Drains

Finish Line™ Round Adjustable Flashing Drain

- Cast iron no-hub connection
- ABS on cast- small head
- Adjustable AFTER the pour
- Adjustable height: round 1-1/4" or square 5/16"-1-1/4"
- Cast iron base adapter with ABS clamping collar, coring sleeve, head adapter and poly coring plug
- Nickel bronze or stainless steel strainers for use in pedestrian traffic areas

Part #	Mfg #	Conn.	Material	Dia.	Price
183896	833-225NR	2"	Nickel Bronze	5-1/2"	

Finish Line™ Square Adjustable Flashing Drain

- Cast iron no-hub connection
- ABS on cast- large head
- Adjustable AFTER the pour
- Adjustable height: round 1-1/4" or square 5/16"-1-1/4"
- Cast iron base adapter with ABS clamping collar, coring sleeve, head adapter and poly coring plug
- Nickel bronze or stainless steel strainers for use in pedestrian traffic areas

Part #	Mfg #	Conn.	Material	Dia.	Price
223875	833-23NQ	3"	Nickel Bronze	5-1/2"	

Finish Line™ Round Adjustable Flashing Drain

- Cast iron no-hub connection
- Ductile on cast- large head
- Adjustable AFTER the pour
- Adjustable height: round 1-1/4" or square 5/16"-1-1/4"
- Cast iron base adapter with ductile iron clamping collar, coring sleeve, head adapter and poly coring plug
- Nickel bronze or stainless steel strainers for use in pedestrian traffic areas
- Ductile iron strainers for heavy-duty applications

Part #	Mfg #	Conn.	Material	Dia.	Price
183897	833-22DNR	2"	Nickel Bronze	6-1/2"	
183899	833-23DNR	3"	Nickel Bronze	6-1/2"	
183900	833-24DNR	4"	Nickel Bronze	6-1/2"	

Finish Line™ Round Adjustable Flashing Drain

- Cast iron no-hub connection
- Ductile on cast- small head
- Adjustable AFTER the pour
- Adjustable height: round 1-1/4" or square 5/16"-1-1/4"
- Cast iron base adapter with ductile iron clamping collar, coring sleeve, head adapter and poly coring plug
- Nickel bronze or stainless steel strainers for use in pedestrian traffic areas

Part #	Mfg #	Conn.	Material	Dia.	Price
183898	833-235DNR	3"	Nickel Bronze	5-1/2"	

Finish Line™ Adjustable Flashing Drain (Nickel Bronze)

- Cast iron push-joint connection
- Ductile on cast - small head
- Adjustable AFTER the pour
- Adjustable height: round 1-1/4" or square 5/16"-1-1/4"
- Cast iron base adapter with ductile iron clamping collar, coring sleeve, head adapter, poly coring plug and neoprene push-joint gasket
- Nickel bronze or stainless steel strainers for use in pedestrian traffic areas



833-625DNQ

Part #	Mfg #	Connection	Type	Dia.	Price
183909	833-625DNQ	2"	Square	5-7/8"	
183910	833-625DNR	2"	Round	5-1/2"	
183912	833-635DNR	3"	Round	5-1/2"	

Finish Line™ Adjustable Flashing Drain (Nickel Bronze—Push-Joint Connection)

- Ductile on cast-large head
- Adjustable AFTER the pour
- Adjustable height: round 1-1/4" or square 5/16"-1-1/4"
- Cast iron base adapter with ductile iron clamping collar, coring sleeve, head adapter, poly coring plug and neoprene push-joint gasket
- Nickel bronze or stainless steel strainers for use in pedestrian traffic areas
- Ductile iron strainers for heavy-duty applications



833-63DNQ

Part #	Mfg #	Connection	Type	Dia.	Price
183911	833-62DNR	2"	Round	6-1/2"	
183914	833-63DNQ	3"	Square	7"	
183916	833-63DNR	3"	Round	6-1/2"	
183917	833-64DNR	4"	Round	6-1/2"	

Cast Iron Floor Drains

Rough-In Drain

Part #	Mfg #	Ring/Strainer	Connection	Price
183913	833-63DF	Coring Plug	2" Push-Joint	

Halo™ Ductile Iron Adjustable Flashing Floor Drain (Deck Flange-No-Hub Connection-Nickel Bronze)

- Head adjusts up to 3/4" above flush to accommodate most flooring types
- Finish Line™ models are adjustable AFTER the pour
- Installs easily in cored concrete floors or corrugated decks
- Great for loft remodels, second floor utility rooms/laundry rooms, etc.
- Adjustable height- **Square:** 1-5/16"-2" **Round:** 1"-2"



822-3DNR

Part #	Mfg #	Connection	Type	Dia.	Price
183874	822-F3DNQ	3"	Square	5-7/8"	
183875	822-F3DNR	3"	Round	5-1/2"	

Halo™ Drain

Part #	Mfg #	Connection	Type	Dia.	Price
187754	822-2DNR	2"	Round	5-1/2"	
183835	822-3DNR	3"	Round	5-1/2"	

Standard No-Hub Connection Flashing Drain

- Cast iron base adapter with ABS clamping collar and head adapter
- Acme threads are stronger than pipe threads and prevent cross-threading
- Ductile iron head/collar available
- Nickel bronze and stainless steel strainers for use in pedestrian traffic areas
- Cast iron strainers for use in heavy-duty applications
- Flange diameter: 8-1/2"



863-231

Round Nickel Bronze Ring & Strainer

Part #	Mfg #	Conn.	Adj. Height	Dia.	Price
184026	863-22NR	2"	4-3/4"-6-3/4"	6-1/2"	

Cast Iron Ring & Strainer

Part #	Mfg #	Conn.	Adj. Height	Dia.	Price
184028	863-231	3"	5-3/8"-7-3/8"	6-5/8"	
184029	863-241	4"	5-3/8"-7-3/8"	6-5/8"	

Commercial Floor Sinks

Cast Iron Square Floor Sink No-Hub Connection

- 8" Diameter, 6" sump height, 8-5/8" overall height
- Acid-resistant porcelain enamel coating (ARE)
- Perfect for high heat discharge applications
- Model **(861-284X12)** includes:
—Open-half ARE cast iron grate

Part #	Mfg #	Connection	Price
169123	861-282X	2" No-Hub	
153824	861-284X12	4" No-Hub	

Cast Iron Round Floor Sink No-Hub Connection

- 9" Diameter, 6" sump depth, 8-1/4" overall height
- Acid-resistant porcelain enamel coating (ARE)
- Perfect for high heat discharge applications
- Floor sink: porcelain-coated (ARE) cast iron
- Strainer: porcelain-coated (ARE) cast iron, nickel-bronze, or 301 stainless steel

Part #	Mfg #	Connection	Price
222418	860-292X	2" No-Hub	

Cast Iron Square Floor Sink No-Hub Connection

- 12" Diameter, 6" sump height, 9" overall height
- Acid-resistant porcelain enamel coating (ARE)
- Perfect for high heat discharge applications
- Available with flange and clamping collar for above-grade applications

Part #	Mfg #	Connection	Price
184011	861-23X	3" No-Hub	
184012	861-24X	4" No-Hub	

Commercial On-Grade Drains

Fat Max™ Large-Capacity On-Grade Floor Drain (Cast Iron Strainer/Body—No-Hub Connection)

- 13" Flange diameter
- Low profile design with anchor flange for a solid installation



860-231

Part #	Mfg #	Conn.	Dia.	Height	Price
175947	860-231	3" No-Hub	9"	6-3/4"	
222575	860-241	4" No-Hub	9"	6-3/4"	

Cast Iron Floor Drains

Finish Line™ Ductile Iron Adjustable Round Floor Drain with No-Hub Connection

- Adjustable *AFTER* the pour
- Ductile iron base adapter, coring sleeve, head adapter and poly coring plug
- Nickel bronze or stainless steel strainer for use in pedestrian traffic areas
- Adjustable height: 0-1" Round, square 5/16"-1"

Part #	Mfg #	Conn.	Dia.	Finish	Price
183881	832-25DNR	2"	5-1/2"	Nickel Bronze	

Finish Fixture

Part #	Mfg #	Conn.	Dia.	Finish	Price
167192	832-3DHR	—	5-1/2"	Nickel Bronze	

Finish Line™ Round On-Grade Floor Drain with No-Hub Connection

- Adjustable *AFTER* the pour
- Ductile iron base adapter, coring sleeve, head adapter and poly coring plug
- Nickel bronze or stainless steel strainers for use in pedestrian traffic areas
- Ductile iron strainers for use in heavy-duty applications
- Completed assembly heights:
—*Pre-pour*: 5-1/4"-6-1/2" *After-pour*: 1-1/4"

Part #	Mfg #	Conn.	Dia.	Finish	Price
183886	832-3DIR	3"	6-1/2"	Ductile Iron	
183887	832-3DNR	3"	6-1/2"	Nickel Bronze	
183890	832-4DIR	4"	6-1/2"	Ductile Iron	

On-Grade Round Adjustable Floor Drain MIP Thread (Nickel Bronze)

- MIP thread connection adapts to standard FIP adapters

Part #	Mfg #	Conn.	Dia.	Height	Price
046080	842-2ILNR	2" MIP	4-1/2"	2-3/8"	
183955	842-4ILNR	4" MIP	6-1/2"	2-3/8"	

Nickel Bronze Non-Adjustable Square Floor Drain (No-Hub Connection)

- Great for tile floors
- For use in pedestrian traffic areas



Part #	Mfg #	Conn.	Dia.	Height	Price
183983	844-23NQ	3" No-Hub	5-7/8"	2-3/8"	

Commercial Roof Drains

868 Series Light Commercial Cast Iron Roof Drain (No-Hub Connection)

- Dome strainer: polyethylene or epoxy-coated cast aluminum
- Gravel guard/flashing clamp: epoxy-coated cast aluminum
- Drain body: enamel-coated cast iron
- Polyethylene dome strainer is U.V. resistant



868-14M

Part #	Mfg #	Conn.	Strainer	Price
184052	868-14M	4" No-Hub	Cast Aluminum	

Cast Iron Roof Drain with No-Hub Connection

- Enamel-coated cast iron body, gravel guard and dome strainer
- 9-1/2" Overall height, 5" body height
- 15" Flange diameter, 13-5/8" gravel guard diameter
- Low-profile dome strainer twist-locks into gravel guard



868-1504

Part #	Mfg #	Connection	Price
184047	868-1503	3" No-Hub	
184048	868-1504	4" No-Hub	
184049	868-1506	6" No-Hub	
184050	868-1508	8" No-Hub	

Residential Floor Drains

St. Louis Style Floor Drain

- Cast iron inside-caulk connection
- Enamel-coated cast iron



844-02SL

Part #	Mfg #	Conn.	Dia	Height	Price
183982	844-0SL	3"	7"	3-1/2"	
183978	844-02SL	2"	4-7/8"	2-3/8"	
183979	844-04SL	4"	9-1/4"	4"	

Commercial Accessories

863 Series Condensate Funnel for Floor Drains

- Designed to receive drips, condensate lines or waste water from indirect waste lines
- Prevents splashing and direct waste into floor drain
- Two stainless steel, washer-head screws included

Part #	Mfg #	Finish	Size	Type	Price
184033	863-FN	Nickel Bronze	2" x 4"	Round	

Cast Iron Floor Drains

Dome Bottom Strainer

- For 12" x 12" cast iron floor sink



Part #	Mfg #	Material	Price
184025	861-AD	Aluminum	

Extension Nipple

- Fits under Halo™ head or Finish Line™ coring sleeve

Part #	Mfg #	Material	Price
157652	822-EX3	Ductile Iron	

FinishLine™ Ductile Iron Extension Nipple

Part #	Mfg #	Min	Max	Price
160328	832-EX4	2"	4"	

Round Ductile Iron Strainer with Screws

- Fits: 822 series, 832 series, 833 series, 842 series, 843 series, 844 series, & 863 series

Part #	Mfg #	Diameter	Screw Centers	Price
162698	842-SD4	6-1/8"	4-7/8"	

Aluminum External Water Dam



868-15WD

Part #	Mfg #	Height	Finish	Price
184051	868-15WD	2"	—	
177083	868-WD	2-3/16"	Epoxy-Coated	

Fat Max™ Strainer

Part #	Mfg #	Material	Price
161707	860-GI	Cast Iron	
226910	860-GN	Nickel Bronze	

Nickel Bronze Square Replacement Drain Strainer

- Fits: 822 series, 832 series, 833 series, 842 series, 843 series, 844 series, & 863 series
- Fat max strainers and accessories can be ordered separately
- Screws included

Part #	Mfg #	Diameter	Screw Centers	Price
183975	842-SNQ4	6-5/8"	4-7/8"	

Open-Half Grate for Cast Iron Floor Sinks

- Acid-resistant porcelain enamel coating (ARE)



860-RGN2

Part #	Mfg #	Material	Sink Size	Price
222419	860-592I	ARE Cast Iron	9" Dia.	
180121	860-RGN2	Nickel Bronze	9" Dia.	
184016	861-52I	ARE Cast Iron	12" x 12"	
170816	861-582I	ARE Cast Iron	8" x 8"	

Open-Quarter Grate for Cast Iron Floor Sinks

Part #	Mfg #	Material	Sink Size	Price
184019	861-53IN	Nickel Bronze	12" x 12"	

Round Replacement Drain Strainer with Screws (Cast 304 Stainless Steel)

- Fits: 822 series, 832 series, 833 series, 842 series, 843 series, 844 series, & 863 series
- Fat max strainers and accessories can be ordered separately

Part #	Mfg #	Diameter	Screw Centers	Price
183972	842-SCS4	6-1/8"	4-7/8"	

Round Replacement Drain Strainer with Screws (Stamped 430 Stainless Steel)

- 18 Gauge thickness (16 gauge for model 842-SS4)
- Fits: 822 series, 832 series, 833 series, 842 series, 843 series, 844 series, & 863 series
- Fat max strainers and accessories can be ordered separately

Part #	Mfg #	Diameter	Screw Centers	Price
183976	842-SS4	6-1/16"	4-7/8"	

Sump Reciever

- Epoxy-coated sump reciever plate



Part #	Mfg #	Plate size	For:	Price
187169	868-S	11-1/2"	3"-6" Roof Drains	

4-Piece 868 Series Underdeck Clamp Kit

Part #	Mfg #	Kit Includes:	Price
176373	868-15U	2 Clamping Bars, Thread Rod, Nuts & Washers	

Cast Iron Floor Drains

Underdeck Clamp Kit for 3"-6" Roof Drains

- Clamping plate, thread rod, nuts & washers

Part #	Mfg #	Size	Material	Price
182805	868-C	11"	Epoxy Coated	

Residential Accessories

Replacement Strainers for Floor Drains

- Fits: Pittsburgh style drain, St. Louis style drain, and Philadelphia style vent cap
- Epoxy-coated cast iron
- 3/8" Thickness



844-02G

Part #	Mfg #	Style	Diameter	Price
183980	844-0G	St. Louis	6-3/8"	
183977	844-02G	St. Louis	4-7/16"	
183985	844-S4	Pittsburgh	6-3/4"	

Floor Drain Strainers for General Purpose

- Cast iron strainers are 1/4" thick and epoxy-coated for corrosion-resistance



846-S5PK

Part #	Mfg #	Size	Price
183990	846-S7PK	6-1/4"	
183986	846-S11PK	6-5/8"	
183987	846-S15PK	7"	
183988	846-S17PK	8"	
183989	846-S19PK	9"	

Gripper™ Stainless Steel Pipe Strainer

- Gripping fingers fit snugly inside pipe keeping strainer securely in place
- Heavy gauge stainless steel is 100% corrosion proof



847-2

Part #	Mfg #	Pipe Size	Price
056942	847-2	2"	
154067	847-3	3"	



Cast Iron Floor Drains

Floor Drains

P-325 Replacement Floor Drain Cover

- Heavy pattern cast iron
- Green enamel painted
- Screwholes available upon request



Part #	Mfg #	Size	Thickness	Weight	Price
072996	P-325-06	6"	1/4"	18 lbs	
023606	P-325-638	6-3/8"	1/4"		
015707	P-325-612	6-1/2"	1/4"	20 lbs	
015746	P-325-658	6-5/8"	1/4"	22 lbs	
015723	P-325-634	6-3/4"	1/4"	25 lbs	
015751	P-325-678	6-7/8"	1/4"		
015754	P-325-07	7"	1/4"	26 lbs	
015761	P-325-714	7-1/4"	1/4"	27 lbs	
029355	P-325-08	8"	1/4"	32 lbs	
033558	P-325-10	10"	5/16"	32 lbs	
012333	P-325-11	11"	5/16"		

Cleanouts

Round Commercial Covers

Finish Line™ Cleanout Cover for Adjustable Cleanout

- Includes head adapter, ring and cover
- Medium-duty nickel bronze & stainless steel
- Tenzalloy covers for pedestrian traffic areas



Part #	Mfg #	Finish	Size	Price
104805	834-4HNR	Nickel Bronze	6-1/2"	

Square Commercial Covers

Finish Line™ Cleanout Cover for Adjustable Cleanout

- Includes head adapter, ring and cover
- Medium-duty nickel bronze & stainless steel
- Tenzalloy covers for pedestrian traffic areas



Part #	Mfg #	Finish	Size	Price
183922	834-4HNQ	Nickel Bronze	6-5/8"	

Commercial Rough-In Cleanouts

Finish Line™ Rough-In Cleanout for Adjustable Cleanout

- ABS/PVC base adapter, ABS coring sleeve
- High-impact polymer coring plug (ring & cover)

Part #	Mfg #	Material	Sch. 40 Hub	Price
104802	834-3PF	PVC	3" x 4"	
104804	834-4PF	PVC	4"	

Round Commercial Cleanouts

Finish Line™ Cleanout Sch. 40 Hub Connection

- Adjustable after the pour
- ABS/PVC Base adapter with polypro cleanout plug, ABS coring sleeve and head adapter - poly coring plug
- For use in pedestrian traffic areas
- Pre-pour height: (3"x4") and (4")
- 5-1/4"-6-1/2" and 5-1/2"-6-3/4"
- After-pour height: 0-1-1/4" and 5/16"-1-1/4"



Part #	Mfg #	Finish	Conn.	Dia	Price
109644	834-3PNR	Nickel Bronze	3"x4"	6-1/2"	
134395	834-4PNR	Nickel Bronze	4"	6-1/2"	

Adjustable Cleanout with Solvent Weld Connection

- Nickel bronze, stainless steel or ductile iron ring and cover
- ABS or PVC base adapter (A) or (P)
- Includes 3-1/2" polypro plug situated in base adapter
- Brass female thread inserts accept cover screws
- 3-1/2" MIP thread top housing adapts to any FIP adapter
- Pre-pour adjustable height:
 - 3" Hub 5-1/8"-6-1/4" or 4" hub 5-3/8"-6-1/2"
- Adapter height: 3" hub 4-3/8" or 4" hub 4-5/8"
- Ring and cover also available in cast brass
- Nickel bronze, stainless steel, and tenzalloy for use in pedestrian traffic areas
- Ductile iron covers for use in heavy-duty applications



Part #	Mfg #	Finish	Conn.	Dia	Price
176359	852-4PI	Ductile Iron	4"	6-1/2"	
066994	852-3PNR	Nickel Bronze	3"	6-1/2"	
066993	852-4PNR	Nickel Bronze	4"	6-1/2"	
159919	852-4PSR	304 Stainless	4"	6-1/2"	
048555	852-4PTR	Tenzalloy	4"	6-1/2"	

Adjustable On-Grade Cleanout (Cast Metal Ring and Cover)

- Brass female thread inserts for cover screws
- Highly polished cast metal
- Pre-doped polypro plug included



Cast Nickel Ring and Cover with PVC Adapter

Part #	Mfg #	Size	Price
082635	852-2PNR	2"	

Standard Adjustable Cleanout ABS/MIP Thread

- Slotted polypropylene cleanout plug included
- Nickel bronze, stainless steel, tenzalloy, and ABS covers for use in pedestrian traffic areas
- Cast iron covers for use in heavy-duty applications

Ring/Cover Dia.	Round	Square	Cast Iron
2" Cleanout	4-1/2"	—	—
3" Cleanout	5-1/2"	5-5/8"	6-1/8"
4" Cleanout	6-1/2"	7"	6-5/8"

Part #	Mfg #	Finish	Conn.	Plug	Price
183996	852-4LNR	Nickel Bronze	4" MIP	3-1/2"	

Cleanouts

On-Grade Solvent Weld Connection Cleanout

- Adapter body: ABS or PVC
- Over 1-1/2" vertical adjustment available
- Polypro plug with threaded brass insert for cover screw included
- Plug size is identical to connection size
- Cover screw: stainless, phillips head, 1/4"-20
- Set screws: square head, 1/4"-20
- Nickel bronze and tenzallo covers for use in pedestrian traffic areas
- Cast iron covers for use in heavy duty applications also available with nickel bronze veneer



851-441

Cast Iron Cover

Part #	Mfg #	Adj. Height	Conn.	Dia	Price
170393	851-441	4-1/2"-6-1/4"	4" PVC	6"	

Nickel Bronze Cover

Part #	Mfg #	Adj. Height	Conn.	Dia	Price
146437	851-461	6"-7-3/4"	6" PVC	8-1/2"	
159090	851-44N	3-3/4"-4-3/4"	4" PVC	6"	

Square Commercial Cleanouts

Finish Line™ Cleanout Sch. 40 Hub Connection

- Adjustable after the pour
- ABS/PVC Base adapter with polypro cleanout plug, ABS coring sleeve and head adapter - poly coring plug
- For use in pedestrian traffic areas
- Pre-pour height: (3"x4") and (4")
- 5-1/4"-6-1/2" and 5-1/2"-6-3/4"
- After-pour height: 0-1-1/4" and 5/16"-1-1/4"



834-3PNQ

Part #	Mfg #	Finish	Conn.	Dia	Price
183918	834-3PNQ	Nickel Bronze	3"x4"	6-5/8"	
222106	834-3PSQ	Stainless	3"x4"	6-5/8"	
222105	834-4PSQ	Stainless	4"	6-5/8"	

Adjustable Cleanout with Solvent Weld Connection

- Nickel bronze, stainless steel or ductile iron ring and cover
- ABS or PVC base adapter
- Includes 3-1/2" polypro plug situated in base adapter
- Brass female thread inserts accept cover screws
- 3-1/2" MIP thread top housing adapts to any FIP adapter
- Pre-pour adjustable height:
—3" Hub 5-1/8"-6-1/4" or 4" hub 5-3/8"-6-1/2"
- Adapter height: 3" hub 4-3/8" or 4" hub 4-5/8"
- Ring and cover also available in cast brass
- Nickel bronze, stainless steel, and tenzallo for use in pedestrian traffic areas
- Ductile iron covers for use in heavy-duty applications



852-4PNQ

Part #	Mfg #	Finish	Conn.	Dia	Price
165265	852-3PNQ	Nickel Bronze	3"	6-5/8"	
105295	852-4PNQ	Nickel Bronze	4"	6-5/8"	

Standard Adjustable Cleanout ABS/MIP Thread

- Slotted polypropylene cleanout plug included
- For use in pedestrian traffic areas
- Cast iron covers for use in heavy-duty applications

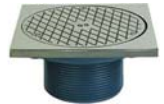

852-3LNQ

Ring/Cover Dia.	Round	Square	Cast Iron
2" Cleanout	4-1/2"	—	—
3" Cleanout	5-1/2"	5-5/8"	6-1/8"
4" Cleanout	6-1/2"	7"	6-5/8"

Part #	Mfg #	Finish	Conn.	Plug	Price
183995	852-3LNQ	Nickel Bronze	3" MIP	2-1/2"	
150591	852-4LNQ	Nickel Bronze	4" MIP	3-1/2"	

Cleanout Plugs

Cleanout Bushing/Kit

- Bushing body: white or black ABS
- Bushing fits inside Sch. 40 pipe
- Cleanout plug:
—White or black polypropylene
- Plugs have threaded brass inserts
- Cleanout bushing kits includes (875-8450P):
—16 Gauge stainless steel cleanout cover
—3/4" Stainless steel screw
—Diameter measurements match connection



875-4P



875-8230P
Bushing Kit

Part #	Mfg #	Conn.	Color	Plug Size	Price
184060	875-8450P	4" Hub	White	3-1/2"	

Cleanouts

Universal Plastic Drain Bases

3" x 4" Pipe Fit Base for 3-1/2" Spud

- Fits over 3" or inside 4" Sch 40 DWV pipe

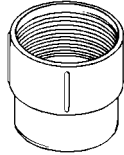

Part #	Mfg #	Description	Price
042061	D52-400	3" x 4" Combo PVC	

Bolts for Extension/Cleanout Covers

- Flat slotted head plated machine screw



Part #	Mfg #	Size	Price
005896	C90-006	1/4" - 20 x 6"	

Cleanouts

Floor Cleanouts

Floor Cleanout with Adjustable Round Top

- Epoxy-coated cast iron floor cleanout
- 5" Round adjustable gasketed nickel bronze top
- Removable gas-tight gasketed brass cleanout plug
- No hub (standard) outlet
- Options:
 - Suffix P = Push-on outlet
 - Suffix 34B = Gasketed bronze plug



Part #	Mfg #	Description	Price
071032	CO-202-P-R34B	For 2" Pipe	
046422	CO-202-P-R	For 2" Pipe	
046423	CO-203-P-R	For 3" Pipe	
050403	CO-203-R	For 3" Pipe	
072135	CO-203-P-R-34 B	For 3" Pipe	
046088	CO-204-R	For 4" Pipe	
071027	CO-204-P-R34B	For 4" Pipe	
046424	CO-204-P-R	For 4" Pipe	

Floor Cleanout with Heavy-Duty Top

- Epoxy-coated cast iron floor cleanout
- 5" Round adjustable gasketed heavy-duty nickel bronze top
- Removable gas-tight, gasketed, brass cleanout plug
- No hub (standard) outlet
- Options:
 - Suffix C = Membrane clamp
 - Suffix P = Push-on outlet
 - Suffix 34B = Gasketed bronze plug



Part #	Mfg #	Description	Price
053407	CO-202-P-RX-3 4B	For 2" Pipe	
095785	CO-203-RX	For 3" Pipe	
073385	CO-203-P-RX	For 3" Pipe	
053410	CO-203-P-RX-3 4B	For 3" Pipe	
148705	CO-204-RX	For 4" Pipe	
053411	CO-204-P-RX-3 4B	For 4" Pipe	
070371	CO-204-P-RX-C -34B	For 4" Pipe	

Floor Cleanout with Heavy-Duty Iron Top

- Epoxy-coated cast iron floor cleanout
- 5" Round adjustable gasketed heavy-duty ductile iron top
- Removable gas-tight, gasketed, brass cleanout plug
- No hub (standard) outlet
- Options:
 - Suffix P = Push-on outlet



Part #	Mfg #	Description	Price
074657	CO-204-P-RX4	For 4" Pipe	
105615	CO-204-RX-4	For 4" Pipe	

Floor Cleanout with Large Heavy-Duty Adjustable Round Top

- Epoxy-coated cast iron floor cleanout
- 8" Round adjustable gasketed heavy-duty ductile iron top
- Removable gas-tight gasketed brass cleanout plug
- No hub (standard) outlet
- Options:
 - Suffix P = Push-on outlet



Part #	Mfg #	Description	Price
069806	CO-266-P	For 6" Pipe	

Components for Cleanouts

Adjustable Cleanout Top



Part #	Mfg #	Description	Price
046354	R-1	5" Dia Nickel Bronze	
046356	RX-1	5" Dia HD Nickel Bronze	
046352	RX-4	5" Dia Ductile Iron	
046357	S-1	5" Sq Nickel Bronze	

Cleanouts

Extra Heavy-Duty Access Housing

- Epoxy-coated cast iron housing
- Anchor flanges
- Heavy-duty ductile iron cover



Part #	Mfg #	Description	Price
055469	CO-300-MF	Extra Heavy-Duty Access Housing	

Equalizer Chambers & End Caps

Infiltrator® Chamber System for Septic Leachfields

- Direct replacement for stone and pipe leachfields
- Patented microleaching™ sidewall
- Open chamber bottom
- Polyolefin construction
- Meets AASHTO load ratings of H-10

THERE IS A BETTER WAY ... THE INFILTRATOR® DESIGNED TO SOLVE PROBLEMS

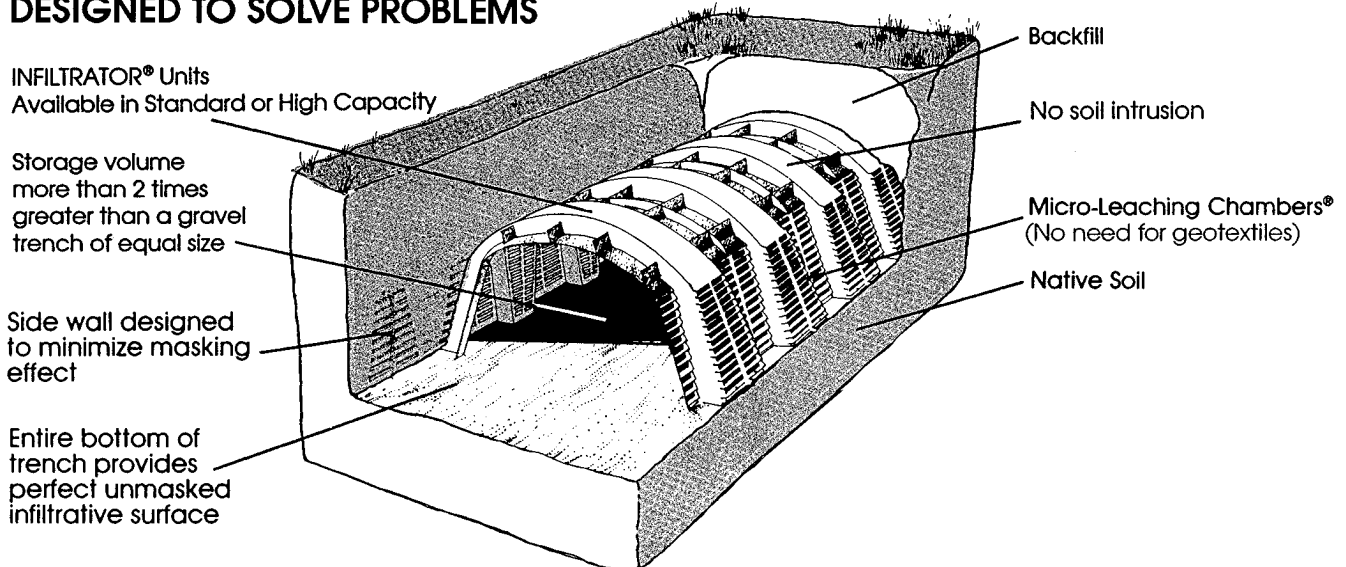

Quick4® Standard Chamber

- Ideal for curved and straight systems
- Contour Swivel Connection™ permits 10° turns right or left
- MultiPort™ end cap allows multiple piping options
- Effective length: 48"



Part #	Mfg #	Description	Size	Trench Width	Storage Volume	Price
091914	Q4STD	Standard Septic Chamber	34" x 53" x 12"	36"	43.5 gal	
087691	Q4STDE	Standard MultiPort™ End Cap				

Quick4® Equalizer® 24 Low Profile Chamber

- 8" Chamber height allows shallow installations with 4" of cover
- Contour Swivel Connection™ permits 15° turns right or left
- Flat end cap construction offers stability
- Simple overlap design for easy installation
- Universal end cap design fits on either end of trench
- Effective length: 48"



Part #	Mfg #	Description	Size	Storage Volume	Price
133198	Q4STDLP	Low Profile Chamber	16" x 53" x 8"	17 gal	
117082	Q4EQ24LP	Equalizer® 24 Low Profile Chamber	16"W x 53"L x 8"H	17 gal	
117083	Q4EQ24LPEN	Equalizer® 24 Low Profile End Cap			

Equalizer Chambers & End Caps

Quick4 Equalizer® Chamber

- Ideal for curved and straight systems
- Contour Swivel Connection™ permits 15° turns right or left
- MultiPort™ end cap allows multiple piping options
- Effective length: 48"



Part #	Mfg #	Description	Size	Trench Width	Storage Volume	Price
091913	Q4EQ24	Equalizer® 24 Septic Chamber	16" x 53" x 11"	18"	21 gal	
091915	Q4EQ24E	Equalizer® 24 MultiPort™ End Cap				

Quick4® Plus Standard Low Profile Chamber

- Maximum strength through center structural columns
- 8" Chamber height allows shallow installations with 6" of soil
- Contour Swivel Connection™ permits 10° turns right or left
- Flat end cap construction offers stability
- Simple overlap design for easy installation
- Universal end cap design fits on either end of trench
- Effective length: 48"



Part #	Mfg #	Description	Price
133200	Q4+E	Quick4 Plus Flat End Cap	

Grease Traps

Grease Interceptors

Endura® Grease Interceptor

- Injection molded thermoplastic
- Includes flow control fitting



Part #	Mfg #	Flow Rate	Grease Capacity	Conn Size	Price
102872	3920A02	20 gpm	46 lbs	2"	

Drains, Carriers, & Sumps

Grease Traps

Grease Interceptors

PDI Certified Grease Interceptor

- Recessed or floor mounted epoxy-coated steel
- Gasketed epoxy-coated steel skid-proof cover
- External cast iron flow control fitting
- Removable baffle assembly
- Deep seal trap with cleanout
- No hub (standard) connections



Part #	Mfg #	Flow Rate	Grease Cap	Dimensions	Price
046328	WD-10	10 gpm	20 lbs	21-3/4"L x 14"W x 12"H	
046332	WD-15	15 gpm	30 lbs	22"L x 15"W x 14"H	
046333	WD-20	20 gpm	40 lbs	24"L x 15-3/4"W x 15"H	
046335	WD-25	25 gpm	50 lbs	26"L x 16-1/2"W x 16-1/2"H	
060996	WD-35	35 gpm	70 lbs	30"L x 18"W x 19"H	
060439	WD-50	50 gpm	100 lbs	32"L x 22"W x 21-1/2"H	

Interceptors

Interceptors

SI-742 Hair, Plaster & Sediment Interceptor

- *Epoxy-coated*
- *10" Clearance required above cover to remove sediment basket*
- *Includes:*
 - *Removable stainless steel sediment basket*
 - *Gasketed cover*
 - *2" IPS Threaded connections*



Part #	Mfg #	Description	Price
060240	SI-742	Cast Iron Interceptor	

Plastic Floor Drains

Floor Drain Cleanout Spuds

3-1/2" Plastic Spud with 6" Round Cover



Part #	Mfg #	Finish	Price
042067	D59-901	Pol Brass	

PVC Area Drain

- Fits over 3" or inside 4" Sch 40 DWV pipe
- 5" Strainer can be installed as snap-in or screwed in



Part #	Mfg #	Description	Price
188017	D40601	3" x 4" PVC	

Way Area Drain

- Less stop
- Fits over 2" or inside 3" Sch40 DWV pipe
- Use with or without a p-trap



Part #	Mfg #	Description	Price
226639	D50220	2" x 3" PVC	

PVC Shower/Floor Drain

- Brass tailpiece and 6" chrome plated round strainer
- Fits over 2" or inside 3" Sch40 DWV pipe
- Low profile for 1st and 2nd floor installations
- Beveled edge allows for recessed installation
- Reversible clamping ring for additional 1/2" height adjustment
- Dual weeps holes
- Recessed sump area for added drainage



Part #	Mfg #	Description	Price
226691	D50800	2" x 3" PVC	

Bell Trap Drains

Plastic Bell Trap Drain

- Molded bell in lid
- Snap-in lid
- Use 2" coupling to convert 6" x 6" x 1-1/2" to 2" outlet



Part #	Mfg #	Description	Outlet	Price
068946	D42-006	6" x 6" PVC	1-1/2" x 2"	
068947	D42-009	9" x 9" PVC	3" x 4"	

Bell Trap Lid

- For D42006



Part #	Mfg #	Description	Price
227110	D42-007	For D42-006	

Floor Sink Grates

Floor Sink Grate PVC

- Fits Coupling & Fitting Hub
- 3/4" Thick Top grate
- 12"x 12" Top Flange
- Rated to 180 Deg F



Part #	Mfg #	Description	Price
179613	S59-012	Half top grate for PVC	

Plastic Floor Drains

Commercial On-Grade Drains

Adjustable On-Grade Drain Sch. 40 Hub Connection

- Acme threads are stronger than pipe threads and prevent cross-threading
- Ductile iron head adapter available
- Square ring is great for floor tile
- For use in pedestrian traffic areas
- Pre-threaded trap primer port for knockout connection



842-3PNQ

Nickel Bronze

Part #	Mfg #	Conn.	Height	Shape	Dia.	Price
037144	842-2PNR	2"x3"	4-3/8"-5-1/8"	Rnd	5-1/2"	
037145	842-3PNR	3"x4"	4-3/8"-5-1/8"	Rnd	5-1/2"	
152046	842-2PNQ	2"x3"	4-3/8"-5-1/8"	Sqr	5-7/8"	
141597	842-3PNQ	3"x4"	4-3/8"-5-1/8"	Sqr	5-7/8"	
183949	842-36PNQ	3"x4"	5-1/8"-6-1/4"	Sqr	7"	
183958	842-4PNQ	4"	5-3/8"-6-1/2"	Sqr	7"	
037146	842-4PNR	4"	5-3/8"-6-1/2"	Rnd	6-1/2"	

Stainless Steel

Part #	Mfg #	Conn.	Height	Shape	Dia.	Price
167242	842-2PSQ	2"x3"	4-3/8"-5-1/8"	Sqr	5-7/8"	
156484	842-2PSR	2"x3"	4-3/8"-5-1/8"	Rnd	5-1/2"	
186755	842-3PSR	3"x4"	4-3/8"-5-1/8"	Rnd	5-1/2"	
160105	842-4PSR	4"	5-3/8"-6-1/2"	Rnd	6-1/2"	

Cast Iron

Part #	Mfg #	Conn.	Height	Shape	Dia.	Price
183957	842-4PI	4"	5-3/4"-6-7/8"	Rnd	6-5/8"	

Adjustable On-Grade Drain ABS MIP Thread

- MIP thread models adapt to any standard FIP adapter



842-3LP

Part #	Mfg #	Conn.	Material	Shape	Dia.	Price
183948	842-2LNQ	2"	Nkl Brz	Sqr	4-1/2"	
144663	842-2LNR	2"	Nkl Brz	Rnd	4-1/2"	
183950	842-3LNQ	2"	Nkl Brz	Sqr	5-7/8"	
183951	842-3LNR	3"	Nkl Brz	Rnd	5-1/2"	
183953	842-3LP	3"	Gray	Rnd	5-1/2"	
183956	842-4LP	4"	Gray	Rnd	6-1/2"	

Little Max™ Standard PVC On-Grade Drain (Sch. 40 Hub Solvent Weld Connection)

- Strainer ring can be used as a clamping collar for above-grade applications
- 8-1/2" Flange diameter



864-3P

Part #	Mfg #	Conn.	O.D.	Height	Price
055523	864-2P	2"	7-1/4"	4-1/4"	
042815	864-3P	3"	7-1/4"	4-3/8"	
064349	864-4P	4"	7-1/4"	5-1/8"	

On-Grade Floor Drain with Sch. 40 Hub Connection

- Use in pedestrian areas
- 3 brass thread inserts secure strainer screws



Part #	Mfg #	Conn.	Material	Shape	Dia.	Price
073790	843-2PNR	2" x 3"	Nkl Brz	Rnd	4-1/2"	

Finish Line™ Adjustable On-Grade Drain Sch. 40 Hub Connection

- Adjustable after the pour
- PVC base adapter, ABS coring sleeve and head adapter, poly coring plug
- For use in pedestrian traffic areas
- Pre-pour height: 5-1/2"-6-3/4"
—5-1/4"-6-1/2" (for models **832-36PNR & 832-36PSQ**)
- After pour height: **round:** 1-1/4", **square:** 5/16"-1-1/4"
- Model (**832-2PNR-V**) is vandal resistant



Complete Assembly with Round Nickel Top



Square Finish Fixture
832-4HNQ



Rough-In Drain

Part #	Mfg #	Conn.	Material	Shape	Dia.	Price
112776	832-2PNR	2"	Nkl Brz	Rnd	6-1/2"	
223442	832-2PNR-V	2"	Nkl Brz	Rnd	6-1/2"	
177005	832-2PNQ	2"	Nkl Brz	Sqr	7"	
102013	832-36PNR	3" x 4"	Nkl Brz	Rnd	6-1/2"	
222104	832-36PSQ	3" x 4"	304 SS	Rnd	7"	
173891	832-4PNQ	4"	Nkl Brz	Sqr	7"	

Rough-In Drain

Part #	Mfg #	Conn.	Rng/Strnr	Adj. Hgt	Price
141802	832-2PF	2"	Coring Plug	5-1/2x6-3/4"	
106619	832-36PF	3" x 4"	Coring Plug	5-1/4-6-1/2"	
106620	832-4PF	4"	Coring Plug	5-1/2x6-3/4"	

Plastic Floor Drains

Finish Fixture

Part #	Mfg #	Conn.	Material	Shape	Dia.	Price
125925	832-4HNQ	—	Nkl Brz	Round	7"	
104806	832-4HNR	—	Nkl Brz	Round	6-1/2"	
153804	832-4HSR	—	304 SS	Round	6-1/2"	

FinishLine™ Adjustable On-Grade Drain Sch. 40 Hub Connection—5-1/2" Top

- PVC sch. 40 connection
- Adjustable AFTER the pour
- ABS/PVC base adapter, ABS coring sleeve, head adapter and poly coring plug
- For use in pedestrian traffic areas
- After-pour height: round: 0"-1" square: 5/16"-1"



832-25PNR

Part #	Mfg #	Conn.	Material	Shape	Dia.	Price
183883	832-25PNQ	2"x3"	Nkl Brz	Sqr	5-7/8"	
159368	832-25PNR	2"x3"	Nkl Brz	Rnd	5-1/2"	
183885	832-35PSR	3"x4"	304 SS	Rnd	5-1/2"	

Rough-In Drain

Part #	Mfg #	Conn.	Ring/Strainer	Price
183882	832-25PF	2" x 3" Hub	Coring Plug	
183884	832-35PF	3" x 4" Hub	Coring Plug	

Finish Fixture

Part #	Mfg #	Conn.	Material	Shape	Dia.	Price
183888	832-3HNR	—	Nkl Brz	Round	5-1/2"	

Fat Max™ Large Capacity On-Grade PVC Floor Drain with Sch. 40 Hub Solvent Weld Connection

- 12" Flange diameter
- Low profile design with anchor flange for a solid installation



860-3PZ

With PVC Strainer

- 8-1/2" Top diameter
- ABS Sand bucket included with model (860-3PS) only

Part #	Mfg #	Conn.	O.D.	Height	Price
184001	860-2P	2"	9"	6-3/8"	
169589	860-3P	3"x4"	9"	6-3/8"	
133651	860-3PS	3"x4"	9"	6-3/8"	
177007	860-4P	4"	9"	6-3/8"	

With Nickel Bronze Ring & Strainer

- 9-3/8" Top diameter

Part #	Mfg #	Conn.	O.D.	Height	Price
158247	860-4PN	4"	9-3/4"	7-3/8"	

With Stainless Steel Ring & Strainer

- 9-3/8" Top diameter, includes mesh debris basket

Part #	Mfg #	Conn.	O.D.	Height	Price
184002	860-3PZW	3"x4"	9-3/4"	7-3/8"	

With Cast Iron Ring & Strainer

- 8-1/2" Top diameter
- ABS debris bucket included with model (860-4PIU) only

Part #	Mfg #	Conn.	O.D.	Height	Price
153505	860-2PI	2"	9-3/8"	6-3/8"	
104593	860-3PI	3" x 4"	9-3/8"	6-3/8"	
100410	860-4PI	4"	9-3/8"	6-3/8"	
153829	860-4PIU	4"	9-3/8"	6-3/8"	

Commercial Flashing Drains

Flashing Drain Sch. 40 Hub Connection

- ABS/PVC base adapter with ABS clamping collar and head adapter
- Acme threads are stronger than pipe threads and prevent cross-threading
- Ductile iron head/collar available
- Square strainer is perfect for floor tile
- For use in pedestrian traffic areas
- Adjustable height: 4-3/8"-6-3/8"



863-435SQ



863-43NR

Part #	Mfg #	Conn.	Material	Shape	Dia.	Price
177006	863-32NQ	2"	Nk Br ABS	Sqr	7"	
184030	863-42NR	2"	Nk Br/PVC	Sqr	6-1/2"	
099062	863-425NR	2"	Nk Br/PVC	Rnd	5-1/2"	
156427	863-425NQ	4"	Nk Br/PVC	Sqr	5-7/8"	
099063	863-435NR	3"	Nk Br/PVC	Rnd	5-1/2"	
137420	863-435SQ	3"	SS/PVC	Sqr	5-7/8"	
137418	863-435SR	3"	SS/PVC	Rnd	5-1/2"	
099064	863-445NR	4"	Nk Br/PVC	Rnd	5-1/2"	

Plastic Floor Drains

Finish Line™ Adjustable Flashing Drain-5-1/2" Tops

- Sch. 40 Hub connection-small head
- Adjustable AFTER the pour
- ABS/PVC base adapter with ABS clamping collar, coring sleeve, head adapter and poly coring plug
- Nickel bronze and stainless steel strainers for use in pedestrian traffic areas
- Adjustable height: round: 0-1", square: 5/16"-1"

Part #	Mfg #	Conn.	Material	Shape	Dia.	Price
182823	833-25PNR	2"	Nkl Brz	Rnd	5-1/2"	
226058	833-25PNQ	2"	Nkl Brz	Sqr	5-7/8"	

Finish Line™ Adjustable Flashing Drain-6-1/2" Tops

- Sch. 40 hub connection-large head
- Adjustable AFTER the pour
- PVC base adapter with ABS clamping collar, coring sleeve, head adapter and poly coring plug
- Nickel bronze and stainless steel strainers for use in pedestrian traffic areas
- Adjustable height: round: 0-1", square: 5/16"-1"

Part #	Mfg #	Conn.	Material	Shape	Dia.	Price
183902	833-2PNQ	2"	Nkl Brz	Sqr	7"	
183906	833-3PNQ	3"	Nkl Brz	Sqr	7"	
183907	833-3PNR	3"	Nkl Brz	Rnd	6-1/2"	
183908	833-4PNR	4"	Nkl Brz	Rnd	6-1/2"	

Rough-In Drain

Part #	Mfg #	Conn.	Ring/Strainer	Price
183905	833-3PF	3" Hub	Coring Plug	

Finish Line™ Halo Drain™ Adjustable Flashing Drain with Sch. 40 Hub Connection & Deck Flange

- Outlet welds over 2" and inside 3", or over 3" and inside 4"
- Head adjusts up to 3/4" above flush to accommodate most flooring types
- Adjustable AFTER the pour: 1"-2" adjustable height
- Installs easily in cored concrete floors or corrugated decks
- Great for loft remodels, second floor utility rooms/laundry rooms, etc



822-3PNR

Part #	Mfg #	Conn.	Material	Dia.	Price
183873	822-F2PNR	2"x3"	Nickel Bronze	5-1/2"	
183876	822-F3PNR	3"x4"	Nickel Bronze	5-1/2"	

Halo™ Drain

- Adjustable heights:
—3/4" Rnd NB — 1/2" Stainless— 5/16"-3/4" Sqr NB

Part #	Mfg #	Conn.	Material	Shape	Dia	Price
164747	822-2PNQ	2"x3"	Nkl Brz	Sqr	5-7/8"	
135477	822-2PNR	2"x3"	Nkl Brz	Rnd	5-1/2"	
130083	822-3PNR	3"x4"	Nkl Brz	Rnd	5-1/2"	
183833	822-2PS	2"x3"	18ga SS	Rnd	5-1/2"	
183837	822-3PS	3"x4"	18ga SS	Rnd	5-1/2"	

Commercial Floor Sinks

Fat Max™ PVC Floor Sink with PVC Strainer

- New white color provides a cleaner appearance in floor sink applications
- Low profile design with anchor flange for a solid installation
- Independent lab tests show no distortion from water temperatures up to 180°F
- Tough, impact resistant PVC construction
- Strainers for pedestrian traffic
- 12" Flange diameter with 8-1/2" top diameter



860-W3P

Part #	Mfg #	Conn.	O.D. Dia.	Height	Price
170284	860-W2P	2" Hub	9"	6-3/8"	
180120	860-W3P	3" x 4" Hub	9"	6-3/8"	

Little Max™ Compact PVC Floor Sink (Solvent Weld Connection)

- New white color provides a cleaner appearance in floor sink applications
- Strainer ring can be used as a clamping collar for above-grade applications
- Stainless steel lift handle for strainer
- Brass thread inserts with stnlss steel rim/collar screws
- 8-1/2" Flange diameter, 7-1/4" rim/collar screws
- (864-W3P2)— Open-half strainer installed



864-W2P

Part #	Mfg #	Connection	Height	Price
184034	864-W2P	2" Hub	4-1/4"	
184035	864-W3P	3" Hub	4-3/8"	
184036	864-W3P2	3" Hub	4-3/8"	

Plastic Floor Drains

Square Max™ PVC Square Floor Sink

- Sump area is 54% larger than most PVC square floor sinks
- Low profile design with anchor flange for a clean appearance and a solid installation. Clamping collar available
- All inner surfaces are pitched, no standing water in sump area
- Independent lab tests show no distortion from water temperatures up to 180°F
- Tough, impact resistant PVC construction
- PVC and nickel bronze strainers for pedestrian traffic.
- Ductile iron strainer for heavy-duty applications
- 14-1/8" Flange diameter
- 10-11/16" top diameter for PVC strainer & sink only



No Strainer—Sink Only

Part #	Mfg #	Conn.	O.D.	Height	Price
099069	861-2PX	2" Hub	11-3/16"	7-7/16"	
099070	861-3PX	3x4" Hub	11-3/16"	8-5/16"	
121524	861-4PX	4" Hub	11-3/16"	7-7/16"	

With PVC Strainer

Part #	Mfg #	Conn.	O.D.	Height	Price
117523	861-2P	2" Hub	11-3/16"	7-7/16"	
099046	861-3P	3x4" Hub	11-3/16"	8-5/16"	
153202	8614-P	4" Hub	11-3/16"	7-7/16"	

With Nickel Bronze Ring & Strainer

- 10-3/4" Top diameter

Part #	Mfg #	Conn.	O.D.	Height	Price
153822	861-3PN	3x4" Hub	11-3/4"	8-3/4"	
153823	861-4PN	4" Hub	11-3/4"	7-1/16"	

With Ductile Iron Ring & Strainer

- 10-5/8" Top diameter

Part #	Mfg #	Conn.	O.D.	Height	Price
184013	861-2PI	2" Hub	11-3/4"	8"	
170848	861-3PI	3x4" Hub	11-3/4"	8-3/8"	
184024	861-6PI	6" Hub	11-3/4"	10-1/16"	

Commercial Roof Drains

Planter Area Drain with PVC Solvent Weld Sch. 40 Hub Connection

- Perfect for indoor atriums, green roof installations, ground-level plant boxes, etc.
- All corrosion-resistant materials
- 10" flange diameter
- Clamping collar and gravel guard: ABS
- Debris cover: stainless steel mesh
- Dome strainer: U.V. resistant polypropylene
- Provides an economical, adjustable alternative to heavy cast iron models



Part #	Mfg #	Conn.	Lower Body Height	Price
168856	867-L4PP	4" Hub	4"	

Light Commercial 867 Series Solvent Weld Roof-Drain with Sch. 40 Hub Connection

- Uses "key and keyhole" alignment system on dome strainer and gravel guard
- 8" Clamping collar: ABS or enamel-coated cast iron
- Polypro strainer & PVC gravel guard are U.V. resistant
- 10" Flange, 8-1/8" overall height, 4" drain body height
- Brass thread inserts accept collar and clamp screws
- Options: **STP2**—2" overflow standpipe installed



Part #	Mfg #	Conn.	Strainer	Body	Price
184043	867-A4	4" Hub	Polyethylene	ABS	
141232	867-P2	2" Hub	Polyethylene	PVC	
140122	867-P3	3" Hub	Polyethylene	PVC	
141233	867-P4	4" Hub	Polyethylene	PVC	
184045	867-P4STP2	4" Hub	Polyethylene	PVC	

868Series Solvent Weld Connection Roof Drain

- Gravel guard/flashing clamp: aluminum
- Polyethylene dome strainer is U.V. resistant
- Aluminum dome strainer and gravel guard are epoxy-coated
- Brass thread inserts accept collar and clamp screws
- Options: **(W)**—2-3/16" external water dam



Part #	Mfg #	Conn.	Strainer	Body	Price
187166	868-P3M	3" Hub	Cast Aluminum	PVC	
187168	868-P3M-W	3" Hub	Cast Aluminum	PVC	
184053	868-P4	4" Hub	Polyethylene	PVC	
187163	868-P4M	4" Hub	Cast Aluminum	PVC	
187167	868-P4M-W	4" Hub	Cast Aluminum	PVC	
159987	868-P6	6" Hub	Polyethylene	PVC	
187928	868-P6M	6" Hub	Cast Aluminum	PVC	
187929	868-P6M-W	6" Hub	Cast Aluminum	PVC	

Plastic Floor Drains

Residential Floor Drains

PVC Bell Trap Drain

- Solvent weld connection
- Bell-type trap is designed into sump area



866-2P

Part #	Mfg #	Connection	Size	Price
157491	866-2P	1-1/2" Hub x 2" Spigot	6" x 2-3/16"	
184037	866-34P	Over 3" Inside 4" Hub	9" x 4-1/2"	

Inside Pipe Drain

- Solvent welds inside pipe, flush to floor
- Also great for direct vent furnaces, water heaters, and/or to cover any open ended pipe



845-3P

Part #	Mfg #	Sch. 40 Hub	Dia.	Height	Price
101141	845-3P	3"	3-1/2"	1-1/2"	
127396	845-4P	4"	4-1/2"	1-7/8"	

Weld One™ PVC Integral Trap Floor Drain

- Proven performance, improved design
- Drain body is sonic welded, **NOT GLUED**
- Deeper outlet reduces slab cracks
- Threaded, 1/2" FIP knockout trap primer port
- Outlet provides proper slope to connecting pipe
- Strainer options include round and square nickel bronze and stainless steel, or heavy-duty ductile iron



800-P

Polypro Strainer

- (-PBW) Includes backwater devise

Part #	Mfg #	Sch. 40 Hub	Drain Body	Price
010027	800-P	2"	Gray PVC	
010028	800-PBW	2"	Gray PVC	

Nickel Bronze Ring & Strainer

Part #	Mfg #	Sch. 40 Hub	Body	Shape	Price
171524	800-PNQ	2"	Gray PVC	Sqr	
166747	800-PNR	2"	Gray PVC	Rnd	

304 Stainless Steel Ring & Strainer

Part #	Mfg #	Sch. 40 Hub	Body	Shape	Price
159889	800-PSR	2"	Gray PVC	Rnd	

Quad Drain™ General Purpose Floor Drain

- PVC or ABS with low profile design
- Standard hub, or full-slip connections available to fit 2" and 3" Sch. 40 pipe
- Full-slip connections allow adjust-to-grade installations — Full-slip models are gray PVC without screws
- Nickel bronze and stainless steel strainers for use in pedestrian traffic areas
- Ductile iron strainers for heavy-duty applications
- **Options:** Add letter suffix — H-2" FIP threaded drain throat for stand pipe



841-2A

Polypro Strainer

Part #	Mfg #	Connection	Material	Price
183938	841-29PL	2" Full-Slip	PVC	
133238	841-2A	2" x 3" Hub	ABS	
024860	841-2P	2" x 3" Hub	PVC	
106746	841-2P-H	2" x 3" Hub	PVC	

Nickel Bronze Ring & Strainer

Part #	Mfg #	Description	Price
156003	841-2PNR	2" x 3" Hub PVC	
183941	841-39PNR	3" Full-Slip PVC	

PVC Solvent Weld Floor Drain with Snap-In Strainer

- 430 Stainless steel strainer
- Strainer finger grip slots in drain body to prevent slipping and turning



Part #	Mfg #	Hub x Inside Fit	Size	Price
144768	840-27P	2" x 3"	4-3/8" x 1-3/4"	

PVC General Purpose Solvent Weld Floor Drain (Nickel Bronze Ring & Strainer)

- Brass inserts in drain body make strainer replacement fast and easy



Part #	Mfg #	Hub x Inside Fit	Size	Price
183929	840-30PNR	3" x 4"	4-1/2" x 2-9/16"	

Plastic Floor Drains

Residential Shower Drains

PVC Shower Pan Drain with Cast Metal Ring and Strainer and 2" Sch. 40 Hub Connection

- Beveled drain body and mounting holes for easy subfloor installation
- Machine screws and threaded brass inserts in drain body and top housing
- 3-15/16"-5-15/16" Adjustable height



821-200PSR

Part #	Mfg #	Shape	Dia.	Material	Price
101693	821-200PNR	Rnd	4-1/2"	Cast Nickel Brz	
066082	821-200PNQ	Sqr	4-1/2"	Cast Nickel Brz	
137709	821-200PRBR	Rnd	4-1/2"	Oil-Rubbed Brz	
126392	821-200PRBQ	Sqr	4-1/2"	Oil-Rubbed Brz	
137422	821-200PSR	Rnd	4-1/2"	Matte 304 SS	
137423	821-200PSQ	Sqr	4-1/2"	Matte 304 SS	

PVC Shower Pan Drain with Screw-On Strainer

- 430 Stainless steel strainer
- Available with brass inserts in head adapter for machine screws or pilot holes for standard screws
- Models available with either (gray) plastic rim around strainer, or no strainer rim
- Beveled drain body and mounting holes for easy subfloor installation
- 3-5/8"-5-5/8" Adjustable height



821-200P

Part #	Mfg #	Conn.	Dia.	Strainer Rim	Price
223380	821-200P	2" Hub	4-3/8"	Plastic	
079009	821-2080P	2" Hub	4-1/4"	—	

PVC Shower Pan Drain with Adapter and Strainer (Sch. 40 Hub Connection)

- Head adapter available separately
- Beveled drain body and mounting holes for easy subfloor installation
- Square pattern is perfect for tile floors
- 4-3/8"-6-3/8" Adjustable height



821-2PQCP

Part #	Mfg #	Shape	Dia.	Material	Price
045481	821-2PCP	Rnd	4-1/8"	Chrome- Plated	
137292	821-2PQCP	Sqr	4-1/8"	Chrome- Plated	
137334	821-2PQRB	Sqr	4-1/8"	Oil-Rubbed Brz	

Large Capacity Shower Pan Drain with Cast Metal Ring and Strainer & 3" Sch. 40 Hub Connection

- For large tile floor showers and showers with multiple heads or body-spray options
- Larger head/strainer and 3" connection provides increased flow capacity
- 4-3/8"-6-3/8" Adjustable height
- Top housing & flashing collar-ABS, adapter body-PVC
- Options: (V) vandal-resistant strainer screws



863-435NQ

Part #	Mfg #	Shape	Dia.	Material	Price
184031	863-435CQ	Rnd	5-7/8"	Pol. 304 Stnlss	
223441	863-435-SQ-V	Sqr	5-7/8"	Cast 304 Stnlss	

Shower Pan Drain with Tile-In Head (2" Sch. 40 Hub Connection)

- Stainless Steel tile-in tray
- Works with any décor – no need to match the finish of fixture trim
- Contemporary design creates the look of a seamless tile floor. Water “disappears” into the drainage slot
- Removable hair strainer included with ABS models
- Installs easily – no special techniques or tools needed



821-2PTQ

Part #	Mfg #	Head Size	Material	Price
182020	821-2PTQ	5"	PVC/Stainless	
223911	821-T2PT4A	4"	ABS	
182808	821-T2PTQ	5"	PVC/Stainless	

825 Series Solvent Weld Shower Module Drain Snap-in Stainless Steel Strainer

- Strainer fingers grip slots in top to prevent slipping and turning
- 430 stainless steel strainer
- Male-thread top: PVC
- Washers: rubber, polyethylene
- Female-thread body: ABS or PVC
- 1-1/2" Hub connection is also 2" spigot
- Do not use putty with plastic shower drains



825-27P

Part #	Mfg #	Conn.	Size	Material	Price
152845	825-27A	2" Hub	4-1/4"x2-5/8"	ABS	
066772	825-27P	2" Hub	4-1/4"x2-5/8"	PVC	

Plastic Floor Drains

Commercial Accessories

Debris Baskets



860-UM

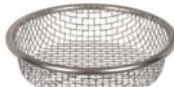

832-UM



864-UM

Part #	Mfg #	Size	Material	Price
142621	860-UM	4-1/4"	Stainless Steel	
167856	832-UM	4-1/4"	Stainless Steel	
171792	864-UM	Mesh Screen	Stainless Steel	

Fat Max™ PVC Buckets



860-U



860-S

Part #	Mfg #	Bucket	Material	For:	Price
095324	860-S	Sand	PVC	Sump Area	
171527	860-U	Debris	PVC	Sump Area	
184009	860-WU	Debris	PVC/SS	Sump Area	

Fat Max™ Strainers

- Dome bottom strainers are used for drain outlets

Part #	Mfg #	Strainer Type	Material	Price
166922	860-D	Dome Bottom w/Lift Hdl	ABS	
184007	860-GP	Full w/Lift Hdl	PVC	
184008	860-WGP2	Open-Half	PVC	

Square Max™ Flat Bottom Strainer

- For use with drain outlets
- DO NOT use on drains with 6" hub connection



Part #	Mfg #	Diameter	Material	Price
153830	861-6	5-1/16"	PVC	

PVC Fitting Socket Drain Adapter

- FIP thread x Sch. 40 spigot connection
- Fits into Sch. 40 hub
- 1/2" FIP tapped/plugged trap primer connection
- Combine these adapters with any of our 842-_L_ drains or 852-_L_ cleanout tops

Part #	Mfg #	FIP x Spigot	Size	Price
183971	842-93P	(3)	4-1/16" x 5/8"	

Gray PVC Round Replacement Strainer with Screws

- Fits: 822 series, 832 series, 833 series, 842 series, 843 series, 844 series, & 863 series
- Fat max strainers and accessories can be ordered separately



Part #	Mfg #	Diameter	Screw Centers	Price
127876	842-SP4	6-1/16"	4-7/8"	

Little Max™ PVC Sand Bucket for On-Grade Drains

Part #	Mfg #	Fits Inside:	Price
089244	864-S	Sump Area	

Little Max™ PVC Strainer for On-Grade Floor Drains

Part #	Mfg #	Description	Price
151995	864-GP	Loose Set with Lift Handle	

Two Adjusting Shims for On-Grade Drains

- Includes two 3/4" screws



Part #	Mfg #	Drain Top Size	Price
102453	832-S4	6-1/2"	

Square Max™ Strainers

- Factory installed



861-5



861-51



861-53



861-51NR

Part #	Mfg #	Strainer	Material	Ring	Price
121330	861-5	Full w/Lift Hdl	PVC	No	
152210	861-5CI	Full/Heel Proof Ductile Iron	Iron	Yes	
184020	861-5CIG	Full/Heel Proof Ductile Iron	Iron	No	
184022	861-5N	Full	Nickel Brz	No	
155111	861-5NR	Full	Nickel Brz	Yes	
103146	861-51	Open-Half	PVC	No	
184014	861-51N	Open-Half	Nickel Brz	No	
153832	861-51NR	Open-Half	Nickel Brz	Yes	
099073	861-53	Open-Quarter	PVC	No	
168225	861-53NR	Open-Quarter	PVC	Yes	



Plastic Floor Drains

PVC Trap Primer Drain Adapter

- FIP thread x Sch. 40 hub connection
- 1/2" FIP tapped/plugged trap primer connection
- Combine these adapters with any of our 842-_L_ drains or 852-_L_ cleanout

Part #	Mfg #	FIP x Hub	Size	Price
183959	842-83PT	(3")	4-11/16" x 3-3/8"	

Dome Screen For 867 Series Roof Drains

Part #	Mfg #	Material	Price
184046	867-UM	Stainless Steel	

Underdeck Clamp Kit

- 8" thread rod, (2)14" clamping bars, (4) washers & nuts

Part #	Mfg #	For:	Price
184044	867-C	867 Series Roof Drains	

Residential Accessories

Round Replacement Cast Strainers with Screws

- Fits: 821 series, 825 series, 827 series, 828 series, 829 series, 840 series

Part #	Mfg #	Dia.	Screw Centers	Finish	Price
153953	821-2SN	4"	2-5/8"	Nkl Brz	

Round-to-Square Strainer Adapter Kit

- Converts 821 drains with round stamped strainers to square
- Simply remove the round strainer from the drain head, attach the square adapter using two screws and snap the new square strainer in place
- Kit includes round-to-square adapter, square stainless steel strainer, two sets of screws and an illustrated instruction sheet

Part #	Mfg #	Finish	Price
181135	821-2QARB	Oil-Rubbed Bronze	
181134	821-2QASN	Satin	

Weld One™ & Quad Drain™ Replacement Strainers

New Pattern PolyPro

Part #	Mfg #	Dia.	Thickness	Color	Price
158175	801A2	6-1/8"	7/16"	Black	
133941	801-P2	6-1/8"	7/16"	White	

Old Pattern PolyPro

- 3/8" Thickness

Part #	Mfg #	Dia.	Screw Centers	Color	Price
010030	801-P	6-3/4"	5-1/2"	White	

Metal Ring & Strainer

- 3/16" Thickness

Part #	Mfg #	Diameter	Screw Centers	Price
158902	801-SR2	6-1/2"	4-7/8"	

Drains, Carriers, & Sumps

Sewage Ejectors

Sewage Pumps

LE40 Series Cast Iron Submersible Sewage Pump

- 2" Solids handling
- 2" FNPT Discharge
- 4/10 hp Oil filled, thermally protected motor
- 55 gpm @ 10' Head
- Vortex style polymer impeller
- Stainless steel rotor shaft and fasteners
- Automatic models feature a mercury-free adjustable wide angle float with series plug
- 10' Quick-disconnect cord
- 3-Year warranty



Part #	Mfg #	Description	Cord	Price
120996	LE41A	115V Auto	10'	

LE50 Series Cast Iron Submersible Sewage Pump

- 2" Solids handling
- 2" FNPT Discharge
- 1/2 hp Hermetically sealed motor, oil filled with thermal overload protection
- 112 gpm @ 25' Maximum head
- 2-Vane corrosion resistant HYTREL® impeller
- Stainless steel rotor shaft and fasteners
- Automatic models feature a mercury-free adjustable wide angle float switch with series plug
- 10' Quick-disconnect cord
- 3-Year warranty



Part #	Mfg #	Description	Cord	Price
120997	LE51A	115V Auto	10'	

Drains, Carriers, & Sumps

Sewage Ejectors

Dominator® Wastewater and Sewage Ejector Pumps

- Cast iron pump housings and cover with protective epoxy coating for corrosion and rust resistance
- Mechanical-type seals
- Thermal overload protection

9SN Series Oil-Filled Submersible Sewage Pump

- 70 gpm @ 10' Head
- Solids handling to 2"
- 2" FPNT Discharge
- Automatic operation with piggyback mechanical float; on level 9" to 14", off lever 2" to 6"
- 4/10 hp



Part #	Mfg #	Model	Description	Price
143068	509204	9SN-CIA-RF	115V Auto/Manual, 20' Cord	

Sewage Ejectors

Sewage Waste Pumps

264 "Waste-Mate" Cast Iron Submersible Sewage/Effluent*/Dewatering Pump

- 60 gpm @ 10' Head
- Passes 2" spherical solids
- Non-clogging vortex impeller
- 2" NPT Discharge
- Float operated, submersible (NEMA 6) 2-pole switch
- 4/10 Horsepower
- Suffix:
 - BN Includes Piggyback variable float



264 Automatic

Part #	Mfg #	Description	Cord	Price
028952	264-0001	115V Auto	15'	
028953	BN264	115V Manual	15'	

266 "Waste-Mate" Cast Iron Submersible Sewage/Effluent*/Dewatering Pump

- 89 gpm @ 10' Head
- Passes 2" spherical solids
- Non-clogging vortex impeller
- 2" NPT Discharge
- Float operated, submersible (NEMA 6) 2-pole switch
- 1/2 Horsepower



Part #	Mfg #	Description	Cord	Price
140834	N266	115V Manual	15'	

267 "Waste-Mate" Cast Iron Submersible Sewage/Effluent*/Dewatering Pump

- 89 gpm @ 10' of head
- Passes 2" spherical solids
- Non-clogging vortex impeller
- 2" NPT Discharge
- Float operated
- 1/2 Horsepower



Part #	Mfg #	Description	Cord	Price
036900	267-0001	115V Auto	10'	

314 High Capacity Non-Submersible Utility Pump

- Cast iron pump housing
- Engineered thermoplastic impeller
- Use for removing water from water heaters, power washing, water transfer and adding propylene glycol antifreeze to radiant heating lines
- Handle on prime plug
- Permanently-lubricated ball bearings
- Carbon ceramic shaft seal
- 20' (6 m) power cord
- On/off switch on motor housing
- Includes 3/4" NPT brass, lead-free garden hose adapters, suction screen and extra set of brushes
- Maximum temperature for dewatering: 104 °F (40 °C)



Part #	Mfg #	Description	Price
189668	314-0002	115V Manual	20'

Qwik Jon® Systems

Qwik Jon® System

- Includes:
 - Qwik Jon® tank
 - Lid and gasket
 - 2" Solids-handling Zoeller-built pump
 - Floor flange extender kit with wax rings
 - Check valve
 - Discharge pipe to lid
 - Qwik Jon® fittings and hardware
 - Installation instructions



Part #	Mfg #	Pump	Power	Price
033165	100-0006	WM264	0.4 hp/115V	

Grinder Pumps

The Shark® 820 Series Cast Iron Grinder Pump

- 1-1/4" NPT Vertical discharge
- Balanced bronze impeller
- Corrosion-resistant powder coated epoxy finish
- Stainless steel cutter plate/cutter, shaft, and hardware



Part #	Mfg #	Description	Cord	Price
039064	E820	230V Manual	20'	

Sewage Ejectors

The Shark® 840 Series Reversible Grinder Pump

- Durable heavy-duty finned cast iron construction
- Cutters can automatically alternate direction
- Tandem seals with leak detection
- 1-1/4" NPT Vertical discharge
- Balanced bronze impeller
- Corrosion resistant power coated epoxy finish
- Stainless steel screws, bolts and lifting bail
- 2 Horsepower



Part #	Mfg #	Description	Cord	Price
039415	840-0004	230V Manual/Auto	20'	

Shark® 803/805/807 Series Grinder Pump

Cast iron grinder series for difficult residential applications where ejectors struggle

- 803 - 1/2 HP, 805 - 3/4 HP, 807 - 1 HP
- Performance up to 55' (16.8 m)
- 115/230 V grinders for residential use without commercial grinder costs
- Oil filled for optimal heat dissipation
- Proven Tri-Slice® cutter technology -three independent cutting channels provide over 250,000 cuts per minute
- Stainless steel cutter and plate
- Automatic and nonautomatic available
- 100% factory tested



Part #	Mfg #	Description	Price
178218	803-0001	115/230V Manual/Auto	15'
178219	805-0001	115/230V Manual/Auto	15'
178220	807-0001	115/230V Manual/Auto	15'

Sewage Ejectors

Submersible Sewage Pumps

E7055 Series Sewage Pump

- *Handles 2" solids through a 2" discharge*
- *Energy efficient permanent split capacitor (PSC) motor*
- *Rated for continuous duty use*
- *Dual carbon/ceramic seals plus one Buna N seal*
- *Upper and lower sealed ball bearings*
- *Stainless steel fasteners*
- *Cast iron impeller*
- *3-year warranty*



Part #	Mfg #	Motor HP	GPM@ 10ft	GPH@ 10ft	Max Head	Discharge	Amps@ 10ft	Switch	Price
140124	E7055-NS	1/2 Hp	89	5340	23'	2"	7.0	No Switch	

Drains, Carriers, & Sumps

Sumps - Pits & Septic Tanks

Pre-Assembled Sewage Systems

Pro370 Series Simplex Sewage System

- 21" x 30" Sewage system
- 2" Solids handling
- Separate access cover
- QuickTree® float system
- Capacity: 41 gallons
- Anti-flotation collar
- Molded torque-stops
- Integrally molded handles
- Unique integrated cord seal technology
- Integral rubber cover seals
- 3-Year warranty



Part #	Mfg #	Description	Price
118393	P372LE41	115V, 4/10 hp, 60 lbs, 2" Discharge	
143626	P372LE51	115V, 1/2 hp, 64 lbs, 2" Discharge	

Pro380 Series Simplex Sewage System

- 24" x 24" Sewage system
- Shallow system design
- 2" Solids handling
- Separate access cover
- QuickTree® float system
- Capacity: 41 gallon
- Anti-flotation collar
- Molded torque-stops
- Integrally molded handles
- Unique integrated cord seal technology
- Integral rubber cover seals
- 3-Year warranty



Part #	Mfg #	Description	Price
121918	P382LE41	115V, 4/10 hp, 60 lbs, 2" Discharge	

Basin Extension

- Includes gasket, stainless steel bolts, longer QuickTree® for float mounting and discharge pipe extension



Part #	Mfg #	Description	Price
122733	X8	8" For Pro370 and Pro380	

Sump Pump Parts & Accessories

Basin & Cover Assembly

Part #	Mfg #	Description	Price
143685	K001107	Basin & Cover Assembly for Pro380 Series	

Sump Pump Hose Kit

- Polyethylene
- Includes:
 - 1-1/2" Threaded adapter
 - Hose clamp



Part #	Mfg #	Description	Price
045580	DHK-245	1-1/2" x 24' Flexible Hose	

Sump Pump Pit & Cover

- 18"Dia x 22"H (Inside dimensions)
- Overall height: 25"
- Poly sump pit, smooth wall
- 4" Rubber inlet grommet included
- 18" Cover with gasket seal and bolts (SC18)



Part #	Mfg #	Description	Price
122476	SP1822	Sump Pump Assembly Pit	

Drains, Carriers, & Sumps

Sumps - Pits & Septic Tanks

Drainosaur® Water Removal Systems

Drainosaur® Water Removal System

- 5 Gallon polypropylene tank
- Easy-to-remove filter trap
- 1/3 hp
- 45 gpm @ 5' Head
- Cast iron pump housing with protective epoxy coating
- Diaphragm switch activator



Part #	Mfg #	Model	Description	Price
006000	506055	WRS-6	115V Auto, 8' Cord	

Compact Drainosaur® Water Removal System

- 3-1/2 Gallon tank
- 1/3 hp
- 45 gpm @ 5' Head
- Cast iron pump housing with protective epoxy coating
- Diaphragm switch activator



Part #	Mfg #	Model	Description	Price
022320	506065	WRSC-6	115V Auto, 8' Cord	

Packaged Sewage Systems

Simplex Package with Structural Foam Polyethylene Basins and Steel Covers

- Package contains an Eliminator® Series Pump, automatic switch, rotational molded polyethylene basin, inlet hub, gas-tight cover assembly and check valve
- Cover assembly includes all discharge, vent and installation hardware
- 18" x 30" Basins includes 4" inlet hub in either cast iron caulking hub or snap-in vinyl configuration

9S Medium Commercial, Agricultural and Light Industrial

- Handles solids up to 2"
- Wastewater and sewage ejector pump
- 4/10 hp
- 2" or 3" Discharge with a maximum lift of 18'
- Auto operation with adjustable piggyback mechanical float switch; on level 11" to 16", off level 4" to 8"



Part #	Mfg #	Model	Description	Price
116057	509009	9S-SMPX	18" x 30", CI Hub, 1-Pc Lid	

Drains, Carriers, & Sumps

Sumps - Pits & Septic Tanks

**Simplex Sewage Package Systems -
Indoor**

**Simplex 2" Vent Job-Ready Sewage
Package Indoor System**

- 2" PVC Discharge pipe, 30" long
- Pump passes 2" spherical solids



18" x 30" Poly Structural Foam Basin

Part #	Mfg #	Pump	Price
080610	912-0007	M264 Auto	

Sumps - Pits & Septic Tanks

Distribution Boxes

- Injection molded HDPE
- Non-corrosive
- Speed leveler in each outlet
- Snap-in pipe seals



7HD2



9HD2

Part #	Mfg #	Description	Price
037035	7HD2	14-1/2" x 16" x 16", 7-Hole Distribution Box	
036192	9HD2	15" x 15" x 22", 9-Hole Distribution Box	

Distribution Box Lid

Part #	Mfg #	Description	Price
089256	B4-RL	16" x 16" Domed Lid for 7HD2	

Distribution Box Riser

- Stackable, watertight, gastight



Part #	Mfg #	Description	Price
140304	B1	6" x 11" x 11" Riser for 4HD2	
077309	B4	16" x 16" Square Riser for 7HD2	

Speed Levelers™

- To control effluent flow from a distribution box



Part #	Mfg #	Description	Price
036193	SL-4	Black & Yellow for 4" PVC Pipe	

Drop Box

- Inlet and outlet are at same level



Part #	Mfg #	Description	Price
140230	DB6	6-Hole Drop Box w/Lid	

Effluent Filters

EF-4 Residential Series Effluent Filter

- Removes solids down to 1/16"
- Combo includes:
 - 4" Standard length (14" rise) T-Baffle™ EF-4 Filter
 - B4035 Bushing
 - Optional SD-4 solids deflector



Part #	Mfg #	Description	Price
079277	EF4	Effluent Filter Only	

Sumps - Pits & Septic Tanks

Effluent Filters

PL-122 Effluent Filter

- Offers over 122 linear feet of 1/16" filter slots
- Shuts off the flow of effluent when filter is removed for cleaning
- Accepts 3" and 4" Sch 40 and SDR 35 Pipe



Part #	Mfg #	Description	Price
070198	PL122	Rated for 1,500-3,000 GPD	

Sumps - Pits & Septic Tanks

Effluent Filters

PL-68 Effluent Filter

- Offers 68 linear feet of 1/16" filter slots
- Accepts 3/4" PVC handle
- Housing can be used as inlet or outlet tee
- Gasket prevents bypass
- NSF Certified



Part #	Mfg #	Description	Price
131723	30130	PL-68 Polypropylene Filter Cartridge	

Septic Tank Risers

- Brings septic access to grade
- Watertight and airtight
- Made of UV-protected, shatter-resistant, high density polyethylene
- Structural ribs inside prevent frost from adhering in frost prone areas

Riser - 12" Diameter



Part #	Mfg #	Description	Price
135885	3017	6" Riser	

Riser - 20" Diameter



Part #	Mfg #	Description	Price
126819	3009	6" Riser	
126818	3009-12	12" Riser	

Riser - 24" Diameter



Part #	Mfg #	Description	Price
123426	3008	6" Riser	

Septic Tank Riser Covers and Grates

Riser Cover

- HDPE Construction



Part #	Mfg #	Description	Price
135886	3017-C12	12" Diameter	

Grated Riser Cover

- Stainless steel screws included
- HDPE Construction



Part #	Mfg #	Description	Price
134206	3008-G24	24" Diameter	

Heavy-Duty Riser Cover

- Stainless steel screws included
- Skid resistant surface
- HDPE Construction
- Factory installed gasket

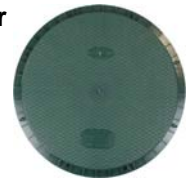

Part #	Mfg #	Description	Price
126817	3017-C20	20" Diameter	
123425	3008-HD24	24" Diameter	

Septic Tank Riser Accessories

Riser-To-Riser Adapter



Part #	Mfg #	Description	Price
126816	3009-RTR-20	Riser-To-Riser Adapter, 20" Dia	
123424	3009-RTR-24	Riser-To-Riser Adapter, 24" Dia	

Sumps - Pits & Septic Tanks

Distribution Boxes

20" Distribution Box

- Use as rain drain for gutters, driveways and sub-surface drainage
- Use as distribution box or drop box for onsite septic system
- Seal accepts 2", 3", 4" or 6" pipe



Part #	Mfg #	Description	Price
126820	3017-207	20" Drain, Valve & Meter Box with Cover	

Butyl Sealants



Part #	Mfg #	Size	Price
123428	3110-1	1/2" x 21'	

Sumps - Pits & Septic Tanks

Septic Tanks

MultiTank Single Compartment Septic Tank

- *Lightweight*
- *High strength engineered resin*
- *Watertight seamless construction*
- *Safe and unique access riser system*
- *Patented COEX-4 multi-layer co-extrusion process*
- *CSA, NSF, and IAPMO Certified*
- *P - Plumbing included*



Part #	Mfg #	Total Volume	Working Volume	Dimensions	Wt	Price
112514	RMT-300-1P	325 gal	300 gal	54" x 45" x 50"	120 lbs	

Septic Tank Accessories

Part #	Mfg #	Description	Price
109635	STAR-PP18	Pump Platform	

Fralo Septic Tanks

- *High strength engineered resin*
- *Watertight seamless construction*
- *Low profile*
- *50-Year warranty*
- *P - Plumbing included*



Septic Tank Riser

- *24" ID Riser*
- *Watertight connection*
- *Extra-strong flat top design*
- *Anti-slip surface*



Part #	Mfg #	Description	Price
084373	STAR-24R6	6" Septic Riser	
084374	STAR-24R12	12" Septic Riser	

Sumps - Pits & Septic Tanks

Infiltrator® Septic Tanks

- Thick, triple-wall design manufactured with proprietary state-of-the-art rotomolding technology
- Permanent, factory-installed structural bulkheads
- Reinforced access ports
- No special installation, backfill or water filling procedures are required; can be pumped dry
- Resistant to flotation in high water table conditions
- Can be installed with 6" to 48" of soil cover (check regulatory codes)
- Flat bottom



TW - Pump Tank

Part #	Mfg #	Total Volume	Diameter	Height	Price
123364	TW-300	313 gal	50"	50"	

TW - Dual Compartment Septic Tank

Part #	Mfg #	Total Volume	Working Volume*	Length	Width	Height	Price
123362	TW-1250-2P	1,448 gal	1,254 gal	143.7"	66"	50.6"	
123363	TW-1500-2P	1,762 gal	1,523 gal	170.1"	66"	50.7"	

* Based upon 39.75" liquid level

TW - Riser

Part #	Mfg #	Size	Price
137192	TWRIS-B2406	24" x 6"	
137193	TWRIS-B2412	24" x 12"	



Sumps - Pits & Septic Tanks

Sewage Basins

Fiberglass Basin

- Chop-hoop filament wound tank
- Includes:
 - (1) 18" Simplex steel cover 2" V&D
 - (1) 18" x 30" Fiberglass pit with 4" CI hub

Part #	Mfg #	Inside Dia	Capacity	Price
028099	FB18X030	18"	33 gal	

Sump Pumps

Sump Pumps

101 Series Pedestal Sump Pump

- 1-1/4" Discharge
- 1/3 hp, 60Hz, Continuous-duty, 1,725 rpm, PSC
- Cast iron construction, epoxy powder coated
- Zinc coated steel column
- Adjustable level control
- Double inlet screening
- Stainless steel rotor shaft
- 8' 3-Wire power cord and ground plug
- 3-Year warranty



Part #	Mfg #	Description	Price
123663	101	1/3 hp Upright	

230 Series Aluminum Submersible Sump Pump

- 3/8" Solids handling
- 1-1/2" Discharge
- 1/3 hp, 60Hz, 3,450 rpm
- Polypropylene and powder-coated aluminum construction
- Vortex-style impeller of high temp engineered thermoplastic
- Stainless steel rotor shaft
- 10' Quick-disconnect power cord
- 3-Year warranty



Part #	Mfg #	Description	Price
115238	237VMF	115V Auto, Vertical Magnetic Float	

250 Series Cast Iron Submersible Sump Pump

- 1/2" Solids handling
- 1-1/2" Discharge
- 1/3 hp Hermetically sealed motor, oil filled with thermal overload protection
- Heavy-duty cast iron pump with epoxy powder coat finish
- Vortex engineered polymer impeller
- Three switching options
- Energy saving model - efficient motor reduces electrical usage by up to 40%
- Permanently sealed and lubricated bearings
- 10' Quick-disconnect cord, unless noted otherwise
- 3-Year warranty



Part #	Mfg #	Description	Price
131287	251-2	115V Auto, Mercury-Free Float, 25' Cord Length	

Sump Pumps (Continued)

250 Series Cast Iron Submersible Sump Pump

Part #	Mfg #	Description	Price
120994	253	115V Auto, Mercury-Free Float, with Series Plug	
114396	257VMF	115V Auto, Vertical Magnetic Float	

280 Series Cast Iron Submersible Sump Pump

- 3/4" Solid handling
- 1-1/2" Discharge
- 1/2 hp Hermetically sealed motor, oil filled with thermal overload protection
- One-piece "Uni-body" casting
- Vortex engineered impeller
- 55 gpm @ 10' Head
- Permanently lubricated upper and lower bearings
- Stainless steel removable bottom screen, rotor shaft, and fasteners
- 10' Quick-disconnect cord, unless noted otherwise
- 3-Year warranty



Part #	Mfg #	Description	Price
122552	283-2	115V Auto w/Piggy-back, 25' Cord Length	
122533	287VMF	115V Auto, Vertical Magnetic Float	

450 Series Aluminum Submersible Sump Pump

- 3/8" Solids handling
- 1-1/2" Discharge
- 1/2 hp Hermetically sealed motor, oil filled with thermal overload protection
- 7.5A, 60Hz, 3,450 rpm
- Polypropylene and powder-coated aluminum construction
- Vortex-style impeller of high temp engineered thermoplastic
- Stainless steel rotor shaft
- Permanently lubricated upper and lower bearings
- 10' Quick-disconnect power cord
- 2-Year warranty



Part #	Mfg #	Description	Price
121529	457VMF	115V Auto, Vertical Magnetic Float	

Drains, Carriers, & Sumps

Sump Pumps

HT40 Series High-Temp Submersible Sump Pump

- For hot water applications up to 200°F
- 3/4" Solids handling
- 1-1/2" Discharge
- 4/10 hp, 12A
- Vortex impeller, made of temperature engineered thermoplastic
- Cast iron construction with all stainless and brass fasteners
- 416 Stainless steel rotor shaft
- Oil, filled thermally protected motor
- Permanently lubricated bearings
- Unitized shaft seal
- 10' UL Approved power cord with quick disconnect



Part #	Mfg #	Description	Price
136540	HT41A	115V Automatic	

SumpJet® Water Powered Back-Up Sump Pump

- 1-1/2" Discharge
- Powered by municipal water supply and requires no electricity
- Compact, high-efficiency design
- Removes 2 gallons of sump water per 1 gallon used
- Built-in backflow prevention
- Built-in screen with removable foot valve
- 3/4" NPT Water inlet connection with optional hose connector included
- Fully automatic
- Completely assembled
- 3-Year warranty



Part #	Mfg #	Description	Price
113773	SJ10	Water Powered Back-Up Pump	

S37 Builder's Series Submersible Sump Pump

- 35 gpm @ 10' Head
- 1/4" Solids handling
- Vortex style thermoplastic impeller
- 1-1/2" Discharge
- 10' Cord
- Vertical float switch
- 1/3 hp
- 2-Year warranty



Part #	Mfg #	Description	Price
124984	S37	115V Auto	

Sump Pump Accessories

"The Brick" Submersible Sump Pump Platform

- Raises sump pump 2.5" off the bottom of your pit
- Durable poly - will not corrode
- 2-Year warranty



Part #	Mfg #	Description	Price
121934	4445000	Fits Liberty Sump Pump Series: 220, 230, 240, 250, 270 & 280	

SBX Series Sump Box System

- Fully assembled
- S35 Pump
- Unique debris filter tray
- Large 41 gallon capacity
- Easy access cover requires no tools to open
- Easy to service float switches located in holders under access cover
- Sealed covers radon-ready
- Molded polyethylene basin material
- Basin dimensions: 18-3/4"H x 24"W x 32"L



Part #	Mfg #	Description	Price
123910	SBX35	115V, 1/3 hp, Complete System	

Drain Pumps

404 Drain Pump

- 3/8" Solids handling
- 1/3 hp Oil-filled, hermetically sealed motor with thermal protection
- 25 gpm @ 10' Head
- Fully automatic operation
- Maintenance-free, permanently lubricated sealed bearings
- Factory pre-assembled, ready to install
- Separate access cover
- Integrally molded rubber gasket for gas-tight seal
- 10' 3-Wire power cord with grounded plug
- 3-Year warranty



Part #	Mfg #	Description	Price
120995	404	115V, 1-1/2" FPT Inlet, Discharge and Vent	

Drains, Carriers, & Sumps

Sump Pumps

Utility Pumps

260 Model Submersible Utility Pump

- Pumps down to within 1/8" of base
- 1-1/4" Discharge with 5/8" garden hose adapter
- 1/6 hp
- 2-Year warranty



Part #	Mfg #	Description	Price
121916	260	115V, Non-Automatic 1/6 hp	

331 Model Cast Aluminum Portable Transfer Pump

- 1/2 hp, 8A, 60Hz, 7,500 rpm
- One-piece pump and motor housing with integral carry handle
- Epoxy powder coat finish
- Glass reinforced thermoplastic impeller
- Includes 3/4" brass garden hose adapters and suction screen
- On/off switch
- Permanently lubricated ball bearings
- Large prime plug with internal funnel design
- Easily replaced motor brushes
- Maximum discharge head: 105'
- Maximum suction lift: 15'
- 20' Cord
- 3-Year warranty



Part #	Mfg #	Description	Price
110244	331	115V Portable Transfer Pump	

Alarms

- For sump, sewage and effluent

ALM-2 Indoor High Liquid Level Alarm

- NEMA 1 Indoor rated
- 86 dB Alarm
- Red alarm light
- Green "power-on" light
- Low battery chirp
- Automatic reset
- Test/silence feature
- Plugs into a 115V outlet



Part #	Mfg #	Description	Price
121275	ALM-2-1	115V Indoor Alarm w/9V Battery Back-Up & 10' Float Cord	

ALM-2W Indoor/Outdoor High Liquid Level Alarm

- Meets type 3R watertight standards
- Thermoplastic enclosure
- Red alarm beacon, 360° visible
- 85 dB Horn
- Test/silence switch
- Green power-on indicator
- 20' Float cord



Part #	Mfg #	Description	Price
124533	ALM-2W	115V Indoor/Outdoor Alarm	

ALM-Pa Indoor Alarm with Probe Sensor

- Compact probe mounted sensor (snaps on 1-1/4" or 1-1/2" discharge pipe)
- Auxiliary contacts
- Visual and audio alarm



Part #	Mfg #	Description	Price
122840	ALM-P1	115V Indoor Alarm with 9V Battery Back-Up & Probe Sensor	

Sump Pumps

Accessories

Ball/Check Valve Combination

- Heavy-duty PVC
- 125 psi
- Vertical or horizontal installation
- Union for easy assembly
- Compact design



Part #	Mfg #	Size	Price
124087	BCV200	2"	

Quiet Check Valve

- Heavy-duty PVC
- Spring-loaded valve reduces "water hammer" effect
- Rated: 125 psi
- Vertical or horizontal installation
- Maximum fluid temp: 160°F



Part #	Mfg #	Description	Price
122776	QCV150	1-1/2"	
122777	QCV200	2"	

Cast Iron Anti-Siphon Check Valve

- Heavy-duty cast iron construction
- Integrated heavy weight nitrile ball check valve
- Anti-siphon features breaks suction to prevent unwanted tank siphonage
- Rated: 125 psi



Part #	Mfg #	Size	Price
134601	ACV125	1-1/4" NPT	

Cast Iron High Temp Check Valve

- Heavy-duty cast iron body
- High-temperature rubber flapper - 200°F
- Rated: 125 psi
- Vertical or horizontal installation



Part #	Mfg #	Size	Price
142300	HCV150	1-1/2" Female NPT	

Flanged 90° Grinder Elbow

- Provides vertical discharge for non-guide rail installations
- 1-1/4" FNPT Outlet
- Heavy cast iron construction
- Powder coated for corrosion resistance
- Includes sealing grommet and stainless steel bolts



Part #	Mfg #	Description	Price
125196	G90	Fits Omnivore LSG Series	

Float Control



Part #	Mfg #	Description	Price
138310	K001001	115V w/Series Plug, 10' Cord	

Pilot Duty Switch

Part #	Mfg #	Description	Price
134600	K001134	115V, 20' Cord	

Power Cord

Part #	Mfg #	Description	Price
132706	K001008	25' 115V Quick Connect Cord Kit	

Drains, Carriers, & Sumps

Sump Pumps

Water Leak Detectors

Lyric™ Wi-Fi Water Leak and Freeze Detector w/ Cable Sensor

- Includes 3(AA) batteries
- 3 Year battery life
- Notification messages and audible alerts
- Use to detect temperatures that can freeze pipes, and humidity that could damage valuables
- Runs on WiFi - no extra hub or hardware purchase required
- Reusable even after detecting an incident
- Wall or floor mount



Part #	Mfg #	Description	Price
189828	CHW3610W1001/ U	Battery Operated Leak Detector Alarm, 7" x 2-1/2"	
189829	CHWES41013/U	4 ft Cable Sensor for Lyric™ Wi-Fi Water Leak and Freeze Detector	

Sump Pumps

Water Wizard 5-Series Submersible Utility Pumps

- Commercial, industrial and home uses where liquid must be transferred or recirculated
 - 1/6 hp Shaded pole motor with overload protection
 - 1,200 gph @ 1' Head
 - 26.3' Maximum lift
 - Pumps down to 1/8"
 - 60Hz, 380 Watts, 5 Amps
 - Designed for continuous duty
 - Epoxy-coated cast aluminum housing
 - 1" FNPT Discharge includes garden hose adapter
 - Bottom inlet has removable screen for cleaning
- 5-MSP Oil-Filled Submersible Utility Pump**
- cCSAus Listed



Part #	Mfg #	Model	Description	Price
006006	505000	5-MSP	115V Manual, 10' Cord	

ES Series Submersible Sump/Effluent Pumps

ES33 Automatic Submersible Sump/Effluent Pump

- Handles up to 3/8" solids
- Energy saving
- Automatic operation with vertical diaphragm switch - operates pump @ 11" and shuts off at 5" of water - non-adjustable switch
- 1-1/2" FNPT Vertical discharge
- 115V
- Diaphragm pressure switch



Part #	Mfg #	Model	Description	Price
108533	506420	ES33D1-10	1/3 hp	

Big John® Submersible Sump Pumps

- Cast iron housing with epoxy coating

6 Series Oil-Filled Sump Pump

- 45 gpm @ 5' Head
- 1-1/2" FNPT Discharge 18' maximum head
- Non-adjustable pressure switch; on level 7" to 10", off level 1" to 4"
- Rated UL/CSA
- 1/3 hp



6-CIA



6-CIA-RFS

Part #	Mfg #	Model	Description	Price
006008	506158	6-CIA	115V Auto, 8' Cord	
006009	506171	6-CIA-RFS*	115V Auto, 10' Cord	

*RFS - Auto with adjustable piggyback mechanical float switch; On level 9" to 10-1/2", off level 2" to 3"

8 Series Oil-Filled Sump Pump

- 10A, 830 Watts
- 4/10 hp Shaded pole motor
- 1-1/2" Discharge
- Auto operation with non-adjustable pressure switch activates; On level 7" to 10", off level 1" to 4"
- CBM & CBA Models are cast bronze
- CIM & CIA Models are epoxy-coated CI
- UL/CSA Rated



Part #	Mfg #	Model	Description	Price
006011	508157	8-CIA	115V Auto, 10' Cord	

Sump Pump Switch Repair Kits



Part #	Mfg #	Model	Description	Price
005995	599300	SPRK-1	Switch Repair Kit	
005996	599320	SPRK-2	For 6-CIA,8-CIA,8-CBA	

Drains, Carriers, & Sumps

Sump Pumps

Piggyback Switches

- Convert any manual pump to an automatic pump

Piggyback Wide Angle Mechanical Float Switch



Part #	Mfg #	Model	Cord	Max HP	Price
021359	599118	RFSN6*	10' Cord	1/2	
027212	599117	RFSN9*	15' Cord	1/2	

* Comes with a 120V piggyback plug; ratings for 208V & 230V apply if plug is removed



Sump Pumps

Submersible Sump Pumps

ST Series Sump Pump

- Cast iron/cast aluminum construction
- Energy efficient permanent split capacitor (PSC) motor
- Piggy-back dual float switch with protective cage
- Continuous duty rated
- Dual carbon/ceramic seals
- 10' power cord
- Will fit in 10" diameter sump pit
- 3-Year warranty when purchased from and installed by a contractor, otherwise 18 months
- Water cooled



ST1033-NS

Part #	Mfg #	Motor HP	GPM@ 10ft	GPH@ 10ft	Max Head	Discharge	Amps@ 10ft	Switch	Price
165293	ST1033-NS	1/3 Hp	46	2770	29'	1.5"	3.8	No Switch	

S3 Series Sump Pump

- Cast iron / stainless steel construction
- Energy efficient permanent split capacitor (PSC) motor
- Continuous duty rated
- Stainless steel shaft
- Dual carbon/ceramic seals
- 20' Pump cord (S3050 & S3100), 10' Pump cord (S3033)
- 4-Year warranty when purchased from and installed by a contractor, otherwise 3 year
- Water cooled



S3033-NS

Part #	Mfg #	Motor HP	GPM@ 10ft	GPH@ 10ft	Max Head	Discharge	Amps@ 10ft	Switch	Price
166538	S3033-NS	1/3 Hp	50	3000	30'	1.5"	4.0	No Switch	
189194	S3050-NS	1/2 Hp	65	3900	33'	2"	4.3	No Switch	
189189	S3100-NS	1 Hp	92	5520	52'	2"	11.5	No Switch	

S5 Series Sump Pump

- Continuous duty construction
- Cast iron housing
- Energy efficient permanent split capacitor (PSC) motor
- Stainless steel shaft
- Upper and lower ball bearings
- Dual carbon ceramic seals with additional third shaft seal
- Dynamically balanced cast iron impeller
- Stainless steel fasteners & removable strainer
- 20' cord length
- 5-Year Warranty
- Water cooled



S5033-NS

Part #	Mfg #	Motor HP	GPM@ 10ft	GPH@ 10ft	Max Head	Discharge	Amps@ 10ft	Switch	Price
231144	S5033-NS	1/3 Hp	59	3540	26'	1.5"	4.0	No Switch	
157546	S5050-NS	1/2 Hp	83	4980	36'	2"	6.8	No Switch	



Sump Pumps

Controllers & Switches

Deluxe Controller with Dual Float Switch

- Monitors pump and power conditions
- Sounds an alarm when a problem is detected
- Begins pumping cycle when either float rises 1/4" and runs the pump an additional 10 seconds after the float returns to its original positions



Part #	Mfg #	Description	Price
144717	DFC2	Deluxe Controller w/ Dual Float Switch	

Enhanced Controller with Dual Float Switch

- Available w/ a dual float or vertical switch
- Activates pump weekly to exercise and extend pump life
- Pump run time is adjustable



Part #	Mfg #	Description	Price
222432	DFC15	Enhanced Controller w/ Dual Float Switch	

Standard Dual Float Controller

- Two micro reed activated floats for added reliability
- Protective cage prevents debris from interfering with floats
- Switch is mounted independent from pump, allowing user to adjust the height of pump activation



Part #	Mfg #	Description	Price
141072	DFC1	Standard Controller w/ Dual Float Switch	



Sump Pumps

Sump Pump Combination Systems

Included with System

- Primary & Backup Pumps
- (3) 1-1/2" Standard no hub couplings
- (2) Standard check valves with hardware
- Sump Foot - Raises and secures both pumps
- Backup System controller/charger with fluid sensor
- Primary Pump controller enhanced controller with caged dual float switch (DFC1.5)
- Battery Box

Pro Series PS-C11 Combination Sump Pump System

- Designed for use with wet cell or AGM / maintenance free batteries
- Dual float switches provide dependable activation for each pump
- Unique monitoring controller sounds an alarm if maintenance is needed
- Pumps are securely attached to raised Sump Foot with stainless steel screws to prevent movement or breakage



ST1033 Primary Pump

PHCC-1000 Backup - 1000 GPH at 10', 12 VDC

Part #	Mfg #	Motor HP	GPH@ 10ft	Max Head	Discharge	Amps@ 10ft	Voltage	Price
146226	PS-C11	1/3 Hp	2770	29'	1-1/2"	3.8	115V, 60Hz	

Pro Series PS-C22 Combination Sump Pump System

- Remote terminals for connection to a security system or auto-dialer
- Designed for use with wet cell or AGM / maintenance free batteries
- Dual float switches provide dependable activation for each pump
- Unique monitoring controller sounds an alarm if maintenance is needed and runs pump weekly to test for proper operation
- Pumps are securely attached to raised Sump Foot with stainless steel screws to prevent movement or breakage



ST1033 Primary Pump

PHCC-1730 Backup - 1730 GPH at 10', 12 VDC

Part #	Mfg #	Motor HP	GPH@ 10ft	Max Head	Discharge	Amps@ 10ft	Voltage	Price
141757	PS-C22	1/3 Hp	2770	29'	1-1/2"	3.8	115V, 60Hz	

Pro-Series PS-C33 Combination Sump Pump

- Remote terminals for connection to a security system or auto-dialer
- Designed for use with wet cell or AGM / maintenance free batteries
- Can accommodate two (2) standby batteries to double the run time
- Caged dual float switches provide dependable activation for each pump
- Pumps are securely attached to raised Sump Foot with stainless steel screws to prevent movement or breakage



S3033 Primary Pump

PHCC-2400 Backup - 2400 GPH at 10', 12VDC

Part #	Mfg #	Motor HP	GPH@ 10ft	Max Head	Discharge	Amps@ 10ft	Voltage	Price
133829	PS-C33	1/3 Hp	3000	30'	1-1/2"	4.0	115V, 60Hz	

Drains, Carriers, & Sumps



Sump Pumps

Backup Pumps

Pro Series PHCC-1000 Battery Backup Sump Pump System

- Stainless steel shaft, rulon seal, and rustproof housing provide long-lasting, reliable operation
- Trickle charger maintains the battery at full charge
- System continuously monitors the battery and power conditions to ensure dependable operation and sounds an alarm when:
 - The AC power is out or the circuit breaker has blown
 - The battery fluid is low and water needs to be added
 - The pump was activated
 - The battery is discharged, defective or the terminals need cleaning
- Alarm can be silenced



Part #	Mfg #	Motor Type	Max Head	GPH@ 10ft	Amps@ 10ft	Power Input	Price
157717	PHCC-1000	Brush DC	15 ft	1000	6.5	115VAC, 60Hz	

Pro Series PHCC-1730 Battery Backup Sump Pump System

- Computer programmed battery charging system minimizes water loss in battery and ensures that the battery is always fully charged
- Remote terminals to connect to a home security system, auto dialer or other device
- -Sounds an alarm and indicates when:
 - Battery needs water
 - Battery is old and needs to be replaced
 - Battery is discharged or defective
 - Cable is loose or terminals are corroded
 - Power, fuse or circuit breaker has failed
 - Pump has been activated
- Computerized controller continuously monitors the pump, battery and power conditions to ensure dependable operation
- Accommodates up to two (2) B-2200 batteries for 120 hours of pumping*
- Alarm can be silenced during an emergency and will automatically reset in 24 hours - (2)B22220 or (2)B12-90 batteries



Part #	Mfg #	Motor Type	Max Head	GPH@ 10ft	Amps@ 10ft	Power Input	Price
133835	PHCC-1730	Brush DC	16 ft	1730	10-12	115VAC, 60Hz	

Pro Series PHCC-2400 Battery Backup Sump Pump System

- Recharges automatically
- Monitors system conditions and alarms when:
 - Battery needs water, is discharged or needs to be replaced
 - Battery cable is loose or corroded
 - Power plug is disconnected, fuse is blown or circuit breaker is tripped
 - Pump is clogged or broken
 - Backup pump has been activated
- Alarm can be silenced during a power outage
- Displays percentage of power remaining in the battery
- Runs pump weekly to test for proper operation
- Can run directly on AC power, automatically switches to battery when AC fails
- Output terminals for connection to a security system or auto-dialer
- Accommodates up to two (2) B-2200 batteries for 100 hours of pumping - either (2)B22220 or (2)B12-90 batteries



Part #	Mfg #	Motor Type	Max Head	GPH@ 10ft	Amps@ 10ft	Power Input	Price
132436	PHCC-2400	Brush DC	17 ft	2400	16	115VAC, 60Hz	

Drains, Carriers, & Sumps

Sump Pump Parts & Accessories

Batteries & Acid

Pro Series Standby Battery

- Helps run pump longer
- Works with all PHCC Backup and Combo Systems
- Accommodate the battery fluid sensor (wet cell batteries)



B-2200

Acid sold separately (wet cell batteries)

Part #	Mfg #	Description	Price
086614	B-2200	Reserve Cap @ 25 Amps: 182 min	

Pro Series Sealed Battery

- Maintenance free
- Sealed, absorbed glass mat (AGM)
-



Part #	Mfg #	Description	Price
142173	B12-90	12 VDC, 90 Amp Hours	

Battery Acid

- Activates wet cell battery
- Flexible pour spout



Part #	Mfg #	Description	Price
133830	Z-PACK	6 Quarts	

Accessories

Jumper Cable

- 12 Gauge wires
- 40" Length
- 3/8" and 5/16" ring terminals
- 1-Year Warranty



Part #	Mfg #	Description	Price
133832	PJC	Parallel Jumper Cable	

Sump Foot

- Pre-drilled holes
- Made of high impact polypropylene
- Keeps pumps out of dirt and debris
- 1-Year Warranty



SF2

Part #	Mfg #	Description	Price
181869	SF2	For Single Primary or Backup Pump	

Check Valve

- Flapper opens 100%
- Used on primary pumps for combo systems
- 1-Year Warranty



1141003

Part #	Mfg #	Description	Price
180041	1141003	Screw-In, 1-1/2"	

Quick Connect Main Pipe

- Pre-assembled with:
 - 1-1/2" Rubber coupling
 - 1-1/2" Check valve
 - 1-1/2" NPT Female adapter
 - Pre-Drilled weep hole
 - Discharge pipe
 - 1-1/2" NPT Threaded male adapter



PS-MP

Part #	Mfg #	Description	Price
178522	PS-MP	Total Length: 14.25"	

Water Alarm

- Solid state circuitry is extremely sensitive and reliable
- 110dB alarm can be heard throughout the house
- Alarm will sound up to 3 days
- Battery will last 24-48 months



Part #	Mfg #	Description	Price
157047	PWA	9V Alkaline Battery (Not Included)	

Drains, Carriers, & Sumps

Sump Pumps

Sump Pump Discharge Kits

- Ideal for discharging water out of the basement sump to a safe location outside the home



- Kit includes:
 - 1-1/4" x 24' Corrugated polyethylene hose
 - ABS Threaded 1-1/2" MNPT x 1-1/4" barbed adapter
 - ABS Threaded 1-1/4" MNPT x 1-1/4" barbed adapter
 - Galvanized steel clamp

Part #	Mfg #	Model	Description	Price
010307	599303	SPDK	1-1/4" & 1-1/2", Black	

Sump Pumps

"Mighty-Mate" Submersible Effluent or Dewatering Pump

53 "Mighty-Mate" Cast Iron Submersible Pump

- 34 gpm @ 10' Head
- Passes 1/2" spherical solids
- Non-clogging vortex impeller
- 1-1/2" NPT Discharge
- Float operated
- 3/10 Horsepower



Part #	Mfg #	Description	Cord	Price
027850	M53	115V Auto	9'	

"Flow-Mate" Submersible Effluent or Dewatering Pump

98 "Flow-Mate" Cast Iron Submersible Pump

- 61 gpm @ 10' Head
- Passes 1/2" spherical solids
- Vortex impeller design
- 1-1/2" NPT Discharge
- Float operated submersible
- 1/2 Horsepower



Part #	Mfg #	Description	Cord	Price
050443	M98	115V Auto	15'	

137 "Flow-Mate" Cast Iron Submersible Pump

- 79 gpm @ 10' Head
- Passes 5/8" spherical solids
- Non-clogging vortex impeller
- 1-1/2" NPT Discharge
- Float operated
- 1/2 Horsepower



Part #	Mfg #	Description	Cord	Price
073136	M137	115V Auto	10'	

Backup Systems

Aquanot® Flood Alert® High Water Alarm

- Operates on (3) AAA batteries
- Low battery alarm
- On/off silence switch
- Stainless steel sensor contacts
- Solid state electronic components
- 5' Lead wire
- AC Power adapter capability, requires Class 2 transformer:
 - Input: 120VAC/60Hz,
 - Output: 4.5VDC/150 mA, tip positive, type B plug
- 1-Year limited warranty



Part #	Mfg #	Description	Price
035746	10-0763	High Water Alarm	

Aquanot® Deep-Cycle Battery



10-0761

Part #	Mfg #	Description	Price
093946	10-1450	AGM Deep Cycle	
053828	10-0761	Wet Battery	

Basement Sentry™ 12V Back-up System

- For clear water
- Includes:
 - Non-corrosive pump
 - Self-contained 10A battery recharger
 - Pump alarm
 - Battery case
 - Fittings
- Battery burn-out and overcharge protection
- Not recommended for installation with over 12' total dynamic head



Part #	Mfg #	Description	Price
028011	507-0005	Adapt Check Valve to Pipe	

Sump Pumps

Home-Guard Max Pump Back-up System

- Water powered emergency back-up sump pump system
- Anticorrosive PVC construction
- Performs at 80 psi
- Removes up to 2 gallons per gallon used
- 2-Year limited warranty



Part #	Mfg #	Description	Price
121999	503-0005	Water Operated Back-up Sump Pump	

Preassembled Sump Pump Systems

Pro Pak Series Sump Pump

- Comes fully assembled and ready to install
- Automatic operation
- 7-1/2 Hours continuous pumping on a fully charged battery
- Battery burn out and overcharge protection
- 12V Deep cycle marine battery not included
- Includes:
 - 115VAC Primary pump
 - Model 507 basement sentry backup system with pump, check valve, float switch and piping
 - Plumbed in 1-1/2" Sch 40 PVC pipe
- 3-Year warranty on entire system



Part #	Mfg #	Description	Price
126635	507-0008	M53 Sump Pump, 507 Backup System	

Scale Removal Systems

109 Series Scale Removal System

- Removes line build-up in tankless water heating units
- Preassembled with hoses, tank, pump and fittings
- Internal reusable filter sock
- Meets flushing requirements for tankless water heater systems
- Pump: 1/6 horsepower, 3.0 FLA, 345 watts, 115V, air-filled (no oil), quiet submersible
- 5 Gallon polyethylene tank and lid with stainless steel hardware
- 3/4" Stainless steel braided flush lines
- Stainless steel handles
- Corrosion resistant
- 3 Gallons per minute recirculation rate



Part #	Mfg #	Description	Price
143567	109-0005	109 SRS Scale Removal System	

Variable Level Control Switch

- Durable PVC/polypropylene float encasing variable level switch
- Switch open when hanging vertically above liquid level - closed when reaching a few degrees above horizontal



Mercury Float Switch Cord

Part #	Mfg #	Cord Length	Price
147456	10-3121	25"	

"Full-Flow" Unichecks

Inline Check Valve

- Rubber coupling with stainless steel clamps
- Threads into pump discharge
- Pre-drilled weep hole
- 4.3 PSI, 10' (3 m) of head
- Vertical installation only
- 12 per carton



Part #	Mfg #	Description	Price
181152	30-0238	1-1/2"	

Sump Pumps

ABS Plastic Union (Slip x Slip)

- Checks backflow of water and sewer gas
- Neoprene gasket and flapper, weighted with heavy stainless steel metal backing plates and stainless steel rivet
- Reduces motor and pump noise
- Stops electrolysis
- Vertical or horizontal installation



Part #	Mfg #	Size	Price
013924	30-0021	2"	

PVC Union (Slip x Slip)

- Checks backflow of water and sewer gas
- Flapper bends over radius - no sharp 90° edges - lengthens life of flapper hinge
- PVC Plastic check body bolted together
- Vertical or horizontal installation



Part #	Mfg #	Size	Price
012917	30-0181	1-1/2" or 1-1/4"	

"Quiet Check" PVC Solvent Weld with Union Check Valve (Comp)

- Checks backflow of water and sewer gas
- Corrosion resistant, nonmetallic parts
- Buna-N flapper, double shielded with PVC
- Buna-N compression ring seals
- Reduces motor and pump noise from plumbing system
- Designed for both horizontal and vertical usage
- Pressure rating: 25 psi at 57'
- Consult factory if use over 130°F required
- Suitable for installation below basin cover
- Compression union solvent weld end fittings



Part #	Mfg #	Pipe Size	Body	Price
130543	30-0040	1-1/2"	White	
133711	30-0042	2"	White	

Tri-Check™

PVC Check Valve/Ball Valve/Union Combination

- Check valve full flow design
- Neoprene gasket and flapper weighted stainless steel backing plates and rivet
- Installed on vertical or horizontal pipe
- All stainless steel screws
- Extra wide hinge to reduce stress
- Rated for 25 psi (58' of head)



Part #	Mfg #	Size	Price
092618	30-0100	1-1/2"	
092619	30-0101	2"	

A-Pak Alarm Systems

Indoor/Outdoor A-Pak II Alarm System

- NEMA 4X Thermoplastic alarm panel
- Horn and light warn of high liquid levels
- Test and silence switch
- Auxiliary dry high level alarm 5A contacts
- 115VAC Operates on separate circuit from pump
- Use with liquids to: 140°F (60°C)
- Horn rated at 88 dB at 10'
- UL Listed for US and Canada



Part #	Mfg #	Description	Price
080330	10-0126	115V, 1-Ph w/15' Float Switch	

Sump Pumps

Battery Back-Up Systems

Automatic Sump Pump Back-Up System

- Provides extra protection in the event the primary sump pump fails, an obstruction in the sump pit blocks flow or a power outage occurs
- Also functions as an alarm system if the primary pump fails to empty the sump pit
- Powered by 12VDC battery (not included)
- Controller/charger monitors the battery condition and charges the battery when required

Part #	Mfg #	Model	Description	Price
021358	506400	SPBS-12	120V 1,360 gph	

Sump Pumps

Tank Alarm Systems

Tank Alert® I Alarm System

- Warns of high or low liquid levels
- For use in lift pump chambers, sump pump basins, holding tanks, and water sewage systems
- NEMA 1 (Indoor) alarm panel and sensor float control switch
- Loud horn plus panel light alarm
- Plugs into receptacle or hard wire
- Low voltage and isolated for 120V power line
- UL Listed; miscellaneous signal appliance
- CSA Certified
- 3-Year limited warranty



Part #	Mfg #	Model	Description	Price
010082	1003104	101-01H	120VAC High Level	

Drains, Carriers, & Sumps

Sump Pumps

Plumbing Valves

Silent Rubber Hose Check Valve

- One-piece ABS plastic housing
- No gasket on valve body
- Valves certified leak proof and pressure tested
- 1-1/2" Full Flow is optimized to fit only 1-1/2" pipe offering 17% improved flow capability
- Nested flapper
- All mounting hardware included

Part #	Mfg #	Description	Price
113017	CV00SL15	1-1/2" Check Valve	

Silent True Union Swing Check Valve

- Injection molded ABS thermoplastic
- O-Ring seal
- For heavy-duty use on home ejector pumps
- Easy to remove for regular cleaning or inceptions
- Installs vertically or horizontally

Part #	Mfg #	Description	Price
113018	CVUNSL15	1-1/2" Check Valve	

Trench Drains

Channel Drains & Accessories

Dura Slope™ Trench Drain System

- Flanges on bottom of channel provide lip for anchoring
- Lightweight 4 foot modular sections
- May be cut to any length

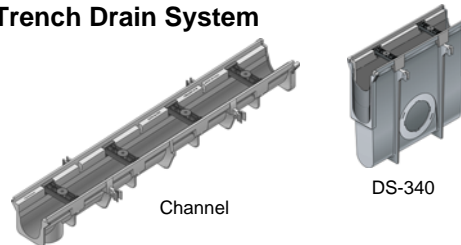

Part #	Mfg #	Description	Color	Price
095381	DS-090N	3.99" Deep Neutral Dura Slope Channel	Gray	
095382	DS-091	3.99" to 4.33" Deep Dura Slope Channel	Gray	
095383	DS-091N	4.33" Deep Neutral Dura Slope Channel	Gray	
095384	DS-092	4.33" to 4.67" Deep Dura Slope Channel	Gray	
095385	DS-093	4.67" to 5.01" Deep Dura Slope Channel	Gray	
095386	DS-094	5.01" to 5.34" Deep Dura Slope Channel	Gray	
095387	DS-094N	5.34" Deep Neutral Dura Slope Channel	Gray	
095388	DS-095	5.34" to 5.68" Deep Dura Slope Channel	Gray	
095389	DS-096	5.68" to 6.01" Deep Dura Slope Channel	Gray	
095390	DS-097	6.01" to 6.35" Deep Dura Slope Channel	Gray	
095391	DS-097N	6.35" Deep Neutral Dura Slope Channel	Gray	
095392	DS-098	6.35" to 6.69" Deep Dura Slope Channel	Gray	
095393	DS-099	6.69" to 7.02" Deep Dura Slope Channel	Gray	
095394	DS-100	7.02" to 7.36" Deep Dura Slope Channel	Gray	
069719	DS-100N	7.36" Deep Neutral Dura Slope Channel	Gray	
068598	DS-101	7.36" to 7.69" Deep Dura Slope Channel	Gray	
068599	DS-102	7.69" to 8.03" Deep Dura Slope Channel	Gray	
068593	DS-103	8.03" to 8.37" Deep Dura Slope Channel	Gray	
069720	DS-103N	8.37" Deep Neutral Dura Slope Channel	Gray	
068594	DS-104	8.37" to 8.70" Deep Dura Slope Channel	Gray	
068595	DS-105	8.70" to 9.04" Deep Dura Slope Channel	Gray	
068597	DS-106N	9.37" Deep Neutral Dura Slope Channel	Gray	
069721	DS-107	9.37" to 9.70" Deep Dura Slope Channel	Gray	
094408	DS-340	2' Outlet Catch Basin	Gray	

Dura Slope™ Grate

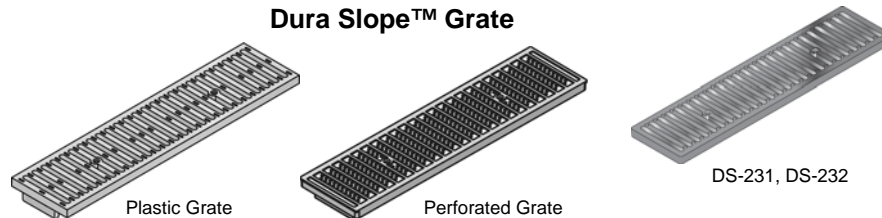

Part #	Mfg #	Description	Color	Price
069731	DS-221	2' Galv Steel Channel Grate	Steel	
069732	DS-231	2' Cast Iron Channel Grate	Black	
069733	DS-232	2' Ductile Iron Channel Grate	Black	
069735	661LG	2' Plastic Channel Grate	Gray	
068601	663	2' Plastic Channel Grate	Black	

Trench Drains

Channel Drains & Accessories (Continued)

Dura Slope™ Grate

Part #	Mfg #	Description	Color	Price
069737	664	2' Plastic Channel Grate	Sand	

Dura Slope™ Accessories

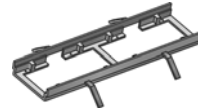

DS-200



DS-227

Part #	Mfg #	Description	Color	Price
068606	DS-122	ProFit Grate Lock	Gray	
069729	DS-123	Frame & End Cap Screws 12/Bag	Gray	
094407	DS-224	Universal End Cap	Gray	
094409	DS-227	Universal End Outlet	Gray	
069730	DS-126	Bottom Outlet Adapter	Gray	
068607	629	Grate Screws FH #1/4 - 20 x 1-1/2"	Steel	
094936	DS-200	Ductile Iron Frame	Black	

Drainage Products

12" Square Catch Basin Grate



Part #	Mfg #	Description	Color	Price
087628	1210	12" x 12" Square Grate	Gray	

Universal Catch Basin Outlet



1243



1245



1206

Part #	Mfg #	Description	Color	Price
069740	1243	3" & 4" Universal Locking Outlet	Black	
069741	1245	3" & 4" Offset Universal Locking Outlet	Black	
069739	1206	6" Universal Plug Adapter	Black	

Drains, Carriers, & Sumps

Trench Drains

Trench Drainage Systems

Z886 Perma-Trench® System

- 6" Wide, pre-sloped system
- High density polyethylene composite drain channel with 75% bottom slope
-Models with -N Suffix are no slope
- All sections are 80" modular lengths with integral top fram, inter-locking ends and radiused bottom
- Combination tie-down/leveling devices at 20" intervals
- Dura-coated cast iron grate unless otherwise specified



Part #	Mfg #	Shallow	Deep	GPM	Price
170493	P8601	3.50"	4.10"	93	
170495	P8602	4.10"	4.70"	122	
170496	P8603	4.70"	5.30"	152	
170497	P8604	5.30"	5.90"	183	
170498	P8605	5.90"	6.50"	214	
171050	P8606	6.50"	7.10"	245	
170499	P8607	7.10"	7.70"	276	
170500	P8608	7.70"	8.30"	308	
178807	P8609	8.30"	8.90"	339	
172910	P8610	8.90"	9.50"	371	
171146	P8612	10.10"	10.70"	435	
176030	P8612N	10.70"	10.70"		

Z886

Part #	Mfg #	Description	Price
170505	P886-E3	3" No-Hub End Outlet	
170506	P886-E4	4" No-Hub End Outlet	
170504	P886-U4	4" No-Hub Bottom Outlet	

Z883 Perma-Trench® Shallow System

- 6" Wide
- High density polyethylene composite drain channel with 3.5" depth
- All sections are 40" modular lengths with integral top fram, inter-locking ends and radiused bottom
- Combination tie-down/leveling devices at 20" intervals
- Dura-coated cast iron grate unless otherwise specified



Part #	Mfg #	Description	Price
170512	P883	6" Wide, 3.5" Depth	
170513	P883-E1	6" W, 3.5" D w/ Closed End Cap	
170514	P883-E2	6" W, 3.5" D 2" No-Hub End Outlet	

Drains, Carriers, & Sumps

Bar Faucets

Faucets & Valves

Single-Handle Beverage Faucets

Wellspring™ Contemporary 1-Hdl Beverage Faucet

- 4-7/8" Reach, 8-3/4" high arch swivel spout
- Solid brass construction
- 1/4-Turn washerless ceramic valving
- Aquifer water filtration system
- Stainless steel hose
- Aerator
- Not for use with hot water or reverse osmosis filtration



Part #	Mfg #	Description	Handle(s)	Finish	Price
126116	K-6665-BL	1-Hole	ADA RH Lever	Matte Black	
054179	K-6665-BN	1-Hole	ADA RH Lever	*Brushed Nickel	
081147	K-6665-BV	1-Hole	ADA RH Lever	*Brushed Bronze	
053689	K-6665-CP	1-Hole	ADA RH Lever	Polished Chrome	
061789	K-6665-G	1-Hole	ADA RH Lever	Brushed Chrome	
099309	K-6665-VS	1-Hole	ADA RH Lever	*Stainless	
071688	K-6665-F-BN	1-Hole, Includes Aquifer Water Filtration System	ADA RH Lever	*Brushed Nickel	
183111	K-6665-F-BL	1-Hole, Includes Aquifer Water Filtration System	ADA RH Lever	Matte Black	
092205	K-6665-F-CP	1-Hole, Includes Aquifer Water Filtration System	ADA RH Lever	Polished Chrome	
099932	K-6665-F-VS	1-Hole, Includes Aquifer Water Filtration System	ADA RH Lever	*Stainless	

Wellspring™ Traditional 1-Hdl Beverage Faucet

- 3" Reach, 7-5/8" high arch swivel spout
- Flow rate: 1.6 gpm
- Solid brass construction
- 1/4-Turn washerless ceramic valving
- Aquifer water filtration system
- Stainless steel hose
- Aerator
- Not for use with hot water or reverse osmosis filtration



K-201 or K-202 Aquifer® replacement cartridge required for -F models only

Part #	Mfg #	Description	Handle(s)	Finish	Price
053690	K-6666-CP	1-Hole	ADA RH Lever	Polished Chrome	
058757	K-6666-BN	1-Hole	ADA RH Lever	*Brushed Nickel	
079291	K-6666-BV	1-Hole	ADA RH Lever	*Brushed Bronze	
068916	K-6666-G	1-Hole	ADA RH Lever	Brushed Chrome	
173262	K-6666-SN	1-Hole	ADA RH Lever	*Polished Nickel	
099558	K-6666-VS	1-Hole	ADA RH Lever	*Stainless	
147009	K-6666-2BZ	1-Hole	ADA RH Lever	Oil-Rubbed Bronze	
078267	K-6666-F-BN	1-Hole, Includes Aquifer Water Filtration System	ADA RH Lever	*Brushed Nickel	
075005	K-6666-F-BV	1-Hole, Includes Aquifer Water Filtration System	ADA RH Lever	*Brushed Bronze	
097128	K-6666-F-SN	1-Hole, Includes Aquifer Water Filtration System	ADA RH Lever	Polished Nickel	
173096	K-6666-F-VS	1-Hole, Includes Aquifer Water Filtration System	ADA RH Lever	*Stainless	
147010	K-6666-F-2BZ	1-Hole, Includes Aquifer Water Filtration System	ADA RH Lever	Oil-Rubbed Bronze	

* Vibrant Limited Lifetime Finish

www.waterconcepts.net • Serving our Customers Since 1946 • www.plumbsupply.com

Bar Faucets

Single-Handle Bar Faucets Artifacts™ 1-Hdl Bar Sink Faucet

- 7" Reach, 13-1/16" high, 360° swivel spout
- Metal construction
- Ceramic disc valve
- Flow rate: 1.8 gpm



Part #	Mfg #	Description	Handle(s)	Finish	Price
177653	K-99264-CP	1-Hole, Less Side Spray	ADA Lever	Polished Chrome	
181994	K-99264-VS	1-Hole, Less Side Spray	ADA Lever	*Stainless	

Artifacts™ 1-Hdl Pull-Out Bar Faucet

- 7-5/8" Reach, 16" high, 360° swivel spout
- Stainless steel construction
- DockNetik™ magnetic docking system
- Ceramic disc valves
- ProMotion™ quiet braided hose
- MasterClean™ sprayface with three spray functions
 - Sweep™
 - BerrySoft™
 - Aerated
- Flow rate: 1.8 gpm



Part #	Mfg #	Description	Handle(s)	Finish	Price
176274	K-99261-CP	1-Hole, Pull-Out Spray	ADA Lever	Polished Chrome	
175224	K-99261-SN	1-Hole, Pull-Out Spray	ADA Lever	Polished Nickel	
178216	K-99261-VS	1-Hole, Pull-Out Spray	ADA Lever	*Stainless	
181832	K-99261-2BZ	1-Hole, Pull-Out Spray	ADA Lever	Oil-Rubbed Bronze	

Artifacts® Gentleman's™ Bar Sink Faucet

- 7-5/16" Reach, 13-13/16" high
- Metal construction
- Ceramic disc valves
- Temperature memory
- Meets CalGreen requirements for kitchen faucets
- Flow rate: 1.8 gpm @ 60 psi



Part #	Mfg #	Description	Handle(s)	Finish	Price
187197	K-99268-SN	1-Hole, Less side spray	ADA Lever	*Polished Nickel	
224613	K-99268-VS	1-Hole, Less side spray	ADA Lever	*Stainless	
222409	K-99268-2BZ	1-Hole, Less side spray	ADA Lever	Oil-Rubbed Bronze	

* Vibrant Limited Lifetime Finish

www.plumbsupply.com • Serving our Customers Since 1946 • www.waterconcepts.net

Bar Faucets

Faucets & Valves

Evoked® 1-Hdl Secondary Kitchen Faucet

- 7" Reach, 8.5" high, 360° swivel spout
- Metal construction
- One-piece, self-contained ceramic disc valve allows both volume and temperature control
- High-temperature limit setting
- Flow rate: 2.2 gpm



Part #	Mfg #	Description	Handle(s)	Finish	Price
156997	K-6335-CP	2-Hole, w/ Side Spray	ADA Lever	Polished Chrome	
130196	K-6335-VS	2-Hole, w/ Side Spray	ADA Lever	*Stainless	
156115	K-6335-BL	2-Hole, w/ Side Spray	ADA Lever	Matte Black	

Forté® 1-Hdl Entertainment Kitchen Faucet

- 7-3/4" Reach, 10-1/8" high swivel spout
- Metal construction
- Washerless ceramic valving, flexible supplies
- Remote valve
- Aerator



K-10441



K-10443

Part #	Mfg #	Description	Handle(s)	Finish	Price
100636	K-10441-CP	3-Hole, Matching Side Spray	ADA Lever	Polished Chrome	
100637	K-10443-CP	2-Hole, Less Side Spray	ADA Lever	Polished Chrome	
100634	K-10443-VS	2-Hole, Less Side Spray	ADA Lever	*Stainless	

Karbon® Articulating Bar/Lavatory Faucet

- 6" Reach spout
- Silver tube
- Metal and carbon fiber construction
- Brass valve bodies
- Integral sprayhead
- 1-5/16" Diameter remote joystick valve
- Touch-activated drain
- Flow rate: 1.5 gpm
- Meets EPA WaterSense® criteria



Part #	Mfg #	Description	Handle(s)	Finish	Price
152066	K-6268-C11-BN	1-Hdl 8", Touch-Activated Drain	ADA Joystick	*Brushed Nickel	
158431	K-6268-C11-CP	1-Hdl 8", Touch-Activated Drain	ADA Joystick	Polished Chrome	
224859	K-6268-C11-VS	1-Hdl 8", Touch-Activated Drain	ADA Joystick	*Stainless	
187801	K-6268-C12-VS	2-Hole, Less Side Spray	ADA Joystick Lever	*Stainless	

* Vibrant Limited Lifetime Finish

www.waterconcepts.net • Serving our Customers Since 1946 • www.plumbsupply.com

Bar Faucets

Purist® 1-Hdl Secondary Kitchen Faucet

- 6" Reach, 9-7/8" high, 360° swivel spout
- Metal construction
- One-piece, self-contained ceramic disc valve allows both volume and temperature control
- High-temperature limit setting
- Flow rate: 1.8 gpm



Part #	Mfg #	Description	Handle(s)	Finish	Price
144810	K-7509-BL	1-Hole, Less Side Spray	ADA Lever	Matte Black	
138740	K-7509-CP	1-Hole, Less Side Spray	ADA Lever	Polished Chrome	
140239	K-7509-VS	1-Hole, Less Side Spray	ADA Lever	*Stainless	
174406	K-7506-BL	1-Hole, Pull-Out Spray	ADA Lever	Matte Black	
134878	K-7506-CP	1-Hole, Pull-Out Spray	ADA Lever	Polished Chrome	
137619	K-7506-VS	1-Hole, Pull-Out Spray	ADA Lever	*Stainless	

Two-Handle Bar Faucets

Coralais® 2-Hdl Gooseneck Bar Faucet

- 4" Reach, 11-3/16" high spout
- Metal construction
- Washerless ceramic valving
- Aerator



K-15275

Part #	Mfg #	Description	Handle(s)	Finish	Price
053597	K-15275-CP	4"cc	Sculptured Acrylic	Polished Chrome	
081404	K-15275-4-CP	4"cc	ADA Levers	Polished Chrome	

Essex® 2-Hdl Bar Faucet

- 5-1/2" Reach, 14-1/4" high spout
- 10-1/16" From deck to aerator
- Brass construction
- Brass valve bodies
- Quarter-turn washerless ceramic disc valves
- Flow rate: 2.2 gpm



Part #	Mfg #	Description	Handle(s)	Finish	Price
100159	K-8761-VS	1-Hole, Less Side Spray	Wrist Blade Levers	*Stainless	

* Vibrant Limited Lifetime Finish

www.plumbsupply.com • Serving our Customers Since 1946 • www.waterconcepts.net

Bar Faucets

HiRise 2-Hdl Bar Faucet

- 7" Reach, 14-1/8" high swing spout
- Stainless steel construction
- Flow rate: 2.2 gpm



Faucets & Valves

Part #	Mfg #	Description	Handle(s)	Finish	Price
183145	K-7342-4-S	1-Hole, Less Side Spray	ADA Lever	Polished Stainless	
108815	K-7342-4-BS	1-Hole, Less Side Spray	ADA Lever	Brushed Stainless	

* Vibrant Limited Lifetime Finish

www.waterconcepts.net • Serving our Customers Since 1946 • www.plumbsupply.com

Bar Faucets

Single-Handle Bar Faucets

Addison™ 1-Hdl Pull-Down Spray Bar/Prep Faucet

- 6-25/64" Reach, 14-19/32" high spout swivels 360°
- 9-1/2" From deck to aerator
- 62" Long hose
- Touch-Clean® 2-function Multi-Flow™ spray head with MagnaTite® docking
- 3/8" Compression fittings
- 2-1/2" Maximum deck thickness
- 32" Minimum supply lines below deck included
- DIAMOND Seal® technology
- Water-efficient product: 1.5 gpm @ 60 psi



Faucets & Valves

Part #	Mfg #	Description	Handle(s)	Finish	Price
137945	9992-DST	1- or 3-Hole 8"cc, Pull-Down Spray, Lead-Free	ADA Lever	Chrome	
152922	9992-AR-DST	1- or 3-Hole 8"cc, Pull-Down Spray, Lead-Free	ADA Lever	Arctic Stainless®	
173741	9992-CZ-DST	1- or 3-Hole 8"cc, Pull-Down Spray, Lead-Free	ADA Lever	Champagne Bronze™	
135524	9992-RB-DST	1- or 3-Hole 8"cc, Pull-Down Spray, Lead-Free	ADA Lever	Venetian Bronze®	

Addison™ Touch2O 1-Hdl Pull-Down Spray Bar/Prep Faucet

- Touch2O® Technology controls water flow
- 6-25/64" Reach, 14-13/32" high spout swivels 360°
- 9-1/2" From deck to aerator
- Touch-Clean® two-function Multi-Flow™ spray head with MagnaTite® docking
- 62" Long hose
- 3/8" Compression fittings
- 2-1/2" Maximum deck thickness
- 32" Minimum supply lines below deck included
- DIAMOND Seal® technology
- Water-efficient product: 1.5 gpm @ 60 psi



Part #	Mfg #	Description	Handle(s)	Finish	Price
134744	9992T-DST	1- or 3-Hole 8"cc, Pull-Down Spray, Lead-Free	ADA Lever	Chrome	
152921	9992T-AR-DST	1- or 3-Hole 8"cc, Pull-Down Spray, Lead-Free	ADA Lever	Arctic Stainless®	
134745	9992T-RB-DST	1- or 3-Hole 8"cc, Pull-Down Spray, Lead-Free	ADA Lever	Venetian Bronze®	

* Brilliance® Anti-Tarnish Lifetime Finishes

www.plumbsupply.com • Serving our Customers Since 1946 • www.waterconcepts.net

Bar Faucets

Faucets & Valves

Allora® 1-Hdl Pull-Down Spray Bar/Prep Faucet

- 6-7/8" Reach, 14-1/2" high
- High-arc spout swivels 360°
- 8-5/16" From deck to aerator
- 62" Long hose
- MagnaTite® docking
- DIAMOND Seal® technology
- 3/8" Compression fittings
- 2-1/2" Maximum deck thickness
- 32" Minimum supply lines below deck included
- Water-efficient product: 1.8 gpm @ 60 psi



Part #	Mfg #	Description	Handle(s)	Finish	Price
116873	999-DST	1-Hole, Pull-Down Spray, Lead-Free	ADA Lever	Chrome	
150201	999-AR-DST	1-Hole, Pull-Down Spray, Lead-Free	ADA Lever	Arctic Stainless®	

Cassidy™ 1-Hdl Bar/Prep Faucet

- 5-7/8" Reach, 8-25/32" high 360° swivel spout
- 7-3/16" From deck to aerator
- 3/8" Staggered copper supply lines with 1/2" fittings
- 1-1/2" Maximum deck thickness
- Euro-Motion Valve
- Flow rate: 1.5 gpm @ 60 psi



Part #	Mfg #	Description	Handle(s)	Finish	Price
152833	1997LF	1-Hole, Lead Free	ADA Lever	Chrome	
152918	1997LF-AR	1-Hole, Lead Free	ADA Lever	Arctic Stainless®	
152919	1997LF-CZ	1-Hole, Lead Free	ADA Lever	Champagne Bronze™	
152460	1997LF-RB	L-Hole, Lead Free	ADA Lever	Venetian Bronze®	

Cassidy™ 1-Hdl Pull-Down Spray Bar/Prep Faucet

- 6-3/8" Reach, 14-1/2" high
- High-arc pull-down swivels 360°
- 9-5/32" From deck to aerator
- 62" Long hose
- 3/8" Compression fittings
- 2-1/2" Maximum deck thickness
- DIAMOND Seal® technology
- MagnaTite® docking
- Water-efficient product: 1.8 gpm @ 60 psi



Part #	Mfg #	Description	Handle(s)	Finish	Price
152827	9997-DST	1-Hole, Pull-Down Spray, Lead Free	ADA Lever	Chrome	
152831	9997-AR-DST	1-Hole, Pull-Down Spray, Lead Free	ADA Lever	Arctic Stainless®	
152832	9997-CZ-DST	1-Hole, Pull-Down Spray, Lead Free	ADA Lever	Champagne Bronze™	
152028	9997-RB-DST	1-Hole, Pull-Down Spray, Lead Free	ADA Lever	Venetian Bronze®	

* Brilliance® Anti-Tarnish Lifetime Finishes

www.waterconcepts.net • Serving our Customers Since 1946 • www.plumbsupply.com

Bar Faucets

Cassidy™ Touch2O 1-Hdl Pull-Down Spray Bar/Prep Faucet

- 6-3/8" Reach, 14-1/2" high
- High-arc pull-down swivels 360°
- 9-5/32" From deck to aerator
- 62" Long hose
- 3/8" Compression fittings
- 2-1/2" Maximum deck thickness
- DIAMOND Seal® technology
- MagnaTite® docking
- Water-efficient product: 1.8 gpm @ 60 psi
- Touch feature to activate on/off



Part #	Mfg #	Description	Handle(s)	Finish	Price
152818	9997T-DST	1-Hole, Pull-Down Spray, Lead Free Touch2O	ADA Lever	Chrome	
152819	9997T-AR-DST	1-Hole, Pull-Down Spray, Lead Free Touch2O	ADA Lever	Arctic Stainless®	
152821	9997T-CZ-DST	1-Hole, Pull-Down Spray, Lead Free Touch2O	ADA Lever	Champagne Bronze™	
152822	9997T-RB-DST	1-Hole, Pull-Down Spray, Lead Free Touch2O	ADA Lever	Venetian Bronze®	

Classic® 1-Hdl Bar/Prep Faucet

- 5" Reach, 10" high spout swivels 180°
- 6" From deck to aerator
- 3/8" Compression fittings
- 2-1/2" Maximum deck thickness
- 32" Minimum supply lines below deck included
- DIAMOND Seal® technology
- Water-efficient product: 1.5 gpm @ 60 psi



Part #	Mfg #	Description	Handle(s)	Finish	Price
127174	1903-DST	2-Hole, Lead-Free	ADA Lever	Chrome	
127175	1903-RB-DST	2-Hole, Lead-Free	ADA Lever	Venetian Bronze®	
127176	1903-SS-DST	2-Hole, Lead-Free	ADA Lever	Stainless*	

Contemporary 1-Hdl Bar/Prep Faucet

- 5-1/16" Reach, 11-5/16" high 360° swivel spout
- 7-1/4" From deck to aerator
- 1-1/2" Maximum deck thickness
- 3/8" Staggered copper supply lines with 1/2" fittings
- DIAMOND Seal® technology
- Flow rate: 1.5 gpm @ 60 psi



Part #	Mfg #	Description	Handle(s)	Finish	Price
172799	1959LF	1-Hole, Lead Free	ADA Lever	Chrome	
171466	1959LF-AR	1-Hole, Lead Free	ADA Lever	Arctic Stainless®	
173908	1959LF-BL	1-Hole, Lead Free	ADA Lever	Matte Black	
186905	1959LF-CZ	1-Hole, Lead Free	ADA Lever	Champagne Bronze™	

* Brilliance® Anti-Tarnish Lifetime Finishes

www.plumbsupply.com • Serving our Customers Since 1946 • www.waterconcepts.net

Bar Faucets

Faucets & Valves

Essa™ 1-Hdl Pull-Down Spray Bar/Prep Faucet

- 6-5/8" Reach, 14-1/2" high 360° swivel spout
- 9-5/32" From deck to aerator
- 3/8" O.D. straight, staggered pex supply lines
- DIAMOND Seal® technology
- MagnaTite® magnetic docking
- Touch-Clean® sprayhead
- 1-1/2" Minimum clearance to back splash
- Flow rate: 1.8 gpm @ 60 psi



Part #	Mfg #	Description	Handle(s)	Finish	Price
182660	9913-DST	1-Hole, Lead Free	ADA Lever	Chrome	
221462	9913-BL-DST	1-Hole, Lead Free	ADA Lever	Matte Black	
181638	9913-AR-DST	1-Hole, Lead Free	ADA Lever	Arctic Stainless®	
177302	9913-RB-DST	1-Hole, Lead Free	ADA Lever	Venetian Bronze®	

Touch2O® Essa® 1-Hdl Pull-Down Bar/Prep Faucet

- 9-3/8" Reach, 16" high 360° swivel spout
- 9-21/32" From deck to aerator
- 3/8" O.D. straight, staggered pex supply lines
- DIAMOND Seal® technology
- MagnaTite® magnetic docking
- LED indicator light signals on-off, water temperature and when batteries run low
- Uses 6 (AA) or 6 (C) batteries
- Optional 120V AC adapter available



Part #	Mfg #	Description	Handle(s)	Finish	Price
228092	9913T-DST	1-Hole, Lead Free Touch2O	ADA Lever	Chrome	
185893	9913T-AR-DST	1-Hole, Lead Free Touch2O	ADA Lever	Arctic Stainless®	
185309	9913T-BL-DST	1-Hole, Lead Free Touch2O	ADA Lever	Matte Black	
187515	9913T-RB-DST	1-Hole, Lead Free Touch2O	ADA Lever	Venetian Bronze®	

Leland® 1-Hdl Pull-Down Spray Bar/Prep Faucet

- 6-11/16" Reach, 14" high, high-arc spout swivels 360°
- 7-7/16" From deck to aerator
- 62" Long hose
- Touch-Clean® 2-function spray
- MagnaTite® magnetic docking
- DIAMOND Seal® technology
- 62" Long hose
- 3/8" Compression fittings
- 2-1/2" Maximum deck thickness
- 32" Minimum supply lines below deck included
- Water-efficient product: 1.8 gpm @ 60 psi



Part #	Mfg #	Description	Handle(s)	Finish	Price
116054	9978-DST	2-Hole, Pull-Down Spray, Lead-Free	ADA Lever	Chrome	

* Brilliance® Anti-Tarnish Lifetime Finishes

www.waterconcepts.net • Serving our Customers Since 1946 • www.plumbsupply.com

Bar Faucets

Single-Handle Bar Faucets (Continued) Leland® 1-Hdl Pull-Down Spray Bar/Prep Faucet

Part #	Mfg #	Description	Handle(s)	Finish	Price
157589	9978-AR-DST	2-Hole, Pull-Down Spray, Lead-Free	ADA Lever	Arctic Stainless®	
116052	9978-RB-DST	2-Hole, Pull-Down Spray, Lead-Free	ADA Lever	Venetian Bronze®	

Leland® 1-Hdl Pull-Down Spray Bar/Prep Faucet

- 6-11/16" Reach, 14" high 360° swivel spout
- 7-7/16" From deck to aerator
- 62" Long hose
- 3/8" Compression fittings
- 2-1/2" Maximum deck thickness
- 32" Minimum InnoFlex® supply lines
- DIAMOND Seal® technology
- MagnaTite® docking
- WaterSense® certified product: 1.8 gpm @ 60 psi



Part #	Mfg #	Description	Handle(s)	Finish	Price
168155	9678-DST	1-Hole, Pull-Down Spray	ADA Lever	Chrome	
173070	9678-AR-DST	1-Hole, Pull-Down Spray	ADA Lever	Arctic Stainless®	
168154	9678-RB-DST	1-Hole, Pull-Down Spray	ADA Lever	Venetian Bronze®	
178230	9678T-AR-DST	1-Hole, Pull-Down Spray, Touch2O	ADA Lever	Arctic Stainless®	
173330	9678T-RB-DST	1-Hole, Pull-Down Spray, Touch2O	ADA Lever	Venetian Bronze®	

Mateo™ 1-Hdl Pull-Down Spray Bar/Prep Fct

- 9-1/4" Reach, 15-1/2" high spout
- 8-5/8" From deck to aerator
- 3/8" Compression fittings
- DIAMOND Seal® technology
- MagnaTite® docking
- WaterSense® certified product: 1.8 gpm @ 60 psi



Part #	Mfg #	Description	Handle(s)	Finish	Price
224178	9983-DST	1-Hole, Pull-Down Spray	ADA Lever	Chrome	
188940	9983-AR-DST	1-Hole, Pull-Down Spray	ADA Lever	Arctic Stainless®	
188221	9983-RB-DST	1-Hole, Pull-Down Spray	ADA Lever	Venetian Bronze®	

* Brilliance® Anti-Tarnish Lifetime Finishes

www.plumbsupply.com • Serving our Customers Since 1946 • www.waterconcepts.net

Bar Faucets

Faucets & Valves

Mateo™ 1-Hdl Pull-Down Spray Bar/Prep Fct w/ Touch2O

- 9-1/4" Reach, 16" high spout
- 9-1/8" From deck to aerator
- 3/8" Compression fittings
- Diamond coated ceramic cartridge
- LED indicator light signals on-off, water temperature and when batteries run low
- Uses 6AA (included) or 6 C (optional) batteries
- Optional (EP73954) 120V AC adapter available (3 prong grounded outlet required)



Part #	Mfg #	Description	Handle(s)	Finish	Price
187812	9983T-AR-DST	1-Hole, Pull-Down Spray, Touch2O	ADA Lever	Arctic Stainless®	

Pilar® 1-Hdl Bar/Prep Faucet

- 6-5/8" Reach, 9-1/2" high, high-arc spout swivels 180°
- 7" From deck to aerator
- 3/8" Compression fittings
- 2-1/2" Maximum deck thickness
- 32" Minimum supply lines below deck included
- DIAMOND Seal® technology
- Water-efficient product: 1.5 gpm @ 60 psi



Part #	Mfg #	Description	Handle(s)	Finish	Price
126691	1980-DST	2-Hole, Lead-Free	ADA Lever	Chrome	
134751	1980-AR-DST	2-Hole, Lead-Free	ADA Lever	Arctic Stainless®	
126184	1980-RB-DST	2-Hole, Lead-Free	ADA Lever	Venetian Bronze®	
125493	1980-SS-DST	2-Hole, Lead-Free	ADA Lever	Stainless*	

Pilar® Electronic 1-Hdl Bar/Prep Faucet

- Touch2O® Technology controls water flow
- 6-5/8" Reach, 9-1/2" high, high-arc spout swivels 180°
- 6-59/64" From deck to aerator
- 3/8" Compression fittings
- 2-1/2" Maximum deck thickness
- 32" Minimum supply lines below deck included
- DIAMOND Seal® technology
- Water-efficient product: 1.5 gpm @ 60 psi



Part #	Mfg #	Description	Handle(s)	Finish	Price
134736	1980T-DST	2-Hole, Lead-Free	ADA Lever	Chrome	
134733	1980T-AR-DST	2-Hole, Lead-Free	ADA Lever	Arctic Stainless®	

* Brilliance® Anti-Tarnish Lifetime Finishes

Bar Faucets

Traditional 1-Hdl Bar/Prep Faucet

- 4-7/8" Reach, 11-7/8" high 360° swivel spout
- 7-7/8" From deck to aerator
- 1-1/2" Maximum deck thickness
- 3/8" Staggered copper supply lines with 1/2" fittings
- DIAMOND Seal® technology
- Flow rate: 1.5 gpm @ 60 psi



Part #	Mfg #	Description	Handle(s)	Finish	Price
171969	1953LF	1-Hole, Lead Free	ADA Lever	Chrome	
172793	1953LF-AR	1-Hole, Lead Free	ADA Lever	Arctic Stainless®	
171215	1953LF-RB	1-Hole, Lead Free	ADA Lever	Venetian Bronze®	

Trinsic® 1-Hdl Pull-Down Spray Bar/Prep Faucet

- 6-1/2" Reach, 13" high, high-arc spout swivels 360°
- 8-7/16" From deck to aerator
- Touch-Clean® two-function spray
- MagnaTite® magnetic docking
- DIAMOND Seal® technology
- 62" Long hose
- 3/8" Compression fittings
- 2-1/2" Maximum deck thickness
- 32" Minimum supply lines below deck included
- Water-efficient product: 1.8 gpm @ 60 psi



Part #	Mfg #	Description	Handle(s)	Finish	Price
145280	9959-DST	1- or 3-Hole, Lead-Free	ADA Lever	Chrome	
141854	9959-AR-DST	1- or 3-Hole, Lead-Free	ADA Lever	Arctic Stainless®	
183769	9959-BL-DST	1- or 3-Hole, Lead-Free	ADA Lever	Matte Black	
144863	9959-CZ-DST	1- or 3-Hole, Lead-Free	ADA Lever	Champagne Bronze™	

Touch2O® Trinsic® 1-Hdl Pull-Down Bar/Prep Faucet

- 6-1/2" Reach, 13" high, high-arc spout swivels 360°
- 8-7/16" From deck to aerator
- Touch2O® on/off functionality
- Touch-Clean® two-function spray head
- MagnaTite® magnetic docking
- DIAMOND Seal® technology
- 62" Long hose
- 3/8" Compression fittings
- Water-efficient product: 1.8 gpm @ 60 psi



Part #	Mfg #	Description	Handle(s)	Finish	Price
147922	9959T-AR-DST	1-Hole, Lead-Free	ADA Lever	Arctic Stainless®	
147797	9959T-CZ-DST	1-Hole, Lead-Free	ADA Lever	Champagne Bronze™	

* Brilliance® Anti-Tarnish Lifetime Finishes

www.plumbsupply.com • Serving our Customers Since 1946 • www.waterconcepts.net

Bar Faucets

Faucets & Valves

Victorian® 1-Hdl Pull-Down Spray Bar/Prep Faucet

- 6-5/8" Reach, 14" high, high-arc pull-down spout swivels 360°
- 7-5/8" From deck to aerator
- 62" Long hose
- Touch-Clean® two-function spray head
- MagnaTite® magnetic docking
- DIAMOND Seal® technology
- 3/8" Compression fittings
- 2-1/2" Maximum deck thickness
- 32" Minimum supply lines below deck included
- Water-efficient product: 1.8 gpm @ 60 psi



Part #	Mfg #	Description	Handle(s)	Finish	Price
116773	9955-RB-DST	2-Hole, Pull-Down Spray, Lead-Free	ADA Lever	Venetian Bronze®	
116872	9955-SS-DST	2-Hole, Pull-Down Spray, Lead-Free	ADA Lever	Stainless*	

Two-Handle Bar Faucets

Classic 2-Hdl Bar Faucet with 10-3/4" High Spout

- 4-1/16" Reach, 10-13/32" high spout swivels 360°
- 7-19/32" From deck to aerator
- 1/2" IPS connection
- 1" Maximum deck thickness
- Water-efficient product: 1.5 gpm @ 60 psi



Part #	Mfg #	Description	Handle(s)	Finish	Price
139312	2170LF	4"cc, 10-3/4" GN Spout, Lead-Free	Clear Knob	Chrome	
138337	2171LF	4"cc, 10-3/4" GN Spout, Lead-Free	ADA Blade	Chrome	
146556	2171LF-WBHDF	2- or 3-Hole 4"cc, 10-3/4" GN Spout, Lead-Free	ADA Blade	Chrome	
164856	2179LF	2- or 3-Hole 4"cc 360° Swivel Spout	ADA Blade	Chrome	

Classic 2-hdl Bar Faucet with 11" High Spout

- 4-1/8" Reach, 11" high spout swivels 360°
- 7-11/16" From deck to aerator
- 1/4 Turn handle stops
- 1/2" - 14 NPSM threaded male inlet shanks
- Water-efficient product: 1.5 gpm @ 60 psi

-LHP Less Handle Package, Handles sold separately



Part #	Mfg #	Description	Handle(s)	Finish	Price
003838	2172LF-LHP	2- or 3-Hole, 4"cc 11" Swivel Spout	Less Handles	Chrome	

* Brilliance® Anti-Tarnish Lifetime Finishes

www.waterconcepts.net • Serving our Customers Since 1946 • www.plumbsupply.com

Bar Faucets

Foundations Core-B 2-Handle Bar Prep Faucet

- Solid brass fabricated body
- 2-Handle deck-mount
- 5" Long, 11" high spout, swings 360°
- 1/4-Turn handle stops
- Washerless stem cartridge
- 1/2"-14 NPSM Threaded male inlet shanks
- 1.5 gpm @ 60 psi



Part #	Mfg #	Description	Handle(s)	Finish	Price
136058	B28910LF	2 or 3-Hole 4"cc, Lead-Free	ADA Lever	Chrome	

Victorian 2-Hdl Bar/Prep Faucet

- 5-1/8" Reach, 8-3/4" high 360° swivel spout
- 6-1/2" From deck to aerator
- 3/8" Compression fittings
- 2-1/4" Maximum deck thickness
- DIAMOND Seal® technology
- 1.5 gpm @ 60 psi



Part #	Mfg #	Description	Handle(s)	Finish	Price
157682	2155-RB-DST	2 or 3-Hole 4"cc, Lead Free	ADA Lever	Venetian Bronze®	
151671	2155-SS-DST	2 or 3-Hole 4"cc, Lead Free	ADA Lever	Stainless*	

Commercial Bar/Prep Faucets

Commercial DIAMOND™ Seal 1-Hdl Bar/Prep Faucet

- 5" Reach, 10" high spout
- Vandal-resistant handles
- Adjustable handle limit stop
- 3/8" Compression fittings
- DIAMOND Seal® technology
- 1.5 gpm @ 60 psi



Part #	Mfg #	Description	Handle(s)	Finish	Price
004113	710LF-HDF	2-Hole, Rigid Spout, Lead-Free	ADA Lever	Chrome	

Commercial 2-Hdl Deck-Mount Bar Faucet

- Cast brass body
- Hot/cold handle indicators
- 4-1/2" Reach, 12" high rigid/swing spout
- 1.5 gpm Aerator
- 1/2" IPS Shanks



Part #	Mfg #	Description	Handle(s)	Finish	Price
128150	27C4832	4"cc VR Aerator, CER-TECK® Cartridge	ADA Hooded Blade	Chrome	
132868	27C4845	4"cc Flow Control Aerator, CER-TECK® Cartridge	ADA Wrist Blade	Chrome	

* Brilliance® Anti-Tarnish Lifetime Finishes

www.plumbsupply.com • Serving our Customers Since 1946 • www.waterconcepts.net

Bar Faucets

Beverage Faucets

Traditional Beverage Faucet

- Cold water only
- Compatible with reverse osmosis systems
- 5" Reach, 8" high, high-arc spout swivels 360°
- 6-7/8" From deck to aerator
- 3/8" Compression fittings
- 2-1/2" Maximum deck thickness
- 32" Minimum supply lines below the deck included
- DIAMOND Seal® technology
- 1.5 gpm @ 60 psi



Touch

Part #	Mfg #	Description	Handle(s)	Finish	Price
143984	1914-DST	1-Hole, Lead-Free	ADA Lever	Chrome	
145842	1914-AR-DST	1-Hole, Lead-Free	ADA Lever	Arctic Stainless®	
154428	1914-CZ-DST	1-Hole, Lead-Free	ADA Lever	Champagne Bronze™	
143305	1914-RB-DST	1-Hole, Lead-Free	ADA Lever	Venetian Bronze®	
143467	1914-SS-DST	1-Hole, Lead-Free	ADA Lever	Stainless*	
169386	1914T-AR	1-Hole, Lead-Free	Touch Activated	Arctic Stainless®	
189397	1914T-RB	1-Hole, Lead-Free	Touch Activated	Venetian Bronze®	
167295	1914T-SS	1-Hole, Lead-Free	Touch Activated	Stainless*	

Transitional Beverage Faucet

- Cold water only
- Compatible with reverse osmosis systems
- 5" Reach, 7-53/64" high, spout swivels 360°
- 6-7/8" From deck to aerator
- 3/8" Compression fittings
- 2-1/2" Maximum deck thickness
- DIAMOND Seal® technology
- Water-efficient product: 1.5 gpm @ 60 psi



Touch

Part #	Mfg #	Description	Handle(s)	Finish	Price
144735	1977-DST	1-Hole, Lead-Free	ADA Lever	Chrome	
144004	1977-AR-DST	1-Hole, Lead-Free	ADA Lever	Arctic Stainless®	
144864	1977-CZ-DST	1-Hole, Lead-Free	ADA Lever	Champagne Bronze™	
146235	1977-RB-DST	1-Hole, Lead-Free	ADA Lever	Venetian Bronze®	
144736	1977-SS-DST	1-Hole, Lead-Free	ADA Lever	Stainless*	
168523	1977T	1-Hole, Lead-Free	Touch Activated	Chrome	
169406	1977T-AR	1-Hole, Lead-Free	Touch Activated	Arctic Stainless®	
177443	1977T-RB	1-Hole, Lead-Free	Touch Activated	Venetian Bronze®	

* Brilliance® Anti-Tarnish Lifetime Finishes

www.waterconcepts.net • Serving our Customers Since 1946 • www.plumbsupply.com

Bar Faucets

Single-Handle Bar Faucets

Artesso™ 1-Hdl Bar Faucet

- 6-1/32" Reach, 13-9/64" high, 360° swing spout
- 9-1/16" From deck to aerator
- Ceramic cartridge
- 2-1/2" Maximum deck thickness
- Maximum flow: 1.80 gpm @ 60 psi



Part #	Mfg #	Description	Handle(s)	Finish	Price
182916	61025LF-PC	1-Hole, Less Side Spray	ADA Lever	Polished Chrome	
178323	61025LF-PN	1-Hole, Less Side Spray	ADA Lever	Polished Nickel*	
175925	61025LF-RB	1-Hole, Less Side Spray	ADA Lever	Venetian Bronze®	
176300	61025LF-SS	1-Hole, Less Side Spray	ADA Lever	Stainless*	

Talo® 1-Hdl Pull-Down Bar Faucet

- 6-19/64" Reach, 14-7/8" high, 360° swing spout
- 8-15/16" From deck to aerator
- DIAMOND™ seal technology
- Euro-motion Diamond™ valve with InnoFlex® waterways
- Touch-Clean® nozzles
- MagneDock® technology
- 2-function pull-down wand: spray and stream
- Accommodates up to 3" deck thickness
- Maximum flow: 1.8 gpm @ 60 psi



Part #	Mfg #	Description	Handle(s)	Finish	Price
134884	63903LF-BZ	1-Hole, Pull-Down Spray	ADA Lever	Brushed Bronze*	
168126	63903LF-PN	1-Hole, Pull-Down Spray	ADA Lever	Polished Nickel*	
134076	63903LF-RB	1-Hole, Pull-Down Spray	ADA Lever	Venetian Bronze®	
131851	63903LF-SS	1-Hole, Pull-Down Spray	ADA Lever	Stainless*	

Talo® 1-Hdl Pull-Down Bar/Prep Faucet With SmartTouch® Technology

- 6-19/64" Reach, 14-7/8" high, 360° swing spout
- 8-15/16" From deck to aerator
- SmartTouch® technology with TempID™
- MagneDock® technology
- DIAMOND™ seal technology
- Euro-motion Diamond™ valve with InnoFlex® waterways
- Touch-Clean® nozzles
- Two function pull-down wand: spray and stream
- Accommodates up to 3" deck thickness
- Maximum flow: 1.8 gpm @ 60 psi



Part #	Mfg #	Description	Handle(s)	Finish	Price
186831	64903LF-PN	1-Hole, Pull-Down Spray w/ SmartTouch®	ADA Lever	Polished Nickel*	

* Brilliance® Anti-Tarnish Lifetime Finishes

www.plumbsupply.com • Serving our Customers Since 1946 • www.waterconcepts.net

Bar Faucets

Single-Handle Bar Faucets (Continued)

Talo® 1-Hdl Pull-Down Bar/Prep Faucet With SmartTouch® Technology

Part #	Mfg #	Description	Handle(s)	Finish	Price
145310	64903LF-RB	1-Hole, Pull-Down Spray w/ SmartTouch®	ADA Lever	Venetian Bronze®	

Solna™ 1-Hdl Pull-Down Bar Faucet

- 12-7/16" Reach, 7-1/16" high, 360° swing spout
- 7-1/16" From deck to aerator
- MagneDock® technology
- DIAMOND™ seal technology
- Euro-motion Diamond™ valve with InnoFlex® waterways
- 2-function wand: spray and stream
- Hidden pull-down spray
- Accommodates up to 3" deck thickness
- Maximum flow: 1.80 gpm @ 60 psi



Part #	Mfg #	Description	Handle(s)	Finish	Price
155649	63920LF-BL	1-Hole, Pull-Down Spray Head	ADA Lever	Matte Black	
154641	63920LF-PC	1-Hole, Pull-Down Spray Head	ADA Lever	Polished Chrome	
139264	63920LF-SS	1-Hole, Pull-Down Spray Head	ADA Lever	Stainless*	
162503	64920LF-SS	1-Hole, PD Spray w/SmartTouch® & 13-5/16" Reach	ADA Lever	Stainless*	

Belo™ 1-Hdl Pull-Down Bar Faucet

- 6-1/2" Reach, 13-1/2" high, 360° swing spout
- 8-1/4" From deck to aerator
- Touch-Clean® nozzles
- MagneDock® technology
- DIAMOND™ seal technology
- 2-function pull-down wand: spray and stream
- Accommodates up to 3" deck thickness
- Maximum flow: 1.8 gpm @ 60 psi



Part #	Mfg #	Description	Handle(s)	Finish	Price
164834	63952LF-PC	1-Hole, Pull-Down Spray	ADA Lever	Polished Chrome	
133484	63952LF-SS	1-Hole, Pull-Down Spray	ADA Lever	Stainless*	

* Brilliance® Anti-Tarnish Lifetime Finishes

www.waterconcepts.net • Serving our Customers Since 1946 • www.plumbsupply.com

Bar Faucets

Venuto® 1-Hdl Pull-Down Bar Faucet

- 6-1/2" Reach, 14-1/2" high spout
- 8-3/4" From deck to aerator
- DIAMOND™ seal technology
- Euro-motion Diamond™ valve with InnoFlex® waterways
- Touch-clean® nozzles
- MagneDock® technology
- 2-function pull-down wand: spray and stream
- Mounts to 3" deck thickness
- Maximum flow: 1.80 gpm @ 60 psi



Part #	Mfg #	Description	Handle(s)	Finish	Price
175078	63970LF-BLST	1-Hole, Pull-Down Spray	ADA Lever	Matte Black/Soft Touch®	
131557	63970LF-SS	1-Hole, Pull-Down Spray	ADA Lever	Stainless*	

Vuelo® 1-Hdl Pull-Down Bar Faucet

- 7-1/8" Reach, 15" high, 360° swing spout
- DIAMOND™ seal technology
- MagneDock® technology
- 2-function wand: spray and stream
- Accommodates up to 3" deck thickness
- Maximum flow: 1.80 gpm @ 60 psi



Part #	Mfg #	Description	Handle(s)	Finish	Price
150874	63955LF-SS	1-Hole, Pull-Down Spray	ADA Lever	Stainless*	

Vuelo™ 1-Hdl Pull Down Prep With SmartTouch®

- 7-1/8" Reach, 15-1/2" high, 360° swing spout
- SmartTouch® technology with TempID™
- DIAMOND™ seal technology
- Two-function wand: spray and stream
- MagneDock® magnetic docking
- Accommodates up to 3" deck thickness
- 1.80 gpm @ 60 psi



Part #	Mfg #	Description	Handle(s)	Finish	Price
185274	64955LF-SSCO	1-Hole, Pull-Down Spray	ADA Lever	Stainless Steel/Cocoa Brz™	

* Brilliance® Anti-Tarnish Lifetime Finishes

www.plumbsupply.com • Serving our Customers Since 1946 • www.waterconcepts.net

Bar Faucets

Two-Handle Bar Faucets

Tresa® 2-Hdl Bar Faucet

- 6-3/8" Reach, 11-1/2" high spout
- 8-3/16" From deck to aerator
- Solid brass faucet body
- Ceramic cartridges
- Accommodates up to 3" deck thickness
- Maximum flow: 1.8 gpm @ 60 psi



Part #	Mfg #	Description	Handle(s)	Finish	Price
175926	62936LF-PC	1-Hole, Single function spray	ADA Lever	Polished Chrome	
170006	62936LF-PN	1-Hole, Single function spray	ADA Lever	Polished Nickel*	
138291	62936LF-RB	1-Hole, Single function spray	ADA Lever	Venetian Bronze®	
136999	62936LF-SS	1-Hole, Single function spray	ADA Lever	Stainless*	

Beverage Faucets

Traditional 1-Hdl Beverage Faucet

- 5" Reach, 9-7/64" high, 360° swing spout
- 6-51/64" From deck to aerator
- DIAMOND™ seal technology
- Air gap included
- Works with RO systems, filtered water systems or as a cold water tap
- Mounts to 4" deck thickness (-2-3/4" with air gap)
- Integrated supply tubes
- Maximum flow: 1.50 gpm @ 60 psi



Part #	Mfg #	Description	Handle(s)	Finish	Price
148274	61310LF-BZ	1-Hole, Single function spray	ADA Lever	Brushed Bronze*	
166055	61310LF-PC	1-Hole, Single function spray	ADA Lever	Polished Chrome	
148651	61310LF-RB	1-Hole, Single function spray	ADA Lever	Venetian Bronze®	
153514	61310LF-SS	1-Hole, Single function spray	ADA Lever	Stainless*	

* Brilliance® Anti-Tarnish Lifetime Finishes

www.waterconcepts.net • Serving our Customers Since 1946 • www.plumbsupply.com

Bar Faucets

Euro 1-Hdl Beverage Faucet

- 5" Reach, 9-1/3" high, 360° swing spout
- 6-51/64" From deck to aerator
- DIAMOND™ seal technology
- Air gap included
- Works with RO systems, filtered water systems or as a cold water tap
- Mounts to 4" deck thickness (2-3/4" with air gap)
- Integrated supply tubes
- Maximum flow: 1.50 gpm @ 60 psi



Part #	Mfg #	Description	Handle(s)	Finish	Price
170375	61320LF-PC	1-Hole, Single function spray	ADA Lever	Polished Chrome	
154450	61320LF-SS	1-Hole, Single function spray	ADA Lever	Stainless*	

* Brilliance® Anti-Tarnish Lifetime Finishes

www.plumbsupply.com • Serving our Customers Since 1946 • www.waterconcepts.net

Bar Faucets

One-Handle Bar Faucets

Align™ 1-Hdl Bar Faucet

- 6-3/4" Reach, 13-3/4" high 360° swivel spout
- 6-7/8" From deck to aerator
- 3/8" Compression connections
- Stream or spray mode
- 1255™ Duralast™ cartridge
- Reflex™ pull-down system with 68" braided hose
- 2-1/2" Maximum deck thickness
- Flow rate: 1.5 gpm



Part #	Mfg #	Description	Handle(s)	Finish	Price
168241	5965	1-Hole, Pull-Down Spray	ADA Lever	Chrome	
165260	5965SRS	1-Hole, Pull-Down Spray	ADA Lever	Spot Resist Stainless	

Arbor™ 1-Hdl Pull-Down Spray Bar Faucet

- 6-9/16" Reach, 14-3/8" spout height
- 3/8" Compression connections
- Hydrolock® quick connect installation
- Stream or spray mode
- Pullout spray with 68" braided hose
- Flow rate: 1.5 gpm



Part #	Mfg #	Description	Handle(s)	Finish	Price
155965	5995	1- or 3-Hole, Pull-Down Spray	ADA Lever	Chrome	
160817	5995BL	1- or 3-Hole, Pull-Down Spray	ADA Lever	Matte Black	
136632	5995ORB	1- or 3-Hole, Pull-Down Spray	ADA Lever	Oil Rubbed Bronze	
168034	5995SRS	1- or 3-Hole, Pull-Down Spray	ADA Lever	Spot Resist Stainless	

Brantford™ 1-Hdl Pull-Down Spray Bar Faucet

- 6-9/16" Reach, 14-3/8" high 360° swivel spout
- 8-3/8" From deck to aerator
- 3/8" Compression connections
- Stream or spray mode
- 1255™ Duralast™ cartridge
- Reflex™ pull-down system with 68" braided hose
- 2-1/2" Maximum deck thickness
- Flow rate: 1.5 gpm



Part #	Mfg #	Description	Handle(s)	Finish	Price
171142	5985	1- or 3-Hole, Pull-Down Spray	ADA Lever	Chrome	
144725	5985ORB	1- or 3-Hole, Pull-Down Spray	ADA Lever	Oil Rubbed Bronze	
162357	5985SRS	1- or 3-Hole, Pull-Down Spray	ADA Lever	Spot Resist Stainless	

* Lifeshine® Anti-Tarnish Lifetime Finish

www.waterconcepts.net • Serving our Customers Since 1946 • www.plumbsupply.com

Bar Faucets

Camerist™ 1-Hdl Bar Faucet

- 5-1/4" Spout reach, 11" high spout
- 7-1/2" From deck to aerator
- 3/8" Compression fittings
- 1255™ Duralast™ cartridge
- 2-1/2" Maximum deck thickness
- Flow rate: 1.5 gpm



Part #	Mfg #	Description	Handle(s)	Finish	Price
083855	4905	2-Hole, Less Side Spray	ADA Lever	Chrome	
115146	4905ORB	2-Hole, Less Side Spray	ADA Lever	Oil Rubbed Bronze	
173695	4905SRS	2-Hole, Less Side Spray	ADA Lever	Spot Resist Stainless	

Etch 1-Hdl Pull-Down Spray Bar Faucet

- 6-1/2" Reach, 15-1/2" high, 360° swivel spout
- 9-1/2" From deck to aerator
- 3/8" Compression connections
- Stream or spray mode
- 1255™ Duralast™ cartridge
- Reflex™ pull-down system with 68" braided hose
- 3-1/2" Maximum deck thickness
- Flow rate: 1.5 gpm



Part #	Mfg #	Description	Handle(s)	Finish	Price
189230	S62608	1-Hole, Pull-Down Spray	ADA Lever	Chrome	
175001	S62608SRS	1-Hole, Pull-Down Spray	ADA Lever	Spot Resist Stainless	

Notch™ 1-Hdl Pull-Down Spray Bar Faucet

- 6-1/16" Reach, 14-1/2" high 360° swivel spout
- 9" From deck to aerator
- 3/8" Compression fittings
- Reflex™ pull-down system offers smooth operation, easy movement and secure docking
- 68" Braided hose
- 1255™ Duralast™ cartridge
- Flow rate: 1.5 gpm



Part #	Mfg #	Description	Handle(s)	Finish	Price
187635	6124SRS	1-Hole, Pull-Down Spray	ADA Lever	Spot Resist Stainless	

* Lifeshine® Anti-Tarnish Lifetime Finish

www.plumbsupply.com • Serving our Customers Since 1946 • www.waterconcepts.net

Bar Faucets

Faucets & Valves

STo 1-Hdl Pull-Down Spray Bar Faucet

- 7" Reach, 14-5/8" high 360° swivel spout
- 7-7/8" From deck to aerator
- 3/8" Compression connections
- 1255™ Duralast™ cartridge
- Reflex™ pulldown system with 68" braided hose
- 2-1/2" Maximum deck thickness
- Flow rate: 1.5 gpm



Part #	Mfg #	Description	Handle(s)	Finish	Price
163254	S62308	1-Hole, Pull-Down Spray	ADA Lever	Chrome	
162501	S62308BL	1-Hole, Pull-Down Spray	ADA Lever	Matte Black	
168491	S62308SRS	1-Hole, Pull-Down Spray	ADA Lever	Spot Resist Stainless	

Woodmere® 1-Hdl Pull-Down Spray Bar Faucet

- 6-3/4" Reach, 13-1/4" spout height
- 7-7/16" From deck to aerator
- 3/8" Compression connections
- 1255™ Duralast™ cartridge
- Reflex™ pulldown system with 68" braided hose
- 2-1/2" Maximum deck thickness
- Flow rate: 1.5 gpm



Part #	Mfg #	Description	Handle(s)	Finish	Price
223186	6615SRS	1-Hole, Pull-Down Spray	ADA Lever	Spot Resist Stainless	

Two-Handle Bar Faucets

Chateau™ 2-Hdl Bar Faucet

- 4-9/16" Reach, 10-1/2" high spout
- 7-1/8" From deck to aerator
- 3/8" Ball nose connections
- 1" Maximum deck thickness
- Flow rate: 1.5 gpm



Part #	Mfg #	Description	Handle(s)	Finish	Price
055066	4903	2-Hole, Less Side Spray	ADA Blade	Chrome	

* Lifeshine® Anti-Tarnish Lifetime Finish

www.waterconcepts.net • Serving our Customers Since 1946 • www.plumbsupply.com

Bar Faucets

Beverage Faucets

Sip Modern 1-Hdl Beverage Faucet

- Cold water only
- 11" High spout
- 8-13/16" From deck to aerator
- 3/8" Compression inlet connection
- 1234 Duralast™ cartridge
- WaterSense® certified: 1.5 gpm



Part #	Mfg #	Description	Handle(s)	Finish	Price
167280	S5530SRS	1-Hole, Cold Water Only	ADA Lever	Spot Resist Stainless	

Sip Traditional 1-Hdl Beverage Faucet

- Cold water only
- 4-9/16" Reach, 11" high spout
- 8-3/4" From deck to aerator
- 3/8" Compression fittings
- 1234 Duralast™ cartridge
- WaterSense® certified: 1.5 gpm



Part #	Mfg #	Description	Handle(s)	Finish	Price
184852	S5510ORB	1-Hole, Cold Water Only	ADA Lever	Oil Rubbed Bronze	

Sip Transitional 1-Hdl Beverage Faucet

- Cold water only
- 5" Reach, 11" high spout
- 8-9/16" From deck to aerator
- 3/8" Compression fittings
- 1234 Duralast™ cartridge
- WaterSense® certified: 1.5 gpm



Part #	Mfg #	Description	Handle(s)	Finish	Price
173397	S5520	1-Hole, Cold Water Only	ADA Lever	Chrome	
215563	S5520ORB	1-Hole, Cold Water Only	ADA Lever	Oil Rubbed Bronze	
170254	S5520SRS	1-Hole, Cold Water Only	ADA Lever	Spot Resist Stainless	

* Lifeshine® Anti-Tarnish Lifetime Finish

www.plumbsupply.com • Serving our Customers Since 1946 • www.waterconcepts.net

Bar Faucets

Sip Filtration System

- For S5510, S5520 and S5530 Sip Beverage Faucets



Part#	Mfg#	Description	Price
173396	S5500	0.7 gpm, Undercount Dry Change System	

Faucets & Valves

* Lifeshine® Anti-Tarnish Lifetime Finish

www.waterconcepts.net • Serving our Customers Since 1946 • www.plumbsupply.com

Bar Faucets

Bar Faucets

Blanco Alta™ Bar Faucet (Cold water only)

- 3-1/2" Reach, 8-1/2" height
- Ceramic disc cartridge
- Installation in a 1-3/8" hole
- 2.2 GPM flow rate
- 2-3/8" Maximum deck thickness



Part #	Mfg #	Description	Handle(s)	Finish	Price
173605	440688	1-Hole, Cold Water Only	Lever	Chrome	

Blanco Meridian™ 1-Hdl Bar Faucet

- 7" Reach, 7-3/4" height
- 360° Swivel spout
- Ceramic disc cartridge
- Installation in a 1-3/8" hole
- 2.5 GPM flow rate
- 1-3/4" Maximum deck thickness



Part #	Mfg #	Description	Handle(s)	Finish	Price
189614	440953	1-Hole, Less Spray	Lever	Chrome	

Blanco Artona™ Pull-Down Bar Faucet

- 6-7/8" Reach, 13-5/8" height
- 180° spout swivel
- Ceramic disk cartridge
- SOLid brass body
- 2.2 GPM flow rate
- Installation in a 1-3/8" hole
- 2-1/4" Maximum deck thickness



Part #	Mfg #	Description	Handle(s)	Finish	Price
227463	442040	1-Hole, Pull-Down Spray, 2.2 GPM	Lever	Stainless/Cafe Brown	

Bar Faucets

Bar Tap Faucets

Long Reach Bar Tap Faucet

- 10" High
- 1/4" Connection
- Lead-free



Part #	Mfg #	Finish	Price
094750	B45-014	Chrome	

Bar Tap Faucet

- 1/4" Compression inlet connection
- Includes:
 - Stem
 - Spring
 - (2) O-Rings
 - Black handle
- Lead-free



Part #	Mfg #	Description	Price
073887	B45-010	Chrome-Plated	

Bar Faucets

Two-Handle Bar Faucets

P4B 2-Hdl Bar Faucet

- Ceramic cartridges
- Maximum flow rate: 2.2 gpm @ 60 psi



Part #	Mfg #	Description	Handle(s)	Finish	Price
141374	P4B-320C	4"cc 3-Hole, Goose Neck Spout	ADA Metal Lever	Chrome	
141375	P4B-320SS	4"cc 3-Hole, Goose Neck Spout	ADA Metal Lever	Stainless Steel	

P4C 2-Hdl Bar Faucet

- Washerless cartridges
- Maximum flow rate: 2.2 gpm @ 60 psi



Part #	Mfg #	Description	Handle(s)	Finish	Price
141390	P4C-320CB	4"cc 3-Hole, Goose Neck Spout	ADA Metal Wrist Blade	Chrome	

Faucets & Valves

Bar Faucets

Faucets & Valves

"Little Gourmet"® Point-Of-Use Drinking Faucets

MT600 "Little Gourmet"® Point-Of-Use Cold Water Faucet

- Height: 11-1/4"
- Spout reach: 3-3/4"
- Can be used as a water filtration faucet, bar or food prep faucet
- Reverse-osmosis filtration
- 1/4-Turn ceramic disc cartridge
- Comes with flange
- Meets NSF standards



Part #	Mfg #	Description	Handle(s)	Finish	Price
049360	MT600-NL/BRN	1-Hole Point-of-Use Drinking Faucet	Lever	Brushed Nickel	
088745	MT600-NL/BRS	1-Hole Point-of-Use Drinking Faucet	Lever	Brushed Stainless	
048786	MT600-NL/CPB	1-Hole Point-of-Use Drinking Faucet	Lever	Polished Chrome	
073745	MT600-NL/ORB	1-Hole Point-of-Use Drinking Faucet	Lever	Oil Rubbed Bronze	
087276	MT600-NL/VB	1-Hole Point-of-Use Drinking Faucet	Lever	Venetian Bronze™	

MT620 "Little Gourmet"® Point-Of-Use Cold Water Faucet

- Height: 11"
- Spout reach: 3-3/4"
- Can be used as a water filtration faucet, bar or food prep faucet
- Reverse-osmosis filtration
- 1/4-Turn ceramic disc cartridge
- Meets NSF standards



Part #	Mfg #	Description	Handle(s)	Finish	Price
089173	MT620-NL/BRS	1-Hole Point-of-Use Drinking Faucet	Lever	Brushed Stainless	

MT1103 "Little Gourmet"® Point-Of-Use Cold Water Faucet

- Height: 9-1/2"
- Spout reach: 5-5/8"
- Can be used as a water filtration faucet, bar or food prep faucet
- Reverse-osmosis filtration
- 1/4-Turn ceramic disc cartridge
- Meets NSF standards



Part #	Mfg #	Description	Handle(s)	Finish	Price
095364	MT1103/BRN	1-Hole Point-of-Use Drinking Faucet	Lever	Brushed Nickel	

*PVD Finish

www.waterconcepts.net • Serving our Customers Since 1946 • www.plumbsupply.com

Bar Faucets

Glass Fillers

- 3" Reach, 8-1/4" height
- 100% Lead-free waterway system
- Stainless steel gooseneck



Part #	Mfg #	Description	Handle(s)	Finish	Price
041063	LK-1110	1-Hole	Push Lever	Chrome	

Body Sprays

Body Sprays

MasterShower® Round Body Spray

- *Spray settings:*
-Full spray
-Massaging pulse spray
-Pause option
- *Flow rate: 1.5 gpm*
- *1/2" NPT Connection*



Part #	Mfg #	Description	Price
063508	K-8510-BN	*Brushed Nickel	
059581	K-8510-CP	Polished Chrome	

MasterShower® Invigorating Body Spray

- *Spray settings:*
-Wide strong spray
-Concentrated pulse
-Wide pulse
- *Flow rate: 2.5 gpm*
- *1/2" NPT Connection*



Part #	Mfg #	Description	Price
053754	K-8509-BN	*Brushed Nickel	
053753	K-8509-CP	Polished Chrome	

WaterTile® Round Single-Function Body Spray

- *Fully adjustable sprayface pivots for targeted hydromassage spray*
- *Low-profile design*
- *MasterClean™ sprayface*
- *Flow rate: 2.0 gpm*
- *1/2" NPT Connection*



Stimulating Spray

Part #	Mfg #	Description	Price
226673	K-8013-AF	27-Nozzle, *French Gold	
111830	K-8013-BN	27-Nozzle, *Brushed Nickel	
111832	K-8013-BV	27-Nozzle, *Brushed Bronze	
111829	K-8013-CP	27-Nozzle, Polished Chrome	
172080	K-8013-SN	27-Nozzle, Polished Nickel	
147040	K-8013-2BZ	27-Nozzle, Oil-Rubbed Bronze	

Soothing Spray

Part #	Mfg #	Description	Price
111826	K-8014-BN	54-Nozzle, *Brushed Nickel	
111828	K-8014-BV	54-Nozzle, *Brushed Bronze	
111825	K-8014-CP	54-Nozzle, Polished Chrome	
117069	K-8014-G	54-Nozzle, Brushed Chrome	

Body Sprays (Continued)

**WaterTile® Round Single-Function Body Spray
Soothing Spray**

Part #	Mfg #	Description	Price
148317	K-8014-SN	54-Nozzle, *Polished Nickel	
147041	K-8014-2BZ	54-Nozzle, Oil-Rubbed Bronze	

WaterTile™ Square Relaxing Body Spray

- *Soothing spray*
- *Low-profile design*
- *MasterClean™ sprayface is full adjustable and pivots to target*
- *Flow rate: 2.5 gpm*
- *1/2" NPT Connection*



Soothing Spray

Part #	Mfg #	Description	Price
094758	K-8002-AF	54-Nozzle, *French Gold	
090050	K-8002-BN	54-Nozzle, *Brushed Nickel	
095056	K-8002-BV	54-Nozzle, *Brushed Bronze	
086261	K-8002-CP	54-Nozzle, Polished Chrome	
093812	K-8002-G	54-Nozzle, Brushed Chrome	
149149	K-8002-SN	54-Nozzle, *Polished Nickel	
147035	K-8002-2BZ	54-Nozzle, Oil-Rubbed Bronze	

Stimulating Spray

Part #	Mfg #	Description	Price
134325	K-8003-AF	22-Nozzle, *French Gold	
090237	K-8003-BN	22-Nozzle, *Brushed Nickel	
116359	K-8003-BV	22-Nozzle, *Brushed Bronze	
086262	K-8003-CP	22-Nozzle, Polished Chrome	
089031	K-8003-G	22-Nozzle, Brushed Chrome	
149150	K-8003-SN	22-Nozzle, Polished Nickel	
147037	K-8003-2BZ	22-Nozzle, Oil-Rubbed Bronze	

* Vibrant Limited Lifetime Warranty

www.waterconcepts.net • Serving our Customers Since 1946 • www.plumbsupply.com

Body Sprays

Body Sprays Square Body Spray

- 30° Up and down adjustment
- 2.5 gpm @ 80 psi
- 1/2" Rough-in
- Solid brass construction
- Touch-Clean® soft, rubber nubbins
- Matching finish spray face



Part #	Mfg #	Finish	Price
144689	50150	Chrome	
160833	50150-CZ	Champagne Bronze™	
175031	50150-PN	Polished Nickel*	
144643	50150-RB	Venetian Bronze®	
143549	50150-SS	Stainless*	

Surface Mount Body Spray

- 2.5 gpm @ 80 psi
- 1/2" Rough-in
- Solid brass construction
- Touch-Clean® soft, rubber nubbins
- Matching finish spray face
- Full body spray setting



Part #	Mfg #	Finish	Price
128477	50102	Chrome	
145828	50102-CZ	Champagne Bronze™	
176411	50102-PN	Polished Nickel*	
125763	50102-RB	Venetian Bronze®	
126248	50102-SS	Stainless*	

Baliza® Round Body Spray Trim

- 1.5 GPM @ 80 PSI
- Flush mount installation
- 1/2" Rough-in
- 3-1/2" Height and width
- Requires (R84100) rough-in
- Requires one of these sprayheads; (SH8411, SH84101, SH84102, or SH84103)



Showerhead Not Included

Part #	Mfg #	Description	Price
189225	T84613-PC	Polished Chrome	

Baliza® Square Body Spray Trim

- 1.5 gpm @ 80 psi
- Flush mount installation
- 1/2" Rough-in
- 3-1/2" Height and width
- Requires (R84100) rough-in
- Requires one of these sprayheads; (SH8411, SH84101, SH84102, or SH84103)



Showerhead Not Included

Part #	Mfg #	Description	Price
189408	T84913-PC	Polished Chrome	
215452	T84913-BN	Brushed Nickel	

H2Okinetic Technology™ Round Body Spray Trim

- Requires 1/2" R50001 body spray rough-in
- Adjusts both vertically and horizontally
- Features patented H2Okinetic Technology™



Part #	Mfg #	Finish	Price
138259	T50001	Chrome	
161956	T50001-PN	Polished Nickel*	
136044	T50001-RB	Venetian Bronze®	
136378	T50001-SS	Stainless*	

H2Okinetic Technology™ Square Body Spray Trim

- Requires 1/2" R50001 body spray rough-in
- Adjusts both vertically and horizontally
- Features H2Okinetic Technology™



Part #	Mfg #	Description	Price
154287	T50050	Chrome	
161487	T50050-RB	Venetian Bronze®	
159201	T50050-SS	Stainless*	

Body Sprays

Faucets & Valves

HydraChoice™ Body Spray Round Trim

- 1.0 gpm @ 80 psi
- Flush mount installation
- 3-1/2" height and width
- 1/2" rough-in
- Rough, trim and spray head require for complete unit
- Rough and spray head sold separately



Part #	Mfg #	Description	Price
170572	T50010	Chrome	
217420	T50010-CZ	Champagne Bronze™	
190342	T50010-PN	Polished Nickel*	
171108	T50010-RB	Venetian Bronze®	
170079	T50010-SS	Stainless*	

HydraChoice™ Max Body Spray Round Trim

- 1/2" Rough-in
- 3-1/2" height and width
- Optional RP82501 reduces flow rate to 1.0 gpm
- Flush mount installation



Part #	Mfg #	Description	Price
227115	T84613-NK	Luxe Nickel*	

HydraChoice™ Body Spray Square Trim

- 1.0 gpm @ 80 psi
- Flush mount installation
- 3-1/2" height and width
- 1/2" rough-in
- Rough, trim and spray head required for complete unit
- Rough and spray head sold separately



Part #	Mfg #	Description	Price
179827	T50210	Chrome	
178601	T50210-RB	Venetian Bronze®	
171797	T50210-SS	Stainless*	

Square Body Jet with H2Okinetic Technology™

- Jet rotates 360°, adjustable in all directions
- H2Okinetic® technology
- Includes standard 1/2" rough-in



Part #	Mfg #	Finish	Price
145888	50101	Chrome	
149237	50101-RB	Venetian Bronze®	
168934	50101-SS	Stainless*	

Round Body Jet H2Okinetic Technology™

- Jet rotates 360°, adjustable in all directions
- H2Okinetic® technology
- Includes standard 1/2" rough-in



Part #	Mfg #	Description	Price
153743	50100	Chrome	
158575	50100-RB	Venetian Bronze®	
151426	50100-SS	Stainless*	

Baliza® Spray Heads

- Spray heads adjust up to 50° in any direction once extended
- H2Okinetic® Technology
- Spray head automatically extends 1-11/32" out of the wall when water is turned on
- Spray heads are interchangeable

Soothing Spray



Part #	Mfg #	Description	Price
189409	SH84100-PC	Polished Chrome	

Massaging Spray



Part #	Mfg #	Description	Price
189226	SH84101-PC	Polished Chrome	

Body Sprays

Body Sprays (Continued)

Baliza® Spray Heads

Massaging Spray

Part #	Mfg #	Description	Price
227073	SH84101-NK	Luxe Nickel*	

HydraChoice™ Spray Heads

- Must order rough (R50200) and trim (T50010 or T50210) separately
- Spray head automatically extends 1-11/32" out of the wall when water is turned on
- Spray heads are interchangeable
- Spray heads adjust up to 50° in any direction once extended
- H2Oknetic® Technology and Touch-Clean® spray holes

Max Spray



Part #	Mfg #	Description	Price
228225	SH84103-BN	Brushed Nickel	

Full Spray



Part #	Mfg #	Description	Price
170573	SH5000	Chrome	
229411	SH5000-CZ	Champagne Bronze™	
171110	SH5000-RB	Venetian Bronze®	
170647	SH5000-SS	Stainless*	

Invigorating Spray



Part #	Mfg #	Description	Price
179828	SH5002	Chrome	
171111	SH5002-RB	Venetian Bronze®	
170648	SH5002-SS	Stainless*	

Soothing Spray



Part #	Mfg #	Description	Price
171112	SH5003-RB	Venetian Bronze®	
170649	SH5003-SS	Stainless*	

Massaging Spray



Part #	Mfg #	Description	Price
179680	SH5005	Chrome	
190343	SH5005-PN	Polished Nickel	
171113	SH5005-RB	Venetian Bronze®	
170080	SH5005-SS	Stainless*	

Loki™ Body Spray Trim and Rough

- Maximum flow rate: 2.0 gpm @ 80 psi



Part #	Mfg #	Description	Price
162481	84121-BL	Matte Black	
158119	84121-BN	Brushed Nickel*	
157191	84121-PC	Chrome	
169999	84121-PN	Polished Nickel*	
164988	84121-RB	Venetian Bronze®	

Vesi Body Spray Trim and Rough

- Surface mount
- 1/2" rough-in flows 2.0 gpm



Part #	Mfg #	Description	Price
138230	84110-BB	Brass*	
177375	84110-BL	Matte Black	
126053	84110-BN	Brushed Nickel*	
130687	84110-BZ	Brushed Bronze*	
129973	84110-PC	Chrome	
148742	84110-PN	Polished Nickel*	

Body Sprays

Faucets & Valves

Body Sprays (Continued)

Vesi Body Spray Trim and Rough

Part #	Mfg #	Description	Price
125996	84110-RB	Venetian Bronze®	

Body Spray Rough-Ins

HydraChoice™ Body Spray Rough



Part #	Mfg #	Description	Price
170078	R50200	1/2" Rough-In	

Custom Shower System Body Spray Rough-In

- H2Okinetic® spray
- 3-3/4" diameter spray face
- Adjust spray horizontally and vertically
- 1.6 gpm @ 80 psi
- Order rough separately (R50001)



Part #	Mfg #	Description	Price
135507	R50001	1.6 gpm H2O Body Spray Rough-In, Brass*	

Baliza® Body Spray Rough



Part #	Mfg #	Description	Price
189227	R84100	1/2" Rough-In	

Body Sprays

Body Sprays

Round Mosaic Body Spray

- 3-1/4" Spray head
- Single spray
- Flush mounting
- 1/2" IPS; CC



Part #	Mfg #	Finish	Price
155174	TS1322	Chrome	
166317	TS1322BN	Brushed Nickel	
217378	TS1322NL	Polished Nickel	
161558	TS1322ORB	Oil Rubbed Bronze	

Square Mosaic Body Spray

- 3-1/4" Diameter sprayhead
- Single spray
- Flush mounting
- 1/2" IPS; CC



Part #	Mfg #	Finish	Price
170114	TS1320	Chrome	
141011	TS1320BN	Brushed Nickel	
152812	TS1320ORB	Oil Rubbed Bronze	

Round Mosaic 2-Function Body Spray

- 3-1/4" Spray head, 5-3/8" overall
- 1/2" CC;IPS connections
- Spray face tilts 20° in any direction
- 2-Function
 - Full spray
 - Targeted massage



Requires Rough-In: S1300

1" Extension available: 155656

Part #	Mfg #	Finish	Price
186315	TS1422	Chrome	
221185	TS1422BN	Brushed Nickel	

Square Mosaic 2-Function Body Spray

- 3-1/4" Spray head, 5-3/8" overall
- 1/2" CC;IPS connections
- Spray face tilts 20° in any direction
- 2-Function
 - Full spray
 - Targeted massage



Requires Rough-In: S1300

1" Extension available: 155656

Part #	Mfg #	Finish	Price
221010	TS1420BN	Brushed Nickel	
186119	TS1420ORB	Oil Rubbed Bronze	

Single Function Body Spray

- Metallic spray face and shell
- Brass swivel ball assembly
- 1/2" IPS connection
- Flow rate: 1.75 gpm



Part #	Mfg #	Finish	Price
097432	A501	Chrome	
095829	A501BN	Brushed Nickel	
108133	A501ORB	Oil Rubbed Bronze	
109620	A501WR	Wrought Iron	

Body Spray Rough-Ins

Body Spray Rough-In Box

- 1/2"CC/IPS connections



Part#	Mfg#	Description	Price
141009	S1300	Fits 2x4 wall	

Commercial - Institutional Faucets

Commercial Two-Handle Service Sink Faucets

Teck™ Commercial Service 2-Hdl Sink & Bar Faucet

- Heavy-duty cartridges
- Tuf-Teck™ compression structures
- 8" Long, rigid vacuum breaker spout
- With integral stops
- Top brace
- Cross handles with hot/cold indicators
- Rough chrome finish



Part #	Mfg #	Description	Handle(s)	Finish	Price
023647	28T9	8"cc Wall-Mount	Cross	Rough Chrome	

Commercial Kitchen Accessories

Basin Mounted Liquid Soap Dispenser

- 4" Nozzle reach
- 2-11/16"
- 3" Maximum deck thickness



Part #	Mfg #	Description	Handle(s)	Finish	Price
185576	44000	32oz White Translucent Bottle	-	Chrome	

* Brilliance® Anti-Tarnish Lifetime Finishes

www.waterconcepts.net • Serving our Customers Since 1946 • www.plumbsupply.com

Commercial - Institutional Faucets

Commercial Electronic Metering Lavatory Faucets

Arzo® Proximity® Sensing Electronic Lavatory Faucet

- Hands-free activation
- 4-11/25" Reach, 4-9/10" high rigid brass spout
- 1-1/2" Maximum deck thicknesses
- Surface mounted control box
- Adjustable sensing range, auto shut-off, metering mode, and periodic rinse feature
- No lift rod hole
- Battery powered uses four "C" cells
- Hardwired model is 24VAC to 6VDC
- Mixing valve required
- WaterSense® certified product: 1.5 gpm @ 60 psi



Part #	Mfg #	Description	Handle(s)	Finish	Price
141768	600T040	1-Hole, Hardwired, 1.5 gpm	ADA Electronic	Chrome	
132283	601T040	1-Hole, Battery Operated, 1.5 gpm	ADA Electronic	Chrome	
163573	600T050	1-Hole, Hardwired, 0.5 gpm	ADA Electronic	Chrome	
174365	600T050-SS	1-Hole, Hardwired, 0.5 gpm	ADA Electronic	*Stainless	

DEMD Electronic Lavatory Faucet

- Sensor detects user's hand to activate water flow
- (6) 1.5V batteries
- Adjustable maximum run time and optional remote control below
- 1-1/4" Maximum deck thicknesses
- Above deck electronics
- Red light indicator blinks when battery is low
- Cold water or pre-mixed only
- WaterSense Certified: 0.5 gpm @ 60 psi



Part #	Mfg #	Description	Handle(s)	Finish	Price
159957	DEMD-201LF	1-Hole, Battery Operated, Gooseneck Spout	ADA Electronic	Chrome	

DEMD Electronic Faucet for Cold or Pre-Mixed Water

- Vandal resistant wrench flat spray outlet
- 2" maximum deck thicknesses
- Adjustable sensor range
- Optional 4" cover plate available
- Battery operated
- Batteries included
- WaterSense Certified: 0.5gpm @ 60 psi



Part #	Mfg #	Description	Handle(s)	Finish	Price
158275	DEMD-301LF	1-Hole, Battery Operated, Rigid Spout	ADA Electronic	Chrome	

* Brilliance® Anti-Tarnish Lifetime Finishes

www.plumbsupply.com • Serving our Customers Since 1946 • www.waterconcepts.net

Commercial - Institutional Faucets

Faucets & Valves

DEMD Electronic Lavatory Faucet

- Battery operated
- Above deck mixer to adjust water temperature

For Hardwire -Order 060704A and 060974A

For Plug-in- Order 060958A

For optional remote control sensor adjustment, see 060967A



Part #	Mfg #	Description	Handle(s)	Finish	Price
227361	DEMD-111LF	1-Hole, Battery Operated, Rigid Spout	ADA Electronic	Chrome	

Innovations® Commercial Electronic Lavatory Faucet

- 5-1/4" Reach, 3-7/8" high rigid spout
- 2-3/8" From deck to aerator
- Hand-free operation
- H2Optics® technology, no external adjustments required
- Self-adaptive technology
- Mixing valve required
- 1-1/2" Maximum deck thicknesses
- No lift rod hole or grid strainer
- 4" Anti-rotation cover plate
- Powered by (4) C batteries
- Operates with a 45 second max run time
- WaterSense Certified: 0.5 gpm @ 60 psi



590



591



Part #	Mfg #	Description	Handle(s)	Finish	Price
070221	590LF-LGHGMHDF	1-Hole 4"cc, 0.5gpm	ADA Electronic	Chrome	
156000	591LF-LGHGMHDF	3-Hole 4"cc, 0.5 gpm	ADA Electronic	Chrome	

Teck® Commercial Electronic Lavatory Faucet

- Hands-free operation, integral waterproof sensor and connector
- 4" Reach rigid spout
- Cast 1-piece body
- Battery powered
- No mixing valve included
- WaterSense Certified



591T1250



Part #	Mfg #	Description	Handle(s)	Finish	Price
136718	590T1150	1-Hole, Hi-Rise Spout, 0.5 gpm VR Non-Aerating	ADA Electronic	Chrome	
108618	590T0250	4"cc, Hardwired, Hi-Rise Spt 0.5 gpm VR Laminar	ADA Electronic	Chrome	
093591	591T1250	4"cc, No Lift-Rod Hole, 0.5 gpm VR Outlet	ADA Electronic	Chrome	
135638	591T1268	4"cc, No Lift Rod Hole, 1.0 gpm VR Non-Aerating	ADA Electronic	Chrome	
158277	591T0268TR	3-Hole 4"cc Hardwire Operated, 1.0 gpm	ADA Electronic	Chrome	
228266	591-PLGHDFHW	4"cc, 7.5" Forged Cover Plate	ADA Electronic	Chrome	

* Brilliance® Anti-Tarnish Lifetime Finishes

www.waterconcepts.net • Serving our Customers Since 1946 • www.plumbsupply.com

Commercial - Institutional Faucets

Teck® Proximity® Sensing Commercial Electronic Faucet

- Proximity® Sensing Technology
- (4) C Batteries or Hardwired
- Adjustable sensing range and timeout
- Forged brass solenoid valve
- Surface mount housing
- Mixing valve required
- WaterSense Certified



Part #	Mfg #	Description	Handle(s)	Finish	Price
185375	590TP0220	4"cc Forged Cover plate, Hi-Rise Spt 1.5gpm VR	ADA Electronic	Chrome	
170501	590TP1160	1-Hole, Battery Operated, Hi-Rise Spout, 1.0 gpm	ADA Electronic	Chrome	
174957	590T0158TR	1-Hole, Hardwire Operated, Hi-Rise Spout 0.5 gpm	ADA Electronic	Chrome	
178568	590-PLGHDF	1-Hole, Battery Operated, Low Spout, 0.5 gpm	ADA Electronic	Chrome	
204949	590-PLGHDFHW	1-Hole, Hardwire Operated, 0.5 gpm	ADA Electronic	Chrome	

Commercial Electronic Lavatory Faucet

- Battery operated
- H2Optics® technology - no external adjustments required
- 1-Piece cast main body with integral sensor and rigid spout
- Adjustable sensing range and timeout
- Audible low battery indicator
- WaterSense Certified



1501T4630



Part #	Mfg #	Description	Handle(s)	Finish	Price
117300	1501T3320	Deck-Mount, 1.5 gpm VR Aerator	ADA Electronic	Chrome	
138206	1500T3480	Deck-Mount w/4" Plate, 0.5 gpm Laminar Flow Control	ADA Electronic	Chrome	
130545	1501T3570	Deck-Mount w/8" Plate, 1.5 gpm Laminar Flow Control	ADA Electronic	Chrome	
133384	1501T4630	Wall-Mount, 1.5 gpm VR Aerator	ADA Electronic	Chrome	

Single-Handle Commercial Lavatory Faucets

Delta® HDF® DIAMOND™ Seal 1-Hdl Lavatory Faucet

- Heavy-duty commercial product
- Hot/cold indicators
- 3/8" OD Straight, staggered supply tubes
- DIAMOND™ Valve with Innoflex™ PEX waterways
- WaterSense Certified



511-HGM-HDF-DST



523-HDF-DST



Part #	Mfg #	Description	Handle(s)	Finish	Price
135900	511-HGM-HDF-DST	4"cc, 5" Spout, No Lift-Rod Hole, 1/2 gpm Flow, Lead-Free	VR ADA Elbow	Chrome	
139551	511LF-HDF	4"cc, less Pop-Up and Lift-Rod Hole, 1.5 or 0.5gpm, Lead-Free	ADA Lever	Chrome	
128599	515-HGM-HDF-DST	2- or 3- Hole, Metal Pop-Up, 1.5 gpm VR, Lead-Free	ADA Lever	Chrome	
004046	515LF-HDF	2- or 3-Hole, Metal Pop-Up, 1.5 gpm VR, Lead-Free	ADA Lever	Chrome	
132280	523-HDF-DST	4"cc, 4-1/2" Spout, Grid Strainer, No Lift-Rod Hole, Lead-Free	ADA Lever	Chrome	

* Brilliance® Anti-Tarnish Lifetime Finishes

www.plumbsupply.com • Serving our Customers Since 1946 • www.waterconcepts.net

Commercial - Institutional Faucets

Faucets & Valves

Delta® HDF® 1-Hdl Centerset Lead-Free Lavatory Faucet

- Single handle lavatory deck faucets for exposed mounting on 3-hole sinks
- All metal fabricated body
- 5" Spout
- Vandal-resistant aerator or spray outlet
- Heavy-duty commercial product
- 3/8" OD Straight, staggered copper supply tubes with 3/8" fittings
- Low flow rate: 1.5 gpm @ 60 psi
- HGM Suffix: flow rate: 0.5 gpm @ 60 psi



Part #	Mfg #	Description	Handle(s)	Finish	Price
139369	501LF-HDF	3-Hole 4"cc, 4-1/2" Spout, Less Pop-Up Drain, Lead-Free	ADA Lever	Chrome	
139181	501LF-HGMHDF	3-Hole 4"cc, 4-1/2" Spout, Less Pop-Up Drain, Lead-Free	ADA Lever	Chrome	
146181	520LF-HGMHDF	3-Hole 4"cc, 4-1/2" Spout, Metal Pop-Up Drain, Lead-Free	ADA Lever	Chrome	
004049	520LF-HDF	4"cc, 5" Spout, Metal Pop-Up Drain, Lead-Free	ADA Lever	Chrome	
139371	511LF-HGMHDF	4"cc, 5" Spout, No Lift-Rod Hole, Lead-Free	VR ADA Elbow	Chrome	
132282	523LF-HGMHDF	4"cc, 4-1/2" Spout, Grid Strainer, Lead-Free	VR ADA Lever	Chrome	

Teck® 22C Commercial 1-Hdl Centerset Lavatory Faucet

- Rigid spout
- Cast brass
- Ceramic cartridge with rotational limit stop
- Vandal-resistant 3-1/2" ADA lever handle with color index
- 3/8" Compression fittings
- WaterSense Certified



Part #	Mfg #	Description	Handle(s)	Finish	Price
086626	22C101	4"cc less Pop-Up, 1.5 gpm VR Aerator, 5.32" Reach	ADA Lever	Chrome	
103994	22C121	4"cc less Pop-Up, 1.5gpm VR Aerator w/Antimicrobial, 5.75" Reach	ADA Lever	Chrome	
099974	22C131	4"cc less Pop-Up, 1.5 gpm VR Aerator	ADA Lever	Chrome	
093894	22C151	4"cc less Pop-Up, 0.5 gpm VR Aerator	ADA Lever	Chrome	
186094	22C191	4"cc less Pop-Up, 0.35gpm VR Aerator	ADA Lever	Chrome	
114941	22C301	4"cc with Pop-Up, 1.5 gpm VR Aerator, 5.75" Reach	ADA Lever	Chrome	
227966	25C521	4"cc w/ ADA Offset Grid Drain 1.5 gpm CR Aerator	VR ADA Lever	Chrome	
089047	22C601	1-Hole less Pop-Up, 1.5 gpm VR Aerator, 5.32" Reach	ADA Lever	Chrome	
145920	22C631	1-Hole less Pop-Up, 1.5 gpm VR, 5.75" Reach	ADA Lever	Chrome	
082015	22C651	1-Hole less Pop-Up, 1.5 gpm VR Non-Aerating, 5.75" Reach	ADA Lever	Chrome	
185789	22C851	1-Hole w/ Metal Pop-Up, 0.5gpm VR Aerator	ADA Lever	Chrome	
185518	22C991	1-Hole w/ Grid Strainer, 0.35 VR Aerator	ADA Lever	Chrome	

* Brilliance® Anti-Tarnish Lifetime Finishes

www.waterconcepts.net • Serving our Customers Since 1946 • www.plumbsupply.com

Commercial - Institutional Faucets

Delta® Commercial 1-Hdl Mixing Faucet

- Gooseneck spout
- Washerless
- Vandal-resistant 6" elbow lever handle
- High temperature limit stop
- Vandal-resistant set screws
- WaterSense Certified



Faucets & Valves

Part #	Mfg #	Description	Handle(s)	Finish	Price
142333	24T2643-R7	2-Hole less Pop-Up, 12.7" Gooseneck, 1.5 gpm Aerator	ADA Lever Blade	Chrome	
127288	24T2673	2-Hole less Pop-Up, Smooth Spout End 1.0 gpm	ADA Lever Blade	Chrome	

Teck® Commercial Bedpan Cleanser - Foot pedal Mixing

- Double pedal self-close WM valve with inlet stops and outlet volume control stop



Part #	Mfg #	Description	Handle(s)	Finish	Price
137794	54T1454A	Double Pedal Self-Close WM Valve, Rigid Spout	Foot pedal	Chrome	

Teck® Commercial Bedpan Cleanser - Wall-Mount

- Lever handle
- Double check vacuum breaker
- Reinforced hose and hanger
- Insulated handle on wand
- Rose spray outlet



Part #	Mfg #	Description	Handle(s)	Finish	Price
127286	54T1104	Tuf-Teck®	Lever	Chrome	

Teck® 86T Commercial 1-Hdl Washdown Urinal Valve

- Supply metering urinal valve



86T503

Part #	Mfg #	Description	Handle(s)	Finish	Price
023639	86T502	Back Inlet Supply, Inlet Cover Tube, Wall Flange	ADA Brass Oscillating Lever	Chrome	
023642	86T503	Top Inlet Supply	ADA Brass Oscillating Lever	Chrome	

* Brilliance® Anti-Tarnish Lifetime Finishes

www.plumbsupply.com • Serving our Customers Since 1946 • www.waterconcepts.net

Commercial - Institutional Faucets

Faucets & Valves

E-Lav Faucet Accessories

Teck® Commercial Rough-In Box for E-Lav Faucets

- Control box rough-in
- For recessed wall mounting
- 10" square metal box with cover
- Hot and cold inlet supplies
- Point of use thermostatic mixing valve
- Integral check valves
- Max flow: 11 gpm @ 45 psi
- Factory assembled waterway components with stops

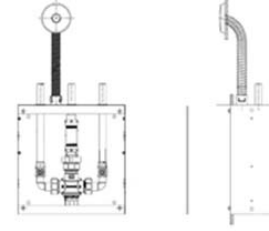

Part #	Mfg #	Description	Handle(s)	Finish	Price
158278	ELAVT0008ARI	Electronic control box, ONLY with Thermostatic Mixing Valve			

Two-Handle Commercial Lavatory Faucets

Single Shank 2-Hdl Mixing Faucet

- 4-1/2" Long, 14-1/4" high rigid spout spout
- Red/blue indicators
- Standard aerator
- 3/8" Compression fittings
- 2" Max deck thickness
- CER-TECK cartridges
- WaterSense® certified product: 1.5 gpm @ 60 psi



Part #	Mfg #	Description	Handle(s)	Finish	Price
098041	25C3847	4"cc, 1-Hole	Balanced Lever	Chrome	

HDF Commercial 2-Hdl Centerset Lavatory Faucet

- 3-1/4" High, 5-1/4" reach rigid spout
- Red/blue indicators
- 2" From deck to aerator
- 1-3/8" Maximum deck thickness
- Vandal resistant aerator
- 1/2" IPS shanks
- Large wrist blade handles
- WaterSense® certified product: 1.2 gpm at 60 psi
- Lifetime faucet and finish warranty



2529LF-HDF



Part #	Mfg #	Description	Handle(s)	Finish	Price
146470	2529LF-LGHDF	4"cc, 2-Hole, L/Grid Strainer, No Lift Rod Hole, Lead-Free	ADA Wrist Blade	Chrome	
146469	2529LF-HDF	4"cc, 2-Hole, Grid Strainer, No Lift Rod Hole, Lead-Free	ADA Wrist Blade	Chrome	
169851	2529LF-HDM	4"cc, 2-Hole Metal Pop-Up, No Lift Rod Hole, Lead-Free	ADA Wrist Blade	Chrome	
177528	2529LF-LGHGMHDF	4"cc, 2-Hole Less Drain, No Lift Rod Hole, Lead Free	ADA Wrist Blade	Chrome	

* Brilliance® Anti-Tarnish Lifetime Finishes

www.waterconcepts.net • Serving our Customers Since 1946 • www.plumbsupply.com

Commercial - Institutional Faucets

Tract-Pack Commercial 2-Hdl Lavatory Faucet

- 5-1/4" Spout reach, 3-1/4" high
- 4" Centers
- 1/2"-14 NPSM threaded male inlet shanks
- 2" From deck to aerator
- 1/4 Turn handle stops
- WaterSense® certified product: 1.2 gpm @ 60 psi



Faucets & Valves

Part #	Mfg #	Description	Handle(s)	Finish	Price
179444	2500LF-TP	2- or 3-hole 4"cc, Lead Free Less Drain and Lift Rod	ADA Blade	Chrome	

Teck® 21C/21T Commercial 2-Hdl ADA Lever Faucet

- Cast brass body
- Compression
- Vandal-resistant lever handles with hot/cold handle indicators
- WaterSense Certified



21_142



21_143

Part #	Mfg #	Description	Handle(s)	Finish	Price
090422	21C122	4"cc, less Pop-Up, Cer-Teck® 1.5gpm	ADA Hooded Blade	Chrome	
122353	21C124	4"cc, less Pop-Up, Cer-Teck® 1.5 gpm	ADA Blade	Chrome	
120989	21C134	4"cc, less Pop-Up, Cer-Tek®, 1.5gpm	ADA Blade	Chrome	
090395	21C142	4"cc, less Pop-Up, Cer-Teck®, 1.5gpm	ADA Hooded Blade	Chrome	
097794	21C144	4"cc, less Pop-Up, Cer-Teck®, 1.5gpm	ADA Blade	Chrome	
110742	21C153	4"cc, less Pop-Up, Cer-Teck®. 0.5gpm	ADA Hooded Lever	Chrome	
177930	21C355	4"cc, Grid Drain, Cer-Teck®, 0.5gpm	ADA Wrist Blade	Chrome	
023648	21T143	4"cc, less Pop-Up, Tuf-Teck®	ADA Lever	Chrome	

HDF Commercial 2-Hdl Widespread Lavatory Faucet

- 5-1/4" Spout reach
- 6-16" Centers
- Vandal resistant metal wrist blade handles
- 1/2" IPS connection
- 1/4 Turn handle stop
- WaterSense® Certified: 1.20 gpm @ 60 psi



3549LF-WFHDF



Part #	Mfg #	Description	Handle(s)	Finish	Price
154527	3549LF-WFHDF	6-16" Centers, 3-Hole w/ Grid Strainer, 1.5gpm	ADA Wrist Blade	Chrome	
019941	3549LF-WFLGHDF	6-16" Centers, 3-Hole Less Grid Drain, 1.2gpm	ADA Wrist Blade	Chrome	

* Brilliance® Anti-Tarnish Lifetime Finishes

www.plumbsupply.com • Serving our Customers Since 1946 • www.waterconcepts.net

Commercial - Institutional Faucets

Faucets & Valves

HDF Commercial 2-Hdl Widespread Lavatory Faucet with Gooseneck Spout

- 5-3/4" Reach, 11" high rigid spout
- Vandal resistant metal wrist blade handles
- 3/8" O.D. copper supply tube inlets with 1/2"-14 NPSM adapters
- WaterSense Certified



Part #	Mfg #	Description	Handle(s)	Finish	Price
004014	3579LF-WFLGHDF	6-16" Centers, 3-Hole Less Drain 1.5gpm	ADA Wrist Blade	Chrome	

Teck® 23C/23T Commercial 2-Hdl Widespread Deck Faucet

- 4-1/2" Cast spout or 12" high rigid/swivel gooseneck spout
- Cast brass body
- Tuf-Teck™ or Cer-Teck® cartridges
- Red/blue indicators
- WaterSense Certified



Part #	Mfg #	Description	Handle(s)	Finish	Price
179874	23C624-R4	6"-12"ws, 6" GN Spout, Cer-Teck®, 1.5 gpm	ADA Blade	Chrome	
076341	23C642	6"-12"ws, Rigid/Swivel Inline Spt, Cer-Teck® 1.5 gpm	ADA Hooded Blade	Chrome	
172229	23C644-R7	6"-12"ws, Rigid/Swivel Inline Spt, Cer-Teck® 1.5 gpm	ADA Blade	Chrome	
122648	23C645	6"-12"ws, GN Spout, Cer-Teck®, 1.5 gpm	ADA Wrist Blade	Chrome	
125332	23C652	6"-12"ws, GN, Cer-Teck®, 0.5 gpm VR Non-A	ADA Hooded Blade	Chrome	
038415	23T644	6"-12"ws, GN, Metal Pop-Up, Tuf-Teck™, 1.5 gpm	ADA Wrist Blade	Chrome	

Teck® 2-Hdl Faucet with Third Valve Connection

- 4-1/2" Spout reach
- 7" From deck to aerator
- 3/8" IPS brass pipe
- Metal hold-down package
- WaterSense Certified



Part #	Mfg #	Description	Handle(s)	Finish	Price
185668	54T2402	8"cc, Gooseneck Spout TUF-TECK® VR 1.5gpm	ADA Blade	Chrome	

* Brilliance® Anti-Tarnish Lifetime Finishes

www.waterconcepts.net • Serving our Customers Since 1946 • www.plumbsupply.com

Commercial - Institutional Faucets

Teck® 26C3 Commercial 2-Hdl Mixing Deck Lavatory Faucet

- Swing-spout or rigid/swivel gooseneck spout
- Heavy-duty cast brass deck-mount mixing faucet
- Vandal resistant color indexed metal handles
- WaterSense Certified



26C3942



Faucets & Valves

Part #	Mfg #	Description	Handle(s)	Finish	Price
128940	26C3143	8"cc, Swing Spout, Cer-Teck®, 1.5 gpm Aerator	ADA Lever Blade	Chrome	
100512	26T3143	8"cc, Swing Spout, Tuf-Teck®, 1.5 gpm Aerator	ADA Lever Blade	Chrome	
138209	26C3232	8"cc, Tubular Swing Spout, Cer-Teck®, 1.5 gpm VR	ADA Hooded Blade	Chrome	
122880	26T3234	8"cc, Swing Spout, Tuf-Teck®, 1.5 gpm VR	ADA Wrist Blade	Chrome	
090906	26T3244	8"cc, Tubular Swing Spout, Tug-Teck®, 1.5 gpm	ADA Blade	Chrome	
138208	26C3922-R7	8"cc, 10.4" GN Spout, Cer-Teck®, 1.5 gpm VP Laminar	ADA Hooded Blade	Chrome	
134018	26C3924	8"cc, 10.4" GN Spout, Cer-Teck®, 1.5 gpm VR	ADA Blade	Chrome	
142893	26C3924-R7	8"cc, 12.7" GN Spout, Cer-Teck®, 1.5 gpm VR Laminar	ADA Blade	Chrome	
119648	26C3933	8"cc, 10.4" GN Spout, Cer-Teck®, 1.5 gpm VR Laminar	ADA Blade	Chrome	
126759	26C3935	8"cc, 10.4" GN Spout, Cer-Tek®, 1.5 gpm VR	ADA Wrist Blade	Chrome	
116979	26C3942-R7	8"cc, 12.7" Swing GN Spout, Cer-Teck®, 1.5 gpm Aerator	ADA Hooded Blade	Chrome	
132452	26C3943	8"cc, 10.4" GN Spout, Cer-Teck®, 1.5 gpm Aerator	ADA Lever Blade	Chrome	
106042	26C3944	8"cc, 10.4" GN Spout, Cer-Teck®, 1.5 gpm Aerator	ADA Blade w/San Hood	Chrome	
090355	26T3944	8"cc, 10.4" GN Spout, Tuf-Teck®, 1.5 gpm Aerator	ADA Blade w/San Hood	Chrome	

* R7 Spout - gooseneck spout with flow control

Teck® Commercial 2-Hdl Faucet

- Swing spout or rigid/swivel gooseneck spout
- Cast brass body
- Tuf-Teck™ or Cer-Teck® cartridges
- WaterSense Certified



27C4844



Part #	Mfg #	Description	Handle(s)	Finish	Price
127064	27C1922	8"ws, w/Spray, Cer-Teck®, 10.4" GN, 1.5 gpm VR	ADA Hooded Blade	Chrome	
186323	27C1924-LS-R7TI	8"ws, w/Spray, Cer-Teck®, 10.4"GN, 6"Reach 1.5 gpm VR	ADA Blade	Chrome	
135548	27C1942	8"ws, w/Spray, Cer-Teck®, 10.4" GN, 1.5 gpm	ADA Hooded Blade	Chrome	
122722	27T1943	8"ws, w/Spray, Cer-Teck®, 8" Swing Spout, 0.5 gpm VR	5-Flute Handle	Chrome	
145946	27C2144	8"ws, less Spray, Cer-Teck®, 8" Swing Spout, 1.5 gpm	ADA Blade	Chrome	
144363	27C1944-R7	8"ws, w/Spray, Cer-Teck®, 12.7" GN, 1.5 gpm	ADA Blade	Chrome	
134090	27C2142	8"ws, less Spray, Cer-Teck®, 8" Swing Spout, 1.5 gpm	ADA Hooded Blade	Chrome	
126744	27C2924	8"ws, less Spray, Cer-Teck®, 6" Swing Spout, 1.5 gpm	ADA Blade	Chrome	
186319	27C2924-LS-TI	8"ws, Cer-Teck®, 10.4"GN Spt, 1.5gpm VR	ADA Blade	Chrome	
148054	27C2924-LS-R7TI	8"ws, Cer-Teck®, 12.7"GN Spt, 1.5gpm VR	ADA Blade	Chrome	
149986	27C2925	8"ws, less Spray, Cer-Teck®, 10.4" GN, 1.5 gpm VR	ADA Wrist Blade	Chrome	
096942	27C2942	8"ws, less Spray, Cer-Teck®, 10.4" GN, 1.5 gpm	ADA Hooded Blade	Chrome	

* Brilliance® Anti-Tarnish Lifetime Finishes

www.plumbsupply.com • Serving our Customers Since 1946 • www.waterconcepts.net

Commercial - Institutional Faucets

Two-Handle Commercial Lavatory Faucets (Continued)

Teck® Commercial 2-Hdl Faucet

Faucets & Valves

Part #	Mfg #	Description	Handle(s)	Finish	Price
100858	27C2944	8"ws, less Spray, Cer-Teck®, 10.4" GN, 1.5 gpm	ADA Blade	Chrome	
186017	27C2974-R5	8"ws, less Spray, Cer-Teck®, 6"Reach 10.4"H Spout, 1.0GPM	ADA Blade	Chrome	
034314	27T2933	8"ws, less Spray, Tuf-Teck®, 10.4" GNP, 1.5 gpm VR	ADA Lever Blade	Chrome	
086543	27C2943-R7	8"ws, less Spray, Cer-Teck®, 10.4" GN, 1.5 gpm VR	ADA Lever Blade	Chrome	
129492	27C2944-R7	8"ws, less Spray, Cer-Teck®, 9" GN, 1.5 gpm	ADA Blade	Chrome	
086283	27T2944-R7	8"ws, less Spray, Tuf-Teck®, 12.7" GN, 1.5 gpm	ADA Blade	Chrome	
126613	27C2945-R7	8"ws, less Spray, Cer-Teck®, 12.7" GN, 1.5 gpm	ADA Wrist Blade	Chrome	
137791	27C2954	8"ws, less Spray, Cer-Teck®, 10.4" GN, 0.5 gpm Non-Aerating	ADA Blade	Chrome	
141998	27C4142	4"cc, less Pop-Up, Cer-Teck®, 8" Swing Spout, 1.5 gpm	ADA Hooded Blade	Chrome	
125349	27C4242	4"cc, less Pop-Up, Cer-Teck®, 8" Tubular Swing Spout, 1.5 gpm	ADA Hooded Blade	Chrome	
136796	27C4244	4"cc, less Pop-Up, Cer-Teck®, 8" Tubular Swing Spout, 1.5 gpm	ADA Blade	Chrome	
125374	27C4263	4"cc, less Pop-Up, Cer-Teck®, 8" Tubular Swing Spout	ADA Lever Blade	Chrome	
138210	27C4323	4"cc, less Pop-Up, Cer-Teck®, 6" Tubular Swing Spout, 1.5 gpm	ADA Lever Blade	Chrome	
137627	27C4343	4"cc, less Pop-Up, Cer-Teck®, 6" Tubular Swing Spout, 1.5 gpm	ADA Lever Blade	Chrome	
094801	27C4842	4"cc, less Pop-Up, Cer-Teck®, 4.5" GN, 1.5 gpm	ADA Hooded Blade	Chrome	
096878	27C4854	4"cc, less Pop-Up, Cer-Teck®, 4.5" GN, 0.5 gpm	ADA Blade	Chrome	
166594	27C4874	4"cc, less Pop-Up, Cer-Teck®, 4.5" GN, 1.0 gpm	ADA Blade	Chrome	
114942	27C4844	4"cc, less Pop-Up, Cer-Teck®, 10.5" GN, 1.5 gpm	ADA Blade	Chrome	
151088	27C4922	4"cc, less Pop-Up, Cer-Teck®, 10.4" GN, 1.5 gpm	ADA Hooded Blade	Chrome	
099746	27C4924	4"cc, less Pop-Up, Cer-Teck® 10.4" GN, 1.5 gpm VR	ADA Blade	Chrome	
229388	27C4925	4"cc, less Pop-Up, Cer-Teck®, 10.4" GN Spout, VR 1.5 gpm	6" Wrist Blade	Chrome	
159485	27C4932	4"cc, less Pop-Up, Cer-Teck®, 10.4" GN Spout, VR 1.5 gpm	ADA Hooded Blade	Chrome	
166615	27C4934	4"cc, less Pop-Up, Cer-Teck®, 10.4" GN, 1.5 gpm	ADA Blade	Chrome	
146616	27C4935	4"cc, less Pop-Up, Cer-Teck®, 10.4" GN, 1.5 gpm VR	ADA Wrist Blade	Chrome	
109804	27C4943	4"cc, less Pop-Up, Cer-Teck®, 10.4" GN, 1.5 gpm	ADA Lever Blade	Chrome	
106041	27C4944	4"cc, less Pop-Up, Cer-Teck®, 10.4" GN, 1.5 gpm	ADA Blade	Chrome	
136549	27C4944-R7	4"cc, less Pop-Up, Cer-Teck®, 9" GN, 1.5 gpm	ADA Blade	Chrome	
129160	27C4952	4"cc, less Pop-Up, Cer-Teck®, 10.4" GN, 0.5 gpm VR Non-A	ADA Hooded Blade	Chrome	
138389	27C4965	4"cc, less Pop-Up, Cer-Teck®, 10.4" GN, Hose Outlet	ADA Wrist Blade	Chrome	
123421	27C4975	4"cc, less Pop-Up, Cer-Teck®, 10.4" GN, 1.1 gpm	ADA Wrist Blade	Chrome	
138001	27C5845	4"cc, w/Pop-Up, Cer-Teck®, 10.5" GN, 1.5 gpm	ADA Wrist Blade	Chrome	

Teck® Commercial 2-Hdl Wall-Mount Faucet

- Cast brass body
- Cer-Teck™ cartridges
- Hot/cold handle indicators
- 1.5 gpm Aerator

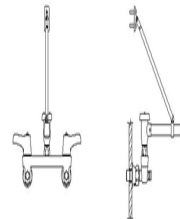

28C2384

Part #	Mfg #	Description	Handle(s)	Finish	Price
150511	28C2284	8"cc, w/Integral Stops, 10-1/2" Rigid Spout w/Pail Hook, Vac Breaker	ADA Blade	Chrome	
098109	28C2383	8"cc, w/Integral Stops, 10-1/2" Rigid Spout w/ Pail Hook, Vac Breaker	ADA Lvr Blade	Chrome	
124515	28C2384	8"cc, w/Integral Stops, Rigid Spout w/Pail Hook, Angle Vac Breaker	ADA Blade	Chrome	

* Brilliance® Anti-Tarnish Lifetime Finishes

www.waterconcepts.net • Serving our Customers Since 1946 • www.plumbsupply.com

Commercial - Institutional Faucets

Two-Handle Commercial Lavatory Faucets (Continued)

Teck® Commercial 2-Hdl Wall-Mount Faucet

Part #	Mfg #	Description	Handle(s)	Finish	Price
155835	28C2385	8"cc, w/Integral Stops, Rigid Spt w/ Pail Hook, ANgle Vac Breaker	ADA Wrist Blade	Chrome	
137763	28C2393	8"cc, w/Integral Stops, 10-1/2" Rigid Spt w/Pail Hook, Vac Breaker	ADA Lvr Blade	Chrome	
145704	28C2394	8"cc, w/Integral Stops, 10-1/2" Rigid Spt w/Pail Hook, Vac Breaker	ADA Blade	Chrome	
137793	28C2982	8"cc, w/Integral Stops, 16-1/2" Rigid Spt w/Pail Hook, Vac Breaker	ADA Hooded Blade	Chrome	
166691	28C2985	8"cc, w/Integral Stops, 16-1/2" Rigid Spt w/ Pail Hook, Vac Breaker	ADA Wrist Blade	Chrome	
142892	28C4424	8"cc, less Integral Stops, 11" Tubular Swing, 1.5 gpm VR Laminar	ADA Blade	Chrome	
128153	28C4433	8"cc, less Integral Stops, 11" Tubular Swing, 1.5 gpm VR Aerator	ADA Lever Blade	Chrome	
145606	28C6944	8"cc, w/Integral Stops, 10.4" GN, 1.5 gpm Aerator	ADA Blade	Chrome	

Teck® Commercial 2-Hdl Wall-Mount Service Sink Faucet

- Spout end vacuum breaker with garden hose end
- Includes 48" hose and stainless steel hanger



Part #	Mfg #	Description	Handle(s)	Finish	Price
127892	28T8073	8"cc, w/Integral Stops, Tuf-Teck®, Vac Breaker w/Hose	ADA Lever Blade	Chrome	

Bathroom Accessories - Commercial

20VA Hardwire Transformer

- 20VA Hardwire Transformer for up to 10 - 590, 590HDF or 860T series - or up to 5 - 3000T, 1500T, 590T, 591T, 590TP, 591TP, 1600T, 81THWA, DEMD, 600T, 630TP and 620TP Series, 110/24 VAC Class II



Part #	Mfg #	Description	Handle(s)	Finish	Price
133437	060704A	20VA Hardwire Transformer for up to 10			

40VA Hardwire Transformer

- 40VA
- 3000T, 1500T, 590T, 591T, 590TP, 591TP, 1600T, 81THWA, DEMD, 600T, 630TP, and 620TP
- 110/24 VAC Class II



Part #	Mfg #	Description	Handle(s)	Finish	Price
181330	060771A	40VA Hardwire Transformer for up to 10			

* Brilliance® Anti-Tarnish Lifetime Finishes

www.plumbsupply.com • Serving our Customers Since 1946 • www.waterconcepts.net

Commercial - Institutional Faucets

Faucets & Valves

100VA Hardwire Transformer

- 3000T, 1500T, 590T, 591T, 590TP, 591TP, 1600T, 81THWA, DEMD, 600T, 630TP, and 620TP Series
- 110/24 VAC Class II



Part #	Mfg #	Description	Handle(s)	Finish	Price
175104	060772A	100VA Hardwire Transformer for up to 25			

Plug-In Transformer



Part #	Mfg #	Description	Handle(s)	Finish	Price
074976	RP32856	Plug-In Transformer - Commercial			

20VA Hardwire Transformer



Part #	Mfg #	Description	Handle(s)	Finish	Price
071703	RP32508	20VA			

Ball Valve

- Two ball valves assembled at 180° in deckmount turret-assembled shank, brass locknut, raised lock washer for positive grip - vandal resistant locking pins on turret (can be removed in field if not required)

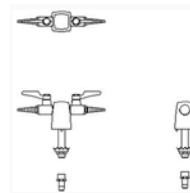

Part #	Mfg #	Description	Handle(s)	Finish	Price
166283	W6225AIR	Two ball valves in deck mount turret	-	-	

Recessed Paper Holder

- Brass body and roller - chrome plated
- Spring actuated roller
- Wood blocking is preferable behind all wall surfaces
- Mounting hardware and template included



Part #	Mfg #	Description	Handle(s)	Finish	Price
168051	45072	6-9/32"W x 6-9/32"H	-	Chrome	

* Brilliance® Anti-Tarnish Lifetime Finishes

www.waterconcepts.net • Serving our Customers Since 1946 • www.plumbsupply.com

Self-Closing Faucets

Two-Handle Self-Closing Commercial Lavatory Faucets

Teck® 86T Commercial 2-Hdl Metering Faucet

- 5-1/10" Reach
- Cast brass body
- Vandal-resistant handles
- Metering, slow-close lever style
- Red/blue indicators
- 2-3/8" Maximum deck thickness
- 0.5 gpm Vandal-resistant outlet
- No lift rod hole



Faucets & Valves

Part #	Mfg #	Description	Handle(s)	Finish	Price
036185	86T1153	2-Hole 4"cc	ADA Levers	Chrome	

HDF Commercial 2-Hdl Self-Closing Faucet

- 5" Reach spout
- 1-7/8" From deck to aerator
- Vandal resistant handles
- Metering, slow-close push style
- 1-3/8" Maximum deck thickness
- No lift rod hole
- 1/2" IPS shanks
- WaterSense Certified



Part #	Mfg #	Description	Handle(s)	Finish	Price
166354	2507LF-HDF	2- or 3-Hole 4"cc, Lead Free	Metering	Chrome	

One-Handle Self-Closing Commercial Lavatory Faucets

Teck® 87T Commercial 1-Hdl Metering Hand wash Faucet

- 5-2/5" Reach
- Cast brass body
- Metering slow close cartridge
- 2-1/2" Maximum deck thickness
- (87T105) Single outlet
- (87T111) Mixing tee and checks
- (2) Body-mounted stainless steel anti-rotation locking pins
- 0.5 gpm Vandal-resistant spout outlet



87T111

Part #	Mfg #	Description	Handle(s)	Finish	Price
114830	87T105	1-Hole	ADA Lever	Chrome	
123905	87T111	1-Hole	ADA Lever	Chrome	
122556	87T151	4"cc Cover Plate with Center Faucet Hole, (2) Hold Down Shanks -		Chrome	

* Brilliance® Anti-Tarnish Lifetime Finishes

www.plumbsupply.com • Serving our Customers Since 1946 • www.waterconcepts.net

Self-Closing Faucets

HDF Self-Closing Commercial Faucet

- 4-1/4" Rigid spout reach
- 1-1/2" From deck to aerator
- Vandal resistant handle
- Metering, self-close push style
- 1-1/8" max deck thickness
- Vandal resistant spray outlet
- 1/2" threaded male inlet shank



Faucets & Valves

Part #	Mfg #	Description	Handle(s)	Finish	Price
164453	701LF-HDF	1-Hole	Push	Chrome	

* Brilliance® Anti-Tarnish Lifetime Finishes

www.waterconcepts.net • Serving our Customers Since 1946 • www.plumbsupply.com

Commercial Shower Faucets

Commercial Tub & Shower Trim

Monitor® 13 Series Tub & Shower Trim

- For use with MultiChoice® universal rough-in valve
- Handle adjusts temperature
- Touch-Clean® showerhead
- Sweat onto 1/2" C.W.T. or thread onto 1/2" IPS
- WaterSense® certified: 2.0 gpm @ 80 psi



Part #	Mfg #	Description	Handle(s)	Finish	Price
149576	T13491	5-1/2" Pull-Up Div Spout	ADA Lever	Chrome	
173860	T13491-SSLHD	4-3/4" Pull-Up Div Spout, Less Showerhead	ADA Lever	Stainless*	

Classic Monitor® 13 Series Tub & Shower Trim

- For use with MultiChoice® universal rough-in valve
- Push-button diverter
- Handle adjusts temperature
- Slip onto 1/2" C.W.T.
- Removable threaded adapter for 1/2" IPS
- Touch-Clean® showerhead
- WaterSense® certified: 1.5 gpm @ 80 psi



Part #	Mfg #	Description	Handle(s)	Finish	Price
163324	T13691-SOS-15	4-3/4" Non-Div Spt, Push-Button Div on Trim	ADA Lever	Chrome	

Monitor® 13 Series Commercial 1-Hdl Tub & Shower Trim

- Fits MultiChoice™ universal valve
- Vandal-resistant blade handle
- Handle adjusts temperature
- Touch-Clean® showerhead
- Sweat onto 1/2" CWT or thread onto 1/2" IPS
- WaterSense® certified product
2.0 gpm @ 80 psi



Part #	Mfg #	Description	Handle(s)	Finish	Price
100907	T13490	Tub & Shower Trim, 5-1/2" Pull-Up Tub Spout	ADA Blade	Chrome	
095921	T13090	Trim Only with Pressure Balance Cartridge	ADA Blade	Chrome	

* Brilliance® Anti-Tarnish Lifetime Finishes

www.plumbsupply.com • Serving our Customers Since 1946 • www.waterconcepts.net

Commercial Shower Faucets

Brass Bent Showerarm

- Metal set screw wall flange



Part #	Mfg #	Description	Handle(s)	Finish	Price
225137	060710A	Brass bent Showerarm			

Teck® Commercial Tub&Shower Trim

Trim Only, Requires Valve: R10000-UNWS



Part #	Mfg #	Description	Handle(s)	Finish	Price
157956	T13H202	Valve Trim with Tub Spout, Less Showerhead	ADA Lever	Chrome	
163535	T13H252	Valve Trim w/ Tub Spout, 24" Slidebar w/HH 1.5gpm	ADA Lever	Chrome	
185508	T13H252-25	Valve Trim w/Tub Spout, 36" Slidebar w/HH 1.5gpm	ADA Lever	Chrome	
100914	T13H253	Valve Trim w/Tub Spout, 24" Slidebar w/HH 1.5gpm	ADA Lever Blade	Chrome	
185506	T13H282	Valve Trim w/Tub Spout, H2Okinetic® Shwrhead 1.5gpm	ADA Lever	Chrome	
187232	T13H283	Valve Trim w/Tub Spout, H2Okinetic® Shwrhead 1.5gpm	ADA Blade	Chrome	

Teck® Commercial Tub & Dual Shower Trim

Trim Only, Requires valve: R1000-UNWS

Part #	Mfg #	Description	Handle(s)	Finish	Price
166138	T13H932	Shower Trim, Div, HH on Slidebar, 1.5gpm Shwrhead	ADA Lever	Chrome	
179353	T13H962-20	Shower Trim, Div, HHw/ 69" Hose on Slidebar, VR 1.5gpm	ADA Lever	Chrome	

Teck® Commercial Thermostatic Tub & Shower w/ Diverter Valve for Dual Showers

- MultiChoice® universal thermostatic dual shower
- 3-Function showerhead, arm, and flange
- Metal lever volume control handle with temperature adjustment
- Showerhead flow rate: 2.0 gpm

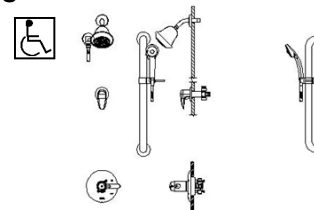

Requires R10700-UNWS Rough-In Valve

Part #	Mfg #	Description	Handle(s)	Finish	Price
173716	T17TH225	Shower Trim, Div, HH on 24" Slidebar 2.5 gpm	ADA Lever	Chrome	

* Brilliance® Anti-Tarnish Lifetime Finishes

www.waterconcepts.net • Serving our Customers Since 1946 • www.plumbsupply.com

Commercial Shower Faucets

30° Vandal Resistant Wall-Mount Showerhead

- Maximum flow rate: 1.5 gpm
- Forged Brass



Part #	Mfg #	Description	Handle(s)	Finish	Price
155676	063127A	Showerhead, Vandal Resistant 1.5 gpm	-	Chrome	

Commercial Shower Packages

Teck® MultiChoice® Universal Pressure Balance Shower Trim

- Heavy duty forged brass valve body
- Back-to-back capability, integral screwdriver stops
- 30° Vandal resistant cast wall mount showerhead



Requires R10000-UNWS Rough-In Valve



Part #	Mfg #	Description	Handle(s)	Finish	Price
166416	T13H162	Shower Trim w/ VR Showerhead 1.5 gpm	ADA Lever	Chrome	
108826	T13H163	Shower Trim w/ VR Showerhead 1.5 gpm	ADA Blade	Chrome	
164428	T13H152-05	Shower Trim w/ 36" Slidebar w/HH 1.5gpm	ADA Lever	Chrome	
179352	T13H152-20	Shower Trim w/ 24" Slidebar, 69" Hose w/HH 1.5gpm	ADA Lever	Chrome	
185374	T13H182	Shower Trim w/H2Okinetic® Showerhead 1.5gpm	ADA Lever	Chrome	
102894	T13H183	Shower Trim w/H2okinetic® Showerhead 1.5 gpm	ADA Blade Lever	Chrome	

Teck® MultiChoice® Universal Shower Package

- Integral checks in the cartridge prevent cross flow between Hot and Cold water inlets
- Non-Removable Blue/Red visual cover indicator for Cold, Mixing and Hot handle positions
- Standard 24" Stainless Steel Bar with ADA Slide handshower and shower diverter valve-backflow protection provided by two integral check valves in handshower
- Includes:
 - Dual shower trim
 - Diverter
 - Handshower
 - Grab bar
- Flow rate: 1.5 gpm @ 80 psi



Part #	Mfg #	Description	Handle(s)	Finish	Price
149708	T13H332	Shower Trim, Div, HH, 24" ADA Slidebar	ADA Lever	Chrome	
187744	T13H332-20	Shower Trim, Div, HH, 24" ADA Slidebar 69" Hose	ADA Lever	Chrome	
166745	T13H332-25	Shower Trim, Div, HH, 36" ADA Slidebar 69" Hose	ADA Lever	Chrome	
175425	T13H323-20	Shower Trim, Div, HH, 24"ADA SlideBar 69" Hose	ADA Blade	Chrome	

* Brilliance® Anti-Tarnish Lifetime Finishes

www.plumbsupply.com • Serving our Customers Since 1946 • www.waterconcepts.net

Commercial Shower Faucets

Commercial Shower Packages (Continued)

Teck® MultiChoice® Universal Shower Package

Part #	Mfg #	Description	Handle(s)	Finish	Price
179351	T13H362-20	Shwr Trim, Div, HH, 24" ADA Slidebar 69" Hose & VR SH 1.5gpm ADA Lever		Chrome	

Teck® MutliChoice® Universal Thermostatic Shower Trim

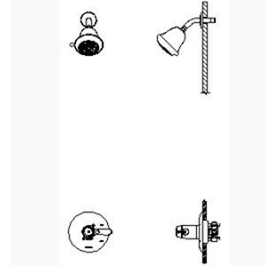

Part #	Mfg #	Description	Handle(s)	Finish	Price
160522	T17TH125	Thermo Trim, 2.0gpm 3-Function Showerhead	ADA Lever	Chrome	
228459	T17TH135	Thermo Trim, 2.0 gpm Touch-Clean® Showerhead	ADA Lever	Chrome	
153022	T17TH155	Thermo Trim, 2.5gpm HHw/ 24" Slidebar less Showerhead	ADA Lever	Chrome	
186759	T17TH305	Thermo Trim, 2.5gpm HH w/ 24" Slidebar NO fixed Shwrhd	ADA Lever	Chrome	
173005	T17TH325	Thermo Trim, 2.5gpm HHw/ 24" Slidebar Touch-Clean® SH	ADA Lever	Chrome	

Volume Control Valve with Integral Stop

- In-wall volume control valve
- WM rigid spout w/double check in-line vacuum breaker
br - spray holder
- Bedpan sprayer w/self-close stop and hose



Part #	Mfg #	Description	Handle(s)	Finish	Price
185314	54T-1254	Volume Control Valve, WM Rigid Spout & Bedpan Sprayer	-	Chrome	

Commercial Handshowers & Showerheads

Personal Handshower

- Single-function white handshower
- Push button on-off control
- Touch-Clean® spray holes
- ADA adjustable slide
- 24" Grab bar
- 60"-82" Stretchable metal hose
- 90° Wall supply elbow
- Backflow protection with 2 integral check valves in handshower
- Flow rate: 2.5 gpm @ 80 psi



Part #	Mfg #	Description	Handle(s)	Finish	Price
052226	RPW324HDF	Handshower, 24" Grab Bar Slide	-	White/Stainless	

* Brilliance® Anti-Tarnish Lifetime Finishes

www.waterconcepts.net • Serving our Customers Since 1946 • www.plumbsupply.com

Commercial - Lavatory

Single-Handle Commercial Lavatory Faucets

Coralais® Commercial 1-Hdl Lavatory Faucet with Plugged Lift Rod Hole

- 4-1/4" Reach spout
- Metal construction
- Flexible connections
- Red/blue indicator
- Vandal-resistant aerator



Part #	Mfg #	Description	Handle(s)	Finish	Price
226369	K-15199-4NDRA-CP	4"cc, Less Drain VR Aerator 1.5gpm	ADA Lever	Polished Chrome	

July™ Commercial 1-Hdl Lavatory Faucet

- 4-3/8" Reach spout
- Ceramic disc valves
- Temperature memory
- Vandal-resistant aerator
- Lift rod not included



Part #	Mfg #	Description	Handle(s)	Finish	Price
189089	K-97282-4-CP	.5 gpm, Less Drain	ADA Lever	Polished Chrome	
186393	K-97283-4-CP	.5 gpm, Grid Drain	ADA Lever	Polished Chrome	

Two-Handle Commercial Lavatory Faucets

Forte® Widespread Bathroom Sink Faucet with Pop-Up Drain and Sculpted Lever Handles

- 5-1/8" Reach spout
- Metal construction
- Vandal-resistant aerator
- Brass valve bodies
- Fluid design lines
- Red and blue index rings



Part #	Mfg #	Description	Handle(s)	Finish	Price
179824	K-10269-4-CP	8"cc, 2.2 gpm, Pop-Up Drain, Flexible Conn	ADA Lever	Polished Chrome	

Two-Handle Commercial Institutional Lavatory Faucets

Cannock™ Wash Sink Faucet

- 4" Reach spout with rose spray
- 8-3/8" wall-to-spout outlet
- Brass construction
- Valvet® valves
- Adjustable flanges



Part #	Mfg #	Description	Handle(s)	Finish	Price
05218	K-8892-RP	Wall Mount, Less Drain	ADA Lever	Rough Plate	

* Vibrant Limited Lifetime Warranty

www.plumbsupply.com • Serving our Customers Since 1946 • www.waterconcepts.net

Commercial - Lavatory

Faucets & Valves

Triton® Commercial Lavatory Faucet with Gooseneck Spout and 2 Wristblade Handles—Less Drain

- 5-1/4" Reach gooseneck spout
- Brass construction
- Standard aerator
- 1/4-Turn washerless ceramic disc valves
- Flexible connections unless stated



Part #	Mfg #	Description	Handle(s)	Finish	Price
094882	K-7305-5A-CP	4"cc, 1.5 gpm, Less Drain	ADA Wrist Blade	Polished Chrome	

Triton® Commercial 2-Hdl Lavatory Faucet with Pop-Up Drain and Aerator—Less Handles

- 5" Spout reach
- Brass construction
- 1/4-Turn washerless ceramic disc valves
- Flow rate: 2.0 gpm



Requires Handles: K-16012-2, K-16012-3, K-16012-4, or K-16012-5

Part #	Mfg #	Description	Handle(s)	Finish	Price
182512	K-7471-K-CP	8"-16"cc, Pop-Up Drain	Less Handles	Polished Chrome	

Triton® Shelf-Back Commercial 2-Hdl Lavatory Faucet

- 1-1/4" Spout reach
- Brass construction
- Valvet® valves
- Grid drain with tailpiece
- Flow rate: 2.0 gpm



Part #	Mfg #	Description	Handle(s)	Finish	Price
182519	K-8046-3A-CP	5-1/2"cc, Grid Drain with tailpiece	Cross Handles	Polished Chrome	
167211	K-8046-5A-CP	5-1/2"cc, Grid Drain with tailpiece	Wrist blade Handles	Polished Chrome	

Triton® Wall-Mount Valve Trim

- Push button diverters
- Cross handles
- Integral diverter mechanism



Requires valve K-303-K

Part #	Mfg #	Description	Handle(s)	Finish	Price
182397	K-T7751-3-CP	Push Button	Cross Handles	Polished Chrome	

* Vibrant Limited Lifetime Warranty

www.waterconcepts.net • Serving our Customers Since 1946 • www.plumbsupply.com

Commercial - Lavatory

Triton® Commercial 2-Hdl Widespread Lavatory Faucet with Gooseneck Spout—Less Drain and Handles

- 5-1/4" Reach spout
- Brass construction
- Flow rate: 2.0 gpm
- Rigid connections allows installation on 8" centers (K-7303-KC-CP) or 12" centers (7313-KE-CP)



Requires Handles: K-16012-2, K-16012-3, K-16012-4 or K-16012-5

Part #	Mfg #	Description	Handle(s)	Finish	Price
182510	K-7303-KC-CP	8"cc, Less Drain, 8" Connections & Rose Spray	Less Handles	Polished Chrome	
182511	K-7313-KE-CP	8"cc, Less Drain, 12" Connections	Less Handles	Polished Chrome	

Touchless™ Commercial Institutional Lavatory Faucets

Commercial Sculpted Touchless AC-Powered Lavatory Faucet with Insight™ Technology—Less Drain

- 5-3/4" Spout reach or 5" reach for (K-13461-CP)
- Brass construction
- Above-deck serviceable
- Vandal-resistant aerator
- 24" Flexible supplies
- Temperature mixer
—Not included with (K-13461-CP)
- Waterproof shroud protects electronic components



DC-Powered
Includes Two AAA Batteries

Part #	Mfg #	Description	Handle(s)	Finish	Price
127701	K-13460-CP	1-Hole, Mixer, DC, Includes (2) AAA Batteries		Polished Chrome	
131019	K-13461-CP	1-Hole, less Mixer, DC, Includes (2) AAA Batteries		Polished Chrome	

AC-Powered

Part #	Mfg #	Description	Handle(s)	Finish	Price
148859	K-13462-CP	1-Hole, Mixer, AC		Polished Chrome	
134611	K-13462-VS	1-Hole, Mixer, AC		*Stainless	

Cell-Powered by 30-Year Hybrid Energy System

Part #	Mfg #	Description	Handle(s)	Finish	Price
134202	K-7515-CP	1-Hole, Mixer, Hybrid with 30-Yr 3.6V Energy Cell		Polished Chrome	

* Vibrant Limited Lifetime Warranty

www.plumbsupply.com • Serving our Customers Since 1946 • www.waterconcepts.net

Commercial - Lavatory

Faucets & Valves

Geometric Touchless™ Commercial Lavatory Faucet with Insight™ Technology—Less Drain

- 6-3/4" Spout reach
- Brass construction
- Above-counter battery and valve
- Vandal-resistant aerator
- Factory set 30 second max continual run cycle
- Temperature mixer
—Not included with (K-13467-CP)
- Flow rate: .5 gpm
- Waterproof shroud protects electronic components



**DC-Powered
Includes Two AAA Batteries**

Part #	Mfg #	Description	Handle(s)	Finish	Price
178641	K-13466-VS	1-Hole, DC, (2) AAA Batteries		*Stainless	
185040	K-13467-CP	1-Hole, DC, (2) AAA Batteries		Polished Chrome	

**AC-Powered
Includes Two AAA Batteries**

Part #	Mfg #	Description	Handle(s)	Finish	Price
183004	K-13468-CP	1-Hole, AC, (2) AAA Batteries		Polished Chrome	
190187	K-13468-VS	1-Hole, AC, (2) AAA Batteries		*Stainless	

Powered by 30-Year Hybrid Energy Cell/System

Part #	Mfg #	Description	Handle(s)	Finish	Price
183148	K-7517-CP	1-Hole, Hybrid with 30-Yr 3.6V Energy Cell		Polished Chrome	

Gooseneck Touchless Commercial Lavatory Faucet with Insight™ Technology—Less Drain

- 6-3/16" Reach
- Brass construction
- 9" From deck to aerator
- 24" flexible supply hoses
- Includes temperature mixer
- Vandal-resistant aerator
- Above-counter battery and valve for easy installation and maintenance
- Waterproof shroud protects electronic components
- Flow Rate: 0.5 gpm



**DC-Powered
Includes Two AAA Batteries**

Part #	Mfg #	Description	Handle(s)	Finish	Price
148385	K-13472-CP	1-Hole, DC (2) AAA Batteries	-	Polished Chrome	

Powered by 30-Year Hybrid Energy Cell/System

Part #	Mfg #	Description	Handle(s)	Finish	Price
189288	K-7519-CP	1-Hole, Hybrid with 30-Yr 3.6V Energy Cell, 6-3/16" Reach		Polished Chrome	

* Vibrant Limited Lifetime Warranty

www.waterconcepts.net • Serving our Customers Since 1946 • www.plumbsupply.com

Commercial - Lavatory

Purist® Touchless™ Wall-Mounted Faucet Trim with 9" 90-Degree Spout and Insight™ Technology

- 9-1/8" Reach spout
- Brass construction
- Flow rate: 0.5 gpm



Requires: K-11830-NA Wall-Mount Valve

Part #	Mfg #	Description	Handle(s)	Finish	Price
182961	K-T11839-VS	2-Hole, Insight™ Technology		*Stainless	

Commercial Faucet Accessories

Escutcheon Round Plate for Insight™ Deck-Mount Faucet



Part #	Mfg #	Description	Handle(s)	Finish	Price
130091	K-13478-A-CP	4"		Polished Chrome	
161694	k-13478-A-VS	4"		*Stainless	

Touchless™ Round AC Valve and Sensor Kit

- Required for Purist® and Falling Water® wall-mount Touchless™ faucets
- Insight™ adaptive infrared technology
- 0.5 gallons per minute flow rate



Part #	Mfg #	Description	Handle(s)	Finish	Price
182999	K-11843-NA	AC Power Supply		N/A	

AC Single Supply - Touchless Faucet

- Single supply power cord plugs into any global outlet
- Intended for use with all insight AC-powered deck- and wall-mount touchless faucets



Part #	Mfg #	Description	Handle(s)	Finish	Price
134610	K-13480-NA	AC Single Supply			

* Vibrant Limited Lifetime Warranty

www.plumbsupply.com • Serving our Customers Since 1946 • www.waterconcepts.net

Commercial - Institutional Faucets

Faucets & Valves

Electronic Lavatory Faucets

M-Power Sensor-Operated Lavatory Faucet

- One piece, cast brass
- Flexible stainless steel supply lines
- Vandal resistant below-deck box with included mounting hardware
- Touch free operation with sensor activation distance from 3" to 12"
- Vandal mode: 30 second time-out feature
- Sentinel flow: eliminates stagnant water supply lines every 24 hours
- Metering mode feature: adjustable run time from 10 to 180 seconds
- Battery 4(AA) with AC compatibility
- Battery life: up to 8 years (typical alkaline battery life at 150 uses per day)
- Flow rate: 0.5 gpm vandal-resistant multi-stream laminar flow



Part #	Mfg #	Description	Handle(s)	Finish	Price
187317	CA8301	4"cc, 3-Hole	Sensor	Chrome	

M-Power Sensor-Operated Lavatory Faucet

- Two piece clamshell design
- Flexible stainless steel supply lines
- Vandal mode: 30 second time-out feature
- Sentinel flow: eliminates stagnant water in supply lines every 24 hours
- Maintenance/Cleaning Mode: Allows for a 30 second deactivation for maintenance or cleaning
- Battery 4(AA) or AC powered
- Battery life: Up to 6 years or 350,000 cycles
- In-line filters included
- Flow rate: 0.5 gpm vandal-resistant multi-stream laminar flow



Part #	Mfg #	Description	Handle(s)	Finish	Price
181563	8551AC	1-Hole, Modern Desing	Sensor	Chrome	

Single-Handle Lavatory Faucets

M-Dura 1-Hdl Lavatory Faucet

- Solid brass construction
- Chrome finish
- 1/2" IPS connections
- Solid brass waterways
- 6" Lever handle w/red and blue temperature indicators
- 110° arc of handle
- Flow rate: 2.2 gpm
0.5 gpm (8416F05)



Part #	Mfg #	Description	Handle(s)	Finish	Price
115759	8416	4"cc, 2- or 3-Hole	ADA Lever	Chrome	
214929	8416F05	4"cc, 2- or 3-Hole	ADA Lever	Chrome	

*Lifeshine® Anti-Tarnish Lifetime Finish

www.waterconcepts.net • Serving our Customers Since 1946 • www.plumbsupply.com

Commercial - Institutional Faucets

M-Dura 1-Hdl Lavatory Faucet

- Solid brass construction
- Chrome finish
- 1/2" IPS connections
- Solid brass waterways
- 110° arc of handle
- Flow rate: 2.2 gpm



Part #	Mfg #	Description	Handle(s)	Finish	Price
095264	8413	4"cc, 2- or 3-Hole	ADA Lever	Chrome	

M-Biton 1-Hdl Lavatory Faucet

- Metal construction
- 1/2" IPS connections or flex supply lines (3/8" compression fittings)
- 1255™ Duralast™ cartridge
- Flow rate: 1.5 gpm



Part #	Mfg #	Description	Handle(s)	Finish	Price
194164	8430	4"cc, 3-Hole Less Drain, 1/2" IPS	ADA Lever	Chrome	
190348	8439	4"cc, 3-Hole Less Drain, Flexible Supplies	ADA Lever	Chrome	

M-Press 1-Hdl Metering Lavatory Faucet

- Brass construction
- Designed to deliver either tempered or ambient water
- Vandal resistant
- Optional 4" deck plate sold separately (99551)
- Cycle time adjusts 5 to 60 seconds
- Operates with water supply line pressures of 20 to 125 psi
- Factory preset to automatically shut off after 10 seconds
- Flow rate: 0.5 gpm vandal resistant multi-stream laminar flow



Part #	Mfg #	Description	Handle(s)	Finish	Price
187765	8894	1-Hole, 1/2" IPS	Metering	Chrome	

M-Press 1-Hdl Metering Lavatory Faucet

- 6" Reach, 3-3/4" high spout
- 2-1/8" From deck to aerator
- Solid brass construction
- Vandal resistant
- Optional 4" deck plate available, 99550
- Flow rate: 0.5 gpm



Part #	Mfg #	Description	Handle(s)	Finish	Price
195911	8884	1-Hole, 1/2" IPS	Metering	Chrome	

*Lifeshine® Anti-Tarnish Lifetime Finish

www.plumbsupply.com • Serving our Customers Since 1946 • www.waterconcepts.net

Commercial - Institutional Faucets

Faucets & Valves

Two-Handle Lavatory Faucets

M-Press 2-Hdl Metering Lavatory Faucet

- 4-3/4" Spout reach, 3-3/4" spout height
- Heavy-duty, vandal resistant
- 1/2" IPS
- Drain NOT included
- Flow rate: 0.5 gpm



Part #	Mfg #	Description	Handle(s)	Finish	Price
007356	8886	2- or 3-Hole	Metering	Chrome	

M-Biton Commercial 2-Hdl Lavatory Faucet

- 6-11/64" Spout Reach
- 2-9/32" From deck to aerator
- 1/2" IPS connections
- Vandal resistant screws
- 1224 Cartridge design
- 4" Wrist blade style handles
- Flow rate: 1.2 gpm
0.5 gpm (8800F05)



Part #	Mfg #	Description	Handle(s)	Finish	Price
030085	8800	2- or 3-Hole, Less Drain	Wrist Blade	Chrome	
215924	8800F05	2- or 3-Hole, Less Drain	Wrist Blade	Chrome	
193737	8820	2- or 3-Hole, Metal Pop-Up Drain	Wrist Blade	Chrome	

B-Biton Commercial Medium-Duty 2-Hdl Lavatory Faucet

- 6-11/64" Spout reach, 3-11/32" spout height
- 2-9/32" From deck to aerator
- 1/2" IPS
- Vandal resistant screws
- Drain NOT included
- Flow rate: 1.2 gpm



Part #	Mfg #	Description	Handle(s)	Finish	Price
155636	8915	2- or 3-Hole, Less Drain	ADA Lever	Chrome	
156059	8218	2- or 3-Hole, Grid Drain	ADA Lever	Chrome	

*Lifeshine® Anti-Tarnish Lifetime Finish

www.waterconcepts.net • Serving our Customers Since 1946 • www.plumbsupply.com

Commercial - Institutional Faucets

M-Biton Commercial 2-Hdl Clinic Faucet

- 4-3/4" Spout reach, 8-7/8" high spout
- 5-1/8" From deck to aerator
- 1/2" IPS connections
- Vandal resistant screws
- 1224 Cartridge design
- Flow rate: 1.2 gpm



Part #	Mfg #	Description	Handle(s)	Finish	Price
148053	8948	2- or 3-Hole	ADA Blade	Chrome	

M-Biton Commercial 2-Hdl Clinic Faucet

- 4-9/16" Spout reach, 10-1/2" high spout
- 7-1/8" From deck to aerator
- 1/2" IPS connections
- Vandal resistant screws
- 1224 Cartridge design
- Flow rate: 1.2 gpm



Part #	Mfg #	Description	Handle(s)	Finish	Price
007358	8938	2- or 3-Hole	ADA Blade	Chrome	

M-Biton Commercial 2-Hdl Pantry Faucet



Part #	Mfg #	Description	Handle(s)	Finish	Price

M-Dura Commercial 2-Hdl Lavatory Faucet

- 5-1/2" Spout reach, 4-1/2" spout height
- 2-7/8" From deck to aerator
- 1/2" IPS
- Vandal resistant aerator
- Drain NOT included
- Flow rate: 2.2 gpm



Part #	Mfg #	Description	Handle(s)	Finish	Price
136369	8210	2-Hole, Less Drain	ADA Lever	Chrome	
198811	8215	2-Hole, Less Drain	ADA Blade	Chrome	

*Lifeshine® Anti-Tarnish Lifetime Finish

www.plumbsupply.com • Serving our Customers Since 1946 • www.waterconcepts.net

Commercial - Institutional Faucets

Faucets & Valves

M-Dura Commercial 2-Hdl Clinic Faucet

- 3-5/8" Spout reach, 9-1/2" high spout
- 6-1/4" From deck to aerator
- 1/2" IPS connections
- Vandal resistant laminar flow aerator
- Flow rate: 1.2 gpm



Part #	Mfg #	Description	Handle(s)	Finish	Price
199920	8278	2- or 3-Hole	ADA Blade	Chrome	

Commercial Kitchen Faucets

M-Dura 1-Handle Commercial Brass Kitchen Faucet

- 9" Reach spout
- 3/8" Compression connection
- 22" Stainless steel supply lines
- Adjustable temperature limit stops
- Aerator is limited to 2.2 gpm Maximum
- Solid brass construction
- Optional 8" deck plate



Part #	Mfg #	Description	Handle(s)	Finish	Price
146800	8701	1- or 3-Hole	ADA Lever	Chrome	

M-Biton 2-Hdl Kitchen Faucet

- 8-3/4" Spout reach, 12-1/2" high
- 9-1/2" From deck to aerator
- 1/2" IPS connections
- Vandal resistant screws
- 4" Wrist blade handles
- 1224 Cartridge desing
- Flow rate: 1.5 gpm



Part #	Mfg #	Description	Handle(s)	Finish	Price
017161	8799	3-Hole	ADA Wrist Blade	Chrome	

M-Biton 2-Hdl Kitchen Faucet

- 8-1/2" Reach, 13" high spout
- 9-1/2" From deck to aerator
- 1/2" IPS connections
- Vandal resistant screws
- 1224 Cartridge
- Flow rate: 1.5 gpm



Part #	Mfg #	Description	Handle(s)	Finish	Price
089246	8792	3-Hole	ADA Lever	Chrome	

*Lifeshine® Anti-Tarnish Lifetime Finish

www.waterconcepts.net • Serving our Customers Since 1946 • www.plumbsupply.com

Commercial - Institutional Faucets

M-Dura 2-Hdl Kitchen Faucet

- 8" Reach, 13-1/4" high spout
- 1/2" IPS connections
- Vandal resistant torx head screws
- 4" Wrist blade handles
- Flow rate: 2.2 gpm



Part #	Mfg #	Description	Handle(s)	Finish	Price
199719	8225	3-Hole	ADA Lever	Chrome	
116521	8289	2- or 3-Hole	ADA Wrist Blades	Chrome	

M-Dura 1-Hdl Multi-Purpose Faucet

- 6-3/4" Spout reach, 10-3/4" high spout
- 5-3/4" From deck to aerator
- 3/8" Compression connection x 24" braided polymer supply lines
- 1255™ Duralast™ cartridge
- Flow rate: 1.5 gpm



Part #	Mfg #	Description	Handle(s)	Finish	Price
207904	8138	3-Hole with Side Spray	ADA Lever	Chrome	

Service Sink Faucets

M-Dura 2-Hdl Wall-Mount Service Sink Faucet

- 9.38" Spout reach
- 1/2" Eccentric IPS connections
- Solid brass construction
- Vandal resistant torque screw
- Heavy-duty 1/4 turn ceramic disc cartridge
- Drain NOT included



Part #	Mfg #	Description	Handle(s)	Finish	Price
110751	8230	2-Hole Centerset, Wall-Mount	ADA Lever	Rough Chrome	

M-Dura 2-Hdl Wall-Mount Service Sink Faucet

- 10-1/4" Reach
- 1/2" IPS connections
- Brass construction
- Vacuum-breaker spout with garden hose thread
- Integral check stops
- With service stops
- Unrestricted flow



Part #	Mfg #	Description	Handle(s)	Finish	Price
027795	8124	2-Hole Centerset, Wall-Mount	ADA Lever	Chrome	

*Lifeshine® Anti-Tarnish Lifetime Finish

www.plumbsupply.com • Serving our Customers Since 1946 • www.waterconcepts.net

Commercial - Institutional Faucets

Faucets & Valves

M-Dura 2-Hdl Wall-Mount Service Sink Faucet

- 12" Spout Reach
- 1/2" IPS connections
- Ceramic disc cartridge
- Flow rate: 1.5 gpm



Part #	Mfg #	Description	Handle(s)	Finish	Price
201039	8119	2-Hole Centerset, Wall-Mount	ADA Lever	Chrome	

Shower Trim

Commercial Posi-Temp® Shower Trim

- Heavy-duty brass
- 1222hd Cartridge design



Valve sold separately

Part #	Mfg #	Description	Handle(s)	Finish	Price
215321	T8375EP15	Shower Trim, 1/2" IPS, 1.5 gpm	ADA Lever	Chrome	
131233	8375	Shower Trim w/ Stops, 1/2" CC. 2.5 gpm	ADA Lever	Chrome	
034791	8370	Valve Trim Only. 1/2"	ADA Lever	Chrome	

Commercial Moentrol® Shower Trim

- 1/2" connections
- 1225™ Cartridge
- Check stops



Part #	Mfg #	Description	Handle(s)	Finish	Price
187826	8350	Valve Trim Only	ADA Lever	Chrome	

Commercial Posi-Temp Shower Trim

- Metal construction
- Pressure balancing cycle valve design with 1/4 turn stops
- 1/2" CC connections
- Includes:
 - 3-Function transfer valve
 - Showerhead
 - Handheld Shower
 - 30" Slidebar (NOT to be used as a grab bar)
 - Drop Elbow
 - 69" Metal Hose
 - Mounting hardware
- Flow rate: 1.5 gpm



Part #	Mfg #	Description	Handle(s)	Finish	Price
211636	T8342EP15	Includes T8342EP15 + 8371HD + 3360	ADA Lever	Chrome	

*Lifeshine® Anti-Tarnish Lifetime Finish

www.waterconcepts.net • Serving our Customers Since 1946 • www.plumbsupply.com

Commercial - Institutional Faucets

Shower Trim (Continued) Commercial Posi-Temp Shower Trim

Part #	Mfg #	Description	Handle(s)	Finish	Price
170267	8342EP15	Transfer Shower Only	ADA Lever	Chrome	

Commercial Posi-Temp Shower Valve and Handshower

- Metal construction
- Pressure balancing cycle valve design with 1/4 turn stops
- Includes:
 - Handheld Shower
 - 30" Slidebar (NOT to be used as a grab bar)
 - Drop Elbow
 - 69" Metal Hose
 - Mounting hardware
- Flow rate: 2.5 gpm



8346



T9346

Faucets & Valves

Part #	Mfg #	Description	Handle(s)	Finish	Price
089332	8346	Shower Valve w/ HH Shower on 30" Slidebar	ADA Lever	Chrome	
233875	T9346	Shower Valve w/ HH Shower on 30" Slidebar	ADA Lever	Chrome	

Commercial Slidebar/ Grabbar Shower Trim

- Handshower includes integral double check valves
- Single-setting handshower
- 69" Hose
- Flow rate: 2.5 gpm



Part #	Mfg #	Description	Handle(s)	Finish	Price
229215	52224GBM25	Stainless Grabbar Slide w/Handshower	-	Chrome/Stainless	

Tub & Shower Trim

Commercial Posi-Temp® Tub & Shower Trim

- Pressure balancing cycle valve design with 1/4 turn stops
- 1/2" CC connections
- Shower arm has 1/2" IPS male threads
- Diverter spout is 1/2" CC slip-fit design
- Vandal resistant screws
- Vandal resistant shower head
- 1255HD Brass cartridge design
- Flow rate: 2.5 gpm



Part #	Mfg #	Description	Handle(s)	Finish	Price
216680	8389	Tub & Shower Trim	ADA Lever	Chrome	

*Lifeshine® Anti-Tarnish Lifetime Finish

www.plumbsupply.com • Serving our Customers Since 1946 • www.waterconcepts.net

Commercial - Institutional Faucets

Faucets & Valves

Single-Handle Kitchen Faucets

Adapt-Faucet 1-Hdl Kitchen Faucet

- 9-1/2" L-Type swing spout
- Solid brass body construction
- Fits 1-1/16"-18 UNEF male body outlet
- 3/8" FNPT Outlet
- Mounting hardware included



Part #	Mfg #	Description	Handle(s)	Finish	Price
090794	613-ACP	1-Hole, Quatern™ Cartridge, E1 Aerator	ADA 369 Lever	CP	

Adapta-Faucet 1-Hdl Kitchen Faucet

- 14" Swing type spout
- Full flow outlet
- 1-1/16"-18 UNEF Female thread inlet
- 3/8" NPT Female outlet in tee



Part #	Mfg #	Description	Handle(s)	Finish	Price
127917	613-AL15E1CP	1-Hole, Quatern™ Cartridge, L13 Spout	ADA 369 Lever	CP	

Pot Fillers

Wall-Mount Pot Filler

- 18" Double-jointed swing spout
- Solid brass body construction
- 1/2" FNPT Inlet with integral wall flange
- Secondary full-flow control valve with heat resistant lever handle
- Mounting hardware included
- Handles indexed hot and cold



Part #	Mfg #	Description	Handle(s)	Finish	Price
031697	515-CP	1-Hole, Quatern™ Cartridge, E31 Control Valve	ADA 369 Lever	CP	

Two-Handle Sink Faucets

50 Series 2-Hdl Deck-Mount Sink Faucet

- Solid brass body construction
- 3/8" OD Copper supply tubes
- Mounting hardware included
- Handles indexed hot and cold



Part #	Mfg #	Description	Handle(s)	Finish	Price
002890	50-CP	1-Hole, Quatern™ Cartridge, E3 Aerator, GN2A Spout	ADA 369 Lever	CP	

* ForeverShine™ PVD Finish

www.waterconcepts.net • Serving our Customers Since 1946 • www.plumbsupply.com

Commercial - Institutional Faucets

895 Series 2-Hdl Deck-Mount Sink Faucet

- 1/2" NPSM Supply inlet with coupling nut for 3/8" or 1/2" flexible riser
- Solid brass body construction
- Mounting hardware included
- Handles indexed hot and cold



Part #	Mfg #	Description	Handle(s)	Finish	Price
002945	895-317CP	4"cc, Quatum™ Cartridge, E3 Aerator, GN1A Spout	ADA 317 Wrist Blade	CP	
082264	895317E2805-5CP	4"cc, Quatum™ Cartridge, E2805-5 Aerator, GN1A Spout	ADA 317 Wrist Blade	CP	
023775	895-LESSSPTCP	4"cc, Quatum™ Cartridge, less Spout	ADA 317 Wrist Blade	CP	

786 Series 2-Hdl Deck-Mount Sink Faucet

- 5-1/4" Rigid/swing gooseneck spout
- Solid brass body construction
- 1/2" NPSM Supply inlets with coupling nut for 3/8" or 1/2" flexible risers
- Mounting hardware included
- Handles indexed hot and cold



Part #	Mfg #	Description	Handle(s)	Finish	Price
002918	786-E3CP	8"cc, Quatum™ Cartridge E3 Aerator, GN2A Spout	ADA 317 Wrist Blade	CP	

815 Series 2-Hdl Wall-Mount Flushing Rim Sink Faucet

- 7-1/8" Rigid spout with pipe support
- Solid brass body construction
- "R" Adjustable 1/2" FNPT supply arms with integral service stop
- 3/4" Male hose thread outlet
- Mounting hardware included



Part #	Mfg #	Description	Handle(s)	Finish	Price
064156	815-VBCP	8"-13"cc, Quatum™ Cartridge, Pail Hook, 815-SVB Spout	ADA 319 Elbow Blade	CP	

2-Hdl Wall-Mount Sink Faucet

- 1/2"-14 NPT Male thread inlets



Part #	Mfg #	Description	Handle(s)	Finish	Price
123339	521-LESSSPTCP	4"cc, Quatum™ Cartridge	ADA 369 Lever	CP	

* ForeverShine™ PVD Finish

www.plumbsupply.com • Serving our Customers Since 1946 • www.waterconcepts.net

Commercial - Institutional Faucets

Service Sink Faucets

835 Series 2-Hdl Wall-Mount Service Sink Faucet

- Solid brass body construction
- Pail hook and wall brace
- Vacuum breaker spout
- 1/2" FNPT Inlets supplied from the top
- Mounting hardware included
- Handles indexed hot and cold



Part #	Mfg #	Description	Handle(s)	Finish	Price
002932	835-CP	6"cc, Quatern™ Cartridge	633 Cross	CP	
017992	835-RCF	6"cc, Quatern™ Cartridge	633 Cross	RCF	

445 Series 2-Hdl Wall-Mount Service Sink Faucet

- Solid brass body construction
- 2-1/2" Offset inlet supply arm with 1/2" FNPT thread inlet
- Mounting hardware included
- Handles indexed hot and cold



Part #	Mfg #	Description	Handle(s)	Finish	Price
023770	445-LESSSPTCP	4"-8-3/8"cc, Quatern™ Cartridge, E3 Aerator, less Spout	ADA 369 Lever	CP	

540 Series 2-Hdl Wall-Mount Exposed Service Sink Faucet

- Solid brass body construction
- 3/8" Offset inlet supply arm with 1/2" FNPT thread inlet
- Loose wall flange
- Handles indexed hot and cold



540-LD



540-LDLESSSPT



Part #	Mfg #	Description	Handle(s)	Finish	Price
002895	540-LDCP	7-1/4"-8-3/4"cc, Quatern™ Cartridge, E3 Aerator, S6 Spout	ADA 369 Lever	CP	
023771	540-LDLESSSPTCP	7-1/4"-8-3/4"cc, Quatern™ Cartridge, less Spout	ADA 369 Lever	CP	

897 Series 2-Hdl Wall-Mount Exposed Service Sink Faucet

- With vacuum breaker spout
- Pail hook and wall brace
- Solid brass body construction
- Adjustable 1/2" FNPT supply arms
- 3/4" Male hose thread outlet
- Mounting hardware included
- Handles indexed hot and cold



Part #	Mfg #	Description	Handle(s)	Finish	Price
002949	897-CP	7-5/8"-8-3/4"cc, Quatern™ Cartridge, 897 VB Spout	ADA 369 Lever	CP	
002950	897-RCF	7-5/8"-8-3/4"cc, Quatern™ Cartridge, 897 VB Spout	ADA 369 Lever	RC	

* ForeverShine™ PVD Finish

www.waterconcepts.net • Serving our Customers Since 1946 • www.plumbsupply.com

Commercial - Institutional Faucets

Pre-Rinse Faucets

2-Hdl Deck-Mount Pre-Rinse Spray

- 44" Stainless steel flexible hose with insulated handle
- 23" Spring guide riser
- Integrated pipe support and hook assembly
- 1.0 gpm @ 60 psi Spray valve water conserving pre-rinse



Part #	Mfg #	Description	Handle(s)	Finish	Price
104242	919-SLCP	1-Hole, Quatern™ Cartridge, 90L Valve	less Hdl	CP	

* ForeverShine™ PVD Finish

www.plumbsupply.com • Serving our Customers Since 1946 • www.waterconcepts.net

Commercial - Institutional Faucets

Faucets & Valves

Single-Handle Lavatory Faucets

1-Hdl Deck-Mount Lavatory Faucet with 5-1/4" Rigid/Swing Spout

- Single water inlet
- Solid brass body construction
- 1/2" NPSM Coupling nut for 3/8" or 1/2" flexible riser
- Mounting hardware included
- Cold indexed handle



Part #	Mfg #	Description	Handle(s)	Finish	Price
002875	350-CP	1-Hole, Quatum™ Cartridge, E3 Aerator	ADA 369 Lever	CP	

1-Hdl Deck-Mount Lavatory Faucet with 4-5/8" Cast Brass Spout

- 1/2" NPSM Supply inlets for 3/8" or 1/2" flexible riser
- Mounting hardware included



Part #	Mfg #	Description	Handle(s)	Finish	Price
131091	420-CP	4"cc, Ceramic Mixing Cartridge, 1.5 gpm Non-Aerating Outlet	ADA Lever	CP	

Marathon™ 1-Hdl Deck-Mount Lavatory Faucet with 4-3/4" Cast Brass Spout

- Solid brass body construction
- 3/8" OD Copper supply tube inlets
- Temperature limit stop
- Mounting hardware included
- Volume control



Part #	Mfg #	Description	Handle(s)	Finish	Price
073566	2200-CP	1-Hole, Ceramic Mixing Cartridge, E12 Aerator	ADA Lever	CP	

Metering Lavatory Faucets

1-Hdl Deck-Mount Metering Lavatory Faucet with 3-3/8" Spout

- Solid brass body construction
- 1/2" NPSM Coupling nut for 3/8" or 1/2" flexible riser
- Mounting hardware included



Part #	Mfg #	Description	Handle(s)	Finish	Price
095047	333-665PSHCP	1-Hole, MVP™ Metering Adj Cycle Time Cartridge, E12 Aerator	MVP™ ADA 665 Push-Button	CP	

Commercial - Institutional Faucets

Electronic Lavatory Faucets

E-Tronic® 40 Sink Faucet

- Dual beam infrared sensor
- 6V Lithium CRP2 battery included
- Geberit Commander™ software compatible
- Replaces 116.606.21.1



Part #	Mfg #	Description	Handle(s)	Finish	Price
139528	116.606.AB.1	1-Hole, Dual Beam Infrared Sensor, Vandal Proof Spray	Electronic Sensor	CP	

Commercial - Institutional Faucets

Inside Sill Fittings

Wall-Mount Inside Sill Fitting with Vacuum Breaker Spout

- Solid brass body construction
- Atmospheric vacuum breaker spout
- Mounting hardware included



Part #	Mfg #	Description	Cartridge	Finish	Price
002958	952-CP	1-Hole, 3/4" FNPT Thread Inlet, Slow Compression Cartridge	293-6 Loose Key	CP	

Wall-Mount Inside Sill Fitting

- Solid brass body construction
- Mounting hardware included
- Slow Compression Cartridge 293-6 Loose Key



Part #	Mfg #	Description	Cartridge	Finish	Price
002853	293-CP	1-Hole, 1/2" FNPT Thread Inlet, 3/4" Male Hose Thread Outlet			

Commercial

Commercial Faucets

Hands-Free® Electric Scrub and Handwash Deck-Mount Faucet

- 5-5/8" Reach, 11-5/8" spout height
—Gooseneck spout
- 7-5/16" Deck clearance
- Sensor Operated
- Solid brass construction
- Electronic control module valve
- Vandal-resistant and water-resistant sensor control module
- Dual power AC and battery
- Adjustable sensor range
- Adjustable shut-off delay and time-out feature
- Maximum flow rate: 2.0 gpm
- NSF/ANSI 61 certified



Faucets & Valves

Part#	Mfg#	Description	Handle(s)	Finish	Price
168437	LKB721C	1-Hole, No Spray Type	Hand-Free®	Chrome	

Hands-Free® Electric Scrub and Handwash Wall-Mount Faucet

- 7-1/2" Reach, 10-7/8" spout height
—Gooseneck spout
- 6-5/8" Deck clearance
- Sensor Operated
- Solid brass construction
- Electronic control module valve
- Vandal-resistant and water-resistant sensor control module
- Dual power AC and battery
- Adjustable sensor range
- Adjustable shut-off delay and time-out feature
- Maximum flow rate: 2.0 gpm
- NSF/ANSI 61 certified



Part#	Mfg#	Description	Handle(s)	Finish	Price
144630	LKB722C	1-Hole, No Spray Type	ADA Hands Free	Chrome	

Commercial

Faucets & Valves

4" Centerset 2-Hdl Scrub/Handwash Faucet with Exposed Deck and High Arc Spout

- 8" Reach, 9" spout height
- Solid brass construction
- Choice of 3 handle options and 4 spout styles
- 1/2" NPSM male inlet shanks
- 6-1/2" Deck clearance
- Quarter turn ceramic disc cartridge
- Adjustable mounting up to 4" spread
- Includes spout swing restriction pin
- Replacement cartridge (45923C) for cold and (45924C) for hot
- NSF/ANSI 61 certified
- 2.2 gpm vandal-resistant aerator standard with 1.5 and .5 gpm insert included



Part #	Mfg #	Overall Size	Holes	Depth	Drain Opening	Price
181024	LK406HA08T6	2-Hole, No Spray Type	6"ADA Wristblade	Chrome		

2-Hdl Scrub/Handwash Wall-Mount Faucet

- 3-1/2" reach, 8" spout height
- 5-3/8" Deck clearance
- 1/2"-14 NPSM
- NSF/ANSI 61 certified
- Maximum flow rate: 2.2 gpm



Part #	Mfg #	Overall Size	Holes	Depth	Drain Opening	Price
168267	LKB400	2-Hole, No Spray	2" Lever	Chrome		

8" Centerset Faucet with Concealed Deck & Gooseneck Spout

- 5" Reach, 8" spout height
- Solid brass construction
- Choice of 3 handle options and 4 spout styles
- 3/8" Female compression hose assembly
- 5-1/2" Deck clearance
- Quarter turn ceramic disc cartridge
- Adjustable mounting up to 8" spread
- Includes spout swing restriction pin
- Replacement cartridge (45923C) for cold and (45924C) for hot
- NSF/ANSI 61 certified
- 2.2 gpm vandal-resistant aerator standard with 1.5 and .5 gpm insert included



Part #	Mfg #	Overall Size	Holes	Depth	Drain Opening	Price
167994	LK800GN05T4	3-Hole, No Spray Type	ADA 4" Wristblade	Chrome		
175742	LK800GN05T6	3-Hole, No Spray Type	ADA 6" Wristblade	Chrome		
179345	LK800GN05L2	3-Hole, No Spray Type	ADA 2" Lever	Chrome		

Commercial

8" Centerset 2-Hdl Scrub & Handwash Faucet with Gooseneck Spout

- 5-1/8" Reach, 11" spout height
- Solid brass construction
- Choice of 3 handle options
- 1/2" NPT female inlets
- 7-3/8" Deck clearance
- Quarter turn ceramic disc valve
- 8" Faucet hole spread
- Includes spout swing restriction pin
- Replacement cartridge (45923C) for cold and (45924C) for hot
- Optional external shut-off valve available
- NSF/ANSI 61 certified
- 2.2 gpm vandal-resistant aerator standard with 1.5 and .5 gpm insert included



Faucets & Valves

Part #	Mfg #	Overall Size	Holes	Depth	Drain Opening	Price
177337	LK940GN04L2H	2-Hole, No Spray	ADA 2" Lever	Chrome		
151707	LK940GN05T4S	2-Hole, No Spray	ADA 4" Wristblade	Chrome		
186326	LK940GN05T6H	2-Hole, No Spray	ADA 6" Wristblade	Chrome		

8" Centerset Foodservice Faucet with Arc Tube Spout

- 10" reach, 6-13/16" spout height
- Solid brass construction
- Choice of 3 handle options: 2" lever and 4" or 6" wristblade
- Quarter turn ceramic disc valve
- 1/2" NPT female inlets
- 4-3/16" Deck clearance
- Includes spout swing restriction pin
- Replacement cartridge 45923C for cold and 45924C for hot
- 8" Faucet hole spread
- NSF/ANSI 61 certified
- 2.2 gpm vandal-resistant aerator standard with .5 gpm insert included



Part #	Mfg #	Overall Size	Holes	Depth	Drain Opening	Price
168416	LK940AT10L2H	2-Hole, No Spray	ADA 2" Lever	Chrome		

Commercial

Faucets & Valves

Pre-Rinse 8" Centerset 2-Hdl Foodservice Faucet with Exposed Deck and Flexible Spout

- 30" Reach, 41-1/8" spout height
- Solid brass construction
- 1/2"-14 NPT
- 5-1/2" Deck clearance
- Quarter turn ceramic disc valve
- 8" Faucet hole spread
- 360° swing spout rotation
- Includes spout swing restriction pin
- Replacement cartridge (45923C) for cold and (45924C) for hot
- NSF/ANSI 61 certified
- Flow rate: 1.6 gpm



Part #	Mfg #	Overall Size	Holes	Depth	Drain Opening	Price
174008	LK843C	3-Hole, Pre-Rinse Spray	Lever	Chrome		

Pre-Rinse 8" Centerset 2-Hdl Foodservice Faucet with Flexible Spout

- 30" Reach, 41-1/8" spout height
- Solid brass construction
- 1/2"-14 NPT
- Quarter turn ceramic disc valve
- Self closing valve
- 5-1/2" Deck clearance
- 8" Faucet hole spread
- 360° swing spout rotation
- Includes spout swing restriction pin
- 44" flexible stainless steel hose with insulated handle
- NSF/ANSI 61 certified
- Spray head flow rate: 3.2 gpm, faucet flow rate: 1.5 gpm



Part #	Mfg #	Overall Size	Holes	Depth	Drain Opening	Price
162507	LK943AF08C	2-Hole, Pre-Rinse Spray	Lever	Chrome		

Commercial

2-Hdl Scrub & Handwash Faucet with Concealed Deck and Gooseneck Spout

- 4" Reach, 11-5/16" spout height
- Dual control
- Solid brass construction
- Choice of 3 handle options and 3 spout styles
- 1-1/8" Unified screw thread, standard series
- 8-7/8" Deck clearance
- Quarter turn ceramic disc cartridge
- Includes spout swing restriction pin
- Replacement cartridge (45923C) for cold and (45924C) for hot
- NSF/ANSI 61 certified
- 2.2 gpm vandal-resistant aerator standard with 1.5 and .5 gpm insert included



Faucets & Valves

Part #	Mfg #	Overall Size	Holes	Depth	Drain Opening	Price
224401	LK500GN04T4	1-Hole, No Spray Type	4" ADA Wristblade	Chrome		

General Use 1-Hdl Gooseneck Spout Bar Faucet

- 5" Reach, 12-1/2" spout height
- Solid brass construction
- Circular brass base
- Removable cartridges
- 3/8" O.D. stainless flex valve connection
- Quarter turn ceramic disc cold valve
- Choice of two spout styles
- 9-3/8" maximum deck clearance
- NSF/ANSI 61 certified
- Maximum flow rate: 1.5 gpm



Part #	Mfg #	Overall Size	Holes	Depth	Drain Opening	Price
129350	LKD208513LC	1-Hole, No-Spray Type	ADA Lever	Chrome		

Classroom 1-Hdl Commercial Faucet with Gooseneck spout

- 4" reach, 11-3/8" spout height
- Solid brass construction
- Choice of 3 handle options and spout styles
- 8-7/8" Maximum deck clearance
- 1/2"-14 NPSM
- Quarter turn ceramic disc cartridge
- Includes spout swing restriction pin
- Replacement cartridge 45923C for cold
- NSF/ANSI 61 certified
- Maximum flow rate: 1.5 gpm



Part #	Mfg #	Overall Size	Holes	Depth	Drain Opening	Price
175661	LK535GN04L2	1-Hole, No Spray Type	ADA 2" Lever	Chrome		

Commercial

Faucets & Valves

Bar/Entertainment 2-Hdl Commercial Bar Faucet with Gooseneck spout

- 5" reach, 12-1/2" spout height
- Solid brass construction
- Choice of 3 handle options and spout styles
- 2.6" Lever handle
- Removable cartridges
- 9-3/8" Maximum deck clearance
- 3/8" O.D stainless flex
- Quarter turn ceramic disc valve
- NSF/ANSI 61 certified
- Water saving flow restrictor
- Maximum flow rate: 1.5 gpm



Part #	Mfg #	Overall Size	Holes	Depth	Drain Opening	Price
168127	LKD208813C	1-Hole, No Spray Type	ADA Lever	Chrome		

3"—8" Adjustable Center 2-Hdl Foodservice Faucet with Hi Arc Spout

- 10" Reach, 10-3/16" spout height
- Solid brass construction
- Choice of 3 handle options and 5 spout styles
- 1/2" NPT female inlets with 2" offset
- 7-11/16" Deck clearance
- Quarter turn ceramic disc valve
- 8" Faucet hole spread
- Includes spout swing restriction pin
- Replacement cartridge (45923C) for cold and (45924C) for hot
- NSF/ANSI 61 certified
- Flow rate: 1.5 gpm



Part #	Mfg #	Overall Size	Holes	Depth	Drain Opening	Price
176398	LK945HA10L2T	2-Hole, No Spray Type	ADA 2" Lever	Chrome		

Commercial Faucet Accessories

Ceramic Short Stem Cartridge with Square Mounting

- Ceramic 1/4" turn cartridge

Part #	Mfg #	Overall Size	Holes	Depth	Drain Opening	Price
155244	45923C	Right Hand, Cold				
155245	45924C	Left Hand, Cold				

Commercial - Institutional Faucets

Pre-rinse Units

2-Hdl Easyinstall Wall-Mount Pre-Rinse Unit

- Wall-mount faucet (002832-40) with "pop and lock" riser installation feature
- 35-1/2" High, 15" overhang
- Spray valve (B-0107)
- 1/2" NPT Female eccentric flanged inlets (00AA)
- 18" Riser model (000369-40)
- Flexible stainless steel hose (B-0044-H)
- EPAAct 2005 Compliant
- Installation kit sold separately (B-0230-K)



Faucets & Valves

Part #	Mfg #	Description	Handle(s)	Finish	Price
037648	B-0133	8"cc	Lever	Pol Chrome	

Pre-Rinse Spray Valve

- Used on most T&S pre-rinse units
- Connects directly to T&S flexible stainless steel hose or roto-flex handle assembly



Part #	Mfg #	Description	Price
010406	B-0107	Standard Spray Valve	

Commercial - Institutional Faucets

Sink Faucets

Commander® 2-Hdl Cast Brass Sink Faucet

- Integral stops
- 1/4-Turn ceramic cartridges
- Vandal-resistant 4-arm handles with color-coded indexes
- Cast brass nozzle with 3/4" hose coupling discharge, pail hook and top brace
- 1/2" NPTF Inlets



Faucets & Valves

Part #	Mfg #	Description	Price
047405	SC-5811-RCP	Rough Chrome-Plated Brass	

Commercial - Institutional Faucets

Service Faucets

- Vacuum breaker integral stops, adjustable wall brace, pail hook, and 3/4" hose thread on spout
- Four arm handles
- Chrome-plated

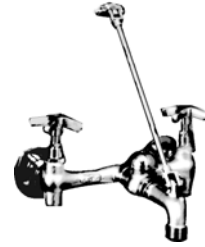

Part #	Mfg #	Description	Price
020372	830AA	8"cc	

Kitchen Faucets & Accessories



Wall-Mount Sink Faucets

20 and 40 Washer-Type 2-Hdl Wall-Mount Faucet

- Washer-type renew valves & seats
- Cast brass body on 8" centers
- Chrome-plated assembly
- Chrome metal blade type handles



24A



40A



49A

Part #	Mfg #	Description	Spout	Price
010493	24A-Q	1/4 Turn Valve, Female Flange Less Soap Dish	12"	
010497	40A-Q	1/4 Turn Valve, Female Flange w/Soap Dish	6"	
010500	49A-Q	1/4 Turn Valve, Female Flange w/Soap Dish	8"	

Faucets & Valves

Commercial - Institutional Faucets

Optima® System Faucets

EBF-85 OptimaPlus® Battery Powered Hand Washing Faucet

- Chrome-plated brass lavatory faucet with engineered plastic throat plate
- 0.5 Flow control aerator
- Fiber-Optic adaptive sensor
- Water-tight circuit control module
- Integral filtered solenoid valve
- (4) "C" Cell alkaline batteries



OPTIMA
plus

Part #	Mfg #	Model	Description	Price
022204	3315010	EBF-85-M	Back Check, 4" Trim Plate	

Faucets & Valves

Commercial - Institutional Faucets

Faucets & Valves

HydroGuard® Tempering Valves

HydroGuard® XP Series ES150 Emergency Tempering Valve with Cold Water Bypass

- Advanced thermal actuator provides precise temperature control
- Internal cold water bypass ensures cold water flow in the event of loss of hot water
- Flow effectively shuts down upon loss of cold water supply when tested under the condition specified in ASSE 1071 standard
- Vandal-resistant locking mechanism to secure temperature setting
- Factory tested
- Checkstops to prevent cross flow
- 1/2" NPT Inlet and outlet connections
- Maximum operating pressure: 125 psi
- Maximum hot water temperature: 180°F
- Bypass flow rate @ 30 psid: 6.5 gpm
- Maximum flow with cold water shut-off: 0.5 gpm



Part #	Mfg #	Description	Price
074242	ES150-11	Temperature/Pressure Gauge on Outlet, Rough Bronze	

LM495 Series Thermostatic Mixing Valve for Individual Lavatory Installations

- Advanced thermal actuator improves performance at low flow
- Solid bronze construction enhances durability
- Adjustable temperature selection with lock down
- Union connections for easy maintenance
- Integral checks and screen prevents cross-flow and contamination
- Temperature control to ASSE 1069, 1070 down to 0.5 gpm
- Maximum operating pressure: 125 psi
- Maximum hot water temperature: 200°F



Part #	Mfg #	Description	Price
092105	LM495-1	1/2" NPT Female	

e480 Series Under-the-Counter Combination Tempering Valve for Low Flow Control

- Adjustable temperature selection with locknut to prevent tampering
- Advanced thermal actuator improves performance
- Temperature controls to ASSE 1070, down to 0.5 gpm
- Solid brass construction enhances durability
- Corrosion resistant internal components for extended life
- Integral checks with screens prevents cross flow and filter out debris
- Factory set to 105°F
- Maximum operating pressure: 125 psi
- Maximum hot water temperature: 180°F



Part #	Mfg #	Description	Price
101202	E480-10	3/8" Compression, Rough Bronze	

Digital Shower Trim

Digital Shower Interfaces

DTV+™ Digital Interface

- Can control shower outlets, audio output, chromatherapy, steam and lighting, allowing user to control their experience from a single interface
- System warm up & pause feature
- Duration/countdown timer
- Up to three interfaces can be connected to each system for alternate locations and applications
- Can control up to two digital valves to provide two different shower temperatures
- Six user definable presets provide easy to use selection of saved favorite settings
- Surface mount installation



Requires K-99694 Interface Mounting Bracket & K-99695 System Controller Module

Part #	Mfg #	Description	Price
173649	K-99693-NA	NA	

DTV+™ Interface Mounting Bracket



Part #	Mfg #	Description	Price
173651	K-99694-BL	Matte Black	
174491	K-99694-BN	*Brushed Nickel	
174353	K-99694-CP	Polished Chrome	
175273	K-99694-SN	Polished Nickel	

DTV Prompt® Digital Interface

- Digitally controlled
- High-temperature limit setting for added safety
- Mounts on finished wall surface
- One touch control of 2 valve outlets
- Interface includes a 2-ft cable
- Low profile design
- Selectable water-saving functionality
- Selectable Fahrenheit or Celsius
- Selectable outlet delivery



Part #	Mfg #	Description	Price
158665	K-527-0	White	
146693	K-527-1CP	Satin Chrome w/ Pol Chrome	
140766	K-527-1SN	Satin Nickel with Pol Nickel	
160202	K-527-7	Black	

DTV Prompt® 3-Outlet Digital Interface

- Large, easy to read LCD display displays time and temperature
- Raised one touch buttons for simple and intuitive system control
- Provides independent control of up to three outlets
- Suitable for multi outlet shower or bath/shower applications
- System warm up and pause feature
- Duration/countdown timer feature



Requires: K-559 Mounting Bracket
K-557-K 3-Port Valve

Part #	Mfg #	Description	Price
183587	K-558-0	White	
186522	K-558-7	Black Black	
174342	K-558-1CP	Satin Chrome w/ Pol Chrome	
176496	K-558-1SN	Satin Nickel with Pol Nickel	

DTV Prompt® Interface Mounting Bracket

- For surface mounting DTV prompt digital interface



Part #	Mfg #	Description	Price
186523	K-559-BL	Matte Black	
183588	K-559-BN	*Brushed Nickel	

* Vibrant Limited Lifetime Warranty

www.plumbsupply.com • Serving our Customers Since 1946 • www.waterconcepts.net

Digital Shower Trim

Faucets & Valves

Digital Shower Interfaces (Continued)

DTV Prompt® Interface Mounting Bracket

Part #	Mfg #	Description	Price
176497	K-559-SN	*Polished Nickel	

DTV Components

DTV Prompt® Three-Port Thermostatic Valve



Part #	Mfg #	Description	Price
174343	K-557-K-NA	NA	

DTV+™ Digital Three-Port Thermostatic Valve



Part #	Mfg #	Description	Price
183586	K-557-K1-NA	NA	

DTV® Six-Port Thermostatic Valve

- Digitally controlled
- Internal brass mixing valve
- Scald hazard prevention
- Cross flow prevention
- Six independent water outlets
- Mounts within a standard 2x4 wall
- 3/4" NPT inlet and 1/2" NPT outlet connections
- Maximum flow rate: 21.0 gpm



Requires K-684 DTV Interface for DTV System

Requires K-695 DTV II Interface and K-638-K Media Module for DTV II System

Requires K-99693 DTV+ Interface, K-99695 DTV+ Controller Module, and K-97172 DTV+ Media Cable for DTV+ System

Part #	Mfg #	Description	Price
099356	K-682-K-NA	NA	

DTV® Two-Port Thermostatic Valve



Part #	Mfg #	Description	Price
140767	K-528-K-NA	NA	

DTV® II Media Module

- Provides connections for digital mixing valve, 2 digital interfaces, incandescent lighting, audio, Ethernet, and steam or other peripheral
- Water-resistant construction
- Ethernet, (2) 1-speaker, (2) 2-speaker and audio line-in cables available in an accessory kit
- Knockout and fitting provided for high voltage lighting connection
- Mounts with a standard 2x4 wall
- Adjustable bracket allows easy installation in a 13" - 19" stud pocket



Requires K-695 Primary Interface and K-682-K Valve

Part #	Mfg #	Description	Price
113117	K-638-K-NA	NA	

DTV+™ System Controller Module

- Provides power to the interfaces and controls digital valves
- Integrated web pages for system set up and configuration using a computer/laptop connected via router or connection to home network
- Two ports for connecting digital valve(s)
- Eight ports for interface(s) and other system component connections
- One Ethernet port for hard wire connection to home network or via Wi-Fi adapter
- One jack for power cord connection



Requires K-99693 Digital Interface

Part #	Mfg #	Description	Price
173650	K-99695-NA	NA	

DTV+™ Data Cable

- 30ft Cable length
- Cable length can be extended using standard CAT5 Ethernet cable and coupler



Requires K-682-K DTV® thermostatic valve & K-99695 DTV+ system controller module

Part #	Mfg #	Description	Price
173652	K-97172-NA	NA	

* Vibrant Limited Lifetime Warranty

www.waterconcepts.net • Serving our Customers Since 1946 • www.plumbsupply.com

Digital Shower Trim

DTV+™ Amplifier Module

- Digitally controlled thermostatic mixing valve.
- Anti scald protection.
- Three independently controllable 1/2" outlets with copper tube connections.
- Up to 13 gpm maximum flow rate (8.0 gpm maximum flow from one outlet).
- 1/2" inlets with copper tube connections.
- Includes filter screens.
- High temperature limit setting for additional protection.



Part #	Mfg #	Description	Price
175274	K-99696-NA	NA	

Amplifier

- BLUETOOTH® connectivity for wireless streaming of audio input
- 3.5 mm Input jack for wired audio input
- Mounting brackets included
- Works with any 4 or 8 ohm speakers
- Power supply with universal plug-in adapters for USA, UK, EU, SAA
- A 69" power cord provided with power supply



Part #	Mfg #	Description	Price
159863	K-752-NA	NA	

SoundTile® Speakers

- Can be used with any audio system and also integrated with the DTV II
- Mounts within standard 2- by 4-inch walls or ceilings
- Installs after finished wall is complete
- Sold in pairs



Requires K-10609-A or K-10609-B Cable Kit

Part #	Mfg #	Description	Price
143946	K-8033-AF	*French Gold	
113544	K-8033-BN	Brushed Nickel	
122133	K-8033-BV	*Brushed Bronze	
113120	K-8033-CP	Polished Chrome	
149147	K-8033-SN	*Polished Nickel	
162517	K-8033-2BZ	Oil-Rubbed Bronze	

DTV+™ Conversion Kit for DTV I Interface

- Upgrade an existing installed primary interface (K-684) to the DTV+™ interface (K-99693)
- Kit includes cover plate, required cables, and a wiring connection adapter.
- DTV I landscape primary interfaces (K-683) cannot be upgraded to the new DTV+™ interface
- Requires K-99693 DTV+™ interface and K-99695 system controller module (sold separately)



Part #	Mfg #	Description	Price
189032	K-99702-NA	NA	

DTV+™ Conversion Kit for DTV II Interface

- Upgrade an existing installed primary interface (k-695) to the DTV+™ interface (k-99693)
- DTV II landscape primary interfaces (k-694) cannot be upgraded to the new DTV+™ interface
- Requires k-99693 DTV+™ interface and k-99695 system controller module (sold separately)



Part #	Mfg #	Description	Price
187827	k-97170-NA	NA	

* Vibrant Limited Lifetime Warranty

www.plumbsupply.com • Serving our Customers Since 1946 • www.waterconcepts.net

Faucet Accessories

Air Gap Units

Reverse Osmosis Air Gap

- For Mountain point-of-use faucets
- Mounting hole 1-1/4"



Part #	Mfg #	Finish	Price
105180	AG600S/BRS	Brushed Stainless	

Faucets & Valves

*PVD Finish

www.waterconcepts.net • Serving our Customers Since 1946 • www.plumbsupply.com

Faucet Accessories

Faucet Parts & Accessories

Faucet Hole Cover



Part #	Mfg #	Size	Price
008040	1275	1-3/4"	
008039	1274	2"	

Faucets & Valves

Faucet Accessories

Rinse Quiks

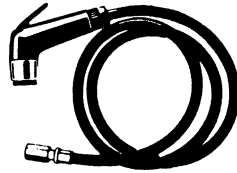

Part #	Mfg #	Description	Price
003059	R392500	MR-422-4 Rinse Quik	
029135	R392600	MR-422-4C Rinse Quik	

Rinse Quik Head



Part #	Mfg #	Description	Price
003058	R392900	MR-422 Head, Black	
033465	R392910	MR-427-WH Head, White	
117698	R392930	MR-427-C Head, Chrome	

Faucets & Valves

Faucet Handles

Lavatory Faucet Handles

Addison™ Lever Handle Kit

- Sold in pairs



Part #	Mfg #	Description	Price
169215	H292	Chrome	

Cassidy™ Cross Handle Kit

- Sold in pairs
- For kitchen, bar/prep, deck-mount lavatory, and bidet applications



H295



H297



H298

Part #	Mfg #	Description	Price
151990	H295	Chrome	
152779	H295CZ	Champagne Bronze™	
165669	H295PN	Polished Nickel*	
150954	H295RB	Venetian Bronze®	
152780	H295SS	Stainless*	
151501	H297	Chrome	
152782	H297CZ	Champagne Bronze™	
160504	H297PN	Polished Nickel*	
152372	H297RB	Venetian Bronze®	
152783	H297SS	Stainless*	
152784	H298	Chrome	
152785	H298CZ	Champagne Bronze™	
157706	H298PN	Polished Nickel*	
152029	H298RB	Venetian Bronze®	
152786	H298SS	Stainless*	

Compel® Faucet Handles

Part #	Mfg #	Description	Price
172972	H261	Chrome	
175511	H261-SS	Stainless*	

Lahara™ Lever Handle Kit

- Sold in pairs



Part #	Mfg #	Description	Price
118892	H238	Chrome	
168302	H238-RB	Venetian Bronze®	
161560	H238-SS	Stainless*	

Leland™ Lever Handle Kit

- Includes screws and finial for lavatory/bidet
- Sold in pairs



Part #	Mfg #	Description	Price
083847	H278	Chrome	
092300	H278RB	Venetian Bronze®	
082337	H278SS	Stainless*	

Leland™ Porcelain Lever Handle kit

- Includes screws and finial for lavatory/bidet
- Sold in pairs



Part #	Mfg #	Description	Price
088850	H277	Chrome	

Linden™ Traditional Lever Handle Kit

- Sold in pairs



Part #	Mfg #	Description	Price
227684	H293	Chrome	
225670	H293RB	Venetian Bronze	

* Brilliance® Anti-Tarnish Lifetime Finishes

www.plumbsupply.com • Serving our Customers Since 1946 • www.waterconcepts.net

Faucet Handles

Faucets & Valves

Linden™ Lever Handle Kit

- Sold in pairs



Part #	Mfg #	Description	Price
159266	H294	Chrome	
150733	H294-SS	Stainless*	

Rook™ Cross Handle Kit

- Sold in pairs



Part #	Mfg #	Description	Price
188958	HX5361-PC	Chrome	

Vero™ Handle Kit

- Sold in pairs



Part #	Mfg #	Description	Price
171384	H253	Chrome	
164947	H253-SS	Stainless*	

Trinsic™ Lever Handle Kit

- Sold in pairs



Part #	Mfg #	Description	Price
167632	H259	Chrome	

Victorian® Metal Lever Handle Kit

- Includes screws and finial
- For kitchen, bar, lavatory, 2- or 3-H handle tub/shower, or bidet
- Sold in pairs



Part #	Mfg #	Description	Price
054268	H216	Chrome	
054273	H216RB	Venetian Bronze®	

Lavatory Faucet Handles (Continued)

Victorian® Metal Lever Handle Kit

Part #	Mfg #	Description	Price
061837	H216SS	Stainless*	

Metal Lever Handle

- Requires A24 accents



Part #	Mfg #	Description	Price
024068	H24	Chrome	
024045	A24	Chrome Handle Accent for H24	

Traditional Lever Handle Kit

- Neo Style® includes screws and finials
- For kitchen, bar, lavatory 2- or 3-H tub/shower/bidet
- Sold in pairs



Part #	Mfg #	Description	Price
003448	H25	Chrome	

Small Porcelain Cross Handle Kit

- Includes screws and finial
- For kitchen, bar, lavatory, 2- or 3-H tub/shower, or bidet
- Sold in pairs



Part #	Mfg #	Description	Price
003558	H27	Chrome	

Small Blade Handle Kit

- Includes buttons, screws and finial
- For kitchen, bar, centerset lavatory, 2-H tub/shower



Part #	Mfg #	Description	Price
003679	H28	Chrome	

* Brilliance® Anti-Tarnish Lifetime Finishes

www.waterconcepts.net • Serving our Customers Since 1946 • www.plumbsupply.com

Faucet Handles

Classic Clear Knob Handles



Part #	Mfg #	Description	Price
003570	H21	Clear	

Porcelain Lever Handle Kit

- Traditional style includes screws and finial
- For kitchen, bar, lavatory, 2- or 3-H handle tub/shower, or bidet
- Sold in pairs



Part #	Mfg #	Description	Price
045768	H212	Chrome	
063729	H212SS	Stainless*	
084397	H212PN	Polished Nickel*	
054267	H212RB	Venetian Bronze®	

Lavatory Lever Handle With Set Screw

- For 500 series lavatory faucets



RP17443

Part #	Mfg #	Description	Price
003518	RP17443	Chrome	
027044	RP17443PB	Polished Brass*	

Traditional® Metal Lever Handle Kit

- Includes screws and finial
- For kitchen, bar, lavatory, 2- or 3-H tub/shower, or bidet
- Sold in pairs



Part #	Mfg #	Description	Price
097619	H215SS	Stainless*	

Roman Tub Faucet Handles

Cassidy™ Lever Roman Tub Handle Kit

- Metal handles
- Sold in pairs
- For Roman tub applications



H695



H697



H698

Part #	Mfg #	Description	Price
152963	H695	Chrome	
152965	H695CZ	Champagne Bronze™	
152966	H695PN	Polished Nickel*	
152943	H695RB	Venetian Bronze®	
152967	H695SS	Stainless*	
151506	H697	Chrome	
152976	H697CZ	Champagne Bronze™	
152977	H697PN	Polished Nickel*	
151695	H697RB	Venetian Bronze®	
151698	H697SS	Stainless*	
152971	H698	Chrome	
152972	H698CZ	Champagne Bronze™	
152973	H698PN	Polished Nickel*	
152974	H698RB	Venetian Bronze®	
152975	H698SS	Stainless*	

Innovations Roman Tub Handles

- Metal Lever
- Requires accent A64 for complete handle set



H64

A64

Part #	Mfg #	Description	Price
024076	H64	Chrome	
024051	A64	Chrome Handle Accent	

* Brilliance® Anti-Tarnish Lifetime Finishes

www.plumbsupply.com • Serving our Customers Since 1946 • www.waterconcepts.net

Faucet Handles

Faucets & Valves

Lahara® Roman Tub Handle Assembly



Part #	Mfg #	Description	Price
162207	RP51289CZ	Champagne Bronze™	
173145	RP51289RB	Venetian Bronze®	
153569	RP51289SS	Stainless*	

Leland™ Single Bath Handle

- Includes screws
- Sold as single handle



Part #	Mfg #	Description	Price
103162	H578	Chrome	
117385	H578RB	Venetian Bronze®	
099488	H578SS	Stainless*	

Leland™ Lever Handle Kit

- Includes screws
- For Roman tub
- Sold in pairs



Part #	Mfg #	Description	Price
084239	H678	Chrome	
092299	H678RB	Venetian Bronze®	
084393	H678SS	Stainless*	

Single Blade Handle Kit - Transfer Valve



Part #	Mfg #	Description	Price
175929	RP62097	Transfer Valve Handle Kit	
155271	RP62097-SS	Transfer Valve Handle Kit	

Victorian® Lever Handle Kit

- Metal lever
- For Roman tub
- Sold in pairs



Part #	Mfg #	Description	Price
054224	H616	Chrome	
145819	H616CZ	Champagne Bronze™	
054230	H616PB	Polished Brass	
054231	H616RB	Venetian Bronze®	
076076	H616SS	Stainless*	

Shower Valve Faucet Handles

Addison™ 14 Series Lever Handle

- Recommend RP26853 wrench for installation



Part #	Mfg #	Description	Price
177447	RP61268SS	Stainless*	

Ara™ 14 Series Lever Handle



Part #	Mfg #	Description	Price
179368	RP79166SS	Stainless*	

Tub & Shower Clear Knob Handle



Part #	Mfg #	Description	Price
003525	H71	Clear	

* Brilliance® Anti-Tarnish Lifetime Finishes

www.waterconcepts.net • Serving our Customers Since 1946 • www.plumbsupply.com

Faucet Handles

Medium Clear Knob Handle Kit

- Includes buttons, screws and finial
- For kitchen, lavatory with screwdriver stops, 2- or 3-H tub and shower, or 2714 & 2708 series models
- Sold in pairs



Part #	Mfg #	Description	Price
025031	H41	For CP/BS/NC/NN/WC/WH	

Clear Knob Handle

- Includes hot/cold arrow buttons and screws
- For basin or 3-H tub/shower
- Sold as single handle



Part #	Mfg #	Description	Price
022373	H11	For CP/BS/NC/NN/WC/WH	

Large Porcelain Cross Handle

- Includes arrow indicator and screw
- For Monitor® 1400 series
- Sold as single handle



Part #	Mfg #	Description	Price
003566	H77	Chrome	

Large Blade Handle

- Includes screws
- For Monitor® 1300, 1400 series
- Sold as single handle



Part #	Mfg #	Description	Price
016915	H78	Chrome	

Large Lever Handle

- For Monitor® 1300, 1400 series
- Sold as single handle



Part #	Mfg #	Description	Price
020138	H79	Chrome	

Cassidy™ Monitor 13/14 Series Shower Handle

- Sold as single handle
- For shower and tub/shower valves



H795 Cross



H797 Lever



H798 Decorative

Part #	Mfg #	Description	Price
151994	H795	Chrome	
153013	H795CZ	Champagne Bronze™	
153023	H795PN	Polished Nickel*	
152946	H795RB	Venetian Bronze®	
152714	H795SS	Stainless*	
151515	H797	Chrome	
153029	H797CZ	Champagne Bronze™	
153031	H797PN	Polished Nickel*	
152962	H797RB	Venetian Bronze®	
153033	H797SS	Stainless*	
153024	H798	Chrome	
153025	H798CZ	Champagne Bronze™	
153026	H798PN	Polished Nickel*	
153027	H798RB	Venetian Bronze®	
153028	H798SS	Stainless*	

Cassidy™ Diverter Trim Handle Options

- Sold as single handle
- Fits Cassidy transfer valve trim



H595 Cross



H597 Traditional



H598 Decorative

Part #	Mfg #	Description	Price
152988	H595	Chrome	
152991	H595-SS	Stainless*	
152990	H595-PN	Polished Nickel*	
152989	H595-CZ	Champagne Bronze™	
151551	H595-RB	Venetian Bronze®	
152238	H597	Chrome	
151701	H597-SS	Stainless*	
153012	H597-PN	Polished Nickel*	
153011	H597-CZ	Champagne Bronze™	
150952	H597-RB	Venetian Bronze®	

* Brilliance® Anti-Tarnish Lifetime Finishes

www.plumbsupply.com • Serving our Customers Since 1946 • www.waterconcepts.net

Faucets & Valves

Faucet Handles

Faucets & Valves

Shower Valve Faucet Handles (Continued)

Cassidy™ Diverter Trim Handle Options

Part #	Mfg #	Description	Price
153006	H598	Chrome	
153010	H598-SS	Stainless*	
153008	H598-PN	Polished Nickel*	
153007	H598-CZ	Champagne Bronze™	
153009	H598-RB	Venetian Bronze®	

Contemporary 14 Series Single Lever Handle Kit

- Sold as single handle
- For 14 Series shower and tub/shower valves



Part #	Mfg #	Description	Price
173915	RP75437SS	Stainless*	

Innovation® 14 Series Single Lever Handle

- H74 requires A74 accent to complete handle



H74--A74

Part #	Mfg #	Description	Price
024080	H74	Handle, Chrome	
024056	A74	Accent, Chrome	

Lahara® 14 Series Single Lever Handle Kit

- Sold as single handle
- For 14 Series shower and tub/shower valves
- Recommend RP26853 wrench for installation



Part #	Mfg #	Description	Price
164475	RP51304	Chrome	
177518	RP51304SS	Stainless*	

Leland™ Lever Handle

- Sold as single handle
- For shower and tub/shower valves



Part #	Mfg #	Description	Price
083920	H778	Chrome	
093874	H778RB	Venetian Bronze®	
082328	H778SS	Stainless*	

Victorian® Metal Lever Handle

- Includes screw
- For 1400 series model
- Sold as single handle



H716

Part #	Mfg #	Description	Price
055893	H716	Chrome	
055784	H716RB	Venetian Bronze®	
075147	H716SS	Stainless*	
044573	H712	Chrome, Porcelain Accent	

14 Series Handle



Part #	Mfg #	Description	Price
185943	RP73376	Chrome	

14 Series Handle Assembly



Part #	Mfg #	Description	Price
171316	RP70639SS	Stainless*	

Single Metal Lever Handle Kit

- For 14 series shower and tub/shower trim



Part #	Mfg #	Description	Price
180772	RP52587SS	Stainless*	

* Brilliance® Anti-Tarnish Lifetime Finishes

www.waterconcepts.net • Serving our Customers Since 1946 • www.plumbsupply.com

Faucet Handles

Handle Assembly

- For 14 series shower and tub/shower trim



Part #	Mfg #	Description	Price
185734	RP77090-SS	Stainless*	

Faucets & Valves

* Brilliance® Anti-Tarnish Lifetime Finishes

www.plumbsupply.com • Serving our Customers Since 1946 • www.waterconcepts.net

Faucet Handles

Faucets & Valves

Lavatory Faucet Handles

Baliza® Lavatory Handle Kit

- ADA Compliant
- Handle kit assembly
- Sold in pairs



Part #	Mfg #	Description	Price
141934	HL505-BN	Brushed Nickel*	
171322	HL505-BZ	Brushed Bronze*	
144002	HL505-PC	Chrome	
159399	HL505-PN	Polished Nickel*	
139208	HL505-RB	Venetian Bronze®	

Baliza® Cross Lavatory Handle Kit

- ADA Compliant
- Handle kit assembly
- Sold in pairs



Part #	Mfg #	Description	Price
154639	HX505-RB	Venetian Bronze®	

Charlotte™ Lavatory Handle Kit

- ADA Compliant
- Sold in pairs



Part #	Mfg #	Description	Price
180679	HL5385-BN	Brushed Nickel*	
177589	HL5385-PC	Chrome	
155366	HL5385-PN	Polished Nickel*	
144007	HL5385-PNCO	Cocoa Bronze™/Pol Nickel	

Charlotte™ Vessel Handle Kit

- Handle kit assembly
- Sold in pairs



Part #	Mfg #	Description	Price
166544	HL5485-BN	Brushed Nickel*	
164023	HL5485-PNCO	Cocoa Bronze™/Pol Nickel	

Charlotte™ Vessel Wall-Mount Handle Kit

- ADA Compliant
- Handle kit assembly
- Sold in pairs



Part #	Mfg #	Description	Price
147187	HL5885-PNCO	Cocoa Bronze™/Pol Nickel	

Litze™ Lavatory Handle Kit



Part #	Mfg #	Description	Price
229518	HL5332-NKTK	Luxe Nickel/Teak Wood	

Rook™ Lavatory Handle Kit



HX5361-NKBL

Part #	Mfg #	Description	Price
185805	HL5360-NK	Lever, Luxe Nickel*	
222019	HL5360-RB	Lever, Venetian Bronze®	
178558	HX5361-NKBL	Luxe Nickel/Matte Black*	

RSVP® Vessel Faucet Handle Kit

- Handle kit assembly
- Sold in pairs



Part #	Mfg #	Description	Price
166344	HL5790-PC	Chrome	

* Brilliance® Anti-Tarnish Lifetime Finishes

www.waterconcepts.net • Serving our Customers Since 1946 • www.plumbsupply.com

Faucet Handles

Siderna® Lavatory Handle Kit

- ADA compliant
- Sold in pairs



Part #	Mfg #	Description	Price
155288	HL5380-BN	Brushed Nickel*, Metal Insert	
187947	HL5380-BL	Matte Black, Metal Insert	
168305	HL5380-PC	Chrome, Metal Insert	
222675	HL5381-PC	Chrome, Green Glass Inserts	
162475	HL5382-BL	Matte Black, Solar Grey Glass Insert	
173087	HL5382-BN	Brushed Nickel* Solar Grey Glass insert	
166142	HL5382-PC	Chrome, Solar Grey Glass Insert	

Siderna® Wall-Mount Lavatory Handles

- ADA Compliant
- Sold in pairs



Part #	Mfg #	Description	Price
158693	HL5880-BN	Brushed Nickel*	
166849	HL5880-PC	Chrome	
227219	HL5882-PC	Chrome/Solar Gray Glass	
227206	HL5882-BL	Matte Black/Solar Gray Glass	

Tesla® Lavatory Handle Kit

- ADA Compliant
- Sold in pairs



Part #	Mfg #	Description	Price
229495	H252PN	Polished Nickel	

Traditional Handle Kit

- Single Metal Lever
- Must order 2 handles for lav, roman tub, & bidet LHP faucets
- Mounting screws included



Part #	Mfg #	Description	Price
024384	HK36-PC	Chrome	
106279	HK36-BN	Brushed Nickel*	

Roman Tub Faucet Handles

Baliza® Roman Tub Handle Kit

- ADA Compliant
- Sold in pairs



Part #	Mfg #	Description	Price
141937	HL605-BN	Brushed Nickel*	
171313	HL605-BZ	Brushed Bronze*	
173815	HL605-PC	Chrome	
134880	HL605-PN	Polished Nickel*	

Charlotte™ Roman Tub Handle Kit

- ADA Compliant
- Sold in pairs



Part #	Mfg #	Description	Price
171231	HL685-PC	Chrome	
155368	HL685-PN	Polished Nickel*	
144792	HL685-PNCO	Cocoa Bronze™/Pol Nickel	

Rook™ Roman Lavatory Handle Kit



Part #	Mfg #	Description	Price
223102	HL660-NKBL	Luxe Nickel/Matte Black	
185520	HL660-RB	Venetian Bronze®	

RSVP® Roman Tub Handle Kit

- Handle kit assembly
- Sold in pairs



Part #	Mfg #	Description	Price
160248	HL790-BN	Brushed Nickel*	
141155	HL790-PC	Chrome	

* Brilliance® Anti-Tarnish Lifetime Finishes

www.plumbsupply.com • Serving our Customers Since 1946 • www.waterconcepts.net

Faucet Handles

Siderna® Roman Tub Handle Kit

- ADA Compliant
- Sold in pairs



Faucets & Valves

Part #	Mfg #	Description	Price
155290	HL680-BN	Br Nickel*, Metal Inserts	
187946	HL680-BL	Matte Black, Metal Inserts	
168304	HL680-PC	Chrome, Metal Inserts	
224584	HL681-PC	Chrome, Green Glass Inserts	
162485	HL682-BL	Matte Black, Solar Grey Glass Inserts	

* Brilliance® Anti-Tarnish Lifetime Finishes

www.waterconcepts.net • Serving our Customers Since 1946 • www.plumbsupply.com

Flush Valves

Manual Flushometers

Royal® Diaphragm Type Exposed Parts Flushometer

- Dual filtered by-pass
- Diaphragm, handle packing, stop seat and vacuum breaker molded from PERMEX™ rubber compound for chloramine resistance
- ADA Compliant metal oscillating non-hold-open handle with triple seal handle packing
- Free spinning vandal resistant stop cap
- Adjustable tailpiece
- High back pressure vacuum breaker flush connection with 1-piece bottom hex coupling nut
- Sweat solder adapter with cover tube and case set screw wall flange
- Valve body, cover, tailpiece and control stop manufactured per ASTM alloy class for semi-red brass
- Valve in compliance with applicable sections of ASSE 1037, ANSI/ASME 112.19.6 and military specification V-29193

Royal® Models 110/111 Exposed Water Closet Flushometer

- Exposed water closet flushometer, for floor mounted or wall hung top spud bowls
- 1" IPS Screwdriver Bak-Chek™ angle stop
- Spud coupling and flange for 1-1/2" top spud



Part #	Mfg #	Model	Description	GPF	Spud	Price
010190	3010100	110	Water Saver	3.5	1-1/2"	
010213	3010000	111-1.6	Low Consumption	1.6	1-1/2"	
121752	3910168	111-1.28	High Efficiency	1.28	1-1/2"	

Royal® Model 117 Exposed Service Sink Flushometer

- Exposed service sink flushometer, for use with top spud service sinks
- 1" IPS Screwdriver Bak-Chek™ angle stop
- Spud coupling and flange for 1-1/2" top spud



Part #	Mfg #	Model	Description	GPF	Spud	Price
010197	3010528	117	Hdl on Front of Valve	6.5	1-1/2"	

Royal® Model 180 Exposed Urinal Flushometer

- Exposed urinal flushometer, for 1-1/4" top spud urinals
- 1" IPS Screwdriver Bak-Chek™ angle stop
- Spud coupling and flange for 1-1/2" top spud



Part #	Mfg #	Model	Description	GPF	Spud	Price
010204	3012436	180-1	Low Consumption	1.0	1-1/2"	

Flush Valves

Faucets & Valves

Royal® Model 186 Exposed Urinal Flushometer

- Exposed urinal flushometer, for 3/4" top spud urinals
- 3/4" IPS Screwdriver Bak-Chek™ angle stop
- Spud coupling and flange for 3/4" top spud



Part #	Mfg #	Model	Description	GPF	Spud	Price
010206	3012600	186	Water Saver	1.5	3/4"	
010209	3012636	186-1	Low Consumption	1.0	3/4"	
103256	3912697	186-0.5	Ultra Low Consumption	0.5	3/4"	

Royal® Bedpan Washer Flushometer

- Dual-filter fixed by-pass diaphragm
- ADA Handle with triple seal packaging
- Vandal-resistant stop cap
- Vacuum breaker flush connection
- Sweat kit with cast set screw wall flange
- Non-hold open
- Fixed volume accuracy with CID® technology

Part #	Mfg #	Model	Description	Price
010110	3019726	ROYAL BPW 1000-1.6	Royal Bedpan Washer Flushometer	

Regal® Diaphragm Type Exposed Flushometers

- ADA Compliant metal oscillating non-hold-open handle
- Vandal resistant stop cap
- Adjustable tailpiece
- Vacuum breaker flush connection
- Low consumption flush accuracy controlled by Para-Flo™ inside parts kit
- Handle packing, stop seat and vacuum breaker molded from PERMEX™ rubber compound for chloramine resistance
- Valve body, cover, tailpiece and control stop manufactured per ASTM alloy class for semi-red brass
- Valve in compliance with applicable sections of ASSE 1037, ANSI/ASME 112.19.6 and military specification V-29193

Regal® 110/111 Exposed Water Closet Flushometer

- Exposed water closet flushometer, for floor mounted or wall hung top spud bowls
- 1" IPS Screwdriver Bak-Chek™ angle stop
- Spud coupling, wall and spud flanges for 1-1/2" top spud



Part #	Mfg #	Model	Description	GPF	Spud	Price
022984	3080053	111-XL	Low Consumption*	1.6	1-1/2"	

* XL variation includes ADA compliant handle, vandal resistant stop cap with set screw and sweat-solder adapter with cover tube and cast set screw wall flange

Flush Valves

Regal® 186 Exposed Urinal Flushometer

- Exposed urinal flushometer, for 3/4" top spud urinals
- 3/4" IPS Screwdriver Bak-Chek™ angle stop
- Spud coupling, wall and spud flanges for 3/4" top spud

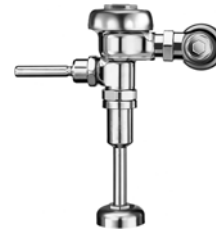

Part #	Mfg #	Model	Description	GPF	Spud	Price
022987	3082675	186-1-XL	Water Saver*	1.5	3/4"	

* XL variation includes ADA compliant handle, vandal resistant stop cap with set screw and sweat-solder adapter with cover tube and cast set screw wall flange

Sensor Operated Flushometers

ECOS® Battery Powered Exposed Dual Flush Flushometer

- ADA Compliant ECOS® battery powered infrared sensor for automatic "No-Hands" operation
- Dual filtered by-pass
- Diaphragm, stop seat and vacuum breaker molded from PERMEX™ rubber compound for chloramine resistance
- Engineered metal cover assembly with replaceable lens window
- 3-Second flush delay
- Courtesy Flush™ override button
- Low battery flashing LED, (4) size AA batteries included
- Infrared sensor range adjustment screw
- Initial set-up range indicator light (10 min)
- Free spinning vandal resistant stop cap
- Adjustable tailpiece
- High back pressure vacuum breaker flush connection with 1-piece bottom hex coupling nut
- Sweat solder adapter with cover tube and case set screw wall flange
- Valve body, cover, tailpiece and control stop manufactured per ASTM alloy class for semi-red brass
- Valve in compliance with applicable sections of ASSE 1037 and ADA standard

ECOS® Battery Powered Exposed Dual Flush Water Closet Flushometer

- Exposed, battery powered, sensor operated urinal flushometer for floor-mounted or wall hung top spud bowls
- 1" IPS Screwdriver Bak-Chek™ angle stop
- Spud coupling and flange for 1-1/2" top spud

Part #	Mfg #	Model	Description	GPF	Spud	Price
114096	3370400	8111-1.6/1.1	High Efficiency	1.1/1.6	1-1/2"	

Sloan® Optima® SMO Battery Powered Toilet Flush Valve

- Side mount sensor operated
- Battery powered infrared sensor for automatic no-hands operation
- Sweat solder adapter with cover tube and cast wall flange
- Type C battery
- Chrome-plated finish
- 1-1/2" Rough-in
- 1" IPS Supply inlet



Part #	Mfg #	Model	Description	GPF	Spud	Price
096030	3780114	111-SMO	Low Consumption	1.6	1-1/2"	

Flush Valves

Faucets & Valves

Regal® Optima® SMO Battery Powered Toilet Flush Valve

- Side mount sensor operated
- Battery powered infrared sensor for automatic no-hands operation
- Type C battery
- Chrome-plated finish
- 11-1/2" Rough-in
- 3/4" IPS Supply inlet



Part #	Mfg #	Model	Description	GPF	Spud	Price
096379	3782614	186-1-SMO	Low Consumption	1.0	3/4"	

G2 OptimaPlus® Battery Powered Exposed Water Closet Flushometers

- PERMEX™ synthetic rubber diaphragm with dual filtered fixed bypass
- Flex tube diaphragm designed for improved life and reduced maintenance
- ADA Compliant OptimaPlus® battery powered infrared sensor for automatic "No Hands" operation
- Infrared Sensor with multiple-focused, lobular sensing fields for high and low target detection
- Isolated latching solenoid operator, isolates magnetic components from water contact
- Engineered metal cover with replaceable lens window
- User friendly 3-second flush delay
- Courtesy Flush™ override button
- Four (4) Size AA batteries factory installed
- "Low Battery" flashing LED
- Infrared sensor range adjustment screw
- Initial set-up range indicator light (first 10 minutes)
- Free spinning, vandal resistant stop cap
- Adjustable tailpiece
- High back pressure vacuum breaker flush connection with 2-piece bottom hex coupling nut
- Sweat solder adapter with cover tube and cast set screw wall flange
- High copper, low zinc brass castings for dezincification resistance
- Fixed metering bypass and no external volume adjustment to ensure water conservation
- Flush accuracy controlled by CID™ Technology
- Diaphragm, stop seat and vacuum breaker to be molded from PERMEX™ rubber compound for chloramine resistance

G2 OptimaPlus® Models 8110/8111 Exposed Water Closet Flushometer

- Exposed, battery powered, sensor operated water closet flushometer for floor-mounted or wall hung top spud bowls
- 1" IPS Screwdriver Bak-Chek™ angle stop
- Spud coupling and flange for 1-1/2" top spud



Part #	Mfg #	Model	Description	GPF	Spud	Price
069989	3250400	8111	Low Consumption	1.6	1-1/2"	

Flush Valves

G2 OptimaPlus® Model 8180 Exposed Urinal Flushometers

- Exposed, battery powered, sensor operated urinal flushometer
- 1" IPS Screwdriver Bak-Chek™ angle stop
- Spud coupling and flange for 1-1/4" top spud
- Supplied less handle opening and metal cap



Part #	Mfg #	Model	Description	GPF	Spud	Price
071223	3250406	8180-1	Low Consumption	1.0	1-1/4"	

G2 OptimaPlus® Model 8186 Exposed Urinal Flushometers

- Exposed, battery powered, sensor operated urinal flushometer
- 3/4" IPS Screwdriver Bak-Chek™ angle stop
- Spud coupling and flange for 3/4" top spud
- Supplied less handle opening and metal cap



Part #	Mfg #	Model	Description	GPF	Spud	Price
071218	3250403	8186	Water Saver	1.5	3/4"	
069988	3250401	8186-1	Water Saver	1.0	3/4"	

Faucets & Valves

Flush Valves

Faucets & Valves

Royal Optima™ Sensor Operated Exposed Flushometer

- Dual filtered by-pass
- OPTIMA® EL-1500-L self adaptive infrared sensor with indicator light
- Courtesy Flush™ override button
- Non-hold-open integral solenoid operator
- (2) Chrome-plated wall cover plates (for 2-gang electrical box) with vandal resistant screws
- Free spinning vandal resistant stop cap
- Adjustable tailpiece
- High back pressure vacuum breaker flush connection with 1-piece bottom hex coupling nut
- Sweat solder adapter with cover tube and case set screw wall flange
- Valve body, cover, tailpiece and control stop manufactured per ASTM alloy class for semi-red brass
- Valve in compliance with applicable sections of ASSE 1037, ANSI/ASME 112.19.6 and military specification V-29193, ADA standards

Royal Optima® Exposed Sensor Operated Water Closet Flushometer

- Exposed sensor operated water closet flushometer, for floor mounted or wall-hung back spud bowls
- 1" IPS Screwdriver Bak-Chek™ angle stop
- Spud coupling and flange for 1-1/2" top spud



OPTIMA®

Part #	Mfg #	Model	Description	GPF	Spud	Price
029813	3450047	111ES-S	Low Consumption	1.6	1-1/2"	

Royal Optima® Exposed Sensor Operated Urinal Flushometer

- Exposed sensor operated water closet flushometer, for floor mounted or wall-hung back spud bowls
- 3/4" IPS screwdriver Bak-Chek™ angle stop
- Spud coupling and flange for 3/4" top spud



OPTIMA®

Part #	Mfg #	Model	Description	GPF	Spud	Price
010210	3452673	186-1ES-S	Low Consumption	1.0	3/4"	

Flush Valves

OptimaPlus™ Retro Fit Conversion Kit

G2® OptimaPlus RESS Royal Retro Conversion Kit

- Battery powered, sensor operated G2® Model retrofit conversion kit for Sloan Royal®, Regal Pro® and Regal® flushometers
- Courtesy flush override button
- User friendly 3-second flush delay
- ADA Compliant
- Installation tools provided
- Chrome-plated metal handle cap



Part #	Mfg #	Model	Description	Price
069990	3325400	RESS-G2-C	1.6 Closet Retrofit Kit, with (2) Flush Regulators	
069991	3325402	RESS-G2-U	1.0 Optima Urinal Retrofit Kit, with (2) Flush Regulators	

Urinal Side-Mount Operator



Part #	Mfg #	Model	Description	Price
078317	0325105	EBV-89A-M	Metal Side-Mount Operator	

Optima Flushometer Retrofit Kit

- ADA Compliant Optima® Smooth™ battery powered infrared sensor
- Sensor with automatic range adjustment
- Programmable automatic flushing system
- Tempered glass lens
- (4) Size C batteries included
- "Low Battery" flashing LED



Part #	Mfg #	Model	Description	Price
091328	3325201	EBV-200-A	Side Mount Operator Over the Handle Retrofit Kit	

Faucets & Valves

Flush Valves

Faucets & Valves

WES-111 Dual-Flush Flushometer

- Lifting handle up initiates reduced flush, eliminating liquid and paper waste, saving 1/2 gallon of water
- Pushing handle down initiates full flush, eliminating solid waste and paper
- Reduces water volume by up to 30% when activated upwards
- Antimicrobial coating on handle protects against germs
- PERMEX™ Synthetic rubber diaphragm with dual filtered fixed bypass
- Distinctive green ADA compliant metal non-hold-open handle with triple seal handle packing signifies water conserving device
- 1" IPS Screwdriver Bak-Chek™ angle stop
- Free spinning vandal resistant stop cap
- Adjustable tailpiece
- High back pressure vacuum breaker flush connection with 1-piece bottom hex coupling nut
- Spud coupling and flange for 1-1/2" top spud
- Includes (2) adhesive backed metal wall plates etched with instructions



Part #	Mfg #	Model	Description	GPF	Spud	Price
095310	3720000	WES-111	Low Consumption	1.6/1.1	1-1/2"	

Optima® System Faucet Parts

Electronic Faucet Parts

EBF-85 Faucet Parts

Part #	Mfg #	Model	Description	Price
044873	3315111	EBF-11-A	Module Assembly	

ETF-600/EFT-610 Faucet Parts

Part #	Mfg #	Model	Description	Price
022201	0365534	ETF-233	Transformer	

Repair Kits

Part #	Mfg #	Model	Description	Price
092078	3315254	EBF-1011-A	Solenoid Replacement Kit, Includes Body, Enclosure, & Filter Plug	

Flush Valves

Manual Urinal Flush Valves Manual Urinal Flushometer Valve

- Cast brass construction
- Piston valve technology
- Chloramine resistance on all rubber components exposed to waterway
- Vacuum breaker and control stop included
- ADA Lever on side



Part #	Mfg #	Description	Finish	Price
142915	K-13517-CP	1.28 gpf Manual Flush Valve	Polished Chrome	
142917	K-13518-CP	1.0 gpf Manual Flush Valve	Polished Chrome	

Manual Washdown Urinal Flushometer Valve

- Cast brass construction
- For urinal installations with 3/4" top spud coupling connection
- Chloramine resistance on all rubber components exposed to waterway
- Vacuum breaker and control stop included
- Locking stop cap and non-hold open design provide protection against vandalism



Part #	Mfg #	Description	Finish	Price
142919	K-13519-CP	0.5 gpf Manual Flush Valve	Polished Chrome	
142921	K-13520-CP	0.125 gpf Manual Flush Valve	Polished Chrome	

Manual Flush Valves Manual Toilet Flushometer Valve

- Cast brass construction
- Piston valve technology
- Chloramine resistance on all rubber components exposed to waterway
- Vacuum breaker and control stop included
- ADA Lever on side



Part #	Mfg #	Description	Finish	Price
142913	K-13516-CP	1.6 gpf Manual Flush Valve	Polished Chrome	

Commercial Electronic Flush Valves - DC Powered Tripoint® Touchless™ DC Toilet Flushometer Valve

- Brass construction
- Includes (4) 1.5V AA batteries
- Electronic infrared sensor with TriPoint™ technology
- For toilet installations with 1-1/2" spud coupling connection
- Vacuum breaker and stop control included



Part #	Mfg #	Description	Finish	Price
101368	K-10956-SV-C P	1.28 gpf Exposed Flush Valve	Polished Chrome	

*Vibrant Limited Lifetime Finish

www.plumbsupply.com • Serving our Customers Since 1946 • www.waterconcepts.net

Flush Valves

Commercial Electronic Flush Valves - DC Powered (Continued)

Tripoint® Touchless™ DC Toilet Flushometer Valve

Part #	Mfg #	Description	Finish	Price
128704	K-10957-SV-C P	1.6 gpf Exposed Flush Valve	Polished Chrome	
107948	K-10958-CP	0.5 gpf Exposed Flush Valve	Polished Chrome	
222205	K-10958-SV-C P	0.5 gpf Touchless DC Flush Valve	Polished Chrome	
183752	K-10960-SV-C P	1.0 gpf Exposed Flush Valve	Polished Chrome	

Tripoint® Exposed Hybrid Flushometer for Toilet Installation

- Powered by the 30-year Hybrid Energy System
- Electronic infrared sensor with Tripoint™ technology for accurate activation
- Intended for toilet installations with 1-1/2-inch top spud coupling connection
- Piston valve technology offers reliable and accurate flushing performance across pressures
- Activation distance is factory set - no adjustments on-site
- Chloramine resistance on all rubber exposed to waterway
- Manual courtesy flush button (works without DC power)



Part #	Mfg #	Description	Finish	Price
181675	K-7531-CP	1.28 gpf Exposed Hybrid Flush Valve	Polished Chrome	
186311	K-7535-CP	1.60 gpf Exposed Hybrid Flush Valve	Polished Chrome	
172753	K-7539-CP	1.0 gpf Exposed Hybrid Flush Valve	Polished Chrome	
186312	K-7542-CP	1.0 gpf Exposed Hybrid Flush Valve	Polished Chrome	

Wave Touchless Flushometer Valve

- Water-saving .5 gpf toilet model
- Manual override flushes even if the batteries have expired
- 24-Hour sentinel flush keeps trapway fresh
- Waterproof shroud protects electronic components



Part #	Mfg #	Description	Finish	Price
133010	K-10675SVCP	0.5 gpf Exposed Flush Valve	Polished Chrome	

*Vibrant Limited Lifetime Finish

www.waterconcepts.net • Serving our Customers Since 1946 • www.plumbsupply.com

Flush Valves

Wave Touchless Hybrid Flushometer

- Metal construction
- Top spud
- Piston technology
- 24-hour sentinel flush
- Manual courtesy flush button
- Powered by the 30-Year hybrid energy system
- Chloramine resistance on all rubber exposed to waterway
- For toilet installations with 3/4" top spud coupling connection
- Electronic infrared sensor with WAVE technology for accurate activation
- Activation distance is factory set - no adjustments on-site
- 24-Hour sentinel flush keeps trapway fresh



Part #	Mfg #	Description	Finish	Price
181092	K-7523-CP	1.6 gpf, Top Spud	Polished Chrome	
232339	K-7526-CP	0.5 gpf, Top Spud	Polished Chrome	
170203	K-7528-CP	0.125 gpf, Washdown Top Spud	Polished Chrome	

Bedpan Washers

Bedpan Washer

- Brass construction
- Machined aluminum double foot control
- Self-closing 14" hinged pedal action
- 3/8" NPT inside threaded inlets
- Outlet to wall with volume control
- Elevated vacuum breaker
- Hose with angle spray nozzle
- Insulated handle and spray hook



Part #	Mfg #	Description	Finish	Price
063788	K-13960-CP	Double Foot Control	Polished Chrome	

*Vibrant Limited Lifetime Finish

www.plumbsupply.com • Serving our Customers Since 1946 • www.waterconcepts.net

Flush Valves

Electronic Flush Valves - Commercial

- 5-Year limited warranty

M-Power™ Battery Powered Exposed Style Closet Flush Valve

- 1" IPS Supply and 1-1/2" top stud
- Adjustable sensor eyes
- Powered by (4) standard AA batteries (included)
- Low battery indicator light
- Piston flushing mechanism
- Self cleaning filter system
- 1.6 gpf & 24 Hour sentinel flush
- Manual override button
- Vandal resistant 1" IPS angle stop



8310

Part #	Mfg #	Description	Price
007351	8310	Battery Powered Closet Flush Valve	
165288	8310AC16	1.6 gpm 1-1/2" AC Powered Sensor	

M-Power™ Battery Powered Exposed Style Urinal Flush Valve

- Brass construction with chrome plated finish
- 3/4" IPS Supply and 3/4" Top stud
- Adjustable sensor eyes
- Powered by (4) standard AA batteries (included)
- Piston flushing mechanism
- Self cleaning filter system
- 1.0 gpf & 24 Hour sentinel flush
- Flush valve manual override button
- 3/4" IPS Angle stop valve



8312

Part #	Mfg #	Description	Price
096645	8312	Battery Powered Exposed Urinal Flush Valve	
165287	8312AC10	3/4" AC Powered Sensor Exposed Urinal Flush Valve	
177078	8315	3/4" Battery Powered Sensor Exposed Urinal Flush Valve	

*Lifeshine® Anti-Tarnish Lifetime Finish

www.waterconcepts.net • Serving our Customers Since 1946 • www.plumbsupply.com

Flush Valves

Urinal Rinse Down Valves

- Polished chrome plate finish
- Oscillating handles or push buttons
- 1/2" NPT Female inlet
- 3/4" OD x 8" Long riser



732-CP

732-OH

Part #	Mfg #	Description	Price
002905	732-CP	NAIAD Chrome-Plated, Self-Closing Angle Valve	
002906	732-OH	NAIAD Self-Closing Angle Valve, Long Bonnet Non-Sag Oscillating Handle	



Generic Replacement Parts

Gerber O-Rings

O-Ring



Part #	Mfg #	Description	Price
093297	92-257	O-Ring	
004803	92-730	O-Ring	

Faucets & Valves

*Physical Vapor Deposition (PVD) Limited Lifetime Finish

www.waterconcepts.net • Serving our Customers Since 1946 • www.plumbsupply.com

Generic Replacement Parts

Washers

Korky® EasySort® Washer



Part #	Mfg #	Description	Price
006192	180	1/4S Dk Brown Flat Faucet	
006193	181	1/4M Dk Blue Flat Faucet	
006194	182	1/4R Dk Green Flat Faucet	
006196	184	3/8R Gray Flat Faucet	
006197	185	3/8L Orchid Flat Faucet	
006198	186	1/2R Hot Pink Flat Faucet	
006183	150	1/4S Dk Brown Beveled Faucet	
006184	150-1	1/4M Dk Blue Beveled Faucet	
006185	151	1/4R Dk Green Beveled Faucet	
006186	152	1/4L Dk Purple Beveled Faucet	

Washer Kits

- In plastic utility case



Part #	Mfg #	Description	Price
028283	149	Korky Master Kit Asst	
006200	189	200 Pc Flat Assortment	

Hose Washer



Part #	Mfg #	Description	Price
006218	51	Hose Washer Display, 48 Clips with 8 Washers per Clip	

Graphite String Packing



Part #	Mfg #	Size	Qty	Price
006202	2-1/2	21"	25/Pk	

O-Ring Kits

- 1/16" Wall thickness
- Made of Nitrile rubber



Part #	Mfg #	Description	Price
030030	POR62	400 O-Rings In 20 Sizes	
022925	K200	200 O-Rings in 12 Sized Plumber's Pack Kit	



Generic Replacement Parts

Gunk® Faucet Washers



Golden State® Beveled Washers

Part #	Mfg #	Size	Pkg Qty	Price
008885	W-132	1/4"	100	

Faucets & Valves

Generic Replacement Parts

O-Rings

Buna-N O-Ring Kit

- (150) Assorted o-rings



Part #	Mfg #	Plastic Box	Price
135282	291-30380	(12) Compartments	

Washers

Rubber Washer Kit

- Includes:
 - (150) Assorted washers
 - (6) 10-24 Bibb screws



Part #	Mfg #	Type of Washer Kit	Price
147954	291-30125	Flat	
147955	291-30225	Beveled	

Hose Washer

- Standard rubber hose washer



Part #	Mfg #	Hose Washer	Price
183399	291-30500	Rubber	

Supply Step Washer for Lavatory or Closet

- Deluxe rubber lavatory supply washer with brass friction ring

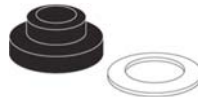

Part #	Mfg #	For	Height	Price
183397	290-20482	Closet	7/16"	

Gaskets

No-Putty Gasket™

- Replaces plumbers putty, won't dry out, stain or smudge
- Self adhesive eliminates mess
- Creates a tight seal on all finishes and materials
- Fits all standard drain attachments
- Allows you to pre-fab fixtures
- Stands up to the toughest commercial cleaners



290-20320



290-20322



290-20324

Part #	Mfg #	Description	Price
183385	290-20320	4-1/4" O.D. x 3-3/8" I.D., For Kitchen Basket Strainer	
183395	290-20322	2" O.D. x 1-1/2" I.D., For Lav Drain & Kit Spray Hose Guide	
183396	290-20324	2-3/4" O.D. x 2" I.D., For Laundry&Bar Sink, Tub Drain	

Tub Overflow Gasket

- Molded sponge



Part #	Mfg #	Description	Price
184087	974-60116	Molded Tub Overflow Gasket	

Hot Water Dispensers

Hot/Cold Water Dispensers

GN1100 Indulge™ Contemporary ADA Lever Hot Water Dispenser

- Gooseneck spout
- F-201 Filtration System included
- Hot Only - dispenses 60 cups of water filtered near-boiling water per hour
- Adjustable thermostat control
- Durable all brass faucet construction
- 1/2 Gallon tank capacity
- 5-Year We Come To You™ warranty



Part #	Mfg #	Model	Faucet Finish/Color	Price
092146	F-GN1100C	GN-1100C Less Tank	Chrome	

H770 Invite™ Twist Top Hot Water Dispenser

- Dispenses 60 cups of near-boiling water per hour
- Adjustable thermostat control
- Patented DuraTank™ hot water tank system
- 2/3 Gallon stainless steel tank
- 3-Year We Come to You™ warranty



Part #	Mfg #	Model	Faucet Finish/Color	Price
092166	H770-SS	H770-SS	Chrome/Black	

Hot100 Instant Hot Water Dispenser

- 2/3 gallon tank delivers 60 cups of near boiling 200°F water per hour
- 1-Year We Come To You™ In-Home Service Warranty
- Tool-free tank connections and dry-start protection to ease installation
- Easy-to-adjust temperature control
- Easy-push button activation
- 115 volts, 750 watts, 6.25 amps



Part #	Mfg #	Model	HP	Grind Stages	Warranty	Price
177386	Hot100-C	Hot100-C	Chrome			

H-View -SS Instant Hot Water Dispenser

- Includes 2/3 gallon Stainless Steel tank that delivers 60 cups/hour of near-boiling 200°F water
- Compact all metal dispenser construction
- InSinkErator 3-Year We Come To You® In-Home Full Service Limited Warranty Covers parts and labor
- UL listed
- 115 volts, 750 watts, 6.25 amps



Part #	Mfg #	Model	HP	Grind Stages	Warranty	Price
121727	H-VIEW-SS-C	H-View-SS-C	Chrome			
133548	H-VIEW-SS-SN	H View-SS-SN	Satin Nickel			

Hot Water Dispensers

HC-View -SS-C Instant Hot Water Dispenser

- Includes 2/3 gallon Stainless Steel tank that delivers 60 cups/hour of near-boiling 200°F water and cool drinking water
- Compact all metal dispenser construction
- InSinkErator 3-Year We Come To You® In-Home Full Service Limited Warranty Covers parts and labor
- UL listed
- 115 volts, 750 watts, 6.25 amps
- Available in two finishes: Chrome and Satin Nickel



Faucets & Valves

Part #	Mfg #	Model	HP	Grind Stages	Warranty	Price
157394	HC-VIEW-SS-C	HC-View-SS-C	Chrome			

Kitchen Faucets & Accessories

Pot Fillers

Artifacts™ Deck-Mount Pot Filler

- Brass construction
- Lever handles
- Articulating spout with 360° rotation, 22" extended reach
- Flow rate: 3.2 gpm



Part #	Mfg #	Holes	Mount	Handle(s)	Finish	Price
188552	K-99271-CP	1	Deck-Mount	Lever	Polished Chrome	

Artifacts™ Wall-Mount Pot Filler

- Brass construction
- Lever handles
- Articulating spout with 360° rotation, 22" extended reach
- Flow rate: 3.2 gpm



Part #	Mfg #	Holes	Mount	Handle(s)	Finish	Price
183663	K-99270-CP	1	Wall-Mount	Lever	Polished Chrome	
176375	K-99270-VS	1	Wall-Mount	Lever	*Stainless	
222913	K-99270-2BZ	1	Wall-Mount	Lever	Oil-Rubbed Bronze	

HiRise® Deck-Mount Pot Filler

- Stainless steel
- ADA lever handles
- 22" Extended swing spout reach
- Flow rate: 4 gpm



Part #	Mfg #	Holes	Mount	Handle(s)	Finish	Price
091295	K-7323-4-BS	1	Deck-Mount	ADA Lever	Brushed Stainless	

HiRise® Wall-Mount Pot Filler

- Stainless steel
- ADA lever handles
- 24" Extended swing spout reach
- Flow rate: 4 gpm



Part #	Mfg #	Holes	Mount	Handle(s)	Finish	Price
093684	K-7322-4-BS	1	Wall-Mount	ADA Lever	Brushed Stainless	
114138	K-7322-4-S	1	Wall-Mount	ADA Lever	Polished Stainless	

* Vibrant Limited Lifetime Finish

www.waterconcepts.net • Serving our Customers Since 1946 • www.plumbsupply.com

Kitchen Faucets & Accessories

Pull-Down Spray Kitchen Faucets

Artifacts® 1-Hdl Pull-Down Spray Kitchen Faucet

- 3-Function sprayhead:
 - Sweep™
 - BerrySoft™
 - Aerated stream
- DockNetik™ magnetic docking system
- Ceramic disc valves
- ProMotion® technology's light
- MasterClean™ sprayface
- Flow rate: 1.8 gpm @ 60 psi



Part #	Mfg #	Holes	Reach	Spout	Handle(s)	Finish	Price
175222	K-99259-CP	1	9-1/16"	360°	ADA Lever	Polished Chrome	
172618	K-99259-SN	1	9-1/16"	360°	ADA Lever	*Polished Nickel	
176859	K-99259-VS	1	9-1/16"	360°	ADA Lever	*Stainless	
177285	K-99259-2BZ	1	9-1/16"	360°	ADA Lever	Oil-Rubbed Bronze	

Artifacts® 1-Hdl Pull-Down Spray Kitchen Faucet with ADA Lever Handle

- 9-1/16" Spout reach with 360° spout rotation
- 9-5/8" From deck to aerator
- 3-Function sprayhead:
 - Sweep™
 - BerrySoft™
 - Aerated stream
- DockNetik™ magnetic docking system
- Ceramic disc valves
- ProMotion® technology's light
- MasterClean™ sprayface
- Flow rate: 1.8 gpm @ 60 psi



Part #	Mfg #	Holes	Reach	Spout	Handle(s)	Finish	Price
225039	K-99260-SN	1	9-1/16"	360°	ADA Lever	*Polished Nickel	
222410	K-99260-2BZ	1	9-1/16"	360°	ADA Lever	Oil-Rubbed Bronze	

* Vibrant Limited Lifetime Finish

www.plumbsupply.com • Serving our Customers Since 1946 • www.waterconcepts.net

Kitchen Faucets & Accessories

Faucets & Valves

Beckon™ 1-Hdl Electronic Pull-Down Spray Kitchen Faucet

- 8-7/16" Spout reach, 15-7/8" height, with 290° spout rotation
- Ceramic disc valves
- Response™ technology
- DockNetik™ magnetic docking system
- ProMotion® nylon hose and ball joint
- MasterClean™ sprayface
- Temperature memory
- 2-Function sprayhead can switch from stream to Sweep™ spray
- Meets CalGreen requirements for kitchen faucets
- Flow rate: 1.8 gpm @ 60 psi



Part #	Mfg #	Holes	Reach	Height	Spout	Handle(s)	Finish	Price
186936	K-99332-SN	1	8-7/16"	15-7/8"	290°	ADA Lever	*Polished Nickel	
185502	K-99332-VS	1	8-7/16"	15-7/8"	290°	ADA Lever	*Stainless	
224116	K-99332-2BZ	1	8-7/16"	15-7/8"	290°	ADA Lever	Oil-Rubbed Bronze	

Bellera® 1-Hdl Pull-Down Spray Kitchen Faucet with High Arc Spout

- 7-7/8" Spout reach, 10-3/16" height, with 360° spout rotation
- One-piece, self-contained ceramic disc valve
- Temperature memory
- Touch control for stream-to-spray water flow
- MasterClean™ sprayface
- ProMotion™ technology with nylon hose and ball joint
- Flexible connections
- 3-Function sprayhead with spray, aerated stream and pause settings
- Maximum flow rate: 1.8 gpm @ 60 psi



Part #	Mfg #	Holes	Reach	Height	Spout	Handle(s)	Finish	Price
143501	K-560-CP	1- or 3-Hole	7-7/8"	10-3/16"	360°	Side ADA Lever	Polished Chrome	
142788	K-560-VS	1- or 3-Hole	7-7/8"	10-3/16"	360°	Side ADA Lever	*Stainless	
147008	K-560-2BZ	1- or 3-Hole	7-7/8"	10-3/16"	360°	Side ADA Lever	Oil-Rubbed Bronze	

Cruette® 1-Hdl Pull-Down Spray Kitchen Faucet with Escutcheon and Lever Handle

- 7-7/8 Spout reach with 360° spout rotation
- Premium metal construction
- One-piece, self-contained ceramic disc
- Temperature memory
- Promotion™ nylon hose and ball joint
- Flexible supply lines
- 3-Function touch control sprayhead with spray, aerated stream and pause settings
- Maximum flow rate: 1.8 gpm @ 60 psi



Part #	Mfg #	Holes	Reach	Spout	Handle(s)	Finish	Price
143347	K-780-CP	1- or 3-Hole	7-7/8"	360°	ADA Lever	Polished Chrome	
142789	K-780-VS	1- or 3-Hole	7-7/8"	360°	ADA Lever	*Stainless	
147013	K-780-2BZ	1- or 3-Hole	7-7/8"	360°	ADA Lever	Oil-Rubbed Bronze	

* Vibrant Limited Lifetime Finish

www.waterconcepts.net • Serving our Customers Since 1946 • www.plumbsupply.com

Kitchen Faucets & Accessories

Sensate™ Touchless Kitchen Faucet with 15-1/2" Pull-Down High-Arch Spout and ADA Lever Handle

- 8-7/16" Spout reach
- Premium metal construction
- Response technology.
- LED light indicates faucet is operational and ready to go.
- Two-function sprayhead with touch-control switches from stream to Sweep® spray.
- Temperature memory
- DockNetik™ magnetic docking system
- ProMotion™ nylon hose and ball joint
- MasterClean™ sprayface
- 3-Hole escutcheon kit available (K-1209172-CP/VS)
- Maximum flow rate: 1.8 gpm @ 60 psi



Part #	Mfg #	Holes	Reach	Handle(s)	Finish	Price
155920	K-72218-CP	1	8-7/16"	ADA Lever	Polished Chrome	
155627	K-72218-VS	1	8-7/16"	ADA Lever	*Stainless	
227210	K-72218-2BZ	1	8-7/16"	ADA Lever	Oil-Rubbed Bronze	
155400	K-72218-B7-CP	1	8-7/16"	ADA Lever	Polished Chrome with Black Accents	
164432	K-72218-B7-VS	1	8-7/16"	ADA Lever	*Stainless with Black Accents	

Simplice® Pull-Down Spray Kitchen Faucet with High-Arch Gooseneck Spout and Lever Handle

- 9" Spout reach, 16-5/8" height with 360° spout rotation
- Premium metal construction
- One-piece, self-contained ceramic disc valve
- Temperature memory
- DockNetik magnetic docking system
- Promotion™ technology
- MasterClean™ sprayface
- Flexible supply lines and installation ring
- Touch control for stream-to-spray water flow
- 3-Function sprayhead allows you to switch from stream to Sweep® spray to pause
- Maximum flow rate: 1.8 gpm @ 60 psi



596-CP

Part #	Mfg #	Holes	Reach	Spout	Rotation	Handle(s)	Finish	Price
126049	K-596-BL	1- or 3-Hole	9"	16-5/8"	360°	ADA Lever	Matte Black	
118248	K-596-CP	1- or 3-Hole	9"	16-5/8"	360°	ADA Lever	Polished Chrome	
118247	K-596-VS	1- or 3-Hole	9"	16-5/8"	360°	ADA Lever	*Stainless	
145817	K-597-BL	1- or 3-Hole	8"	15-3/8"	360°	ADA Lever	Matte Black	
118250	K-597-CP	1- or 3-Hole	8"	15-3/8"	360°	ADA Lever	Polished Chrome	
118249	K-597-VS	1- or 3-Hole	8"	15-3/8"	360°	ADA Lever	*Stainless	

* Vibrant Limited Lifetime Finish

www.plumbsupply.com • Serving our Customers Since 1946 • www.waterconcepts.net

Kitchen Faucets & Accessories

Faucets & Valves

Simplice™ Pull-Down Spray Kitchen Faucet with High-Arch Gooseneck Swing Spout and Lever Handle

- 9" Spout reach, 16-1/8" height with 360° spout rotation
- Premium metal construction
- One-piece, self-contained ceramic disc valve
- Remote valve configuration
- DockNetick™ magnetic docking system
- Promotion™ light, quiet nylon hose and ball joint
- MaterClean™ sprayface
- Temperature memory with high-temperature limit setting for added safety
- Flexible supply lines and installation ring
- 3-Function sprayhead allows you to switch from stream to Sweep® spray to pause



Part #	Mfg #	Holes	Reach	Spout	Rotation	Handle(s)	Finish	Price
121515	K-647-BL	2-Hole	9"	16-1/8"	360°	ADA Lever	Matte Black	
102467	K-647-CP	2-Hole	9"	16-1/8"	360°	ADA Lever	Polished Chrome	
102465	K-647-VS	2-Hole	9"	16-1/8"	360°	ADA Lever	*Stainless	
122062	K-649-BL	2-Hole	9"	16-1/8"	360°	ADA Lever	Matte Black	
102468	K-649-CP	2-Hole	8"	14-3/8"	360°	ADA Lever	Polished Chrome	
102466	K-649-VS	2-Hole	8"	14-3/8"	360°	ADA Lever	*Stainless	

Vinnata® Pull-Down Spray Kitchen Faucet with High-Arch Gooseneck Swing Spout and Lever Handle

- 9-1/2" Spout reach, 16-5/8" height with 360° spout rotation
- Premium metal construction
- One-piece, self-contained ceramic disc valves
- Handle can be installed on right side, left side, or front of faucet
- Integral vacuum breaker
- Promotion™ light, quiet nylon hose and ball joint
- MaterClean™ sprayface
- Temperature memory with high-temperature limit setting for added safety
- Flexible supply lines and installation ring
- Two-function pull-down sprayhead with touch-control allows you to switch from stream to spray
- Includes 10-1/2" escutcheon for 3-hole installations 2-1/2" escutcheon for 1-hole installations
- Maximum flow rate: 1.8 gpm @ 60 psi



Part #	Mfg #	Holes	Reach	Spout	Handle(s)	Finish	Price
066120	K-690-BN	1- or 3-Hole	9-1/2"	16-5/8"	ADA Lever	*Brushed Nickel	
097235	K-690-BV	1- or 3-Hole	9-1/2"	16-5/8"	ADA Lever	*Brushed Bronze	
066118	K-690-CP	1- or 3-Hole	9-1/2"	16-5/8"	ADA Lever	Polished Chrome	
066119	K-690-G	1- or 3-Hole	9-1/2"	16-5/8"	ADA Lever	Brushed Chrome	
086139	K-690-SN	1- or 3-Hole	9-1/2"	16-5/8"	ADA Lever	*Polished Nickel	
097400	K-690-VS	1- or 3-Hole	9-1/2"	16-5/8"	ADA Lever	*Stainless	
147011	K-690-2BZ	1- or 3-Hole	9-1/2"	16-5/8"	ADA Lever	Oil-Rubbed Bronze	
067523	K-691-BN	1- or 3-Hole	7-1/2"	15-1/8"	ADA Lever	*Brushed Nickel	
080215	K-691-BV	1- or 3-Hole	7-1/2"	15-1/8"	ADA Lever	*Brushed Bronze	
066121	K-691-CP	1- or 3-Hole	7-1/2"	15-1/8"	ADA Lever	Polished Chrome	
069880	K-691-G	1- or 3-Hole	7-1/2"	15-1/8"	ADA Lever	Brushed Chrome	
084666	K-691-SN	1- or 3-Hole	7-1/2"	15-1/8"	ADA Lever	*Polished Nickel	
097401	K-691-VS	1- or 3-Hole	7-1/2"	15-1/8"	ADA Lever	*Stainless	

* Vibrant Limited Lifetime Finish

www.waterconcepts.net • Serving our Customers Since 1946 • www.plumbsupply.com

Kitchen Faucets & Accessories

Pull-Down Spray Kitchen Faucets (Continued)

Vinnata® Pull-Down Spray Kitchen Faucet with High-Arch Gooseneck Swing Spout and Lever Handle

Part #	Mfg #	Holes	Reach	Spout	Handle(s)	Finish	Price
147012	K-691-2BZ	1- or 3-Hole	7-1/2"	15-1/8"	ADA Lever	Oil-Rubbed Bronze	

Pull-Out Spray Kitchen Faucets

Coralais® 1-Hdl Kitchen Faucet with Pull-Out Matching Color Sprayhead and Rotating Spout

- 9" Reach, 11" high swivel spout
- Premium metal construction
- One-piece, self-contained ceramic disc valves
- Integral vacuum breaker
- Promotion™ light, quiet nylon hose and ball joint
- MaterClean™ sprayface
- Temperature memory with high-temperature limit setting for added safety
- Flexible supply lines
- Two-function pull-out sprayhead with touch-control switches from stream to spray
- Maximum flow rate: 1.8 gpm @ 60 psi



Part #	Mfg #	Holes	Reach	Height	Handle(s)	Finish	Price
055157	K-15160-96	1-Hole	9"	11"	ADA Lever	Biscuit	
067251	K-15160-BN	1-Hole	9"	11"	ADA Lever	*Brushed Nickel	
055155	K-15160-CP	1-Hole	9"	11"	ADA Lever	Polished Chrome	
073153	K-15160-L-BN	1-Hole	9"	11"	ADA Loop Lever	*Brushed Nickel	
056784	K-15160-L-CP	1-Hole	9"	11"	ADA Loop Lever	Polished Chrome	
109419	K-15160-L-G	1-Hole	9"	11"	ADA Loop Lever	Brushed Chrome	
061367	K-15160-L-0	1-Hole	9"	11"	ADA Loop Lever	White	
064551	K-15160-L-7	1-Hole	9"	11"	ADA Loop Lever	Black	
112729	K-15160-L-96	1-Hole	9"	11"	ADA Loop Lever	Biscuit	

Elate™ 1-Hdl Pull-Out Spray Kitchen Faucet with High-Arch Swing Spout and 10-1/2" Escutcheon Plate

- 9" Spout reach, 12-11/16" height
- Premium metal construction
- One-piece, self-contained ceramic disc valve
- Temperature memory
- Integral pull-out sprayhead with retractable hose
- ProMotion™ light, quiet nylon hose and ball joint
- MasterClean™ sprayface
- Flexible supply lines
- 3-function sprayhead with touch-control switches from stream to spray to pause
- Maximum flow rate 1.8 gpm @ 60 psi



Part #	Mfg #	Holes	Reach	Height	Handle(s)	Finish	Price
136822	K-13963-CP	3-Hole	9"	12-11/16"	ADA Lever	Polished Chrome	
132863	K-13963-VS	3-Hole	9"	12-11/16"	ADA Lever	*Stainless	

* Vibrant Limited Lifetime Finish

www.plumbsupply.com • Serving our Customers Since 1946 • www.waterconcepts.net

Kitchen Faucets & Accessories

Faucets & Valves

Evoked® Pull-Out Spray Kitchen Faucet with Lever Handle

- 9" Spout reach, 11-5/16" height with 360° spout rotation
- Premium metal construction
- One-piece, self-contained ceramic disc valve
- Temperature memory with high temperature limit setting
- ProMotion® light, quiet nylon hose and ball joint
- MasterClean™ sprayface
- Flexible supply lines
- Maximum flow rate: 1.8 gpm @ 60 psi



Part #	Mfg #	Holes	Reach	Spout	Rotation	Handle(s)	Finish	Price
109267	K-6331-CP	1-Hole	9"	11-5/16"	360°	ADA Lever	Polished Chrome	
109791	K-6331-VS	1-Hole	9"	11-5/16"	360°	ADA Lever	*Stainless	

Fairfax® Kitchen Faucet with Pull-Out Matching Color Sprayhead, High Swing Spout, Lever Handle

- 9" Spout reach, 8-3/8" height
- Premium metal construction
- One-piece, self-contained ceramic disc valve
- Temperature memory with high temperature limit setting
- ProMotion® light, quiet nylon hose and ball joint
- MasterClean™ sprayface
- Integral vacuum breaker
- Flexible supply lines
- Includes 10" escutcheon for 3-hole installation and one white plug button
- 2-function sprayhead with touch-control allows you to switch from stream to spray
- Maximum flow rate: 1.8 gpm @ 60 psi



Part #	Mfg #	Holes	Reach	Height	Handle(s)	Finish	Price
057325	K-12177-BN	1-or 3-Hole	9"	8-3/8"	ADA Lever	*Brushed Nickel	
053607	K-12177-CP	1-or 3-Hole	9"	8-3/8"	ADA Lever	Polished Chrome	
153199	K-12177-2BZ	1-or 3-Hole	9"	8-3/8"	ADA Lever	Oil Rubbed Bronze	

Forté® 1-Hdl Pull-Out Spray Kitchen Faucet with High-Arch Swing Spout and Lever Handle

- 10-1/8" Spout reach
- Premium metal construction with flexible supply lines
- One-piece, self-contained ceramic disc valve
- Temperature memory with high temperature limit setting
- ProMotion® light, quiet nylon hose and ball joint
- MasterClean™ sprayface
- Maximum flow rate: 1.8 gpm @ 60 psi



Part #	Mfg #	Holes	Reach/Spout	Handle(s)	Finish	Price
085879	K-10433-BN	1-or 3-Hole	10-1/8"	ADA Lever	*Brushed Nickel	
086231	K-10433-BV	1-or 3-Hole	10-1/8"	ADA Lever	*Brushed Bronze	
085822	K-10433-CP	1-or 3-Hole	10-1/8"	ADA Lever	Polished Chrome	
085968	K-10433-G	1-or 3-Hole	10-1/8"	ADA Lever	Brushed Chrome	
086209	K-10433-VS	1-or 3-Hole	10-1/8"	ADA Lever	*Stainless	

* Vibrant Limited Lifetime Finish

www.waterconcepts.net • Serving our Customers Since 1946 • www.plumbsupply.com

Kitchen Faucets & Accessories

Purist® 1-Hdl Pull-Out Spray Kitchen Faucet with High-Arch Swing Spout and Lever Handle

- 8" Spout reach, 11-3/8" height with 360° spout rotation
- One-piece, self contained ceramic disc valve
- Premium metal construction with flexible supply lines
- Temperature memory
- MasterClean™ sprayface
- Promotion™ light, quiet nylon hose and ball joint
- 3-Function sprayhead with touch control: laminar flow, spray, and pause setting
- Coordinates with other products in the Purist® collection
- Maximum flow rate: 1.8 gpm @ 60 psi



Part #	Mfg #	Holes	Reach	Spout	Rotation	Handle(s)	Finish	Price
133738	K-7505-BL	1	8"	11-3/8"	360°	ADA Lever	Matte Black	
142997	K-7505-CP	1	8"	11-3/8"	360°	ADA Lever	Polished Chrome	
144006	K-7505-SN	1	8"	11-3/8"	360°	ADA Lever	Polished Nickel	
132656	K-7505-VS	1	8"	11-3/8"	360°	ADA Lever	*Stainless	

Single-Handle Kitchen Faucets

Artifacts® Kitchen Faucet with High-Arch Swing Spout, Matching Finish Sidespray, Lever Handle

- 8-1/2" Spout reach, 14-11/16" height with 360° spout rotation
- Premium metal construction
- One-piece, self-contained ceramic disc valve
- 2-function sidespray with Sweep® spray and BerrySoft® spray
- Temperature memory
- ProMotion® technology
- MasterClean™ sprayface
- Available with 8-1/2" swing spout
- Maximum flow rate: 1.8 gpm @ 60 psi



Part #	Mfg #	Holes	Reach	Spout	Rotation	Handle(s)	Finish	Price
188551	K-99262-CP	2	8-1/2"	14-11/16"	360°	ADA Lever	Polished Chrome	
172619	K-99262-VS	2	8-1/2"	14-11/16"	360°	ADA Lever	*Stainless	

Artifacts® Kitchen Faucet with High-Arch Swing Spout, Matching Sidespray, Lever Handle

- 8-1/2" Spout reach, 13-1/2" height with 360° spout rotation
- Premium metal construction with flexible supply lines
- One-piece, self-contained ceramic disc valve
- 2-function sidespray with Sweep® spray and BerrySoft® spray
- Temperature memory
- ProMotion® technology
- MasterClean™ sprayface
- Available with 9" swing spout reach
- For two-hole or four-hole installation (3-Hole escutcheon available, sold separately, K-99272)
- Maximum flow rate: 1.8 gpm @ 60 psi



Part #	Mfg #	Holes	Reach	Spout	Rotation	Handle(s)	Finish	Price
222423	K-99265-VS	2	8-1/2"	13-1/2"	360°	ADA Lever	*Stainless	

* Vibrant Limited Lifetime Finish

www.plumbsupply.com • Serving our Customers Since 1946 • www.waterconcepts.net

Kitchen Faucets & Accessories

Faucets & Valves

Coralais® Kitchen Faucet with Swing Spout

- 8-1/2" Spout reach
- Premium metal construction
- Flexible supply lines
- One-piece, self-contained ceramic disc valve
- Temperature memory
- High-temperature limit setting
- Model (K-15173-P-CP) includes ground joint connections
- Maximum flow rate: 1.8 gpm @ 60 psi



Without Sidespray

Part #	Mfg #	Holes	Reach	Handle(s)	Finish	Price
073315	K-15171-F-CP	3	8-1/2"	ADA Lever	Polished Chrome	
169207	K-15171-F-G	3	8-1/2"	ADA Lever	Brushed Chrome	

With Matching Finish Sidespray

Part #	Mfg #	Holes	Reach	Handle(s)	Finish	Price
066908	K15172FCP	4	8-1/2"	ADA Lever	Polished Chrome	
068250	K-15172-F-BN	4	8-1/2"	ADA Lever	*Brushed Nickel	
069570	K-15172-F-G	4	8-1/2"	ADA Lever	Brushed Chrome	
182813	K-15172-FL-G	4	10"	ADA Loop Lever	Brushed Chrome	
067161	K-15176-F-CP	2	8-1/2"	ADA Lever	Polished Chrome	
168296	K-15176-TL-CP	2	10"	ADA Loop Lever	Polished Chrome	

With Matching Finish Sidespray in Escutcheon

Part #	Mfg #	Holes	Reach	Handle(s)	Finish	Price
067992	K-15173-F-CP	3	8-1/2"	ADA Lever	Polished Chrome	
177407	K-15173-F-G	3	8-1/2"	ADA Lever	Brushed Chrome	
190207	K-15173-P-CP	3	8-1/2"	ADA Lever	Polished Chrome	

Coralais® Project Pack Kitchen Faucet with Swing Spout, Escutcheon, and Sidespray

- 8-1/2" Reach, 8-5/8" high swivel spout
- For job business only
- Premium metal construction
- 3/8" Fitting on hoses fastnes directly to stops
- Contemporary/transitional styling
- Ceramic disc valves with flexible supply lines
- Temperature memory with high-temperature limit setting
- Maximum flow rate: 1.8 gpm @ 60 psi



Part #	Mfg #	Holes	Reach	SideSpray	Handle(s)	Finish	Price
077600	K-P15172-F-CP	4	8-1/2"	Chrome	ADA Lever	Polished Chrome	

* Vibrant Limited Lifetime Finish

www.waterconcepts.net • Serving our Customers Since 1946 • www.plumbsupply.com

Kitchen Faucets & Accessories

Fairfax® Kitchen Faucet with Arched Swing Spout, Matching Finish Sidespray, Lever Handle

- 9" Reach, 7-5/8" max handle height
- Premium metal construction
- Ceramic disc valves with flexible supply lines
- Temperature memory with high-temperature limit setting
- Includes one white ceramic plug button
- Maximum flow rate: 1.8 gpm @ 60 psi



Part #	Mfg #	Holes	Reach	Max Height	Handle(s)	Finish	Price
056595	K-12176-BN	2	9"	7-5/8"	ADA Lever	*Brushed Nickel	

Fairfax® Remote Valve Kitchen Faucet with High-Arch Swing Spout, Matching Sidespray, Lever Handle

- 9-3/8" Spout reach, 10-3/8" spout height
- 7-1/2" From deck to aerator
- Premium metal construction
- Brass valve bodies
- Temperature memory with high-temperature limit setting
- Ceramic disc valves with flexible supply lines
- Includes white plug buttons
- Maximum flow rate: 1.8 gpm @ 60 psi



Part #	Mfg #	Holes	Reach	Max Height	Handle(s)	Finish	Price
087525	K-12185-BN	3	9-3/8"	10-3/8"	ADA Lever	*Brushed Nickel	
097557	K-12185-CP	3	9-3/8"	10-3/8"	ADA Lever	Polished Chrome	

Forté® 1-Hdl Kitchen Faucet with 9-1/16" High-Arch Swing Spout

- 9-1/16" Spout reach
- Premium metal construction
- Temperature memory with high-temperature limit setting
- Ceramic disc valves with flexible supply lines
- Maximum flow rate: 1.8 gpm @ 60 psi



Without Sidespray

Part #	Mfg #	Holes	Reach	Handle(s)	Finish	Price
073752	K-10411-CP	3	9-1/16"	ADA Lever	Polished Chrome	
079964	K-10415-BN	1	9-1/16"	ADA Lever	*Brushed Nickel	
075691	K-10415-CP	1	9-1/16"	ADA Lever	Polished Chrome	

With Matching Finish Sidespray

Part #	Mfg #	Holes	Reach	Handle(s)	Finish	Price
071115	K-10412-BN	4	9-1/16"	ADA Lever	*Brushed Nickel	
078528	K-10412-BV	4	9-1/16"	ADA Lever	*Brushed Bronze	
073593	K-10412-CP	4	9-1/16"	ADA Lever	Polished Chrome	
080380	K-10412-G	4	9-1/16"	ADA Lever	Brushed Chrome	
097379	K-10412-VS	4	9-1/16"	ADA Lever	*Stainless	
073770	K-10416-BN	2	9-1/16"	ADA Lever	*Brushed Nickel	
072094	K-10416-CP	2	9-1/16"	ADA Lever	Polished Chrome	

* Vibrant Limited Lifetime Finish

www.plumbsupply.com • Serving our Customers Since 1946 • www.waterconcepts.net

Kitchen Faucets & Accessories

Single-Handle Kitchen Faucets (Continued)

**Forté® 1-Hdl Kitchen Faucet with 9-1/16" High-Arch Swing Spout
With Matching Finish Sidespray**

Part #	Mfg #	Holes	Reach	Handle(s)	Finish	Price
097378	K-10416-VS	2	9-1/16"	ADA Lever	*Stainless	

Forté® Remote Valve Kitchen Faucet with High-Arch Swing Spout and Matching Sidespray

- 9" Reach, 11-5/8" high swivel spout
- Premium metal construction
- Temperature memory with high-temperature limit setting
- Ceramic disc valves with flexible supply lines
- 3-Hole installation
- Maximum flow rate: 1.8 gpm @ 60 psi



Part #	Mfg #	Holes	Reach	Max Height	Handle(s)	Finish	Price
080383	K-10430-BN	3	9"	11-5/8"	ADA Lever	*Brushed Nickel	
083130	K-10430-CP	3	9"	11-5/8"	ADA Lever	Polished Chrome	
085927	K-10430-G	3	9"	11-5/8"	ADA Lever	Brushed Chrome	
097377	K-10430-VS	3	9"	11-5/8"	ADA Lever	*Stainless	

Karbon® 1-Hdl Articulating Deck-Mount Kitchen Faucet with 13" Tube Spout

- Spout reaches from less than 2" to over 13"
- 1-5/16" Diameter remote joystick valve
- Sturdy metal and carbon fiber construction
- Integral sprayhead
- Self-contained ceramic disc valve
- Flexible supply lines and installation ring
- Maximum flow rate: 1.8 gpm @ 60 psi



Part #	Mfg #	Holes	Tube Color	Joystick Dia.	Handle(s)	Finish	Price
139158	K-6227-C11-CP	2	Silver	1-5/16"	ADA Remote Lever	Polished Chrome	
114972	K-6227-C11-VS	2	Silver	1-5/16"	ADA Remote Lever	*Stainless	
140792	K-6227-C12-CP	2	Black	1-5/16"	ADA Remote Lever	Polished Chrome	
127936	K-6227-C12-VS	2	Black	1-5/16"	ADA Remote Lever	*Stainless	
154457	K-6227-C15-BV	2	Bronze	1-5/16"	ADA Remote Lever	*Brushed Bronze	

* Vibrant Limited Lifetime Finish

www.waterconcepts.net • Serving our Customers Since 1946 • www.plumbsupply.com

Kitchen Faucets & Accessories

Purist® 1-Hdl Kitchen Faucet with High-Arch Swing Spout

- 8" Reach, 11-3/8" high, 360° swivel spout
- Premium metal construction
- Self-contained ceramic disc valve
- Temperature memory
- Flexible supply lines and installation ring
- Coordinates with other products in the Purist® collection
- Maximum flow rate: 1.8 gpm @ 60 psi



Without Sidespray

Part #	Mfg #	Holes	Reach	Spout Rotation	Height	Handle(s)	Finish	Price
147998	K-7507-BL	1	8"	360°	11-3/8"	ADA Lever	Matte Black	
138659	K-7507-CP	1	8"	360°	11-3/8"	ADA Lever	Pol Chrome	
154171	K-7507-VS	1	8"	360°	11-3/8"	ADA Lever	*Stainless	

With Sidespray

Part #	Mfg #	Holes	Reach	Spout Rotation	Height	Handle(s)	Finish	Price
166749	K-7508-BL	2	8"	360°	11-3/8"	ADA Lever	Matte Black	
140343	K-7508-CP	2	8"	360°	11-3/8"	ADA Lever	Pol Chrome	
223583	K-7508-SN	2	8"	360°	11-3/8"	ADA Lever	*Pol Nickel	
176334	K-7508-VS	2	8"	360°	11-3/8"	ADA Lever	*Stainless	
183147	K-7511-VS	2	6"	360°	9-7/8"	ADA Lever	*Stainless	

Two-Handle Kitchen Faucets

Coralais® Kitchen Faucet with High-Arch Gooseneck Swing Spout—Requires Handles

- 9" Reach for 8" centers with 11-1/2" high spout
- Premium metal construction
- Reversible quarter-turn washerless ceramic disc valves
- Requires **K-15850-4M** ergonomic lever handles (sold separately)
- Maximum flow rate: 1.8 gpm @ 60 psi



Part #	Mfg #	Holes	Reach	Centers	Height	Handle(s)	Finish	Price
066774	K-15888-K-CP	3	9"	8"	11-1/2"	ADA Lever	Pol Chrome	

Coralais® Kitchen Faucet with Swing Spout, Matching Finish Sidespray, and Lever Handles

- 7-5/8" Reach, 6-7/8" high spout
- Premium metal construction
- Reversible quarter-turn washerless ceramic disc valves
- Ergonomic handle rotation
- Maximum flow rate: 1.8 gpm @ 60 psi



Part #	Mfg #	Holes	Reach	Spout Height	Handle(s)	Finish	Price
081987	K-15253-4-CP	4	7-5/8"	6-7/8"	ADA Lever	Polished Chrome	

* Vibrant Limited Lifetime Finish

www.plumbsupply.com • Serving our Customers Since 1946 • www.waterconcepts.net

Kitchen Faucets & Accessories

Faucets & Valves

Essex® Kitchen Faucet with High-Arch Gooseneck Spout and Handles

- 9-1/4" Reach, 15-1/2" high spout
- 9-5/16" From deck to aerator
- Solid-brass construction
- Ceramic disc valves
- Single-hole or three-hole installation (escutcheon sold separately)
—Requires escutcheon for three-hole installations
- Maximum flow rate: 1.8 gpm @ 60 psi



Part #	Mfg #	Holes	Reach	Spout Height	Handle(s)	Finish	Price
082542	K-8762-CP	1	9-1/4"	15-1/2"	ADA Wrist Blade Lever	Polished Chrome	

Forte® 2-Hdl Kitchen Faucet with High-Arch Swing Spout and Matching Finish Sidespray

- 7-3/4" Reach swivel spout
- Premium metal construction
- UltraGlide™ engineered ceramic disc valves
- Two ergonomic handles pre-assembled on valves
- Flexible supply lines
- Maximum flow rate: 1.8 gpm @ 60 psi



Part #	Mfg #	Holes	Reach	Spout Height	Handle(s)	Finish	Price
113690	K-10445-BN	4	7-3/4"	10-1/8"	ADA Lever	*Brushed Nickel	
117451	K-10445-CP	4	7-3/4"	10-1/8"	ADA Lever	Polished Chrome	

HiRise® Kitchen Faucet with 10" High-Arch Gooseneck Spout and Lever Handles

- 10-1/4" Reach, 17-1/2" high swivel spout
- Stainless steel construction
- Two quarter-turn washerless ceramic disc valves
- Coordinates with other HiRise® kitchen products
- Flexible supply lines and installation ring
- Maximum flow rate: 1.8 gpm @ 60 psi



Part #	Mfg #	Holes	Reach	Spout Rotation	Height	Handle(s)	Finish	Price
111514	K-7341-4-BS	1	10-1/4"	17-1/2"	360°	ADA Lever	Br. Stainless	
183144	K-7341-4-S	1	10-1/4"	17-1/2"	360°	ADA Lever	Pol Stainless	

HiRise® Wall-Mount Bridge Kitchen Faucet with 13-7/8" High-Arch Gooseneck Spout and Lever Handles

- 10-1/4" Reach, 360° swivel spout, 8" Centers
- Stainless steel construction
- Two quarter-turn washerless ceramic disc valves
- UltraGlide™ engineered ceramic disc valves
- Coordinates with other HiRise® kitchen products
- Maximum flow rate: 1.8 gpm @ 60 psi



Part #	Mfg #	Centers	Reach	Spout Rotation	Height	Handle(s)	Finish	Price
183143	K-7338-4-BS	8"	10-1/4"	13-7/8"	360°	ADA Lever	Br. Stainless	
183366	K-7338-4-S	8"	10-1/4"	13-7/8"	360°	ADA Lever	Pol. Stainless	

* Vibrant Limited Lifetime Finish

www.waterconcepts.net • Serving our Customers Since 1946 • www.plumbsupply.com

Kitchen Faucets & Accessories

HiRise® Deck-Mount Bridge Kitchen Faucet with High-Arch Gooseneck Spout and Lever Handles

- 10-1/4" Reach, 18-1/8" high, 360° spout
- Stainless steel construction
- Two quarter-turn washerless ceramic disc valves
- UltraGlide™ engineered ceramic disc valves
- Two-hole installation for 8" centers
- Coordinates with other HiRise® kitchen products
- Maximum flow rate: 1.8 gpm @ 60 psi



Part #	Mfg #	Holes	Reach	Spout Rotation	Height	Handle(s)	Finish	Price
182348	K-7337-4-S	2	10-1/4"	18-1/8"	360°	ADA Lever	Pol Stainless	

Parq® Deck-Mount Bridge Kitchen Faucet with High-Arch Gooseneck Spout and Tri Handles

- 9" Spout reach, 14-11/16" High spout
- Metal construction
- Flexible supply lines
- Two quarter-turn washerless ceramic disc valves
- UltraGlide™ engineered ceramic disc valves
- 360° Swing spout with 8-1/2" clearance below spout
- Maximum flow rate: 1.8 gpm @ 60 psi



Without Sidespray

Part #	Mfg #	Holes	Reach	Spout Rotation	Height	Handle(s)	Finish	Price
181937	K-6130-3-SN	2	9"	14-11/16"	360°	ADA Cross	*Polished Nickel	
129974	K-6130-3-VS	2	9"	14-11/16"	360°	ADA Cross	*Stainless	
171794	K-6130-3-2BZ	2	9"	14-11/16"	360°	ADA Cross	Oil-Rubbed Bronze	
128391	K-6130-4-CP	2	9"	14-11/16"	360°	ADA Lever	Polished Chrome	
138664	K-6130-4-VS	2	9"	14-11/16"	360°	ADA Lever	*Stainless	

With Matching Finish Sidespray

- Ceramic disc valves
- MasterClean™ sprayface
- ProMotion light, quiet nylon hose and ball joint

Part #	Mfg #	Holes	Reach	Spout Rotation	Height	Handle(s)	Finish	Price
157759	K-6131-3-CP	3	9"	14-11/16"	360°	ADA Cross	Polished Chrome	
129976	K-6131-3-VS	3	9"	14-11/16"	360°	ADA Cross	*Stainless	
156202	K-6131-3-SN	3	9"	14-11/16"	360°	ADA Cross	Polished Nickel	
163693	K-6131-3-2BZ	3	9"	14-11/16"	360°	ADA Cross	Oil-Rubbed Bronze	
134668	K-6131-4-CP	3	9"	14-11/16"	360°	ADA Lever	Polished Chrome	
124195	K-6131-4-VS	3	9"	14-11/16"	360°	ADA Lever	*Stainless	
151399	K-6131-4-2BZ	3	9"	14-11/16"	360°	ADA Lever	Oil-Rubbed Bronze	

* Vibrant Limited Lifetime Finish

www.plumbsupply.com • Serving our Customers Since 1946 • www.waterconcepts.net

Kitchen Faucets & Accessories

Faucets & Valves

Purist® Deck-Mount Bridge Kitchen Sink Faucet with 8-3/8" High Spout and Lever Handles

- 8-3/8" Spout reach, 12-1/2" height, 360° spout rotation
- Two quarter-turn washerless ceramic disc valves
- Flexible supply lines and installation ring
- Two-hole installation for 8" centers
- Coordinates with other products in the Purist® collection
- 360° Swing spout with 10" clearance below spout
- Available with or without sidespray
- Maximum flow rate: 1.8 gpm @ 60 psi



Without Sidespray

Part #	Mfg #	Holes	Reach	Spout Rotation	Height	Handle(s)	Finish	Price
226887	K-7547-4-CP	2	8-3/8"	12-1/2"	360°	ADA Lever	Polished Chrome	

With Matching Accent® Sidespray

Part #	Mfg #	Holes	Reach	Spout Rotation	Height	Handle(s)	Finish	Price
162844	K-7548-4-CP	2	8-3/8"	12-1/2"	360°	ADA Lever	Polished Chrome	
156873	K-7548-4-VS	2	8-3/8"	12-1/2"	360°	ADA Lever	*Stainless	

Revival® Kitchen Faucet High-Arch Swing Spout and Matching Accent® Sidespray and Lever Handles

- 11-13-16" Spout reach, 13-3/4" spout height (16111 Model)
- 9-3/16" Spout reach, 12-3/16" spout height (16109 Model)
- Solid brass construction and brass valve bodies
- Ergonomic handle rotation
- Quarter-turn washerless ceramic disc valves
- UltraGlide™ engineered ceramic disc valves
- Coordinates with other products in the Revival® collection
- Flexible supply lines and installation ring
- Maximum flow rate: 1.8 gpm @ 60 psi



Part #	Mfg #	Holes	Reach	Spout Height	Handle(s)	Finish	Price
082554	K-16111-4-BN	4	11-13/16"	13-3/4"	Scroll Lever	*Brushed Nickel	
157679	K-16111-4-CP	4	11-13/16"	13-3/4"	Scroll Lever	Polished Chrome	
059948	K-16111-4-PB	4	11-13/16"	13-3/4"	Scroll Lever	Polished Brass	
054863	K-16109-4A-BN	4	9-3/16"	12-3/16"	Traditional Lever	*Brushed Nickel	
070705	K-16109-4A-BV	4	9-3/16"	12-3/16"	Traditional Lever	*Brushed Bronze	
060583	K-16109-4A-CP	4	9-3/16"	12-3/16"	Traditional Lever	Polished Chrome	
070467	K-16109-4A-PB	4	9-3/16"	12-3/16"	Traditional Lever	Polished Brass	

* Vibrant Limited Lifetime Finish

www.waterconcepts.net • Serving our Customers Since 1946 • www.plumbsupply.com

Kitchen Faucets & Accessories

Misc Accessories

HiRise® Independent Sidespray with Valve

- 90° progressive valve
- Spray pause function
- ProMotion® technology's light, quiet braided hose and ball joint
- Flow rate: 2.2 gpm



Part #	Mfg #	Material	Reach Spout	Price
108814	K-7344-4-BS	Brushed Stnlss	4-3/16"	
182350	K-7344-4-S	Polished Stnlss	4-3/16"	

Faucet Hole Cover for Sinks and Lavatories



Part #	Mfg #	Finish	Dia.	Price
094134	K-8830-0	White	1-3/4"	
135394	K-8830-47	Almond	1-3/4"	
074555	K-8830-7	Black	1-3/4"	
098964	K-8830-96	Biscuit	1-3/4"	
081702	K-8830-CP	Polished Chrome	1-3/4"	
065328	K-8830-PB	Polished Brass	1-3/4"	
173029	K-8830-VS	*Stainless	1-3/4"	
147019	K-8830-2BZ	Oil-Rubbed Bronze	1-3/4"	

Air Gaps

Air Gap body with Cover

- Durable plastic body
- Solid-brass cap offers years of reliable performance



Part #	Mfg #	Finish	Price
183159	K-9110-CP	Polished Chrome	
222601	K-9110-VS	*Stainless	

Cleaners

Kohler® Cast Iron Cleaner



Part #	Mfg #	Bottle Size	Price
119311	K-1012525	8 Ounces	

Misc.

Accent® Kitchen Side Spray

- Includes hose and sidespray holder
- MasterClean™ sprayface
- Coordinates with many faucet designs



Part #	Mfg #	Finish	Price
104810	K-10101-BN	*Brushed Nickel	
102596	K-10101-CP	Polished Chrome	
102597	K-10101-G	Brushed Chrome	
173986	K-10101-2BZ	Oil-Rubbed Bronze	

Bellegrove™ Sponge Caddy

- Comes included with K-6482



Part #	Mfg #	Finish	Price
188518	K-6545-ST	Stainless Steel	

Dish Scraper



Part #	Mfg #	Finish	Price
177433	K-8624-0	White	

Disinfecting Wipes Dispenser with Silicone Seal

- Fits 30- to 35 wipes
- Easy one-touch lid opening
- Rust-resistant stainless steel



Part #	Mfg #	Finish	Price
190458	K-6382-0	Stainless/White	

Prolific™ Colander and Wash bin

- Included with the K-5540 Prolific Sink



Part #	Mfg #	Finish	Price
173553	K-5544-0	White	

In Step™ Paper Towel Holder



Part #	Mfg #	Finish	Price
227175	K-8618-0	White	
177432	K-8618-CHR	Charcoal	

* Vibrant Limited Lifetime Warranty

www.plumbsupply.com • Serving our Customers Since 1946 • www.waterconcepts.net

Kitchen Faucets & Accessories

Faucets & Valves

Reset™ Flexible Kitchen Mat

- Heat-resistant to 400°F
- Protects sink surface and cushions dishware
- Doubles as a dish drying mat on the countertop



Part #	Mfg #	Finish	Price
177054	8619-0	White	
183658	8619-CHR	Charcoal	

Dishwasher Safe Silicone Drying Mat

- Heat-resistant to 500°F



Part #	Mfg #	Finish	Size	Price
190465	K-5472-0	White	11" x 15" x 3/8"	
190466	K-5472-CHR	Charcoal	11" x 15" x 3/8"	

Sponge Caddy



Part #	Mfg #	Finish	Price
171845	K-6377-0	White	

Sponge Caddy for the Octave™

K-3842, K-3843, K-3844, or K-3845



Part #	Mfg #	Finish	Price
163370	K-6139-ST	Stainless Steel	

Surface Swipe



Part #	Mfg #	Finish	Price
172617	K-6379-0	White	

Utility Rack with Soaking Cup

- Expands 3" to fit most sinks (14.6" to 17.6")



Part #	Mfg #	Finish	Price
190459	K-5473-CHR	Stainless Charcoal	

* Vibrant Limited Lifetime Warranty

www.waterconcepts.net • Serving our Customers Since 1946 • www.plumbsupply.com

Soap Dispensers

Soap/Lotion Dispensers

Contemporary Soap/Lotion Dispenser

- Refillable from top with up to 16 oz liquid soap, dishwashing liquid, or hand lotion
- 3-7/16" High pump
- 3-1/16" Long spout
- May be installed in a pre-drilled sink hole or surfaces up to 2.5"
- Clam shell packed



Part #	Mfg #	Finish	Price
126092	K-1895-BL	Matte Black	
100745	K-1895-C-BN	*Brushed Nickel	
103610	K-1895-C-BV	*Brushed Bronze	
100746	K-1895-C-CP	Polished Chrome	
106253	K-1895-C-G	Brushed Chrome	
100747	K-1895-C-VS	*Stainless	

Contemporary Soap/Lotion Dispenser with 4" Spout

- Refillable from top with up to 16 oz liquid soap, dishwashing liquid or hand lotion
- 4-7/16" High pump



Part #	Mfg #	Description	Price
169803	K-1995-BL	Matte Black	
115893	K-1995-BN	*Brushed Nickel	
120314	K-1995-CP	Polished Chrome	
115894	K-1995-VS	*Stainless	

HiRise® Soap/Lotion Dispenser with 3-1/8" Pump

- Refillable from top with up to 16 oz liquid soap, dishwashing liquid or hand lotion
- 3-13/16" Long spout



Part #	Mfg #	Description	Price
139295	K-7346-BS	Brushed Stainless	
182349	K-7346-S	Polished Stainless	

Purist® Countertop Soap/Lotion Dispenser



Part #	Mfg #	Description	Price
164190	K-14379-CP	Polished Chrome	

Traditional Soap/Lotion Dispenser—16 Fl Oz

- Refillable from top
- 3-7/16" High pump
- 3-7/16" Long spout
- May be installed in a pre-drilled sink hole or surfaces up to 2.5"
- Clam shell packed



Part #	Mfg #	Finish	Price
097717	K-1894-C-BN	*Brushed Nickel	
104617	K-1894-C-BV	*Brushed Bronze	
100743	K-1894-C-CP	Polished Chrome	
135463	K-1894-G-G	Brushed Chrome	
112851	K-1894-C-PB	*Polished Brass	
178563	K-1894-C-SN	*Polished Nickel	
100744	K-1894-C-VS	*Stainless	
147006	K-1894-C-2BZ	Oil-Rubbed Bronze	

Traditional Design Soap/Lotion Dispenser

- Solid brass construction
- Refillable from top with up to 16 oz
- 5-1/2" High Pump
- 3-15/16" Long spout



Part #	Mfg #	Description	Price
189542	K-1994-CP	Polished Chrome	
225038	K-1994-SN	*Polished Nickel	
185194	K-1994-VS	*Stainless	

* Vibrant Limited Lifetime Warranty

www.plumbsupply.com • Serving our Customers Since 1946 • www.waterconcepts.net

Soap Dispensers

Transitional Soap/Lotion Dispenser

- Refillable from top with up to 16 oz
- 3-5/16" High pump
- 3-3/8" Long spout
- May be installed in a pre-drilled sink hole or surfaces up to 2"
- Clam shell packed



Part #	Mfg #	Finish	Price
098307	K-1893-C-BN	*Brushed Nickel	
114047	K-1893-C-BV	*Brushed Bronze	
100741	K-1893-C-CP	Polished Chrome	
105578	K-1893-C-G	Brushed Chrome	
178239	K-1893-C-SN	*Polished Nickel	
100742	K-1893-C-VS	*Stainless	
147005	K-1893-C-2BZ	Oil Rubbed Bronze	

Soap/Lotion Dispenser

- Solid brass construction
- Holds up to 8.5 ounces
- 3-3/4" high pump
- 2-11/16" spout



Part #	Mfg #	Description	Price
053686	K-9619-0	White	
053687	K-9619-96	Biscuit	

* Vibrant Limited Lifetime Warranty

www.waterconcepts.net • Serving our Customers Since 1946 • www.plumbsupply.com

Kitchen Faucets & Accessories

Single-Handle Kitchen Faucets

Artesso™ 1-Hdl Pull-Down Kitchen Faucet

- 8-3/4" Long, 15-5/8" high, 360° swivel spout
- Two-function spray
- One hole installation
- MagneDock® magnetic docking
- DIAMOND™ seal technology
- Euro-motion Diamond™ valve with InnoFlex® waterways
- Touch-Clean® nozzles
- Accommodates 3" deck thickness
- 1.80 gpm @ 60 psi



Part #	Mfg #	Description	Handle(s)	Finish	Price
177630	63025LF-PC	1- or 3-Hole, Pull-Down Spray	ADA Lever	Chrome	
178322	63025LF-PN	1- or 3-Hole, Pull-Down Spray	ADA Lever	Polished Nickel*	
170377	63025LF-RB	1- or 3-Hole, Pull-Down Spray	ADA Lever	Venetian Bronze®	
171626	63025LF-SS	1- or 3-Hole, Pull-Down Spray	ADA lever	Stainless*	
177873	64025LF-SS	1- or 3-Hole, Pull-Down Spray w/ SmartTouch® Tech	ADA lever	Stainless*	
225034	64025LF-PN	1- or 3-Hole, Pull-Down Spray w/ SmartTouch® Tech	ADA lever	Polished Nickel*	

Artesso™ 1-Hdl Articulating Arm Kitchen Faucet

- 20-13/16" High spout
- 23" Above-deck exposed hose, arm rotates 360°
- Two-function spray
- Quick connect hoses
- MagneDock® magnetic docking
- DIAMOND™ seal technology
- Euro-motion Diamond™ valve with InnoFlex® waterways
- Touch-Clean® nozzles
- One hole installation
- Accommodates 3" deck thickness
- Optional escutcheon included for 3-hole mount
- 1.8 gpm @ 60 psi



Part #	Mfg #	Description	Handle(s)	Finish	Price
186425	63225LF-PC	1-or-3 Hole, Articulating Arm	ADA Lever	Chrome	
176921	63225LF-SS	1- or 3-Hole, Articulating Arm	ADA Lever	Stainless*	

* Brilliance® Anti-Tarnish Lifetime Finishes

www.plumbsupply.com • Serving our Customers Since 1946 • www.waterconcepts.net

Kitchen Faucets & Accessories

Baliza™ 1-Hdl Pull-Out Kitchen Faucet

- 9-17/32" Reach, 8-3/64" high, 120° swing spout
- MagneDock® technology
- DIAMOND™ seal technology
- Euro-motion Diamond™ valve with InnoFlex® waterways
- Touch-Clean® nozzles
- 4-function wand: spray, stream, volume control, and pause
- Accommodates up to 3" deck thickness
- Maximum flow: 1.80 gpm @ 60 psi



Part #	Mfg #	Description	Handle(s)	Finish	Price
110033	63005LF-BZ	1-Hole, Pull-Out Spray	ADA Lever	Brushed Bronze*	
186666	63005LF-PC	1-Hole, Pull-Out Spray	ADA Lever	Chrome	
147534	63005LF-RB	1-Hole, Pull-Out Spray	ADA Lever	Venetian Bronze®	
156141	63005LF-SS	1-Hole, Pull-Out Spray	ADA Lever	Stainless*	

Belo® 1-Hdl Pull-Down Kitchen Faucet

- 9-1/2" Long, 15" high, 360° swivel spout
- Touch-Clean® sprayhead
- Quick connect hoses
- MagneDock® magnetic docking
- Optional 10" escutcheon included for 3-hole mount
- 1.8 gpm @ 60 psi



Part #	Mfg #	Description	Handle(s)	Finish	Price
134898	63052LF-PC	1- or 3-Hole, Pull-Down Spray	ADA Lever	Chrome	
131294	63052LF-SS	1- or 3-Hole, Pull-Down Spray	ADA Lever	Stainless*	

Solna® 1-Hdl Pull-Out Kitchen Faucet

- 8-25/32" Long, 11-11/16" high, 360° swivel spout
- Quick connect hoses
- 1.8 gpm @ 60 psi



Part #	Mfg #	Description	Handle(s)	Finish	Price
179678	63220LF-PC	1-Hole, Pull-Out Spray	ADA Lever	Chrome	
226382	63220LF-BL	1-Hole, Pull-Out Spray	ADA Lever	Matte Black	
168367	63220LF-SS	1-Hole, Pull-Out Spray	ADA Lever	Stainless*	

* Brilliance® Anti-Tarnish Lifetime Finishes

www.waterconcepts.net • Serving our Customers Since 1946 • www.plumbsupply.com

Kitchen Faucets & Accessories

Solna® 1-Hdl Articulating Kitchen Faucet

- 10-1/2" Long, 20-9/16" High, 360° swivel spout
- MagneDock® magnetic docking
- Touch-Clean® sprayhead
- Two function spray
- 1-Hole installation
- Accommodates up to 3" deck thickness
- 1.8 gpm @ 60 psi



Part #	Mfg #	Description	Handle(s)	Finish	Price
225095	63221LF-PC	1-Hole, Articulating Arm	ADA Lever	Chrome	
185536	63221LF-BL	1-Hole, Articulating Arm	ADA Lever	Matte Black	
185410	63221LF-SS	1-Hole, Articulating Arm	ADA Lever	Stainless*	

Solna™ 1-Hdl Pull-Down Kitchen Faucet

- 9-3/32" Long, 15-11/16" high, 360° swing spout
- MagneDock™ magnetic docking
- DIAMOND™ seal technology
- Euro-motion Diamond™ valve with InnoFlex® waterways
- Two-function wand: spray and stream
- Hidden pull-down wand
- Accommodates up to 3" deck thickness
- Maximum flow rate: 1.80 gpm @ 60 psi



Part #	Mfg #	Description	Handle(s)	Finish	Price
158688	63020LF-BL	1-Hole, Pull-Down Spray	ADA Lever	Matte Black	
159155	63020LF-BZ	1-Hole, Pull-Down Spray	ADA Lever	Brushed Bronze*	
229427	63020LF-MW	1-Hole, Pull-Down Spray	ADA Lever	Matte White	
147982	63020LF-PC	1-Hole, Pull-Down Spray	ADA Lever	Chrome	
139265	63020LF-SS	1-Hole, Pull-Down Spray	ADA Lever	Stainless*	
147390	64020LF-BL	1-Hole, Pull-Down Spray w/ SmartTouch®	ADA Lever	Matte Black	
170374	64020LF-PC	1-Hole, Pull-Down Spray w/ SmartTouch®	ADA Lever	Chrome	
147389	64020LF-SS	1-Hole, Pull-Down Spray w/ SmartTouch®	ADA Lever	Stainless*	

Talo® 1-Hdl Pull-Down Kitchen Faucet

- 8-7/16" Long, 15-29/32" high, 360° swing spout
- Four function with pause and volume control
- Solid brass body
- MagneDock® magnetic docking
- 1.80 gpm @ 60 psi



Part #	Mfg #	Description	Handle(s)	Finish	Price
134882	63003LF-BZ	1-Hole, Pull-Down Spray	ADA Lever	Brushed Bronze*	
159858	63003LF-PC	1-Hole, Pull-Down Spray	ADA Lever	Chrome	
157812	63003LF-PN	1-Hole, Pull-Down Spray	ADA Lever	Polished Nickel*	

* Brilliance® Anti-Tarnish Lifetime Finishes

www.plumbsupply.com • Serving our Customers Since 1946 • www.waterconcepts.net

Kitchen Faucets & Accessories

Single-Handle Kitchen Faucets (Continued)

Talo® 1-Hdl Pull-Down Kitchen Faucet

Part #	Mfg #	Description	Handle(s)	Finish	Price
129710	63003LF-RB	1-Hole, Pull-Down Spray	ADA Lever	Venetian Bronze®	
131609	63003LF-SS	1-Hole, Pull-Down Spray	ADA Lever	Stainless*	
186830	64003LF-PN	1-Hole, Pull-Down Spray w/ SmartTouch®	ADA Lever	Polished Nickel*	
131217	64003LF-RB	1-Hole, Pull-Down Spray w/ SmartTouch®	ADA Lever	Venetian Bronze®	

Tresa® 1-Hdl Kitchen Faucet

- 9" Reach, 13-3/16" high, 360° swing spout
- Euro-motion DIAMOND™ valve with InnoFlex® waterways
- Accommodates up to 3" deck thickness
- Maximum flow: 1.8 gpm @ 60psi



Part #	Mfg #	Description	Handle(s)	Finish	Price
170565	61036LF-SS	1-Hole, Less Side Spray	ADA Lever	Stainless*	
163266	61136LF-PC	2-Hole, Matching Side Spray	ADA Lever	Chrome	
167498	61136LF-PN	2-Hole, Matching Side Spray	ADA Lever	Polished Nickel*	
174390	61136LF-RB	2-Hole, Matching Side Spray	ADA Lever	Venetian Bronze®	
156422	61136LF-SS	2-Hole, Matching Side Spray	ADA Lever	Stainless*	

Venuto® 1-Hdl Pull-Down Kitchen Faucet

- 9-1/2" Reach, 15-1/2" high, 360° swing spout
- MagneDock® technology
- DIAMOND™ seal technology
- Euro-motion Diamond™ valve with InnoFlex® waterways
- Touch-Clean® nozzles
- 2-function wand: spray and stream
- 3" Maximum deck thickness
- Maximum flow: 1.80 gpm @ 60 psi



Part #	Mfg #	Description	Handle(s)	Finish	Price
154741	63070LF-BLST	1-Hole, Pull-Down Spray	ADA Lever	Matte Black/Soft Touch®	
132301	63070LF-PC	1-Hole, Pull-Down Spray	ADA Lever	Chrome	
130516	63070LF-SS	1-Hole, Pull-Down Spray	ADA Lever	Stainless*	
131555	63070LF-SSST	1-Hole, Pull-Down Spray	ADA Lever	Stainless*/Soft Touch®	
132723	64070LF-PC	1-Hole, Pull-Down Spray w/ SmartTouch®	ADA Lever	Chrome	
131907	64070LF-SS	1-Hole, Pull-Down Spray w/ SmartTouch®	ADA Lever	Stainless*	

* Brilliance® Anti-Tarnish Lifetime Finishes

www.waterconcepts.net • Serving our Customers Since 1946 • www.plumbsupply.com

Kitchen Faucets & Accessories

Vuelo® 1-Hdl Hi-Arch Pull-Out Kitchen Faucet

- 10" Reach, 16-3/8" High, 360° swing spout
- DIAMOND™ seal technology
- Touch-Clean® sprayhead
- MagneDock® magnetic docking
- Two-function wand: spray and stream
- Maximum flow: 1.5 gpm @ 60 psi



Part #	Mfg #	Description	Handle(s)	Finish	Price
225571	63255LF-PC	1-Hole, Pull-Out Spray	ADA Lever	Chrome	
176944	63255LF-SSCO	1-Hole, Pull-Out Spray	ADA Lever	Stainless Steel/Cocoa Brz™	

Vuelo® 1-Hdl High-Arch Pull-Out Kitchen Faucet with SmartTouch®

- 9-15/16" Reach, 16-3/4" high, 360° swing spout
- MagneDock™ magnetic docking
- SmartTouch® technology with TempID™
- DIAMOND™ seal technology
- Two-function wand: spray and stream
- Accommodates up to 3" deck thickness
- Flow rate: 1.80 gpm @ 60 psi



Part #	Mfg #	Description	Handle(s)	Finish	Price
168524	64255LF-PC	1-Hole, Pull-Down Spray w/ SmartTouch®	ADA Lever	Chrome	
163316	64255LF-SSCO	1-Hole, Pull-Down Spray w/ SmartTouch®	ADA Lever	Stainless Steel/Cocoa Brz™	

Vuelo® 1-Hdl Pull-Down Kitchen Faucet

- 10-3/4" Long, 15-3/4" high, 360° swing spout
- DIAMOND™ seal technology
- Touch-Clean® nozzles
- MagneDock® magnetic docking
- Accommodates up to 3" deck thickness
- Maximum flow: 1.80 gpm @60 psi



Part #	Mfg #	Description	Handle(s)	Finish	Price
154158	63055LF-PC	1-Hole, Pull-Down Spray	ADA Lever	Chrome	
156055	63055LF-SS	1-Hole, Pull-Down Spray	ADA Lever	Stainless*	
155144	63055LF-SSCO	1-Hole, Pull-Down Spray	ADA Lever	Stainless Steel/Cocoa Brz™	

* Brilliance® Anti-Tarnish Lifetime Finishes

www.plumbsupply.com • Serving our Customers Since 1946 • www.waterconcepts.net

Kitchen Faucets & Accessories

Faucets & Valves

Vuelo® 1-Hdl Pull-Down Kitchen Faucet with SmartTouch®

- 10-1/4" Reach, 16-3/4" high, 360° swing spout
- SmartTouch® technology with TempID™
- MagneDock™ magnetic docking
- DIAMOND® seal technology
- Two-function wand: spray and stream
- Accommodates up to 3" deck thickness
- Flow rate: 1.80 gpm @ 60 psi



Part #	Mfg #	Description	Handle(s)	Finish	Price
158002	64355LF-SS	1-Hole, Pull-Down Spray w/ SmartTouch®	ADA Lever	Stainless*	
166423	64355LF-SSCO	1-Hole, Pull-Down Spray w/ SmartTouch®	ADA Lever	Stainless Steel/Cocoa Brz™	

Two-Handle Kitchen Faucets

Artesso™ 2-Hdl Bridge Kitchen Faucet

- 8-19/32" Reach, 13-21/34" high 360° swing spout
- 10-5/32" From deck to aerator
- Solid brass with one-piece waterway
- Ceramic cartridges
- Accommodates up to 3" deck thickness
- Includes matching side sprayer
- Maximum flow: 1.8 gpm @ 60 psi



Part #	Mfg #	Description	Handle(s)	Finish	Price
178172	62525LF-PC	3-Hole, Matching Side Spray	ADA Lever	Chrome	
177270	62525LF-SS	3-Hole, Matching Side Spray	ADA Lever	Stainless*	

Tresa® 2-Hdl Bridge Kitchen Faucet

- 9-27/32" Reach, 10-21/32" high 360° swing spout
- 7-3/8" From deck to aerator
- Solid brass one-piece waterway
- Ceramic cartridges
- Accommodates up to 3" deck thickness
- Maximum flow: 1.8 gpm @ 60 psi



Part #	Mfg #	Description	Handle(s)	Finish	Price
150686	62436LF-PC	2-Hole, Less Side Spray	ADA lever	Polished Chrome	
146887	62436LF-RB	2-Hole, Less Side Spray	ADA Lever	Venetian Bronze®	
155363	62436LF-SS	2-Hole, Less Side Spray	ADA Lever	Stainless*	
156176	62536LF-BZ	3-Hole, Matching Side Spray	ADA Lever	Brushed Bronze*	
155225	62536LF-PC	3-Hole, Matching Side Spray	ADA Lever	Polished Chrome	
170004	62536LF-PN	3-Hole, Matching Side Spray	ADA Lever	Polished Nickel*	
138290	62536LF-RB	3-Hole, Matching Side Spray	ADA Lever	Venetian Bronze®	
151760	62536LF-SS	3-Hole, Matching Side Spray	ADA Lever	Stainless*	

* Brilliance® Anti-Tarnish Lifetime Finishes

www.waterconcepts.net • Serving our Customers Since 1946 • www.plumbsupply.com

Kitchen Faucets & Accessories

Tresa® 2-Hdl Kitchen Faucet

- 9" Reach, 13-3/16" high spout
- 9-5/8" From deck to aerator
- Includes matching side sprayer
- Solid brass faucet body
- Ceramic cartridges
- Accommodates up to 3" deck thickness
- Maximum flow: 1.8 gpm @ 60 psi



Part #	Mfg #	Description	Handle(s)	Finish	Price
189228	62136LF-PC	2-Hole, Matching Side Spray	ADA Lever	Polished Chrome	
140344	62136LF-SS	2-Hole, Matching Side Spray	ADA Lever	Stainless*	

Pot Fillers Euro Pot Filler

- 23-1/4" Reach
- Wall-mount
- Dual shut-offs
- Cold water only
- Maximum flow rate: 4.0 gpm @ 60 psi



Part #	Mfg #	Description	Handle(s)	Finish	Price
131637	62820LF-RB			Venetian Bronze®	
130279	62820LF-SS			Stainless*	

Traditional Pot Filler

- 23-1/4" Spout reach
- Wall-mount
- Dual shut-offs
- Cold water only
- Maximum flow rate: 4.0 gpm @ 60 psi



Part #	Mfg #	Description	Handle(s)	Finish	Price
130184	62810LF-PC			Polished Chrome	
131639	62810LF-SS			Stainless*	

Deck-Mount Traditional Pot Filler

- 20-1/2" Reach, 17" high
- 14-3/4" Spout outlet to deck
- Deck-Mount
- Dual shut-offs
- Cold water only
- Maximum flow rate: 4.0 gpm @ 60 psi



Part #	Mfg #	Description	Handle(s)	Finish	Price
135061	62710LF-RB			Venetian Bronze®	

* Brilliance® Anti-Tarnish Lifetime Finishes

www.plumbsupply.com • Serving our Customers Since 1946 • www.waterconcepts.net

Kitchen Faucets & Accessories

Deck-Mount Euro Pot Filler

- 20-1/2" Reach, 17" high
- 14-3/4" Spout outlet to deck
- Deck-mount
- Dual shut-offs
- Cold water only
- Maximum flow rate: 4.0 gpm @ 60 psi



Part #	Mfg #	Description	Handle(s)	Finish	Price
189234	62720LF-SS		Stainless*		

Kitchen Accessories

Arteso™ Air Gap

- Polyethylene body
- 1-7/8" Diameter, 2-1/8" long brass cap
- 5/8" dishwasher inlet, 7/8" outlet



Part #	Mfg #	Description	Handle(s)	Finish	Price
222289	69060-PC	Polished Chrome			
222290	69060-RB	Venetian Bronze			
222291	69060-SS	Stainless*			

Classic Air Gap

- Polyethylene body
- 1-5/8" Diameter, 2-1/8" long brass cap
- 5/8" Dishwasher inlet, 7/8" outlet



Part #	Mfg #	Description	Handle(s)	Finish	Price
152292	72020	Chrome			
134116	72020-RB	Venetian Bronze®			
169379	72020-SS	Stainless*			

Venuto® Bud Vase

- Installation hardware included
- Mounts to 3" deck thickness
- 6-7/8" Overall height



Part #	Mfg #	Description	Handle(s)	Finish	Price
170378	RP42879	Chrome			
091631	RP42879SS	Stainless*			

* Brilliance® Anti-Tarnish Lifetime Finishes

www.waterconcepts.net • Serving our Customers Since 1946 • www.plumbsupply.com

Kitchen Faucets & Accessories

Baliza™ Escutcheon

- Includes installation hardware
- Accommodates up to 3" deck thickness
- 8" On center



Part #	Mfg #	Description	Handle(s)	Finish	Price
156838	RP50271BZ	10", Brushed Bronze*			
187514	RP50271SS	10", Stainless*			

Vuelo® Escutcheon

- Includes installation hardware
- Accommodates up to 3" deck thickness
- 8" On center
- (Not for use w/ SmartTouch® models)



Part #	Mfg #	Description	Handle(s)	Finish	Price
154160	RP64475PC	8", Polished Chrome			
176964	RP64475SS	8", Stainless*			

Talo® Escutcheon

- Includes installation hardware
- Accommodates up to 3" deck thickness
- 8" On center
- (Not for use w/ SmartTouch® models)



Part #	Mfg #	Description	Handle(s)	Finish	Price
154706	RP60281RB	10", Venetian Bronze®			
179625	RP60281SS	10", Stainless*			

* Brilliance® Anti-Tarnish Lifetime Finishes

www.plumbsupply.com • Serving our Customers Since 1946 • www.waterconcepts.net

Soap Dispensers

Faucets & Valves

Soap Dispensers

Artesso™ Soap/Lotion Dispenser

- Accommodates up to 3" deck thickness
- Refillable from above the deck
- 15-Ounce bottle
- 2-3/4" Overall height
- Includes installation hardware



Part #	Mfg #	Finish	Price
225035	RP75675PN	Polished Nickel	
177874	RP75675SS	Stainless*	

Solna® Soap/Lotion Dispenser

- Includes installation hardware
- Accommodates up to 3" deck thickness
- Refillable from above the deck
- 15-Ounce bottle
- 2-3/4" Overall height



Part #	Mfg #	Finish	Price
225096	RP79275PC	Polished Chrome	
181489	RP79275SS	Stainless*	

Baliza® Soap/Lotion Dispenser

- Installation hardware included
- Mounts to 3" deck thickness
- 5-11/16" Overall height
- 13-Ounce bottle
- Refillable from above the deck



Part #	Mfg #	Finish	Price
186339	RP50274	Polished Chrome	
134883	RP50274BZ	Brushed Bronze*	
157813	RP50274PN	Polished Nickel*	
132303	RP50274RB	Venetian Bronze®	
131610	RP50274SS	Stainless*	

Vuelo® Soap/Lotion Dispenser

- Installation hardware included
- Mounts to 3" deck thickness
- 5-11/16" Overall height
- 13-Ounce height
- Refillable from above the deck



Part #	Mfg #	Finish	Price
158003	RP64473SS	Stainless*	
162940	RP64473SSCO	Stainless/Cocoa Bronze™	

Tresa™ Soap/Lotion Dispenser

- Includes installation hardware
- Accommodates up to 3" deck thickness
- 5-1/2" Overall height
- Refillable from above the deck



Part #	Mfg #	Finish	Price
159191	RP61024PC	Polished Chrome	
167608	RP61024PN	Polished Nickel*	
156137	RP61024RB	Venetian Bronze®	
166189	RP61024SS	Stainless*	

Kitchen Faucets & Accessories

Commercial Single-Handle Kitchen Faucets

Commercial 1-Hdl Kitchen Faucet

- 8-11/16" Reach, 6-3/4" high spout
- 4-3/4" From deck to aerator
- Vandal-resistant handles
- Adjustable handle limit stop
- 3/8" Compression fittings
- Water-efficient product: 1.5 gpm @ 60 psi



Part #	Mfg #	Description	Handle(s)	Finish	Price
060979	100LF-HDF	8"cc, Lead-Free	ADA Lever	Chrome	
143877	101LF-HDF	1-Hole, Lead-Free	ADA Lever	Chrome	
141017	400LF-HDF	8"cc, Side Spray, Lead-Free	ADA Lever	Chrome	

Pot Filler Faucets

Traditional Wall-Mount Pot Filler Faucet

- Single-hole wall mount
- Dual-handle design for easy operation
- 24" Dual jointed swing spout
- On/off control by rotating handle 90°
- Rough into 1/2" stub out
- 1/2" IPS Inlets
- Cold water connection only
- Washerless ceramic valving
- Flow rate: 4.3 gpm @ 60 psi



Part #	Mfg #	Description	Handle(s)	Finish	Price
140946	1177LF	1-Hole, Lead-Free	ADA Lever	Chrome	
159217	1177LF-AR	1-Hole, Lead-Free	ADA Lever	Arctic Stainless™	
183316	1177LF-CZ	1-Hole, Lead-Free	ADA Lever	Champagne Bronze™	
224275	1177LF-PN	1-Hole, Lead-Free	ADA Lever	Polished Nickel	
140944	1177LF-RB	1-Hole, Lead-Free	ADA Lever	Venetian Bronze®	
140945	1177LF-SS	1-Hole, Lead-Free	ADA Lever	Stainless*	

Contemporary Wall-Mount Pot Filler Faucet

- Single-hole wall mount
- Dual-handle design for easy operation
- 24" Dual jointed swing spout
- On/off control by rotating handle 90°
- Rough into 1/2" stub out
- 1/2" IPS Inlets
- Cold water connection only



Part #	Mfg #	Description	Handle(s)	Finish	Price
177308	1165LF	1-Hole, Lead-Free	ADA Lever	Chrome	
171595	1165LF-AR	1-Hole, Lead-Free	ADA Lever	Arctic Stainless™	
180916	1165LF-SS	1-Hole, Lead-Free	ADA Lever	Stainless*	

* Brilliance® Anti-Tarnish Lifetime Finishes

www.plumbsupply.com • Serving our Customers Since 1946 • www.waterconcepts.net

Kitchen Faucets & Accessories

Pull-Down Kitchen Faucets

Addison® 1-Hdl Pull-Down Spray Kitchen Faucet

- 10-11/32" Reach, 15-9/16" high pull-down spout swivels 360°
- 9-1/16" From deck to aerator
- Touch-Clean® two-function Multi-Flow™ spray head with MagnaTite® docking
- 62" Long hose
- 3/8" Compression fittings
- 2-1/2" Maximum deck thickness
- Optional 10-1/2" escutcheon included
- 32" Minimum supply lines below deck included
- Water-efficient product: 1.5 gpm @ 60 psi



Part #	Mfg #	Description	Handle(s)	Finish	Price
134963	9192-DST	1-Hole, Pull-Down Spray, Lead-Free	ADA Lever	Chrome	
152920	9192-AR-DST	1-Hole, Pull-Down Spray, Lead-Free	ADA Lever	Arctic Stainless™	
155788	9192-CZ-DST	1-Hole, Pull-Down Spray, Lead-Free	ADA Lever	Champagne Bronze™	
134964	9192-RB-DST	1-Hole, Pull-Down Spray, Lead-Free	ADA Lever	Venetian Bronze®	

Addison® Touch2O 1-Hdl Pull-Down Spray Kitchen Faucet

- Touch2O® Technology controls water flow
- 10-11/32" Reach, 15-3/8" high pull-down spout swivels 360°
- 8-25/32" From deck to aerator
- Touch-Clean® two-function Multi-Flow™ spray head with MagnaTite® docking
- 62" Long hose
- 3/8" Compression fittings
- 2-1/2" Maximum deck thickness
- Optional 10-1/2" escutcheon included
- 32" Minimum supply lines below deck included
- Water-efficient product: 1.5 gpm @ 60 psi



Part #	Mfg #	Description	Handle(s)	Finish	Price
134738	9192T-DST	1-Hole, Pull-Down Spray, Lead-Free	ADA Lever	Chrome	
156060	9192T-AR-DST	1-Hole, Pull-Down Spray, Lead-Free	ADA Lever	Arctic Stainless™	
161615	9192T-CZ-DST	1-Hole, Pull-Down Spray, Lead-Free	ADA Lever	Champagne Bronze™	
134741	9192T-RB-DST	1-Hole, Pull-Down Spray, Lead-Free	ADA Lever	Venetian Bronze®	

* Brilliance® Anti-Tarnish Lifetime Finishes

www.waterconcepts.net • Serving our Customers Since 1946 • www.plumbsupply.com

Kitchen Faucets & Accessories

Allora® 1-Hdl Pull-Down Spray Kitchen Faucet

- 9-7/8" Reach, 15-9/16" high spout swivels 360°
- 7-3/4" From deck to aerator
- Touch-Clean® pull-down two-function spray head with MagnaTite® docking
- 62" Long hose
- 3/8" Compression fittings
- 2-1/2" Maximum deck thickness
- 32" Minimum supply lines below deck included
- Water-efficient product: 1.8 gpm @ 60 psi



989-DST



989-SD-DST

Part #	Mfg #	Description	Handle(s)	Finish	Price
116875	989-DST	1-Hole, Pull-Down Spray, Lead-Free	ADA Lever	Chrome	
147898	989-AR-DST	1-Hole, Pull-Down Spray, Lead-Free	ADA Lever	Arctic Stainless™	
116877	989-SD-DST	2-Hole, Pull-Down Spray, Soap Dispenser, Lead-Free	ADA Lever	Chrome	

Cassidy™ 1-Hdl Pull-Down Spray Kitchen Faucet

- 9-3/8" Reach, 15-1/2" high
- High-arc pull-down swivels 360°
- 9-5/32" From deck to aerator
- 62" Long hose
- 3/8" Compression fittings
- 32" minimum InnoFlex® supply lines below the deck included
- 2-1/2" Maximum deck thickness
- Euro-motion DIAMOND™ valve
- MagnaTite® docking
- WaterSense® certified product: 1.8 gpm @ 60 psi



Part #	Mfg #	Description	Handle(s)	Finish	Price
152825	9197-DST	1- or 3-Hole, Pull-Down Spray, Lead Free	ADA Lever	Chrome	
152267	9197-AR-DST	1- or 3-Hole, Pull-Down Spray, Lead Free	ADA Lever	Arctic Stainless™	
152274	9197-CZ-DST	1- or 3-Hole, Pull-Down Spray, Lead Free	ADA Lever	Champagne Bronze™	
227742	9197-PN-DST	1- or 3-Hole, Pull-Down Spray, Lead Free	ADA Lever	Polished Nickel	
152027	9197-RB-DST	1- or 3-Hole, Pull-Down Spray, Lead Free	ADA Lever	Venetian Bronze®	

* Brilliance® Anti-Tarnish Lifetime Finishes

www.plumbsupply.com • Serving our Customers Since 1946 • www.waterconcepts.net

Kitchen Faucets & Accessories

Faucets & Valves

Cassidy™ 1-Hdl Pull-Down Spray Touch2O® Kitchen Faucet

- 9-3/8" Reach, 15-1/2" high
- High-arc pull-down swivels 360°
- 9-5/32" From deck to aerator
- 62" Long hose
- 3/8" Compression fittings
- 32" minimum InnoFlex® supply lines below the deck included
- 2-1/2" Maximum deck thickness
- Euro-motion DIAMOND™ valve
- MagnaTite® docking
- WaterSense® certified product: 1.8 gpm @ 60 psi
- Touch feature to activate on/off



Part #	Mfg #	Description	Handle(s)	Finish	Price
152816	9197T-DST	1- or 3-Hole, Pull-Down Spray, Lead Free Touch2O	ADA Lever	Chrome	
152710	9197T-AR-DST	1- or 3-Hole, Pull-Down Spray, Lead Free Touch2O	ADA Lever	Arctic Stainless™	
152817	9197T-CZ-DST	1- or 3-Hole, Pull-Down Spray, Lead Free Touch2O	ADA Lever	Champagne Bronze™	
152151	9197T-RB-DST	1- or 3-Hole, Pull-Down Spray, Lead Free Touch2O	ADA Lever	Venetian Bronze®	

Essa™ 1-Hdl Pull-Down Spray Kitchen Faucet

- 9-3/8" Reach, 15-3/4" high 360° swivel spout
- 8-3/4" From deck to aerator
- 3/8" O.D. straight, staggered pex supply lines
- 1- or 3-Hole (escutcheon included)
- DIAMOND™ Valve
- MagnaTite® magnetic docking
- Touch-Clean® sprayhead
- 1.8 gpm @ 60 psi



Part #	Mfg #	Description	Handle(s)	Finish	Price
180317	9113-DST	1- or 3-Hole 8"cc, Pull-Out Spray, Lead Free	ADA Lever	Chrome	
180390	9113-AR-DST	1- or 3-Hole 8"cc, Pull-Out Spray, Lead Free	ADA Lever	Arctic Stainless™	
179486	9113-BL-DST	1- or 3-Hole 8"cc, Pull-Out Spray, Lead Free	ADA Lever	Matte Black	
177300	9113-RB-DST	1- or 3-Hole 8"cc, Pull-Out Spray, Lead Free	ADA Lever	Venetian Bronze®	

Essa™ 1-Hdl Pull-Down Spray Touch2O® Kitchen Faucet

- 9-3/8" Reach, 16" high 360° swivel spout
- 9-21/32" From deck to aerator
- 3/8" O.D. straight, staggered pex supply lines
- 1- or 3-Hole (escutcheon included)
- DIAMOND™ Valve
- MagnaTite® magnetic docking
- Touch-Clean® sprayhead
- 1.8 gpm @ 60 psi
- Touch2O® touch feature to activate on/off



Part #	Mfg #	Description	Handle(s)	Finish	Price
185200	9113T-DST	1- or 3-Hole 8"cc, Pull-Out Spray, Lead Free Touch2O	ADA Lever	Chrome	

* Brilliance® Anti-Tarnish Lifetime Finishes

www.waterconcepts.net • Serving our Customers Since 1946 • www.plumbsupply.com

Kitchen Faucets & Accessories

Pull-Down Kitchen Faucets (Continued)

Essa™ 1-Hdl Pull-Down Spray Touch2O® Kitchen Faucet

Part #	Mfg #	Description	Handle(s)	Finish	Price
179996	9113T-AR-DST	1- or 3-Hole 8"cc, Pull-Out Spray, Lead Free Touch2O	ADA Lever	Arctic Stainless™	
185307	9113T-BL-DST	1- or 3-Hole 8"cc, Pull-Out Spray, Lead Free Touch2O	ADA Lever	Matte Black	
181845	9113T-RB-DST	1- or 3-Hole 8"cc, Pull-Out Spray, Lead Free Touch2O	ADA Lever	Venetian Bronze®	

Fuse™ 1-Hdl Pull-Down Kitchen Faucet

- 9" Reach, 16" high-arc spout swivels 360°
- 3/8" Compression fittings
- Optional 10" escutcheon
- Touch-Clean® 2-function sprayhead
- Magnetic docking systems secures sprayer to spout
- Water-efficient product: 1.8 gpm @ 60 psi



Part #	Mfg #	Description	Handle(s)	Finish	Price
145372	9158-SB-DST	1- or 3-Hole 8"cc, Pull-Down Spray, Lead-Free	ADA Lever	Stainless & Cracked Pepper	
152863	9158-SR-DST	1- or 3-Hole 8"cc, Pull-Down Spray, Lead-Free	ADA Lever	Stainless & Chili Pepper	
152517	9158-SW-DST	1- or 3-Hole 8"cc, Pull-Down Spray, Lead-Free	ADA Lever	Stainless & Snowflake White	

Leland® 1-Hdl Pull-Down Spray Kitchen Faucet

- 9-1/8" Reach, 14-7/8" high, pull-down spout swivels 360°
- 7-7/8" From deck to aerator
- Touch-Clean® two-function spray head with MagnaTite® docking
- 59" Long hose
- 3/8" Compression fittings
- 2-1/2" Maximum deck thickness
- 32" Minimum supply lines below deck included
- Water-efficient product: 1.8 gpm @ 60 psi ("WE" models: 1.5 gpm @ 60 psi)



Part #	Mfg #	Description	Handle(s)	Finish	Price
117359	978-DST	2-Hole, Pull-Down Spray, Lead-Free	ADA Lever	Chrome	
130201	978-WE-DST	2-Hole, Pull-Down Spray, Water Efficient, Lead-Free	ADA Lever	Chrome	
222231	978-RBWE-DST	2-Hole, Pull-Down Spray, Water Efficient, Lead-Free	ADA Lever	Venetian Bronze®	
154935	978-AR-DST	2-Hole, Pull-Down Spray, Lead-Free	ADA Lever	Arctic Stainless™	
165324	978-ARWE-DST	2-Hole, Pull-Down Spray, Water Efficient, Lead-Free	ADA Lever	Arctic Stainless™	
158903	978-CZ-DST	2-Hole, Pull-Down Spray, Lead-Free	ADA Lever	Champagne Bronze™	
116996	978-RB-DST	2-Hole, Pull-Down Spray, Lead-Free	ADA Lever	Venetian Bronze®	
116251	978-SS-DST	2-Hole, Pull-Down Spray, Lead-Free	ADA Lever	Stainless*	
134160	9178-DST	1-Hole or 8"cc, Pull-Down Spray, Escutcheon, Lead-Free	ADA Lever	Chrome	
162595	9178-CZ-DST	1-Hole or 8"cc, Pull-Down Spray, Escutcheon, Lead-Free	ADA Lever	Champagne Bronze™	
133915	9178-RB-DST	1-Hole or 8"cc, Pull-Down Spray, Escutcheon, Lead-Free	ADA Lever	Venetian Bronze®	
153721	9178-AR-DST	1-Hole or 8"cc, Pull-Down Spray, Escutcheon, Lead-Free	ADA Lever	Arctic Stainless™	
188501	9178T-DST	1-Hole, Pull-Down Spray Touch2O Technology	ADA Lever	Chrome	
170732	9178T-AR-DST	1-Hole, Pull-Down Spray Touch2O Technology	ADA Lever	Arctic Stainless™	

* Brilliance® Anti-Tarnish Lifetime Finishes

www.plumbsupply.com • Serving our Customers Since 1946 • www.waterconcepts.net

Kitchen Faucets & Accessories

Pull-Down Kitchen Faucets (Continued)

Leland® 1-Hdl Pull-Down Spray Kitchen Faucet

Part #	Mfg #	Description	Handle(s)	Finish	Price
171780	9178T-RB-DST	1-Hole, Pull-Down Spray Touch2O Technology	ADA Lever	Venetian Bronze®	

Mateo™ 1-Hdl Pull-Down Spray Kitchen Faucet

- 9-1/4" Reach, 15-1/2" high swivel spout
- 8-5/8" From deck to aerator
- 3/8" O.D. straight, staggered PEX supply lines
- Two-function wand: aerated stream or spray
- Dual integral check valves in sprayer
- Flow rate: 1.8 gpm @ 60 psi
- RP81914 Escutcheon required for 3-hole



Part #	Mfg #	Description	Handle(s)	Finish	Price
187864	9183-DST	1-Hole, Pull-Down Spray, Lead Free	ADA Lever	Chrome	
187326	9183-AR-DST	1-Hole, Pull-Down Spray, Lead Free	ADA Lever	Arctic Stainless™	
187404	9183-RB-DST	1-Hole, Pull-Down Spray, Lead Free	ADA Lever	Venetian Bronze®	

Mateo™ Touch2O® 1-Hdl Pull-Down Spray Kitchen Faucet

- 9-1/4" Reach, 16" high swivel spout
- 8-1/8" From deck to aerator
- 3/8" O.D. straight, staggered PEX supply lines
- 6 (AA) or 6 (C) batteries
- Optional (EP73954) 120V AC adapter available
- LED indicator light signals on-off
- Dual integral check valves in sprayer
- Flow rate: 1.8 gpm @ 60 psi
- RP81914 Escutcheon required for 3-hole



Part #	Mfg #	Description	Handle(s)	Finish	Price
225576	9183T-DST	1-Hole, Pull-Down Spray Touch2O Technology, Lead Free	ADA Lever	Chrome	
188527	9183T-AR-DST	1-Hole, Pull-Down Spray Touch2O Technology, Lead Free	ADA Lever	Arctic Stainless™	
189610	9183T-RB-DST	1-Hole, Pull-Down Spray Touch2O Technology, Lead Free	ADA Lever	Venetian Bronze®	

* Brilliance® Anti-Tarnish Lifetime Finishes

www.waterconcepts.net • Serving our Customers Since 1946 • www.plumbsupply.com

Kitchen Faucets & Accessories

Pilar® Touch2O 1-Hdl Pull-Down Spray Kitchen Faucet

- 10-5/8" Reach, 13-7/8" high, high-arc spout swivels 360°
- 8-1/4" From deck to aerator
- Touch2O™ Technology controls water flow
- Touch-Clean® two-function spray head with MagnaTite® docking
- 54" Long hose
- 3/8" Compression fittings
- 2-1/2" Maximum deck thickness
- 32" Minimum supply lines below deck included
- Water-efficient product: 1.8 gpm @ 60 psi



980T-DST



980T-SD-DS

Faucets & Valves

Part #	Mfg #	Description	Handle(s)	Finish	Price
117178	980T-DST	2-Hole, Pull-Down Spray, Lead-Free	ADA Lever	Chrome	
134732	980T-AR-DST	2-Hole, Pull-Down Spray, Lead-Free	ADA Lever	Arctic Stainless™	
133579	980T-RB-DST	2-Hole, Pull-Down Spray, Lead-Free	ADA Lever	Venetian Bronze®	
117177	980T-SD-DST	3-Hole, Pull-Down Spray, Soap Dispenser, Lead-Free	ADA Lever	Chrome	
143099	980T-RBSD-DST	3-Hole, Pull-Down Spray, Soap Dispenser, Lead-Free	ADA Lever	Venetian Bronze®	
116726	980T-SSSD-DST	3-Hole, Pull-Down Spray, Soap Dispenser, Lead-Free	ADA Lever	Stainless*	

Trinsic™ Touch2O 1-Hdl Pull-Down Spray Kitchen Faucet

- 9-1/2" Reach, 15-11/16" high-arc pull-down spout swivels 360°
- 8-7/16" From deck to aerator
- Touch2O® technology controls water flow
- Touch-Clean® two-function spray head with MagnaTite® docking
- 62" Long hose
- 3/8" Compression fittings
- 2-1/2" Maximum deck thickness
- 32" Minimum supply lines below deck included
- Water-efficient product, 1.8 gpm @ 60 psi



Part #	Mfg #	Description	Handle(s)	Finish	Price
148248	9159T-DST	1-Hole, Pull-Down Spray, Lead-Free	ADA Lever	Chrome	
223923	9159T-BL-DST	1-Hole, Pull-Down Spray, Lead-Free	ADA Lever	Matte Black	
144027	9159T-AR-DST	1-Hole, Pull-Down Spray, Lead-Free	ADA Lever	Arctic Stainless™	
147734	9159T-CZ-DST	1-Hole, Pull-Down Spray, Lead-Free	ADA Lever	Champagne Bronze™	

* Brilliance® Anti-Tarnish Lifetime Finishes

www.plumbsupply.com • Serving our Customers Since 1946 • www.waterconcepts.net

Kitchen Faucets & Accessories

Faucets & Valves

Trinsic™ 1-Hdl Pull-Down Spray Kitchen Faucet

- 9-1/2" Reach, 15-11/16" high pull-down spout swivels 360°
- 8-7/16" From deck to aerator
- Touch-Clean® two-function spray head with MagnaTite® docking
- 62" Long hose
- 3/8" Compression fittings
- 2-1/2" Maximum deck thickness
- 32" Minimum supply lines below deck included
- Water-efficient product: 1.8 gpm @ 60 psi



Part #	Mfg #	Description	Handle(s)	Finish	Price
142115	9159-DST	1-Hole, Pull-Down Spray, Lead-Free	ADA Lever	Chrome	
185377	9159-BL-DST	1-Hole, Pull-Down Spray, Lead-Free	ADA Lever	Matte Black	
141126	9159-AR-DST	1-Hole, Pull-Down Spray, Lead-Free	ADA Lever	Arctic Stainless™	
147269	9159-CZ-DST	1-Hole, Pull-Down Spray, Lead-Free	ADA Lever	Champagne Bronze™	

Trinsic® Pro 1-Hdl Pull-Down Kitchen Faucet

- 9-1/2" Reach, 18-7/18" high spring spout
- 8-1/8" From deck to aerator
- Touch-Clean® sprayhead
- MagnaTite® magnetic docking
- DIAMOND Seal® technology
- 3/8" Compression fittings
- Maximum flow rate: 1.8 gpm



Part #	Mfg #	Description	Handle(s)	Finish	Price
226605	9659-DST	1-Hole, Pull-Down Spray Spring Spout	ADA Lever	Chrome	
225266	9569-AR-DST	1-Hole, Pull-Down Spray Spring Spout	ADA Lever	Arctic Stainless™	

* Brilliance® Anti-Tarnish Lifetime Finishes

www.waterconcepts.net • Serving our Customers Since 1946 • www.plumbsupply.com

Kitchen Faucets & Accessories

Trinsic® Pro 1-Hdl Pull-Down Kitchen Faucet with Touch2O®

- 9-1/2" Reach, 19-1/2" high spring spout
- 8-7/16" From deck to aerator
- 3/8" Compression fittings
- Touch activated faucet
- On-off indicator light signals when batteries run low
- Automatic water flow shut-off after four minutes if the water is left running
- TempSense LED light indicates water temperature
- Battery operated (6 AA included) for up to 2 year battery life or 6 C (not included) for up to 5 year battery life
- Battery box can be mounted to cabinet with included mounting hardware
- Optional A/C adapter EP73954 may be ordered separately
- MagnaTite docking
- DIAMOND Seal® technology
- Touch-Clean spray holes
- Maximum flow rate: 1.8 gpm



Faucets & Valves

Part #	Mfg #	Description	Handle(s)	Finish	Price
229558	9659T-DST	1 or 3-Hole, Pull-Down Spray Spring Spout	ADA Lever	Chrome	
228075	9659T-AR-DST	1 or 3-Hole, Pull-Down Spray Spring Spout	ADA Lever	Arctic Stainless™	

Victorian® 1-Hdl Pull-Down Spray Kitchen Faucet

- 9-1/8" Reach, 14-1/4" high spout swivels 360°
- 7-3/8" From deck to aerator
- Touch-Clean® two-function spray head with MagnaTite® docking
- 62" Long hose
- 3/8" Compression fittings
- 2-1/2" Maximum deck thickness
- 32" Minimum supply lines below deck included
- Water-efficient product: 1.8 gpm @ 60 psi



Part #	Mfg #	Description	Handle(s)	Finish	Price
116511	955-RB-DST	2-Hole, Pull-Down Spray, Lead-Free	ADA Lever	Venetian Bronze®	
116868	955-SS-DST	2-Hole, Pull-Down Spray, Lead-Free	ADA Lever	Stainless*	

* Brilliance® Anti-Tarnish Lifetime Finishes

www.plumbsupply.com • Serving our Customers Since 1946 • www.waterconcepts.net

Kitchen Faucets & Accessories

Pull-Out Kitchen Faucets

Cassidy™ 1-Hdl Pull-Out Spray Kitchen Faucet

- 10-11/16" Reach, 10-11/16" high 120° swivel spout
- 7-15/16" From deck to aerator
- 54" Long hose
- 3/8" Compression fittings
- Order RP61607 for 1.5 gpm hose adapter
- 2-1/2" Max deck thickness
- 32" Minimum InnoFlex® supply lines
- DIAMOND™ Valve
- 1.8 gpm @ 60 psi



Part #	Mfg #	Description	Handle(s)	Finish	Price
158926	4197-DST	1- or 3-Hole 8"cc, Pull-Out Spray, Lead Free	ADA Lever	Chrome	
161452	4197-AR-DST	1- or 3-Hole 8"cc, Pull-Out Spray, Lead Free	ADA Lever	Arctic Stainless™	
164888	4197-CZ-DST	1- or 3-Hole 8"cc, Pull-Out Spray, Lead Free	ADA Lever	Champagne Bronze™	
226002	4197-PN-DST	1- or 3-Hole 8"cc, Pull-Out Spray, Lead Free	ADA Lever	Polished Nickel	
160254	4197-RB-DST	1- or 3-Hole 8"cc, Pull-Out Spray, Lead Free	ADA Lever	Venetian Bronze®	

Foundations® Core-B 1-Hdl Pull-Out Spray Kitchen Faucet

- 9-5/8" Reach, 10" high pull-out spout swivels 120°
- 6-11/16" From deck to aerator
- 59" Long hose
- 1/2" IPS Connection
- 2-1/2" Maximum deck thickness
- Optional 8" escutcheon included
- Water-efficient product: 1.8 gpm @ 60 psi



Part #	Mfg #	Description	Handle(s)	Finish	Price
133790	B4310LF	1- or 3-Hole 8"cc, Pull-Out Spray, Lead-Free	ADA Lever	Chrome	
138458	B4310LF-SS	1- or 3-Hole 8"cc, Pull-Out Spray, Lead-Free	ADA Lever	Stainless*	

Linden™ 1-Hdl Pull-Out Spray Kitchen Faucet

- 9-7/8" Reach, 12-5/16" high pull-down spout swings 360°
- 9-9/16" From deck to aerator
- Touch-Clean® pull-down Multi-Flow™ three-function spray head
- 54" Long hose
- 3/8" Compression fittings
- 2-1/2" Maximum deck thickness
- Optional 10-1/2" escutcheon included
- 32" Minimum supply lines below deck included
- Water-efficient product: 1.5 gpm @ 60 psi



Part #	Mfg #	Description	Handle(s)	Finish	Price
134272	4153-DST	1- or 3-Hole, Pull-Down Spray, Lead-Free	ADA Lever	Chrome	
134747	4153-RB-DST	1- or 3-Hole, Pull-Down Spray, Lead-Free	ADA Lever	Venetian Bronze®	
156074	4153-AR-DST	1- or 3-Hole, Pull-Down Spray, Lead-Free	ADA Lever	Arctic Stainless™	

* Brilliance® Anti-Tarnish Lifetime Finishes

www.waterconcepts.net • Serving our Customers Since 1946 • www.plumbsupply.com

Kitchen Faucets & Accessories

Linden™ 1-Hdl Pull-Out Spray Kitchen Faucet

- 10" Reach, 8" high pull-out spout swivels 120°
- 5-3/4" From deck to aerator
- Touch-Clean® three-function Multi-Flow™ spray head
- 54" Long hose
- 3/8" Compression fittings
- 2-1/2" Maximum deck thickness
- Optional 10-1/2" escutcheon included
- 32" Minimum supply lines below deck included
- Water-efficient product: 1.5 gpm @ 60 psi



Part #	Mfg #	Description	Handle(s)	Finish	Price
126608	4353-DST	1- or 3-Hole, Pull-Out Spray, Lead-Free	ADA Lever	Chrome	
155381	4353-AR-DST	1- or 3-Hole, Pull-Out Spray, Lead-Free	ADA Lever	Arctic Stainless™	
126690	4353-RB-DST	1- or 3-Hole, Pull-Out Spray, Lead-Free	ADA Lever	Venetian Bronze®	

Linden™ 1-Hdl Pull-Out Spray Kitchen Faucet with Touch2O® Technology

- 10" Reach, 8" high pull-out spout swivels 120°
- 5-3/4" From deck to aerator
- 54" Long hose
- 3/8" Compression fittings
- 2-1/2" Maximum deck thickness
- Optional 10-1/2" escutcheon included
- 32" Minimum supply lines below deck included
- Water-efficient product: 1.5 gpm @ 60 psi
- Touch2O® technology



Part #	Mfg #	Description	Handle(s)	Finish	Price
185238	4353T-DST	1- or 3-Hole, Pull-Out Spray, Lead-Free	ADA Lever	Chrome	
155351	4353T-AR-DST	1- or 3-Hole, Pull-Out Spray, Lead-Free	ADA Lever	Arctic Stainless™	
159973	4353T-RB-DST	1- or 3-Hole, Pull-Out Spray, Lead-Free	ADA Lever	Venetian Bronze®	

Palo® 1-Hdl Pull-Out Spray Kitchen Faucet

- 9" Reach, 8-3/16" high pull-out spout swivels 120°
- 6-1/2" From deck to aerator
- Touch-Clean® two-function spray head
- 54" Long hose
- 3/8" Compression fittings
- 2-1/2" Maximum deck thickness
- Optional 10-1/2" escutcheon included
- 32" Minimum supply lines below deck included
- Water-efficient product: 1.8 gpm @ 60 psi



467-DST



467-SD-DST

Part #	Mfg #	Description	Handle(s)	Finish	Price
117360	467-DST	1- or 3-Hole, Pull-Out Spray, Lead-Free	ADA Lever	Chrome	
117361	467-SS-DST	1- or 3-Hole, Pull-Out Spray, Lead-Free	ADA Lever	Stainless*	
117362	467-SD-DST	2- or 4-Hole, Pull-Out Spray, Soap Dispenser, Lead-Free	ADA Lever	Chrome	
117502	467-SSSD-DST	2- or 4-Hole, Pull-Out Spray, Soap Dispenser, Lead-Free	ADA Lever	Stainless*	

* Brilliance® Anti-Tarnish Lifetime Finishes

www.plumbsupply.com • Serving our Customers Since 1946 • www.waterconcepts.net

Kitchen Faucets & Accessories

Faucets & Valves

Signature® 1-Hdl Pull-Out Spray Kitchen Faucet

- 9" Reach, 8" high spout swivels 120°
- 6-5/8" From deck to aerator
- Touch-Clean® 2-function spray head
- 54" Long hose
- 3/8" Compression fittings
- 2-1/2" Maximum deck thickness
- Optional 10-3/4" escutcheon included
- 32" Minimum supply lines below deck included
- Water-efficient product: 1.8 gpm @ 60 psi



470-DST

Part #	Mfg #	Description	Handle(s)	Finish	Price
117363	470-DST	1-Hole or 8"cc, Pull-Out Spray, Lead-Free	ADA Lever	Chrome	
117366	470-WH-DST	1-Hole or 8"cc, Pull-Out Spray, Lead-Free	ADA Lever	White	
134748	470-AR-DST	1-Hole or 8"cc, Pull-Out Spray, Lead-Free	ADA Lever	Arctic Stainless™	
117364	470-BL-DST	1-Hole or 8"cc, Pull-Out Spray, Lead-Free	ADA Lever	Matte Black	

Trinsic™ 1-Hdl Pull-Out Spray Kitchen Faucet

- 9-1/4" Reach, 12-21/32" high 360° swivel spout
- 6-39/64" From deck to aerator
- 54" Long hose
- 3/8" Compression fittings
- Order RP61607 for 1.5 gpm hose adapter
- 2-1/4" Max deck thickness
- 32" Minimum InnoFlex® supply lines
- 1.8 gpm @ 60 psi
- Euro-Motion DIAMOND™ Valve



Part #	Mfg #	Description	Handle(s)	Finish	Price
160863	4159-DST	1- or 3-Hole 8"cc, Pull-Out Spray, Lead Free	Lever	Chrome	
179785	4159-BL-DST	1- or 3-Hole 8"cc, Pull-Out Spray, Lead Free	Lever	Matte Black	
165335	4159-AR-DST	1- or 3-Hole 8"cc, Pull-Out Spray, Lead Free	Lever	Arctic Stainless™	

Single-Handle Kitchen Faucets

Bellini™ 1-Hdl Kitchen Faucet with Side Spray & Soap Dispenser

- Quick Snap® hose installation
- 45" Long spray hose
- Red/Blue graphics on handle button for hot/cold indication
- 3/8" OD Straight, staggered PEX supply tubes
- Spray attachment has anti-siphon device as integral part of valve



Part #	Mfg #	Description	Handle(s)	Finish	Price
134595	11946-SSSD-DST	3- or 4-Hole, 6"-16"ws, Side Spray & Soap Disp, Lead-Free	ADA Lever	Stainless*	

* Brilliance® Anti-Tarnish Lifetime Finishes

www.waterconcepts.net • Serving our Customers Since 1946 • www.plumbsupply.com

Kitchen Faucets & Accessories

Cassidy™ 1-Hdl Kitchen Faucet

- 10-1/8" Reach, 16" high 360° swivel spout
- 10-1/8" From deck to aerator
- 3/8" Compression fittings
- Order RP52216 for 1.5 gpm aerator insert
- 2-1/2" Max deck thickness
- 2-Hole 4" installation
- Matching finish spray
- 32" Minimum InnoFlex® supply lines
- DIAMOND™ Valve
- 1.8 gpm @ 60 psi



Faucets & Valves

Part #	Mfg #	Description	Handle(s)	Finish	Price
164870	4297-DST	2-Hole 4"cc, Lead Free	ADA Lever	Chrome	
162366	4297-AR-DST	2-Hole 4"cc, Lead Free	ADA Lever	Arctic Stainless™	
163172	4297-CZ-DST	2-Hole 4"cc, Lead Free	ADA Lever	Champagne Bronze™	
162621	4297-RB-DST	2-Hole 4"cc, Lead Free	ADA Lever	Venetian Bronze®	

Classic™ 1-Hdl Kitchen Faucet

- 8-11/16" Reach, 6-3/4" high spout swivels 170°
- 4-3/4" From deck to aerator
- 3/8" Compression fittings
- 2-1/2" Maximum deck thickness
- 32" Minimum supply lines below deck included
- Water-efficient product: 1.8 gpm @ 60 psi



100-DST



175-DST

Part #	Mfg #	Description	Handle(s)	Finish	Price
129288	100-DST	3-Hole 8"cc, Lead-Free	ADA Lever	Chrome	
180643	100-SS-DST	3-Hole 8"cc, Lead-Free	ADA Lever	Stainless*	
151159	100-BH-DST	3-Hole 8"cc, Lead-Free, Hot & Cold Indicators	ADA Lever	Chrome	
003745	101-DST	1-Hole, Lead-Free	ADA Lever	Chrome	
126979	175-DST	2-Hole, Side Spray, Lead-Free	ADA Lever	Chrome	
134650	300-DST	8"cc, Integral Spray	ADA Lever	Chrome	
129287	400-DST	4-Hole 8"cc, Side Spray, Lead-Free	ADA Lever	Chrome	
217805	400-SS-DST	4-Hole 8"cc, Side Spray, Lead-Free	ADA Lever	Stainless*	
170285	400-BH-DST	4-Hole 8"cc, Side Spray, Lead-Free	ADA Lever	Chrome	
156139	400LF-WF	4-Hole 8"cc, Side Spray, Lead-Free	ADA Lever	Chrome	

Classic™ 1-Hdl Kitchen Faucet

- 8" Reach, 7-3/16" high 360° swivel spout
- 5" From deck to aerator
- 1-1/4" Maximum deck thickness
- RP30393 adds 1" to maximum deck thickness
- Straight, staggered supply tubes
- Flow rate: 1.8 gpm @ psi
- Order RP19754 for 1.5 gpm aerator



Part #	Mfg #	Description	Handle(s)	Finish	Price
155099	100LF-WF	3-Hole 8"cc, Lead Free	ADA Lever	Chrome	

* Brilliance® Anti-Tarnish Lifetime Finishes

www.plumbsupply.com • Serving our Customers Since 1946 • www.waterconcepts.net

Kitchen Faucets & Accessories

Single-Handle Kitchen Faucets (Continued)

Classic™ 1-Hdl Kitchen Faucet

Part #	Mfg #	Description	Handle(s)	Finish	Price
166483	101LF-WF	1-Hole, Lead Free	ADA Lever	Chrome	

Collins™ 1-Hdl Kitchen Faucet

- 9-3/16" Reach spout swivels 170°
- 5-7/32" From deck to aerator
- 3/8" Compression fittings
- 2-1/2" Maximum deck thickness
- 32" Minimum supply lines below deck included
- Water-efficient product: 1.8 gpm @ 60 psi



140



340



440

Part #	Mfg #	Description	Handle(s)	Finish	Price
127889	140-DST	8"cc, Lead-Free	ADA Lever	Chrome	
052162	140-SS-DST	8"cc, Lead-Free	ADA Lever	Stainless*	
168085	140-WE-DST	3-Hole 8"cc, Lead Free 1.5 gpm	ADA Lever	Chrome	
126822	141-DST	1-Hole, Lead-Free	ADA Lever	Chrome	
129963	141-SS-DST	1-Hole, Lead-Free	ADA Lever	Stainless*	
130727	141-WH-DST	1-Hole, Lead-Free	ADA Lever	White	
129807	340-DST	8"cc, Integral Spray, Lead-Free	ADA Lever	Chrome	
055838	340-SS-DST	8"cc, Integral Spray, Lead-Free	ADA Lever	Stainless*	
127488	340-WH-DST	8"cc, Integral Spray, Lead-Free	ADA Lever	White	
126572	440-DST	8"cc, Side Spray, Lead-Free	ADA Lever	Chrome	
124987	440-WE-DST	8"cc, Side Spray, Water Efficient, Lead-Free	ADA Lever	Chrome	
126658	440-SS-DST	8"cc, Side Spray, Lead-Free	ADA Lever	Stainless*	
125395	440-SSWE-DST	8"cc, Side Spray, Water Efficient, Lead-Free	ADA Lever	Stainless*	
126660	440-WH-DST	8"cc, Side Spray, Lead-Free	ADA Lever	White	
126384	441-DST	2-Hole, Side Spray, Lead-Free	ADA Lever	Chrome	
126532	441-SS-DST	2-Hole, Side Spray, Lead-Free	ADA Lever	Stainless*	
127243	441-WH-DST	2-Hole, Side Spray, Lead-Free	ADA Lever	White	

Foundations® Core-B 1-Hdl Kitchen Faucet

- 9-1/2" Reach, 8-3/8" high spout swivels 360°
- 6-5/8" From deck to aerator
- 1/2" IPS Connection
- 1-1/2" Maximum deck thickness
- Water-efficient product: 1.8 gpm @ 60 psi



B1310LF



B3310LF



B4410LF

Part #	Mfg #	Description	Handle(s)	Finish	Price
130008	B1310LF	8"cc, Lead-Free	ADA Lever	Chrome	
226360	B1310LF-SS	8"cc, Lead-Free	ADA Lever	Stainless*	
139598	B3310LF	8"cc, Integral Spray, Lead-Free	ADA Lever	Chrome	
139599	B4410LF	8"cc, Side Spray, Lead-Free	ADA Lever	Chrome	
186142	B4410LF-SS	8"cc, Side Spray, Lead-Free	ADA Lever	Stainless*	

* Brilliance® Anti-Tarnish Lifetime Finishes

www.waterconcepts.net • Serving our Customers Since 1946 • www.plumbsupply.com

Kitchen Faucets & Accessories

Linden™ 1-Hdl Kitchen Faucet with Side Spray

- 9-13/16" Reach, 11-3/8" high spout swivels 120°
- 5-7/8" From deck to aerator
- 3/8" Compression fittings
- 2-1/2" Maximum deck thickness
- Optional 10-1/2" escutcheon included
- 32" Minimum supply lines below deck included
- Water-efficient product: 1.8 gpm @ 60 psi



3353



4453

Faucets & Valves

Part #	Mfg #	Description	Handle(s)	Finish	Price
144955	3353-DST	3-Hole, Integral Spray, Lead-Free	ADA Lever	Chrome	
160540	3353-AR-DST	3-Hole, Integral Spray, Lead Free	ADA Lever	Arctic Stainless®	
147214	3353-RB-DST	3-Hole, Integral Spray, Lead-Free	ADA Lever	Venetian Bronze®	
136869	4453-DST	2 or 4-Hole, Side Spray, Lead-Free	ADA Lever	Chrome	
163166	4453-AR-DST	2 or 4-Hole, Side Spray, Lead-Free	ADA Lever	Arctic Stainless™	
135898	4453-RB-DST	2 or 4-Hole, Side Spray, Lead-Free	ADA Lever	Venetian Bronze®	
137036	1353-DST	1-Hole, Less Side Spray, Lead Free	ADA Lever	Chrome	
136216	1353-AR-DST	1-Hole, Less Side Spray, Lead Free	ADA Lever	Arctic Stainless™	
138450	1353-RB-DST	1-Hole, Less Side Spray, Lead Free	ADA Lever	Venetian Bronze®	

Pilar® Waterfall® 1-Hdl Kitchen Faucet with Spray

- 10-1/2" Reach, 13" high, high-arc spout swivels 180°
- 9-3/4" From deck to aerator
- 3/8" Compression fittings
- 2-1/2" Maximum deck thickness
- 32" Minimum supply lines below deck included
- Water-efficient product: 1.8 gpm @ 60 psi
- DIAMOND™ Valve



Part #	Mfg #	Description	Handle(s)	Finish	Price
125911	4380-DST	3-Hole 6"-16"ws, Side Spray, Lead-Free	ADA Lever	Chrome	
134750	4380-AR-DST	3-Hole 6"-16"ws, Side Spray, Lead-Free	ADA Lever	Arctic Stainless™	
125913	4380-RB-DST	3-Hole 6"-16"ws, Side Spray, Lead-Free	ADA Lever	Venetian Bronze®	

Pilar® Waterfall® Touch2O 1-Hdl Kitchen Faucet with Side Spray

- 10-1/2" Reach, 13" high, high-arc spout swivels 180°
- 9-3/4" From deck to aerator
- Touch2O® Technology controls water flow
- 3/8" Compression fittings
- 2-1/2" Maximum deck thickness
- 32" Minimum supply lines below deck included
- Water-efficient product: 1.8 gpm @ 60 psi



Part #	Mfg #	Description	Handle(s)	Finish	Price
135919	4380T-AR-DST	6"-16"ws, Side Spray, Lead-Free	ADA Lever	Arctic Stainless™	

* Brilliance® Anti-Tarnish Lifetime Finishes

www.plumbsupply.com • Serving our Customers Since 1946 • www.waterconcepts.net

Kitchen Faucets & Accessories

Faucets & Valves

Trinsic® 1-Hdl Kitchen Faucet

- 8-1/4" Reach, 12-5/8" high 360° swivel spout
- 7" From deck to aerator
- 3/8" Compression fittings
- 1-1/8" Maximum deck thickness
- Water-efficient product: 1.8 gpm @ 60 psi



Part #	Mfg #	Description	Handle(s)	Finish	Price
152923	1159LF	1-Hole, Less Side Spray	ADA Lever	Chrome	
151619	1159LF-AR	1-Hole, Less Side Spray	ADA Lever	Arctic Stainless™	

Victorian® 1-Hdl Kitchen Faucet

- 9-3/8" Reach, 9" high spout swivels 180°
- 6" From deck to aerator
- 3/8" Compression fittings
- 2-1/2" Maximum deck thickness
- 32" Minimum supply lines below deck included
- Water-efficient product: 1.8 gpm @ 60 psi



Part #	Mfg #	Description	Handle(s)	Finish	Price
068297	155-DST	6"-16"ws, Side Spray, Lead-Free	ADA Lever	Chrome	
128022	155-RBDST	6"-16"ws, Side Spray, Lead-Free	ADA Lever	Venetian Bronze®	
128021	155-SSDST	6"-16"ws, Side Spray, Lead-Free	ADA Lever	Stainless*	

Two-Handle Kitchen Faucets

Cassidy™ 2-Hdl Kitchen Faucet

- 8-21/32" Reach, 13-15/32" high 360° swivel spout
- 8-11/32" Deck to aerator
- 1/2" IPS connection
- 1-3/4" Maximum deck thickness
- 1.8 gpm @ 60 psi (Order RP52216 aerator insert for 1.5 gpm)



Part #	Mfg #	Description	Handle(s)	Finish	Price
151677	2497LF	3 or 4 Hole, 8"cc, Matching Side Spray, Lead Free	ADA Lever	Chrome	
155756	2497LF-AR	3 or 4 Hole, 8"cc, Matching Side Spray, Lead Free	ADA Lever	Arctic Stainless™	
152924	2497LF-CZ	3 or 4 Hole, 8"cc, Matching Side Spray, Lead Free	ADA Lever	Champagne Bronze™	
152926	2497LF-RB	3 or 4 Hole, 8"cc, Matching Side Spray, Lead Free	ADA Lever	Venetian Bronze®	

* Brilliance® Anti-Tarnish Lifetime Finishes

www.waterconcepts.net • Serving our Customers Since 1946 • www.plumbsupply.com

Kitchen Faucets & Accessories

Classic 2-Hdl Kitchen Faucet

- Standard spout swivels 360°
- 9" Reach, 7-7/16" high
- 5" From deck to aerator
- Blade handles
- 1/2" IPS connection
- 7/8" Maximum deck thickness
- Flow rate: 1.8 gpm @ 60 psi



Part #	Mfg #	Description	Handle(s)	Finish	Price
153632	2100-LF	3-Hole 8"cc, Lead-Free	Blade	Chrome	
154112	2400-LF	4-Hole 8"cc White Side Spray, Lead-Free	Blade	Chrome	
154096	2102-LF	3-Hole 8"cc, Lead-Free	Knobs	Chrome	
153712	2402-LF	4-Hole 8"cc White Side Spray, Lead-Free	Knobs	Chrome	

Foundations® Core-B 2-Hdl Kitchen Faucet

- 9-1/4" Reach, 6-7/16" high spout swivels 360°
- 5-3/8" From deck to aerator
- 1/2" IPS Connection
- 1-1/8" Maximum deck thickness
- Water-efficient product: 1.8 gpm @ 60 psi



Part #	Mfg #	Description	Handle(s)	Finish	Price
135568	B2310LF	3-Hole 8"cc, Lead-Free	ADA Lever	Chrome	
160747	B2312LF	3-Hole 8"cc, Lead-Free	Crystal Knobs	Chrome	
135944	B2410LF	4-Hole 8"cc, Side Spray, Lead-Free	ADA Lever	Chrome	
161067	B2412LF	4-Hole 8"cc, Side Spray, Lead-Free	Crystal Knobs	Chrome	

Pillar Series 2-Hdl Kitchen Faucet

- 10-1/2" Reach, 13" high, high-arc spout swivels 180°
- 9-3/4" From deck to aerator
- 3/8" Compression fittings
- 2-1/2" Maximum deck thickness
- Water-efficient product: 1.8 gpm @ 60 psi
- ADA Compliant



Part #	Mfg #	Description	Handle(s)	Finish	Price
144333	2480-DST	6-16"ws, Side Spray, Lead-Free	ADA Metal Lever	Chrome	
145786	2480-AR-DST	6-16"ws, Side Spray, Lead-Free	ADA Metal Lever	Arctic Stainless™	
148628	2480-RB-DST	6-16"ws, Side Spray, Lead-Free	ADA Metal Lever	Venetian Bronze®	

* Brilliance® Anti-Tarnish Lifetime Finishes

www.plumbsupply.com • Serving our Customers Since 1946 • www.waterconcepts.net

Kitchen Faucets & Accessories

Faucets & Valves

Victorian® 2-Hdl Kitchen Faucet

- Tall high-arc spout
- 9" Reach, 9" high spout swivels 360°
- 6" From deck to aerator
- 3/8" Compression fittings
- 2-1/2" Maximum deck thickness
- Side spray with 45" hose length
- Water-efficient product: 1.8 gpm @ 60 psi



Part #	Mfg #	Description	Handle(s)	Finish	Price
148292	2256-DST	6"-16"ws, Side Spray, Lead-Free	ADA Metal Lever	Chrome	
152551	2256-RB-DST	6"-16"ws, Side Spray, Lead-Free	ADA Metal Lever	Venetian Bronze®	
148482	2256-SS-DST	6"-16"ws, Side Spray, Lead-Free	ADA Metal Lever	Stainless*	

Windemere® 2-Hdl Kitchen Faucet

- 8" Reach, 11-5/8" high spout swivels 360°
- 6-3/4" From deck to aerator
- 1/2" - 14 NPSM threaded male inlet shanks
- Minimum 2-1/2" Clearance to back splash
- Flow rate: 1.8 gpm @ 60 psi



Part #	Mfg #	Description	Handle(s)	Finish	Price
174237	21996LF	8"cc, Side Spray, Lead Free	ADA Lever	Chrome	
189169	21996LF-OB	8"cc, Side Spray, Lead Free	ADA Lever	Oil-Rubbed Bronze	
186851	21996LF-SS	8"cc, Side Spray, Lead Free	ADA Lever	Stainless*	

* Brilliance® Anti-Tarnish Lifetime Finishes

www.waterconcepts.net • Serving our Customers Since 1946 • www.plumbsupply.com

Soap Dispensers

Soap/Lotion Dispensers

Soap/Lotion Dispenser

- 13 oz Bottle
- Replaced RP1000
- Refillable from above the deck
- Includes refill funnel



Part #	Mfg #	Description	Price
044358	RP1001	Chrome	
134749	RP1001AR	Arctic™ Stainless	
075150	RP1001BL	Black	
044441	RP1001BS	Biscuit	
074041	RP1001RB	Venetian Bronze®	
054299	RP1001SS	Stainless*	
025434	RP21904	Soap Dispenser Bottle	

Soap/Lotion Dispenser Assembly

- 2-7/8" Height



Part #	Mfg #	Description	Price
225404	RP82129SP	SpotShield Stainless	

Allora® Soap/Lotion Dispenser

- 12.5 oz Bottle
- Refillable from above the deck
- 2-13/16" Maximum deck thickness



Part #	Mfg #	Finish	Price
147899	RP47280AR	Arctic™ Stainless	
106170	RP47280SS	Stainless*	

Contemporary Touch Soap Dispenser

- Touch2O.xt Technology offers both touch and proximity sensing technology to activate
- Battery operated (6 AA included)
- Mounting hardware included
- Refillable from above the deck
- 3" Maximum deck thickness



Part #	Mfg #	Description	Price
173907	72065T-AR	Arctic Stainless	
185537	72065T-BL	Matte Black	
184460	72065T-SS	Stainless*	

Cassidy™ Soap/Lotion Dispenser

- 13 oz Bottle
- Refillable from above the deck
- 2-1/2" Maximum deck thickness



Part #	Mfg #	Description	Price
151965	RP71543	Chrome	
152684	RP71543AR	Arctic Stainless™	
152823	RP71543CZ	Champagne Bronze™	
152824	RP71543RB	Venetian Bronze®	

Classic® Soap/Lotion Dispenser

- 13 oz Bottle
- Refillable from above the deck
- 2-1/2" Maximum deck thickness



Part #	Mfg #	Description	Price
134634	RP1002	Chrome	
146137	RP1002AR	Arctic Stainless™	
134625	RP1002RB	Venetian Bronze®	
135384	RP1002SS	Stainless*	

Leland® Soap/Lotion Dispenser

- 13 oz Bottle
- Refillable from above the deck
- 2-1/2" Maximum deck thickness



Part #	Mfg #	Description	Price
122280	RP50813	Chrome	
154936	RP50813AR	Arctic Stainless™	
165391	RP50813CZ	Champagne Bronze™	
122725	RP50813RB	Venetian Bronze®	
121289	RP50813SS	Stainless*	

Pilar® Soap/Lotion Dispenser

- 13 oz Bottle
- Refillable from above the deck
- 2-1/2" Maximum deck thickness



Part #	Mfg #	Description	Price
125914	RP50781	Chrome	
134737	RP50781AR	Arctic Stainless™	
151143	RP50781CZ	Champagne Bronze™	
125917	RP50781RB	Venetian Bronze®	
125916	RP50781SS	Stainless*	

* Brilliance® Anti-Tarnish Lifetime Finishes

www.plumbsupply.com • Serving our Customers Since 1946 • www.waterconcepts.net

Soap Dispensers

Faucets & Valves

Traditional Touch Soap Dispenser

- Touch2O.xt Technology offers both touch and proximity sensing technology to activate
- Battery operated (6 AA included)
- Mounting hardware included
- Refillable from above the deck
- 3" Maximum deck thickness



Part #	Mfg #	Description	Price
188595	72045T-AR	Arctic Stainless™	
222071	72045T-CZ	Champagne Bronze™	
189399	72045T-RB	Venetian Bronze®	

Transitional Touch2O.xt® Soap/Lotion Dispenser

- 13 oz Bottle
- Refillable from above the deck
- 3" Maximum deck thickness
- Touch2O.xt® Technology offers both touch and proximity sensing technology to activate
- Hands-free activation
- Programmable at the spout
- Drip-free performance
- Battery operated (6 AA included)
- Fits pre-drilled 1-1/8"-1-1/2" holes
- Includes (RP30395) refill funnel



Part #	Mfg #	Description	Price
185147	72055T	Chrome	
172454	72055T-AR	Arctic Stainless	
225926	72055T-BL	Matte Black	
187583	72055T-SS	Stainless*	

Victorian® Soap/Lotion Dispenser

- 13 oz Bottle
- Refillable from above the deck
- 1-1/2" Maximum deck thickness
- Includes (RP30395) refill funnel



Part #	Mfg #	Description	Price
073318	RP37039RB	Venetian Bronze®	
072072	RP37039SS	Stainless*	

* Brilliance® Anti-Tarnish Lifetime Finishes

www.waterconcepts.net • Serving our Customers Since 1946 • www.plumbsupply.com

Kitchen Faucets & Accessories

Pot Fillers

Modern Pot Filler

- Wall-mount
- 1/2" IPS
- Flow rate: 5.5 gpm



Part #	Mfg #	Description	Handle(s)	Finish	Price
189229	S665	1-Hole	ADA Lever	Chrome	
168490	S665SRS	1-Hole	ADA Lever	Spot Resist Stainless	

Traditional Pot Filler

- Wall-Mount
- 1/2" IPS
- Aerated stream
- Flow rate: 5.5 gpm



Part #	Mfg #	Description	Handle(s)	Finish	Price
204102	S664	1-Hole	ADA Lever	Chrome	
113776	S664ORB	1-Hole	ADA Lever	Oil Rubbed Bronze	
189554	S664SRS	1-Hole	ADA Lever	Spot Resist Stainless	

Pull-Down Spray Kitchen Faucets

Aberdeen™ 1-Hdl Pull-Down Spray Kitchen Faucet

- 7-7/8" Reach, 14-5/8" high spout
- 7-3/8" From deck to aerator
- Reflex™ pulldown system with 68" braided hose
- Hydrolock® Quick connect system
- Flexible supplies with 3/8" compression fittings
- 1255™ Duralast™ cartridge
- WaterSense® certified: 1.5 gpm



Part #	Mfg #	Description	Handle(s)	Finish	Price
068863	7490C	2-Hole, Pull-Down Spray	ADA Lever	Chrome	
129337	7590CSL	2-Hole, Pull-Down Spray	ADA Lever	Classic Stainless	
087510	7590ORB	2-Hole, Pull-Down Spray	ADA Lever	Oil Rubbed Bronze	

* Lifeshine® Anti-Tarnish Lifetime Finish

www.plumbsupply.com • Serving our Customers Since 1946 • www.waterconcepts.net

Kitchen Faucets & Accessories

Faucets & Valves

Arbor™ 1-Hdl Pull-Down Spray Kitchen Faucet

- 7-7/8" Reach, 15-1/2" high swivel spout
- 8-1/4" From deck to aerator
- 3/8" Compression fittings
- 1255™ Duralast™ cartridge
- WaterSense® certified: 1.5 gpm



Part #	Mfg #	Description	Handle(s)	Finish	Price
145145	7594BL	1- or 3-Hole, Pull-Down Spray	ADA Lever	Matte Black	
136634	7594C	1- or 3-Hole, Pull-Down Spray	ADA Lever	Chrome	
135943	7594ORB	1- or 3-Hole, Pull-Down Spray	ADA Lever	Oil Rubbed Bronze	
153795	7594SRS	1- or 3-Hole, Pull-Down Spray	ADA Lever	Spot Resist Stainless	

Arbor™ MotionSense™ 1-Hdl Pull-Down Spray Kitchen Faucet

- 7-7/8" Reach, 15-1/2" high swivel spout
- 8-1/4" From deck to aerator
- 3/8" Compression fittings
- 1255™ Duralast™ cartridge
- Powered by (6) AA batteries
- WaterSense® certified: 1.5 gpm



Part #	Mfg #	Description	Handle(s)	Finish	Price
163151	7594EC	1- or 3-Hole, Pull-Down Spray w/ Motion Sense™	ADA Lever	Chrome	
157056	7594EORB	1- or 3-Hole, Pull-Down Spray w/ Motion Sense™	ADA Lever	Oil Rubbed Bronze	
151596	7594ESRS	1- or 3-Hole, Pull-Down Spray w/ Motion Sense™	ADA Lever	Spot Resist Stainless	

Align™ 1-Hdl Pull-Down Spray Kitchen Faucet

- 7-17/32" Reach, 15-5/8" high 360° swivel spout
- 9-1/2" From deck to aerator
- 3/8" Compression fittings
- 1255™ Duralast™ cartridge
- Optional 141002 escutcheon available for 3-hole application
- WaterSense® certified: 1.5 gpm



Part #	Mfg #	Description	Handle(s)	Finish	Price
171772	7565	1-Hole, Pull-Down Spray	ADA Lever	Chrome	
159429	7565SRS	1-Hole, Pull-Down Spray	ADA Lever	Spot Resist Stainless	

* Lifeshine® Anti-Tarnish Lifetime Finish

www.waterconcepts.net • Serving our Customers Since 1946 • www.plumbsupply.com

Kitchen Faucets & Accessories

Align™ MotionSense™ 1-Hdl Pull-Down Spray Kitchen Faucet

- 7-1/2" Reach, 15-5/8" high 360° swivel spout
- 9-1/2" From deck to aerator
- 3/8" Compression fittings
- 1255™ Duralast™ cartridge
- Powered by (6) AA batteries or option AC adapter with power splitter
- WaterSense® certified: 1.5 gpm



Faucets & Valves

Part #	Mfg #	Description	Handle(s)	Finish	Price
185534	7565ESRS	1-Hole, Pull-Down Spray w/ MotionSense™	ADA Lever	Spot Resist Stainless	

Align™ 1-Hdl Pre-Rinse Spring Pull-Down Spray Kitchen Faucet

- 10" Reach, 22-1/2" high swivel spout
- 8-3/4" From deck to aerator
- 3/8" Compression fittings
- 1255™ Duralast™ cartridge
- PowerClean™ spray technology
- 2-1/2" Maximum deck thickness
- 68" Braided hose
- WaterSense® certified: 1.5 gpm



Part #	Mfg #	Description	Handle(s)	Finish	Price
221768	5923	1-Hole, Pull-Down Spray	ADA Lever	Chrome	
187906	5923SRS	1-Hole, Pull-Down Spray	ADA Lever	Spot Resist Stainless	

Brantford™ 1-Hdl Pull-Down Spray Kitchen Faucet

- 15.72" High arc spout rotates 360°
- Hydrolock® quick connect installation
- Pull-out spray with 68" braided hose
- Flexible supply lines with 3/8" compression fittings
- Maximum flow: 2.2 gpm



Part #	Mfg #	Description	Handle(s)	Finish	Price
147215	7185C	1- or 3-Hole, Pull-Down Spray	ADA Side Lever	Chrome	
163584	7185SRS	1- or 3-Hole, Pull-Down Spray	ADA Side Lever	Spot Resist Stainless	
143931	7185ORB	1- or 3-Hole, Pull-Down Spray	ADA Side Lever	Oil Rubbed Bronze	

* Lifeshine® Anti-Tarnish Lifetime Finish

www.plumbsupply.com • Serving our Customers Since 1946 • www.waterconcepts.net

Kitchen Faucets & Accessories

Faucets & Valves

Brantford™ with Motion Sense™ 1-Hdl Pull-Down Spray Kitchen Faucet

- 7-7/8" Reach, 15-1/2" high spout
- 8-1/4" From deck to aerator
- 3/8" Compression fittings
- 1255™ Duralast™ cartridge
- Powered by (6) AA batteries
- WaterSense® certified: 1.5 gpm



Part #	Mfg #	Description	Handle(s)	Finish	Price
176530	7185EORB	1- or 3-Hole, Pull-Down Spray w/ Motion Sense™	ADA Lever	Oil Rubbed Bronze	
161568	7185ESRS	1- or 3-Hole, Pull-Down Spray w/ Motion Sense™	ADA Lever	Spot Resist Stainless	

Etch 1-Hdl Pull Down Spray Kitchen Faucet-1/4

- 8-1/4" Reach, 17-3/16" high swing spout
- 3/8" Connections, flexible supplies
- 68" Braided hose
- Duralock quick connect installation
- 1255™ Duralast cartridge
- WaterSense® certified: 1.5 gpm



Part #	Mfg #	Description	Handle(s)	Finish	Price
181277	S72608	1 Hole, Pull-Down Spray	ADA Lever	Chrome	
175000	S72608SRS	1 Hole, Pull-Down Spray	ADA Lever	Spot Resist Stainless	

Notch™ 1-Hdl Pull-Down Spray Kitchen Faucet

- 7-13/16" Reach, 16-1/4" high spout
- 8-5/8" From deck to aerator
- 68" Braided hose
- 3/8" Connections with flexible supplies
- 1255™ Duralast™ cartridge
- WaterSense® certified: 1.5 gpm



Part #	Mfg #	Description	Handle(s)	Finish	Price
220017	9124C	1 Hole, Pull-Down Spray	ADA Lever	Chrome	
189422	9124ORB	1-Hole, Pull-Down Spray	ADA Lever	Oil Rubbed Bronze	
187327	9124SRS	1 Hole, Pull-Down Spray	ADA Lever	Spot Resist Stainless	

* Lifeshine® Anti-Tarnish Lifetime Finish

www.waterconcepts.net • Serving our Customers Since 1946 • www.plumbsupply.com

Kitchen Faucets & Accessories

Sto 1-Hdl Pull-Down Spray Kitchen Faucet

- 9" Reach, 17-1/4" high, 360° rotating spout
- Reflex™ pulldown system
- 68" Braided hose
- 3/8" Connection, flexible supplies
- 1255™ Duralast™ cartridge
- WaterSense® certified: 1.5 gpm



Part #	Mfg #	Description	Handle(s)	Finish	Price
168239	S72308	1 Hole, Pull-Down Spray	ADA Lever	Chrome	
166429	S72308SRS	1 Hole, Pull-Down Spray	ADA Lever	Spot Resist Stainless	

Woodmere® 1-Hdl Pull-Down Spray Kitchen Faucet

- 7-7/8" Reach, 16-7/8" high spout
- 9-9/16" From deck to aerator
- 3/8" Compression fittings
- 1255™ Duralast™ cartridge
- Reflex™ system with 68" braided hose
- 2-1/2" Maximum deck thickness
- WaterSense® certified: 1.5 gpm



Part #	Mfg #	Description	Handle(s)	Finish	Price
223207	7615ORB	1-Hole, Pull-Down Spray	ADA Lever	Oil Rubbed Bronze	
221550	7615SRS	1-Hole, Pull-Down Spray	ADA Lever	Spot Resist Stainless	

Pull-Out Spray Kitchen Faucets

90 Degree™ 1-Hdl Pull-Out Spray Kitchen Faucet

- 9-13/16" Reach, 12-3/8" high swivel spout
- 11-5/16" From deck to aerator
- Flexible supply Lines with 3/8" compression fittings
- 1255™ Duralast™ cartridge
- WaterSense® certified: 1.5 gpm



Part #	Mfg #	Description	Handle(s)	Finish	Price
171013	S7597SRS	1 Hole, Pull-Out Spray	ADA Lever	Spot Resist Stainless	

* Lifeshine® Anti-Tarnish Lifetime Finish

www.plumbsupply.com • Serving our Customers Since 1946 • www.waterconcepts.net

Kitchen Faucets & Accessories

Faucets & Valves

Arbor™ 1-Hdl Pull-Out Spray Kitchen Faucet

- 8-1/8" reach, 12-1/8" high 360° swivel spout
- 10-1/8" From deck to aerator
- 3/8" Compression fittings
- 1255™ Duralast™ cartridge
- WaterSense® certified: 1.5 gpm



Part #	Mfg #	Description	Handle(s)	Finish	Price
157001	7294BL	1- or 3-Hole, Pull-Down Spray	ADA Lever	Matte Black	
156048	7294C	1- or 3-Hole, Pull-Down Spray	ADA Lever	Chrome	
165939	7294ORB	1- or 3-Hole, Pull-Down Spray	ADA Lever	Oil Rubbed Bronze	
153839	7294SRS	1- or 3-Hole, Pull-Down Spray	ADA Lever	Spot Resist Stainless	

Brantford™ 1-Hdl Pull-Out Spray Kitchen Faucet

- 10" Reach, 9-15/16" high swing spout
- 6-15/16" From deck to aerator
- 3/8" Compression connections
- 68" Braided hose
- Duralock quick connect installation
- 1255™ Duralast cartridge
- WaterSense® certified: 1.5 gpm



Part #	Mfg #	Description	Handle(s)	Finish	Price
221479	7295SRS	1- or 3-Hole, Pull-Out Spray	ADA Lever	Spot Resist Stainless	

Camerist® 1-Hdl Pull-Out Spray Kitchen Faucet

- 9" Reach, 9-1/12" high swing spout
- 3/8" Connections, flexible supplies
- 68" Hose
- Hydrolock® quick connect installation
- Spray functions: aerated, rinse and veggie
- Pause button temporarily stops the flow of water
- Integral vacuum breaker
- Maximum flow: 2.5 gpm



Part #	Mfg #	Description	Handle(s)	Finish	Price
096703	7545C	1- or 3-Hole, Pull-Out Spray	ADA Lever	Chrome	
102245	7545ORB	1- or 3-Hole, Pull-Out Spray	ADA Lever	Oil Rubbed Bronze	
162356	7545SRS	1- or 3-Hole, Pull-Out Spray	ADA Lever	Spot Resist Stainless	

* Lifeshine® Anti-Tarnish Lifetime Finish

www.waterconcepts.net • Serving our Customers Since 1946 • www.plumbsupply.com

Kitchen Faucets & Accessories

Extensa® 1-Hdl Pull-Out Spray Kitchen Faucet

- 10-1/2" Reach spout, 10-3/4" high swing spout
- 3/8" Connections, flexible supplies
- 59" Hose
- Hydrolock® quick connect installation
- Integral vacuum breaker
- Spray functions: stream or spray
- WaterSense® certified: 1.5 gpm



Part #	Mfg #	Description	Handle(s)	Finish	Price
127699	7560CSL	1- or 3-Hole, Pull-Out Spray	ADA Lever	*Classic Stainless	

Integra® 1-Hdl Pull-Out Spray Kitchen Faucet

- 9-5/8" Reach spout, 10-5/8" high swing spout
- 3/8" Connections with flexible supplies
- 68" Hose
- Hydrolock® quick connect installation
- Spray functions: stream or spray
- Includes optional escutcheon
- WaterSense® certified: 1.5 gpm



Part #	Mfg #	Description	Handle(s)	Finish	Price
063242	67315C	1- or 3-Hole, Pull-Out Spray	ADA Lever	Chrome	
168493	67315SRS	1- or 3-Hole, Pull-Out Spray	ADA Lever	Spot Resist Stainless	

Tilt™ 1-Hdl Pull-Out Spray Kitchen Faucet

- 9-1/16" Reach, 10-7/16" 110° rotating spout
- 9" From deck to aerator
- 3/8" Compression fittings
- 1255™ Duralast™ cartridge
- Flow rate: 2.5 gpm



Part #	Mfg #	Description	Handle(s)	Finish	Price
189855	7626C	1 Hole, Pull-Out Spray	ADA Lever	Chrome	
225856	7626SRS	1 Hole, Pull-Out Spray	ADA Lever	Spot Resist Stainless	

Voss™ 1-Hdl Pull-Out Spray Kitchen Faucet

- 9-25/64" Reach, 12-19/64" high spout
- 7-23/64" From deck to aerator
- Reflex™ system with 68" braided hose
- 3/8" Compression fittings
- 1255™ Duralast™ cartridge
- 2-1/2" Maximum deck thickness
- WaterSense® certified: 1.5 gpm



Part #	Mfg #	Description	Handle(s)	Finish	Price
187350	9125SRS	1-Hole, Pull-Out Spray	ADA Lever	Spot Resist Stainless	
187180	9125ORB	1-Hole, Pull-Out Spray	ADA Lever	Oil Rubbed Bronze	

* Lifeshine® Anti-Tarnish Lifetime Finish

www.plumbsupply.com • Serving our Customers Since 1946 • www.waterconcepts.net

Kitchen Faucets & Accessories

Faucets & Valves

Single-Handle Kitchen Faucets

Align™ 1-Hdl Kitchen Faucet

- 8" Reach, 15-5/16" high 360° rotating spout
- 9-5/8" From deck to aerator
- 3/8" Connections, flexible supplies
- 1255™ Duralast™ cartridge
- WaterSense® certified: 1.5 gpm



Part #	Mfg #	Description	Handle(s)	Finish	Price
167803	7165	2-Hole, Matching Side Spray	ADA Lever	Chrome	
180852	7365	1-Hole, Less Side Spray	ADA Lever	Chrome	
177175	7365SRS	1-Hole, Less Side Spray	ADA Lever	Spot Resist Stainless	

Arbor® 1-Hdl Kitchen Faucet

- 8-1/8" Reach, 15-1/2" high 360° swivel spout
- 12-1/2" From deck to aerator
- 3/8" Compression fittings
- 1255™ Duralast™ cartridge
- WaterSense® certified: 1.5 gpm



Part #	Mfg #	Description	Handle(s)	Finish	Price
185345	7790SRS	2-Hole, Matching Side Spray	ADA Lever	Spot Resist Stainless	

Banbury® 1-Hdl Kitchen Faucet

- 9" Reach, 7-1/4" high
- 4-1/2" From deck to aerator
- 3/8" Compression fittings
- 1255™ Duralast™ cartridge
- WaterSense® certified: 1.5 gpm



Part #	Mfg #	Description	Handle(s)	Finish	Price
164962	87690SRS	4-Hole, Matching Side Spray	ADA Lever	Spot Resist Stainless	

Belfield™ 1-Hdl Kitchen Faucet

- 10" Reach, 10" high spout
- 7-7/8" From deck to aerator
- 3/8" Compression fittings
- 1255™ Duralast™ cartridge
- WaterSense® certified: 1.5 gpm



Part #	Mfg #	Description	Handle(s)	Finish	Price
185237	7245C	4-Hole, Matching Side Spray	ADA Lever	Chrome	
223083	7245ORB	4-Hole, Matching Side Spray	ADA Lever	Oil Rubbed Bronze	
229186	7240SRS	1- or 3-Hole, Less Side Spray	ADA Lever	Spot Resist Stainless	

* Lifeshine® Anti-Tarnish Lifetime Finish

www.waterconcepts.net • Serving our Customers Since 1946 • www.plumbsupply.com

Kitchen Faucets & Accessories

Brantford™ 1-Hdl Kitchen Faucet

- 8-1/8" Reach, 15-1/2" high 360° swivel spout
- 12-1/2" From deck to aerator
- 3/8" Compression fittings
- 1255™ Duralast™ cartridge
- WaterSense® certified: 1.5 gpm



Part #	Mfg #	Description	Handle(s)	Finish	Price
166241	7735SRS	2-Hole, Matching Side Spray	ADA Lever	Spot Resist Stainless	

Camerist™ 1-Hdl Kitchen Faucet

- 9-1/4" Reach, 8-1/8" high spout
- 6-1/8" From deck to aerator
- 3/8" Compression fittings
- 1255™ Duralast™ cartridge
- WaterSense® certified: 1.5 gpm



Part #	Mfg #	Description	Handle(s)	Finish	Price
099151	7825	1- or 3-Hole, Less Side Spray	ADA Lever	Chrome	
117369	7825ORB	1- or 3-Hole, Less Side Spray	ADA Lever	Oil Rubbed Bronze	
174083	7825SRS	1- or 3-Hole, Less Side Spray	ADA Lever	Spot Resist Stainless	
088084	7840	2- or 4-Hole, Matching Side Spray	ADA Lever	Chrome	
113915	7840ORB	2- or 4-Hole, Matching Side Spray	ADA Lever	Oil Rubbed Bronze	
174447	7840SRS	2- or 4-Hole, Matching Side Spray	ADA Lever	Spot Resist Stainless	

Chateau® 1-Hdl Kitchen Faucet

- 9-1/8" Reach, 6-3/4" high swing spout
- 3/8" Connections, flexible supplies
- Hydrolock® quick connect installation
- Maximum flow: 2.0 gpm



Part #	Mfg #	Description	Handle(s)	Finish	Price
037482	7423	1-Hole, Less Side Spray	ADA Lever	Chrome	
029728	7425	8"cc, 3-Hole, Less Side Spray	ADA Lever	Chrome	
147853	67425	8"cc, 3-Hole, Less Side Spray (Bulk 12/Pk)	ADA Lever	Chrome	
037058	67430	8"cc, 4-Hole, Matching Side Spray	ADA Lever	Chrome	
029729	7430	8"cc, 4-Hole, Matching Side Spray	ADA Lever	Chrome	
087346	7430BC	8"cc, 4-Hole, Matching Side Spray	ADA Lever	Brushed Chrome	

* Lifeshine® Anti-Tarnish Lifetime Finish

www.plumbsupply.com • Serving our Customers Since 1946 • www.waterconcepts.net

Kitchen Faucets & Accessories

Faucets & Valves

Waterhill™ 1-Hdl Kitchen Faucet

- 9-3/8" Reach, 12-1/4" high spout
- 8-1/2" from deck to aerator
- 3/8" Connections, flexible supplies
- 1255™ Duralast™ cartridge
- Maximum flow: 1.5 gpm



Part #	Mfg #	Description	Handle(s)	Finish	Price
100453	S711	3-Hole, Matching Side Spray	ADA Lever	Chrome	

Weymouth 1-Hdl Kitchen Faucet

- 8-1/4" Reach, 10-1/2" high 360° rotating spout
- 7-1/2" From deck to aerator
- Flexible supply line with 3/8" compression Fitting
- 1255™ Duralast™ cartridge
- WaterSense® certified: 1.5 gpm



Part #	Mfg #	Description	Handle(s)	Finish	Price
185236	S72101	2-Hole, Matching Side Spray	ADA Lever	Chrome	
183889	S72101NL	2-Hole, Matching Side Spray	ADA Lever	Polished Nickel	
164050	S72101SRS	2-Hole, Matching Side Spray	ADA Lever	Spot Resist Stainless	
179531	S72101ORB	2-Hole, Matching Side Spray	ADA Lever	Oil Rubbed Bronze	

Two-Handle Kitchen Faucets

Belfield™ Two-Handle Kitchen Faucet

- 9-1/2" Reach, 9-11/32" high spout
- 7-3/8" From deck to aerator
- 1/2" IPS connections
- 1224™ Cartridge design
- WaterSense® certified: 1.5 gpm



Part #	Mfg #	Description	Handle(s)	Finish	Price
224947	7250ORB	3-Hole, Less Side Spray	ADA lever	Oil Rubbed Bronze	

Waterhill™ Two-Handle Bridge Kitchen Faucet

- 9-3/8" Reach, 11-15/32" high
- 7-3/4" From deck to aerator
- 1/2" IPS connections
- 1224 Cartridge
- WaterSense® certified: 1.5 gpm



Part #	Mfg #	Description	Handle(s)	Finish	Price
158775	S713	2- or 4-Hole, Matching Side Spray	ADA Lever	Chrome	
105506	S713ORB	2- or 4-Hole, Matching Side Spray	ADA Lever	Oil Rubbed Bronze	
187303	S713SRS	2- or 4-Hole, Matching Side Spray	ADA Lever	Spot Resist Stainless	
103954	S713WR	2- or 4-Hole, Matching Side Spray	ADA Lever	Wrought Iron	

* Lifeshine® Anti-Tarnish Lifetime Finish

www.waterconcepts.net • Serving our Customers Since 1946 • www.plumbsupply.com

Kitchen Faucets & Accessories

Waterhill™ Two-Handle Kitchen Faucet

- 9-3/8" Reach, 12-1/4" high 360° rotating spout
- 8-1/2" From deck to aerator
- 1/2" IPS Connections, 3/8" tubing
- 1224 Cartridge
- Flow rate: 2.0 gpm



Part #	Mfg #	Description	Handle(s)	Finish	Price
168354	S712	8"cc, 4-Hole, Matching Side Spray	ADA Lever	Chrome	
110155	S712ORB	8"cc, 4-Hole, Matching Side Spray	ADA Lever	Oil Rubbed Bronze	

Kitchen Faucet Accessories

Kitchen Faucet Adapter Kit



Part #	Mfg #	Description	Handle(s)	Finish	Price
189586	169031	Kitchen Faucet Adapter			

Faucets & Valves

* Lifeshine® Anti-Tarnish Lifetime Finish

www.plumbsupply.com • Serving our Customers Since 1946 • www.waterconcepts.net

Soap Dispensers

Faucets & Valves

Kitchen Faucet Accessories

Traditional Soap/Lotion Dispenser

- Top lifts off for easy refill
- 18 oz Refillable bottle
- Mounts in 1-1/8" diameter hole



Part #	Mfg #	Finish	Price
140198	3944	Chrome	
119049	3944ORB	Oil Rubbed Bronze	
153722	3944SRS	Spot Resist Stainless	

Soap/Lotion Dispenser

- 3.13" Height
- 2.75" Spout reach
- 2-1/4" Max deck thickness
- 1-1/8" Hole diameter
- 18 oz refillable bottle



Part #	Mfg #	Finish	Price
122900	3942	Chrome	
129743	3942BL	Matte Black	
146576	3942W	Glacier	
155791	3942SRS	Spot Resist Stainless	

Modern Soap/Lotion Dispenser

- 5" Height
- 3.50" Spout reach
- 3-1/2" Max deck thickness
- 1-1/8" Hole diameter
- 18 oz refillable bottle



Part #	Mfg #	Finish	Price
171272	S3947C	Chrome	
180915	S3947SRS	Spot Resist Stainless	

Traditional Soap Dispenser

- 5" Height
- 3.50" Spout Reach
- 3-1/2" Max deck thickness
- 1-1/8" Hole diameter
- 18 oz refillable bottle



Part #	Mfg #	Finish	Price
215706	S3945C	Chrome	
180906	S3945ORB	Oil Rubbed Bronze	
170788	S3945SRS	Spot Resist Stainless	

Transitional Soap/Lotion Dispenser

- 3.78" Reach
- Press down, pump action
- 18 oz Refillable bottle
- Mounts in 1-1/8" diameter hole



Part #	Mfg #	Finish	Price
216312	S3946C	Chrome	
227909	S3946BL	Matte Black	
168814	S3946ORB	Oil Rubbed Bronze	
168813	S3946SRS	Spot Resist Stainless	

Transitional (2) Soap/Lotion Dispenser

- 5" Height
- 3.5" Reach
- 3-1/2" Max deck thickness
- 1-1/8" Hole diameter
- 18 oz refillable bottle



Part #	Mfg #	Finish	Price
213250	S3948C	Chrome	
175002	S3948SRS	Spot Resist Stainless	

*Lifeshine® Anti-Tarnish Lifetime Finish

www.waterconcepts.net • Serving our Customers Since 1946 • www.plumbsupply.com

Kitchen Faucets

Pot Fillers

Blanco Cantata™ Pot Filler

- Cold water only
- Ceramic disc cartridge
- 2.2 GPM flow rate



Part #	Mfg #	Description	Handle(s)	Finish	Price
156122	441194	Wall Mounted, 21-3/4" Reach	Lever	Chrome	
150486	441195	Wall Mounted, 21-3/4" Reach	Lever	Satin Nickel	

Pull-Down Spray Kitchen Faucets

Blanco Artona™ 1-Hdl Pull-Down Kitchen Faucet

- 8-5/8" Reach, 15-3/4" height
- 180° Swivel spout
- Solid brass body
- Ceramic disk cartridge
- Dual spray feature
- 2-1/4" Max deck thickness
- Installation in a 1-2/8" hole
- 2.2 GPM flow rate



Part #	Mfg #	Description	Handle(s)	Finish	Price
223603	442023	1-Hole, Pull-Down Spray, 2.2 GPM	Lever	Stainless/Anthracite	
226948	442027	1-Hole, Pull-Down Spray, 2.2 GPM	Lever	Stainless/Truffle	

Blanco Culina™ 1-Hdl Pull-Down Kitchen Faucet

- 8-5/8" Reach, 21-1/2" height
- 360° Swivel spout, 7-1/4" spout height
- Flexible steel spring spout
- Ceramic disc cartridge
- Dual spray feature
- Quick release magnetic hand spray
- 2" Max deck thickness
- Installation in a 1-3/8" hole



Part #	Mfg #	Description	Handle(s)	Finish	Price
154207	441407	1-Hole, Pull-Down Spray, 1.8 GPM	Lever	Satin Nickel	
166181	441331	1-Hole, Pull-Down Spray, 2.2 GPM	Lever	Chrome	
148052	441332	1-Hole, Pull-Down Spray, 2.2 GPM	Lever	Satin Nickel	

Kitchen Faucets

Faucets & Valves

Blanco Culina™ Mini 1-Hdl Pull-Down Kitchen Faucet

- 7-7/8" Reach, 17-1/8" height
- Ceramic disc cartridge
- Installation in a 1-3/8" hole
- 2.2 GPM flow rate
- Solid brass construction



Part #	Mfg #	Description	Handle(s)	Finish	Price
172246	441622	1-Hole, Pull-Down Spray, Lead Free	Lever	Chrome	
224665	441623	1-Hole, Pull-Down Spray, Lead Free	Lever	Satin Nickel	
189613	441624	1-Hole, Pull-Down Spray, Lead Free 1.8GPM	Lever	Chrome	

Blanco Meridian™ Semi Professional 1-Hdl Pull-Down Kitchen Faucet

- 8-3/8" Reach, 19-1/4" height
- 360° Swivel spout
- Ceramic disc cartridge
- 3-1/2" Maximum deck thickness
- Installation in a 1-3/8" hole



Part #	Mfg #	Description	Handle(s)	Finish	Price
169561	441409	1-Hole, Pull-Down Spray, 1.8 GPM	Lever	Chrome	
144538	440558	1-Hole, Pull-Down Spray, 2.2 GPM	Lever	Chrome	
148480	440557	1-Hole, Pull-Down Spray, 2.2 GPM	Lever	Satin Nickel	

Blanco Grace II™ 1-Hdl Pull-Down Kitchen Faucet

- 8-1/2" Reach, 16-1/8" height
- 360° Swivel spout
- Ceramic disc cartridge
- Installation in a 1-3/8" hole
- 2.2 GPM flow rate
- 2-1/2" Maximum deck thickness



Part #	Mfg #	Description	Handle(s)	Finish	Price
165450	441495	1-Hole, Pull-Down Spray, Lead Free	Lever	Satin Nickel	

Kitchen Faucets

Blanco Napa™ 1-Hdl Pull-Down Kitchen Faucet

- 9-1/4" Reach, 9-3/8" height
- 180° Swivel spout
- Ceramic disc cartridge
- 2-1/4" Maximum deck thickness
- Installation in a 1-3/8" hole



Part #	Mfg #	Description	Handle(s)	Finish	Price
189530	441507	1-Hole, Pull-Down Spray, Lead Free	Lever	Stainless	

Blanco Sonoma™ 1-Hdl Pull-Down Kitchen Fau

- 8-1/2" Reach, 15-1/2" height
- 180° Swivel spout
- Dual spray feature on hand spray
- Ceramic disc cartridge
- Installation in a 1-3/8" hole
- 1.8 GPM flow rate



Part #	Mfg #	Description	Handle(s)	Finish	Price
187221	441649	1-Hole, Pull-Down Spray, Lead Free	Lever	Stainless	

Pull-Out Spray Kitchen Faucets

Blanco Acclaim™ 1-Hdl Pull-Out Kitchen Faucet

- 7-1/2" reach, 12-3/4" height
- 120° Swivel spout
- Ceramic disk cartridge
- 1-3/4" Maximum deck thickness
- Installation in a 1-3/8" hole
- 2.2 GPM flow rate



Part #	Mfg #	Description	Handle(s)	Finish	Price
136215	440518	1-Hole, Pull-Out Spray, Lead Free	lever	Cafe Brown	

Blanco Aires II™ 1-Hdl Pull-Out Kitchen Faucet

- 8-1/2" Reach, 8" height
- 120° Swivel spout
- Ceramic disc cartridge
- 2-1/2" Maximum deck thickness
- Installation in a 1-3/8" hole
- 2.2 GPM flow rate



Part #	Mfg #	Description	Handle(s)	Finish	Price
158562	441182	1-Hole, Pull-Out Spray, Lead Free	Lever	Satin Nickel	

Faucets & Valves

Kitchen Faucets

Faucets & Valves

Blanco Alta Compact™ Pull-Out Kitchen Faucet

- 8" Reach, 6" height
- 130° Swivel spout
- Ceramic disk cartridge
- Extendable dual pull-out spray
- 1-3/4" Maximum deck thickness
- Installation in a 1-3/8" hole
- 2.2 GPM flow rate



Part #	Mfg #	Description	Handle(s)	Finish	Price
183129	441484	1-Hole, Pull-Out Spray, Lead Free	Lever	Anthracite/Chrome	

Blanco Torino™ 1.8 GPM 1-Hdl Pull-Out Kitchen Faucet

- 7-3/4" Reach, 8-1/2" height
- 120° Swivel spout, 6-7/8" spout height
- Extra long supply lines
- Ceramic disc cartridge
- 1-1/2" Max deck thickness
- Installation in a 1-3/8" hole
- 1.8 gpm flow rate



Part #	Mfg #	Description	Handle(s)	Finish	Price
155984	441410	1-Hole, Pull-Out Spray, Lead Free	Lever	Chrome	

Blanco Torino™ 1-Hdl Pull-Out Kitchen Faucet

- 7-3/4" Reach, 8-1/2" height
- 120° Swivel spout, 6-7/8" spout height
- Extra long supply lines
- Ceramic disc cartridge
- 1-1/2" Max deck thickness
- Installation in a 1-3/8" hole
- 2.2 gpm flow rate



Part #	Mfg #	Description	Handle(s)	Finish	Price
150875	441208	1-Hole, Pull-Out Spray, Lead Free	Lever	Anthracite	

Blanco Torino, JR™ 1-Hdl Pull-Out Kitchen Faucet

- 7-3/4" Reach, 6-1/8" height
- 120° Swivel spout, 4-5/8" spout height
- Extra long supply lines
- Ceramic disc cartridge
- 2" Max deck thickness
- Installation in a 1-3/8" hole
- 2.2 gpm flow rate



Part #	Mfg #	Description	Handle(s)	Finish	Price
147726	440520	1-Hole, Pull-Out Spray, Lead Free	Lever	Chrome	
154787	441209	1-Hole, Pull-Out Spray, Lead Free	Lever	Biscotti	
149533	441210	1-Hole, Pull-Out Spray, Lead Free	Lever	Anthracite	

Kitchen Faucets

Blanco Linus™ 1-Hdl Pull-Out Kitchen Faucet

- 8-1/2" Reach, 11" height
- 140° Swivel spout, 9-3/4" spout height
- Ceramic disc cartridge
- 1-3/4" Max deck thickness
- Installation in a 1-3/8" hole
- Lead free



Part #	Mfg #	Description	Handle(s)	Finish	Price
182721	441403	1-Hole, Pull-Out Dual Spray, 2.2 GPM	Lever	Chrome	
161084	441404	1-Hole, Pull-Out Dual Spray, 2.2 GPM	Lever	Satin Nickel	
162025	441198	1-Hole, Pull-Out Stream Only, 2.2 GPM	Lever	Cafe Brown	
132055	441199	1-Hole, Pull-Out Stream Only, 2.2 GPM	Lever	Anthracite	
178473	441431	1-Hole, Pull-Out Dual Spray, 1.8 GPM	Lever	Satin Nickel	

Blanco Hiland™ 1-Hdl Pull-Out Kitchen Faucet

- 9-1/2" Reach, 11-3/4" height
- 180° Swivel spout
- Ceramic disc cartridge
- 2-1/4" Max deck thickness
- Installation in a 1-3/8" hole
- 2.2 GPM flow rate



Part #	Mfg #	Description	Handle(s)	Finish	Price
173647	441503	1-Hole, Pull-Out Spray, Lead Free	Lever	Stainless Steel	

Single-Handle Kitchen Faucets

Blanco Purus I™ 1-Hdl with Metal Side Spray Kitchen Faucet

- 10" Reach, 12-3/8" height
- 360° Swivel spout
- Ceramic disc cartridge
- Installation in a 1-3/8" hole
- 2.2 GPM flow rate
- 1-7/8" Maximum deck thickness



Part #	Mfg #	Description	Handle(s)	Finish	Price
156816	440602	2-Hole, with Side Spray, Lead Free	Lever	Anthracite & Chrome	
161618	441330	2-Hole, with Side Spray, Lead Free	Lever	Truffle & Chrome	
149524	441206	2-Hole, with Side Spray, Lead Free	Lever	Biscotti & Chrome	

Kitchen Faucets

Faucets & Valves

Blanco Meridian™ 1-Hdl with Side Spray Kitchen Faucet

- 9" Reach, 13-3/4" height
- 360° Swivel spout
- Ceramic disc cartridge
- Installation in a 1-3/8" hole
- 2.2 GPM flow rate
- 1-3/4" Maximum deck thickness



Part #	Mfg #	Description	Handle(s)	Finish	Price
165840	440008	2-Hole, with Side Spray, Lead Free	Lever	Satin Nickel	

Blanco Grace™ 1-Hdl with Side Spray Kitchen Faucet

- 9" Reach, 12" height
- 360° Swivel spout
- Ceramic disc cartridge
- Installation in a 1-3/8" hole
- 2.2 GPM flow rate
- 2-1/8" Maximum deck thickness



Part #	Mfg #	Description	Handle(s)	Finish	Price
168220	440685	2-Hole, with Side Spray, Lead Free	Lever	Satin Nickel	
151607	441189	2-Hole, with Side Spray, Lead Free	Lever	Cafe Brown	

Soap Dispensers

Soap Dispensers

Alta™ Soap Dispenser

- Solid brass construction
- Reservoir approximately 15 oz.
- Installation cutout hole size 1-3/8"



Part #	Mfg #	Description	Overall Size	Price
168089	440046	Chrome	3-3/4" H x 4-1/2" W	
174403	440047	Satin Nickel	3-3/4"H x 4-1/2"W	

Meridian Soap Dispenser

- Solid brass construction
- Reservoir approximately 12 oz.
- Installation cutout hole size 1-3/8"



Part #	Mfg #	Description	Overall Size	Price
160904	440058	Satin Nickel	3-1/4" H x 3-15/16" W	
189612	440059	Chrome	3-1/4" H x 3-15/16" W	

Milano™ Soap Dispenser

- Solid brass construction
- Reservoir approximately 15 oz.
- Installation cutout hole size 1-3/8"



Part #	Mfg #	Description	Overall Size	Price
177774	441230	Biscotti	3-3/4"H x 3" W	

Sonoma™ Soap Dispenser

- Solid brass construction
- Reservoir approximately 12 oz
- Installation cutout hole size 1-3/8"



Part #	Mfg #	Description	Overall Size	Price
182726	441757	Chrome	1-3/4"H x 2.5"W	
185937	441758	Stainless Steel	1-3/4"H x 2.5"W	



Kitchen Faucets & Accessories

Single-Handle Kitchen Faucets

Maxwell 1-Hdl Kitchen Faucet

- 8" Elliptical spout
- Ceramic disc cartridge with temperature limit stops
- Brass and copper waterways
- Limited lifetime warranty



40-122

Part #	Mfg #	Description	Handle(s)	Finish	Price
132123	40-110	8"cc	ADA Solid Lever	Chrome	
129479	40-112	8"cc, with Spray	ADA Solid Lever	Chrome	

Faucets & Valves

*Physical Vapor Deposition (PVD) Limited Lifetime Finish

www.waterconcepts.net • Serving our Customers Since 1946 • www.plumbsupply.com

Kitchen Faucets & Accessories

Pull-Down Kitchen Faucets

Avado® Pull-Down Semi-professional Kitchen Faucet

- 8-1/4" Reach, 21-1/8" high spout
- Brass material
- 2-Function spray
- Ceramic disc valves
- 255° Spout rotation
- 3/8" Compression hose assembly
- Stainless steel braided hand spray hose
- 2-1/2" Maximum countertop thickness
- 11-5/8" Deck clearance
- Low flow models:
—(LKLFAV2031CR)
- Flow rate: 1.75 gpm or 1.5 gpm for low flow models



Faucets & Valves

Part #	Mfg #	Description	Handle(s)	Finish	Price
144407	LKAV2031NK	1-Hole, Pull-Down Spray	ADA Lever	Brushed Nickel	
174220	LKFAV2031CR	1-Hole, Pull-Down Spray	ADA Lever	Chrome	

Avado® Pull-Down Kitchen Faucet

- 7-7/8" Reach, 18-7/8" high spout
- Brass material
- 2-Function spray
- Ceramic disc valves
- 360° Spout rotation
- 3/8" Compression hose assembly
- Stainless steel braided hand spray hose
- 2-1/2" Maximum countertop thickness
- 11-1/4" Deck clearance
- Flow rate: 1.75 gpm



Part #	Mfg #	Description	Handle(s)	Finish	Price
186384	LKAV1031NK	1-Hole, Pull-Down Spray	ADA Lever	Brushed Nickel	

Kitchen Faucets & Accessories

Faucets & Valves

Avado® Semi-Professional Pull-Down Kitchen Faucet

- 8-1/2" Reach, 24-1/4" high spout
- Brass material
- 3-Function spray:
 - Aerated
 - Spray
 - Pause
- Ceramic disc valves
- 360° Spout rotation
- Stainless steel coil hand spray hose
- 2-1/2 Maximum countertop thickness
- 8-1/2" Deck clearance
- Flow rate: 1.5 gpm (2.2 gpm flow regular included with faucet)



Part #	Mfg #	Description	Handle(s)	Finish	Price
146080	LKAV4061CR	1-Hole, Pull-Down Spray	ADA Lever	Chrome	
148288	LKAV4061LS	1-Hole, Pull-Down Spray	ADA Lever	Lustrous Steel	

Everyday Quick-Connect Pull-Down Spray Kitchen Faucet

- 9" Reach, 15-3/4" high spout
- Solid brass waterway construction
- 3-Function spray:
 - Aerated
 - Spray
 - Pause
- Forward only handle
- 360° Spout rotation
- 3/8" Female compression hose assembly
- 7-3/8" Deck clearance
- 2-1/2" Maximum countertop thickness
- Ceramic disc valve
- Flow rate: 1.5 gpm installed with 2.2 gpm regulator included



Part #	Mfg #	Description	Handle(s)	Finish	Price
187687	LK6000LS	1-Hole, Quick-Connect Pull-Down Spray	ADA Lever	Lustrous Steel	

Explore™ Pull-Down Bridge Kitchen Faucet

- 9-1/4" Reach, 17-1/8" high spout
- 3-Function spray:
 - Aerated
 - Spray
 - Pause
- 360° Spout rotation
- 1/2"-14 NPSM
- 8-5/8" Deck clearance
- Ceramic disc valves
- Flow rate: 1.5 gpm



Part #	Mfg #	Description	Handle(s)	Finish	Price
185489	LKEC2037AS	3-Hole, Pull-Down Spray	ADA Lever	Antique Steel	
172971	LKEC2037CR	3-Hole, Pull-Down Spray	ADA Lever	Chrome	

Kitchen Faucets & Accessories

Pull-Down Kitchen Faucets (Continued)

Explore™ Pull-Down Bridge Kitchen Faucet

Part #	Mfg #	Description	Handle(s)	Finish	Price
169805	LKEC2037LS	3-Hole, Pull-Down Spray	ADA Lever	Lustrous Steel	

Explore™ Pull-Down Spray Kitchen Faucet

- 9-1/4" Reach, 17-7/8" high spout
- Solid brass waterway construction
- 3-Function spray:
 - Aerated
 - Spray
 - Pause
- Forward only handle
- 360° Spout rotation
- 1/2"-14 NPSM
- Ceramic disc valve
- 2-1/2" Countertop thickness
- 9-1/2" Deck clearance



Part #	Mfg #	Description	Handle(s)	Finish	Price
180841	LKEC2031AS	1-Hole, Pull-Down Spray	ADA Lever	Antique Steel	
181148	LKEC2031LS	1-Hole, Pull-Down Spray	ADA Lever	Lustrous Steel	

Gourmet® Pull-Down Kitchen Faucet

- 9-3/8" Reach, 16" high spout
- 3-Function spray:
 - Aerated
 - Spray
 - Pause
- 360° Spout rotation
- 1/2"-14 NPSM
- 8-5/8" Deck clearance
- Ceramic disc valves
- 2-1/2" Max countertop thickness
- Flow rate: 1.5 gpm (2.2 gpm flow rate included with faucet)



Part #	Mfg #	Description	Handle(s)	Finish	Price
148957	LKGT3031	1-Hole, Pull-Down Spray	ADA Lever	Lustrous Steel	

Kitchen Faucets & Accessories

Faucets & Valves

Harmony™ Pull-Down Spray Kitchen Faucet

- 8-11/16" Reach, 15-3/8" high spout
- 8-11/16" Reach, 16-1/4" high spout **(LKHA1031NK Model only)**
- Solid brass construction
- Two function spray
- Stainless steel braided hand spray hose
- 170° Spout rotation
- 3/8" Female compression hose assembly
- 7-1/4" Deck clearance
- 8-1/8" Deck clearance **(LKHA1031NK Model only)**
- Ceramic disc valve
- 2-1/2" Max countertop thickness
- Flow rate: 1.75 gpm



Part #	Mfg #	Description	Handle(s)	Finish	Price
156082	LKHA1031NK	1-Hole, Pull-Down Spray	ADA Lever	Brushed Nickel	
176959	LKHA2031NK	1-Hole, Pull-Down Spray	ADA Lever	Brushed Nickel	

Pull-Out Spray Kitchen Faucets

Avado® 1-Hdl Pull-Out Two Function Spray Kitchen Faucet

- 9-1/8" Reach, 11-7/8" spout height
- Solid brass construction
- 3/8" Female compression hose assembly
- Ceramic disc valve
- 9-7/8" Deck clearance
- Stainless steel braided hand spray hose
- 360° Spout rotation
- 2-1/2" Maximum countertop thickness
- Maximum flow rate: 1.75 gpm



Part #	Mfg #	Description	Handle(s)	Finish	Price
158464	LKAV3041NK	1-Hole, Pull-Out Spray	ADA Lever	Brushed Nickel	

Gourmet® 1-Hdl Pull-Out Spray Kitchen Faucet

- 10-1/8" Reach
- Solid brass construction
- Removable ceramic disc cartridge
- 110° Swing spout
- 5" Maximum countertop thickness (mid-rise)
- 2-1/2" Maximum countertop thickness (hi-rise)
- Flexible hose with 3/8" compression
- Maximum flow rate: 1.75 gpm @ 60 psi
- Low flow rate: 1.5 gpm @ 60 psi
- **LKLFGT** models have low flow



Part #	Mfg #	Description	Handle(s)	Finish	Price
172019	LKGT1041NK	1-Hole, Pull-Out Spray	ADA Lever	Brushed Nickel	

Kitchen Faucets & Accessories

Pull-Out Spray Kitchen Faucets (Continued)
Gourmet® 1-Hdl Pull-Out Spray Kitchen Faucet

Part #	Mfg #	Description	Handle(s)	Finish	Price
155037	LKLFGT1041CR	1-Hole, Pull-Out Spray	ADA Lever	Chrome	

Kitchen Faucets

Allure® 1-Hdl Kitchen Faucet

- 8" Reach, 13-3/4" spout height
- Stainless steel construction
- Ceramic disc valve
- 1/2" IPT
- 360° Spout rotation
- 2-1/2" Maximum countertop thickness
- 7-3/4" Deck clearance
- Maximum flow rate: 1.5 gpm



Faucets & Valves

Part #	Mfg #	Description	Handle(s)	Finish	Price
158462	LK7921SSS	1-Hole, No Spray Type	ADA lever	Satin Stnlss Steel	
152148	LK7922SSS	2-Hole, Side Spray	ADA Lever	Satin Stnlss Steel	

1-Hdl Everyday Kitchen Faucet

- 8" Reach, 6" Spout height
- Brass construction
- Ceramic disc valve
- 360° Swing spout
- 2-1/2" Maximum countertop thickness
- 4-7/8" Deck clearance
- 3/8" Female compression hose assembly
- Maximum flow rate: 1.5 gpm



Part #	Mfg #	Description	Handle(s)	Finish	Price
142798	LK1500CR	1-Hole, No Spray Type	ADA Lever	Chrome	
177162	LK1501CR	1-Hole, Side Spray	ADA Lever	Chrome	

1-Hdl Everyday Kitchen Faucet with Escutcheon and Side Spray

- 8" Reach, 6" Spout height
- Brass construction
- Ceramic disc valve
- 360° Swing spout
- 2-1/2" Maximum countertop thickness
- 5" Deck clearance
- 3/8" Female compression hose assembly
- Maximum flow rate: 1.5 gpm



Part #	Mfg #	Description	Handle(s)	Finish	Price
185692	LK1001CR	1-Hole, Side Spray	ADA Lever	Chrome	

Kitchen Faucets & Accessories

Faucets & Valves

Remote Handle Everyday Kitchen Faucet with Side Spray

- 8" Reach, 11-1/2" Spout height
- Brass construction
- Ceramic disc valve
- 360° Swing spout
- 2-1/2" Maximum countertop thickness
- 10-3/8" Deck clearance
- 3/8" Female compression hose assembly
- Maximum flow rate: 1.5 gpm



Part #	Mfg #	Description	Handle(s)	Finish	Price
186030	LK3001CR	3-Hole, Side Spray	ADA Lever	Chrome	

2-Hdl Everyday Bar Faucet

- 3-9/16" Reach, 11-11/16" spout height
- Brass construction
- Ceramic disc valve
- 3/8" Compression hose assembly
- 360° Swing spout
- 9" Maximum deck clearance
- Maximum flow rate 1.5 gpm



Part #	Mfg #	Description	Handle(s)	Finish	Price
172754	LK2477CR	2-Hole, No Spray Type	ADA Lever	Chrome	

Utility Kitchen Faucets

Pursuit™ 1-Hdl Flexible Spout 2-Function Spray Utility Faucet

- 8-3/8" Reach, 14-3/8" Spout height
- Solid brass waterway construction
- Ceramic disc valve
- 360° Swing spout
- 2-1/2" Maximum countertop thickness
- 7-3/8" Deck clearance
- Forward only lever handle
- 3/8" Femal compression hose assembly
- Maximum flow rate: 1.5 gpm



Part #	Mfg #	Description	Handle(s)	Finish	Price
175964	LK2500CR	1-Hole, No Spray Type	ADA Lever	Chrome	

Kitchen Faucets & Accessories

Pot Fillers

Avado® Wall-Mount Pot Filler

- Brass construction
- Articulating spout with 360° rotation, 24" extended reach
- Ceramic disc valves
- 1/2" NPT female
- Flow rate: 4 gpm



Part #	Mfg #	Description	Handle(s)	Finish	Price
167038	LKAV4091CR	1-Hole, Wall-Mount	ADA Lever	Chrome	

Faucet Accessories

Avado™ Soap/Lotion Dispenser

- 3-1/2" Spout reach, 3-1/2" height
- Brass construction



Part #	Mfg #	Description	Handle(s)	Finish	Price
163756	LK325LS	1-Hole		Lustrous Steel	

Explore™ Soap/Lotion Dispenser

- 3-1/2" Spout reach, 4-1/2" height
- Brass construction



Part #	Mfg #	Description	Handle(s)	Finish	Price
185490	LK330AS	1-Hole		Antique Steel	
173659	LK330CR	1-Hole		Chrome	
182196	LK330LS	1-Hole		Lustrous Steel	

Gourmet® Harmony™ Soap/Lotion Dispenser

- 3-1/2" Spout reach, 4-3/8" height
- Brass construction



Part #	Mfg #	Description	Handle(s)	Finish	Price
188721	LKGT1054NK	1-Hole		Brushed Nickel	

Kitchen Faucets & Accessories

Single-Handle Kitchen Faucets

P4B Builder Series 1-Hdl Pull-Out Kitchen Fa

- Ceramic cartridge
- Optional deckplate included
- Max flow rate: 2.2 gpm @ 60 psi



Part #	Mfg #	Description	Handle(s)	Finish	Price
141370	P4B-150C	8"cc 1- or 3-Hole, Pull-Out Spray	ADA Metal Lever	Chrome	
141371	P4B-150SS	8"cc 1- or 3-Hole, Pull Out Spray	ADA Metal Lever	Stainless	

P4B Builder Series 1-Hdl Kitchen Faucet

- Ceramic cartridge
- Optional deckplate included
- Max flow rate: 1.5 gpm @ 60 psi



Part #	Mfg #	Description	Handle(s)	Finish	Price
234721	P4B-140C	2- or 4-Hole, Matching Side Spray	ADA Metal Lever	Chrome	
234723	P4B-140SS	2- or 4-Hole, Matching Side Spray	ADA Metal Lever	Stainless	

P4B Builder Series 1-Hdl Pull-Down Kitchen Faucet

- Ceramic cartridge
- Quick connect feature
- Optional deckplate included
- Max flow rate: 1.8 gpm @ 60 psi



Part #	Mfg #	Description	Handle(s)	Finish	Price
234724	P4B-151C	1- or 3-Hole, Pull-Down Spray	ADA Metal Lever	Chrome	
173989	P4B-151SS	1- or 3-Hole, Pull-Down Spray	ADA Metal Lever	Stainless	

P4C Classic Series 1-Hdl Kitchen Faucet

- Stainless steel ball valve
- Max flow rate: 2.2 gpm @ 60 psi



Part #	Mfg #	Description	Handle(s)	Finish	Price
141386	P4C-100C	8"cc 1- or 3-Hole, less Side Spray	ADA Metal Lever	Chrome	
158742	P4C-100SS	8"cc 1 or 3-Hole, less Side Spray	ADA Metal Lever	Stainless	
141387	P4C-140C	8"cc 4-Hole, Matching Side Spray	ADA Metal Lever	Chrome	
158744	P4C-140SS	8"cc 4-Hole, Matching Side Spray	ADA Metal Lever	Stainless	

Kitchen Faucets & Accessories

P4C Classic Series 1-Hdl Pull-Out Kitchen Faucet

- Ceramic cartridge
- Optional deckplate included
- Max flow rate: 1.5 gpm



Part #	Mfg #	Description	Handle(s)	Finish	Price
143140	P4C-150C	1- or 3-Hole, Pull-Out Spray	ADA Metal Lever	Chrome	
147875	P4C-150SS	1- or 3-Hole, Pull-Out Spray	ADA Metal Lever	Stainless	

P4H Series 1-Hdl Kitchen Faucet

- Ceramic cartridge
- Optional deckplate included
- With side spray
- Max flow rate: 1.5 gpm @ 60 psi



Part #	Mfg #	Description	Handle(s)	Finish	Price
235480	P4H-140C	2- or 4-Hole, Matching Side Spray	ADA Metal Lever	Chrome	
235481	P4H-140SS	2- or 4-Hole, Matching Side Spray	ADA Metal Lever	Stainless	

P4H Series 1-Hdl Pull-Down Kitchen Faucet

- Ceramic cartridge
- Optional deckplate included
- Max flow rate: 1.8 gpm @ 60 psi



Part #	Mfg #	Description	Handle(s)	Finish	Price
235456	P4H-150C	1- or 3-Hole, Pull-Down Spray	ADA Metal Lever	Chrome	
235457	P4H-150SS	1- or 3-Hole, Pull-Down Spray	ADA Metal Lever	Stainless	

Two-Handle Kitchen Faucets

P4B Builder Series 2-Hdl Kitchen Faucet

- Ceramic cartridges
- Max flow rate: 2.2 gpm @ 60 psi



Part #	Mfg #	Description	Handle(s)	Finish	Price
141372	P4B-200C	8"cc 4-Hole, less Side Spray	ADA Metal Lever	Chrome	
141373	P4B-240C	8"cc 4-Hole, Matching Side Spray	ADA Metal Lever	Chrome	

Kitchen Faucets & Accessories

Faucets & Valves

P4B Builder Series 2-Hdl with Goose Neck Spout

- Metal lever handles
- Ceramic cartridges
- Goose neck spout
- Less spray



Part #	Mfg #	Description	Handle(s)	Finish	Price
143545	P4B-260C	8"cc 4-Hole, Matching Side Spray	ADA Metal Lever	Chrome	
158740	P4B-250SS	8"cc 3-Hole, less Side Spray	ADA Metal Lever	Stainless	

P4C Classic Series 2-Hdl Kitchen Faucet

- Washerless cartridges
- Max flow rate: 2.2 gpm @ 60 psi



Part #	Mfg #	Description	Handle(s)	Finish	Price
141389	P4C-200C	8"cc 3-Hole, less Side Spray	Metal Wing	Chrome	

P4C Classic Series 2-Hdl Kitchen Faucet

- Acrylic round handles
- Washerless cartridges
- Max flow rate: 1.5 gpm



Part #	Mfg #	Description	Handle(s)	Finish	Price
235466	P4V-242C	4-Hole, Black Side Spray	Acrylic Round	Chrome	

P4V Value Series 2-Hdl Kitchen Faucet

- Washerless cartridges
- Acrylic round handles
- Max flow rate: 1.5 gpm @ 60 psi



Part #	Mfg #	Description	Handle(s)	Finish	Price
148250	P4V-202C	8"cc 3-Hole, less Side Spray	Acrylic Round	Chrome	

Kitchen Faucets & Accessories



Kitchen Faucets

E400 Single-Handle Kitchen Faucet

- *Washerless cartridge*



Part #	Mfg#	Description	Handle(s)	Finish	Price
124490	E401M	8"cc, Side Spray	Metal Loop Handle	Polished Chrome	

Faucets & Valves

Kitchen Faucets & Accessories



Single-Handle Kitchen Faucets

Classic 1-Hdl Kitchen Faucet

- Washerless cartridge
- Brass waterway
- 1/2" NPT Hookup



Part #	Mfg #	Description	Handle(s)	Finish	Price
089227	FT-200	8"cc less Hose & Spray	ADA Lever	Chrome	

Faucets & Valves

Lavatory - Single Hole

Single-Handle Lavatory Faucets

Alteo® 1-Hdl Lavatory Faucet with Pop-up Drain

- 5" Reach, 7-7/8" high spout
- Metal construction
- One-piece, self-contained ceramic disc valve
- Includes 6-1/4" escutcheon plate for three-hole sinks
- WaterSense® certified product: 1.5 gpm



Part #	Mfg #	Description	Handle(s)	Finish	Price
165726	K-45800-4-BN	1- or 3-Hole, Pop-Up Drain	ADA Lever	*Brushed Nickel	
165561	K-45800-4-CP	1- or 3-Hole, Pop-Up Drain	ADA Lever	Polished Chrome	
167966	K-458004-2BZ	1- or 3-Hole, Pop-Up Drain	ADA Lever	Oil-Rubbed Bronze	

Artifacts® 1-Hdl Lavatory Faucet with Pop-Up Drain and 1-1/4" Tailpiece

- 5-11/16" Reach, 6-15/16" high spout
- Flexible supplies
- Laminar flow
- WaterSense® certified product: 1.5 gpm



Part #	Mfg #	Description	Handle(s)	Finish	Price
162837	K-72762-9M-BN	1 Hole, Pop-Up Drain	ADA Lever	*Brushed Nickel	
176272	K-72762-9M-CP	1 Hole, Pop-Up Drain	ADA Lever	Polished Chrome	
174457	K-72762-9M-SN	1 Hole, Pop-Up Drain	ADA Lever	*Polished Nickel	
189857	K-72762-9M-VNT	1 Hole, Pop-Up Drain	ADA Lever	Vintage Nickel	
171402	K-72762-9M-2BZ	1 Hole, Pop-Up Drain	ADA Lever	Oil-Rubbed Bronze	

Composed® 1-Hdl Lavatory Faucet with Pop-Up Drain and 1-1/4" Tailpiece

- 5-15/16" Reach, 4-3/4" high spout
- WaterSense® certified product: 1.2 gpm



Part #	Mfg #	Description	Handle(s)	Finish	Price
229526	K-73167-4-CP	1 Hole, Pop-Up Drain	ADA Lever	Chrome	

Devonshire® 1-Hdl Lavatory Faucet with Pop-Up Drain and 1-1/4" Tailpiece

- 4-7/8" Reach, 8-13/16" high spout
- Flexible supplies
- 6" Escutcheon plate includes for 3-hole installation
- WaterSense® certified product



Part #	Mfg #	Description	Handle(s)	Finish	Price
170296	K-193-4-CP	1- or 3-Hole, Pop-Up Drain	ADA Lever	Polished Chrome	

* Vibrant Limited Lifetime Warranty

www.plumbsupply.com • Serving our Customers Since 1946 • www.waterconcepts.net

Lavatory - Single Hole

Single-Handle Lavatory Faucets (Continued)

Devonshire® 1-Hdl Lavatory Faucet with Pop-Up Drain and 1-1/4" Tailpiece

Part #	Mfg #	Description	Handle(s)	Finish	Price
169497	K-193-4-BN	1- or 3-Hole, Pop-Up Drain	ADA Lever	*Brushed Nickel	
171979	K-193-4-BV	1- or 3-Hole, Pop-Up Drain	ADA Lever	*Brushed Bronze	
171971	K-193-4-PB	1- or 3-Hole, Pop-Up Drain	ADA Lever	*Polished Brass	
172074	K-193-4-SN	1- or 3-Hole, Pop-Up Drain	ADA Lever	*Polished Nickel	
170292	K-193-4-2BZ	1- or 3-Hole, Pop-Up Drain	ADA Lever	Oil-Rubbed Bronze	

Fairfax® 1-Hdl Lavatory Faucet with Pop-Up Metal Drain, 1-1/4" Tailpiece, and Aerator

- 5" Reach spout
- Solid metal construction
- Washerless ceramic valving, flexible supplies
- 6" Escutcheon plate included with **K-12181** models
- Maximum flow rate: 1.2 gpm



K12181-CP



K12182-CP



Part #	Mfg #	Description	Handle(s)	Finish	Price
053609	K-12181-CP	4"cc, 6" Escutcheon Plate, Metal Drain	ADA Lever	Polished Chrome	
059787	K-12181-BN	4"cc, 6" Escutcheon Plate, Metal Drain	ADA Lever	*Brushed Nickel	
153198	K-12181-2BZ	4"cc, 6" Escutcheon Plate, Metal Drain	ADA Lever	Oil-Rubbed Bronze	
053614	K-12182-CP	1-Hole, Metal Drain	ADA Lever	Polished Chrome	
056232	K-12182-BN	1-Hole, Metal Drain	ADA Lever	*Brushed Nickel	
154864	K-12182-2BZ	1-Hole, Metal Drain	ADA Lever	Oil-Rubbed Bronze	

Forté® Lavatory Faucet with Metal Pop-Up Drain, 1-1/4" Tailpiece, and Sculpted Lever Handle

- 5-1/8" Reach spout
- Solid brass construction
- One-piece ceramic valve
- Temperature memory
- High-temperature limit setting
- (**K-10216-4-CP**) includes plastic pop-up drain
- Maximum flow rate: 1.5 gpm



Part #	Mfg #	Description	Handle(s)	Finish	Price
096961	K-10215-4-CP	1-Hole, Metal Pop-Up Drain with 1-1/4" Tailpiece	ADA Sculpted Lever	Polished Chrome	
095489	K-10215-4-BN	1-Hole, Metal Pop-Up Drain with 1-1/4" Tailpiece	ADA Sculpted Lever	*Brushed Nickel	
104046	K102154G	1-Hole, Metal Pop-Up Drain with 1-1/4" Tailpiece	ADA Sculpted Lever	*Brushed Chrome	
189998	K-10216-4-CP	1-Hole, Plastic Pop-Up Drain with 1-1/4" Tailpiece	ADA Sculpted Lever	Polished Chrome	

* Vibrant Limited Lifetime Warranty

www.waterconcepts.net • Serving our Customers Since 1946 • www.plumbsupply.com

Lavatory - Single Hole

Honesty™ 1-Hdl Lavatory Faucet with Pop-Up Drain

- 5-11/16" Reach, 4-3/4" high spout
- Brass construction
- One-piece, self-contained ceramic disc valve
- Flexible supplies
- WaterSense® certified product: 1.5 gpm



Part #	Mfg #	Description	Handle(s)	Finish	Price
177286	K-99760-4-CP	1-Hole, Pop-Up Drain	ADA Lever	Polished Chrome	

July™ 1-Hdl Lavatory Faucet with Pop-Up Drain

- 4-3/8" Reach, 4-13/16" high spout
- Brass construction
- Ceramic disc valve
- Escutcheon included with model **(K-98146-4-CP)**
- WaterSense® certified product: 1.5 gpm



Part #	Mfg #	Description	Handle(s)	Finish	Price
165844	K-16027-4-CP	1-Hole, Pop-Up Drain	ADA Lever	Polished Chrome	
170448	K-16027-4-G	1-Hole, Pop-Up Drain	ADA Lever	Brushed Chrome	
166688	K-98146-4-CP	1- or 3-Hole with Escutcheon, Pop-Up Drain	ADA Lever	Polished Chrome	

Margaux® Lavatory Faucet with Joystick Handle—Touch-Activated Drain with Tailpiece and Overflow

- 5-3/8" Spout reach
- Brass construction
- Ceramic disc valve
- WaterSense® certified product 1.5 gpm



Part #	Mfg #	Description	Handle(s)	Finish	Price
155283	K-16230-4-AF	1-Hole, Touch-Activated Drain with Overflow	ADA Joystick	*French Gold	
106169	K-16230-4-BN	1-Hole, Touch-Activated Drain with Overflow	ADA Joystick	*Brushed Nickel	
186601	K-16230-4-BV	1-Hole, Touch-Activated Drain with Overflow	ADA Joystick	*Brushed Bronze	
109272	K-16230-4-CP	1-Hole, Touch-Activated Drain with Overflow	ADA Joystick	Polished Chrome	
183017	K-16230-4-SN	1-Hole, Touch-Activated Drain with Overflow	ADA Joystick	Polished Nickel	

* Vibrant Limited Lifetime Warranty

www.plumbsupply.com • Serving our Customers Since 1946 • www.waterconcepts.net

Lavatory - Single Hole

Faucets & Valves

Margaux® Tall Lavatory Faucet with Joystick Handle—Touch-Activated Drain with Tailpiece and Overflow

- 6-3/8" Spout reach
- Brass construction
- Ceramic disc joystick valve actuation
- Flexible connections
- WaterSense® certified: 1.2gpm



Part #	Mfg #	Description	Handle(s)	Finish	Price
226610	K-16231-4-AF	1-Hole, Touch-Activated Drain with Overflow	ADA Joystick	*French Gold	

Purist® Lavatory Faucet with Pop-Up Drain, Tailpiece, and Straight Lever Handle

- Solid brass construction
- 5-1/2" Spout reach
- Ceramic disc valve
- Temperature memory
- Low spout design
- WaterSense® certified product 1.5 gpm



Part #	Mfg #	Description	Handle(s)	Finish	Price
087293	K-14402-4A-CP	1-Hole, Low Spout Design	ADA Straight Lever	Polished Chrome	
083540	K-14402-4A-BN	1-Hole, Low Spout Design	ADA Straight Lever	*Brushed Nickel	
137209	K-14402-4A-BGD	1-Hole, Low Spout Design	ADA Straight Lever	*Moderne Brushed Gold	
100730	K-14402-4A-BV	1-Hole, Low Spout Design	ADA Straight Lever	*Brushed Bronze	
141119	K-14402-4A-SN	1-Hole, Low Spout Design	ADA Straight Lever	Polished Nickel	

Refinia® 1-Hdl Lavatory Faucet with Pop-Up Drain

- 4-1/2" Reach, 6-7/8" high spout
- Ceramic disc valve
- Optional escutcheon included for 1- or -hole installation
- WaterSense® certified product: 1.5 gpm



Part #	Mfg #	Description	Handle(s)	Finish	Price
166531	K-5313-4-BN	1- or 3-Hole, Pop-Up Drain	ADA Lever	*Brushed Nickel	
167293	K-5313-4-CP	1- or 3-Hole, Pop-Up Drain	ADA Lever	Pol Chrome	

* Vibrant Limited Lifetime Warranty

www.waterconcepts.net • Serving our Customers Since 1946 • www.plumbsupply.com

Lavatory - Single Hole

Stance® 1-Hdl Lavatory Faucet—Touch-Activated Drain with Tailpiece and Overflow

- Solid brass construction
- 6-3/8" Spout reach
- Ceramic disc valve
- Flexible connections
- 8-1/2" High spout for **K-14760** models or 13-7/16" tall high spout for **K-14761** models
- WaterSense® certified product 1.5 gpm



Part #	Mfg #	Description	Handle(s)	Finish	Price
134405	K-14760-4-BN	1-Hole, 8-1/2" High Spout	ADA Lever	*Brushed Nickel	
134877	K-14760-4-CP	1-Hole, 8-1/2" High Spout	ADA Lever	Polished Chrome	
134408	K-14761-4-BN	1-Hole, 13-7/16" High Spout	ADA Lever	*Brushed Nickel	
133741	K-14761-4-CP	1-Hole, 13-7/16" High Spout	ADA Lever	Polished Chrome	

Toobi™ Lavatory Faucet with Pop-Up Drain, Tailpiece, and Knob Handle

- 4" Spout reach
- Brass construction
- One-piece, self-contained ceramic disc valve
- Temperature memory
- Flexible connections
- Maximum flow rate: 1.5 gpm



Part #	Mfg #	Description	Handle(s)	Finish	Price
149686	K-8959-7-BN	1-Hole, Pop-Up Drain with Tailpiece	Knob	*Brushed Nickel	
148622	K-8959-7-CP	1-Hole, Pop-Up Drain with Tailpiece	Knob	Polished Chrome	

Two-Handle Lavatory Faucets

Bancroft™ Monoblock 2-Hdl Lavatory Faucet with Pop-Up Metal Drain, 1-1/4" Tailpiece, and 6" Escutcheon

- 4-7/8" Reach spout
- Metal construction
- Brass valve bodies
- Flexible connections
- Maximum flow rate: 1.5 gpm



K-10579-4



K-10579-4P



Metal Lever Handles

Part #	Mfg #	Description	Handle(s)	Finish	Price
153390	K-10579-4-2BZ	1-Hole or 4"cc, Metal Drain	ADA Metal Lever	Oil-Rubbed Bronze	
099751	K-10579-4-BN	1-Hole or 4"cc, Metal Drain	ADA Metal Lever	*Brushed Nickel	
101444	K-10579-4-BV	1-Hole or 4"cc, Metal Drain	ADA Metal Lever	*Brushed Bronze	
091753	K-10579-4-CP	1-Hole or 4"cc, Metal Drain	ADA Metal Lever	Polished Chrome	
096957	K-10579-4-SN	1-Hole or 4"cc, Metal Drain	ADA Metal Lever	*Polished Nickel	

* Vibrant Limited Lifetime Warranty

www.plumbsupply.com • Serving our Customers Since 1946 • www.waterconcepts.net

Lavatory - Single Hole

Ceramic Lever Handles

Part #	Mfg #	Description	Handle(s)	Finish	Price
098776	K-10579-4P-BN	1-Hole or 4"cc, Metal Drain	ADA Ceramic Lever	*Brushed Nickel	
182987	K-10579-4P-BV	1-Hole or 4"cc Metal Drain	ADA Ceramic Lever	*Brushed Bronze	
087741	K-10579-4P-CP	1-Hole or 4"cc Metal Drain	ADA Ceramic Lever	Polished Chrome	
098002	K-10579-4P-SN	1-Hole or 4"cc Metal Drain	ADA Ceramic Lever	*Polished Nickel	

Oblo® Lavatory Faucet with Pop-Up Drain, Lift Rod, Tailpiece, and 2 Oval Lever Handles

- 4-13/16" Spout reach
- Brass construction and valve bodies
- Flexible connections
- Maximum flow rate: 1.5 gpm



Part #	Mfg #	Description	Handle(s)	Finish	Price
136229	K-10085-9-BN	1-Hole, Pop-up Drain	Oval Lever	*Brushed Nickel	
154877	K-10085-9-CP	1-Hole, Pop-up Drain	Oval Lever	Polished Chrome	

Vessel Faucets

Composed™ 1-Hdl Vessel Faucet Including Pop-Up Drain with 1-1/4" Tailpiece

- Metal construction
- 7-1/8" Reach spout
- 8-3/4" Faucet height, 8" from deck to aerator
- WaterSense® certified: 1.2 gpm



Part #	Mfg #	Description	Handle(s)	Finish	Price
226560	K-73168-4-CP	1-Hole, Pop-up Drain	ADA Lever	Chrome	

Fairfax® 1-Hdl Vessel Faucet

- 5" Reach spout
- 11-15/16" Faucet height, 7-1/2" from deck to aerator
- Solid metal construction
- Washerless ceramic valving, flexible supplies
- Maximum flow rate: 1.2 gpm



Part #	Mfg #	Description	Handle(s)	Finish	Price
068895	K-12183-BN	1-Hole, less Drain & Lift Rod	ADA Lever	*Brushed Nickel	
063449	K-12183-CP	1-Hole, less Drain & Lift Rod	ADA Lever	Polished Chrome	
152682	K-12183-2BZ	1-Hole, less Drain & Lift Rod	ADA Lever	Oil Rubbed Bronze	

* Vibrant Limited Lifetime Warranty

www.waterconcepts.net • Serving our Customers Since 1946 • www.plumbsupply.com

Lavatory - Single Hole

Forté® Vessel Faucet with Touch-Activated Drain, Tailpiece, and 1 Sculpted Lever Handle

- Solid brass construction
- Without overflow
- 5-1/8" Reach spout
- 12-3/8" Faucet height, 7-7/8" from deck to aerator
- One-piece ceramic valve temperature memory
- High-temperature limit setting
- Maximum flow rate: 1.2 gpm



Part #	Mfg #	Description	Handle(s)	Finish	Price
095568	K-10217-4-BN	1-Hole, Tall, Touch-activated Drain with Tailpiece	ADA Sculpted Lever	*Brushed Nickel	
095598	K-10217-4-CP	1-Hole, Tall, Touch-activated Drain with Tailpiece	ADA Sculpted Lever	Polished Chrome	
103935	K-10217-4-G	1-Hole, Tall, Touch-activated Drain with Tailpiece	ADA Sculpted Lever	Brushed Chrome	

Purist® 1-Hdl Vessel Faucet with Touch Activated Drain, Tailpiece, and No Overflow

- 6-1/4" Reach
- 12" Faucet height, 6-1/2" from deck to aerator
- Solid brass construction
- Ceramic disc valve
- Temperature memory
- WaterSense® certified product 1.5 gpm



Part #	Mfg #	Description	Handle(s)	Finish	Price
132490	K-14404-4A-BGD	1-Hole	ADA Lever	*Moderne Brushed Gold	
087208	K-14404-4A-BN	1-Hole	ADA Lever	*Brushed Nickel	
129662	K-14404-4A-BV	1-Hole	ADA Lever	*Brushed Bronze	
085446	K-14404-4A-CP	1-Hole	ADA Lever	Polished Chrome	

Toobi™ Vessel Faucet with Touch Activated Drain, Tailpiece, Knob Handle, and No Overflow

- 4" Spout reach
- 11-5/16" Faucet height, 7-7/8" from deck to aerator
- Brass construction
- One-piece, self-contained ceramic disc valve
- Temperature memory
- Flexible connections
- Maximum flow rate: 1.5 gpm



Part #	Mfg #	Description	Handle(s)	Finish	Price
144913	K-8990-7-BN	1-Hole, Tall, Touch-Activated Drain with Tailpiece	Knob	*Brushed Nickel	
143744	K-8990-7-CP	1-Hole, Tall, Touch-Activated Drain with Tailpiece	Knob	Polished Chrome	

* Vibrant Limited Lifetime Warranty

www.plumbsupply.com • Serving our Customers Since 1946 • www.waterconcepts.net

Lavatory Faucets - Single Hole

Faucets & Valves

Single-Handle Lavatory Faucets

Addison™ 1-Hdl Lavatory Faucet

- 5-1/16" Reach
- 10-1/4" High spout, 5-3/4" from deck to aerator
- 3/8" Compression fittings
- Hot/cold indicator
- 2-1/2" Maximum deck thickness
- Includes optional 5-3/4" escutcheon
- 32" Minimum InnoFlex® supply lines below deck
- WaterSense® certified product, 1.2 gpm @ 60 psi
- Euro-motion DIAMOND™ valve



Part #	Mfg #	Description	Handle(s)	Finish	Price
132558	592-DST	1- or 3-Hole 4"cc, Metal Pop-Up Drain, LF	ADA Lever	Chrome	
137600	592-CZ-DST	1- or 3-Hole 4"cc, Metal Pop-Up Drain, LF	ADA Lever	Champagne Bronze™	
131815	592-RB-DST	1- or 3-Hole 4"cc, Metal Pop-Up Drain, LF	ADA Lever	Venetian Bronze®	
132559	592-SS-DST	1- or 3-Hole 4"cc, Metal Pop-Up Drain, LF	ADA Lever	Stainless*	

Addison™1-Hdl Lavatory Faucet with Touch2O™ Technology

- 5-1/6" Reach, 9-7/16" high rigid spout
- 6-1/4" From deck to aerator
- Hands-Free Activation
 - Touch feature to activate on/off
- 3/8" Compression fittings
- 2-1/2" Maximum deck thicknesses
- Battery operated with box that can be mounted to cabinet including hardware
- 32" Minimum InnoFlex® supply lines below the deck
- TempSense™ LED light
- Euro-motion DIAMOND™ valve
- WaterSense® certified product: 1.20 @ 60 psi



Part #	Mfg #	Description	Handle(s)	Finish	Price
142467	592T-DST	1- or 3-Hole 4"cc, Metal Pop-Up Drain, Lead-Free	ADA Lever	Chrome	
153045	592T-CZ-DST	1- or 3-Hole 4"cc, Metal Pop-Up Drain, Lead-Free	ADA Lever	Champagne Bronze™	
148213	592T-RB-DST	1- or 3-Hole 4"cc, Metal Pop-Up Drain, Lead-Free	ADA Lever	Venetian Bronze®	
141682	592T-SS-DST	1- or 3-Hole 4"cc, Metal Pop-Up Drain, Lead-Free	ADA Lever	Stainless*	

* Brilliance® Anti-Tarnish Lifetime Finishes

www.waterconcepts.net • Serving our Customers Since 1946 • www.plumbsupply.com

Lavatory Faucets - Single Hole

Ara® 1-Hdl Lavatory Faucet

- 5-3/16" Reach, or 5-3/16" reach w/ channel spout
- 6-3/8" high rigid spout or rigid channel spout
- 4-1/8" From deck to aerator
- 3/8" Compression fittings
- 2-1/4" Maximum deck thickness
- Optional 6" escutcheon included
- 3/2" Minimum InnoFlex® supply lines
- Euro-motion valve
- WaterSense® certified product: 1.2 gpm @ 60 psi
- Less Pop-Up (-LPU Models)



Part #	Mfg #	Description	Handle(s)	Finish	Price
166552	567LF-MPU	1- or 3-Hole 4"cc, Metal Pop-Up, LF	ADA Lever	Chrome	
162252	567LF-SSMPU	1- or 3-Hole 4"cc, Metal Pop-Up, LF	ADA Lever	Stainless*	
177881	567LF-SSLPU	1- or 3-Hole 4"cc, Less Drain, LF	ADA Lever	Stainless*	
165654	568LF-MPU	1- or 3-Hole 4"cc, Metal Pop-Up, LF Channel Spout	ADA Lever	Chrome	
160230	568LF-SSMPU	1- or 3-Hole 4"cc, Metal Pop-Up, LF Channel Spout	ADA Lever	Stainless*	
225636	568LF-LPU	1- or 3-Hole 4"cc, Less Drain, LF Channel Spout	ADA Lever	Chrome	
184425	568LF-SSLPU	1- or 3-Hole 4"cc, Less Drain, LF Channel Spout	ADA Lever	Stainless*	

Modern 1-Hdl Lavatory Faucet

- 4-1/2" Reach, 6-7/8" height
- 4-3/8" From deck to aertor
- 3/8" Compression fittings
- 2-1/4" Maximum deck thickness
- Optional 6" escutcheon included
- WaterSense® certified: 1.2 gpm



Part #	Mfg #	Description	Handle(s)	Finish	Price
227957	567LF-SSPP	1- or 3-Hole 4"cc, 50/50 Pop-Up, LF	ADA Lever	Stainless*	

Arzo® 1-Hdl Lavatory Faucet

- 4-1/2" Reach, 6-7/8" high rigid spout
- 3-3/4" From deck to aerator
- Ceramic cartridge
- 1/2" IPS connection
- 2-1/4" Maximum deck thickness (1-3/4" with escutcheon)
- Optional 6-1/10" escutcheon included
- WaterSense® certified product, 1.5 gpm @ 60 psi



Part #	Mfg #	Description	Handle(s)	Finish	Price
123722	586LF-MPU	1- or 3-Hole 4"cc, Metal Pop-Up Drain, Lead-Free	ADA Lever	Chrome	
129589	586LF-SSMPU	1- or 3-Hole 4"cc, Metal Pop-Up Drain, Lead-Free	ADA Lever	Stainless*	

* Brilliance® Anti-Tarnish Lifetime Finishes

www.plumbsupply.com • Serving our Customers Since 1946 • www.waterconcepts.net

Lavatory Faucets - Single Hole

Faucets & Valves

Ashlyn™ 1-Hdl Lavatory Faucet

- 5-1/8" Reach, 6-11/16" high rigid spout
- 3-7/16" From deck to aerator
- Red/blue indicator
- 1-1/4" Minimum clearance to backsplash
- 3/8" Compression fittings
- 2-1/2" Maximum deck thickness
- Optional 6" escutcheon included
- 32" Minimum InnoFlex® supply lines below the deck
- DIAMOND™ Valve
- WaterSense® certified product: 1.2 gpm @ 60 psi



Part #	Mfg #	Description	Handle(s)	Finish	Price
173152	564-MPU-DST	1- or 3-Hole 4"cc, Metal Pop-Up, Lead Free	ADA Lever	Chrome	
171541	564-RBMPU-DST	1- or 3-Hole 4"cc, Metal Pop-Up, Lead Free	ADA Lever	Venetian Bronze®	
171217	564-SSMPU-DST	1- or 3-Hole 4"cc, Metal Pop-Up, Lead Free	ADA Lever	Stainless*	

Cassidy™ 1-Hdl Lavatory Faucet

- 5-13/32" Reach, 6-13/16" high spout
- 5-7/32" From deck to aerator
- Channel spout:
5" Reach, 6-13/16" high
4-11/16" From deck to aerator
- 1/2" IPS connection
- 2-1/8" Maximum deck thickness
- 2-1/2" Minimum clearance to backsplash
- Euro-motion valve
- WaterSense® certified product, 1.2 gpm @ 60 psi



597LF



598LF



Part #	Mfg #	Description	Handle(s)	Finish	Price
152720	597LF-MPU	1- or 3-Hole 4"cc, Metal Pop-Up Drain, Lead Free	ADA Lever	Chrome	
152721	597LF-CZMPU	1- or 3-Hole 4"cc, Metal Pop-Up Drain, Lead Free	ADA Lever	Champagne Bronze™	
159649	597LF-PNMPU	1- or 3-Hole 4"cc, Metal Pop-Up Drain, Lead Free	ADA Lever	Polished Nickel	
152723	597LF-RBMPU	1- or 3-Hole 4"cc, Metal Pop-Up Drain, Lead Free	ADA Lever	Venetian Bronze®	
152724	597LF-SSMPU	1- or 3-Hole 4"cc, Metal Pop-Up Drain, Lead Free	ADA Lever	Stainless*	
150662	598LF-MPU	1- or 3-Hole 4"cc, MPU Drain w/ Channel Spout, LF	ADA Lever	Chrome	
152726	598LF-CZMPU	1- or 3-Hole 4"cc, MPU Drain w/ Channel Spout, LF	ADA Lever	Champagne Bronze™	
188712	598LF-PNMPU	1- or 3-Hole 4"cc, MPU Drain w/ Channel Spout, LF	ADA Lever	Polished Nickel	
152440	598LF-RBMPU	1- or 3-Hole 4"cc, MPU Drain w/ Channel Spout, LF	ADA Lever	Venetian Bronze®	
152730	598LF-SSMPU	1- or 3-Hole 4"cc, MPU Drain w/ Channel Spout, LF	ADA Lever	Stainless*	

* Brilliance® Anti-Tarnish Lifetime Finishes

www.waterconcepts.net • Serving our Customers Since 1946 • www.plumbsupply.com

Lavatory Faucets - Single Hole

Compel® 1-Hdl Lavatory Faucet

- 6-7/16" Reach, 7-3/8" high rigid spout
- 3-3/16" From deck to aerator
- Red/blue indicators
- Stream shaper
- 3/8" Compression fittings
- 2-1/2" Maximum deck thicknesses
- 32" Minimum InnoFlex® supply lines below the deck
- Euro-motion DIAMOND™ valve
- WaterSense® certified product: 1.2 gpm @ 60 psi



Part #	Mfg #	Description	Handle(s)	Finish	Price
175582	561-MPU-DST	1- or 3-Hole 4"cc, Metal Pop-Up Drain, Lead Free	ADA Lever	Chrome	
178492	561-SSMPU-DST	1- or 3-Hole 4"cc, Metal Pop-Up Drain, Lead Free	ADA Lever	Stainless*	
152787	561-LPU-DST	1- or 3-Hole 4"cc, Less Drain, Lead Free	ADA Lever	Chrome	
176470	561-SSLPU-DST	1- or 3-Hole 4"cc, Less Drain, Lead Free	ADA Lever	Stainless*	

Compel® 1-Hdl Lavatory Faucet with Touch20.xt® Technology

- 5" Reach, 8-1/4" high rigid spout
- 4" From deck to aerator
- Hands-free activation
- TempSense™ LED light
- Stream shaper
- Red/blue indicator
- 3/8" Compression fittings
- 2-1/2" Maximum deck thicknesses
- Optional 6" escutcheon included
- 32" Minimum InnoFlex® supply lines below the deck
- Coordinating insulator
- Euro-motion DIAMOND™ valve
- Uses (6) AA batteries (included) or (6) C batteries (optional)
- WaterSense® certified product: 1.2 gpm @ 60 psi



Part #	Mfg #	Description	Handle(s)	Finish	Price
182204	561T-SS-DST	1- or 3-Hole, Plastic Pop-Up Drain, Lead Free	ADA Lever	Stainless*	

Dryden™ 1-Hdl Lavatory Faucet

- 5-3/8" Reach, 5-3/4" high rigid spout
- 7-3/4" Faucet height, 3-7/8" from deck to aerator
- 3/8" Compression fittings
- 2-7/8" Maximum deck thickness or 2-3/4" with riser
- 32" Minimum supply lines below deck included
- Includes optional 6" escutcheon (551 model)
- DIAMOND™ valve
- WaterSense® certified product: 1.2 gpm @ 60 psi



Part #	Mfg #	Description	Handle(s)	Finish	Price
131286	551-DST	1- or 3-Hole 4"cc, MPU Drain, Lead-Free	ADA Lever	Chrome	

* Brilliance® Anti-Tarnish Lifetime Finishes

www.plumbsupply.com • Serving our Customers Since 1946 • www.waterconcepts.net

Lavatory Faucets - Single Hole

Single-Handle Lavatory Faucets (Continued)

Dryden™ 1-Hdl Lavatory Faucet

Part #	Mfg #	Description	Handle(s)	Finish	Price
143552	551-CZ-DST	1- or 3-Hole 4"cc, MPU Drain, Lead-Free	ADA Lever	Champagne Bronze™	
176967	551-PN-DST	1- or 3-Hole 4"cc, MPU Drain, Lead-Free	ADA Lever	Polished Nickel*	
131462	551-RB-DST	1- or 3-Hole 4"cc, MPU Drain, Lead-Free	ADA Lever	Venetian Bronze®	
130963	551-SS-DST	1- or 3-Hole 4"cc, MPU Drain, Lead-Free	ADA Lever	Stainless*	

Dryden™ 1-Hdl Touch2O.xt® Lavatory Faucet

- 5-3/8" Reach, 8-1/4" high rigid spout
- 4-3/8" From deck to aerator
- 3/8" Compression fittings
- 2" Maximum deck thickness, or 2-1/4" with riser
- 32" Minimum InnoFlex® supply lines below the deck
- Coordinating insulator
- Battery operated 4 (AA) or 6 (C)
- Hands-free activation
- DIAMOND™ Valve
- WaterSense® certified product: 1.2 gpm @ 60 psi



Part #	Mfg #	Description	Handle(s)	Finish	Price
163644	551T-DST	1- or 3-Hole 4"cc, Plastic Pop-Up, Lead Free	ADA Lever	Chrome	
174124	551T-CZ-DST	1- or 3-Hole 4"cc, Plastic Pop-Up, Lead Free	ADA Lever	Champagne Bronze™	
162516	551T-RB-DST	1- or 3-Hole 4"cc, Plastic Pop-Up, Lead Free	ADA Lever	Venetian Bronze®	
160834	551T-SS-DST	1- or 3-Hole 4"cc, Plastic Pop-Up, Lead Free	ADA Lever	Stainless*	

Haywood™ 1-Hdl Lavatory Faucet

- 5-1/2" Reach, 9-3/16" high rigid spout
- 5" From deck to aerator
- 3/8" Compression fittings
- WaterSense® certified product: 1.2 gpm



Part #	Mfg #	Description	Handle(s)	Finish	Price
228580	15999-SS-DST	1- or 3-Hole 4"cc, Plastic Pop-Up, Lead Free	ADA Lever	Stainless*	

* Brilliance® Anti-Tarnish Lifetime Finishes

www.waterconcepts.net • Serving our Customers Since 1946 • www.plumbsupply.com

Lavatory Faucets - Single Hole

Lahara® 1-Hdl Lavatory Faucet

- 5-1/2" Reach, 6-15/16" high rigid spout
- 7-1/2" High rigid spout (with escutcheon)
- 4-1/2" From deck to aerator
- Red/blue indicator
- 1/2" IPS Connection
- 2-3/4" Maximum deck thickness
- 2-1/8" Maximum deck thickness (with escutcheon)
- Optional 6-1/2" escutcheon included
- 32" Minimum InnoFlex® supply lines below deck
- DIAMOND® valve
- WaterSense® certified product: 1.2 gpm @ 60 psi



Part #	Mfg #	Description	Handle(s)	Finish	Price
132347	538-MPU-DST	1- or 3-Hole 4"cc, Metal Pop-Up Drain, Lead-Free	ADA Lever	Chrome	
148950	538-CZMPU-DST	1- or 3-Hole 4"cc, Metal Pop-Up Drain, Lead-Free	ADA Lever	Champagne Bronze™	
132136	538-RBMPU-DST	1- or 3-Hole 4"cc, Metal Pop-Up Drain, Lead-Free	ADA Lever	Venetian Bronze®	
132894	538-SSMPU-DST	1- or 3-Hole 4"cc, Metal Pop-Up Drain, Lead-Free	ADA Lever	Stainless*	

Lahara™ 1-Hdl Lavatory Faucet with Touch2O™ Technology

- 5-1/2" Reach, 7-5/16" high rigid spout
- 7-7/8" High rigid spout (with escutcheon)
- TempSense™ LED light
- 5" From deck to aerator
- 3/8" Compression fittings
- Hands-free activation
- 2-1/4" Maximum deck thickness
- 1-5/8" Maximum deck thickness (with escutcheon)
- 32" Minimum InnoFlex® supply lines below the deck
- Coordinating insulator
- Battery operated (6AA) or 6(C)
- DIAMOND™ valve
- WaterSense® certified product: 1.2 gpm @ 60 psi



Part #	Mfg #	Description	Handle(s)	Finish	Price
141460	538T-DST	1- or 3-Hole 4"cc, Plastic Pop-Up, Lead-Free	ADA Lever	Chrome	
146435	538T-RB-DST	1- or 3-Hole 4"cc, Plastic Pop-Up, Lead-Free	ADA Lever	Venetian Bronze®	
140806	538T-SS-DST	1- or 3-Hole 4"cc, Plastic Pop-Up, Lead-Free	ADA Lever	Stainless*	

* Brilliance® Anti-Tarnish Lifetime Finishes

www.plumbsupply.com • Serving our Customers Since 1946 • www.waterconcepts.net

Lavatory Faucets - Single Hole

Faucets & Valves

Linden™1-Hdl Centerset Lavatory Faucet

- 5-1/4" Reach, 8-1/8" high rigid spout
- 5-1/4" From deck to aerator
- 3/8" Compression fittings
- 2-1/2" Maximum deck thickness
- Includes optional escutcheon
- 32" Minimum InnoFlex® supply lines below the deck
- DIAMOND™ valve
- WaterSense® certified product: 1.2 gpm @ 60 psi



Part #	Mfg #	Description	Handle(s)	Finish	Price
143818	594-MPU-DST	1- or 3-Hole 4"cc, Metal Pop-Up Drain, Lead-Free	ADA Lever	Chrome	
144798	594-CZMPU-DST	1- or 3-Hole 4"cc, Metal Pop-Up Drain, Lead-Free	ADA Lever	Champagne Bronze™	
144563	594-RBMPU-DST	1- or 3-Hole 4"cc, Metal Pop-Up Drain, Lead-Free	ADA Lever	Venetian Bronze®	
143528	594-SSMPU-DST	1- or 3-Hole 4"cc, Metal Pop-Up Drain, Lead-Free	ADA Lever	Stainless*	

Tesla™ 1-Hdl Lavatory Faucet

- 4-11/16" Reach, 5-5/8" high rigid spout
- 4-11/16" From deck to aerator
- Red/blue indicator
- 3/8" Compression fittings
- 2-1/8" Maximum deck thickness
- Includes optional 6-1/8" escutcheon
- 32" Minimum InnoFlex® supply lines below the deck
- DIAMOND™ valve
- WaterSense® certified product: 1.2 gpm @ 60 psi



Part #	Mfg #	Description	Handle(s)	Finish	Price
181551	552LF-MPU	1- or 3-Hole 4"cc, Metal Pop-Up Drain, Lead Free	ADA Joystick	Chrome	
182329	552LF-PNMPU	1- or 3-Hole 4"cc, Metal Pop-Up Drain, Lead Free	ADA Joystick	Polished Nickel*	
179651	552LF-SSMPU	1- or 3-Hole 4"cc, Metal Pop-Up Drain, Lead Free	ADA Joystick	Stainless*	

Tesla™ 1-Hdl Lavatory Faucet with Touch20.xt® Technology

- 4-11/16" Reach, 6-1/8" high rigid spout
- 5-3/16" From deck to aerator
- Hands-free activation
- Red/blue indicators markings
- TempSense™ LED light
- 3/8" Compression fittings
- 2-1/8" Maximum deck thickness
- 32" Minimum InnoFlex® supply lines below the deck
- Optional 6" escutcheon included
- Coordinating insulator
- Uses (6) AA (included) or (6) C (optional) batteries
- DIAMOND Seal® Technology
- WaterSense certified: 1.2 gpm @ 60 psi



Part #	Mfg #	Description	Handle(s)	Finish	Price
184959	552TLF	1- or 3-Hole, Plastic Pop-Up Drain, Lead Free	ADA Joystick	Chrome	

* Brilliance® Anti-Tarnish Lifetime Finishes

www.waterconcepts.net • Serving our Customers Since 1946 • www.plumbsupply.com

Lavatory Faucets - Single Hole

Single-Handle Lavatory Faucets (Continued) Tesla™ 1-Hdl Lavatory Faucet with Touch20.xt® Technology

Part #	Mfg #	Description	Handle(s)	Finish	Price
186437	552TLF-SS	1- or 3-Hole, Plastic Pop-Up Drain, Lead Free	ADA Joystick	Stainless*	

Trinsic™ 1-Hdl Lavatory Faucet

- 5" Reach, 6-1/4" high rigid spout
- 2-3/8" From deck to spout
- Red/blue indicator
- 3/8" Compression fittings
- 32" Minimum InnoFlex® supply lines below the deck
- Euro-motion DIAMOND™ valve
- WaterSense® certified product: 1.2 gpm @ 60 psi



Part #	Mfg #	Description	Handle(s)	Finish	Price
152798	559LF-CZMPU	1- or 3-Hole 4"cc, Metal Pop-Up Drain, Lead-Free	ADA Lever	Champagne Bronze™	
152796	559LF-LPU	1- or 3-Hole 4"cc, Less Pop-Up Drain, Lead-Free	ADA Lever	Chrome	
151400	559LF-MPU	1- or 3-Hole 4"cc, Metal Pop-Up Drain, Lead-Free	ADA Lever	Chrome	
152799	559LF-RBMPU	1- or 3-Hole 4"cc, Metal Pop-Up Drain, Lead-Free	ADA Lever	Venetian Bronze®	
152797	559LF-SSLPU	1- or 3-Hole 4"cc, Less Pop-Up Drain, Lead-Free	ADA Lever	Stainless*	
152800	559LF-SSMPU	1- or 3-Hole 4"cc, Metal Pop-Up Drain, Lead-Free	ADA Lever	Stainless*	

Trinsic™ 1-Hdl High-Arc Lavatory Faucet

- 5-9/16" Reach, 8-7/8" high spout
- 360° swivel spout
- 5-3/4" From deck to spout
- Red/blue indicator
- Overflows in push pop-up drain
- 3" Maximum deck thickness
- 35" Minimum InnoFlex® supply lines below the deck
- 3/8" Compression fittings
- Euro-motion DIAMOND™ valve
- WaterSense® certified: 1.2 gpm @ 60 psi



Part #	Mfg #	Description	Handle(s)	Finish	Price
178645	559HA-DS	1-Hole, Metal Push Pop-Up Drain, Lead-Free	ADA Lever	Chrome	
186833	559HA-CZ-DST	1-Hole, Metal Push-Pop-Up Drain, Lead-Free	ADA Lever	Champagne Bronze™	
187577	559HA-RB-DST	1-Hole, Metal Push-Pop-Up Drain, Lead-Free	ADA Lever	Venetian Bronze®	
185164	559HA-SS-DST	1-Hole, Metal Push-Pop-Up Drain, Lead-Free	ADA Lever	Stainless*	

* Brilliance® Anti-Tarnish Lifetime Finishes

www.plumbsupply.com • Serving our Customers Since 1946 • www.waterconcepts.net

Lavatory Faucets - Single Hole

Faucets & Valves

Vero™ 1-Hdl Lavatory Faucet

- 4-25/32" Reach, 7-25/32" high rigid spout
- 5-1/4" From deck to spout
- 1/2" IPS Connection
- 2-31/32" Maximum deck thickness
- Euro-motion Diamond™ valve
- WaterSense® certified product: 1.2 gpm @ 60 psi



Part #	Mfg #	Description	Handle(s)	Finish	Price
134765	553LF	1- or 3-Hole 4"cc, Metal Push Pop-Up Drain, Lead-Free	ADA Lever	Chrome	
143242	553LF-CZ	1- or 3-Hole 4"cc, Metal Push Pop-Up Drain, Lead-Free	ADA Lever	Champagne Bronze™	
146665	553LF-RB	1- or 3-Hole 4"cc, Metal Push Pop-Up Drain, Lead-Free	ADA Lever	Venetian Bronze®	
134766	553LF-SS	1- or 3-Hole 4"cc, Metal Push Pop-Up Drain, Lead-Free	ADA Lever	Stainless*	

Victorian® 1-Hdl Lavatory Channel Faucet

- 5-1/8" Reach, 8-1/4" high rigid channel spout
- 4-1/8" From deck to spout
- 1/2" IPS connection
- 2-1/2" Maximum deck thickness
- Euro-motion valve
- WaterSense® certified product: 1.2 gpm @ 60 psi



Part #	Mfg #	Description	Handle(s)	Finish	Price
117180	554LF	1 or 3-Hole 4"cc, Metal Pop-Up Drain, Lead-Free	ADA Lever	Chrome	
146395	554LF-CZ	1 or 3-Hole 4"cc, Metal Pop-Up Drain, Lead-Free	ADA Lever	Champagne Bronze™	
129905	554LF-RB	1 or 3-Hole 4"cc, Metal Pop-Up Drain, Lead-Free	ADA Lever	Venetian Bronze®	
145762	554LF-SS	1 or 3-Hole 4"cc, Metal Pop-Up Drain, Lead-Free	ADA Lever	Stainless*	

Victorian® 1-Hdl Lavatory Faucet

- 5-3/8" Reach, 8-3/4" high rigid spout
- 4-5/8" From deck to aerator
- 1/2" IPS connection
- Includes optional 6-1/8" escutcheon for 3-hole installation (555 model)
- 1-3/8" Maximum deck thickness
- Euro-motion valve
- WaterSense® certified product: 1.2 gpm @ 60 psi



Part #	Mfg #	Description	Handle(s)	Finish	Price
144344	555LF	1- or 3-Hole 4"cc, Metal Pop-Up Drain, Lead-Free	ADA Lever	Chrome	
166040	555LF-CZ	1- or 3-Hole 4"cc, Metal Pop-Up Drain, Lead-Free	ADA Lever	Champagne Bronze™	
147493	555LF-RB	1- or 3-Hole 4"cc, Metal Pop-Up Drain, Lead-Free	ADA Lever	Venetian Bronze®	
152154	555LF-SS	1- or 3-Hole 4"cc, Metal Pop-Up Drain, Lead-Free	ADA Lever	Stainless*	

* Brilliance® Anti-Tarnish Lifetime Finishes

www.waterconcepts.net • Serving our Customers Since 1946 • www.plumbsupply.com

Lavatory Faucets - Single Hole

Vessel Faucets

Addison™ 1-Hdl Vessel Faucet

- 5" Spout Reach
- 14-1/2" Faucet height, 10" from deck to aerator
- 3/8" Compression fittings
- Hot/cold indicator
- 2-1/2" Maximum deck thickness
- 32" Minimum InnoFlex® supply lines below deck
- Drain sold separately
- Euro-motion DIAMOND™ valve
- WaterSense® certified product, 1.2 gpm @ 60 psi



Part #	Mfg #	Description	Handle(s)	Finish	Price
132560	792-DS	1-Hole, High Spout w/ Riser, Less Drain, LF	ADA Lever	Chrome	
137599	792-CZ-DST	1-Hole, High Spout w/ Riser, Less Drain, LF	ADA Lever	Champagne Bronze™	
132562	792-RB-DST	1-Hole, High Spout w/ Riser, Less Drain, LF	ADA Lever	Venetian Bronze®	
132561	792-SS-DST	1-Hole, High Spout w/ Riser, Less Drain, LF	ADA Lever	Stainless*	

Ara® 1-Hdl Vessel Faucet

- 5-3/8" Reach, or 5-3/16" reach w/ channel spout
- 13-3/8" High rigid spout, or 6-3/8" high w/ channel spout
- 11-1/8" From deck to aerator
- Red/blue indicator
- 3/8" Compression fittings
- 2-1/4" Maximum deck thickness
- 32" Minimum InnoFlex® supply lines
- Euro-motion ceramic valve
- WaterSense® certified product: 1.2 gpm @ 60 psi



767LF



768LF



Part #	Mfg #	Description	Handle(s)	Finish	Price
173773	767-LF	1-Hole, Less Drain, Lead-Free	ADA Lever	Chrome	
171989	767LF-SS	1-Hole, Less Drain, Lead-Free	ADA Lever	Stainless*	
172916	768-LF	1-Hole, Less Drain, Lead-Free Channel Spout	ADA Lever	Chrome	
171040	768LF-SS	1-Hole, Less Drain, Lead-Free Channel Spout	ADA Lever	Stainless*	

Cassidy™ 1-Hdl Vessel Lavatory Faucet with Riser

- 5-13/32" Reach, 11-9/16" high spout
- 10" From deck to aerator
- Channel Spout:
5" Reach, 11-9/16"
9-17/32" From deck to aerator
- 1/2" IPS connection
- 2-1/8" Maximum deck thickness
- Euro-motion valve
- WaterSense® certified product: 1.2 gpm @ 60 psi



797LF



798LF



Part #	Mfg #	Description	Handle(s)	Finish	Price
152731	797LF	1-Hole, Less Drain, Lead Free	ADA Lever	Chrome	

* Brilliance® Anti-Tarnish Lifetime Finishes

www.plumbsupply.com • Serving our Customers Since 1946 • www.waterconcepts.net

Lavatory Faucets - Single Hole

Vessel Faucets (Continued)

Cassidy™ 1-Hdl Vessel Lavatory Faucet with Riser

Part #	Mfg #	Description	Handle(s)	Finish	Price
152732	797LF-CZ	1-Hole, Less Drain, Lead Free	ADA Lever	Champagne Bronze™	
152246	797LF-RB	1-Hole, Less Drain, Lead Free	ADA Lever	Venetian Bronze®	
152733	797LF-SS	1-Hole, Less Drain, Lead Free	ADA Lever	Stainless*	
152735	798LF	1-Hole, Less Drain, Lead Free, Channel Spout	ADA Lever	Chrome	
152736	798LF-CZ	1-Hole, Less Drain, Lead Free, Channel Spout	ADA Lever	Champagne Bronze™	
157022	798LF-PN	1-Hole, Less Drain, Lead Free, Channel Spout	ADA Lever	Polished Nickel*	
152244	798LF-RB	1-Hole, Less Drain, Lead Free, Channel Spout	ADA Lever	Venetian Bronze®	
151765	798LF-SS	1-Hole, Less Drain, Lead Free, Channel Spout	ADA Lever	Stainless*	

Compel® 1-Hdl Vessel Faucet

- 5" Reach
- 13-5/8" Faucet height, 9-7/16" from deck to aerator
- Red/blue indicators
- 3/8" Compression fittings
- 2-1/2" Maximum deck thicknesses
- 32" Minimum InnoFlex® supply lines below the deck
- Euro-motion DIAMOND™ valve
- Drain sold separately
- WaterSense® certified product: 1.2 gpm @ 60 psi



Part #	Mfg #	Description	Handle(s)	Finish	Price
152792	761-DST	1-Hole with Riser, Less Drain, Lead Free	ADA Lever	Chrome	
176599	761-SS-DST	1-Hole with Riser, Less Drain, Lead Free	ADA Lever	Stainless*	

Dryden™ 1-Hdl Vessel Faucet

- 5-3/8" Reach
- 13-5/16" Faucet height, 8-7/8" from deck to aerator
- 3/8" Compression fittings
- 2-7/8" Maximum deck thickness or 2-3/4" with riser
- 32" Minimum supply lines below deck included
- Includes optional 6" escutcheon (551 model)
- DIAMOND™ valve
- WaterSense® certified product: 1.2 gpm @ 60 psi



Part #	Mfg #	Description	Handle(s)	Finish	Price
116273	751-DST	1-Hole, w/Riser, Less Drain, Lead-Free	ADA Lever	Chrome	
159472	751-CZ-DST	1-Hole, w/Riser, Less Drain Lead-Free	ADA Lever	Champagne Bronze™	
175035	751-PN-DST	1-Hole, w/Riser, Less Drain Lead-Free	ADA Lever	Polished Nickel*	
116275	751-RB-DST	1-Hole, w/Riser, Less Drain Lead-Free	ADA Lever	Venetian Bronze®	
134574	751-SS-DST	1-Hole, w/Riser, Less Drain Lead-Free	ADA Lever	Stainless*	

* Brilliance® Anti-Tarnish Lifetime Finishes

www.waterconcepts.net • Serving our Customers Since 1946 • www.plumbsupply.com

Lavatory Faucets - Single Hole

Dryden™ 1-Hdl Touch2O.xt® Vessel Faucet

- 5-3/8" Reach
- 13" Faucet height, 9-1/8" from deck to aerator
- 3/8" Compression fittings
- 2" Maximum deck thickness, or 2-1/4" with riser
- 32" Minimum InnoFlex® supply lines below the deck
- Coordinating insulator
- Battery operated 4 (AA) or 6 (C)
- Hands-free activation
- DIAMOND™ Valve
- WaterSense® certified product: 1.2 gpm @ 60 psi



Faucets & Valves

Part #	Mfg #	Description	Handle(s)	Finish	Price
169524	751T-RB-DST	1-Hole, w/ Riser Less Drain, Lead Free	ADA Lever	Venetian Bronze®	
174261	751T-SS-DST	1-Hole, w/ Riser Less Drain, Lead Free	ADA Lever	Stainless*	

Linden™1-Hdl Vessel Faucet

- 5-1/4" Reach
- 12-5/8" Faucet height, 9-3/4" from deck to aerator
- 3/8" Compression fittings
- 2-1/2" Maximum deck thickness
- Includes optional escutcheon
- 32" Minimum InnoFlex® supply lines below the deck
- DIAMOND™ valve
- Drain sold separately
- WaterSense® certified product: 1.2 gpm @ 60 psi



Part #	Mfg #	Description	Handle(s)	Finish	Price
148239	794-DST	1-Hole, with Riser Less Drain, Lead-Free	ADA Lever	Chrome	
156759	794-CZ-DST	1-Hole, with Riser Less Drain, Lead-Free	ADA Lever	Champagne Bronze™	
149632	794-RB-DST	1-Hole, with Riser Less Drain, Lead-Free	ADA Lever	Venetian Bronze®	
144936	794-SS-DST	1-Hole, with Riser Less Drain, Lead-Free	ADA Lever	Stainless*	

Tesla™ 1-Hdl Vessel Faucet

- 4-1/2" Reach
- 13-13/16" Faucet height, 9-3/4" from deck to aerator
- Handle rotates 22°
- 3/8" Compression fittings
- 2-1/2" Maximum deck thickness
- DIAMOND™ valve
- Drain sold separately
- WaterSense® certified product: 1.20 gpm @ 60 psi



Part #	Mfg #	Description	Handle(s)	Finish	Price
189236	752LF	1-Hole, with Riser Less Drain, Lead Free	ADA Lever	Chrome	

* Brilliance® Anti-Tarnish Lifetime Finishes

www.plumbsupply.com • Serving our Customers Since 1946 • www.waterconcepts.net

Lavatory Faucets - Single Hole

Faucets & Valves

Trinsic™ 1-Hdl Vessel Faucet

- 6-1/8" Reach
- 13-1/2" Faucet height, 9-5/16" from deck to aerator
- Red/blue indicator
- 3/8" Compression fittings
- 32" Minimum InnoFlex® supply lines below the deck
- Euro-motion DIAMOND™ valve
- Drain sold separately
- WaterSense® certified product: 1.2 gpm @ 60 psi



Part #	Mfg #	Description	Handle(s)	Finish	Price
183984	759-DST	1-Hole, with Riser, Less Drain, Lead Free	ADA Lever	Chrome	
182885	759LF-CZ-DST	1-Hole, with Riser, Less Drain, Lead Free	ADA Lever	Champagne Bronze™	
185471	759-RB-DST	1-Hole, with Riser, Less Drain, Lead Free	ADA Lever	Venetian Bronze®	
186410	759-SS-DST	1-Hole, with Riser, Less Drain, Lead Free	ADA Lever	Stainless*	

Vero™ 1-Hdl Vessel Faucet

- 4-25/32" Reach
- 11-13/16" Faucet height, 9-9-32" from deck to aerator
- 1/2" IPS Connection
- 2-5/16" Maximum deck thickness
- Drain sold separately
- WaterSense® certified product: 1.2 gpm @ 60 psi



Part #	Mfg #	Description	Handle(s)	Finish	Price
134767	753-LF	1-Hole with Riser, Less Drain, Lead-Free	ADA Lever	Chrome	
155302	753LF-CZ	1-Hole with Riser, Less Drain, Lead-Free	ADA Lever	Champagne Bronze™	
146151	753LF-RB	1-Hole with Riser, Less Drain, Lead-Free	ADA Lever	Venetian Bronze®	
134768	753LF-SS	1-Hole with Riser, Less Drain, Lead-Free	ADA Lever	Stainless*	

Victorian® 1-Hdl Vessel Faucet w/ Channel Spout

- 5-1/8" Reach
- 12-5/8" Faucet height, 8-9/16" from deck to aerator
- 1/2" IPS connection
- 2-1/2" Maximum deck thickness
- Euro-motion valve
- Drain sold separately
- WaterSense® certified product: 1.2 gpm @ 60 psi



Part #	Mfg #	Description	Handle(s)	Finish	Price
117188	754LF	1-Hole, Less Drain, Lead-Free	ADA Lever	Chrome	
159765	754LF-CZ	1-Hole, Less Drain, Lead-Free	ADA Lever	Champagne Bronze™	
144236	754LF-RB	1-Hole, Less Drain, Lead-Free	ADA Lever	Venetian Bronze®	
142970	754LF-SS	1-Hole, Less Drain, Lead-Free	ADA Lever	Stainless*	

* Brilliance® Anti-Tarnish Lifetime Finishes

www.waterconcepts.net • Serving our Customers Since 1946 • www.plumbsupply.com

Lavatory Faucets - Single Hole

Victorian® 1-Hdl Vessel Faucet

- 5-3/8" Reach
- 12-5/8" Faucet height, 8-1/2" from deck to aerator
- 1/2" IPS connection
- Euro-motion valve
- Drain sold separately
- WaterSense® certified product: 1.2 gpm @ 60 psi



Faucets & Valves

Part #	Mfg #	Description	Handle(s)	Finish	Price
171166	755LF	1-Hole, Less Drain, Lead-Free	ADA Lever	Chrome	
159222	755LF-CZ	1-Hole, Less Drain, Lead-Free	ADA Lever	Champagne Bronze™	
117194	755LF-RB	1-Hole, Less Drain, Lead-Free	ADA Lever	Venetian Bronze®	
166910	755LF-SS	1-Hole, Less Drain, Lead-Free	ADA Lever	Stainless*	

* Brilliance® Anti-Tarnish Lifetime Finishes

www.plumbsupply.com • Serving our Customers Since 1946 • www.waterconcepts.net

Lavatory - Single Hole

Single-Handle Lavatory Faucets

Baliza® 1-Hdl Lavatory Faucet

- 5-5/16" Reach, 6-29/32" high spout
- 4-5/16" From deck to aerator
- 3-1/2" Maximum deck thickness
- Optional 4" escutcheon (RP61619)
- WaterSense® certified product: 1.5 gpm @ 60 psi



Part #	Mfg #	Description	Handle(s)	Finish	Price
143662	65005LF-BN	1-Hole, Metal Pop-Up	ADA Lever	Brushed Nickel*	
168980	65005LF-BZ	1-Hole, Metal Pop-Up	ADA Lever	Brushed Bronze*	
184106	65005LF-PC	1-Hole, Metal Pop-Up	ADA Lever	Chrome	
134881	65005LF-PN	1-Hole, Metal Pop-Up	ADA Lever	Polished Nickel*	
174382	65005LF-RB	1-Hole, Metal Pop-Up	ADA Lever	Venetian Bronze®	

Charlotte™ 1-Hdl Lavatory Faucet

- 5-1/16" Reach, 5-3/4" high spout
- 32" InnoFlex supply lines
- 3" Maximum deck thickness
- WaterSense® certified: 1.5 gpm @ 60 psi



Part #	Mfg #	Description	Handle(s)	Finish	Price
170567	65085LF-BN	1-Hole, Less Drain	ADA Lever	Brushed Nickel*	
170566	65085LF-PC	1-Hole, Less Drain	ADA Lever	Chrome	
164831	65085LF-PN	1-Hole, Less Drain	ADA Lever	Polished Nickel*	

Charlotte™ Electronic Lavatory Faucet with Proximity

- 5" Reach, 7-3/8" high spout
- 6" From Deck to aerator
- Features SmartTouch Plus™ hands-free activation
- TempIQ™ temperature control technology
- 2-1/2" Maximum deck thickness
- Drain sold separately
- WaterSense® certified product: 1.5 gpm @ 60 psi



Part #	Mfg #	Description	Handle(s)	Finish	Price
157006	65685LF-BN	1-Hole, Less Drain	SmartTouch™	Brushed Nickel*	

* Brilliance® Anti-Tarnish Lifetime Finishes

www.waterconcepts.net • Serving our Customers Since 1946 • www.plumbsupply.com

Lavatory - Single Hole

Loki® 2-Hdl Lavatory Faucet

- 5-13/16" Reach, 8-9/16" high spout
- 120° Swivel spout
- 73/4" From deck to aerator
- Recommended 1-3/8" hole size
- 3-5/16" Maximum deck thickness
- WaterSense® certified product: 1.5 gpm @ 60 psi



Part #	Mfg #	Description	Handle(s)	Finish	Price
131817	65172LF-BN	1-Hole, Metal Pop-Up Drain	ADA Lever	Brushed Nickel*	

Odin™ 1-Hdl Lavatory Faucet

- 4-7/16" Reach, 6-1/2" high spout
- Laminar flow aerator
- Integrated supply line hoses, 34" long connect to 3/8" OD compression stop fittings
- 3" Maximum deck thickness
- WaterSense® certified product: 1.5 gpm @ 60 psi



Part #	Mfg #	Description	Handle(s)	Finish	Price
177284	65075LF-BL	1-Hole, Less Drain	ADA Lever	Matte Black	
165340	65075LF-BN	1-Hole, Less Drain	ADA Lever	Brushed Nickel*	
164975	65075LF-BNBL	1-Hole, Less Drain	ADA Lever	Matte Black/Brushed Nickel	
171594	65075LF-PC	1-Hole, Less Drain	ADA Lever	Chrome	

Odin™ Jason Wu 1-Hdl Lavatory Faucet

- 4-3/4" Reach, 9-1/8" high spout
- 6" From deck to aerator
- 2-1/2" Maximum deck thickness
- Includes optional base that must be used with metal sinks
- SmartTouch Plus™ hands-free activation
- TempIQ™ temperature Control
- Drain sold separately
- WaterSense® certified product: 1.5 gpm @ 60 psi



Part #	Mfg #	Description	Handle(s)	Finish	Price
156567	65675LF-BL	1-Hole, Less Drain	ADA Lever	Matte Black	
225076	65675LF-BN	1-Hole, Less Drain	ADA Lever	Brushed Nickel*	
188916	65675LF-PC	1-Hole, Less Drain	ADA Lever	Chrome	

* Brilliance® Anti-Tarnish Lifetime Finishes

www.plumbsupply.com • Serving our Customers Since 1946 • www.waterconcepts.net

Lavatory - Single Hole

Faucets & Valves

Quiessence® 1-Hdl Lavatory Faucet

- 5-3/16" Reach, 7-1/8" high spout
- 1/2" IPS connection
- 1-1/2" Hole size recommended
- 2" Maximum deck thickness
- Optional vessel sink riser
- WaterSense® certified product: 1.5 gpm @ 60 psi



Part #	Mfg #	Description	Handle(s)	Finish	Price
139478	65014LF-BN	1-Hole, Metal Pop-Up Drain	ADA Lever	Brushed Nickel*	

Rook™ SmartTouchPlus™ 1-Hdl Lavatory Faucet

- 5-13/16" Reach, 6-3/8" high spout
- 3-1/4" From deck to aerator
- Drain sold separately
- WaterSense® certified product: 1.5 gpm @ 60 psi
- Optional escutcheon (RP80414)



Part #	Mfg #	Description	Handle(s)	Finish	Price
178561	65960LF-NK	1-Hole, Less Drain	ADA Lever	Luxe Nickel*	

Rook™ 1-Hdl Lavatory Faucet

- 7-1/4" High spout
- Single hole installation
- Ceramic cartridge
- Metal pop-up included
- 3" From deck to aerator
- 2-1/2" Maximum deck thickness
- WaterSense® certified product: 1.5 gpm @ 60 psi
- **(65060LF-PN) dimensions:**
-6-3/8" Reach
- **(65061LF-NK) dimensions:**
-5-7/16" Reach



Part #	Mfg #	Description	Handle(s)	Finish	Price
223518	65060LF-PN	1-Hole, Less Drain	ADA Lever	Polished Nickel*	
226987	65060LF-NKBL	1-Hole, Less Drain	ADA Lever	Luxe Nickel/Matte Black*	
189088	65061LF-NK	1-Hole, Less Drain Channel Spout	ADA Lever	Luxe Nickel*	
188714	65061LF-NKBL	1-Hole, Less Drain Channel Spout	ADA Lever	Luxe Nickel/Matte Black*	
188523	65061LF-RB	1-Hole, Less Drain Channel Spout	ADA Lever	Venetian Bronze®	

* Brilliance® Anti-Tarnish Lifetime Finishes

www.waterconcepts.net • Serving our Customers Since 1946 • www.plumbsupply.com

Lavatory - Single Hole

Siderna® 1-Hdl Lavatory Faucet

- 5" Reach, 8-3/16" high spout
- One hole mount
- Drain sold separately
- WaterSense® certified product: 1.5 gpm @ 60 psi



Part #	Mfg #	Description	Handle(s)	Finish	Price
175549	65080LF-BL	1-Hole, Less Drain	ADA Lever	Matte Black	
143498	65080LF-BN	1-Hole, Less Drain	ADA Lever	Brushed Nickel*	
141650	65080LF-PC	1-Hole, Less Drain	ADA Lever	Chrome	

Sotria™ 1-Hdl Lavatory Faucet

- 4-55/64" Reach, 5-5/8" high spout
- 4-9/16" From deck to aerator
- 1/2-14 NPSM threaded inlets
- 1-1/8" Minimum - 1-1/2" maximum hole size
- 3" Maximum deck thickness
- Spout features hidden cache laminar flow
- WaterSense® certified product: 1.5 gpm @ 60 psi



Part #	Mfg #	Description	Handle(s)	Finish	Price
225005	65050LF-PC	1-Hole, Metal Pop-Up Drain	ADA Lever	Chrome	
178247	65050LF-BL	1-Hole, Metal Pop-Up Drain	ADA Lever	Matte Black	
187907	65050LF-NK	1-Hole, Metal Pop-Up Drain	ADA Lever	Polished Nickel*	

Sotria™ 1-Hdl Lavatory Faucet with Channel Spout

- 5-19/32" Reach, 5-21/64" high spout
- 3-15/16" From deck to aerator
- 1/2-14 NPSM threaded inlets
- 1-1/8" Minimum - 1-1/2" maximum hole size
- 3" Maximum deck thickness
- WaterSense® certified product: 1.5 gpm @ 60 psi



Part #	Mfg #	Description	Handle(s)	Finish	Price
181996	65051LF-BL	1-Hole, Metal Pop-Up Drain w/ Channel Spout	ADA Lever	Matte Black	
180744	65051LF-PC	1-Hole, Metal Pop-Up Drain w/ Channel Spout	ADA Lever	Chrome	

* Brilliance® Anti-Tarnish Lifetime Finishes

www.plumbsupply.com • Serving our Customers Since 1946 • www.waterconcepts.net

Lavatory - Single Hole

Faucets & Valves

Two-Handle Lavatory Faucets

Tresa® 2-Hdl Single Hole Lavatory Faucet

- 6-1/2" Reach, 5" high spout
- Spout features hidden water-efficient aerator
- 2-1/4" Maximum deck thickness
- WaterSense® certified product: 1.5 gpm @ 60 psi



Part #	Mfg #	Description	Handle(s)	Finish	Price
163224	65136LF-BN	1-Hole, Metal Pop-Up Drain	ADA Lever	Brushed Nickel*	
134899	65136LF-RB	1-Hole, Metal Pop-Up Drain	ADA Lever	Venetian Bronze®	

Vessel Faucets

Baliza® 1-Hdl Vessel Faucet

- 5-5/16" Reach, 12-5/16" high spout
- Grid strainer with overflow assembly
- 28 mm Ceramic disc cartridge with metal stem
- WaterSense® certified product: 1.5 gpm @ 60 psi

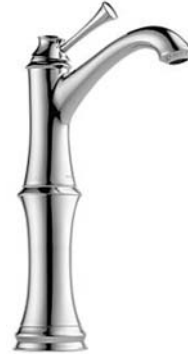

Part #	Mfg #	Description	Handle(s)	Finish	Price
134243	65105LF-RB	1-Hole, Grid Drain w/ Overflow	ADA Lever	Venetian Bronze®	

Rook™ 1-Hdl Vessel Faucet

- 5-3/8" Reach, 10-1/4" high rigid spout
- 9-1/16" Spout outlet to deck
- 1/2-14 NPSM threaded inlets
- Ceramic cartridge
- Optional escutcheon (RP80414) available
- 2 1/2 Maximum deck thickness
- Drain sold separately
- Watersense® certified product: 1.5 gpm @ 60 psi



Part #	Mfg #	Description	Handle(s)	Finish	Price
223159	65461LF-NK	1-Hole, Less Drain	ADA Lever	Luxe Nickel*	
185517	65461LF-RB	1-Hole, Less Drain	ADA Lever	Venetian Bronze®	

* Brilliance® Anti-Tarnish Lifetime Finishes

www.waterconcepts.net • Serving our Customers Since 1946 • www.plumbsupply.com

Lavatory - Single Hole

Siderna 1-Hdl Vessel Faucet

- 5" Reach, 12-1/4" high spout
- 1/2-14 NPSM Connection
- 1-1/8" to 1-1/2" Maximum hole size
- 2-1/2" Maximum deck thickness
- Drain sold separately



Part #	Mfg #	Description	Handle(s)	Finish	Price
188671	65480LF-BL	1-Hole, Less Drain	Lever	Matte Black	
155107	65480LF-BN	1-Hole, Less Drain	Lever	Brushed Nickel*	
158284	65480LF-PC	1-Hole, Less Drain	Lever	Chrome	

Tresa® 1-Hdl Vessel Faucet

- 6-3/4" Reach, 9-3/4" high spout
- Spout features hidden water-efficient aerator
- 2" Maximum deck thickness
- WaterSense® certified product: 1.5 gpm @60 psi
- Drain sold separately



Part #	Mfg #	Description	Handle(s)	Finish	Price
190138	65436LF-PC	1-Hole, Less Drain	ADA Lever	Chrome	
188974	65436LF-PN	1-Hole, Less Drain	ADA Lever	Polished Nickel*	

* Brilliance® Anti-Tarnish Lifetime Finishes

www.plumbsupply.com • Serving our Customers Since 1946 • www.waterconcepts.net

Lavatory - Single Hole

Faucets & Valves

Single-Handle Lavatory Faucets

90 Degree™ 1-Hdl Low Arc Lavatory Faucet

- 4-1/4" Reach, 6-5/16" high spout
- 3-13/16" From deck to aerator
- 3/8" Compression connections
- 1255™ Duralast™ cartridge
- WaterSense® certified: 1.5 gpm



Part #	Mfg #	Description	Handle(s)	Finish	Price
130738	S6700	1-Hole, Metal Pop-Up Drain	ADA Lever	Chrome	
143953	S6700BN	1-Hole, Metal Pop-Up Drain	ADA Lever	Brushed Nickel	

90 Degree™ 1-Hdl Channel Spout Lavatory Faucet

- 4-3/16" Reach, 6-5/16" high spout
- 3-13/16" from deck to aerator
- 3/8" Compression fittings
- 1255™ Duralast™ cartridge
- WaterSense® certified: 1.5 gpm



Part #	Mfg #	Description	Handle(s)	Finish	Price
167270	S6705	1-Hole, Metal Pop-Up Drain	ADA Lever	Chrome	
174373	S6705BN	1-Hole, Metal Pop-Up Drain	ADA Lever	Brushed Nickel	

Align™ 1-Hdl Lavatory Faucet

- 5" Reach 6-3/8" Height
- 3-5/16" From deck to aerator
- 3/8" Compression connections
- 1255™ Duralast™ cartridge
- WaterSense® Certified: 1.5 gpm



Part #	Mfg #	Description	Handle(s)	Finish	Price
177515	6190	1- or 3-Hole, Metal Pop-Up Drain	ADA Lever	Chrome	
176388	6190BN	1- or 3-Hole, Metal Pop-Up Drain	ADA Lever	Brushed Nickel	

Align™ 1-Hdl Low Arc Lavatory Faucet

- 4.998" Reach, 4.893" high spout
- 3/8" Compression fittings
- Optional 3-hole deck escutcheon available
- 1255™ Duralast™ cartridge
- WaterSense® certified: 1.5 gpm



Part #	Mfg #	Description	Handle(s)	Finish	Price
170256	6191	1- or 3-Hole, Metal Pop-Up Drain	ADA Lever	Chrome	

*Lifeshine® Anti-Tarnish Lifetime Finish

www.waterconcepts.net • Serving our Customers Since 1946 • www.plumbsupply.com

Lavatory - Single Hole

Arris™ 1-Hdl Lavatory Faucet

- 5-1/2" Reach, 6-5/8" high spout
- 5-5/8" From deck to aerator
- 3/8" fittings
- 1255™ Duralast™ cartridge
- WaterSense® certified: 1.5 gpm



Part #	Mfg #	Description	Handle(s)	Finish	Price
160879	S43001	1-Hole, Metal Pop-Up Drain	ADA Lever	Chrome	
214530	S43001BN	1-Hole, Metal Pop-Up Drain	ADA Lever	Brushed Nickel	

Brantford™ 1-Hdl Low Arc Lavatory Faucet

- 4-7/8" Reach, 6-5/8" high spout
- 4-13/16" From deck to aerator
- 3/8" Connections with flexible supplies
- 1255™ Duralast™ cartridge
- Escutcheon for 3-hole application included
- WaterSense® certified: 1.5 gpm



Part #	Mfg #	Description	Handle(s)	Finish	Price
124008	6600	1- or 3-Hole, Metal Waste	ADA Lever	Chrome	
124009	6600BN	1- or 3-Hole, Metal Waste	ADA Lever	Brushed Nickel	
122466	6600ORB	1- or 3-Hole, Metal Waste	ADA Lever	Oil Rubbed Bronze	

Chateau® 1-Hdl Lavatory Faucet

- 4-3/8" Reach
- 2" From deck to aerator
- 1/2" IPS Connections
- 1255™ Duralast™ cartridge
- WaterSense® certified: 1.5 gpm



L4621



Part #	Mfg #	Description	Handle(s)	Finish	Price
177165	L4605	4" cc Less Drain	ADA Lever	Chrome	
017155	L4621	4"cc, Drain	ADA Lever	Chrome	
020083	L4621P	4"cc, Drain	ADA Lever	Polished Brass	
084503	L4621BC	4"cc, 50/50 Drain	ADA Lever	Chrome	
020082	L4625	4"cc, Drain, 3/8" x 16" Tubing	ADA Lever	Chrome	
120610	L64624	4"cc, Drain, 3/8" x 16" Tubing, Bulk (12/Pk)	ADA Lever	Chrome	
191634	64621	4"cc, 50/50 Drain	Acrylic Knob	Chrome	

*Lifeshine® Anti-Tarnish Lifetime Finish

www.plumbsupply.com • Serving our Customers Since 1946 • www.waterconcepts.net

Lavatory - Single Hole

Faucets & Valves

Chateau® 1-Hdl Lavatory Faucet

- 4-3/8" Reach, 5-3/4" high spout
- 2" From deck to aerator
- Acrylic knob handle, tilt-on/tilt-off
- 3/8" Compression fittings
- 1255™ Duralast™ cartridge



Part #	Mfg #	Description	Handle(s)	Finish	Price
029189	64625	3-Hole, 50/50 Waste Assembly	Acrylic Knob	Chrome	

Eva™ 1-Hdl High Arc Lavatory Faucet Valve and Trim

- 5-1/16" Reach, 6-5/8" high spout
- 4-7/8" From deck to aerator
- 3/8" IPS Connections
- 1255™ Duralast™ cartridge
- Escutcheon for 3-hole application included
- WaterSense® certified: 1.5 gpm



Part #	Mfg #	Description	Handle(s)	Finish	Price
124010	6400	1-Hole, Pop-Up Drain	ADA Lever	Chrome	
123689	6400BN	1-Hole, Pop-Up Drain	ADA Lever	Brushed Nickel	
122464	6400ORB	1-Hole, Pop-Up Drain	ADA Lever	Oil Rubbed Bronze	

Icon™ 1-Hdl Lavatory Faucet

- 5" Reach, 8-1/2" high spout
- 4" From deck to aerator
- 3/8" Compression fittings
- 1255™ Duralast™ cartridge
- Escutcheon for 3-hole application included
- WaterSense® certified: 1.2 gpm



Part #	Mfg #	Description	Handle(s)	Finish	Price
102249	S6500	1- or 3-Hole, Metal Pop-Up Drain	ADA Lever	Chrome	
102250	S6500BN	1- or 3-Hole, Metal Pop-Up Drain	ADA Lever	Brushed Nickel	

Kingsley™ 1-Hdl Lavatory Faucet

- 5.309" Reach
- 3" From deck to aerator
- 3/8" Compression fittings
- 1255™ Duralast™ cartridge
- Escutcheon for 3-hole application included
- WaterSense® certified: 1.5 gpm



Part #	Mfg #	Description	Handle(s)	Finish	Price
094153	6102	1- or 3-Hole, Metal Pop-Up Drain	ADA Lever	Chrome	
082932	6102BN	1- or 3-Hole, Metal Pop-Up Drain	ADA Lever	Brushed Nickel	

*Lifeshine® Anti-Tarnish Lifetime Finish

www.waterconcepts.net • Serving our Customers Since 1946 • www.plumbsupply.com

Lavatory - Single Hole

Single-Handle Lavatory Faucets (Continued)

Kingsley™ 1-Hdl Lavatory Faucet

Part #	Mfg #	Description	Handle(s)	Finish	Price
076542	6102ORB	1- or 3-Hole, Metal Pop-Up Drain	ADA Lever	Oil Rubbed Bronze	
161363	6102P	1- or 3-Hole, Metal Pop-Up Drain	ADA Lever	Polished Brass	
087278	6102WR	1- or 3-Hole, Metal Pop-Up Drain	ADA Lever	Wrought Iron	

Method™ 1-Hdl Lavatory Faucet

- 3" Reach, 4-1/4" spout height
- 3-1/2" From deck to aerator
- 3/8" Compression fittings
- 1255™ Duralast™ cartridge
- Escutcheon for 3-hole application included
- WaterSense® certified: 1.5gpm



Part #	Mfg #	Description	Handle(s)	Finish	Price
137865	6810	1- or 3-hole, Metal Pop-Up Drain	ADA Lever	Chrome	
134861	6810BN	1- or 3-hole, Metal Pop-Up Drain	ADA Lever	Brushed Nickel	

Rizon 1-Hdl Low Arc Lavatory Faucet

- 4-7/32" Reach, 6-1/4" high spout
- 3-27/64" From deck to aerator
- 3/8" Compression fittings
- 1255™ Duralast™ cartridge
- Escutcheon for 3-hole application included
- WaterSense® certified: 1.5 gpm



Part #	Mfg #	Description	Handle(s)	Finish	Price
178140	6900	1-Hole, Metal Pop-Up Drain	ADA Lever	Chrome	

Rothbury™ 1-Hdl Lavatory Faucet

- 5/16" Reach, 3-3/16" high spout
- 2-1/16" From deck to aerator
- 3/8" Flexible supply lines
- 1255™ Duralast™ cartridge
- Escutcheon for 3-Hole application included
- WaterSense® certified: 1.5 gpm



Part #	Mfg #	Description	Handle(s)	Finish	Price
124011	S6202	1- or 2-Hole, Pop-Up Drain	ADA Lever	Chrome	
124012	S6202BN	1- or 2-Hole, Pop-Up Drain	ADA Lever	Brushed Nickel	
124013	S6202ORB	1- or 2-Hole, Pop-Up Drain	ADA Lever	Oil Rubbed Bronze	

*Lifeshine® Anti-Tarnish Lifetime Finish

www.plumbsupply.com • Serving our Customers Since 1946 • www.waterconcepts.net

Lavatory - Single Hole

Faucets & Valves

Voss™ 1-Hdl Lavatory Faucet

- 4-5/8" Reach
- 4-11/16" From deck to aerator
- 3/8" Compression fittings
- 1255™ Duralast™ cartridge
- Escutcheon for 3-hole application included
- WaterSense® certified: 1.5 gpm



Part #	Mfg #	Description	Handle(s)	Finish	Price
150545	6903	1- or 3-Hole, Metal Pop-Up Drain	ADA Lever	Chrome	
151188	6903BN	1- or 3-Hole, Metal Pop-Up Drain	ADA Lever	Brushed Nickel	
153393	6903ORB	1- or 3-Hole, Metal Pop-Up Drain	ADA Lever	Oil Rubbed Bronze	

Weymouth™ 1-Hdl Lavatory Faucet

- 5-1/2" Reach
- 5-1/4" From deck to aerator
- 3/8" Compression fittings
- 1255™ Duralast™ cartridge
- WaterSense® certified: 1.5 gpm



Part #	Mfg #	Description	Handle(s)	Finish	Price
225651	S42107NL	1- or 3-Hole, Metal Pop-Up Drain	ADA Lever	Polished Nickel	

Waterhill™ 1-Hdl Lavatory Faucet

- 5-3/8" Reach
- 4-5/32" From deck to aerator
- 1/2" IPS connections will accept standard ball nose connection for 3/8" tubing
- 1255™ Duralast™ cartridge
- Escutcheon for 3-hole application included
- WaterSense® certified: 1.5 gpm



Part #	Mfg #	Description	Handle(s)	Finish	Price
109169	S411	1- or 3-Hole, Metal Pop-Up Drain	ADA Lever	Chrome	
083439	S411BN	1- or 3-Hole, Metal Pop-Up Drain	ADA Lever	Brushed Nickel	
102921	S411ORB	1- or 3-Hole, Metal Pop-Up Drain	ADA Lever	Oil Rubbed Bronze	

Wynford™ 1-Hdl Lavatory Faucet

- 4-5/8" Reach
- 5" From deck to aerator
- 3/8" Compression fittings
- 1255™ Duralast™ cartridge
- Escutcheon for 3-hole application included
- WaterSense® certified: 1.5 gpm



Part #	Mfg #	Description	Handle(s)	Finish	Price
186314	4500	1- or 3-Hole, Metal Pop-Up Drain	ADA Lever	Chrome	

*Lifeshine® Anti-Tarnish Lifetime Finish

www.waterconcepts.net • Serving our Customers Since 1946 • www.plumbsupply.com

Lavatory - Single Hole

Single-Handle Lavatory Faucets (Continued)

Wynford™ 1-Hdl Lavatory Faucet

Part #	Mfg #	Description	Handle(s)	Finish	Price
185269	4500BN	1- or 3-Hole, Metal Pop-Up Drain	ADA Lever	Brushed Nickel	
218319	4500ORB	1- or 3-Hole, Metal Pop-Up Drain	ADA Lever	Oil Rubbed Bronze	

Vessel Faucets

90 Degree™ 1-Hdl Vessel Faucet

- 4-1/4" Reach, 12-11/16" Height
- 9-1/8" From deck to aerator
- 3/8" Compression connections
- 1255™ Duralast™ cartridge
- WaterSense® certified: 1.5 gpm



Part #	Mfg #	Description	Handle(s)	Finish	Price
127409	S6711	1-Hole, Less Drain	ADA Lever	Chrome	
141003	S6711BN	1-Hole, Less Drain	ADA Lever	Brushed Nickel	

Align™ 1-Hdl Vessel Faucet

- 4-1/2" Reach, 12-3/32" high spout
- 9" From deck to aerator
- 3/8" Compression fittings
- 1255™ Duralast® cartridge
- WaterSense® certified: 1.5 gpm
- Drain sold separately: 140780



Part #	Mfg #	Description	Handle(s)	Finish	Price
190197	6192BN	1- or 3-Hole, Metal Pop-Up Drain	ADA Lever	Brushed Nickel	

Wynford™ 1-Hdl Vessel Faucet

- 5-1/4" Reach, 10-3/4" high spout
- 9" From deck to aerator
- 3/8" Compression fittings
- 1255™ Duralast™ cartridge
- WaterSense® certified: 1.2 gpm



Part #	Mfg #	Description	Handle(s)	Finish	Price
220143	4507BN	1-Hole	ADA Lever	Brushed Nickel	
181281	4507ORB	1-Hole	ADA Lever	Oil Rubbed Bronze	

*Lifeshine® Anti-Tarnish Lifetime Finish

www.plumbsupply.com • Serving our Customers Since 1946 • www.waterconcepts.net

Lavatory Faucets - 4" Center

Single-Handle Lavatory Faucets

Coralais® Lavatory Faucet for 4" Centers with Pop-Drain, Lift Rod, Tailpiece, and Lever Handle

- 4-3/16" Stationary spout reach
- Solid brass construction
- Red/blue indexing on handle
- Temperature memory
- Flexible connections
- One-piece, self-contained ceramic disc valve
- Maximum flow rate: 1.2 gpm @ 60 psi
—0.5 gpm for (K-15198-4RA-CP) model
- Model (K-15198-4RA-CP) includes metal throat plate and vandal-resistant aerator



Metal Pop-Up Drain

Part #	Mfg #	Description	Handle(s)	Finish	Price
223147	K-15182-4RA-CP	4"cc, Metal Pop-Up, 1.2 gpm	ADA Lever	Polished Chrome	
223148	K-15182-4RA-G	4"cc, Metal Pop-Up, 1.2 gpm	ADA Lever	Brushed Chrome	

Plastic Pop-Up Drain

Part #	Mfg #	Description	Handle(s)	Finish	Price
223149	K-15182-4DRA-CP	4"cc, Plastic Pop-Up, 1.2 gpm	ADA Lever	Polished Chrome	
223150	K-15182-4DRA-G	4"cc, Plastic Pop-Up, 1.2 gpm	ADA Lever	Brushed Chrome	

Grid Drain with Tailpiece

Part #	Mfg #	Description	Handle(s)	Finish	Price
102721	K-15198-4RA-CP	4"cc, Grid Drain, 0.5 gpm	ADA Lever	Polished Chrome	

Two-Handle Lavatory Faucets

Alteo® Lavatory Faucet for 4" Centers with Pop-Up Drain, Tailpiece, and Lever Handles

- 5" Reach spout
- Metal construction
- 1/4-Turn washerless ceramic disc valves
- Integrated supply hoses with 3/8" compression connection
- WaterSense® certified product: 1.2 gpm



Part #	Mfg #	Description	Handle(s)	Finish	Price
149113	K-45100-4-2BZ	4"cc, Pop-Up Drain with Tailpiece	ADA Lever	Oil-Rubbed Bronze	
141714	K-45100-4-BN	4"cc, Pop-Up Drain with Tailpiece	ADA Lever	*Brushed Nickel	
141713	K-45100-4-CP	4"cc, Pop-Up Drain with Tailpiece	ADA Lever	Polished Chrome	

* Vibrant Limited Lifetime Warranty

www.waterconcepts.net • Serving our Customers Since 1946 • www.plumbsupply.com

Lavatory Faucets - 4" Center

Archer® Lavatory Faucet for 4" Centers with Pop-Up Drain, Tailpiece, and Lever Handles

- 4" Reach spout
- Brass construction
- 1/4-Turn washerless ceramic disc valves
- WaterSense® certified product: 1.5 gpm



Part #	Mfg #	Description	Handle(s)	Finish	Price
120240	K-11075-4-BN	4"cc, Pop-Up Drain with Tailpiece	ADA Lever	*Brushed Nickel	
109875	K-11075-4-CP	4"cc, Pop-Up Drain with Tailpiece	ADA Lever	Polished Chrome	

Coralais® Lavatory Faucet for 4" Centers with Metal Pop-Drain, Lift Rod, Tailpiece, and Lever Handles

- 4-7/16" Stationary spout reach
- Solid metal construction
- Red/blue indexing on handle
- One-piece, self-contained ceramic disc valve
- Maximum flow rate: 1.2 gpm @ 60 psi



Metal Pop-Up Drain

Part #	Mfg #	Description	Handle(s)	Finish	Price
223151	K-15241-4RA-CP	4"cc, Metal Pop-Up & Lift Rod, 1.2 gpm	ADA Lever	Polished Chrome	
223152	K-15241-4RA-G	4"cc, Metal Pop-Up & Lift Rod, 1.2 gpm	ADA Lever	Brushed Chrome	

Plastic Pop-Up Drain

Part #	Mfg #	Description	Handle(s)	Finish	Price
223153	K-15241-4DRA-CP	4"cc, Plastic Pop-Up & Lift Rod, 1.2 gpm	ADA Lever	Polished Chrome	
223154	K-15241-4DRA-G	4"cc, Plastic Pop-Up, & Lift Rod, 1.2 gpm	ADA Lever	Brushed Chrome	

Coralais® Lavatory Faucet for 4" Centers with Plug for Lift Rod Hole and Lever Handles—Less Drain

- 4-7/16" Stationary spout reach
- Solid metal construction
- Ceramic disc valves
- Red/blue indexing on handle
- Vandal-resistant aerator
- Maximum flow rate: 0.5 gpm



Part #	Mfg #	Description	Handle(s)	Finish	Price
227922	K-15240-4NDRA-CP	4"cc, Vandal-Resistant .5gpm Aerator, Less Drain	ADA Lever	Polished Chrome	

Devonshire® Lavatory Faucet for 4" Centers with Pop-Up Drain, Tailpiece, Lift Rod, and Lever Handles

- 4-3/4" Reach spout
- Metal construction
- Brass valve bodies
- 1/4-Turn washerless ceramic disc valves
- Meets EPA WaterSense® criteria



Part #	Mfg #	Description	Handle(s)	Finish	Price
122023	K-393-N4-BN	4"cc, Pop-Up Drain with Lift Rod & Tailpiece	ADA Lever	*Brushed Nickel	
122018	K-393-N4-CP	4"cc, Pop-Up Drain with Lift Rod & Tailpiece	ADA Lever	Polished Chrome	

* Vibrant Limited Lifetime Warranty

www.plumbsupply.com • Serving our Customers Since 1946 • www.waterconcepts.net

Lavatory Faucets - 4" Center

Two-Handle Lavatory Faucets (Continued)

Devonshire® Lavatory Faucet for 4" Centers with Pop-Up Drain, Tailpiece, Lift Rod, and Lever Handles

Part #	Mfg #	Description	Handle(s)	Finish	Price
088698	K-393-N4-PB	4"cc, Pop-Up Drain with Lift Rod & Tailpiece	ADA Lever	*Polished Brass	
188708	K-393-N4-SN	4"cc, Pop-Up Drain with Lift Rod & Tailpiece	ADA Lever	*Polished Nickel	
146968	K-393-N4-2BZ	4"cc, Pop-Up Drain with Lift Rod & Tailpiece	ADA Lever	Oil Rubbed Bronze	

Fairfax® 2-Hdl Lavatory Faucet for 4" Centers with Pop-Up Drain, Tailpiece, Lift Rod, and Lever Handles

- 4-1/2" Spout reach
- Metal construction.
- Brass valve bodies.
- Quarter-turn washerless ceramic disc valves
- Maximum flow rate: 1.2 gpm @ 60 psi



Part #	Mfg #	Description	Handle(s)	Finish	Price
075675	K-12266-4-BN	4"cc, 4-1/2" Reach Spout	ADA Lever	*Brushed Nickel	
075672	K-12266-4-CP	4"cc, 4-1/2" Reach Spout	ADA Lever	Polished Chrome	
135656	K-12266-4-2BZ	4"cc, 4-1/2" Reach Spout	ADA Lever	Oil-Rubbed Bronze	

Forté® 2-Hdl Lavatory Faucet for 4" Centers with Metal Pop-Up Drain, Tailpiece, and Lever Handles

- 5-1/8" Stationary spout reach
- Metal construction, brass valve bodies
- Reversible quarter-turn washerless ceramic disc valves
- Flexible connections
- Maximum flow rate: 1.5 gpm
- Meets EPA WaterSense® criteria



K-10270-4
Sculptured Handles



K-10270-4A
Traditional Handles



Part #	Mfg #	Description	Handle(s)	Finish	Price
071894	K-10270-4-BN	4"cc, Metal Drain	ADA Sculptured Lever	*Brushed Nickel	
071117	K-10270-4-CP	4"cc, Metal Drain	ADA Sculptured Lever	Polished Chrome	
076726	K-10270-4-G	4"cc, Metal Drain	ADA Sculptured Lever	Brushed Chrome	
072093	K-10270-4A-BN	4"cc, Metal Drain	ADA Traditional Lever	*Brushed Nickel	
073409	K-10270-4A-CP	4"cc, Metal Drain	ADA Traditional Lever	Polished Chrome	
072794	K-10270-4A-G	4"cc, Metal Drain	ADA Traditional Lever	Brushed Chrome	

Kelston® Lavatory Faucet for 4" Centers with Metal Pop-Up Drain, Tailpiece, and Lever Handles

- 4-1/2" Reach spout
- Brass construction
- 1/4-Turn washerless ceramic disc valves
- WaterSense® certified product: 1.5 gpm



Part #	Mfg #	Description	Handle(s)	Finish	Price
136351	K-13490-4-BN	4"cc, Metal Drain	ADA Lever	*Brushed Nickel	
132069	K-13490-4-CP	4"cc, Metal Drain	ADA Lever	Polished Chrome	
146988	K-13490-4-2BZ	4"cc, Metal Drain	ADA Lever	Oil-Rubbed Bronze	

* Vibrant Limited Lifetime Warranty

www.waterconcepts.net • Serving our Customers Since 1946 • www.plumbsupply.com

Lavatory Faucets - 4" Center

Refinia® Lavatory Faucet for 4" Centers with Pop-Up Drain, Tailpiece, and Lever Handles

- 4-1/2" Spout reach
- Metal construction
- 1/4-Turn washerless ceramic disc valves
- Integrated supply hoses with 3/8" compression connection
- WaterSense® certified product 1.5 gpm



Part #	Mfg #	Description	Handle(s)	Finish	Price
141699	K-5316-4-BN	4"cc, Pop-Up Drain with Tailpiece	ADA Lever	*Brushed Nickel	
141039	K-5316-4-CP	4"cc, Pop-Up Drain with Tailpiece	ADA Lever	Polished Chrome	

* Vibrant Limited Lifetime Warranty

www.plumbsupply.com • Serving our Customers Since 1946 • www.waterconcepts.net

Lavatory Faucets - 4" Center

Single-Handle Lavatory Faucets

Classic C-Spout 1-Hdl Centerset Lavatory Faucet

- 5-1/2" Reach, 5-9/16" high rigid spout
- Red/blue indicator
- 14" flexible supplies with 3/8" compression fittings
- Ceramic cartridge with temperature limit stop
- (1-Hole): 2-1/4" deck to aerator and 2" max. deck thickness
- (3-Hole): 2-1/2" deck to aerator and 1-3/4" max. deck thickness
- Optional escutcheon included
- WaterSense® certified product, 1.5 gpm @ 60 psi



Faucets & Valves

Part #	Mfg #	Description	Handle(s)	Finish	Price
127740	583LF-W	1- or 3-Hole 4"cc, 50/50 Pop-Up Drain, Lead-Free	ADA Lever	Chrome	
127741	583LF-SSWF	1- or 3-Hole 4"cc, 50/50 Pop-Up Drain, Lead-Free	ADA Lever	Stainless*	

Classic 1-Hdl Centerset Lavatory Faucet

- 5" Reach, 4-7/8" high rigid spout
- 1-11/16" From deck to aerator
- DIAMOND™ valve
- 3/8" Compression fittings
- 2" Maximum deck thickness
- 32" Minimum InnoFlex® supply lines below deck included
- WaterSense® certified product: 1.2 gpm @ 60 psi
- No lift rod hole (501)
50/50 Pop-Up (520-DST)
Metal Pop-Up (520-MPU-DST)
Plastic Pop-Up (520-PPU-DST)



520-DST



522-DST



Part #	Mfg #	Description	Handle(s)	Finish	Price
127072	500-DST	4"cc, Lift-Rod Hole, Lead-Free	ADA Lever	Chrome	
127928	501-DST	4"cc, No Lift-Rod Hole, Lead-Free	ADA Lever	Chrome	
156696	501LF-WF	4"cc, No Lift-Rod Hole, Lead-Free	ADA Lever	Chrome	
128275	520-TPM-DST	4"cc, Metal Pop-Up Drain, Tract-Pack, Lead-Free	ADA Lever	Chrome	
152145	520-DST	4"cc, 50/50 Pop-Up Drain, Lead-Free	ADA Lever	Chrome	
119503	520-MPU-DST	4"cc, Metal Pop-Up Drain, Lead-Free	ADA Lever	Chrome	
121837	520-SSMPU-DST	4"cc, Metal Pop-Up Drain, Lead-Free	ADA Lever	Stainless*	
130362	520-SSPPU-DST	4"cc, Plastic Pop-Up Drain, Lead-Free	ADA Lever	Stainless*	
127185	522-MPU-DST	4"cc, Metal Pop-Up Drain, Lead-Free	Clear Knob	Chrome	

* Brilliance® Anti-Tarnish Lifetime Finishes

www.waterconcepts.net • Serving our Customers Since 1946 • www.plumbsupply.com

Lavatory Faucets - 4" Center

Foundations® Core-B 1-Hdl Centerset Lavatory Faucet

- 4-1/4" Reach, 5-7/16" high rigid spout
- 2-1/16" From deck to aerator
- Red/blue indicator
- 1/2" IPS connection
- 1/4" Threaded mounting studs
- 1-1/8" Maximum deck thickness
- WaterSense® certified product, 1.5 gpm @ 60 psi
- Less Pop-Up (B501LF)
- Metal Pop-Up (B510LF, B512LF)



B501



B510



Part #	Mfg #	Description	Handle(s)	Finish	Price
140909	B501LF	3-Hole 4"cc, less Pop-Up, Lead-Free	ADA Lever	Chrome	
130713	B510LF	3-Hole 4"cc, Metal Pop-Up, Lead-Free	ADA Lever	Chrome	
134117	B510LF-SS	3-Hole 4"cc, Metal Pop-Up, Lead-Free	ADA Lever	Stainless*	
130007	B512LF	3-Hole 4"cc, Metal Pop-Up, Lead-Free	Clear Knob	Chrome	

Two-Handle Lavatory Faucets

Addison™ 2-Hdl Centerset Lavatory Faucet

- 5" Reach, 7" high rigid spout
- 4-7/8" From deck to aerator
- 3/8" Compression fittings
- 2-1/4" Maximum deck thickness
- 32" Minimum InnoFlex® supply lines below the deck included
- DIAMOND™ Valve
- WaterSense® Certified product, 1.2 gpm @ 60 psi



Part #	Mfg #	Description	Handle(s)	Finish	Price
162736	2592-CZMPU-DST	3-Hole 4"cc, Metal Pop-Up Drain, Lead-Free	ADA Lever	Champagne Bronze™	
153046	2592-MPU-DST	3-Hole 4"cc, Metal Pop-Up Drain, Lead-Free	ADA Lever	Chrome	
153047	2592-RBMPU-DST	3-Hole 4"cc, Metal Pop-Up Drain, Lead-Free	ADA Lever	Venetian Bronze®	
153049	2592-SSMPU-DST	3-Hole 4"cc, Metal Pop-Up Drain, Lead-Free	ADA Lever	Stainless*	

Ashlyn™ 2-Hdl Centerset Lavatory Faucet

- 5-1/16" Reach, 5-9/16" high rigid spout
- 4-9/16" From deck to aerator
- Red/blue indicator
- 1-1/4" Minimum clearance to backsplash
- 3/8" Compression fittings
- 2-1/4" Maximum deck thickness
- 32" Minimum InnoFlex® supply lines below the deck [
- DIAMOND™ Valve
- WaterSense® certified product: 1.2 gpm @ 60 psi



Part #	Mfg #	Description	Handle(s)	Finish	Price
170825	2564-MPU-DST	3-Hole 4"cc, Metal Pop-Up Drain, Lead-Free	ADA Lever	Chrome	
172088	2564-RBMPU-DST	3-Hole 4"cc, Metal Pop-Up Drain, Lead-Free	ADA Lever	Venetian Bronze®	
170524	2564-SSMPU-DST	3-Hole 4"cc, Metal Pop-Up Drain, Lead-Free	ADA Lever	Stainless*	

* Brilliance® Anti-Tarnish Lifetime Finishes

www.plumbsupply.com • Serving our Customers Since 1946 • www.waterconcepts.net

Lavatory Faucets - 4" Center

Faucets & Valves

Cassidy™ 2-Hdl Centerset Lavatory Faucet

- 5-13/32" Reach, 6-1/4" high rigid spout
- 4-25/32" From deck to aerator
- 1/2" IPS Connection
- 1-5/8" Maximum deck thickness
- WaterSense® certified product: 1.2 gpm @60 psi



Part #	Mfg #	Description	Handle(s)	Finish	Price
152739	2597LF-CZMPU	3-Hole 4"cc, Metal Pop-Up Drain, Lead Free	ADA Lever	Champagne Bronze™	
152760	2597LF-CZMPU-LH P	3-Hole 4"cc, Metal Pop-Up Drain, Lead Free	Less Handles	Champagne Bronze™	
152737	2597LF-MPU	3-Hole 4"cc, Metal Pop-Up Drain, Lead Free	ADA Lever	Chrome	
152168	2597LF-MPU-LHP	3-Hole 4"cc, Metal Pop-Up Drain, Lead Free	Less Handles	Chrome	
153342	2597LF-PNMPU	3-Hole 4"cc, Metal Pop-Up Drain, Lead Free	ADA Lever	Polished Nickel*	
185454	2597LF-PNMPU-LH P	3-Hole 4"cc, Metal Pop-Up Drain, Lead Free	Less Handles	Polished Nickel	
152741	2597LF-RBMPU	3-Hole 4"cc, Metal Pop-Up Drain, Lead Free	ADA Lever	Venetian Bronze®	
152761	2597LF-RBMPU-LH P	3-Hole 4"cc, Metal Pop-Up Drain, Lead Free	Less Handles	Venetian Bronze®	
152742	2597LF-SSMPU	3-Hole 4"cc, Metal Pop-Up Drain, Lead Free	ADA Lever	Stainless*	
152762	2597LF-SSMPU-LH P	3-Hole 4"cc, Metal Pop-Up Drain, Lead Free	Less Handles	Stainless*	

Classic 2-Hdl Centerset Lavatory Faucet

- 5-1/4" Reach, 3-1/4" high rigid spout
- 2" From deck to aerator
- 1/2" IPS Connection
- 1-9/16" Maximum deck thickness
- Hot/cold indicators
- WaterSense® certified product, 1.2 gpm @ 60 psi
- Metal Pop-Up (2520LF)
Less Pop-Up (2500LF, 2510LF, 2502LF, 2512LF)



2500LF



2502LF



Part #	Mfg #	Description	Handle(s)	Finish	Price
146034	2500LF	2-or 3-Hole 4"cc, Less Pop-Up, Lead-Free	ADA Blade	Chrome	
155420	2510LF	2-or3-Hole 4"cc, Less Pop-Up, Lead-Free	ADA Blade	Chrome	
146337	2502LF	2-or3-Hole 4"cc, Less Pop-Up, Lead-Free	Clear Knob	Chrome	
155784	2512LF	2-or3-Hole 4"cc, Less Pop-Up, Lead-Free	Clear Knob	Chrome	
146107	2520LF-MPU	3-Hole 4"cc, Metal Pop-Up Drain, Lead-Free	ADA Blade	Chrome	
146035	2522LF-MPU	3-Hole 4"cc, Metal Pop-Up Drain, Lead-Free	Clear Knob	Chrome	

* Brilliance® Anti-Tarnish Lifetime Finishes

www.waterconcepts.net • Serving our Customers Since 1946 • www.plumbsupply.com

Lavatory Faucets - 4" Center

Classic 2-Hdl Centerset Lavatory Faucet

- 5-1/4" Reach, 3-1/4" high rigid spout
- 2" From deck to aerator
- 1/2" IPS Connection
- 1-9/16" Maximum deck thickness
- WaterSense® certified product: 1.2 gpm @ 60 psi
- Metal Pop-Up (2503LF)
Less Pop-Up (2523LF)



Part #	Mfg #	Description	Handle(s)	Finish	Price
145730	2503LF	2-or3-Hole 4"cc, Less Pop-Up, Lead-Free	ADA Lever	Chrome	
144382	2523LF-MPU	3-Hole 4"cc, Metal Pop-Up Drain, Lead-Free	ADA Lever	Chrome	
152826	2503LF-SS	2-or 3-Hole 4"cc, Less Pop-Up, Lead-Free	ADA Lever	Stainless*	
143810	2523LF-SSMPU	3-Hole 4"cc, Metal Pop-Up Drain, Lead-Free	ADA Lever	Stainless*	

Dryden™ 2-Hdl Centerset Lavatory Faucet

- 4-11/16" Reach, 6-5/8" high rigid spout
- 4-1/8" From deck to aerator
- 3/8" Compression fittings
- 1/2" IPS Connection
- 2-1/4" Maximum deck thickness
- 32" Minimum InnoFlex® supply lines below the deck
- DIAMOND™ valve
- WaterSense® certified product, 1.2 gpm @ 60 psi



Part #	Mfg #	Description	Handle(s)	Finish	Price
158894	2551-MPU-DST	3-Hole 4"cc, Metal Pop-Up Drain, Lead-Free	ADA Lever	Chrome	
166667	2551-CZMPU-DST	3-Hole 4"cc, Metal Pop-Up Drain, Lead-Free	ADA Lever	Champagne Bronze™	
178256	2551-PNMPU-DST	3-Hole 4"cc, Metal Pop-Up Drain, Lead-Free	ADA Lever	Polished Nickel*	
156559	2538-SSMPU-DST	3-Hole 4"cc, Metal Pop-Up Drain, Lead-Free	ADA Lever	Venetian Bronze®	
116280	2551-SSMPU-DST	3-Hole 4"cc, Metal Pop-Up Drain, Lead-Free	ADA Lever	Stainless*	

Foundations® Core-B 2-Hdl Centerset Lavatory Faucet

- 4-5/16" Reach, 3-3/4" high rigid spout
- 2-3/8" From deck to aerator
- 1/2" IPS Connection
- 1" Maximum deck thickness
- WaterSense® certified product: 1.2 gpm @ 60 psi



Part #	Mfg #	Description	Handle(s)	Finish	Price
136366	B2510LF	3-Hole 4"cc, Metal Pop-Up Drain, Lead-Free	ADA Lever	Chrome	
132471	B2510LF-SS	3-Hole 4"cc, Metal Pop-Up Drain, Lead-Free	ADA Lever	Stainless*	
165753	B2512LF	3-Hole 4"cc, Metal Pop-Up Drain, Lead-Free	Crystal Knobs	Chrome	

* Brilliance® Anti-Tarnish Lifetime Finishes

www.plumbsupply.com • Serving our Customers Since 1946 • www.waterconcepts.net

Lavatory Faucets - 4" Center

Faucets & Valves

Lahara® 2-Hdl Centerset Lavatory Faucet

- 5" Reach, 6-3/8" high
- 4-5/8" From deck to aerator
- 3/8" Compression fittings
- 2-1/4" Maximum deck thickness
- 32" Minimum InnoFlex® supply lines below the deck
- DIAMOND™ valve
- WaterSense® certified product: 1.2 gpm @ 60 psi



Part #	Mfg #	Description	Handle(s)	Finish	Price
150258	2538-CZMPU-DST	3-Hole 4"cc, Metal Pop-Up Drain, Lead-Free	ADA Lever	Champagne Bronze™	
153783	2538-SSMPU-DST	3-Hole 4"cc, Metal Pop-Up Drain, Lead-Free	ADA Lever	Chrome	
153784	2538-SSMPU-DST	3-Hole 4"cc, Metal Pop-Up Drain, Lead-Free	ADA Lever	Venetian Bronze®	
153785	2538-SSMPU-DST	3-Hole 4"cc, Metal Pop-Up Drain, Lead-Free	ADA Lever	Stainless*	

Leland® 2-Hdl Centerset Lavatory Faucet

- 5-1/16" Reach, 3-7/8" high rigid spout
- 2-1/2" From deck to aerator
- 1-5/8" Maximum deck thickness
-Thick deck kit RP76691 adds 1-1/4" max thickness
- WaterSense® certified product: 1.2 gpm



Part #	Mfg #	Description	Handle(s)	Finish	Price
147231	2578LF-278	3-Hole 4"cc, 50/50 Pop-Up Drain, Lead-Free	ADA Lever	Chrome	
174290	2578LFRB-278RB	3-Hole 4"cc, 50/50 Pop-Up Drain, Lead-Free	ADA Lever	Venetian Bronze®	
147232	2578LFSS-278SS	3-Hole 4"cc, 50/50 Pop-Up Drain, Lead-Free	ADA Lever	Stainless*	

Linden™ 2-Hdl Centerset Lavatory Faucet

- 4-7/8" Reach, 5-3/4" high rigid spout
- 4-1/2" From deck to aerator
- 3/8" Compression fittings
- 2-1/4" Maximum deck thickness
- 32" Minimum InnoFlex® supply lines below the deck
- DIAMOND™ valve
- WaterSense® certified product: 1.2 gpm @ 60 psi



Part #	Mfg #	Description	Handle(s)	Finish	Price
190194	2593-MPU-DST	3-Hole 4"cc, Metal Pop-Up Drain, Lead-Free	ADA Lever	Chrome	
190240	2593-RBMPU-DST	3-Hole 4"cc, Metal Pop-Up Drain, Lead-Free	ADA Lever	Venetian Bronze®	
223604	2593-SSMPU-DST	3-Hole 4"cc, Metal Pop-Up Drain, Lead-Free	ADA Lever	Stainless*	
159723	2594-CZMPU-DST	3-Hole 4"cc, Metal Pop-Up Drain, Lead-Free	ADA Lever	Champagne Bronze™	
157475	2594-MPU-DST	3-Hole 4"cc, Metal Pop-Up Drain, Lead-Free	ADA Lever	Chrome	
157328	2594-RBMPU-DST	3-Hole 4"cc, Metal Pop-Up Drain, Lead-Free	ADA Lever	Venetian Bronze®	
157456	2594-SSMPU-DST	3-Hole 4"cc, Metal Pop-Up Drain, Lead-Free	ADA Lever	Stainless*	

* Brilliance® Anti-Tarnish Lifetime Finishes

www.waterconcepts.net • Serving our Customers Since 1946 • www.plumbsupply.com

Lavatory Faucets - 4" Center

Tesla® 2-Hdl Centerset Lavatory Faucet

- 4-1/2" Reach, 6-1/2" high rigid spout
- 5-11/16" From deck to aerator
- Red/blue indicators
- 3/8" Compression fittings
- 2-1/4" Maximum deck thickness
- 3/2" Minimum InnoFlex® supply lines below the deck
- DIAMOND™ valve
- WaterSense® certified product: 1.2 gpm @ 60 psi



Part #	Mfg #	Description	Handle(s)	Finish	Price
223378	2552-MPU-DST	3-Hole 4"cc, Metal Pop-Up Drain, Lead Free	ADA Lever	Chrome	
187678	2552-SSMPU-DST	3-Hole 4"cc, Metal Pop-Up Drain, Lead Free	ADA Lever	Stainless*	

Victorian™ 2-Hdl Centerset Lavatory Faucet

- 5-1/8" Reach, 6-1/4" high rigid spout
- 4" From deck to aerator
- 3/8" Compression fittings
- 2-1/4" Maximum deck thickness
- 3/2" Minimum InnoFlex® supply lines below the deck
- DIAMOND™ valve
- WaterSense® certified product: 1.2 gpm @ 60 psi



Part #	Mfg #	Description	Handle(s)	Finish	Price
173065	2555-CZMPU-DST	3-Hole 4"cc, Metal Pop-Up Drain, Lead-Free	ADA Lever	Champagne Bronze™	
161099	2555-MPU-DST	3-Hole 4"cc, Metal Pop-Up Drain, Lead-Free	ADA Lever	Chrome	
162273	2555-PBMPU-DST	3-Hole 4"cc, Metal Pop-Up Drain, Lead-Free	ADA Lever	Polished Brass*	
156749	2555-RBMPU-DST	3-Hole 4"cc, Metal Pop-Up Drain, Lead-Free	ADA Lever	Venetian Bronze®	
156750	2555-SSMPU-DST	3-Hole 4"cc, Metal Pop-Up Drain, Lead-Free	ADA Lever	Stainless*	

Windemere® 2-Hdl Centerset Lavatory Faucet

- 5-1/8" Reach, 5-7/8" high rigid spout
- 3-17/32" From deck to aerator
- Hot/cold indicators
- 1/2" IPS Connection
- 1-1/8" Maximum deck thickness
- WaterSense® certified product: 1.2 gpm @ 60 psi



Part #	Mfg #	Description	Handle(s)	Finish	Price
135103	B2596LF	3-Hole 4"cc, Metal Pop-Up Drain, Lead-Free	ADA Lever	Chrome	
133542	B2596LF-OB	3-Hole 4"cc, Metal Pop-Up Drain, Lead-Free	ADA Lever	Oil-Rubbed Bronze	
157251	B2596LF-PB	3-Hole 4"cc, Metal Pop-Up Drain, Lead-Free	ADA Lever	Polished Brass*	
133218	B2596LF-SS	3-Hole 4"cc, Metal Pop-Up Drain, Lead-Free	ADA Lever	Stainless*	

* Brilliance® Anti-Tarnish Lifetime Finishes

www.plumbsupply.com • Serving our Customers Since 1946 • www.waterconcepts.net

Lavatory Faucets - 4" Center

Faucets & Valves

Single-Handle Lavatory Faucets Chateau Single-Handle Lavatory Faucet

- 4-3/8" Spout reach
- 2" From deck to aerator
- 50/50 Pop-Up Drain
- 1255™ Duralast™ cartridge
- Pivot action lever style handle
- Flow rate: 1.2 gpm



Part #	Mfg #	Description	Handle(s)	Finish	Price
126359	L64621	4"cc, 1/2" IPS Connections	ADA Lever	Chrome	
037061	L64625	4"cc, 3/8" Compression Connections	ADA Lever	Chrome	

Two-Handle Lavatory Faucets Brantford™ 2-Hdl Lavatory Faucet

- 5-1/16" Reach, 5" high spout
- 3-1/2" From deck to aerator
- 1/2" IPS Connection
- 1234 Cartridge design
- WaterSense® certified: 1.5 gpm



Part #	Mfg #	Description	Handle(s)	Finish	Price
105029	6610	4"cc, Metal Pop-Up Drain	ADA Lever	Chrome	
102294	6610BN	4"cc, Metal Pop-Up Drain	ADA Lever	Brushed Nickel	
102285	6610ORB	4"cc, Metal Pop-Up Drain	ADA Lever	Oil Rubbed Bronze	

Chateau™ 2-Hdl Lavatory Faucet

- 4-15/16" Reach, 3-5/16" high spout
- 2-5/8" From deck to aerator
- 1/2" IPS Connection
- 1234 Duralast™ cartridge
- Includes hot and cold temperature indicators
- WaterSense® certified: 1.2 gpm



Part #	Mfg #	Description	Handle(s)	Finish	Price
076481	4925	4"cc, Metal Pop-Up Drain	ADA Lever	Chrome	

Dartmoor™ 2-Hdl Lavatory Faucet

- 6-1/16" Reach, 5-15/16" high spout
- 4-1/4" From deck to aerator
- 1/2" IPS Connection
- 1234 Cartridge design
- WaterSense® certified: 1.5 gpm



Part #	Mfg #	Description	Handle(s)	Finish	Price
224173	6802	4"cc, Metal Pop-Up Drain	ADA Lever	Chrome	
225130	6802ORB	4"cc, Metal Pop-Up Drain	ADA Lever	Oil Rubbed Bronze	

*Lifeshine® Anti-Tarnish Lifetime Finish

www.waterconcepts.net • Serving our Customers Since 1946 • www.plumbsupply.com

Lavatory Faucets - 4" Center

Eva™ 2-Hdl Lavatory Faucet

- 3-7/8" Reach, 6-3/16" high spout
- 4-1/2" From deck to aerator
- 1/2" IPS Connection
- 1224 Cartridge design
- WaterSense® certified: 1.5 gpm



Part #	Mfg #	Description	Handle(s)	Finish	Price
094488	6410	4"cc, Metal Pop-Up Drain, High Arc Spout	ADA Lever	Chrome	
097628	6410BN	4"cc, Metal Pop-Up Drain, High Arc Spout	ADA Lever	Brushed Nickel	
096046	6410ORB	4"cc, Metal Pop-Up Drain, High Arc Spout	ADA Lever	Oil Rubbed Bronze	

Gibson 2-Hdl Lavatory Faucet

- 4-3/16" Reach, 7-15/16" high spout
- 5-23/32" From deck to aerator
- 1/2" IPS connection
- 1234 Cartridge design
- WaterSense® certified: 1.2 gpm



Part #	Mfg #	Description	Handle(s)	Finish	Price
227081	6150	4"cc, Pop-Up Drain	ADA Lever	Chrome	

Icon™ 2-Hdl Lavatory Faucet

- 5-3/4" Reach, 8-1/2" high spout
- 5-3/8" From deck to aerator
- 1/2" IPS Connection
- 1234 Duralast® cartridge
- WaterSense® certified: 1.2 gpm



Part #	Mfg #	Description	Handle(s)	Finish	Price
196523	S6510	4"cc, Metal Pop-Up Drain	ADA Lever	Chrome	
096171	S6510BN	4"cc, Metal Pop-Up Drain	ADA Lever	Brushed Nickel	

Kingsley™ 2-Hdl Lavatory Faucet

- 5-5/8" Reach, 3-1/4" high spout
- 2" From deck to aerator
- 1/2" IPS connection
- 1224 Cartridge design
- WaterSense® certified: 1.5 gpm



Part #	Mfg #	Description	Handle(s)	Finish	Price
070913	6101	4"cc, Metal Pop-Up Drain	ADA Lever	Chrome	
077651	6101BN	4"cc, Metal Pop-Up Drain	ADA Lever	Brushed Nickel	
083434	6101ORB	4"cc, Metal Pop-Up Drain	ADA Lever	Oil Rubbed Bronze	

*Lifeshine® Anti-Tarnish Lifetime Finish

www.plumbsupply.com • Serving our Customers Since 1946 • www.waterconcepts.net

Lavatory Faucets - 4" Center

Faucets & Valves

Kingsley™ 2-Hdl Lavatory Faucet

- 4-3/8" Reach, 6-3/4" high spout
- 4-1/2" From deck to aerator
- 1/2" IPS connections
- 1224 Cartridge design
- WaterSense® certified: 1.5 gpm



Part #	Mfg #	Description	Handle(s)	Finish	Price
084409	6121	4"cc, Meta Pop-Up Drain	ADA lever	Chrome	
104394	6121BN	4"cc, Meta Pop-Up Drain	ADA lever	Brushed Nickel	
079298	6121ORB	4"cc, Meta Pop-Up Drain	ADA lever	Oil Rubbed Bronze	
094233	6121WR	4"cc, Meta Pop-Up Drain	ADA lever	Wrought Iron	

Voss™ 2-Hdl Lavatory Faucet

- 6-1/8" High, 5-3/8" reach spout
- 4-3/4" From deck to aerator
- 1/2" IPS connections
- 1224 cartridge design
- WaterSense® certified: 1.5 gpm



Part #	Mfg #	Description	Handle(s)	Finish	Price
152309	6901	4"cc, Metal Pop-Up Drain, High Arc Spout	ADA Lever	Chrome	
160697	6901BN	4"cc, Metal Pop-Up Drain, High Arc Spout	ADA Lever	Brushed Nickel	

Wynford™ 2-Hdl Lavatory Faucet

- 4-1/2" Spout reach, 5-3/4" high spout
- 4-1/4" From deck to aerator
- 1/2" IPS connection
- 1224 Cartridge
- WaterSense® certified: 1.5 gpm



Part #	Mfg #	Description	Handle(s)	Finish	Price
188953	4505	4"cc, Metal Pop-Up	ADA Lever	Chrome	
220421	4505BN	4"cc, Metal Pop-Up	ADA Lever	Brushed Nickel	
186958	4505ORB	4"cc, Metal Pop-Up	ADA Lever	Oil Rubbed Bronze	

*Lifeshine® Anti-Tarnish Lifetime Finish

www.waterconcepts.net • Serving our Customers Since 1946 • www.plumbsupply.com

Lavatory - Centerset

Single-Handle Lavatory Faucets
E200 Single Handle Lavatory Faucet

- *Washerless cartridge*
- *E200MM includes metal handle and metal throat plate*



Faucets & Valves

Part #	Mfg#	Description	Price
078933	E200M	4"cc Metal Post Handle with Chrome Plated Brass Pop-Up	



Lavatory - Centerset

Single-Handle Lavatory Faucets

Maxwell 1-Hdl Lavatory Faucet

- Maximum aerator: 1.5 gpm @ 60 psi
- 1/2" NPSM Supply connection with plastic coupling nut
- Ceramic disc cartridge with temperature limit stops
- Brass and copper waterway
- Handle has acrylic hot and cold index button
- Limited lifetime warranty
- Meets EPA WaterSense® criteria



Part #	Mfg #	Description	Handle(s)	Finish	Price
128642	40-145	4"cc, Metal Pop-Up	ADA Lever	Chrome	

Hardwater® 1-Hdl Lavatory Faucet

- 4-7/8" Spout reach
- Brass escutcheon plate
- Maximum aerator: 2.2 gpm @ 60 psi
- Supplied with 1/4" nominal copper tubes with 1/2" compression tubes
- Ceramic disc cartridge with temperature limit stops
- Limited lifetime warranty



Part #	Mfg #	Description	Handle(s)	Finish	Price
027529	40-501	4"cc, Less Lift Hole	ADA Loop Lever	Chrome	

*Physical Vapor Deposition (PVD) Limited Lifetime Finish

www.waterconcepts.net • Serving our Customers Since 1946 • www.plumbsupply.com

Lavatory Faucets

Single-Handle Lavatory Faucets

P4C Classic Series 1-Hdl Lavatory Faucet

- *Stainless steel ball valve*
- *Max flow rate: 1.5 gpm @ 60 psi*
- *-CL = Less Drain*



Part #	Mfg #	Description	Handle(s)	Finish	Price
141391	P4C-500C	4"cc, Brass Pop-Up Drain	ADA Metal Lever	Chrome	
155686	P4C-500CL	4"cc, Less Pop-Up Drain	ADA Metal Lever	Chrome	
141392	P4C-500BN	4"cc, Brass Pop-Up Drain	ADA Metal Lever	Brushed Nickel	

P4B Builder Series 1-Hdl Lavatory Faucet

- *Ceramic cartridges*
- *Brass Pop-Up*
- *Optional escutcheon plate included*
- *Max flow rate: 1.2 gpm @ 60 psi*



Part #	Mfg #	Description	Handle(s)	Finish	Price
234725	P4B-500C	1- or 3-Hole, Brass Pop-Up Drain	ADA Metal Lever	Chrome	
234726	P4B-500BN	1- or 3-Hole, Brass Pop-Up Drain	ADA Metal Lever	Brushed Nickel	
234727	P4B-500ORB	1- or 3-Hole, Brass Pop-Up Drain	ADA Metal Lever	Oil Rubbed Bronze	

Two-Handle Lavatory Faucets

P4B Builders Series 2-Hdl Lavatory Faucet

- *Washerless cartridges*
- *Max flow rate: 1.5 gpm @ 60 psi*



Part #	Mfg #	Description	Handle(s)	Finish	Price
141376	P4B-400C	4"cc 3-Hole, Brass Pop-Up Drain	ADA Metal Lever	Chrome	
141377	P4B-400BN	4"cc 3-Hole, Brass Pop-Up Drain	ADA Metal Lever	Brushed Nickel	
141378	P4B-400ORB	4"cc 3-Hole, Brass Pop-Up Drain	ADA Metal Lever	Oil Rubbed Bronze	

P4B Builders Series 2-Hdl Lavatory Faucet

- *Metal lever handles*
- *Ceramic cartridges*
- *Max flow rate: 1.2 gpm*



Part #	Mfg #	Description	Handle(s)	Finish	Price
235412	P4B-420C	4"cc 3-Hole, Brass Pop-Up Drain	ADA Metal Lever	Chrome	
235413	P4B-420BN	4"cc 3-Hole, Brass Pop-Up Drain	ADA Metal Lever	Brushed Nickel	

Lavatory Faucets

Two-Handle Lavatory Faucets (Continued)

P4B Builders Series 2-Hdl Lavatory Faucet

Part #	Mfg #	Description	Handle(s)	Finish	Price
235414	P4B-420ORB	4"cc 3-Hole, Brass Pop-Up Drain	ADA Metal Lever	Oil Rubbed Bronze	

P4C Classic Series 2-Hdl Lavatory Faucet

- Washerless cartridges
- Max flow rate: 1.5 gpm @ 60 psi



Part #	Mfg #	Description	Handle(s)	Finish	Price
141393	P4C-400C	4"cc 3-Hole, Brass Pop-Up Drain	ADA Metal Wing	Chrome	
154377	P4C-402C	4"cc 3-Hole, Brass Pop-Up Drain	Acrylic Round	Chrome	

P4V Value Series 2-Hdl Lavatory Faucet

- Washerless cartridges
- Acrylic round handles
- Max flow rate: 1.2 gpm @ 60 psi



Part #	Mfg #	Description	Handle(s)	Finish	Price
157443	P4V-402C	4"cc 3-Hole, Brass Pop-Up Drain	Acrylic Round	Chrome	
148251	P4V-402-CL	4"cc 3-Hole, Less Pop-Up Drain	Acrylic Round	Chrome	

P4B Builders Series 2-Hdl Lavatory Faucet

- Washerless cartridges
- Max flow rate: 1.5 gpm @ 60 psi



Part #	Mfg #	Description	Handle(s)	Finish	Price
170252	P4B-480C	8"cc 3-Hole, Brass Pop-Up Drain	ADA Metal Lever	Chrome	

Lavatory - Widespread

Two-Handle Widespread Lavatory Faucets

Alteo® 2-Hdl Lavatory Faucet for 8" or 16" Centers with Pop-Up Drain and Tailpiece

- 4-1/2" Spout reach
- Metal construction
- 1/4-Turn washerless ceramic disc valves
- UltraGlide valve with Dry Stem technology
- Maximum flow rate: 1.2 gpm
- Meets EPA WaterSense® criteria



Part #	Mfg #	Description	Handle(s)	Finish	Price
141725	K-45102-4-BN	8"-16"ws, Pop-Up Drain with Tailpiece	ADA Lever	*Brushed Nickel	
141726	K-45102-4-CP	8"-16"ws, Pop-Up Drain with Tailpiece	ADA Lever	Polished Chrome	
152340	K-45102-4-2BZ	8"-16"ws, Pop-Up Drain with Tailpiece	ADA Lever	Oil-Rubbed Bronze	

Archer™ 2-Hdl Lavatory Faucet for 8" or 16" Centers with Pop-Up Drain and Tailpiece

- 4" Spout reach
- Fluid design lines
- 1/4-Turn washerless ceramic disc valves
- Maximum Flow Rate: 1.2 gpm



Part #	Mfg #	Description	Handle(s)	Finish	Price
111423	K-11076-4-BN	8"-16"ws, Metal Drain	ADA Lever	*Brushed Nickel	
111584	K-11076-4-CP	8"-16"ws, Metal Drain	ADA Lever	Polished Chrome	

Artifacts® Bell Design Stationary Spout with Aerator and Pop-Up drain with 1-1/4" Tailpiece

- 5-3/8" Reach, 4-11/16" high spout
- Brass construction
- Handles sold separately
- Laminar flow
- WaterSense® certified product: 1.5 gpm



Part #	Mfg #	Description	Handle(s)	Finish	Price
162098	K-72759-BN	Widespread, Pop-Up Drain with Tailpiece	Less Handles	*Brushed Nickel	
185184	K-72759-BV	Widespread, Pop-Up Drain with Tailpiece	Less Handles	*Brushed Bronze	
165049	K-72759-CP	Widespread, Pop-Up Drain with Tailpiece	Less Handles	Polished Chrome	
162835	K-72759-SN	Widespread, Pop-Up Drain with Tailpiece	Less Handles	*Polished Nickel	
184810	K-72759-VNT	Widespread, pop-Up Drain with Tailpiece	Less Handles	Vintage Nickel	
168450	K-72759-2BZ	Widespread, Pop-Up Drain with Tailpiece	Less Handles	Oil-Rubbed Bronze	

* Vibrant Limited Lifetime Warranty

www.plumbsupply.com • Serving our Customers Since 1946 • www.waterconcepts.net

Lavatory - Widespread

Artifacts® Column Design Stationary Spout with Aerator and Pop-Up Drain with 1-1/4" Tailpiece

- 6-5/8" Reach, 8-1/2" high spout
- Handles sold separately
- Laminar flow
- WaterSense® certified product: 1.2 gpm



Part #	Mfg #	Description	Handle(s)	Finish	Price
166094	K-72760-BN	Widespread, Pop-Up Drain with Tailpiece	Less Handles	*Brushed Nickel	
162838	K-72760-BV	Widespread, Pop-Up Drain with Tailpiece	Less Handles	*Brushed Bronze	
169554	K-72760-CP	Widespread, Pop-Up Drain with Tailpiece	Less Handles	Polished Chrome	
169988	K-72760-SN	Widespread, Pop-Up Drain with Tailpiece	Less Handles	*Polished Nickel	
176330	K-72760-2BZ	Widespread, Pop-Up Drain with Tailpiece	Less Handles	Oil-Rubbed Bronze	

Artifacts® Tea Design Stationary Spout with Aerator and Pop-Up Drain with 1-1/4" Tailpiece

- 5-3/8" Reach, 4-11/16" high spout
- Handles sold separately
- Laminar flow
- WaterSense® certified product: 1.5 gpm



Part #	Mfg #	Description	Handle(s)	Finish	Price
183652	K-72758-BN	Widespread, Pop-Up Drain with Tailpiece	Less Handles	*Brushed Nickel	
183653	K-72758-BV	Widespread, Pop-Up Drain with Tailpiece	Less Handles	*Brushed Bronze	
176273	K-72758-CP	Widespread, Pop-Up Drain with Tailpiece	Less Handles	Polished Chrome	
183654	K-72758-SN	Widespread, Pop-Up Drain with Tailpiece	Less Handles	*Polished Nickel	
162840	K-72758-2BZ	Widespread, Pop-Up Drain with Tailpiece	Less Handles	Oil-Rubbed Bronze	

Artifacts® Handles for Widespread Lavatory Faucets

- UltraGlide engineered ceramic disc valves



K-98068-3M Prong Handles



K-98068-4 Lever Handles



K-98068-9M Swing Lever Handles

Prong Handles

Part #	Mfg #	Description	Handle(s)	Finish	Price
162099	K-98068-3M-BN		Prong	*Brushed Nickel	
185185	K-98068-3M-BV		Prong	*Brushed Bronze	
166632	K-98068-3M-CP		Prong	Polished Chrome	
184813	K-98068-3M-VNT		Prong	Vintage Nickel	
162841	K-98068-3M-2BZ		Prong	Oil-Rubbed Bronze	

Lever Handles

Part #	Mfg #	Description	Handle(s)	Finish	Price
166095	K-98068-4-BN		Lever	*Brushed Nickel	

* Vibrant Limited Lifetime Warranty

www.waterconcepts.net • Serving our Customers Since 1946 • www.plumbsupply.com

Lavatory - Widespread

Two-Handle Widespread Lavatory Faucets (Continued)

Artifacts® Handles for Widespread Lavatory Faucets

Lever Handles

Part #	Mfg #	Description	Handle(s)	Finish	Price
176830	K-98068-4-BV		Lever	*Brushed Bronze	
165050	K-98068-4-CP		Lever	Polished Chrome	
162836	K-98068-4-SN		Lever	*Polished Nickel	
188089	K-98068-4-VNT		Lever	Vintage Nickel	
171400	K-98068-4-2BZ		Lever	Oil-Rubbed Bronze	

Swing Lever Handles

Part #	Mfg #	Description	Handle(s)	Finish	Price
162839	K-98068-9M-BV		Swing Lever	*Brushed Bronze	
170165	K-98068-9M-CP		Swing Lever	Polished Chrome	
169996	K-98068-9M-SN		Swing Lever	*Polished Nickel	
178609	K-98068-9M-2BZ		Swing Lever	Oil-Rubbed Bronze	

Bancroft™ 2-Hdl Lavatory Faucet for 8"-16" Centers with Pop-Up Drain, Lift Rod, and 1-1/4" Tailpiece

- 4-7/8" Reach spout
- Metal construction
- Brass valve bodies
- Flexible connections
- 1/4" turn washerless ceramic disc valves
- Flow rate: 1.2 gpm
- Meets EPA WaterSense® criteria



K-10577-4



K-10577-4P



Metal Lever Handles

Part #	Mfg #	Description	Handle(s)	Finish	Price
109356	K-10577-4-AF	8"-16"ws, Metal Drain	ADA Metal Lever	*French Gold	
096178	K-10577-4-BN	8"-16"ws, Metal Drain	ADA Metal Lever	*Brushed Nickel	
111078	K-10577-4-BV	8"-16"ws, Metal Drain	ADA Metal Lever	*Brushed Bronze	
087294	K-10577-4-CP	8"-16"ws, Metal Drain	ADA Metal Lever	Polished Chrome	
103486	K-10577-4-SN	8"-16"ws, Metal Drain	ADA Metal Lever	*Polished Nickel	
151325	K-10577-4-2BZ	8"-16"ws, Metal Drain	ADA Metal Lever	Oil-Rubbed Bronze	

Ceramic Lever Handles

Part #	Mfg #	Description	Handle(s)	Finish	Price
095470	K-10577-4P-BN	8"-16"ws, Metal Drain	ADA Ceramic Lever	*Brushed Nickel	
133082	K-10577-4P-BV	8"-16"ws, Metal Drain	ADA Ceramic Lever	*Brushed Bronze	
087742	K-10577-4P-CP	8"-16"ws, Metal Drain	ADA Ceramic Lever	Polished Chrome	
146100	K-10577-4P-SN	8"-16"ws, Metal Drain	ADA Ceramic Lever	*Polished Nickel	

* Vibrant Limited Lifetime Warranty

www.plumbsupply.com • Serving our Customers Since 1946 • www.waterconcepts.net

Lavatory - Widespread

Faucets & Valves

Composed™ 2-Hdl Lavatory Faucet for 8"-16" Centers with Metal Pop-Up Drain

- 5-15/16" Reach spout
- 3-7/8" From deck to aerator
- Metal construction
- Cross or lever handles
- Quick-connect hose
- Flow rate: 1.2 gpm



Part #	Mfg #	Description	Handle(s)	Finish	Price
224845	K-73060-3-CP	8"-16"ws, Metal Drain	ADA Cross	Polished Chrome	
224853	K-73060-4-CP	8"-16"ws, Metal Drain	ADA Level	Polished Chrome	

Coralais® Lavatory Faucet for 8"-16" Centers with Lever Handles

- 4-1/4" Reach spout
- Solid metal construction
- 1.2 GPM maximum flow rate
- Red/blue indexing on handles
- Handles pre-assembled on valves
- Quick-connect hose connectors
- UltraGlide engineered ceramic disc valves
- Model **(K-15261-4NDRA-CP)** does not include drain, lift rod, or tailpiece
- Meets EPA WaterSense® criteria



Part #	Mfg #	Description	Handle(s)	Finish	Price
188344	K-15265-4NDRA-CP	8"-16"ws, Red & Blue Indicators, Less Pop-Up Drain	ADA Lever	Polished Chrome	
226365	K-15261-4RA-G	8"-16"ws, Red & Blue Indicators, Pop-Up Drain	ADA Lever	Brushed Chrome	

Devonshire® 2-Hdl Lavatory Faucet for 8"-16" Centers

- 4-3/4" Reach spout
- Metal construction
- Brass valve bodies
- 1/4-Turn washerless ceramic disc valves
- WaterSense® certified product: 1.2 gpm



Part #	Mfg #	Description	Handle(s)	Finish	Price
146969	K-394-4-2BZ	8"-16"ws	ADA Lever	Oil Rubbed Bronze	
068213	K-394-4-BN	8"-16"ws	ADA Lever	*Brushed Nickel	
084602	K-394-4-BV	8"-16"ws	ADA Lever	*Brushed Bronze	
068212	K-394-4-CP	8"-16"ws	ADA Lever	Polished Chrome	
076829	K-394-4-PB	8"-16"ws	ADA Lever	*Polished Brass	
181953	K-394-4-SN	8"-16"ws	ADA Lever	*Polished Nickel	

* Vibrant Limited Lifetime Warranty

www.waterconcepts.net • Serving our Customers Since 1946 • www.plumbsupply.com

Lavatory - Widespread

Fairfax® 2-Hdl Lavatory Faucet for 8" - 16" Centers

- 5" Reach, 4-1/2" high spout
- Brass construction
- 1/4-Turn washerless ceramic valving
- WaterSense® certified product: 1.2 gpm



Part #	Mfg #	Description	Handle(s)	Finish	Price
057322	K-12265-4-BN	8"-16"ws,	ADA Lever	*Brushed Nickel	
053615	K-12265-4-CP	8"-16"ws,	ADA Lever	Polished Chrome	
127814	K-12265-4-2BZ	8"-16"ws,	ADA Lever	Oil-Rubbed Bronze	

Finial® Traditional Lavatory Faucet for 8" - 16" Centers with Metal Pop-Up Drain, Lift Rod, and Tailpiece

- 5" Reach, 6-1/4" high stationary spout
- Brass construction
- Brass valve bodies
- 1/4-Turn washerless ceramic disc valves
- Watersense® certified product: 1.2 gpm



Part #	Mfg #	Description	Handle(s)	Finish	Price
075051	K-310-4M-AF	8"-16"ws, Metal Pop-Up	ADA Lever	*French Gold	
056366	K-310-4M-BN	8"-16"ws, Metal Pop-Up	ADA Lever	*Brushed Nickel	
073511	K-310-4M-BV	8"-16"ws, Metal Pop-Up	ADA Lever	*Brushed Bronze	
054005	K-310-4M-CP	8"-16"ws, Metal Pop-Up	ADA Lever	Polished Chrome	
061723	K-310-4M-SN	8"-16"ws, Metal Pop-Up	ADA Lever	*Polished Nickel	
162512	K-310-4M-2BZ	8"-16"ws, Metal Pop-Up	ADA Lever	Oil-Rubbed Bronze	

Forté® 2-Hdl Lavatory Faucet for 8" - 16" Centers with Pop-Up Drain and Tailpiece

- 5-1/8" Reach stationary spout
- Metal construction, brass valve bodies
- Ceramic disc valves
- Fluid design lines
- Maximum flow rate: 1.2 gpm
- Meets EPA WaterSense® criteria



K-10272-4



K-10272-4A



Sculpted Lever Handles

Part #	Mfg #	Description	Handle(s)	Finish	Price
072960	K-10272-4-BN	8"-16"ws, Metal Drain	ADA Sculpted Lever	*Brushed Nickel	
069925	K-10272-4-CP	8"-16"ws, Metal Drain	ADA Sculpted Lever	Polished Chrome	
072247	K-10272-4-G	8"-16"ws, Metal Drain	ADA Sculpted Lever	Brushed Chrome	

Traditional Lever Handles

Part #	Mfg #	Description	Handle(s)	Finish	Price
074936	K-10272-4A-BN	8"-16"ws, Metal Drain	ADA Traditional Lever	*Brushed Nickel	
073410	K-10272-4A-CP	8"-16"ws, Metal Drain	ADA Traditional Lever	Polished Chrome	
074760	K-10272-4A-G	8"-16"ws, Metal Drain	ADA Traditional Lever	Brushed Chrome	

* Vibrant Limited Lifetime Warranty

www.plumbsupply.com • Serving our Customers Since 1946 • www.waterconcepts.net

Lavatory - Widespread

Faucets & Valves

Kelston® 2-Hdl Lavatory Faucet for 8" - 16" Centers with Pop-Up Drain and Tailpiece

- 4-1/2" Reach spout
- Brass construction and valve bodies
- Pop-up drain with tailpiece
- 1/4-Turn washerless ceramic disc valve
- Flow rate: 1.2 gpm



Part #	Mfg #	Description	Handle(s)	Finish	Price
146989	K-13491-4-2BZ	8"-16"cc	ADA Lever	Oil Rubbed Bronze	
124521	K-13491-4-BN	8"-16"cc	ADA Lever	*Brushed Nickel	
124937	K-13491-4-CP	8"-16"cc	ADA Lever	Polished Chrome	

Loure® 2-Hdl Lavatory Faucet for 8" - 16" Centers with Pop-Up Drain, Tailpiece and 8-1/4" Tall Spout

- 3-7/8" Reach spout
- Brass construction, brass valve bodies
- Fluid design lines
- WaterSense® certified product: 1.2 gpm
- 14-3/8" tall spout for (K-14662-4-CP) model



Part #	Mfg #	Description	Handle(s)	Finish	Price
144348	K-14661-4-BN	8"-16"cc, 8-1/4" Tall Spout	ADA Lever	*Brushed Nickel	
139112	K-14661-4-CP	8"-16"cc, 8-1/4" Tall Spout	ADA Lever	Polished Chrome	
142545	K-14661-4-SN	8"-16"cc, 8-1/4" Tall Spout	ADA Lever	*Polished Nickel	
173998	K-14662-4-CP	8"-16"cc, 14-3/8" Tall Spout	ADA Lever	Polished Chrome	

Margaux® 2-Hdl Lavatory Faucet for 8" - 16" Centers with Pop-Up Drain, Tailpiece, and Lift Rod

- 5-3/8" Reach stationary spout
- Brass construction, brass valve bodies
- Fluid design lines
- WaterSense® certified product: 1.2 gpm



K-16232-4

K-16232-3



Part #	Mfg #	Description	Handle(s)	Finish	Price
134192	K-16232-3-BN	8"cc	ADA Cross	*Brushed Nickel	
114264	K-16232-3-BV	8"cc	ADA Cross	*Brushed Bronze	
110486	K-16232-3-CP	8"cc	ADA Cross	Polished Chrome	
113684	K-16232-3-SN	8"cc	ADA Cross	*Polished Nickel	
133955	K-16232-4-AF	8"cc	ADA Lever	*French Gold	
109778	K-16232-4-BN	8"cc	ADA Lever	*Brushed Nickel	
122138	K-16232-4-BV	8"cc	ADA Lever	*Brushed Bronze	
107346	K162324CP	8"cc	ADA Lever	Polished Chrome	
135075	K-16232-4-SN	8"cc	ADA Lever	*Polished Nickel	

* Vibrant Limited Lifetime Warranty

www.waterconcepts.net • Serving our Customers Since 1946 • www.plumbsupply.com

Lavatory - Widespread

Memoirs® 2-Hdl Lavatory Faucet for 8" - 16" Centers with Pop-Up Drain, Lift Rod, and 1-1/4" Tailpiece

- 5" Reach stationary spout
- Brass construction, brass valve bodies
- 1/4" Turn washerless ceramic disc valves
- Two stately deco lever handles pre-assembled on valves
- Flexible connections
- Flow rate: 1.2 gpm



Part #	Mfg #	Description	Handle(s)	Finish	Price
074959	K-454-4V-BN	8"-16"ws	ADA Deco Lever	*Brushed Nickel	
077017	K-454-4V-BV	8"-16"ws	ADA Deco Lever	*Brushed Bronze	
077190	K-454-4V-CP	8"-16"ws	ADA Deco Lever	Polished Chrome	
170474	K-454-4V-2BZ	8"-16"ws	ADA Deco Lever	Oil-Rubbed Bronze	

Oblo® Lavatory Faucet for 8" - 16" Centers with Pop-Up Drain, Lift Rod, Tailpiece, and Two Oval Handles

- 5-7/16" Reach spout
- Metal construction, brass valve bodies
- Ceramic disc valves
- WaterSense® certified product: 1.2 gpm



Part #	Mfg #	Description	Handle(s)	Finish	Price
123664	K-10086-9-BN	8"-16"ws	Oval Handles	*Brushed Nickel	
130360	K-10086-9-CP	8"-16"ws	Oval Handles	Polished Chrome	

Oblo® Wall-Mount Lavatory Faucet with Valve and Two Oval Handles

- 7-1/8" Maximum spout reach
- Solid brass construction
- Flexible supply lines
- Ceramic disc valves
- Dual control wall-mounted
- WaterSense® certified product: 1.2 gpm



Part #	Mfg #	Description	Handle(s)	Finish	Price
172362	K-10087-9-BN	8" ws	Oval Handles	*Brushed Nickel	
133210	K-10087-9-CP	8" ws	Oval Handles	Polished Chrome	

Pinstripe® Pure 2-Hdl Lavatory Faucet for 8" - 16" Centers

- 5" Reach spout
- Low stationary spout
- Metal construction
- Brass valve bodies
- Pop-up drain with lift rod and tailpiece
- Quarter-turn washerless ceramic disc valves



Part #	Mfg #	Description	Handle(s)	Finish	Price
099065	K-13132-4A-CP	8"-16"ws	ADA Levers	Polished Chrome	
112661	K-13132-4A-SN	8"-16"ws	ADA Levers	*Polished Nickel	

* Vibrant Limited Lifetime Warranty

www.plumbsupply.com • Serving our Customers Since 1946 • www.waterconcepts.net

Lavatory - Widespread

Faucets & Valves

Purist® 2-Hdl Low Handle Lavatory Faucet with 8" - 16" Centers with Pop-Up Drain, Lift Rod, and Tailpiece

- 5-1/2" Reach spout, 8-1/2" height
- Brass construction, brass valve bodies
- Low gooseneck stationary spout
- Quarter-turn washerless ceramic disc valves
- Flow rate: 1.2 gpm



K-14406-4
Lever Handles



K-14406-3
Cross Handles



Part #	Mfg #	Description	Handle(s)	Finish	Price
170302	K-14406-3-BGD	8"-16"ws	Cross	*Modern Brushed Gold	
074666	K-14406-3-BN	8"-16"ws	Cross	*Brushed Nickel	
227809	K-14406-3-BV	8"-16"ws	Cross	*Brushed Bronze	
067401	K-14406-3-CP	8"-16"ws	Cross	Polished Chrome	
147218	K-14406-3-SN	8"-16"ws	Cross	*Polished Nickel	
179563	K-14406-4-BGD	8"-16"ws	ADA Lever	*Modern Brushed Gold	
084014	K-14406-4-BN	8"-16"ws	ADA Lever	*Brushed Nickel	
089431	K-14406-4-BV	8"-16"ws	ADA Lever	*Brushed Bronze	
069648	K-14406-4-CP	8"-16"ws	ADA Lever	Polished Chrome	
131007	K-14406-4-SN	8"-16"ws	ADA Lever	*Polished Nickel	

Purist® Lavatory Faucet for 8"- 16" Centers with Pop-Up Drain, Lift Rod, Tailpiece, and 2 High Handles

- 5-1/2" Reach, 8-1/2" height
- Brass construction, brass valve bodies
- Low gooseneck stationary spout
- Quarter-turn washerless ceramic disc valves
- Flow rate: 1.2 GPM



Part #	Mfg #	Description	Handle(s)	Finish	Price
093334	K-14407-3-BN	8"-16"ws	Cross	*Brushed Nickel	
107275	K-14407-3-BV	8"-16"ws	Cross	*Brushed Bronze	
099017	K-14407-3-CP	8"-16"ws	Cross	Polished Chrome	
090275	K-14407-3-SN	8"-16"ws	Cross	*Polished Nickel	
086386	K-14407-4-BN	8"-16"ws	ADA Lever	*Brushed Nickel	
154172	K-14407-4-BV	8"-16"ws	ADA Lever	*Brushed Bronze	
071838	K-14407-4-CP	8"-16"ws	ADA Lever	Polished Chrome	

Purist® and Lavatory Faucet for 8"- 16" Centers with Pop-Up Drain, Lift Rod, Tailpiece, and 2 Low Handles

- 5" Reach spout, 3-15/16" height
- Brass construction, Brass valve bodies
- Low gooseneck stationary spout
- Reversible quarter-turn washerless ceramic disc valves
- WaterSense® certified product: 1.2 gpm



K-14410-4



K-14410-3
Cross Handles



Part #	Mfg #	Description	Handle(s)	Finish	Price
080659	K-14410-3-BN	8"-16"ws	Cross	*Brushed Nickel	
099335	K-14410-3-CP	8"-16"ws	Cross	Polished Chrome	
073846	K-14410-4-BN	8"-16"ws	ADA Lever	*Brushed Nickel	

* Vibrant Limited Lifetime Warranty

www.waterconcepts.net • Serving our Customers Since 1946 • www.plumbsupply.com

Lavatory - Widespread

Two-Handle Widespread Lavatory Faucets (Continued)

Purist® and Lavatory Faucet for 8" - 16" Centers with Pop-Up Drain, Lift Rod, Tailpiece, and 2 Low Handles

Part #	Mfg #	Description	Handle(s)	Finish	Price
132502	K-14410-4-BV	8"-16"ws	ADA Lever	*Brushed Bronze	
076750	K-14410-4-CP	8"-16"ws	ADA Lever	Polished Chrome	
082407	K-14410-4-SN	8"-16"ws	ADA Lever	*Polished Nickel	

Purist® 2-Hdl Dual Controlled Wall-Mount Lavatory Faucet with Stationary Spout—Less Drain and Valve

- 8-1/4" 35° spout from wall to center of drain
- Brass construction
- Ceramic disc valves
- Fluid design lines
- Flow rate: 1.2 GPM



K-T14415-3-CP



K-T14415-4-CP



Faucets & Valves

Requires valve: K-410-K

Part #	Mfg #	Description	Handle(s)	Finish	Price
076197	K-T14415-3-BN	8"cc, Wall-mount	Cross	*Brushed Nickel	
093592	K-T14415-3-BV	8"cc, Wall-mount	Cross	*Brushed Bronze	
073309	K-T14415-3-CP	8"cc, Wall-mount	Cross	Polished Chrome	
090590	K-T14415-3-SN	8"cc, Wall-mount	Cross	*Polished Nickel	
080499	K-T14415-4-BN	8"cc, Wall-mount	ADA Lever	*Brushed Nickel	
093380	K-T14415-4-BV	8"cc, Wall-mount	ADA Lever	*Brushed Bronze	
069751	K-T14415-4-CP	8"cc, Wall-mount	ADA Lever	Polished Chrome	
092888	K-T14415-4-SN	8"cc, Wall-mount	ADA Lever	Polished Nickel	

Purist® 2-Hdl Dual Controlled Wall-Mount Lavatory Faucet with Stationary 90° Spout—Less Drain and Valve

- 9" Reach spout
- Brass construction
- Flow rate: 1.2 gpm



Part #	Mfg #	Description	Handle(s)	Finish	Price
113683	K-T14414-3-BN	8"cc, Wall-Mount	Cross	*Brushed Nickel	
222958	K-T14414-3-BGD	8"cc, Wall-Mount	Cross	*Moderne Brushed Gold	
169051	K-T14414-3-BV	8"cc, Wall-Mount	Cross	*Brushed Bronze	
167356	K-T14414-3-CP	8"cc, Wall-Mount	Cross	Polished Chrome	
096083	K-T14414-4-BN	8"cc, Wall-Mount	ADA Lever	*Brushed Nickel	
186403	K-T14414-4-BV	8"cc, Wall-Mount	ADA Lever	*Brushed Bronze	
098011	K-T14414-4-CP	8"cc, Wall-Mount	ADA Lever	Polished Chrome	

* Vibrant Limited Lifetime Warranty

www.plumbsupply.com • Serving our Customers Since 1946 • www.waterconcepts.net

Lavatory - Widespread

Faucets & Valves

Refinia® Lavatory Faucet for 8" - 16" Centers with Pop-Drain, Tailpiece, and Two Lever Handles

- 4-1/2" Reach spout
- Metal construction
- Quarter turn washerless ceramic disc valves
- Features UltraGlide Valve with Dry Stem technology
- Meets EPA WaterSense® criteria
- Maximum flow rate: 1.2 gpm



Part #	Mfg #	Description	Handle(s)	Finish	Price
141700	K-5317-4-BN	8"-16"ws, Pop-Up Drain with Tailpiece	ADA Lever	*Brushed Nickel	
141701	K-5317-4-CP	8"-16"ws, Pop-Up Drain with Tailpiece	ADA Lever	Polished Chrome	

Revival® Lavatory Faucet for 8" - 16" Centers with Pop-Up Drain, Tailpiece, and Two Lever Handles

- 5-1/4" Reach stationary spout, 4-1/8" height
- Brass construction, brass valve bodies
- Quarter-turn washerless ceramic disc valves
- Complements Revival® suite
- WaterSense certified product: 1.2 gpm



Part #	Mfg #	Description	Handle(s)	Finish	Price
054869	K-16102-4A-BN	8"-16"ws, Pop-Up Drain with Tailpiece	ADA Traditional Lever	*Brushed Nickel	
066584	K-16102-4A-BV	8"-16"ws, Pop-Up Drain with Tailpiece	ADA Traditional Lever	*Brushed Bronze	
053625	K-16102-4A-PB	8"-16"ws, Pop-Up Drain with Tailpiece	ADA Traditional Lever	Polished Brass	

Stillness® Lavatory Faucet for 8" - 16" Centers with Pop-Up Drain, Tailpiece, Liftrod, and Two Lever Handles

- 3-7/8" Reach stationary spout
- Brass construction, brass valve bodies
- Quarter-turn washerless ceramic disc valves
- Flow rate: 1.5 gpm



Part #	Mfg #	Description	Handle(s)	Finish	Price
066490	K-942-4-BN	8"-16"ws, Pop-Up Drain with Tailpiece	ADA Lever	*Brushed Nickel	
063698	K-942-4-CP	8"-16"ws, Pop-Up Drain with Tailpiece	ADA Lever	Polished Chrome	
082455	K-942-4-SN	8"-16"ws, Pop-Up Drain with Tailpiece	ADA Lever	*Polished Nickel	

Stillness® Laminar 2-Hdl Wall-Mount Lavatory Faucet Trim with Two Lever Handles—Less Drain

- 5-5/16" Reach spout
- Brass construction
- Flow rate: 2.0 gpm
- Requires two-handle ceramic valve [K-410-K]



Part #	Mfg #	Description	Handle(s)	Finish	Price
101643	K-T945-4-BN	8"ws, Less Drain	ADA Lever	*Brushed Nickel	
093585	K-T945-4-CP	8"ws, Less Drain	ADA Lever	Polished Chrome	

* Vibrant Limited Lifetime Warranty

www.waterconcepts.net • Serving our Customers Since 1946 • www.plumbsupply.com

Lavatory - Widespread

IV Georges Brass® Widespread Lavatory Faucet with High Country™ Swing Spout and Lever Handles

- 5" Reach, 11-7/8" high spout
- Brass construction, brass valve bodies
- Quarter-turn washerless ceramic disc valves.
- Metal pop-up drain with lift rod and tailpiece
- Flow rate: 1.2 gpm



Part #	Mfg #	Description	Handle(s)	Finish	Price
076960	K-6813-4-BN	8"-16"ws, Metal Pop-Up	ADA Lever	*Brushed Nickel	
182867	K-6813-4-BV	8"-16"ws, Metal Pop-Up	ADA Lever	*Brushed Bronze	
136917	K-6813-4-SN	8"-16"ws, Metal Pop-Up	ADA Lever	*Polished Nickel	

Single-Handle Widespread Lavatory Faucets

Loure® Tall Lavatory Faucet with Lever Handle and Touch-Activated Drain with Tailpiece and Overflow

- One-piece, self-contained ceramic disc valve
- 5-1/4" Reach spout
- Metal construction
- 2" Diameter valve
- Flow rate: 1.2 gpm



Part #	Mfg #	Description	Handle(s)	Finish	Price
141510	K-14660-4-BN	8"cc, 2-Hole	ADA Lever	*Brushed Nickel	
143000	K-14660-4-CP	8"cc, 2-Hole	ADA Lever	Polished Chrome	

Lavatory Rough-In Valves

Dual-Controlled Wall-Mount Lavatory Rough-In Valve

- Brass construction
- Quarter-turn ceramic disc valves
- Requires valve trim (sold separately)
- WaterSense compliant when paired with appropriate trim
- Maximum flow rate: 2.2 gpm @ 60 psi



Part #	Mfg #	Description	Price
062816	K-410-K-NA	2-Hdl Ceramic Valve	

* Vibrant Limited Lifetime Warranty

www.plumbsupply.com • Serving our Customers Since 1946 • www.waterconcepts.net

Lavatory Faucets - Widespread

Two-Handle Widespread Lavatory Faucets

Baliza® 2-Hdl Mini-Widespread Lavatory Faucets

- 5-1/16" Reach, 6-1/4" high spout
- 4-3/16" From deck to aerator
- 1-1/2" Maximum deck thickness
- Spout features hidden water-efficient aerator
- WaterSense® certified product: 1.5 gpm @ 60 psi



Handles Sold Separately

Requires HL505 or HX505 Handle Package

Part #	Mfg #	Description	Handle(s)	Finish	Price
173816	65505LF-PCLHP	3-Hole 4"cc, Metal Pop-Up	Less Handles	Chrome	
186748	65505LF-PNLHP	3-Hole 4" cc, Metal Pop-Up	Less Handle	Polished Nickel*	

Baliza® 2-Hdl Widespread Lavatory Faucet

- 5-5/16" Reach, 6-1/2" high spout
- 4-5/16" From deck to aerator
- 3" Maximum deck thickness
- Spout features hidden water-efficient aerator
- WaterSense® certified product: 1.5 gpm @ 60 psi



Handles Sold Separately

Requires HL505 or HX505 Handle Package

Part #	Mfg #	Description	Handle(s)	Finish	Price
141933	65305LF-BNLHP	3-Hole, Metal Pop-Up	Less Handles	Brushed Nickel*	
171321	65305LF-BZLHP	3-Hole, Metal Pop-Up	Less Handles	Brushed Bronze*	
144001	65305LF-PCLHP	3-Hole, Metal Pop-Up	Less Handles	Chrome	
159398	65305LF-PNLHP	3-Hole, Metal Pop-Up	Less Handles	Polished Nickel*	
139207	65305LF-RBLHP	3-Hole, Metal Pop-Up	Less Handles	Venetian Bronze®	

Charlotte™ 2-Hdl Widespread Lavatory Faucet

- 5" Reach, 7-3/8" high spout
- 5-5/8" From deck to aerator
- 2-1/2" Maximum deck thickness
- Spout features hidden water-efficient, laminar flow aerator
- WaterSense® certified product: 1.5 gpm @ 60 psi



Handles Sold Separately

Requires H5385 Handle Package

Part #	Mfg #	Description	Handle(s)	Finish	Price
180678	65385LF-BNLHP	3-Hole, Metal Pop-Up	Less Handles	Brushed Nickel*	
177588	65385LF-PCLHP	3-Hole, Metal Pop-Up	Less Handles	Chrome	
155365	65385LF-PNCOLHP	3-Hole, Metal Pop-Up	Less Handles	Cocoa Brz™/Pol Nickel	
144005	65385LF-PNLHP	3-Hole, Metal Pop-Up	Less Handles	Polished Nickel*	

* Brilliance® Anti-Tarnish Lifetime Finishes

www.waterconcepts.net • Serving our Customers Since 1946 • www.plumbsupply.com

Lavatory Faucets - Widespread

Litze™ 2-Hdl Widespread Lavatory Faucet

- 5-9/16" Reach, 7" high spout
- 5" From deck to aerator
- 2-1/2" Maximum deck thickness
- WaterSense® certified product: 1.5 gpm @ 60 psi



Handles Sold Separately
 Requires HL5334 or HL5332 Handle Package

Part #	Mfg #	Description	Handle(s)	Finish	Price
229517	65335LF-NKLHP	3-Hole, Metal Pop-Up	Less Handles	Luxe Nickel	

Odin™ 2-Hdl Widespread Lavatory Faucet

- 4-3/4" Reach, 9" high spout
- 6-1/8" From deck to aerator
- 2" Maximum deck thickness
- Spout features hidden water-efficient aerator
- WaterSense® certified product: 1.5 gpm @ 60 psi



Part #	Mfg #	Description	Handle(s)	Finish	Price
180052	65375LF-BN	3-Hole, Less Drain	ADA Lever	Brushed Nickel*	
157992	65375LF-PC	3-Hole, Less Drain	ADA Lever	Chrome	

Providence™ Classic 2-Hdl Widespread Lavatory Faucet

- 4-3/4" Reach, 7" high spout
- 4-3/4" From deck to aerator
- 1-1/8" Maximum deck thickness
- Order RP10612 for additional 1" mounting aids
- Handles sold separately
- WaterSense® certified product: 1.5 gpm @ 60 psi



Part #	Mfg #	Description	Handle(s)	Finish	Price
185169	6520LF-BNLHP	3 Hole,	Less Handles	Brushed Nickel*	
163846	6520LF-RBLHP	3-Hole	Less Handles	Venetian Bronze®	

Providence™ Belle 2-Hdl Widespread Lavatory Faucet

- 4-3/4" Reach, 7" high spout
- 4-3/4" From deck to aerator
- 1-1/8" Maximum deck thickness
- Order RP10612 for additional 1" mounting aids
- WaterSense® certified product: 1.5 gpm @ 60 psi



Handles Sold Separately
 Requires HK33, HK36 or HK37 Handle Package

Part #	Mfg #	Description	Handle(s)	Finish	Price
173259	6526LF-BNLHP	3-Hole	Less Handles	Brushed Nickel*	

* Brilliance® Anti-Tarnish Lifetime Finishes

www.plumbsupply.com • Serving our Customers Since 1946 • www.waterconcepts.net

Lavatory Faucets - Widespread

Faucets & Valves

Rook™ 2-Hdl Widespread Lavatory Faucet

- 5-3/4" Reach, 4-11/16" high spout
- 3" From deck to aerator
- 1/4" Turn handle stops
- 1/2-14 NPSM threaded inlets
- Flexible hose connections
- WaterSense® certified product: 1.5 gpm @ 60 psi



Handles Sold Separately

Requires HL5360 or HX5361 Handle Package

Part #	Mfg #	Description	Handle(s)	Finish	Price
178557	65360LF-NKBLLHP	3-Hole, Metal Pop-Up Drain	Less Handles	Luxe Nickel/Matte Black*	
185804	65360LF-NKLHP	3-Hole, Metal Pop-Up Drain	Less Handles	Luxe Nickel*	
222406	65360LF-RBLHP	3-Hole, Metal Pop-Up Drain	Less Handles	Venetian Bronze®	
227119	65361LF-NKLHP	3-Hole, Metal Pop-Up Drain w/ Channel Spout	Less Handles	Luxe Nickel	
223090	65361LF-NKBLLHP	3-Hole, Metal Pop-Up Drain w/ Channel Spout	Less Handles	Luxe Nickel/Matte Black*	
188956	65361LF-PCLHP	3-Hole, Metal Pop-Up Drain w/ Channel Spout	Less Handles	Chrome	

RSVP® Lavatory Faucet

- 5" Reach, 8" high spout
- 3-13/16" From deck to aerator
- Ceramic cartridge
- WaterSense® certified product: 1.20 gpm @ 60 psi



Handles sold separately

Requires HL5390 or HX5390 handle package

Part #	Mfg #	Description	Handle(s)	Finish	Price
145029	65390LF-BNLHP	3-Hole, Metal Pop-Up	Less Handles	Brushed Nickel*	
141152	65390LF-PCLHP	3-Hole, Metal Pop-Up	Less Handles	Chrome	

Siderna™ 2-Hdl Widespread Lavatory Faucet

- 6" Reach, 8-1/2" high spout
- 5-27/32" From deck to aerator
- 2-1/2" Maximum deck thickness
- Spout features hidden water-efficient, laminar flow aerator
- Handles feature neodymium rare earth magnets to simplify installation and provide secure, flush fit
- WaterSense® certified product: 1.5 gpm @ 60 psi



Handles Sold Separately

Requires HL5380, HL5382 or HL5381 Handle Package

Part #	Mfg #	Description	Handle(s)	Finish	Price
162474	65380LF-BLLHP	3-Hole, Less Drain	Less Handles	Matte Black	
155285	65380LF-BNLHP	3-Hole, Less Drain	Less Handles	Brushed Nickel*	
166141	65380LF-PCLHP	3-Hole, Less Drain	Less Handles	Chrome	

* Brilliance® Anti-Tarnish Lifetime Finishes

www.waterconcepts.net • Serving our Customers Since 1946 • www.plumbsupply.com

Lavatory Faucets - Widespread

Sotria™ 2-Hdl Widespread Lavatory Faucet

- 5-3/4" Reach, 5-13/32" high spout
- 4-1/2" From deck to aerator
- 2-1/2" Maximum deck thickness
- Handles feature neodymium rare earth magnets to simplify installation and provide secure, flush kit
- WaterSense® certified product: 1.5 gpm @ 60 psi



Part #	Mfg #	Description	Handle(s)	Finish	Price
222393	65350LF-PC	3-Hole Installation, Metal Pop-Up	ADA Lever	Chrome	
177372	65350LF-BL	3-Hole Installation, Metal Pop-Up	ADA Lever	Matte Black	
173228	65350LF-NK	3-Hole Installation, Metal Pop-Up	ADA Lever	Luxe Nickel*	
179424	65350LF-PN	3-Hole Installation, Metal Pop-Up	ADA Lever	Polished Nickel*	

Sotria™ 2-Hdl Widespread Lavatory Faucet with Channel Spout

- 5-19/32" Reach, 5-21/64" high spout
- 3-15/16" From deck to aerator
- 2-1/2" Maximum deck thickness
- 1/4 Turn handle stops
- WaterSense® certified product: 1.5 gpm @ 60 psi



Part #	Mfg #	Description	Handle(s)	Finish	Price
182225	65351LF-BL	3-Hole, Channel Spout, Metal Pop-Up	ADA Lever	Matte Black	
180762	65351LF-NK	3-Hole, Channel Spout, Metal Pop-Up	ADA Lever	Luxe Nickel*	
179425	65351LF-PN	3-Hole, Channel Spout, Metal Pop-Up	ADA Lever	Polished Nickel*	

Tresa® 2-Hdl Widespread Lavatory Faucet

- 6-1/2" Reach, 7-1/2" high spout
- 4-3/16" From deck to aerator
- 2-1/4" Maximum deck thickness
- Spout features hidden water-efficient aerator
- WaterSense® certified product: 1.5 gpm @ 60 psi



Part #	Mfg #	Description	Handle(s)	Finish	Price
155248	65336LF-PC	3-Hole, Metal Pop-Up	ADA Lever	Chrome	
172780	65336LF-PN	3-Hole, Metal Pop-Up	ADA Lever	Polished Nickel*	
145562	65336LF-RB	3-Hole, Metal Pop-Up	ADA Lever	Venetian Bronze®	
130947	65338LF-BN	3-Hole, Metal Pop-Up	ADA Cross	Brushed Nickel*	
119045	65338LF-PC	3-Hole, Metal Pop-Up	ADA Cross	Chrome	
174833	65338LF-PN	3-Hole, Metal Pop-Up	ADA Cross	Polished Nickel*	
120624	65338LF-RB	3-Hole, Metal Pop-Up	ADA Cross	Venetian Bronze®	

* Brilliance® Anti-Tarnish Lifetime Finishes

www.plumbsupply.com • Serving our Customers Since 1946 • www.waterconcepts.net

Lavatory Faucets - Widespread

Tresa® 2-Hdl Widespread Bridge Lavatory Faucet

- 6-1/2" Reach, 9-1/4" high spout
- 5-1/2" From deck to aerator
- 3" Maximum deck thickness
- Spout features hidden water-efficient aerator
- Includes optional decorative center hole cover
- Drain sold separately
- WaterSense® certified product: 1.5 gpm @ 60 psi



Part #	Mfg #	Description	Handle(s)	Finish	Price
188609	65536LF-BN	2- or 3-Hole, Less Drain 7" Reach	ADA Cross	Brushed Nickel*	
175059	65538LF-BN	2- or 3-Hole, Less Drain	ADA Cross	Brushed Nickel*	
134901	65538LF-PC	2- or 3-Hole, Less Drain	ADA Cross	Chrome	
171918	65538LF-PN	2- or 3-Hole, Less Drain	ADA Cross	Polished Nickel*	
174389	65538LF-RB	2- or 3-Hole, Less Drain	ADA Cross	Venetian Bronze®	

Vesi® Curve 2-Hdl Widespread Lavatory Faucet

- 5-1/4" Reach, 4-1/4" high spout
- 2-1/8" From deck to aerator
- 1-1/8" Maximum deck thickness
- Order RP10612 for additional 1" mounting aids
- WaterSense® certified product: 1.5 gpm @ 60 psi



Part #	Mfg #	Description	Handle(s)	Finish	Price
129689	65340LF-BN	3-Hole, Metal Pop-Up	ADA Lever	Brushed Nickel*	
142835	65340LF-BZ	3-Hole, Metal Pop-Up	ADA Lever	Brushed Bronze*	
156801	65340LF-PC	3-Hole, Metal Pop-Up	ADA Lever	Chrome	
185767	65340LF-RB	3-Hole, Metal Pop-Up	ADA Lever	Venetian Bronze®	

Vesi® Channel 2-Hdl Widespread Lavatory Faucet

- 5-1/4" Reach, 4-1/4" high spout
- 1-3/4" From deck to aerator
- 1-1/8" Maximum deck thickness
- Order RP10612 for additional 1" mounting aids
- WaterSense® certified product: 1.5 gpm @ 60 psi



Part #	Mfg #	Description	Handle(s)	Finish	Price
130804	65345LF-BN	3-Hole, Metal Pop-Up	ADA Lever	Brushed Nickel*	
130243	65345LF-BZ	3-Hole, Metal Pop-Up	ADA Lever	Brushed Bronze*	
130971	65345LF-PC	3-Hole, Metal Pop-Up	ADA Lever	Chrome	
172035	65345LF-RB	3-Hole, Metal Pop-Up	ADA Lever	Venetian Bronze®	

* Brilliance® Anti-Tarnish Lifetime Finishes

www.waterconcepts.net • Serving our Customers Since 1946 • www.plumbsupply.com

Lavatory Faucets - Widespread

Virage® 2-Hdl Widespread Lavatory Faucet

- 5-9/16" Reach, 7-27/32" high spout
- 4-7/8" From deck to aerator
- WaterSense® certified product: 1.5 gpm @ 60 psi



Part #	Mfg #	Description	Handle(s)	Finish	Price
133559	65330LF-BN	3-Hole, Metal Pop-Up	ADA Lever	Brushed Nickel*	
136563	65330LF-BZ	3-Hole, Metal Pop-Up	ADA Lever	Brushed Bronze*	
129978	65330LF-PC	3-Hole, Metal Pop-Up	ADA Lever	Chrome	
134903	65330-LF-PN	3-Hole, Metal Pop-Up	ADA Lever	Polished Nickel*	
137491	65330-LF-RB	3-Hole, Metal Pop-Up	ADA Lever	Venetian Bronze®	

Widespread Vessel Faucets

Charlotte™ 2-Hdl Widespread Vessel Faucet

- 5" Reach, 12-3/4" high spout
- 11" From deck to aerator
- 2-1/2" Maximum deck thickness
- Spout features hidden water-efficient, laminar flow aerator
- WaterSense® certified product: 1.5 gpm @ 60 psi



Handles Sold Separately

Requires HL5485 Handle Package

Part #	Mfg #	Description	Handle(s)	Finish	Price
166543	65485LF-BNLHP	3-Hole, Grid Strainer	Less Handles	Brushed Nickel*	
159769	65485LF-PNCOLHP	3-Hole, Grid Strainer	Less Handles	Cocoa Brz™/Pol Nickel	

RSVP® 2-hdl Widespread Vessel Faucet

- 5" Reach, 13" high spout
- 9-13/16" From deck to aerator
- Spout features hidden water-efficient, laminar flow aerator
- Additional decorative finial's available
- WaterSense® certified product: 1.5 gpm @ 60 psi



Handles Sold Separately

Requires HL5790 or HX5790 Handle Package

Part #	Mfg #	Description	Handle(s)	Finish	Price
165647	65790LF-PCLHP	3-Hole, Less Drain	Less Handles	Chrome	

* Brilliance® Anti-Tarnish Lifetime Finishes

www.plumbsupply.com • Serving our Customers Since 1946 • www.waterconcepts.net

Lavatory Faucets - Widespread

Virage® 2-Hdl Widespread Vessel Faucet

- 5-9/16" Reach, 12-11/32" high spout
- 9-9/16" From deck to aerator
- 3" Maximum deck thickness
- Spout features hidden water-efficient, laminar flow aerator
- WaterSense® certified product: 1.5 gpm @ 60 psi



Part #	Mfg #	Description	Handle(s)	Finish	Price
135948	65430LF-BN	3-Hole, Grid Drain	ADA Lever	Brushed Nickel*	
160243	65430LF-PC	3-Hole, Grid Drain	ADA Lever	Chrome	
131327	65430LF-RB	3-Hole, Grid Drain	ADA Lever	Venetian Bronze®	

Wall-Mount Lavatory Faucets

Charlotte™ 2-Hdl Wall-Mount Vessel Faucet

- 8-1/4" Spout reach
- 1-1/2" Hole size
- Adjustable roughing in dimensions: 2-1/8" to 3-1/4"
- 1/2" IPS inlets
- WaterSense® certified product: 1.5 gpm @ 60 psi



Handles Sold Separately

Requires HL5885 Handle Package

Part #	Mfg #	Description	Handle(s)	Finish	Price
175355	65885LF-BNLHP	3-Hole, Grid Drain	Less Handles	Brushed Nickel*	
147185	65885LF-PNCOLHP	3-Hole, Grid Drain	Less Handles	Cocoa Brz™/Pol Nickel	

Odin™ 2-Hdl Wall-Mount Vessel Faucet

- 8-1/2" Spout length
- Spout features hidden water-efficient, laminar flow aerator
- 3-1/4" Maximum deck thickness
- WaterSense® certified product: 1.5 gpm @ 60 psi



Part #	Mfg #	Description	Handle(s)	Finish	Price
169579	65875LF-BL	3-Hole, Less Drain	ADA Lever	Matte Black	
222154	65875LF-BN	3-Hole, Less Drain	ADA Lever	Brushed Nickel*	
182728	65875LF-PC	3-Hole, Less Drain	ADA Lever	Chrome	

* Brilliance® Anti-Tarnish Lifetime Finishes

www.waterconcepts.net • Serving our Customers Since 1946 • www.plumbsupply.com

Lavatory Faucets - Widespread

Siderna™ 2-Hdl Wall-Mount Vessel Faucet

- 6-3/4" - 8-1/2" Adjustable spout reach
- 3-1/2" Maximum deck thickness
- Spout features hidden water-efficient, laminar flow aerator
- WaterSense® certified product: 1.5 gpm @ 60 psi



Handles Sold Separately

Requires HL5880, HL5881, or HL5882 Handle Package

Part #	Mfg #	Description	Handle(s)	Finish	Price
158692	65880LF-BNLHP	3-Hole, Less Drain	Less Handles	Brushed Nickel*	
166848	65880LF-PCLHP	3-Hole, Less Drain	Less Handles	Chrome	

Sotria™ 2-Hdl Wall-Mount Vessel Faucet

- 8-7/16" Reach
- 1-1/2" Recommended hole size
- Rough-in dimensions: 2-1/8" to 3-1/2"
- 1/2" IPS inlets
- WaterSense® certified product: 1.5 gpm @ 60 psi



Requires Rough-In Valve: R65800

Part #	Mfg #	Description	Handle(s)	Finish	Price
177245	T65851LF-NK	3-Hole, Less drain	ADA Lever	Polished Nickel*	
180634	T65851LF-PC	3-Hole, Less drain	ADA Lever	Chrome	

Tresa® 2-Hdl Wall-Mount Lavatory Faucet

- 7" Spout reach
- 1-1/8" Maximum wall thickness
- WaterSense® certified product



Part #	Mfg #	Description	Handle(s)	Finish	Price
173166	65836LF-BN	3-Hole, Grid Drain	ADA Lever	Brushed Nickel*	
174016	65836LF-PC	3-Hole, Grid Drain	ADA Lever	Chrome	
146635	65836LF-RB	3-Hole, Grid Drain	ADA Lever	Venetian Bronze®	

Virage® 2-Hdl Wall-Mount Vessel Faucet

- 8-1/2" Spout reach
- 1-1/2" Recommended hole size
- Rough-in dimensions: 2-1/8" to 3-1/2"
- 1/2" IPS inlets
- WaterSense® certified product: 1.5 gpm @ 60 psi



Part #	Mfg #	Description	Handle(s)	Finish	Price
188544	65830LF-BZ	3-Hole, Less Drain	ADA Lever	Brushed Bronze*	

* Brilliance® Anti-Tarnish Lifetime Finishes

www.plumbsupply.com • Serving our Customers Since 1946 • www.waterconcepts.net

Lavatory Faucets - 8" Center

Faucets & Valves

Two-Handle Widespread Lavatory Faucets

Addison™ 2-Hdl Widespread Lavatory Faucet

- 5" Reach, 6-5/8" high rigid spout
- 4-1/2" From deck to aerator
- 1/2" IPS Connection
- 1-1/16" Maximum deck thickness
- WaterSense® certified product, 1.2 gpm @ 60 psi



Part #	Mfg #	Description	Handle(s)	Finish	Price
131027	3592LF	3-Hole 6"-16"ws, Metal Pop-Up Drain, Lead-Free	ADA Lever	Chrome	
138277	3592LF-CZ	3-Hole 6"-16"ws, Metal Pop-Up Drain, Lead-Free	ADA Lever	Champagne Bronze™	
145414	3592LF-RB	3-Hole 6"-16"ws, Metal Pop-Up Drain, Lead-Free	ADA Lever	Venetian Bronze®	
147552	3592LF-SS	3-Hole 6"-16"ws, Metal Pop-Up Drain, Lead-Free	ADA Lever	Stainless*	

Ara™ 2-Hdl Widespread Lavatory Faucet

- 5-3/8" Reach, 4-3/16" high rigid spout
- 3-3/16" From deck to aerator
- Red/blue indicators
- 3/8" Compression fittings
- 2-1/4" Maximum deck thickness
- 32" Minimum InnoFlex® supply lines below the deck
- DIAMOND™ Valve
- WaterSense® certified product: 1.2 gpm @ 60 psi



Part #	Mfg #	Description	Handle(s)	Finish	Price
165651	3567-MPU-DST	3-Hole 4-16"ws, Metal Pop-Up Drain, Lead-Free	ADA Lever	Chrome	
162242	3567-SSMPU-DST	3-Hole 4-16"ws Metal Pop-Up Drain, Lead-Free	ADA Lever	Stainless*	

Ara™ 2-Hdl Channel Spout Widespread Lavatory Faucet

- 5-1/8" Reach, 4-3/16" rigid spout
- 3-3/16" From deck to aerator
- Red/blue indicators
- 3/8" Compression fittings
- 2-1/4" Maximum deck thickness
- 32" Minimum InnoFlex® supply lines below the deck
- DIAMOND™ valve
- WaterSense® certified product: 1.2 gpm @ 60 psi



Part #	Mfg #	Description	Handle(s)	Finish	Price
165655	3568LF-MPU	3-Hole 4-16"ws, Metal Pop-Up Drain, Lead-Free	ADA Lever	Chrome	
165881	3568LF-SSMPU	3-Hole 4-16"ws, Metal Pop-Up Drain, Lead-Free	ADA Lever	Stainless*	

* Brilliance® Anti-Tarnish Lifetime Finishes

www.waterconcepts.net • Serving our Customers Since 1946 • www.plumbsupply.com

Lavatory Faucets - 8" Center

Arzo® 2-Hdl Widespread Lavatory Faucet

- 4-1/2" Reach, 4-3/4" high rigid spout
- 3-3/4" From deck to aerator
- Hot/cold indicators
- 3/8" Compression fittings
- 1/2" IPS Connection
- 1-1/8" Maximum deck thickness
- WaterSense® certified product, 1.2 gpm @ 60 psi



Part #	Mfg #	Description	Handle(s)	Finish	Price
131763	3586LF-MPU	3-Hole 6-16"ws, Metal Pop-Up Drain, Lead-Free	ADA Lever	Chrome	
130574	3586LF-SSMPU	3-Hole 6-16"ws, Metal Pop-Up Drain, Lead-Free	ADA Lever	Stainless*	

Ashlyn™ 2-Hdl Widespread Lavatory Faucet

- 5-1/8" Reach, 5-1/4" high rigid spout
- 4-1/8" From deck to aerator
- Red/blue indicators
- 3/8" Compression fittings
- 2-1/4" Maximum deck thickness
- 32" Minimum InnoFlex® supply lines below the deck
- Optional gray/black set screw covers included
- 1-1/4" Minimum hole size to install EZAnchor™ top down mounting
- DIAMOND™ Valve
- WaterSense® certified product: 1.2 gpm @ 60 psi



Part #	Mfg #	Description	Handle(s)	Finish	Price
172337	3564-MPU-DST	3-Hole 4-1/2"-16"ws, MPU Drain, Lead Free	ADA Lever	Chrome	
171445	3564-RBMPU-DST	3-Hole 4-1/2"-16"ws, MPU Drain, Lead Free	ADA Lever	Venetian Bronze®	
170922	3564-SSMPU-DST	3-Hole 4-1/2"-16"ws, MPU Drain, Lead Free	ADA Lever	Stainless*	

Cassidy™ 2-Hdl Widespread Lavatory Faucet

- 5-13/32" Reach, 5-13/16" high rigid spout
- 4-5/16" From deck to aerator
- 1/2" IPS Connection
- 1-3/32" Maximum deck thickness
- WaterSense® certified product: 1.2 gpm @ 60 psi
- LHP - Less handle program (sold separately)
- **Handles sold separately for -LHP models**
 - (H295 cross, H297 traditional lever, H298 decorative)



Part #	Mfg #	Description	Handle(s)	Finish	Price
152744	3597LF-CZMPU	3-Hole 6-16"ws, Metal Pop-Up Drain, Lead-Free	ADA Lever	Champagne Bronze™	
152775	3597LF-CZMPU-LHP	3-Hole 6-16"ws, Metal Pop-Up Drain, Lead-Free	Less Handles	Champagne Bronze™	
152743	3597LF-MPU	3-Hole 6-16"ws, Metal Pop-Up Drain, Lead-Free	ADA Lever	Chrome	
151499	3597LF-MPU-LHP	3-Hole 6-16"ws, Metal Pop-Up Drain, Lead-Free	Less Handles	Chrome	
188303	3597LF-PNMPU	3-Hole 6-16"ws, Metal Pop-Up Drain, Lead-Free	ADA Lever	Polished Nickel*	
160503	3597LF-PNMPU-LHP	3-Hole 6-16"ws, Metal Pop-Up Drain, Lead-Free	Less Handles	Polished Nickel*	

* Brilliance® Anti-Tarnish Lifetime Finishes

www.plumbsupply.com • Serving our Customers Since 1946 • www.waterconcepts.net

Lavatory Faucets - 8" Center

Two-Handle Widespread Lavatory Faucets (Continued)

Cassidy™ 2-Hdl Widespread Lavatory Faucet

Part #	Mfg #	Description	Handle(s)	Finish	Price
151693	3597LF-RBMPU	3-Hole 6-16"ws, Metal Pop-Up Drain, Lead-Free	ADA Lever	Venetian Bronze®	
150953	3597LF-RBMPU-LHP	3-Hole 6-16"ws, Metal Pop-Up Drain, Lead-Free	Less Handles	Venetian Bronze®	
151696	3597LF-SSMPU	3-Hole 6-16"ws, Metal Pop-Up Drain, Lead-Free	ADA Lever	Stainless*	
152776	3597LF-SSMPU-LHP	3-Hole 6-16"ws, Metal Pop-Up Drain, Lead-Free	Less Handles	Stainless*	

Cassidy™ 2-Hdl Low Arc Spout Widespread Lavatory Faucet

- 5-17/32" Reach, 4-1/32" high rigid spout
- 2-3/4" From deck to aerator
- 1/2" IPS Connection
- 1-3/32" Maximum deck thickness
- WaterSense® certified product: 1.2 gpm @ 60 psi
- **Handles sold separately**
- (H295 cross, H297 traditional lever, H298 decorative)



Part #	Mfg #	Description	Handle(s)	Finish	Price
152773	3595LF-CZMPU-LHP	3-Hole 6-16"ws, Metal Pop-Up Drain, Lead-Free	Less Handles	Champagne Bronze™	
151991	3595LF-MPU-LHP	3-Hole 6-16"ws, Metal Pop-Up Drain, Lead-Free	Less Handles	Chrome	
157705	3595LF-PNMPU-LHP	3-Hole 6-16"ws, Metal Pop-Up Drain, Lead-Free	Less Handles	Polished Nickel*	
152371	3595LF-RBMPU-LHP	3-Hole 6-16"ws, Metal Pop-Up Drain, Lead-Free	Less Handles	Venetian Bronze®	
152774	3595LF-SS-MPU-LH	3-Hole 6-16"ws, Metal Pop-Up Drain, Lead-Free	Less Handles	Stainless*	

Classic 2-Hdl Widespread Lavatory Faucet

- 5-1/4" Reach, 3-7/8" high rigid spout
- 2-3/8" From deck to aerator
- 1/2" IPS connection
- 1-1/8" Maximum deck thickness
- WaterSense® certified product: 1.52 gpm @ 60 psi



Part #	Mfg #	Description	Handle(s)	Finish	Price
152536	3530LF-MPU	3-Hole, 6-16"ws, Metal Pop-up Drain, Lead Free	ADA Lever	Chrome	
154425	3530LF-SSMPU	3-Hole, 6-16"ws, Metal Pop-up Drain, Lead Free	ADA Lever	Stainless*	
003996	3544LF-WFMPU	3-Hole, 6-16"ws, Metal Pop-up Drain, Lead Free	Clear Knobs	Chrome	

* Brilliance® Anti-Tarnish Lifetime Finishes

www.waterconcepts.net • Serving our Customers Since 1946 • www.plumbsupply.com

Lavatory Faucets - 8" Center

Compel™ 2-Hdl Widespread Lavatory Faucet

- 6-7/16" Reach, 7-3/8" high rigid spout
- 3-3/16" From deck to aerator
- Stream shaper
- Red/blue indicators
- 3/8" Compression fittings
- 2-1/4" Maximum deck thickness
- 32" Minimum InnoFlex® supply lines below the deck
- DIAMOND™ Valve
- WaterSense certified product: 1.2 gpm @ 60 psi



Part #	Mfg #	Description	Handle(s)	Finish	Price
150797	3561-MPU-DST	3-Hole, 4-16"ws, Metal Pop-Up, Lead Free	ADA Lever	Chrome	
152793	3561-SSMPU-DST	3-Hole, 4-16"ws, Metal Pop-Up, Lead Free	ADA Lever	Stainless*	

Dryden™ 2-Hdl Widespread Lavatory Faucet

- 4-11/16" Reach, 6-1/4" high rigid spout
- 3-3/4" From deck to aerator
- 1/2" IPS Connection
- 1-1/8" Maximum deck thickness
- WaterSense® certified product: 1.2 gpm @ 60 psi



Part #	Mfg #	Description	Handle(s)	Finish	Price
145759	3551LF	3-Hole 6-16"ws, Metal Pop-Up Drain, Lead-Free	ADA Lever	Chrome	
146205	3551LF-CZ	3-Hole 6-16"ws, Metal Pop-Up Drain, Lead-Free	ADA Lever	Champagne Bronze™	
171145	3551LF-PN	3-Hole 6-16"ws, Metal Pop-Up Drain, Lead-Free	ADA Lever	Polished Nickel*	
145760	3551LF-RB	3-Hole 6-16"ws, Metal Pop-Up Drain, Lead-Free	ADA Lever	Venetian Bronze®	
145761	3551LF-SS	3-Hole 6-16"ws, Metal Pop-Up Drain, Lead-Free	ADA Lever	Stainless*	

Haywood™ 2-Hdl Widespread Lavatory Faucet

- 5-1/16" Reach, 4-1/8" high rigid spout
- 2-1/2" From deck to aerator
- Quick-Snap® installation
- 3/8" O.D. copper supply tubes
- WaterSense® certified product: 1.2 gpm @ 60 psi



Part #	Mfg #	Description	Handle(s)	Finish	Price
220854	35999LF	3-Hole 6-16"ws, Plastic Pop-Up Drain, Lead-Free	ADA Lever	Chrome	

* Brilliance® Anti-Tarnish Lifetime Finishes

www.plumbsupply.com • Serving our Customers Since 1946 • www.waterconcepts.net

Lavatory Faucets - 8" Center

Faucets & Valves

Lahara™ 2-Hdl Widespread Lavatory Faucet

- 5" Reach, 5-7/8" high rigid spout
- 3-5/8" From deck to aerator
- 3/8" Compression fittings
- 2-1/4" Maximum deck thickness
- 32" Minimum InnoFlex® supply lines below the deck
- DIAMOND™ valve
- WaterSense® certified product, 1.2 gpm @ 60 psi



Part #	Mfg #	Description	Handle(s)	Finish	Price
161970	3538-CZMPU-DST	3-Hole 4-16"ws, Metal Pop-Up Drain, Lead-Free	ADA Lever	Champagne Bronze™	
154151	3538-MPU-DST	3-Hole 4-16"ws, Metal Pop-Up Drain, Lead-Free	ADA Lever	Chrome	
150464	3538-RBMPU-DST	3-Hole 4-16"ws, Metal Pop-Up Drain, Lead-Free	ADA Lever	Venetian Bronze®	
153972	3538-SSMPU-DST	3-Hole 4-16"ws, Metal Pop-Up Drain, Lead-Free	ADA Lever	Stainless*	

Linden™ 2-Hdl Widespread Lavatory Faucet

- 4-7/8" Reach, 5-1/8" high rigid spout
- 3-7/8" From deck to aerator
- 3/8" Compression fittings
- 2-1/4" Maximum deck thickness
- 32" Minimum InnoFlex® supply lines below the deck
- DIAMOND® Valve
- WaterSense® certified product: 1.2 gpm @ 60 psi



3594

3593

Part #	Mfg #	Description	Handle(s)	Finish	Price
222861	3593-MPU-DST	3-Hole 4-16"ws, Metal Pop-Up Drain, Lead-Free	ADA Lever	Chrome	
224690	3593-RBMPU-DST	3-Hole 4-16"ws, Metal Pop-Up Drain, Lead-Free	ADA Lever	Venetian Bronze®	
225507	3593-SSMPU-DST	3-Hole 4-16"ws, Metal Pop-Up Drain, Lead-Free	ADA Lever	Stainless*	
171887	3594-CZMPU-DST	3-Hole 4-16"ws, Metal Pop-Up Drain, Lead-Free	ADA Lever	Champagne Bronze™	
175373	3594-MPU-DST	3-Hole 4-16"ws, Metal Pop-Up Drain, Lead-Free	ADA Lever	Chrome	
167041	3594-RBMPU-DST	3-Hole 4-16"ws, Metal Pop-Up Drain, Lead-Free	ADA Lever	Venetian Bronze®	
157476	3594-SSMPU-DST	3-Hole 4-16"ws, Metal Pop-Up Drain, Lead-Free	ADA Lever	Stainless*	

Tesla™ 2-Hdl Widespread Lavatory

- 4-5/8" Reach, 6-1/16" high rigid spout
- 5-3/16" From deck to aerator
- Red/blue indicators
- 3/8" Compression fittings
- 2-1/4" Maximum deck thickness
- 32" Minimum InnoFlex® supply lines below the deck
- DIAMOND® Valve
- WaterSense® certified product: 1.2 gpm @ 60 psi



Part #	Mfg #	Description	Handle(s)	Finish	Price
184422	3552-MPU-DST	3-Hole 4-16"ws, Metal Pop-Up Drain, Lead Free	ADA Lever	Chrome	
181115	3552-SSMPU-DST	3-Hole 4-16"ws, Metal Pop-Up Drain, Lead Free	ADA Lever	Stainless*	
229497	3552-PNMPU-DST	3-Hole 4-16"ws, Metal Pop-Up Drain, Lead Free	ADA Lever	Polished Nickel	

* Brilliance® Anti-Tarnish Lifetime Finishes

www.waterconcepts.net • Serving our Customers Since 1946 • www.plumbsupply.com

Lavatory Faucets - 8" Center

Trinsic® 2-Hdl Widespread Lavatory Faucet

- 5" Reach, 7-3/4" high rigid spout
- 4-15/16" From deck to aerator
- Red/blue indicators
- 3/8" Compression fittings
- 2-1/4" Maximum deck thickness
- 32" Minimum InnoFlex® supply lines below the deck included
- DIAMOND™ Valve
- WaterSense® certified product: 1.2 gpm @ 60 psi



Part #	Mfg #	Description	Handle(s)	Finish	Price
152802	3559-CZMPU-DST	3-Hole 4-16"ws, Metal Pop-Up, Lead Free	ADA Lever	Champagne Bronze™	
152801	3559-MPU-DST	3-Hole 4-16"ws, Metal Pop-Up, Lead Free	ADA Lever	Chrome	
152803	3559-RBMPU-DST	3-Hole 4-16"ws, Metal Pop-Up, Lead Free	ADA Lever	Venetian Bronze®	
152804	3559-SSMPU-DST	3-Hole 4-16"ws, Metal Pop-Up, Lead Free	ADA Lever	Stainless*	

Vero™ 2-Hdl Widespread Lavatory Faucet

- 4-25/32" Reach, 6-3/8" high rigid spout
- 2-5/8" From deck to spout
- Stream straightener
- 1/2" IPS Connection
- 1-1/8" Maximum deck thickness
- WaterSense® certified product: 1.2 gpm @ 60 psi



Part #	Mfg #	Description	Handle(s)	Finish	Price
134769	3553LF	3-Hole 6-16"ws, Metal Push Pop-Up Drain, LF	ADA Lever	Chrome	
161458	3553LF-CZ	3-Hole 6-16"ws, Metal Push Pop-Up Drain, LF	ADA Lever	Champagne Bronze™	
145309	3553LF-RB	3-Hole 6-16"ws, Metal Push Pop-Up Drain, LF	ADA Lever	Venetian Bronze®	
134770	3553LF-SS	3-Hole 6-16"ws, Metal Push Pop-Up Drain, LF	ADA Lever	Stainless*	

Victorian® 2-Hdl Widespread Lavatory Faucet

- 5-1/8" Reach, 5-15/16" high rigid spout
- 3-3/4" From deck to aerator
- 1/4" Turn stops
- 3/8" Compression fittings
- 2-1/4" Maximum deck thickness
- 32" Minimum InnoFlex® supply lines below the deck
- DIAMOND™ valve
- WaterSense® certified product: 1.2 gpm @ 60 psi



Part #	Mfg #	Description	Handle(s)	Finish	Price
222973	3555-MPU-DST	3-Hole 4-16"ws, Metal Pop-Up Drain, Lead-Free	ADA Lever	Chrome	
185504	3555-RBMPU-DST	3-Hole 4-16"ws, Metal Pop-Up Drain, Lead-Free	ADA Lever	Venetian Bronze®	
187807	3555-SSMPU-DST	3-Hole 4-16"ws, Metal Pop-Up Drain, Lead Free	ADA Lever	Stainless*	

* Brilliance® Anti-Tarnish Lifetime Finishes

www.plumbsupply.com • Serving our Customers Since 1946 • www.waterconcepts.net

Lavatory Faucets - 8" Center

Faucets & Valves

Windemere® 2-Hdl Widespread Lavatory Faucet

- 4-5/8" Reach, 6-13/16" high rigid spout
- 5" From deck to aerator
- Hot/cold indicators
- 1/2" IPS Connection
- 1-1/8" Maximum deck thickness
- WaterSense® certified product, 1.2 gpm @ 60 psi



Part #	Mfg #	Description	Handle(s)	Finish	Price
132681	B3596LF	3-Hole 6-16"ws, Metal Pop-Up Drain, Lead-Free	ADA Lever	Chrome	
131932	B3596LF-OB	3-Hole 6-16"ws, Metal Pop-Up Drain, Lead-Free	ADA Lever	Oil-Rubbed Bronze	
136126	B3596LF-SS	3-Hole 6-16"ws, Metal Pop-Up Drain, Lead-Free	ADA Lever	Stainless*	

Wall-Mount Lavatory Faucets

Ara™ 2-Hdl Widespread Wall-Mount Lavatory Faucet

- 7-5/8" Reach, rigid spout
- Accommodates wall thicknesses from 1/8" to 1-1/8"
- Must order R3500-WL rough separately
- Order RP7387 for .5 gpm and RP73838 for 1.0 gpm water efficient flow restrictors
- WaterSense® certified product: 1.2 gpm @ 60 psi



Part #	Mfg #	Description	Handle(s)	Finish	Price
165665	T3567LF-WL	3-Hole 8"cc, Less Drain, Lead-Free	ADA Lever	Chrome	
162248	T3567LF-SSWL	3-Hole 8"cc, Less Drain, Lead-Free	ADA Lever	Stainless*	

Ara® 2-Hdl Channel Spout Widespread Lavatory Faucet

- 7-5/8" Reach, rigid spout
- Accommodates wall thicknesses from 1/8" to 1-1/8"
- Must order R3500-WL rough separately
- Order RP7387 for .5 gpm and RP73838 for 1.0 gpm water efficient flow restrictors
- WaterSense® certified product: 1.20 gpm @ 60 psi



Part #	Mfg #	Description	Handle(s)	Finish	Price
165666	T3568LF-WL	3-Hole 8"cc, Less Drain, Lead-Free w/ Channel Spout	ADA Lever	Chrome	
168010	T3568LF-SSWL	3-Hole 8"cc, Less Drain, Lead-Free w/ Channel Spout	ADA Lever	Stainless*	

* Brilliance® Anti-Tarnish Lifetime Finishes

www.waterconcepts.net • Serving our Customers Since 1946 • www.plumbsupply.com

Lavatory Faucets - 8" Center

Cassidy™ 2-Hdl Widespread Wall-Mount Lavatory Faucet

- 8-3/4" Reach, rigid spout
- 3-1/4" Handle length
- Accommodates wall thicknesses from 1/8" to 1-1/8"
- Cast brass body
- 1/2"-14 NPT threaded female inlets
- Drain sold separately
- WaterSense® certified: 1.2 gpm



Requires Valve: R3500-WL

Part #	Mfg #	Description	Handle(s)	Finish	Price
224827	T3597LF-RBWL	3-Hole 8"cc, Less Drain, Lead-Free	ADA Lever	Venetian Bronze®	

Compel™ 2-Hdl Widespread Wall-Mount Lavatory Faucet

- 7" Reach, rigid spout
- Red/blue indicators
- Accommodates wall thicknesses from 1/8"-1-1/8"
- (R3500-WL) Order rough separately
- WaterSense® certified product: 1.2 gpm @ 60 psi



Part #	Mfg #	Description	Handle(s)	Finish	Price
226262	T3561LF-WL	3-Hole 8"cc, Less Drain, Lead Free	ADA Lever	Chrome	
187076	T3561LF-SSWL	3-Hole 8"cc, Less Drain, Lead Free	ADA Lever	Stainless*	

Dryden™ 2-Hdl Widespread Wall-Mount Lavatory Faucet

- 8-5/16" Reach, rigid spout
- Red/blue indicators
- Accommodates wall thicknesses from 1/8"-1-1/8"
- WaterSense® certified product: 1.2 gpm @ 60 psi



Rough-In Valve Required: R3500-WL

Part #	Mfg #	Description	Handle(s)	Finish	Price
221999	T3551LF-RBWL	3-Hole 8"cc, Less Drain, Lead Free	ADA Lever	Venetian Bronze®	
186406	T3551LF-SSWL	3-Hole 8"cc, Less Drain, Lead Free	ADA Lever	Stainless*	

Tesla™ Wall-Mount 1-Hdl Lavatory Faucet

- 9" Reach, rigid spout
- Red/blue indicator markings
- Accommodates wall thickness from 0" to 1"
- Drain sold separately
- WaterSense® certified product: 1.2 gpm @ 60 psi



Rough-In Valve Required: R3510-WL

Part #	Mfg #	Description	Handle(s)	Finish	Price
223867	T552LF-SSWL	3-Hole 8"cc, Less Drain, Lead Free	ADA Lever	Stainless*	

* Brilliance® Anti-Tarnish Lifetime Finishes

www.plumbsupply.com • Serving our Customers Since 1946 • www.waterconcepts.net

Lavatory Faucets - 8" Center

Faucets & Valves

Trinsic™ Wall-Mount 1-Hdl Lavatory Faucet

- 7-1/2" Reach, rigid spout
- Accommodates wall thicknesses from 1/8"-1-1/8"
- Order (RP73805) for 1.0 gpm water efficient aerator
Order (RP73806) for 0.5 gpm water efficient aerator
- Euro-motion valve
- WaterSense® certified product: 1.2 gpm @ 60 psi



Requires R3510-WL Rough-In Valve

Part #	Mfg #	Description	Handle(s)	Finish	Price
188137	T3559LF-WL	2-Hole 4- 8" cc, Less Drain, Lead Free	ADA Lever	Chrome	
152807	T3559LF-CZWL	2-Hole 4- 8" cc, Less Drain, Lead Free	ADA Lever	Champagne Bronze™	
190504	T3559LF-RBWL	2-Hole 4- 8" cc, Less Drain, Lead Free	ADA Lever	Venetian Bronze®	
152001	T3559LF-SSWL	2-Hole 4- 8" cc, Less Drain, Lead Free	ADA Lever	Stainless*	

Zura® 2-Hdl Wall-Mount Vessel Faucet

- 8-1/2" Reach
- 1/2"-14 NPT threaded female inlets
- Accommodates wall thicknesses from 1/8" to 1-1/8"
- Drain sold separately
- WaterSense® certified product: 1.2 gpm @ 60 psi



Requires R3500-WL Rough-In Valve

Part #	Mfg #	Description	Handle(s)	Finish	Price
228887	T3574LF-SSWL	3-Hole 8"cc, Less Drain, Lead Free	ADA Lever	Stainless*	

Zura® 1-Hdl Wall-Mount Vessel Faucet

- 9-3/16" Reach
- 2-1/4" to 3-1/4" Rough-in depth
- Drain sold separately
- WaterSense® certified product: 1.20 gpm @ 60 psi



Requires R3510-WL Rough-In Valve

Part #	Mfg #	Description	Handle(s)	Finish	Price
229600	T574LF-WL	2-Hole 4"cc, Less Drain	ADA Lever	Chrome	

* Brilliance® Anti-Tarnish Lifetime Finishes

www.waterconcepts.net • Serving our Customers Since 1946 • www.plumbsupply.com

Lavatory Faucets - 8" Center

Two-Handle Widespread Lavatory Faucets

90 Degree™ 2-Hdl Lavatory Faucet

- 4-5/8" Reach, 4-1/16" high spout
- 3-7/8" From deck to aerator
- 1/2" IPS connections
- 1224 Cartridge design
- WaterSense certified: 1.5 gpm



Requires Valve: 9000

Part #	Mfg #	Description	Handle(s)	Finish	Price
132632	TS6720	8"-16" ws, Metal Pop-Up	ADA Lever	Chrome	
167312	TS6720BN	8"-16" ws, Metal Pop-Up	ADA Lever	Brushed Nickel	

Align™ 2-Hdl Lavatory Faucet

- 5-9/16" Reach, 6-13/32" high spout
- 4-17/64" From deck to aerator
- Hydrolock™ quick connect system
- 1/2" IPS connections
- 1224 Cartridge design
- WaterSense® certified: 1.5 gpm



Requires Valve: 9000

Part #	Mfg #	Description	Handle(s)	Finish	Price
174588	T6193	8"-16"ws	ADA Lever	Chrome	
186108	T6193BN	8"-16"ws	ADA Lever	Brushed Nickel	

Arris™ 2-Hdl Lavatory Faucet

- 5-3/4" Reach, 5-5/64" high spout
- 4-3/64" From deck to aerator
- Duralock™ quick connect system
- 1234™ Duralast™ cartridge
- WaterSense® certified: 1.2 gpm



Part #	Mfg #	Description	Handle(s)	Finish	Price
212033	TS43002	8"-16"ws, Metal Pop-Up	ADA Lever	Chrome	
180729	TS43002BN	8"-16"ws, Metal Pop-Up	ADA Lever	Brushed Nickel*	

*Lifeshine® Anti-Tarnish Lifetime Finish

www.plumbsupply.com • Serving our Customers Since 1946 • www.waterconcepts.net

Lavatory Faucets - 8" Center

Faucets & Valves

Brantford™ 2-Hdl Lavatory Faucet

- 5" Reach, 5" high spout
- 3-1/2" From deck to aerator
- 1/2" IPS connections
- 1224 Cartridge design
- WaterSense® certified: 1.5 gpm



Requires Valve: 9000

Part #	Mfg #	Description	Handle(s)	Finish	Price
109274	T6620	8"-16"ws	ADA Lever	Chrome	
102295	T6620BN	8"-16"ws	ADA Lever	*Brushed Nickel	
102286	T6620ORB	8"-16"ws	ADA Lever	Oil Rubbed Bronze	

Chateau™ 2-Hdl Lavatory Faucet

- 5-1/2" Reach
- 4-1/4" From deck to aerator
- 1/2" IPS shanks
- Duralock™ quick connect system
- 1234 Cartridge design
- WaterSense® certified: 1.5 gpm



Part #	Mfg #	Description	Handle(s)	Finish	Price
081364	4945	8"-16"ws, Metal Pop-Up	ADA Lever	Chrome	

Darcy™ 2-Hdl Lavatory Faucet

- 5-55/64" Reach, 5-3/4" high spout
- 4-1/2" From deck to aerator
- 1/2" IPS connections
- 1234 Cartridge design
- WaterSense® certified: 1.5 gpm



Part #	Mfg #	Description	Handle(s)	Finish	Price
180793	84551SRN	8"-16" ws, Metal Pop-Up Drain	ADA Lever	SR Brushed Nickel	

Dartmoor™ 2-Hdl Lavatory Faucet

- 5-1/16" Reach, 5-1/8" high spout
- 4-1/16" From deck to aerator
- 1/2" IPS connections
- 1234 Duralast® cartridge
- WaterSense® certified: 1.2 gpm



Requires Valve: 9000

Part #	Mfg #	Description	Handle(s)	Finish	Price
189423	T6805	8"-16" ws, Metal Pop-Up Drain	ADA Lever	Chrome	
189284	T6805BN	8"-16" ws, Metal Pop-Up Drain	ADA Lever	*Brushed Nickel	
222888	T6805ORB	8"-16" ws, Metal Pop-Up Drain	ADA Lever	Oil Rubbed Bronze	

*Lifeshine® Anti-Tarnish Lifetime Finish

www.waterconcepts.net • Serving our Customers Since 1946 • www.plumbsupply.com

Lavatory Faucets - 8" Center

Eva™ 2-Hdl Lavatory Faucet

- 4-7/8" Reach, 6" high spout
- 4" From deck to aerator
- 1/2" IPS connections
- 1224 Cartridge design
- WaterSense® certified: 1.5 gpm



Requires Valve: 9000

Part #	Mfg #	Description	Handle(s)	Finish	Price
098737	T6420	8"-16"ws, Metal Pop-Up Drain	ADA Lever	Chrome	
097223	T6420BN	8"-16"ws, Metal Pop-Up Drain	ADA Lever	*Brushed Nickel	
096177	T6420ORB	8"-16"ws, Metal Pop-Up Drain	ADA Lever	Oil Rubbed Bronze	

Glyde™ 2-Hdl Lavatory Faucet

- 5-3/4" Reach, 5-3/4" high spout
- 4-3/16" From deck to aerator
- 1/2" IPS connections
- 1234 Cartridge design
- WaterSense® certified: 1.2 gpm



Part #	Mfg #	Description	Handle(s)	Finish	Price
229218	T6173	8"-16"ws, Metal Pop-Up Drain	ADA Lever	Chrome	
221490	T6173BN	8"-16"ws, Metal Pop-Up Drain	ADA Lever	*Brushed Nickel	

Kingsley™ 2-Hdl Lavatory Faucet

- 5-1/8" Reach, 7" high spout
- 4-7/16" From deck to aerator
- Hydrolock™ quick connect system
- 1/2" IPS connections
- 1224 Cartridge design
- WaterSense® certified: 1.5 gpm



Requires Valve: 9000

Part #	Mfg #	Description	Handle(s)	Finish	Price
108631	T6125	8"-16"ws, Metal Pop-Up Drain	ADA Lever	Chrome	
079236	T6125BN	8"-16"ws, Metal Pop-Up Drain	ADA Lever	Brushed Nickel	
077212	T6125ORB	8"-16"ws, Metal Pop-Up Drain	ADA Lever	Oil Rubbed Bronze	
176395	T6125P	8"-16"ws, Metal Pop-Up Drain	ADA Lever	*Polished Brass	
078880	T6125WR	8"-16"ws, Metal Pop-Up Drain	ADA Lever	Wrought Iron	

*Lifeshine® Anti-Tarnish Lifetime Finish

www.plumbsupply.com • Serving our Customers Since 1946 • www.waterconcepts.net

Lavatory Faucets - 8" Center

Faucets & Valves

Kingsley™ 2-Hdl Low Arc Lavatory Faucet

- 4-1/2" Reach, 3-1/4" high spout
- 1-9/16" From deck to aerator
- 1/2" IPS connections
- 1234™ Duralast™ cartridge
- WaterSense® certified: 1.2 gpm to 1.5 gpm



Requires Valve: 9000

Part #	Mfg #	Description	Handle(s)	Finish	Price
188505	T6105	8"-16"ws, Metal Pop-Up Drain	ADA Lever	Chrome	
074527	T6105BN	8"-16"ws, Metal Pop-Up Drain	ADA Lever	Brushed Nickel	
079642	T6105ORB	8"-16"ws, Metal Pop-Up Drain	ADA Lever	Oil Rubbed Bronze	

Rothbury™ 2-Hdl Low Arc Bathroom Faucet

- 5-1/4" Reach, 3.176" high spout
- 2.094" From deck to aerator
- 1/2" IPS connections
- 1234™ Duralast™ cartridge
- WaterSense® certified: 1.2 gpm



Requires Valve: 9000

Part #	Mfg #	Description	Handle(s)	Finish	Price
117450	TS6205	8"-16"ws, Metal Pop-Up Drain	ADA Lever	Chrome	
120014	TS6205BN	8"-16"ws, Metal Pop-Up Drain	ADA Lever	Brushed Nickel	
113886	TS6205ORB	8"-16"ws, Metal Pop-Up Drain	ADA Lever	Oil Rubbed Bronze	

Voss™ 2-Hdl Lavatory Faucet

- 4-3/4" Reach, 5-7/8" high spout
- 4-1/2" From deck to aerator
- 1/2" IPS connection
- 1224 Cartridge design
- WaterSense® certified: 1.5 gpm



Requires Valve: 9000

Part #	Mfg #	Description	Handle(s)	Finish	Price
150271	T6905	8"-16" ws, Metal Pop-Up Drain	ADA Lever	Chrome	
150370	T6905BN	8"-16" ws, Metal Pop-Up Drain	ADA Lever	*Brushed Nickel	
152283	T6905ORB	8"-16" ws, Metal Pop-Up Drain	ADA Lever	Oil Rubbed Bronze	

*Lifeshine® Anti-Tarnish Lifetime Finish

www.waterconcepts.net • Serving our Customers Since 1946 • www.plumbsupply.com

Lavatory Faucets - 8" Center

Waterhill® 2-Hdl Lavatory Faucet

- 5-3/4" Reach, 5-25/32" high spout
- 3-7/32" From deck to aerator
- 1/2" IPS connection
- 1224 Cartridge design
- WaterSense® certified: 1.5 gpm



Requires Valve: 9000

Part #	Mfg #	Description	Handle(s)	Finish	Price
111447	TS418	8"-16" ws, Metal Pop-Up Drain	ADA Lever	Chrome	
149152	TS418BN	8"-16" ws, Metal Pop-Up Drain	ADA Lever	Brushed Nickel	
197452	TS418NL	8"-16" ws, Metal Pop-Up Drain	ADA Lever	Polished Nickel	
105946	TS418ORB	8"-16" ws, Metal Pop-Up Drain	ADA Lever	Oil Rubbed Bronze	

Weymouth™ 2-Hdl Lavatory Faucet

- 5-3/4" Spout reach
- 3" Handle Reach
- 5-1/4" From deck to aerator
- 1224 Cartridge design
- WaterSense® certified: 1.5gpm



• Requires Valve: 9000

Part #	Mfg #	Description	Handle(s)	Finish	Price
156108	TS42108	8"-16" ws, Metal Pop-Up Drain	ADA Lever	Chrome	
148352	TS42108BN	8"-16" ws, Metal Pop-Up Drain	ADA Lever	Brushed Nickel	
181593	TS42108NL	8"-16" ws, Metal Pop-Up Drain	ADA Lever	Polished Nickel	
143065	TS42114	8"-16" ws, Metal Pop-Up Drain	Cross Handles	Chrome	
157720	TS42114BN	8"-16" ws, Metal Pop-Up Drain	Cross Handles	Brushed Nickel	
152844	TS42114NL	8"-16" ws, Metal Pop-Up Drain	Cross Handles	Polished Nickel	
175571	TS42114ORB	8"-16" ws, Metal Pop-Up Drain	Cross Handles	Oil Rubbed Bronze	

Wynford™ 2-Hdl Lavatory Faucet

- 4-5/8" Spout reach, 6-1/2" high spout
- 4-38" From deck to aerator
- 1234™ Duralast™ cartridge design
- WaterSense® certified: 1.5 gpm



• Requires Valve: 9000

Part #	Mfg #	Description	Handle(s)	Finish	Price
190527	T4520	8"-16" ws, Metal Pop-Up Drain	ADA Lever	Chrome	
178606	T4520BN	8"-16" ws, Metal Pop-Up Drain	ADA Lever	Brushed Nickel	
184811	T4520NL	8"-16" ws, Metal Pop-Up Drain	ADA Lever	Polished Nickel	
189588	T4520ORB	8"-16" ws, Metal Pop-Up Drain	ADA Lever	Oil Rubbed Bronze	
187212	T4524	8"-16" ws, Metal Pop-Up Drain	ADA Cross	Chrome	

*Lifeshine® Anti-Tarnish Lifetime Finish

www.plumbsupply.com • Serving our Customers Since 1946 • www.waterconcepts.net

Lavatory Faucets - 8" Center

Faucets & Valves

Wall-Mount Lavatory Faucets

90° Wall-Mount Lavatory Faucet

- 6-7/8" Spout length
- 2-5/8" Handle reach
- 3" Minimum clearance from aerator to vessel sink
- 1224 Cartridge design
- WaterSense® certified: 1.2 gpm



Part #	Mfg #	Description	Handle(s)	Finish	Price
143560	TS6730	8" ws, Less Drain	ADA Lever	Chrome	
141000	TS6730BN	8" ws, Less Drain	ADA Lever	Brushed Nickel	

Kingsley™ 2-Hdl Wall-Mount Lavatory Faucet

- 7" Spout length
- 2-7/8" Handle reach
- 3" Minimum clearance from aerator to vessel sink
- 1/2" Copper connections
- 1224 Cartridge design
- WaterSense® certified: 1.5 gpm



Part #	Mfg #	Description	Handle(s)	Finish	Price
103738	T6107BN	8" ws, Less Drain	ADA Lever	Brushed Nickel	
103984	T6107ORB	8" ws, Less Drain	ADA Lever	Oil Rubbed Bronze	

Voss™ 2-Hdl Wall-Mount Lavatory Faucet

- 7-3/8" Spout reach
- 3-1/2" Handle reach
- 3" Minimum clearance from aerator to vessel sink
- 1224 Cartridge design
- WaterSense® certified: 1.5 gpm



Requires Valve: 9700

Part #	Mfg #	Description	Handle(s)	Finish	Price
152308	T6906	8" ws, Less Drain	ADA Lever	Chrome	
158203	T6906BN	8" ws, Less Drain	ADA Lever	*Brushed Nickel	

*Lifeshine® Anti-Tarnish Lifetime Finish

www.waterconcepts.net • Serving our Customers Since 1946 • www.plumbsupply.com

Lavatory Faucets - 8" Center

Weymouth™ 2-Hdl Wall-Mount Lavatory Faucet

- 7.84" Spout reach
- 4" Handle reach
- 3" Minimum clearance from aerator to vessel sink
- 1-3/4" Max wall thickness
- 1224 Cartridge design
- Drain sold separately
- WaterSense® certified: 1.5 gpm



Faucets & Valves

Requires Valve: 9700

Part #	Mfg #	Description	Handle(s)	Finish	Price
186664	TS42112	8"ws, Less Drain	Cross Handles	Chrome	

*Lifeshine® Anti-Tarnish Lifetime Finish

www.plumbsupply.com • Serving our Customers Since 1946 • www.waterconcepts.net

Lavatory Faucets - 8" Center

Lavatory Faucets

172 Washer-Type 2-Hdl Slantback Lavatory Faucet

- Renew valves & seats
- Solid cast brass valves & spout
- Adjustable centers 4" - 8"
- Chrome finish
- Chrome metal handles



Faucets & Valves

Part #	Mfg #	Description	Price
026010	172	With Pop-Up Drain Assembly	

Laundry/Utility Faucets

Two-Handle Laundry Faucets

Coralais® 2-Hdl Laundry Faucet

- 6" Reach swivel spout
- Metal construction
- Reversible 1/4-turn washerless ceramic valving



Plain Spout



Threaded Spout

Part #	Mfg #	Description	Handle(s)	Finish	Price
083147	K-152704-CP	4"cc, Plain Spout	ADA Levers	Polished Chrome	
087122	K-152714-CP	4"cc, Threaded Spout	ADA Levers	Polished Chrome	

Trend® 2-Hdl Laundry Faucet with Threaded Swing Spout and Metal Blade Handles

- 5-1/2" Reach spout
- Brass construction
- Compression valving



Part #	Mfg #	Description	Handle(s)	Finish	Price
067157	K-11935-U-CP	4"cc, Threaded Spout	ADA Blades	Polished Chrome	

Utility Faucets

Kinlock™ Service Sink Faucet with Top-Mounted Wall Brace

- Solid brass construction
- 4-5/8" threaded spout
- 7-1/4" Wall-to-spout outlet (8907)
- 8-5/8" Wall-to-spout outlet (8908)
- Inside-threaded couplings
- Vacuum breaker
- Top-mounted Wall brace; pail hook
- Double lever handles are ADA-compliant
- Valvet® valves with brass valve bodies
- Loose-key stops included with model (K-7320-4-CP)



Part #	Mfg #	Description	Handle(s)	Finish	Price
168573	K-8907-CP	8"cc, Wall Brace	ADA Lever	Polished Chrome	
180263	K-8908-CP	8"cc, Wall Brace, Loose Key Stops in Shanks	ADA Lever	Polished Chrome	

Triton® Utility Sink Faucet with Gooseneck Spout

- 7-3/4" fixed gooseneck spout
- Solid brass construction with Valvet® valves and brass valve bodies
- Adjustable flanges
- 1/2" IPS inside-threaded inlets
- 2.2 gallons per minute
- Rosespray gooseneck spout included with model (K-7320-4-CP)



Part #	Mfg #	Description	Handle(s)	Finish	Price
178546	K-7319-3-CP	8"cc, Gooseneck Spout Rose spray	ADA Cross	Polished Chrome	
181902	K-7320-4-CP	8"cc, Gooseneck Spout	ADA Lever	Polished Chrome	

* Vibrant Limited Lifetime Finish

www.plumbsupply.com • Serving our Customers Since 1946 • www.waterconcepts.net

Laundry/Utility Faucets

Faucets & Valves

Single-Handle Specialty Faucets

Classic Basin Faucet

- 1-Hole Installation
- 4" Long, 3-5/8" high
- 1-1/2" From deck to aerator
- 1/4-Turn handle stop
- 1/2" IPS Connection
- 2" diameter escutcheon
- 1-1/8" maximum deck thickness
- WaterSense® certified product:
1.5 gpm @ 60 psi



Part #	Mfg #	Description	Handle(s)	Finish	Price
156900	2302LF	1-Hole	Crystal Knob	Chrome	

Classic 1-Hdl Basin Faucet

- 1-Hole installation
- 4" Long, 5-7/8" high 360° swivel spout
- 2-1/4" From deck to aerator
- 3/8" O.D. inlets
- 1/2" IPS adapters
- 1-9/16" Max deck thickness
- Flow rate: 1.5 gpm @ 60 psi



Part #	Mfg #	Description	Handle(s)	Finish	Price
156196	570LF-WF	1-Hole	ADA Lever	Chrome	

Two-Handle Specialty Faucets

Classic 2-Hdl Laundry Faucet with Hose Thread Spout

- 2 or 3 Hole 4" installation
- 7" Long, 4-5/8" high, 360° swivel spout
- 2-3/8" From deck to outlet
- 1/2" IPS connection
- Spout has hose thread
- 1-1/8" Max deck thickness
- RP76691 adds 1-1/4" to max deck thickness



Part #	Mfg #	Description	Handle(s)	Finish	Price
152471	2131LF	2- or 3-Hole 4"cc	Blade Handles	Chrome	

* Brilliance® Anti-Tarnish Lifetime Finishes

www.waterconcepts.net • Serving our Customers Since 1946 • www.plumbsupply.com

Laundry/Utility Faucets

Classic 2-Hdl Laundry Faucet

- 2 or 3 Hole 4" installation
- 5-5/8" Reach, 6-1/2" high, 360° swivel spout
- 3-31/32" From deck to aerator
- 1/2" IPS connection
- Spout has stream straightener
- 1-1/8" Max deck thickness
- RP76691 adds 1-1/4" to max deck thickness



Part #	Mfg #	Description	Handle(s)	Finish	Price
152755	2133LF	2- or 3-Hole 4"cc	Blade Handles	Chrome	

Classic 2-Hdl Laundry Faucet

- 2 or 3-Hole 4" installation
- 6-1/4" Reach, 5-1/8" high, 360° swivel spout
- 3-5/8" From deck to aerator
- 1/2" - 14 NPSM threaded male shanks
- Spout has hose thread
- 1-1/8" Maximum deck thickness



Part #	Mfg #	Description	Handle(s)	Finish	Price
191969	2121LF	2- or 3-Hole 4"cc	Blade Handles	Chrome	

Faucets & Valves

* Brilliance® Anti-Tarnish Lifetime Finishes

www.plumbsupply.com • Serving our Customers Since 1946 • www.waterconcepts.net

Laundry/Utility Faucets

Laundry Faucets

Chateau 2-Hdl Laundry Faucet

- 5-7/16" Spout reach, 6-5/8" high
- 4-63/64" From deck to aerator
- Inlet shanks will accept 3/8" ball nose connections
- 1224 Cartridge design



74998

4975

Part #	Mfg #	Description	Handle(s)	Finish	Price
034988	74998	4"cc, Threaded Spout	Mini Blade	Chrome	
007310	4975	4"cc, Non-Threaded Spout	Acrylic Knob	Chrome	

Faucets & Valves

*Lifeshine® Anti-Tarnish Lifetime Finish

www.waterconcepts.net • Serving our Customers Since 1946 • www.plumbsupply.com



Laundry Faucets

Two-Handle Laundry Faucets

Gerber Classics Clamp-On 2-Hdl Laundry Faucet

- Cast spout with hose connection
- Clamp-on mounting
- Cast brass body
- Compression cartridges
- 10-Year limited warranty



Part #	Mfg #	Description	Handle(s)	Finish	Price
004720	49-530	1/2" IPS/Sweat	ADA Lever	Rough Brass	

Faucets & Valves

*Physical Vapor Deposition (PVD) Limited Lifetime Finish

www.plumbsupply.com • Serving our Customers Since 1946 • www.waterconcepts.net

Laundry/Utility Faucets

Utility Faucets

8" Centerset Service and Utility Wall-Mount Faucet

- 6-1/2" Reach, 3-7/8" high spout
- Solid brass construction
- 1/2" NPT female inlet
- Quarter turn ceramic disc valve
- 1/2" Deck clearance
- 8" Faucet hole spread
- NSF/ANSI 61 certified



Part #	Mfg #	Overall Size	Holes	Depth	Drain Opening	Price
189274	LKB940C	2-Hole, No Spray type	ADA 2" Lever	Chrome		

4" - 8-3/8" Adjustable Centers Service and Utility Wall-Mount Faucet

- 5-1/2" Reach, 3-1/2" high spout
—Bucket hook spout
- Solid brass construction
- 1/2" NPT female inlet
- Brass stem assembly valve
- 3/8" Compression hose assembly
- 4" Faucet hole spread
- Flow rate: 2.2 gpm
- NSF/ANSI 61 certified



Part #	Mfg #	Overall Size	Holes	Depth	Drain Opening	Price
170294	LK400	2-Hole, No Spray Type	ADA 2" Lever	Chrome		

Service & Utility Wall-Mount Faucet

- 3-3/16" Reach, 4" spout height
- Chrome plated brass
- 1/2" NPT female inlets
- Brass stem assembly valve
- Sold as pair (C) or individually (CH or CP)
- NSF/ANSI 61 certified
- Maximum flow rate: 2.5 gpm



Part #	Mfg #	Overall Size	Holes	Depth	Drain Opening	Price
161287	LK69CP	1-Hole, No Spray Type	ADA Cross	Chrome		

Faucets & Valves



Laundry/Utility Faucets

Laundry Faucets

P4C 2-Hdl Laundry Faucet

- Metal wing handles
- Washerless cartridges
- Max flow rate: 2.2 gpm @ 60 psi



Faucets & Valves

Part #	Mfg #	Description	Handle(s)	Finish	Price
235459	P4C-386CA	4"cc	Metal Wing	Chrome	

* Brilliance® Anti-Tarnish Lifetime Finishes

www.plumbsupply.com • Serving our Customers Since 1946 • www.waterconcepts.net

Personal Showers & Accessories

Faucets & Valves

Handshowers

Artifacts® Single-Function Handshower

- Full hydromassage spray
- MasterClean™ 3-5/8" sprayface
- Katalyst® air-induction spray
- Hose sold separately
- WaterSense® certified: 2.0 gpm



Part #	Mfg #	Description	Price
166101	K-72776-BN	3-5/8", *Brushed Nickel	
171980	K-72776-BV	3-5/8", *Brushed Bronze	
166448	K-72776-CP	3-5/8", Polished Chrome	
165046	K-72776-SN	3-5/8", *Polished Nickel	
168455	K-72776-2BZ	3-5/8", Oil-Rubbed Bronze	

Awaken® G90 Multi-Function Handshower

- Spray modes: wide coverage, intense drenching, and targeted spray.
- Thumb tab for diverting sprays
- MasterClean™ sprayface
- Hose sold separately
- WaterSense® certified: 2.0 gpm
- Contemporary design



Part #	Mfg #	Description	Price
160256	K-72414-CP	3-9/16", Polished Chrome	
160467	K-72414-BN	3-9/16", *Brushed Nickel	
160257	K-72415-CP	4-5/16", Polished Chrome	
160285	K-72415-BN	4-5/16", *Brushed Nickel	

Awaken® B90 Multi-Function Handshower

- Spray modes: wide coverage, intense drenching, and targeted spray.
- Thumb tab for diverting sprays
- MasterClean™ sprayface
- Hose sold separately
- Transitional design



3-3/4" Awaken Multi-Function Handshower

Part #	Mfg #	Description	Price
160260	K-72420-CP	2.0 gpm, Polished Chrome	
160469	K-72420-BN	2.0 gpm, *Brushed Nickel	
177745	K-99248-BN	1.5 gpm, w/Eco-Boost *Br Nickel	
187830	K-99248-CP	1.5 gpm w/Eco-Boost, Pol Chrome	

4-5/8" Awaken Multi-Function Handshower

Part #	Mfg #	Description	Price
159627	K-72421-CP	2.0 gpm, Polished Chrome	
159539	K-72421-BN	2.0 gpm, *Brushed Nickel	
229505	K-72421-2BZ	2.0 gpm, Oil Rubbed Bronze	

Bancroft™ Multi-Function Handshower

- Spray modes: wide coverage, massage, soft aerated and reduced-flow
- MasterClean™ wide spray face
- Flow rate: 2.5 gpm



Part #	Mfg #	Description	Price
100093	K-10597-BN	*Brushed Nickel	
103945	K-10597-BV	*Brushed Bronze	
102428	K10597CP	Polished Chrome	
116737	K-10597-SN	*Polished Nickel	
148343	K-10597-2BZ	Oil-Rubbed Bronze	

Bancroft Multi-Function 1.75 gpm Handshower

- Spray modes: wide coverage, medium coverage, forceful utility spray, and water-saving spray option
- Water-saving spray meets ADA requirement for non-positive shutoff
- WaterSense® certified: 1.75gpm



Part #	Mfg #	Description	Price
138665	K-10549-BN	*Brushed Nickel	
150807	K-10549-CP	Polished Chrome	
156621	K-10549-2BZ	Oil-Rubbed Bronze	

Exhale® B120 Multi-Function Handshower

- Spray modes: full coverage, drenching, pulsating, silk spray
- Flow rate: 2.0 gpm



Part #	Mfg #	Description	Price
222215	K-72595-SN	*Polished Nickel	

* Vibrant Limited Lifetime Warranty

www.waterconcepts.net • Serving our Customers Since 1946 • www.plumbsupply.com

Personal Showers & Accessories

Flipside™ 01 Multi-Function Handshower

- *Flipstream Technology™*
- *Four unique, experiential spray patterns: Koverage™ (full), Kotton™ (downpour), Komotion™ (soft) and Kurrent™ (massage)*
- *Adjustable angle for various user heights*



Part #	Mfg #	Description	Price
127529	K-17493-BN	2.5 gpm, *Brushed Nickel	
127698	K-17493-CP	2.5 gpm, Polished Chrome	
154376	K-17493-2BZ	2.5 gpm, Oil-Rubbed Bronze	
166463	K-45425-BN	2.0 gpm, *Brushed Nickel	
156710	K-45425-CP	2.0 gpm, *Polished Chrome	
166464	K-45425-2BZ	2.0 gpm, *Oil-Rubbed Bronze	

Flipside™ 02 Multi-Function Handshower

- *Flipstream Technology™*
- *Four unique, experiential spray patterns: Koverage™ (full), Kotton™ (downpour), Komotion™ (soft) and Kurrent™ (massage)*
- *Adjustable angle for various user heights*



Part #	Mfg #	Description	Price
124358	K-17492-BN	2.5 gpm, *Brushed Nickel	
125908	K-17492-CP	2.5 gpm, Polished Chrome	
148318	K-17492-SN	2.5 gpm, *Polished Nickel	
156153	K-45426-BN	2.0 gpm, *Brushed Nickel	
157761	K-45426CP	2.0 gpm, Polished Chrome	

Forté® Multi-Function Handshower

- *MasterClean™ sprayface*
- *Spray modes: wide coverage, massage, soft aerated and reduced-flow*
- *Ergonomic sprayhead pivots for targeted massage*



Part #	Mfg #	Description	Price
096596	K-10286-AF	2.5 gpm, * French Gold	
093443	K-10286-BN	2.5 gpm, *Brushed Nickel	
097539	K-10286-BV	2.5 gpm, *Brushed Bronze	
088105	K10286CP	2.5 gpm, Polished Chrome	
099436	K-10286-G	2.5 gpm, Brushed Chrome	
099030	K-10286-PB	2.5 gpm, *Polished Brass	
092354	K-10286-SN	2.5 gpm, *Polished Nickel	

Handshowers (Continued)

Forté® Multi-Function Handshower

Part #	Mfg #	Description	Price
161745	K102862BZ	2.5 gpm, Oil-Rubbed Bronze	
131641	K-10298-BN	1.75 gpm, *Brushed Nickel	
113848	K-10298-CP	1.75 gpm, Polished Chrome	
170457	K-10298-G	1.75 gpm, Brushed Chrome	

Kelston® Single-Function Handshower

- *MasterClean™ sprayface*
- *Flow rate: 2.5 gpm*
- *Hose sold separately*



Part #	Mfg #	Description	Price
126468	K-10343-BN	*Brushed Nickel	
131713	K-10343-BV	*Brushed Bronze	
117160	K-10343-CP	Polished Chrome	
160870	K-10343-SN	*Polished Nickel	
146987	K-10343-2BZ	Oil-Rubbed Bronze	

MasterShower® Multi-Function Handshower

- *Spray modes: wide strong spray, concentrated pulse and wide pulse*
- *Easy-grip ring offers smooth switch of spray options*
- *MasterClean™ sprayface*
- *Flow rate: 2.5 gpm*



Part #	Mfg #	Description	Price
053756	K-8501-BN	*Brushed Nickel	
053755	K-8501-CP	Polished Chrome	

MasterShower® Multi-Function Relaxing Handshower

- *Spray modes: wide soft coverage, slow pulse massage and soft aerated*
- *Easy-grip ring offers smooth switch of spray options*
- *MasterClean™ sprayface*
- *Flow rate: 2.5 gpm*



Part #	Mfg #	Description	Price
053758	K-8502-BN	*Brushed Nickel	
053757	K-8502-CP	Polished Chrome	

* Vibrant Limited Lifetime Warranty

www.plumbsupply.com • Serving our Customers Since 1946 • www.waterconcepts.net

Personal Showers & Accessories

Faucets & Valves

MasterShower® Multi-Function 3-Way Relaxing Eco Handshower

- Spray modes: wide soft coverage, slow pulse massage and soft aerated spray settings
- Easy-grip ring offers smooth switch of spray options
- Easy clean flexible spray nozzles



Part #	Mfg #	Description	Price
114787	K-8543-CP	Polished Chrome	

Memoirs® Single-Function Handshower

- Full spray
- Ergonomic sprayhead
- MasterClean™ sprayface
- Flow rate: 2.5 gpm
- Shower hose sold separately



Part #	Mfg #	Description	Price
093410	K-419-BN	*Brushed Nickel	
093763	K-419-BV	*Brushed Bronze	
093740	K419CP	Polished Chrome	
165827	K-419-2BZ	Oil-Rubbed Bronze	

Purist® Multi-Function Handshower

- Spray modes: wide coverage, medium coverage and concentrated
- Ergonomic sprayhead pivots for precise adjustment
- MasterClean™ sprayface
- WaterSense® certified: 1.75 gpm



Part #	Mfg #	Description	Price
113292	K-978-CP	Polished Chrome	

Shift™ Multi-Function Square Handshower

- Wide coverage and concentrated spray settings
- Shower hose not included



Black Handle

Part #	Mfg #	Description	Price
134409	K-14788-BN	2.5,*Brushed Nickel	
139116	K-14788-CP	2.5, Polished Chrome	
151107	K-14788-SN	2.5, *Polished Nickel	
150615	K-45203-CP	2.0, Polished Chrome	

Grey Handle

Part #	Mfg #	Description	Price
154352	K-14788-GR-BN	2.5, *Brushed Nickel	
148092	K-14788-GR-CP	2.5, Polished Chrome	
158853	K-14788-GR-SN	2.5, *Polished Nickel	
160959	K-45203-GR-CP	2.0, Polished Chrome	

Shift™ Multi-Function Ellipse Handshower

- Wide coverage and concentrated spray settings
- Shower hose not include



-A

Metallic Handle

Part #	Mfg #	Description	Price
150205	K-10257-A-BN	2.5 gpm, *Br Nickel	
154956	K-10257-A-CP	2.5 gpm Polished Chrome	
118880	K-10257-CP	2.5 gpm Pol Chrome/Black	

Black Handle

Part #	Mfg #	Description	Price
183573	K-45415-CP	2.0 gpm, Polished Chrome	

Stillness® Multi-Function Handshower

- Spray modes: wide coverage, massage, soft aerated, and reduced-flow
- Sprayhead pivots
- MasterClean™ sprayface
- Flow rate: 2.5 gpm
- Shower hose not included



Part #	Mfg #	Description	Price
093406	K-973-BN	*Brushed Nickel	
122136	K-973-BV	*Brushed Bronze	
093467	K-973-CP	Polished Chrome	
131004	K-973-SN	*Polished Nickel	

* Vibrant Limited Lifetime Warranty

www.waterconcepts.net • Serving our Customers Since 1946 • www.plumbsupply.com

Personal Showers & Accessories

Handshower Sets

Awaken® B110 Slidebar Kit

- Includes:
 - Multi-function handshower
 - Slidebar
 - Hose
- MasterClean™ sprayface
- Wide coverage, intense drenching, targeted massage, and reduce-flow sprays
- Transitional design
- WaterSense® certified: 2.0 gpm



Premium

- 36" Slidebar
- 60" Metal hose

Part #	Mfg #	Description	Price
173841	K-99899-BN	*Brushed Nickel	
173208	K-99899-CP	Polished Chrome	

Deluxe

- 24" Slidebar
- 60" Smooth Hose

Part #	Mfg #	Description	Price
182424	K-99243-BN	*Brushed Nickel	
175220	K-99243-CP	Polished Chrome	

Awaken® G110 Slidebar Kit

- Includes:
 - Multi-function handshower
 - Slidebar
 - Hose
- MasterClean™ sprayface
- Contemporary design
- WaterSense® certified: 2.0 gpm



Premium

- 34" Slidebar
- 60" Metal hose

Part #	Mfg #	Description	Price
176051	K-99898-BN	*Brushed Nickel	
174961	K-99898-CP	Polished Chrome	

Deluxe

- 24" Slidebar
- 60" Smooth hose

Part #	Mfg #	Description	Price
178400	K-99242-BN	*Brushed Nickel	
188401	K-99242-CP	Polished Chrome	

Awaken® B90 Handshower Kit

- Includes:
 - Multi-function handshower
 - 24" Slidebar
 - 60" Ribbon hose
- MasterClean™ sprayface
- Wide coverage, intense drenching, or targeted massage
- WaterSense® certified: 2.0 gpm
- Transitional design



Part #	Mfg #	Description	Price
160427	K-98362-BN	*Brushed Nickel	
160264	K-98362-CP	Polished Chrome	

Awaken® G90 Handshower Kit

- Includes:
 - Multi-function handshower
 - 24" Slidebar
 - 60" Ribbon hose
- MasterClean™ sprayface
- Wide coverage, intense drenching, or targeted massage
- WaterSense® certified: 2.0 gpm
- Contemporary design



Part #	Mfg #	Description	Price
160471	K-98361-BN	*Brushed Nickel	
160263	K-98361-CP	Polished Chrome	

Hotel Handshower Kit

- Includes:
 - Shift handshower
 - 24-3/4" Slidebar
 - 60" Metal hose
- MasterClean™ sprayface
- Wide coverage or concentrated sprays
- Flow rate: 2.5 gpm



Part #	Mfg #	Description	Price
128070	K-8487-BN	*Brushed Nickel	

* Vibrant Limited Lifetime Warranty

www.plumbsupply.com • Serving our Customers Since 1946 • www.waterconcepts.net

Personal Showers & Accessories

Faucets & Valves

Handshower Sets (Continued)

Hotel Handshower Kit

Part #	Mfg #	Description	Price
128069	K-8487-CP	Polished Chrome	

MasterShower® Hotel Handshower Kit

- Includes:
 - Multi-function handshower
 - 25" Slidebar
 - 60" Metal hose
 - Vacuum breaker
 - Wall elbow
- Flow rate: 2.5 gpm



Part #	Mfg #	Description	Price
058890	K-8520-CP	Polished Chrome	

Contemporary Handshower Kit

- Includes:
 - Multi-function handshower
 - Slide bar with Stillness/Purist® trim
 - 60" Hose and supply elbow
- MasterClean™ sprayface
- Full-coverage, therapeutic massage, soft-aerated, and water-saving eco spray options
- Flow rate: 2.5 gpm



Part #	Mfg #	Description	Price
130326	K-9059-BN	*Brushed Nickel	
119139	K-9059-CP	Polished Chrome	

Handshower Slidebars

Handshower Slidebar

- Durable metal construction
- Handshower sold separately



Part #	Mfg #	Description	Price
105841	K-8524-AF	30", *French Gold	
099005	K-8524-BN	30", *Brushed Nickel	
095601	K-8524-BV	30", *Brushed Bronze	
128703	K-9069-BN	24", *Brushed Nickel	
099004	K-8524-CP	30", Pol Chrome	

Handshower Slidebars (Continued)

Handshower Slidebar

Part #	Mfg #	Description	Price
103933	K-8524-G	30", Brushed Chrome	
127182	K-8524-PB	30", *Pol Brass	
111915	K-8524-SN	30", *Pol Nickel	
147045	K-8524-2BZ	30", Oil Rubbed Bronze	
129831	K-9069-CP	24", Polished Chrome	

Artifacts® Handshower Slidebar

- 30" Slidebar
- Adjustable mounting bracket



Part #	Mfg #	Description	Price
172099	K-72798-BN	30", *Brushed Nickel	
162737	K-72798-CP	30", Polished Chrome	
165047	K-72798-SN	30", Polished Nickel	
168453	K-72798-2BZ	30", Oil-Rubbed Bronze	

Awaken® Handshower Slidebar

- Adjustable mounting brackets
- Adjustable angle of handshower



Part #	Mfg #	Description	Price
159537	K-98341-BN	24", *Brushed Nickel	
159970	K-98341-CP	24", Polished Chrome	

* Vibrant Limited Lifetime Warranty

www.waterconcepts.net • Serving our Customers Since 1946 • www.plumbsupply.com

Personal Showers & Accessories

Awaken® Deluxe Handshower Slidebar

- Adjustable mounting brackets offer installation flexibility
- Adjustable angle of handshower
- Wall-Mount



Part #	Mfg #	Description	Price
177744	K-98342-BN	24", *Brushed Nickel	
188365	K-98342-CP	24", Polished Chrome	
224771	K-98343-BN	36", *Brushed Nickel	
172836	K-98343-CP	36", Pol Chrome	

Awaken® Deluxe Handshower Slidebar with Integrated Water Supply

- Adjustable mounting brackets offer installation flexibility
- Adjustable angle of handshower
- Wall-Mount
- Integrated water supply allows water to be plumbed directly through bottom bracket of slidebar



Part #	Mfg #	Description	Price
170222	K-98344-BN	36", *Brushed Nickel	
173521	K98344CP	36", Polished Chrome	

MasterShower® 22-3/4" Shower Slidebar

- Includes soap dish and adjustable mounting bracket
- For use with MasterShower® handshower systems



Part #	Mfg #	Description	Price
069306	K-9516-BN	22-3/4", *Brushed Nickel	
090354	K-9516-BV	22-3/4", *Brushed Bronze	

Handshower Slidebars (Continued)

MasterShower® 22-3/4" Shower Slidebar

Part #	Mfg #	Description	Price
061895	K-9516-CP	22-3/4", Polished Chrome	
080313	K-9516-G	22-3/4", Brushed Chrome	
081388	K-9516-PB	22-3/4", *Polished Brass	
092355	K-9516-SN	22-3/4", *Polished Nickel	

Artifacts® Slidebar Trim



Part #	Mfg #	Description	Price
172100	K-72799-BN	*Brushed Nickel	
173114	K-72799-CP	Polished Chrome	
173104	K-72799-SN	Polished Nickel	
168454	K-72799-2BZ	Oil-Rubbed Bronze	

Forté Slidebar Trim Kit

- Escutcheon's and bar inserts
- Requires K-8524 basic slidebar



Part #	Mfg #	Finish	Price
105842	K-349-AF	*French Gold	
102073	K-349-BKB	Brushed Black	
099007	K-349-BN	*Brushed Nickel	
101758	K-349-BV	Vibrant Brushed Bronze	
099006	K-349-CP	Polished Chrome	
103934	K-349-G	Brushed Chrome	
127183	K-349-PB	*Polished Brass	
151109	K-349-SN	*Polished Nickel	
147030	K-349-2BZ	Oil-Rubbed Bronze	

Loure® Slidebar Trim



Part #	Mfg #	Finish	Price
146702	K-14790-BN	*Brushed Nickel	
142828	K-14790-CP	Polished Chrome	
142548	K-14790-SN	*Polished Nickel	

* Vibrant Limited Lifetime Warranty

www.plumbsupply.com • Serving our Customers Since 1946 • www.waterconcepts.net

Personal Showers & Accessories

Faucets & Valves

Memoirs® Slidebar Trim Kit

- For use with K-8524 and K-9069 Slidebars



Part #	Mfg #	Description	Price
104808	K-421-BN	*Brushed Nickel	
097634	K-421-BV	*Brushed Bronze	
111149	K-421-CP	Polished Chrome	

Stillness® Slidebar Trim Kit

- Escutcheon's
- Requires K-8524 basic slidebar



Part #	Mfg #	Finish	Price
103526	K-974-BN	*Brushed Nickel	
099539	K-974-CP	Polished Chrome	

Shower Hoses

MasterShower® Shower Hose



Part #	Mfg #	Description	Price
087917	K-8593-AF	72", *French Gold	
072507	K-8593-BN	72", *Brushed Nickel	
071258	K-8593-CP	72", Polished Chrome	
073079	K-8593-G	72", Brushed Chrome	
082428	K-8593-PB	72", Polished Brass	
092356	K-8593-SN	72", *Polished Nickel	
096187	K-9514-AF	60", *French Gold	
056368	K-9514-BN	60", *Brushed Nickel	
076705	K-9514-BV	60", *Brushed Bronze	
053896	K-9514-CP	60", Polished Chrome	
054493	K-9514-G	60", Brushed Chrome	
066447	K-9514-PB	60", *Polished Brass	
054535	K-9514-SN	60", *Polished Nickel	
225786	K-9514-VNT	60", Vintage Nickel	
147046	K-9514-2BZ	60", Oil Rubbed Bronze	

Awaken® Ribbon Hose



Part #	Mfg #	Description	Price
159802	K-45981-BN	72", Brushed Nickel	
160262	K-45981-CP	72", Polished Chrome	
187241	K-45981-2BZ	72", Oil-Rubbed Bronze	
159538	K-45982-BN	60", Brushed Nickel	
159971	K-45982-CP	60", Polished Chrome	
172782	K-45982-SN	60", Polished Nickel	
166465	K-45982-2BZ	60", Oil-Rubbed Bronze	

Awaken® Smooth Shower Hose



Part #	Mfg #	Description	Price
183660	K-98359-BN	60", *Brushed Nickel	
188511	K-98359-CP	60", Polished Chrome	
187934	K-98359-2BZ	60", Oil-Rubbed Bronze	
178070	K-98360-2BZ	72", Oil-Rubbed Bronze	

Showerarm-Mount Handshower Cradles

Artifacts® Wall-Mount Handshower Holder with Supply Elbow

- Mounts to the end of showerarm
- Bracket pivots and rotates
- Includes check valve for backflow prevention



Part #	Mfg #	Description	Price
163763	K-72797-BN	*Brushed Nickel	
181401	K-72797-BV	*Brushed Bronze	
166447	K-72797-CP	Polished Chrome	
174117	K-72797-SN	*Polished Nickel	
225785	K-72797-VNT	Vintage Nickel	
171399	K-72797-2BZ	Oil-Rubbed Bronze	

Awaken® Handshower Cradle

- Mounts to the end of showerarm
- Brass ball joint pivots



Part #	Mfg #	Description	Price
160284	K-98771-BN	*Brushed Nickel	
160266	K-98771-CP	Polished Chrome	

* Vibrant Limited Lifetime Warranty

www.waterconcepts.net • Serving our Customers Since 1946 • www.plumbsupply.com

Personal Showers & Accessories

Shower Supply Elbows

Artifacts® Wall-Mount Supply Elbow



Part #	Mfg #	Description	Price
174432	K-72796-BN	*Brushed Nickel	
177297	K-72796-BV	*Brushed Bronze	
173113	K-72796-CP	Polished Chrome	
165048	K-72796-SN	*Polished Nickel	
168458	K-72796-2BZ	Oil-Rubbed Bronze	

Awaken® Wall-Mount Supply Elbow

- (98351) Models include check valve



Part #	Mfg #	Description	Price
165689	K-98350-BN	*Brushed Nickel	
173207	K-98350-CP	Polished Chrome	
167878	K-98351-CP	Polished Chrome	
183061	K-98351-BN	*Brushed Nickel	

Bancroft™ Wall-Mount Supply Elbow



Part #	Mfg #	Finish	Price
106261	K-10574-BN	*Brushed Nickel	
103946	K-10574-BV	*Brushed Bronze	
102542	K-10574-CP	Polished Chrome	
100057	K-10574-SN	*Polished Nickel	
147025	K-10574-2BZ	Oil Rubbed Bronze	

Forté® Wall-Mount Supply Elbow



Part #	Mfg #	Finish	Price
105761	K-355-AF	*French Gold	
090513	K-355-BN	*Brushed Nickel	
092041	K-355-BV	*Brushed Bronze	
097251	K-355-CP	Polished Chrome	
099437	K-355-G	Brushed Chrome	
099028	K-355-PB	*Polished Brass	
135072	K-355-SN	*Polished Nickel	
156623	K-355-2BZ	Oil-Rubbed Bronze	

MasterShower® Wall-Mount Supply Elbow



Part #	Mfg #	Finish	Price
081475	K-9513-AF	*French Gold	
056367	K-9513-BN	*Brushed Nickel	
073981	K-9513-BV	*Brushed Bronze	
054687	K-9513-CP	Polished Chrome	
056357	K-9513-G	Brushed Chrome	
064220	K-9513-PB	*Polished Brass	
057110	K-9513-SN	*Polished Nickel	

Memoirs® Wall-Mount Supply Elbow



Part #	Mfg #	Finish	Price
095287	K-427-BN	*Brushed Nickel	
101359	K-427-BV	*Brushed Bronze	
097990	K-427-CP	Polished Chrome	
165829	K-427-2BZ	Oil-Rubbed Bronze	

* Vibrant Limited Lifetime Warranty

www.plumbsupply.com • Serving our Customers Since 1946 • www.waterconcepts.net

Personal Showers & Accessories

Faucets & Valves

Stillness® Wall-Mount Supply Elbow



Part #	Mfg #	Finish	Price
093408	K-976-BN	*Brushed Nickel	
099896	K-976-BV	*Brushed Bronze	
094454	K-976-CP	Polished Chrome	
111916	K-976-SN	*Polished Nickel	

Handshower Wall Brackets

Awaken® Handshower Wall Bracket



Part #	Mfg #	Description	Price
165688	K-98348-BN	*Brushed Nickel	
166723	K-98348-CP	Polished Chrome	

Bancroft® Adjustable Handshower Wall Bracket



Part #	Mfg #	Description	Price
106286	K-10599-BKB	Brushed Black	
106260	K-10599-BN	*Brushed Nickel	
103947	K-10599-BV	*Brushed Bronze	
105303	K-10599-CP	Polished Chrome	
100056	K-10599-SN	Polished Nickel	
147026	K-10599-2BZ	Oil-Rubbed Bronze	

Exhale® Wall-Mount Handshower Holder

- Includes check valve for backflow prevention
- Integrated handshower bracket fits most handshowers



Part #	Mfg #	Description	Price
228093	K-98354-BN	Brushed Nickel	
226968	K-98354-CP	Polished Chrome	

Forté® Adjustable Handshower Wall Bracket



Part #	Mfg #	Description	Price
105760	K-352-AF	*French Gold	
090512	K-352-BN	*Brushed Nickel	
092040	K-352-BV	*Brushed Bronze	
097252	K-352-CP	Polished Chrome	
101753	K-352-G	Brushed Chrome	
099029	K-352-PB	Polished Brass	
135071	K-352-SN	Polished Nickel	
156622	K-352-2BZ	Oil-Rubbed Bronze	

Loure® Wall-Mount Handshower Holder



Part #	Mfg #	Description	Price
134412	K-14791-BN	*Brushed Nickel	
139095	K-14791-CP	Polished Chrome	
183016	K-14791-SN	*Polished Nickel	

Memoirs® Adjustable Wall-Mount Bracket



Part #	Mfg #	Description	Price
093412	K-422-BN	*Brushed Nickel	
116360	K-422-BV	*Brushed Bronze	
097989	K-422-CP	Polished Chrome	
165828	K-422-2BZ	Oil-Rubbed Bronze	

MasterShower® Fixed Wall-Mount Bracket



Part #	Mfg #	Description	Price
096186	K-8515-AF	*French Gold	
062696	K-8515-BN	*Brushed Nickel	
076706	K-8515-BV	*Brushed Bronze	

* Vibrant Limited Lifetime Warranty

www.waterconcepts.net • Serving our Customers Since 1946 • www.plumbsupply.com

Personal Showers & Accessories

Handshower Wall Brackets (Continued)

MasterShower® Fixed Wall-Mount Bracket

Part #	Mfg #	Description	Price
053895	K-8515-CP	Polished Chrome	
073078	K-8515-G	Brushed Chrome	
082245	K-8515-PB	Polished Brass	
122119	K-8515-SN	*Polished Nickel	

MasterShower® Adjustable Wall Bracket



Part #	Mfg #	Description	Price
074644	K-9515-BN	*Brushed Nickel	
094127	K-9515-BV	*Brushed Bronze	
060470	K-9515-CP	Polished Chrome	
061161	K-9515-G	Brushed Chrome	
089124	K-9515-PB	*Polished Brass	
182869	K-9515-SN	*Polished Nickel	

Stillness® Adjustable Wall-Mount Bracket



Part #	Mfg #	Description	Price
093407	K-975-BN	*Brushed Nickel	
094227	K-975-CP	Polished Chrome	
131006	K-975-SN	*Polished Nickel	

Toobi™ Wall-Mount Handshower Holder

- Pivots to keep handshower perfectly positioned
- Includes check valve for backflow prevention
- Handshower holder and wall supply into one



Part #	Mfg #	Description	Price
154353	K-8987-BN	*Brushed Nickel	
150833	K-8987-CP	Polished Chrome	

Showerarm Diversers

Awaken® Showerarm Diverter

- Switches water between showerhead or handshower, or both at same time.
- Mounts on end of showerarm
- Showerarm not included



Part #	Mfg #	Description	Price
160428	K-98770-BN	*Brushed Nickel	
160265	K-98770-CP	Polished Chrome	

HydroRails®

HydroRail® Wall-Mount -H Shower/Bath Column

- For use with shower only installations
- Converts fixed showerhead to a handshower and sidebar combo
- Adjustable sidebar bracket
- Includes: column, bracket, and sidebar
- Handshower and hose sold separately



27" Bar

Part #	Mfg #	Description	Price
223373	K-45903-SN	*Polished Nickel	

18" Bar

Part #	Mfg #	Description	Price
183272	K-45904-CP	Polished Chrome	

HydroRail® Wall-Mount -R Beam Shower Column

- For use in shower only installations
- (2) Position diverter for rainhead showerhead or handshower operation
- Check valve installed in diverter valve for backflow prevention



Part #	Mfg #	Description	Price
153560	K-45212-BN	*Brushed Nickel	
155348	K-45212-CP	Polished Chrome	
183571	K-45212-SN	*Polished Nickel	
187820	K-45212-2BZ	Oil-Rubbed Bronze	

* Vibrant Limited Lifetime Warranty

www.plumbsupply.com • Serving our Customers Since 1946 • www.waterconcepts.net

Personal Showers & Accessories

Faucets & Valves

HydroRail® -R Beam Bath/Shower Column

- For use in bath and shower installations
- Adjustable slidebar bracket
- Showerhead, handshower, and hose sold separately



Part #	Mfg #	Description	Price
156213	K-45210-BN	*Brushed Nickel	
154955	K-45210-CP	Polished Chrome	
172660	K-45210-2BZ	Oil Rubbed Bronze	

HydroRail® -S Bath/Shower Column

- For use in bath and shower installations
- (2) Position diverter for rainhead, showerhead, or handshower operation
- Check valve installed in diverter valve for backflow prevention



Part #	Mfg #	Description	Price
171873	K-45905-BN	*Brushed Nickel	
158627	K-45905-CP	Polished Chrome	
224086	K-45905-SN	*Polished Nickel	
173098	K-45905-2BZ	Oil-Rubbed Bronze	

HydroRail® Wall-Mount -R Arch Shower Column

- For use in shower installations
- Adjustable slidebar bracket
- Diverter at base of column for toggling between handshower and rainhead
- Showerhead, handshower, and hose sold separately



Part #	Mfg #	Description	Price
147926	K-45211-BN	*Brushed Nickel	
147754	K-45211-CP	Polished Chrome	
161085	K-45211-2BZ	Oil-Rubbed Bronze	

-S Shower HydroRail®

- For use in shower installations
- Slidebar bracket
- Diverter for easy toggling between handshower and showerhead
- Showerhead, handshower, and hose sold separately



Part #	Mfg #	Description	Price
169699	K-45906-BN	*Brushed Nickel	
171042	K-45906-CP	Polished Chrome	
222214	K-45906-SN	*Polished Nickel	
189562	K-45906-2BZ	Oil-Rubbed Bronze	

HydroRail® -R Arch Bath and Shower Column

- For use in bath and shower installations
- (2) Position diverter for rainhead, showerhead or handshower operation
- Check valve installed in diverter valve for backflow prevention



Part #	Mfg #	Description	Price
166320	K-45209-BN	*Brushed Nickel	
153864	K-45209-CP	Polished Chrome	
173805	K-45209-2BZ	Oil-Rubbed Bronze	

HydroRail-S™ Shower Column Kit with Awaken®

- For use in shower installations
- MasterClean™ sprayface
- Slidebar bracket
- Diverter for easy toggling between handshower and showerhead
- Patent-pending technology
- Includes K-72419 Awaken® showerhead, K-72415 Awaken® handshower, K-45906 HydroRail-S™ shower column, and K-45982 Awaken® 60" ribbon hose
- WaterSense® certified product: 2.0 gpm



Part #	Mfg #	Description	Price
190495	K-76471-BN	*Brushed Nickel	

* Vibrant Limited Lifetime Warranty

www.waterconcepts.net • Serving our Customers Since 1946 • www.plumbsupply.com

Personal Showers & Accessories

HydroRails® (Continued)

HydroRail-S™ Shower Column Kit with Awaken®

Part #	Mfg #	Description	Price
189969	K-76471-CP	Polished Chrome	

HydroRail-R™ Arch Shower Column Kit with Moxie® Rainhead & Flipside® Handshower

- Premium metal construction
- Slidebar bracket
- Diverter at base
- Moxie® Syncs with Bluetooth®
- Includes K-99105-E Moxie rainhead, K-45425 Flipside handshower, K-45211 HydroRail-R arch shower column, and K-9514 MasterShower® 60-inch metal hose
- WaterSense® certified product: 2.0 gpm



Part #	Mfg #	Description	Price
224759	K-76475-2BZ	Oil-Rubbed Bronze	

* Vibrant Limited Lifetime Warranty

www.plumbsupply.com • Serving our Customers Since 1946 • www.waterconcepts.net

Personal Showers & Accessories

Faucets & Valves

Diverter Trim for Deck Mount Tub Faucets

Bancroft® Deck-Mount Handshower Holder

- Handshower sold separately
- Hoses included



Part #	Mfg #	Description	Price
100092	K-10573-BN	*Brushed Nickel	
110809	K-10573-BV	*Brushed Bronze	
105020	K-10573-CP	Polished Chrome	
116738	K-10573-SN	*Polished Nickel	
147024	K-10573-2BZ	Oil-Rubbed Bronze	

Forté® Deck-Mount Handshower Holder

- Handshower sold separately
- Hoses Included



Part #	Mfg #	Description	Price
118966	K-368-AF	*French Gold	
094725	K-368-BN	*Brushed Nickel	
106792	K-368-BV	*Brushed Bronze	
098058	K-368-CP	Polished Chrome	
113092	K-368-G	Brushed Chrome	
161690	K-368-2BZ	Oil-Rubbed Bronze	

Loure® Bath- or Deck-Mount 2-Way Diverter Valve

- Valve has backflow protection
- 2-3/8" High, 2-1/2" width
- Can be mounted up to 1-1/4" thickness



Part #	Mfg #	Description	Price
150899	K-14677-BN	*Brushed Nickel	
142805	K-14677-CP	Polished Chrome	

Loure® Bath- or Deck-Mount Handshower Holder

- Handshower sold separately
- Hoses included



Part #	Mfg #	Description	Price
134406	K-14789-BN	*Brushed Nickel	
142806	K-14789-CP	Polished Chrome	

**Diverter Trim for Deck Mount Tub Faucets
(Continued)**

Loure® Bath- or Deck-Mount Handshower Holder

Part #	Mfg #	Description	Price
223374	K-14789-SN	*Polished Nickel	

Memoirs® Deck-Mount Handshower Holder

- Handshower sold separately
- Hoses included



Part #	Mfg #	Description	Price
097074	K-424-BN	*Brushed Nickel	
114262	K-424-BV	*Brushed Bronze	
094596	K-424-CP	Polished Chrome	

Stillness® Bath- or Deck-Mount Handshower Holder

- Handshower sold separately
- Hoses included



Part #	Mfg #	Description	Price
094120	K-977-BN	*Brushed Nickel	
093466	K-977-CP	Polished Chrome	

Deck-Mount Handshower Holder

- Handshower sold separately
- Hoses included



Part #	Mfg #	Description	Price
086889	K-8548-AF	*French Gold	
064421	K-8548-BN	*Brushed Nickel	
107912	K-8548-BV	*Brushed Bronze	
056216	K-8548-CP	Polished Chrome	
058423	K-8548-PB	*Polished Brass	
151104	K-8548-SN	*Polished Nickel	

* Vibrant Limited Lifetime Warranty

www.waterconcepts.net • Serving our Customers Since 1946 • www.plumbsupply.com

Personal Showers & Accessories

Bath- or Deck-Mount 2-Way Diverter Valve with Handshower Cradle

- Handshower sold separately
- Valve has backflow protection
- 69" decorative hose included
- 36" high-pressure hose included
- Flow rate: 15 gpm with 1/2" lines
25 gpm with 3/4" lines



Part #	Mfg #	Description	Price
087365	K-8549-AF	*French Gold	
059247	K-8549-BN	*Brushed Nickel	
073983	K-8549-BV	* Brushed Bronze	
054122	K-8549-CP	Polished Chrome	
056904	K-8549-G	Brushed Chrome	
055649	K-8549-PB	*Polished Brass	
086142	K-8549-SN	* Polished Nickel	

Bath- or Deck-Mount 2-Way Diverter Valve

- Handshower sold separately
- Valve has backflow protection
- 69" Decorative hose included
- 36" High-pressure hose included
- Flow rate: 15 gpm with 1/2" lines
25 gpm with 3/4" lines



Part #	Mfg #	Description	Price
086888	K-9530-AF	*French Gold	
059882	K-9530-BN	*Brushed Nickel	
075015	K-9530-BV	*Brushed Bronze	
058400	K-9530-CP	Polished Chrome	
072798	K-9530-G	Brushed Chrome	
066446	K-9530-PB	*Polished Brass	
111917	K-9530-SN	*Polished Nickel	

Deck-Mount Transfer Valve/Vacuum Breaker

- Trim only, valve not included

Required Valve 408-K or 409-K



Part #	Mfg #	Description	Price
092009	K-T9540-4-BN	*Brushed Nickel	
116578	K-T9540-4-CP	Polished Chrome	

* Vibrant Limited Lifetime Warranty

www.plumbsupply.com • Serving our Customers Since 1946 • www.waterconcepts.net

Personal Showers & Accessories

Faucets & Valves

Handshowers

Baliza® Wall-Mount Handheld Shower

- 3-Function handshower:
 - Full
 - Massage
 - Aerated spray
- Touch-Clean® nozzles
- Wall elbow included
- 60" - 82" Stretchable metal hose
- WaterSense® certified product: 2.0 gpm @ 80 psi



Part #	Mfg #	Description	Price
175332	85810-BN	Brushed Nickel*	
171320	85810-BZ	Brushed Bronze*	
173270	85810-PC	Chrome	
177180	85810-RB	Venetian Bronze®	

Charlotte® Wall-Mount Handheld Shower

- Single function spray
- 60" - 82" Stretchable metal hose
- Wall mount bracket and elbow included
- WaterSense® certified product: 2.0 gpm @ 80 psi



Part #	Mfg #	Description	Price
156699	85885-PNCO	Cocoa Bronze & Pol Nickel	

Odin™ Wall-Mount Handheld Shower

- Single-function handshower
- H2Okinetic® technology with self-cleaning spray holes
- 60"-82" Stretchable metal hose
- Wall mount bracket and elbow included
- WaterSense® certified product: 2.0 gpm @ 80 psi



Part #	Mfg #	Description	Price
157996	88875-BN	Brushed Nickel*	

Rook™ Wall-Mount Handshower

- Three-function handshower
 - H2Okinetic® spray
 - Massage spray
 - Pause
- H2Okinetic® technology
- 60"-82" Stretchable metal hose
- Wall-mount bracket with integrated hose connection
- Watersense® certified product: 2.0 gpm @ 80 psi



Part #	Mfg #	Description	Price
223097	88861-NKBL	Luxe Nickel/Matte Black	
227076	88861-NK	Luxe Nickel	
226799	88861-RB	Venetian Bronze®	

Siderna® Wall-Mount Handheld Shower

- Single function spray
- 60" - 82" Stretchable metal hose
- Wall mountable elbow included
- WaterSense® certified product: 2.0 gpm @ 80 psi



Part #	Mfg #	Description	Price
188214	85880-BN	Brushed Nickel*	

Sotria™ Wall-Mount Handheld Shower

- Single-function handshower
- 60" - 82" Stretchable metal hose
- Wall elbow and bracket included
- WaterSense® certified product: 2.0 gpm @ 80 psi



Part #	Mfg #	Description	Price
181333	88850-NK	Luxe Nickel*	
184226	88850-PC	Chrome	
228063	88850-PN	Polished Nickel	

* Brilliance® Anti-Tarnish Lifetime Finishes

Personal Showers & Accessories

Vesi® Wall-Mount Handheld Shower

- Single function spray
- Solid brass construction
- 60"-82" Stretchable metal hose
- WaterSense® certified product: 2.0 gpm @ 80 psi
- Requires wall mount elbow (RP36004) sold separately



Charlotte™ Slide Bar Handheld Shower

- Single function spray
- 23-1/4" Long slide bar
- 60" - 82" Stretchable metal hose
- Wall mount elbow included
- WaterSense® certified product: 2.0 gpm @ 80 psi



Part #	Mfg #	Description	Price
086433	RP41202-BN	Brushed Nickel*	
170633	RP41202-RB	Venetian Bronze®	

Part #	Mfg #	Description	Price
155371	85785-BN	Brushed Nickel*	
171233	85785-PC	Chrome	
147477	85785-PNCO	Cocoa Bronze & Pol Nickel	

Virage® Wall-Mount Handheld Shower

- Single function handshower
- Touch-Clean® nozzles
- 60" - 82" Stretchable metal hose
- Wall mount bracket and elbow included
- WaterSense® certified: 2.0 gpm @ 80 psi



Part #	Mfg #	Description	Price
145294	85830-BN	Brushed Nickel*	
135232	85830-BZ	Brushed Bronze*	
129972	85830-PC	Chrome	
165832	85830-PN	Polished Nickel*	
161086	85830-RB	Venetian Bronze®	

Euro Slide Bar Handheld Shower

- Three-function handshower
- Full
- Massage
- Aerated spray
- 35" Long slide bar
- 60"-82" Stretchable metal hose
- Handshower includes wall mount elbow
- WaterSense® certified product: 2.0 gpm @ 80 psi



Part #	Mfg #	Description	Price
188613	85521-BL	Matte Black	
135873	85521-BN	Brushed Nickel*	

Handshower with Slidebars

Baliza® Slide Bar Handheld Shower

- Single-function handshower
- 23-1/4" Long slidebar w/ adjustable slide
- 60"-82" Stretchable metal hose
- Wall mount elbow included
- WaterSense® certified: 2.0 gpm @ 80 psi



Part #	Mfg #	Description	Price
184792	85710-BN	Brushed Nickel*	
171584	85710-PC	Polished Chrome	
175146	85710-PN	Polished Nickel*	
170981	85710-RB	Venetian Bronze®	

Odin™ Slide Bar Handheld Shower

- Single function handshower
- H2Okinetic® technology with self-cleaning spray holes
- 60"-82" metal hose
- 24" Long slide bar
- Wall mount elbow included
- WaterSense® certified: 2.0 gpm @ 80 psi



Part #	Mfg #	Description	Price
162482	88775-BL	Matte Black	
165339	88775-BN	Brushed Nickel*	

* Brilliance® Anti-Tarnish Lifetime Finishes

www.plumbsupply.com • Serving our Customers Since 1946 • www.waterconcepts.net

Personal Showers & Accessories

Faucets & Valves

Rook™ Slide Bar Handheld Shower

- Three-function handshower
-Spray
-Massage spray
-Pause
- H2Okinetic® technology with self-cleaning spray holes
- 60"-82" Metal hose
- 26-3/4" Long slide bar
- WaterSense® certified:
2.0 gpm @ 80 psi



Part #	Mfg #	Description	Price
185781	88761-NK	Luxe Nickel*	
188716	88761-NKBL	Luxe Nickel*/Matte Black	
188965	88761-PC	Polished Chrome	
222753	88761-RB	Venetian Bronze	

Sotria® Wall-Mount Handheld Shower

- Single function handshower
- H2Okinetic® technology with self-cleaning spray holes
- 18-3/8" Long slide bar
- 60" - 82" Stretchable metal hose
- Wall elbow included
- WaterSense® certified product:
2.0 gpm @ 80 psi



Part #	Mfg #	Description	Price
177376	88750-BL	Matte Black	
223947	88750-NK	Luxe Nickel*	
184217	88750-PC	Polished Chrome	

Virage® Slide Bar Handheld Shower

- Single function spray
- 24" Long slide bar
- 60"-82" Stretchable metal hose
- WaterSense® certified:
2.0 gpm @ 80 psi



Part #	Mfg #	Description	Price
143200	85730-BN	Brushed Nickel*	
158222	85730-BZ	Brushed Bronze*	
137212	85730-PC	Polished Chrome	
159771	85730-RB	Venetian Bronze®	

RSVP® Slide Bar Handheld Shower

- Single-function handshower
- 60"-82" Stretchable metal hose
- 34" Long slide bar
- Includes vacuum breaker and wall mount elbow
- WaterSense® certified product:
2.0 gpm @ 80 psi



Part #	Mfg #	Description	Price
119122	89710-PC	Polished Chrome	

Siderna® Wall-Mount Handheld Shower

- Single-function handshower
- Touch-Clean® nozzles
- 25" Long slide bar with adjustable slide
- 60" - 82" Stretchable metal hose
- Wall elbow included
- WaterSense® certified product:
2.0 gpm @ 80 psi



Part #	Mfg #	Description	Price
176444	85780-BN	Brushed Nickel*	
169305	85780-PC	Polished Chrome	

* Brilliance® Anti-Tarnish Lifetime Finishes

www.waterconcepts.net • Serving our Customers Since 1946 • www.plumbsupply.com

Personal Showers & Accessories

Handshowers

ActivTouch® Handshower

- Handshower only, less hose (59424)
- Handshower w/ 60"-82" hose (55424)
- Plated spray face
- Push button spray selection
- 2.5 gpm @ 80 psi (55424, 59424)
- 2.0 gpm @ 80 psi (59424-20)
- 9-Setting handshower:
 - Pause
 - Fast massage
 - Full spray with massage
 - Soft drench spray
 - Soft drench spray with massage
 - Soft full spray
 - Shampoo rinsing spray
 - Shampoo rinsing spray with massage
 - Full body spray



Part #	Mfg #	Finish	Price
146610	55424	Chrome	
159508	55424-RB	Venetian Bronze®	
134980	55424-SS	Stainless*	
143067	59424-PK	Chrome	
165001	59424-RB	Venetian Bronze®	
147870	59424-SS	Stainless*	
185741	59424-20-PK	2.0 gpm, Chrome	

Ara™ Wall-Mount Handshower

- Single setting H2Okinetic®
- Self-cleaning spray holes
- 60" -82" Stretchable metal hose
- 2.0 gpm @ 80 psi



Part #	Mfg #	Finish	Price
168496	55567	Chrome	
165294	55567-SS	Stainless*	

Cassidy™ Handshower

- 3-Setting
- Self-cleaning spray holes
- Handshower ONLY
- WaterSense® certified product:
2.0 gpm @ 80 psi



Part #	Mfg #	Finish	Price
189823	59433-PK	Chrome	

Handshowers (Continued)

Cassidy™ Handshower

Part #	Mfg #	Finish	Price
187689	59433-CZ-PK	Champagne Bronze™	
159595	59433-RB-PK	Venetian Bronze®	
166258	59433-SS-PK	Stainless*	

Cassidy™ Wall-Mount Handshower

- Adjustable wall mount
- Self-cleaning spray holes
- 60" to 82" Stretchable metal hose
- 3-Setting handshower:
 - Pause
 - H2Okinetic® spray
 - Massage spray



Part #	Mfg #	Finish	Price
155252	55433	Chrome	
170383	55433-CZ	Champagne Bronze™	
165670	55433-PN	Polished Nickel*	
151570	55433-RB	Venetian Bronze®	
151703	55433-SS	Stainless*	

Cassidy™ Shower-Mount Handshower

- Self-cleaning H2Okinetic® spray
- 60" - 82" Stretchable metal hose
- 3-Setting handshower
- Shower arm mount
- Shower arm and flange sold separately
- WaterSense® certified product:
2.0 gpm @ 80 psi



Part #	Mfg #	Finish	Price
159428	54433-PK	Chrome	
156181	54433-CZ-PK	Champagne Bronze™	
156096	54433-SS-PK	Stainless*	

Classic Arm-Mount Handshower

- (5) Spray settings
- High-velocity eco spray
- 60" UltraFlex hose
- 0.5 gpm @ 80 psi
- Meets EPA WaterSense® criteria



Part #	Mfg #	Finish	Price
144315	54434-20-PK	Chrome	

* Brilliance® Anti-Tarnish Lifetime Finishes

www.plumbsupply.com • Serving our Customers Since 1946 • www.waterconcepts.net

Personal Showers & Accessories

Faucets & Valves

Handshowers (Continued) Classic Arm-Mount Handshower

Part #	Mfg #	Finish	Price
144460	54434-SS20-PK	Stainless*	

Classic White Shower-Mount Handshower

- Full body spray pattern plus pause
- 2.5 gpm @ 80 psi



Part #	Mfg #	Finish	Price
058413	59344-B-PK	Chrome	
001193	59344-WHB-PK	White	

Classic 3-Setting Shower-Mount Handshower

- Spray settings:
 - Full body
 - Fast massage
 - Full spray w/ massage
- WaterSense® certified: 2.0 gpm



Part #	Mfg #	Finish	Price
174086	54471-20-BG	Chrome	

Classic Shower-Mount Handshower

- (6) Spray patterns plus pause
- 2.5 gpm @ 80 psi
- 60" UltraFlex® hose



Part #	Mfg #	Finish	Price
149486	59345-PK	Chrome	
149232	59345-SS-PK	Stainless	
143874	59345-RB-PK	Venetian Bronze	
001194	59345-WH-PK	White	

Classic Palm® Shower-Mount Handshower

- Change spray modes with pushbutton
- Includes double check valves for backflow prevention
- Maximum flow: 2.5 gpm @ 80 psi
- Less mount and hose (59456-PK)



Part #	Mfg #	Finish	Price
166769	54456-PK	Chrome	
145936	54456-SS-PK	Stainless*	
147742	59456-PK	Chrome, Less Hose	
166862	59456-SS-PK	Stainless*, Less Hose	

Classic Touch-Clean® Handshower

- 2.5 gpm @ 80 psi
- Spray settings:
 - Full body spray
 - Fast massage
 - Full spray with massage
 - Pause
 - Soft drench spray
 - Shampoo rinsing spray



Part #	Mfg #	Finish	Price
150285	59425-RB-PK	Venetian Bronze®	
016785	59425-WH-PK	White	
147229	59425-PB-PK	Polished Brass*	

Classic Shower-Mount Handshower

- 2.5 gpm @ 80 psi
- Spray settings:
 - Full body spray
 - Fast massage
 - Full spray with massage
 - Soft drench spray
 - Shampoo rinsing spray



Part #	Mfg #	Finish	Price
033016	59435-PK	Chrome, less Hose	
157574	59435-SS-PK	Stainless Steel, less Hose	

* Brilliance® Anti-Tarnish Lifetime Finishes

www.waterconcepts.net • Serving our Customers Since 1946 • www.plumbsupply.com

Personal Showers & Accessories

Classic Handshower - 4-Spray

- Spray settings:
 - Full body spray
 - Massaging spray
 - Crossing full spray
 - Crossing full spray with massage
- 2.5 gpm (59456)
- 2.0 gpm (59465-20)



Part #	Mfg #	Finish	Price
001206	59465-PK	Chrome	
182015	59465-WH-PK	White	
157498	59465-20-PK	Chrome	

Classic Adjustable Spray Handshower

- 2.5 gpm @ 80 psi
- Adjusts from wide to narrow spray
- Acrylic handle



Part #	Mfg #	Finish	Price
176381	59480	Chrome, 2.5 gpm	

Single-Setting Hand Shower



Part #	Mfg #	Finish	Price
139142	RP46680	Chrome	

Classic ADA Handshower

- ADA Compliant
- Spray settings:
 - Full body spray
 - Pause
- 2.5 gpm (59462)
- 2.0 gpm (59462-20)
- 1.5 gpm (59462-15)



59462-B

59462-WHB

Part #	Mfg #	Finish	Price
001202	59462-WH-PK	White, 2.5 gpm	
001201	59462-B-PK	Chrome, 2.5 gpm	
001200	59462-WHB-PK	White, 2.5 gpm	
158279	59462-WH15-PK	White, 1.5 gpm	
172897	59462-WH20-PK	White, 2.0 gpm	
153370	59462-B15-BG	Chrome, 1.5 gpm	
156070	59462-WHB15-BG	White, 1.5 gpm	

Classic Fixed Wall-Mount 5-Spray Handshower

- (5) Spray settings
- 2.5 gpm @ 80 psi
- 60" UltraFlex hose



Part #	Mfg #	Finish	Price
045357	55435-PK	Chrome	

Classic Handshower

- Spray settings:
 - Full body spray
 - Fast massage
 - Full spray with massage
 - High efficiency
 - Pause
- 2.0 gpm

59434-20



Part #	Mfg #	Finish	Price
147518	59434-20-PK	Chrome	
151187	59434-SS20-PK	Stainless	

Classic Fixed Wall-Mount Handshower

- Full spray pattern with pause
- 2.5 gpm @ 80 psi



59410-B-PK

Part #	Mfg #	Finish	Price
001182	59410-B-PK	Chrome	
001183	59410-WHB-PK	White	

* Brilliance® Anti-Tarnish Lifetime Finishes

www.plumbsupply.com • Serving our Customers Since 1946 • www.waterconcepts.net

Personal Showers & Accessories

Faucets & Valves

Universal Shower-Mount Handshower

- 2-Setting
- Touch-Clean® spray holes
- 60" UltraFlex® hose
- Shower arm mount
- Shower arm and flange sold separately
- Push button trickle
- WaterSense® certified product: 2.0 gpm @ 80 psi



Part #	Mfg #	Finish	Price
161733	59344-B20-PK	Chrome	
167509	59344-WHB20-PK	White	

Contemporary ActivTouch® Wall-Mount Handshower

- 60" to 82" Stretchable metal hose
- Adjustable Showerarm mount
- 9-Setting handshower:
 - Pause
 - Fast massage
 - Full spray with massage
 - Soft drench spray
 - Soft drench spray with massage
 - Soft full spray
 - Shampoo rinsing spray
 - Shampoo rinsing spray with massage
 - Full body spray
- 2.5 gpm (54424)
2.0 gpm (54424-20)



Part #	Mfg #	Finish	Price
147151	54424-PK	Chrome	
147741	54424-SS-PK	Stainless*	
162115	54424-RB-PK	Venetian Bronze®	
151029	54424-SS20-PK	Stainless*	
146834	54424-20-PK	Chrome,	

Classic Wall-Mount Handshower

- Single-setting
- Touch-Clean® spray holes
- 60" UltraFlex® hose
- 2.5 gpm @ 80 psi



Part #	Mfg #	Finish	Price
156921	59310-WH-PK	White	

Delta Showerarm-Mount Handshower

- 3-Function handshower
- 69" Long hose
- Dual check valves
- Maximum flow: 2.5 gpm @ 80 psi



Part #	Mfg #	Finish	Price
089806	56613	Chrome	
173091	56613-CZ	Champagne Bronze™	
145597	56613-RB	Venetian Bronze®	
101750	56613-SS	Stainless*	

Classic Fixed Wall-Mount Handshower

- 4-Setting handshower
- 60" UltraFlex® hose



Part #	Mfg #	Finish	Price
001213	59348-PK	Chrome	
186138	59348-WH-PK	White	

Delta Single-Function Wall-Mount Handshower

- 69" Long flexible hose with brass connections
- Dual check valves
- 2.0 gpm @ 80 psi
- Full body spray



Part #	Mfg #	Finish	Price
139704	55011	Chrome	

* Brilliance® Anti-Tarnish Lifetime Finishes

www.waterconcepts.net • Serving our Customers Since 1946 • www.plumbsupply.com

Personal Showers & Accessories

Delta Single-Function Wall-Mount Handshower

- 69" Long flexible hose with brass connections
- Dual check valves
- 2.0 gpm @ 80 psi
- Full body spray



Part #	Mfg #	Finish	Price
135452	55013	Chrome	
137767	55013-RB	Venetian Bronze®	
139373	55013-SS	Stainless*	

Delta Five-Function Wall-Mount Handshower

- 69" Flexible hose with brass connections
- Certified dual check valves
- 2.5 gpm @ 80 psi
- (5) Functions:
 - Full body spray
 - Massage spray
 - Full spray with massage
 - Soft drench spray
 - Soft drench spray with massage



Part #	Mfg #	Finish	Price
143533	55021	Chrome	
145827	55021-CZ	Champagne Bronze™	
142776	55021-RB	Venetian Bronze®	
143493	55021-SS	Stainless*	

Addison Single-Function Wall-Mount Handshower

- 60" - 82" Stretchable metal hose
- Dual check valves
- 2.0 gpm @ 80 psi
- Full body spray



Part #	Mfg #	Finish	Price
129270	57923	Chrome	
139330	57923-CZ	Champagne Bronze™	
126352	57923-RB	Venetian Bronze®	
128925	57923-SS	Stainless*	

Compel Wall-Mount Handshower

- Single-setting
- 2.5 gpm @ 80 psi
- 60" - 82" Stretchable metal hose
- Wall-mounting bracket included
- Dual check valves



Part #	Mfg #	Finish	Price
136176	55085	Chrome	
136500	55085-SS	Stainless*	
158971	55085-RB	Venetian Bronze®	

Delta Full Spray Push Button Handshower

- Push button pause control
- TouchClean®



Part #	Mfg #	Finish	Price
150233	75009WH	White, less Hose	

Handshower - 3-Setting



Part #	Mfg #	Finish	Price
162711	RP48769RB	Venetian Bronze®	

Handshower - Single Setting

- Handshower ONLY



Part #	Mfg #	Finish	Price
155274	RP46683SS	Stainless*	

* Brilliance® Anti-Tarnish Lifetime Finishes

www.plumbsupply.com • Serving our Customers Since 1946 • www.waterconcepts.net

Personal Showers & Accessories

Faucets & Valves

Dryden™ Wall-Mount Single-Function Handshower

- 69" Long flexible hose with brass connections
- 2.0 gpm @ 80 psi
- Full body spray
- Certified dual check valves
- Includes mounting bracket



Part #	Mfg #	Finish	Price
137501	55051	Chrome	
166666	55051-CZ	Champagne Bronze™	
176966	55051-PN	Polished Nickel*	
135703	55051-SS	Stainless*	
136731	55051-RB	Venetian Bronze®	

Ribbon Wall-Mount Handshower

- Single-setting H2Okinetic®
- 60" - 82" Stretchable hose
- Face rotates 360°
- Adjustable wall mount
- Maximum flow: 2.0 gpm @ 80 psi



Part #	Mfg #	Finish	Price
175118	55421	Chrome	
169731	55421-RB	Venetian Bronze®	
158686	55421-SS	Stainless*	
165991	59421-PK	Handshower ONLY, Chrome	

Leland® Wall-Mount Handshower

- 69" Long hose
- 2.0 gpm @ 80 psi
- Single-setting handshower: full body spray



Part #	Mfg #	Finish	Price
137030	55020	Chrome	
147480	55020-CZ	Champagne Bronze™	
137956	55020-RB	Venetian Bronze®	
134025	55020-SS	Stainless*	

Temp2O Shower-Mount Handshower

- LED digital temperature display powered by AAA batteries
- Soft, rubber spray holes
- Includes 60"-82" hose
- Spray settings:
 - Full body
 - Full spray with massage
 - Massaging
 - Shampoo rinsing
 - Shampoo rinsing with massage
 - Soft drench
- WaterSense® certified: 2.0 gpm @ 80 psi



Part #	Mfg #	Finish	Price
186896	54446-SS-PK	Stainless*	

Palm® Shower Mount Handshower

- 82" Long hose
- WaterSense® certified: 2.0 gpm @ 80 psi
- Pause feature
- Spray settings:
 - Full Body
 - Fast Massage
 - Full spray with massage



Part #	Mfg #	Finish	Price
189382	54488-PK	Chrome	

Temp2O Wall-Mount Handshower

- LED digital temperature display powered by AAA batteries
- Soft, rubber spray holes
- Includes 60"-82" hose
- Spray settings:
 - Full body
 - Full spray with massage
 - Massaging
 - Shampoo rinsing
 - Shampoo rinsing with massage
 - Soft drench
- WaterSense® certified: 2.0 gpm @ 80 psi



Part #	Mfg #	Finish	Price
190437	55446	Chrome	

* Brilliance® Anti-Tarnish Lifetime Finishes

www.waterconcepts.net • Serving our Customers Since 1946 • www.plumbsupply.com

Personal Showers & Accessories

Tesla Handshower

- 4-Setting H2Okinetic
- Touch-Clean spray holes
- Push-button spray selection
- 2.0 gpm @ 80 psi



Part #	Mfg #	Finish	Price
186786	59552-PK	Chrome	
182712	59552-SS-PK	Stainless*	

Tesla™ Wall-Mount Handshower

- 60" Metal hose
- 2.0 gpm @ 80 psi
- 4-Spray handshower
- Touch-Clean® nozzles
- H2Okinetic Technology® Handshower



Part #	Mfg #	Finish	Price
177024	55552	Chrome	

Traditional Adjustable Wall-Mount Handshower

- 5-Spray
- 60" to 82" Stretchable hose
- Moveable faceplate switches between spray patterns
- Maximum flow: 2.5 gpm @ 80 psi



Part #	Mfg #	Finish	Price
147254	59515	Chrome	
147184	59515-SS	Stainless*	
146300	59515-RB	Venetian Bronze®	
145373	59515-PB	Polished Brass	

Traditional Showerarm-Mount Handshower

- 5-Spray
- 60" to 82" Stretchable hose
- Moveable faceplate switches between spray patterns
- Maximum flow: 2.5 gpm @ 80 psi



Part #	Mfg #	Finish	Price
150927	59355-PK	Chrome	
147517	59355-RB-PK	Venetian Bronze®	
166674	59355-PB-PK	Polished Brass	

Traditional 5-Spray Handshower

- Less hose



Part #	Mfg #	Finish	Price
150676	59478-PK	Chrome	
147740	59478-RB-PK	Venetian Bronze®	
157447	59478-SS-PK	Stainless*	
157513	59478-PB-PK	Polished Brass	

Transitional Handshower

- 5-Setting H2Okinetic®
- Touch-Clean® spray holes
- Soft-touch handle
- Handshower ONLY
- WaterSense® certified product: 2.0 gpm @ 80 psi



Part #	Mfg #	Finish	Price
155333	59445-PK	Chrome	
159237	59445-CZ-PK	Champagne Bronze™	
157710	59445-RB-PK	Venetian Bronze®	
158017	59445-SS-PK	Stainless*	

* Brilliance® Anti-Tarnish Lifetime Finishes

www.plumbsupply.com • Serving our Customers Since 1946 • www.waterconcepts.net

Personal Showers & Accessories

Faucets & Valves

Transitional Shower-Mount Handshower

- Spray settings: pause, full body spray, full spray w/massage, H2Okinetic™ spray, massage spray
- Touch-Clean® spray holes
- Soft-Touch® handle
- Shower arm mount
- 60" to 82" Stretchable metal hose
- 28" Long wall bar w/ adjustable slide
- 2.0 gpm @ 80 psi



Part #	Mfg #	Finish	Price
157846	54445-PK	Chrome	
173185	54445-CZ-PK	Champagne Bronze™	
153956	54445-RB-PK	Venetian Bronze®	
154921	54445-SS-PK	Stainless*	

Transitional Wall-Mount Handshower

- Spray settings: pause, full body spray, full spray w/massage, H2Okinetic™ spray, massage spray
- Touch-Clean® spray holes
- Soft-Touch® handle
- Adjustable wall-mount
- 60" to 82" Stretchable metal hose
- 2.0 gpm @ 80 psi



Part #	Mfg #	Finish	Price
174192	55445	Chrome	
154980	55445-CZ	Champagne Bronze™	
157238	55445-RB	Venetian Bronze®	
157887	55445-SS	Stainless*	

Vero™ Wall-Mount Handshower

- Single-setting handshower
- 69" Long hose
- 2.5 gpm @ 80 psi



Part #	Mfg #	Finish	Price
139042	55530	Chrome	
135467	55530-SS	Stainless*	
150725	55530-RB	Venetian Bronze®	
143544	55530-CZ	Champagne Bronze™	

Fundamentals™ 4-Setting Shower Mount Handshower

- Touch-Clean® spray holes
- Spray settings:
 - Full body
 - Fast massage
 - Full spray with massage
 - Pause
- 2.5 gpm @ 80 psi



Part #	Mfg #	Finish	Price
148310	59202-PK	Chrome	

3-Function Shower Mount Handshower

- 69" Long hose
- 2.5 gpm @ 80 psi
- Full spray, massage spray & soft aerated spray patterns



54613

Part #	Mfg #	Finish	Price
099457	54613	Chrome	
172502	54613-CZ	Champagne Bronze™	
097286	54613-RB	Venetian Bronze®	
092346	54613-SS	Stainless*	
173715	RP48770CZ	Handshower Only, Champagne Bronze™	
152204	RP48770SS	Handshower Only, Stainless*	

5-Setting Shower Mount Handshower

- 60" Long hose
- Watersense® certified: 2.0 gpm @ 80 psi
- Touch-Clean® spray holes
- Spray settings:
 - Full body
 - Fast massage
 - Full spray w/ massage
 - Shampoo rinsing-Soft drench



Part #	Mfg #	Finish	Price
190226	54436-PK	Chrome	
189808	54436-SS-PK	Stainless*	

* Brilliance® Anti-Tarnish Lifetime Finishes

www.waterconcepts.net • Serving our Customers Since 1946 • www.plumbsupply.com

Personal Showers & Accessories

5-Setting Wall-Mount Handshower

- 60" Long hose
- WaterSense® certified: 2.0 gpm @ 80 psi
- Touch-Clean® spray holes
- Spray settings:
 - Full body
 - Full spray with massage
 - Massaging
 - Shampoo rinsing
 - Pause



Part #	Mfg #	Finish	Price
222979	55436-PK	Chrome	

5-Setting Handshower

- WaterSense® certified: 2.0 gpm @ 80 psi
- Touch-Clean® spray holes
- Spray settings:
 - Full body
 - Full spray with massage
 - Massaging
 - Shampoo rinsing
 - Pause



Part #	Mfg #	Finish	Price
190168	59436-PK	Chrome	
190170	59436-SS-PK	Stainless*	

7-Setting Shower Arm Mount Handshower

- 7-spray/massaging hand shower
- Touch-Clean spray holes
- 60" Long Hose
- WaterSense® certified: 2.0 gpm @ 80 psi



Part #	Mfg #	Finish	Price
189642	59346-PK	Chrome	
190398	59346-SS-PK	Stainless*	

7-Setting Handshower

- 7-spray/massaging hand shower
- Touch-Clean® spray holes
- WaterSense® certified: 2.0 gpm @ 80 psi



Part #	Mfg #	Finish	Price
222582	59426-PK	Chrome	
229504	59426-PB-PK	Polished Brass	
190500	59426-RB-PK	Venetian Bronze®	
222697	59426-SS-PK	Stainless*	

7-Setting Adjustable Wall-Mount Handshower

- 7-spray/massaging hand shower
- Touch-Clean® spray holes
- 60-82" Stretchable hose
- WaterSense® certified: 2.0 gpm @ 80 psi



Part #	Mfg #	Finish	Price
222656	59716-RB	Venetian Bronze®	
190416	59716-SS	Stainless*	

Handshowers with Slidebar

Addison® Slidebar Handshower

- 69" Long hose
- 24" Long wall bar with adjustable slide
- 2.0 gpm @ 80 psi
- All metal construction
- Single-setting handshower: full body spray



Part #	Mfg #	Finish	Price
127101	59210	Chrome	
137610	59210-CZ	Champagne Bronze™	
125983	59210-RB	Venetian Bronze®	
134062	59210-SS	Stainless*	

Faucets & Valves

* Brilliance® Anti-Tarnish Lifetime Finishes

www.plumbsupply.com • Serving our Customers Since 1946 • www.waterconcepts.net

Personal Showers & Accessories

Faucets & Valves

Ara™ Slidebar Handshower

- Single setting H2Okinetic®
- Self-cleaning spray holes
- 60"-82" Stretchable metal hose
- 28" Slidebar
- 2.0 gpm @ 80 psi



Part #	Mfg #	Finish	Price
167399	51567	Chrome	
164922	51567-SS	Stainless*	

Classic Palm® Grab Bar Handshower

- Touch-clean spray holes
- Push-button spray selection
- 24" Wall grab bar w/ ADA adjustable slide
- 4-Setting handshower
- 2.5 gpm @ 80 psi



Part #	Mfg #	Finish	Price
154395	52008-DS	Chrome	

Ashlyn® Slidebar Handshower

- H2Okinetic® Shower technology
- Touch-Clean® spray holes
- 82" Hose
- 24" Slidebar
- 2.0 gpm @ 80 psi



Part #	Mfg #	Finish	Price
231275	51559	Chrome	

Classic Slidebar 5-Spray Handshower

- (5) Spray patterns
- Wall bar w/ adjustable slide
- 70" Ultra Flex hose (51599)
- 60"-82" metal stretchable hose w/ vacuum breaker (51599-DS)
- Maximum flow: 2.0 gpm @ 80 psi



Part #	Mfg #	Finish	Price
227962	51599	Chrome	
097754	51599-DS	Chrome	
228185	51599-SSDS	Stainless*	

Cassidy™ Slidebar Handshower

- Self-cleaning H2Okinetic spray
- 60"-82" Stretchable metal hose
- 3-Setting handshower:
 - Pause
 - H2Okinetic spray
 - Massage spray
- WaterSense® certified product: 2.0 gpm @ 80 psi



Part #	Mfg #	Finish	Price
153944	51308	Chrome	
159236	51308-CZ	Champagne Bronze™	
161955	51308-PN	Polished Nickel*	
155287	51308-RB	Venetian Bronze®	
155689	51308-SS	Stainless*	

Classic 7-Setting Glide Rail Handshower

- (7) Spray settings
- 24" Wall bar w/ adjustable slide
- 60"-82" Stretchable metal hose
- 2.0 gpm @ 80 psi



Part #	Mfg #	Finish	Price
149509	51751	Chrome	

* Brilliance® Anti-Tarnish Lifetime Finishes

www.waterconcepts.net • Serving our Customers Since 1946 • www.plumbsupply.com

Personal Showers & Accessories

Classic Slidebar 2-Setting Handshower

- Dual check valve for backflow protection
- Maximum flow: 2.5 gpm @ 80 psi



Part #	Mfg #	Finish	Price
001159	51501-WH	24" Slidebar, White	
166856	51502-WH	30" Slidebar, White	

Classic Slidebar Handshower

- (2) Spray patterns
- 7" Ultra flex hose
- Internal dual check valve
- 2.5 gpm @ 80 psi



Part #	Mfg #	Finish	Price
001165	51521-WHB	White/Chrome	

Classic Wall-Bar 7-Spray Handshower

- (7) Spray patterns - not a positive shut-off
- Wall bar with adjustable slide
- 2.5 gpm @ 80 psi
- 60" - 82" Stretchable metal hose

51704



Part #	Mfg #	Finish	Price
032711	51701	24" Bar, Chrome	
152239	51704	28" Bar, Chrome	
146394	51704-RB	28" Bar, Venetian Bronze®	
145667	51704-SS	28" Bar, Stainless*	

Classic Slidebar 7-Spray Handshower

- 2.5 gpm @ 80 psi
- 7-Setting handshower
 - Pause
 - Full body spray
 - Full spray w/ massage
 - Fast massage
 - Shampoo rinsing spray
 - Soft drench spray
 - Soft drench spray w/ massage



Part #	Mfg #	Finish	Price
151879	51708	Chrome	
223062	51708-PB	Polished Nickel	
148637	51708-SS	Stainless*	
151401	51708-RB	Venetian Bronze	

Delta Adjustable Grab Bar Handshower

- ADA Slide mechanism
- White push button handshower
- 60" - 82" Stretchable metal hose
- 24" Grabbar slide (52001, 52002)
- 36" Grabbar slide (52003)



52001-DS 52002-DS

Part #	Mfg #	Finish	Price
037861	52001-DS	White/Stainless	
037858	52002-DS	White	
037862	52003-DS	White/Stainless	

Delta Single-Function Slidebar Handshower

- 69" Long flexible hose with brass connections
- 24" Wall bar
- 2.0 gpm @ 80 psi
- Full body spray



Part #	Mfg #	Finish	Price
136905	57011	Chrome	

* Brilliance® Anti-Tarnish Lifetime Finishes

www.plumbsupply.com • Serving our Customers Since 1946 • www.waterconcepts.net

Personal Showers & Accessories

Faucets & Valves

Traditional Slidebar Handshower

- 82" hose
- Supports up to 500 lbs of force
- Grab/slide bar diameter 1-1/4"
- ActivTouch
- Spray settings:
 - Full body
 - Fast massage
 - Full spray with massage
 - Shampoo rinsing
 - Shampoo rinsing with massage
 - Soft drench
 - Soft drench with massage
 - Soft full
- WaterSense® certified: 2.0 gpm



Part #	Mfg #	Finish	Price
181016	51900	Chrome	
186618	51900-RB	Venetian Bronze®	
181017	51900-SS	Stainless*	

Delta Transitional Slidebar Handshower

- 69" Long flexible hose with brass connections
- Full spray, massage spray, and aerated soft spray
- 24" Wall bar
- 2.5 gpm @ 80 psi



Part #	Mfg #	Finish	Price
135121	57014	Chrome	
147900	57014-CZ	Champagne Bronze™	
134897	57014-RB	Venetian Bronze®	
135193	57014-SS	Stainless*	

Delta Traditional Slidebar Handshower

- 69" Long flexible hose with brass connections
- Full spray, massage spray, and aerated soft spray
- 24" Wall bar
- 2.5 gpm @ 80 psi



Part #	Mfg #	Finish	Price
137069	57021	Chrome	
146422	57021-CZ	Champagne Bronze™	
144570	57021-PB	Polished Brass	
135419	57021-RB	Venetian Bronze®	

Handshowers with Slidebar (Continued)

Delta Traditional Slidebar Handshower

Part #	Mfg #	Finish	Price
135030	57021-SS	Stainless*	

Dryden™ Slidebar Single-Function Handshower

- 69" Long flexible hose with brass connections
- 24" Wall bar with adjustable slide; not to be used as a grab bar; not ADA compliant
- 2.0 gpm @ 80 psi
- Certified dual check valves



Part #	Mfg #	Finish	Price
137741	57051	Chrome	
154747	57051-CZ	Champagne Bronze™	
175032	57051-PN	Polished Nickel*	
137126	57051-RB	Venetian Bronze®	
136972	57051-SS	Stainless*	

Glide Rail Handshower

- Full body spray
- 70" Hose
- 24" Slidebar
- 2.5 gpm @ 80 psi



Part #	Mfg #	Finish	Price
001166	51551-WH	White	

* Brilliance® Anti-Tarnish Lifetime Finishes

www.waterconcepts.net • Serving our Customers Since 1946 • www.plumbsupply.com

Personal Showers & Accessories

Ribbon Slidebar Handshower

- Single-setting H2Okinetic
- 60"-/2" stretchable metal hose
- Face rotates 360°
- 28" Long wall bar with adjustable slide
- 2.0 gpm @ 80 psi



Part #	Mfg #	Finish	Price
163820	51205-SS	Stainless*	

Rizu™ Slidebar Single-Function Handshower

- 69" Long hose
- 24" Long wall bar with adjustable slide
- 2.5 gpm @ 80 psi
- Full body spray



Part #	Mfg #	Finish	Price
136767	57085	Chrome	
186835	57085-CZ	Champagne Bronze™	
135080	57085-SS	Stainless*	
161069	57085-RB	Venetian Bronze®	

Temp2O Handshower w/ Wall Bar

- (6) Setting handshower
- LED color changing digital temperature display
- Touch-Clean™ spray holes
- 60"-82" Stretchable metal hose
- Push-button spray selection
- 24" Slidebar
- 2.0 gpm @ 80 psi



Part #	Mfg #	Finish	Price
182004	51406	Chrome	
171540	51406-RB	Venetian Bronze®	
188073	51406-SS	Stainless*	

Tesla™ Handshower w/ Slidebar

- (4) Setting handshower
- H2Okinetic Technology®
- Touch-Clean® nozzles
- 24" Wall bar
- 60" Metal hose
- 2.0 gpm @ 80 psi



Part #	Mfg #	Finish	Price
185041	51552	Chrome	
182339	51552-PN	Polished Nickel	
180598	51552-SS	Stainless*	

Contemporary Slidebar Handshower

- Spray settings:
 - Full body
 - Fast massage
 - Full spray with massage
- 82" Hose
- 1-1/4" Slidebar diameter
- Supports up to 500 lbs
- 2.0 gpm @ 80 psi



Part #	Mfg #	Finish	Price
189822	51400	Chrome	
186152	51400-SS	Stainless*	

Traditional Slidebar 5-Spray Handshower

- Spray settings: full spray, fast massage, full spray with massage, aerated spray, and trickle
- Rub clean nozzle
- Double-check valve for back-flow protection
- 60" to 82" Stretchable stainless steel hose
- 29" Long wall bar with adjustable mount
- 2.5 gpm @ 80 psi



Part #	Mfg #	Finish	Price
160756	51508	Chrome	
147262	51508-SS	Stainless*	
147368	51508-RB	Venetian Bronze®	
168995	51508-PB	Polished Brass	

* Brilliance® Anti-Tarnish Lifetime Finishes

www.plumbsupply.com • Serving our Customers Since 1946 • www.waterconcepts.net

Personal Showers & Accessories

Faucets & Valves

Vero™ Slidebar Handshower

- 69" Long hose
- 26-15/16" Long wall bar with adjustable slide
- 2.5 gpm @ 80 psi



Part #	Mfg #	Finish	Price
137235	57530	Chrome	
173122	57530-CZ	Champagne Bronze™	
146667	57530-RB	Venetian Bronze®	
135446	57530-SS	Stainless*	

Square Wall Supply Elbow

- 1/2" IPS Female inlet
- 1/2" IPS Male outlet



Part #	Mfg #	Finish	Price
151583	50570	Chrome	
159238	50570-CZ	Champagne Bronze™	
175033	50570-PN	Polished Nickel*	
151554	50570-RB	Venetian Bronze®	
150717	50570-SS	Stainless*	

Handshower Components

Handshower Wall Supply Elbow

- 1/2" IPS Female inlet
- 1/2" IPS Male outlet



Part #	Mfg #	Finish	Price
089463	50560	Chrome	
137609	50560-CZ	Champagne Bronze™	
089465	50560-PB	Polished Brass	
089466	50560-PN	Polished Nickel	
089468	50560-RB	Venetian Bronze®	
089470	50560-SS	Stainless*	

Handshower Showerarm Diverter

- Use to divert water between showerhead and hand shower
- 1/2" IPS Female inlet
- 1/2" IPS Male outlet
- Brass construction



Part #	Mfg #	Finish	Price
089471	50650	Chrome	
143548	50650-CZ	Champagne Bronze™	
089473	50650-PB	Polished Brass	
089476	50650-RB	Venetian Bronze®	
089477	50650-SS	Stainless*	

Brass Handshower Wall Supply Elbow

- Replaces standard showerarm
- Brass construction



Part #	Mfg #	Finish	Price
061578	U4980-PK	Chrome	
146299	U4980-RB-PK	Venetian Bronze®	
147748	U4980-SS-PK	Stainless*	

Handshower 3-Way Showerarm Diverter

- Brass construction
- ADA Flip lever control
- 1/2" IPS Female inlet
- 1/2" IPS Male outlet



Part #	Mfg #	Finish	Price
118482	U4929-PK	Chrome	
145374	U4929-PB-PK	Polished Brass*	
147527	U4929-RB-PK	Venetian Bronze®	
120931	U4929-SS-PK	Stainless*	

3-Way Showerarm Diverter with Handshower Mount

- Brass construction
- ADA Flip lever control
- 1/2" IPS Female inlet
- 1/2" IPS Male outlet



Part #	Mfg #	Finish	Price
147746	U4920-PK	Chrome	

* Brilliance® Anti-Tarnish Lifetime Finishes

www.waterconcepts.net • Serving our Customers Since 1946 • www.plumbsupply.com

Personal Showers & Accessories

Handshower Components (Continued)

3-Way Showerarm Diverter with Handshower Mount

Part #	Mfg #	Finish	Price
166596	U4920-CZ-PK	Champagne Bronze™	
173120	U4920-PN-PK	Polished Nickel*	
160909	U4920-SS-PK	Stainless Steel	
147530	U4920-RB-PK	Venetian Bronze®	

Handshower 3-Way Showerarm Diverter

- Brass construction
- (1) Inlet and (2) outlets



Part #	Mfg #	Finish	Price
001228	U4923-PK	Chrome	
117672	U4923SSPK	Stainless*	
090755	U4923RBPk	Venetian Bronze®	
025325	U4923PBPk	Polished Brass	

Handshower Showerarm Diverter

- Brass construction



Part #	Mfg #	Finish	Price
001226	U4922-PK	Chrome	

Handshower Universal Adjustable Showerarm Mount

- 1/2" IPS Female inlet
- 1/2" IPS Male outlet



Part #	Mfg #	Finish	Price
039553	U3401-PK	Chrome	
168036	U3401-PB-PK	Polished Brass	
131271	U3401-RB-PK	Venetian Bronze®	
147747	U3401-SS-PK	Stainless*	
194915	U3401-WH-PK	White	

Handshower Wall Supply Elbow/Mount

- Replaces standard shower arm
- 1/2" IPS female inlet
- 1/2" IPS male outlet



Part #	Mfg #	Finish	Price
120567	U4985-PK	Chrome	
162712	U4985-RB-PK	Venetian Bronze®	
149600	U4985-SS-PK	Stainless*	

Handshower Showerarm Wall-Mount



U3001-PK



RP61294SS



U4005-SS

Part #	Mfg #	Finish	Price
041386	U3001-PK	Chrome	
043138	U3001-WH-PK	White	
147745	U4005-PK	Chrome	
170373	U4005-CZ-PK	Champagne Bronze™	
155307	U4005-PB-PK	Polished Brass	
117673	U4005-RB-PK	Venetian Bronze®	
117674	U4005-SS-PK	Stainless*	
141199	RP61294	Chrome	
136458	RP61294-SS	Stainless	
141476	RP61294-RB	Venetian Bronze®	
150132	RP61294-CZ	Champagne Bronze™	

Square Wall Mount Bracket

- Adjustable wall mount
- Concealed installation screws



Part #	Mfg #	Finish	Price
168704	U4010-PK	Handshower Mount, Chrome	
189850	U4010-RB-PK	Handshower Mount, Venetian Bronze®	
162696	U4010-SS-PK	Handshower Mount, Stainless	

* Brilliance® Anti-Tarnish Lifetime Finishes

www.plumbsupply.com • Serving our Customers Since 1946 • www.waterconcepts.net

Personal Showers & Accessories

Faucets & Valves

Handshower Pin-Mount Swivel Connector



Part #	Mfg #	Finish	Price
001175	U4002-PK	Chrome, Plastic Connector	
001176	U4002-WH-PK	Chrome/White	
001251	U5002-PK	Chrome, Metal Connector	
149179	U5002-PB-PK	Polished Brass	

Delta Volume Control

- Volume control with trickle feature
- Brass construction
- 1/2" IPS female inlet
- 1/2" IPS male outlet



Part #	Mfg #	Finish	Price
001211	U4760-PK	Chrome	
156135	U4760-PB-PK	Polished Brass	
173767	U4760-RB-PK	Venetian Bronze®	
095041	U4760-SS-PK	Stainless*	

Shower Arm Pin Mount



Part #	Mfg #	Finish	Price
001190	U4301-PK	Chrome	

Handshower Pin Wall-Mount

- For use with pin-mount swivel connectors



Part #	Mfg #	Finish	Price
001249	U5001-PK	Clear Pin, Chrome Back	
001247	U5001-A-PK	Chrome Pin and Back	

Universal All Brass Pin Wall-Mount



Part #	Mfg #	Finish	Price
026410	U9501-PK	Chrome	
229502	U9501-PB-PK	Polished Brass	

Adapter for Handshower to Hose

- Quick connect
- 1/2" IPS female inlet
- 1/2" IPS male outlet



Part #	Mfg #	Finish	Price
157779	U7500	Chrome	

UltraFlex® Handshower Hose

- UltraFlex® hose and gaskets



Part #	Mfg #	Finish	Price
168959	RP64157	Chrome	
161692	RP64157RB	Venetian Bronze®	
144825	RP64157SS	Stainless*	

UltraFlex® Ribbon Hose



Part #	Mfg #	Finish	Price
001222	U490R-60-PK	60" Black/Chrome	
001224	U490R-70-PK	70" Black/Chrome	
001225	U490R-84-PK	84" Black/Chrome	

Handshower Stretchable Metal Hose

- (1) Conical and (1) hex all-brass nut
- 60" - 82" Length



Part #	Mfg #	Finish	Price
022707	U495D-60-PK	Chrome	
165863	U495D-CZ60-PK	Champagne Bronze	
148873	U495D-PB60-PK	Polished Brass	
172180	U495D-PN60-PK	Polished Nickel	
117671	U495D-RB60-PK	Venetian Bronze	
048383	U495D-SS60-PK	Stainless	

* Brilliance® Anti-Tarnish Lifetime Finishes

www.waterconcepts.net • Serving our Customers Since 1946 • www.plumbsupply.com

Personal Showers & Accessories

Handshower Stainless Steel Hose

- (1) Conical and (1) hex all-brass nut



Part #	Mfg #	Finish	Price
001240	U495S-60PK	60", Chrome	
001241	U495S-69PK	69", Chrome	

Hose - Handshower for R4700



Part #	Mfg #	Finish	Price
178457	RP40664RB	Venetian Bronze®	

UltraFlex® Ribbon Hand Shower Hose

- 84" Length
- Two chrome metal conical hose notes



Part #	Mfg #	Finish	Price
019829	U494R84PK	White/Chrome	

Handshower Vacuum Breaker

- Atmospheric with Brass Shield
- 1/2" IPS female inlet
- 1/2" IPS male outlet



Part #	Mfg #	Finish	Price
001218	U4900-PK	Chrome	
164861	U4900-RB-PK	Venetian Bronze®	
164847	U4900-SS-PK	Stainless*	

Adjustable ADA Grab Bar Assembly

- 60" - 82" Stretchable metal hose
- 24" Decorative 1-1/4" wall grab bar
- ADA Slide mechanism
- Lifetime faucet and finish warranty



Part #	Mfg #	Finish	Price
106572	56302	Chrome	
162219	56302-PB	Polished Brass	

Handshower Components (Continued)

Adjustable ADA Grab Bar Assembly

Part #	Mfg #	Finish	Price
147241	56302-RB	Venetian Bronze®	
121009	56302-SS	Stainless	

Adjustable Pin-Mount Wall Bar



Part #	Mfg #	Finish	Price
001172	55024	24" Chrome	

Adjustable Wall Bar



Part #	Mfg #	Finish	Price
028904	55041-PK	Chrome	
156611	55041-RB-PK	Venetian Bronze®	
048381	55041-SS-PK	Stainless*	

Adjustable Wall Bar

- 29" Long adjustable
- Concealed screws



Part #	Mfg #	Finish	Price
084676	55083	Chrome	
149112	55083-RB	Venetian Bronze®	
164464	55083-SS	Stainless*	

* Brilliance® Anti-Tarnish Lifetime Finishes

www.plumbsupply.com • Serving our Customers Since 1946 • www.waterconcepts.net

Personal Showers & Accessories

Faucets & Valves

Grab Bar Wall Anchor



Part #	Mfg #	Finish	Price
150480	RP72402	Wall Anchor	

ADA Grab Bar Handshower Mount

- Fits 1-1/2" to 1-1/4" grab bars
- Rotatable hand shower mount



Part #	Mfg #	Finish	Price
148470	U6300-WH	White	
151564	U6300	Black	
190499	U6400-RB	Venetian Bronze®	
185523	U6400-SS	Stainless*	

Slide Mechanism Contemporary

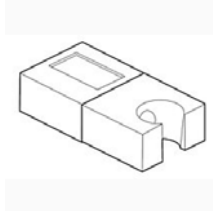

Part #	Mfg #	Finish	Price
170304	RP64239	Chrome	

Bar Slide

BAS-3BX



Part #	Mfg #	Finish	Price
041665	BAS-3BX	Chrome/Clear Knob	
001149	BAS-4BX	Chrome/Clear Lever	

* Brilliance® Anti-Tarnish Lifetime Finishes

www.waterconcepts.net • Serving our Customers Since 1946 • www.plumbsupply.com

Aerators

Aerators

Water Efficient 1.5 gpm Aerator



Part #	Mfg #	Description	Price
173223	RP53343RB	Venetian Bronze®	
173222	RP53343SS	Stainless*	

RP330 Aerator

- For Classic series kitchen and lavatory models and e-FLOW™ lavatory models
- 15/16" - 27 Male thread
- 2.2 gpm @ 60 psi



Part #	Mfg #	Description	Price
003614	RP330	Chrome	
003616	RP330PB	Polished Brass*	

RP18508 Aerator

- For Signature® and Waterfall® series standard kitchen models, Innovations® collection two handle lavatory models, and C-Spout series lavatory models
- 15/16" - 27 Male thread
- 2.2 gpm @ 60 psi



Part #	Mfg #	Description	Price
026970	RP18508	Chrome	

RP19754 Aerator

- 1.5 gpm



Part #	Mfg #	Finish	Price
123353	RP19754	Chrome	

RP54977 Aerator

- 1.5 gpm

Part #	Mfg #	Description	Price
139326	RP54977	Chrome	

Vandal-Resistant Aerator



Part #	Mfg #	Description	Price
032115	RP246	Chrome	

RP5202 Vandal-Resistant Aerator



Part #	Mfg #	Description	Price
027030	RP5202	Aerator	

RP61342 Aerator



Part #	Mfg #	Description	Price
176597	RP61342	Aerator	

RP31704 Vandal Resistant Aerator

- .5 gpm

Part #	Mfg #	Description	Price
050500	RP31704	Chrome, .5 gpm	

RP71110 Vandal Resistant Aerator

- 2.2 GPM



Part #	Mfg #	Description	Price
173239	RP71110	Aerator, 2.2 gpm	

Rp64451 Aerator Assembly

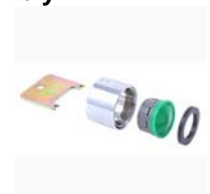

Part #	Mfg #	Description	Price
158132	RP64451	Aerator Assy	

* Brilliance® Anti-Tarnish Lifetime Finishes

www.plumbsupply.com • Serving our Customers Since 1946 • www.waterconcepts.net

Aerators

Faucets & Valves

RP37018 Aerator

- 2.2 GPM



Part #	Mfg #	Description	Price
187840	RP37018RB	Venetian Bronze®	
167613	RP37018SS	Stainless*	

RP46827 Aerator



Part #	Mfg #	Description	Price
169284	RP46827	Chrome	

Michael Graves™ Aerator

- Swivel



Part #	Mfg #	Description	Price
144734	RP40372	Chrome	

RP47667 Aerator



Part #	Mfg #	Description	Price
156042	RP47667	Chrome	

RP43516 Aerator

- 2.2 GPM



Part #	Mfg #	Description	Price
182276	RP43516SS	Aerator	

RP43774 Water Efficient Aerator



Part #	Mfg #	Description	Price
230933	RP43774	Insert, 1.5 gpm	

RP43166 Aerator

- 2.2 GPM



Part #	Mfg #	Description	Price
168387	RP43166	Chrome	

Water Efficient Aerator Insert

- 1.5 gpm



Part #	Mfg #	Description	Price
131096	RP52216	Insert, 1.5 gpm	

Classic RP60983 Aerator

- 1.5 gpm



Part #	Mfg #	Description	Price
133924	RP60983	Chrome	

RP53349 Water Efficient Aerator

- 1.5 gpm



Part #	Mfg #	Description	Price
188598	RP53349	Chrome	

* Brilliance® Anti-Tarnish Lifetime Finishes

www.waterconcepts.net • Serving our Customers Since 1946 • www.plumbsupply.com

Aerators

RP53339 Water Efficient Aerator

- 1.5 gpm



Part #	Mfg #	Description	Price
164431	RP53339	Chrome	

RP53343SS Water Efficient Aerator

- 1.5 GPM



Part #	Mfg #	Description	Price
225108	RP53343SS	Stainless	

Water Efficient Aerator Insert

- 1.8 gpm



Part #	Mfg #	Description	Price
179821	RP70746	Insert - 1.8 gpm	

RP76076 Aerator

Part #	Mfg #	Description	Price
169550	RP76076	Aerator	

RP63039 Aerator

Part #	Mfg #	Description	Price
165426	RP63039	Aerator, 1.5 gpm	

RP63137 Aerator - Round Spray



Part #	Mfg #	Description	Price
135198	RP63137	Chrome, Round Spray	

RP18454 Aerator

- 2.2 gpm



Part #	Mfg #	Description	Price
018485	RP18454	Aerator, 2.2 gpm	

Water Efficient TT Aerator

- .5 GPM



Part #	Mfg #	Description	Price
169533	RP73806	TT Aerator - .5 gpm	

Water Efficient Aerator

- .5 gpm
- Removal wrench included



Part #	Mfg #	Description	Price
144084	RP71111	Aerator .5 gpm	

Commercial Aerator

- 1.5 GPM

Part #	Mfg #	Description	Price
133081	060640A	Aerator, 1.5 gpm	
155596	060641A	Commercial Aerator	

Aerator Key



Part #	Mfg #	Description	Price
139056	RP60730	Aerator Key	

* Brilliance® Anti-Tarnish Lifetime Finishes

www.plumbsupply.com • Serving our Customers Since 1946 • www.waterconcepts.net

Rough-In Valves

Tub & Shower Rough-In Valves

Modern MultiChoice® Universal Tub & Shower Rough-In Valve

- 1/2" Universal outlets, inlets/outlets have male threads
- Back-to-back capability
- 1/2" Universal inlets accept 1/2" copper, 1/2" iron pipe, PEX or CPVC adapters
- Cartridge ships with trim



Part #	Mfg #	Description	Handle(s)	Finish	Price
103001	R6000-UNBX	1/2" Rough-In, Single Box Model			
168148	R6000-UNBXHF	1/2" Rough-In, High Flow Single Box Model			
231643	R6000-UNWS	1/2" Rough-In, With Stops			
231003	R60000-PX	1/2" Rough-In, Pex Crimp Inlets with Un Outlets			

Charlotte® Diverter Rough-In Valve

- Forged brass body



Part #	Mfg #	Description	Handle(s)	Finish	Price
138774	R60700	1/2" Rough-In, 3-Port 6-Function Diverter			

Baliza® Single-Handle Freestanding Tub Filler Rough-In

- 3-3/4" Maximum floor thickness
- Maximum flow: 14.5 gpm @ 60 psi



Part #	Mfg #	Description	Handle(s)	Finish	Price
169122	R70100	1/2" Rough-In, Forged Brass Body			

Baliza® Two-Handle Freestanding Tub Filler Rough-In

- 4-3/4" Maximum floor thickness
- Maximum flow: 12 gpm @ 60 psi



Part #	Mfg #	Description	Handle(s)	Finish	Price
165674	R70200	1/2" Rough-In, Forged Brass Body			

* Brilliance® Anti-Tarnish Lifetime Finishes

www.waterconcepts.net • Serving our Customers Since 1946 • www.plumbsupply.com

Rough-In Valves

Baliza® One-Handle Freestanding Tub Filler Rough-In

- 3-3/4" Maximum floor thickness
- Maximum flow 14.5 gpm @ 60 psi



Part #	Mfg #	Description	Handle(s)	Finish	Price
163378	R70100-WS	1/2" Rough-In, Forged Brass Body			

Vesi Curve® Two-Handle Roman Tub Rough-In Valve

- Flexible deck or ledge mount
- Adjustable rough-in for thin or thick deck installations
- 8"-16" Maximum widespread



Part #	Mfg #	Description	Handle(s)	Finish	Price
117391	R62707	3-Hole, 8"-16" cc	-	-	
095062	R64707	4-Hole, 8"-16"cc	-	-	

Custom Shower System Rough-In

Euro Sensori Thermostatic Temperature Control Rough-In Valve

- Flow rate: 12 gpm @ 60 psi
- Accepts single function thermostatic cartridge that ships with sensori trim
- Must also order sensori trim



Part #	Mfg #	Description	Price
127290	R66000-WS	3/4" Rough-In Thermostatic Temperature Control Rough with Stops	

Sensori® Volume Control Rough-In Valve

- 3/4" rough-in
- Max flow 9.1 gpm @ 60 psi per volume control
- Volume controls are required for every outlet and every set of body sprays (up to max flow)
- Extension kit not required. Rough accommodates up to 3 1/4" wall thickness
- Provides precise handle alignment
- 1-piece brass construction cartridge and stem
- Solid brass extension sleeve



Part #	Mfg #	Description	Price
228243	R35600	3/4" Rough-in Volume Control	

* Brilliance® Anti-Tarnish Lifetime Finishes

www.plumbsupply.com • Serving our Customers Since 1946 • www.waterconcepts.net

Rough-In Valves

Lavatory Rough-In Valves
Sotria™ Wall-Mount Lavatory Rough

- 1/2" NPT rough-in
- Lead free brass body
- Must order trim separately
- 3-Hole, 8" center-to-center



Faucets & Valves

Part #	Mfg #	Description	Handle(s)	Finish	Price
177246	R65800	3-Hole, 8" center-to-center	-	-	

* Brilliance® Anti-Tarnish Lifetime Finishes

www.waterconcepts.net • Serving our Customers Since 1946 • www.plumbsupply.com

Rough-In Valves

Shower Rough-In Valves

Shower Trim Rough-In Valve

- Accepts single-function (13/14), dual-function (17), or dual-function thermostatic (17T) cartridge
- Cartridge ships with trim kit



Part #	Mfg #	Description	Price
092547	R10000-UNWS	Universal Valve Body with Stops, MIP/Swt	
092544	R10000-UNBX	Universal Valve Body less Stops, MIP/Swt - Single Box Model	
134053	R10000-UNBXHF	Universal Valve Body less Stops, MIP/Swt - Single Box Model w/ High Flow, No Tub Outlet	
092548	R10000-PX	Universal Valve Body less Stops, PEX	
140394	R10000-MF	MultiChoice® Universal Valve, PEX Cold Expansion Connection	

Delta® Diverter Rough-In Valve

- 3-Port, 6-setting diverter with 3 individual and 3 shared positions
- 2-Port, 3-setting diverter with 2 individual and 1 shared position
- 1/2" Universal inlets/outlets
- Cartridge ships with trim
- For use with three or six function diverter
- Forged brass body



Part #	Mfg #	Description	Price
133926	R11000	Three or Six Function 3-Port Diverter Rough	

Jetted Shower Rough-In with Extra Outlet - 6 Setting with Stops

- Use with 14, 17 & 17T Series shower trims
- Use with 14 & 17 Series shower trims
- Order T18017-XO for Jetted Shower XO® trim
- Order T18037-XO for Jetted Shower XO® trim
- 3 port, 6 position diverter
- 1/2" universal inlets/outlets, male threads
- High flow capability for shower only applications
- Back-to-back capability



Part #	Mfg #	Description	Price
138221	R18000-XO	3-Port 6-Position Diverter	
175619	R18000-XOWS	3-Port 6-Position Diverter, With Stops	

* Brilliance® Anti-Tarnish Lifetime Finishes

www.plumbsupply.com • Serving our Customers Since 1946 • www.waterconcepts.net

Rough-In Valves

Faucets & Valves

MultiChoice® Universal Valve with Integrated Diverter Rough

- Monitor® pressure balance valve keeps water temperature within a safe $\pm 3^{\circ} F$ ($\pm 1.6^{\circ} C$), helping to protect you from sudden changes in hot or cold water pressure
- Rough-in only
- One-Piece forged valve body without stops
- Back-to-back installation capability



Part #	Mfg #	Description	Price
226549	R22000	Universal Valve w/ Integrated Diverter	

Roman Tub Rough-In Valves

2-Hdl Roman Tub Rough-In Valve

- Flexible deck or ledge mounting arrangement
- Self-locating basis
- Tighten/adjust from above deck
- Adjust to 2-1/4" maximum deck thickness or adjust to 2-1/4" maximum thickness after mud and tile
- No thick deck kit required



Part #	Mfg #	Description	Price
075435	R2707	3-Hole 8"-16"cc Deck-Mount, 18 gpm	
173479	R2707-PX	3-Hole 8"-16"cc Deck-Mount, 18 gpm, 1/2" PEX Crimp Connections	
052946	R2700	3-Hole 8"-16"cc Deck-Mount, 18 gpm Flexible Mounting	

2-Hdl Roman Tub Faucet w/Handshower Rough-In Valve

- Flexible deck or ledge mounting arrangement
- Includes handshower rough-in
- Self-locating bases
- Tighten/adjust from above deck
- Adjust to 2-1/4" maximum deck thickness or adjust to 2-1/4" maximum thickness after mud and tile
- No thick deck kit required



Part #	Mfg #	Description	Price
075261	R4707	4-Hole 8"-16"cc Deck-Mount, 18 gpm	
173482	R4707-PX	4-Hole 8"-16"cc Deck-Mount, 18 gpm, 1/2" PEX Crimp Connections	
175951	R4707-MF	4-Hole 8"-16"cc Deck-Mount, 18 gpm, PEX Expansion Connections	

* Brilliance® Anti-Tarnish Lifetime Finishes

www.waterconcepts.net • Serving our Customers Since 1946 • www.plumbsupply.com

Rough-In Valves

1-Hdl Floor Mount Tub Filler Rough-In

- Floor mount installations
- Tighten/adjust from above floor
- Adjust to 2-1/2" max. deck thickness
- Test caps and plaster guard included
- Order trim separately



Part #	Mfg #	Description	Price
162069	R4700-FL	1-Hole Installation, Less Stops	
172242	R4700-FLWS	1-Hole Installation, With Stops	

Lavatory Wall-Mount Rough-In Valves

Two Handle Wall-Mount Lavatory Rough-In

- 1/2" IPS connection
- 2-3/4" +/- 1/2" mounting depth
- Compatible with 2 handle Delta® wall-mount trims



Part #	Mfg #	Description	Price
162246	R3500-WL	3-Hole 8"cc, Trim sold separately	

Single Handle Wall-Mount Lavatory Rough

- Max rough-in depth 2-3/4"
- 1/2" IPS connection



Part #	Mfg #	Description	Price
190502	R3510-WL	2-Hole 8"cc, Trim sold separately	

Commercial Shower Valves

MultiChoice® Universal Dual Rough-In Valve

- Includes diverter valve for dual showers
- Forged brass body
- Back-to-back installation
- Square plasterguard allows for right angle cuts
- Thin wall mounting
- For use with MultiChoice® Universal single or dual function trim.
- Cartridge, handle, and flange ships with trim
- 1/2" outlets and connections



For use with MultiChoice® Universal T13H and T17TH series with diverter valve for dual showers

Part #	Mfg #	Description	Price
095471	R10700-UNWS	Valve Body with Stops, In-Wall 2-Outlet Div Vlv	- N/A

* Brilliance® Anti-Tarnish Lifetime Finishes

www.plumbsupply.com • Serving our Customers Since 1946 • www.waterconcepts.net

Rough-In Valves

Faucets & Valves

MultiChoice® Universal Rough Valve Body

- Forged brass body
- Back-to-back installation capabilities
- Square plasterguard allows for right angle cuts
- Thin wall mounting
- 1/2" outlets and connections



Part #	Mfg #	Description		Price
150688	R10000-MFWS	Valve Body with Pex Cold Expansion with Stops	-	N/A
092549	R10000-PXWS	Valve Body with PEXCrimp and Stops	-	N/A

Thermostatic Mixing Valve

- Point of use thermostatic mixing valve
- Integral check valves in hot and cold inlets
- Forged brass body
- 3/8" Compression fittings
- Maximum flow: 5.8 gpm @ 45 psi



Part #	Mfg #	Description		Price
171431	R3070-MIXLF	Valve Body with 3/8" Compression w/ Integral Check Valves	-	-

Thermostatic Brass Mixing Valve

- Thermostatic element senses the outlet water temperature and reacts to maintain a constant delivery temperature even under changing flows or variations in supply temperatures or pressures
- Brass body
- Inlets/outlets: 1/2" copper sweat
- Maximum flow rate: 11.0 gpm @ 145 psi



Part #	Mfg #	Description		Price
168956	R2570-MIXLF	Valve Body with 1/2" Swt w/ Integral Check Valve	-	N/A

Mixing Valve

- Solid brass body
- Valve only with built-in check valves
- Mechanical mixer with adjustable temperature setting, temperature control handle, and screw to lock in temperature selection
- 3/8" Compression inlets and outlet connections
- Maximum rated working pressure @ 125 PSI



Part #	Mfg #	Description		Price
063095	R2910-MIXLF	Valve Only, Mechanical Mixer with Integral Check Valves	-	

* Brilliance® Anti-Tarnish Lifetime Finishes

www.waterconcepts.net • Serving our Customers Since 1946 • www.plumbsupply.com

Tub & Shower Valves

Two-Handle Lavatory Rough-In Valves

Widespread 2-Hdl Lavatory Rough-In Valve

- Metal drain assembly
- Hydrolock™ quick connect installation



Part #	Mfg #	Description	Price
049457	9000	8"-16"ws, 1/2" IPS	
070902	69000	8"-16"ws, 1/2" IPS, Bulk (6/Pk)	

Wall-Mount Widespread 2-Hdl Lavatory Rough-In Valve

- 8" center
- 1/2" connections



Part #	Mfg #	Description	Price
158210	9700	8"cc, 1/2" Copper Connections	

Tub & Shower Rough-In Valves

Two-Function Posi-Temp or Moentrol Transfer Rough-In Valve

- Two-function transfer valve - 2 discrete outputs
- 180° rotational control
- 162154 Cartridge



Part #	Mfg #	Description	Handle(s)	Finish	Price
168714	3375	1/2" cc			

Three-Function M•PACT® Transfer Rough-In Valve

- (2) Discrete outputs and (1) shared mode
- 180° Rotational control
- 116719 Cartridge



Part #	Mfg #	Description	Price
131044	3372	1/2"cc	

Volume Control Rough-In Valve

- Brass construction
- 3/4" IPS connections
- Ceramic disc cartridge
- Flow rate: 13 gpm @ 60 psi



Part #	Mfg #	Description	Handle(s)	Finish	Price
095818	S3600	3/4" IPS			

*Lifeshine® Anti-Tarnish Lifetime Finish

www.plumbsupply.com • Serving our Customers Since 1946 • www.waterconcepts.net

Tub & Shower Valves

Faucets & Valves

Commercial Three-Function Transfer Valve

- 1/2" CC
- Inlets and outlets on same plane
- Valve operates 2 distinct functions but can be plumbed for 2 distinct functions
- Ceramic disc cartridge



Part #	Mfg #	Description	Handle(s)	Finish	Price
154584	3360	1/2"cc			

Commercial Posi-Temp® Pressure-Balancing Valve

- 4-Port
- 1/4 Turn stops
- Adjustable temperature limit stop
- 1222HD Cartridge design
- Accommodates back to back installations



8371HD

Part #	Mfg #	Description	Handle(s)	Finish	Price
154585	8371HD	1/2"cc/IPS with 1/4 Turn Stops			
215006	8373HD	1/2" PEX with 1/4 Turn Stops			

Posi-Temp® M•PACT® Pressure Balancing Cycling Rough-In Valve

- 4-Port
- Temperature limit stops
- Cycling valve
- Meets pressure-balancing safety codes
- Without volume control



2520, 62320



62370

Part #	Mfg #	Description	Handle(s)	Finish	Price
106351	2570	1/2"cc with 1/4 Turn Stops			
087781	62370	1/2"cc with 1/4 Turn Stops , #2570 Bulk (12/Pk)			

M•PACT® Common Valve System

- 4-Port
- 1/2" CC
- 12/Pk



Part #	Mfg #	Description	Handle(s)	Finish	Price
191635	62720	1/2"cc, 4-Port Bulk 12/Pk			

*Lifeshine® Anti-Tarnish Lifetime Finish

www.waterconcepts.net • Serving our Customers Since 1946 • www.plumbsupply.com

Tub & Shower Valves

M•PACT® Moentrol® with Transfer Connection

- 1/2" cc connection includes pressure balancing check stops volume control
- Two outlets; four



Part #	Mfg #	Description	Handle(s)	Finish	Price
155059	3350	1/2" cc with Stops, 2 Independent Functions, 1255 Cartridge			
049429	3330	1/2" cc with Stops, 2 Independent Functions, 1 Shared			

M•PACT® Moentrol® Pressure Balancing Valve with Volume Control

- Brass construction
- 1225 Cartridge design
- Pressure balancing, four port valve design with volume control and integral checks, 1/2" CC or IPS connections
- Adjustable temperature limit stop to control maximum hot water temperature
- Pressure balancing mechanism maintain selected discharge temperature to $\pm 2^{\circ}F$



Part #	Mfg #	Description	Handle(s)	Finish	Price
154990	3510	1/2" IPS			
068643	3520	1/2" CC			
191636	63170	1/2" CC #3570 Bulk (12/Pk)			

M•PACT® Posi-Temp® Pressure Balancing Valve

- Brass construction
- 1/2" cc or IPS connections
- Four port, cycle valve
- Adjustable temperature limit stop
- Pressure balancing mechanism maintain selected discharge temperature to $\pm 2^{\circ}F$



Part #	Mfg #	Description	Handle(s)	Finish	Price
093103	2510	1/2" IPS connections			
196031	62300	1/2" IPS connections, #2510 Bulk (12/Pk)			
043774	2520	1/2"cc with Stops			
022872	62320	1/2"cc with Stops, #2520 Bulk (12/Pk)			
130013	62380	1/2" PEX with Stops, Bulk (12/Pk)			

ExactTemp® M•PACT® Thermostatic Valve

- Brass construction
- 3/4" IPS connections
- Thermostatic valve design with integral checkstops
- Factory established temperature range from 80° F to 120° F
- Flow: 18 gpm @ 60 psi



Must be used with at least one S3600 Valve

Part #	Mfg #	Description	Handle(s)	Finish	Price
095817	S3371	3/4" IPS connections			

*Lifeshine® Anti-Tarnish Lifetime Finish

www.plumbsupply.com • Serving our Customers Since 1946 • www.waterconcepts.net

Tub & Shower Valves

Faucets & Valves

Roman Tub Rough-In Valves

Adjustable 2-Hdl Roman Tub Rough-In Valve

- Installs on 10"cc minimum
- To be installed on rough decks up to 3-3/8" (4792)
To be installed on rough decks up to 2-5/8" (9792)
- Accommodates 1-1/4" additional finish deck
- No cut adjustable spout shank
- Test plug and spout shank tool included

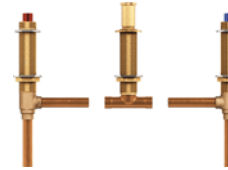

Part #	Mfg #	Description	Price
149604	4792	3-Hole 1/2"cc Connections. Adjustable Roman Tub Rough-In Valve	
152740	9792	4-Hole 1/2"cc Connections. Adjustable Roman Tub Rough-In Valve	

2-Hdl Roman Tub Rough-In Valve

- 10" Centers
- 1/2" cc inlets
- 1-7/8" Deck thickness
- Includes brass test plug
- Flow rate: 16 gpm @ 45 psi
- 1248 Cartridge



Part #	Mfg #	Description	Handle(s)	Finish	Price
152179	4796	1/2"cc Connections, 2-Hdl 10"cc			

Roman Tub Rough-In Valve

- 10"-24"
- 2-5/8" Maximum deck thickness
- 24" Quick connect hoses
- Integral 1/2" PEX connections
- Includes (2) 1/2" CPVC adapters
- Includes brass test plug
- 140715 Kit available separately to connect to 1/2" cold expansion PEX
- Flow rate: 13 gpm @ 45 psi



Part #	Mfg #	Description	Handle(s)	Finish	Price
154444	4793	3-Hole, 10" - 24" center 1/2" CPVC Crimp Ring PEX			
152305	9793	4-Hole w/ Diverter, 10" - 24" center 1/2" CPVC Crimp Ring PEX			

Arris™ Single Riser Floor Mount Tub Filler

- 1/2" MNPT; CC
- Built in stops



Part #	Mfg #	Description	Handle(s)	Finish	Price
170174	TS50100	1/2" MNPT; CC Single-Hole Floor Mount			

*Lifeshine® Anti-Tarnish Lifetime Finish

www.waterconcepts.net • Serving our Customers Since 1946 • www.plumbsupply.com

Tub & Shower Valves

Weymouth™ Double Riser Floor Mount Tub Filler

- 1/2" MNPT; CC
- Built in stops



Part #	Mfg #	Description	Handle(s)	Finish	Price
215023	TS50200	1/2"MNPT; CC Double Floor Mount			

*Lifeshine® Anti-Tarnish Lifetime Finish

www.plumbsupply.com • Serving our Customers Since 1946 • www.waterconcepts.net

Rough-In Valves

Tub & Shower Rough-In Valves
iBox Universal Plus Rough-In Valve

- With service stops
- 3/4" Inlets and outlets
- Includes (3) 1/2" reducers and (1) 3/4" plug and seal



Faucets & Valves

Part #	Mfg #	Description	Price
133273	01850181	4-Port Universal Rough-In	

*PVD Limited Lifetime Finish

Rough-In Valves

Tub & Shower Rough-In Valves Ceramic In-Wall Tub & Shower Rough-In Valve

- Flow rate: 10 gpm @ 45 psi
- Yoke with 8" centers
- Order trim separately



Part #	Mfg #	Description	Price
058278	K-302-K-NA	1/2" Ceramic In-Wall 2-Hdl Valve	

Hi-Flow Valve System with Diverter Valve

- Finished deck-mount or rim-mount only
- High-flow valve
- Eliminates the need for a transfer valve and transfer valve trim on the bath deck
- Order trim separately



Part #	Mfg #	Description	Price
097845	K-438-K-NA	1/2" Ceramic High-Flow Valve System	

Hi-Flow Rite-Temp® Pressure Balancing Tub & Shower Rough-In Valve

- Wall-mount
- Superior resistance to aggressive or treated water
- Flow rate: 13 gpm
- Utilizes existing K-306-KS valve trim
- Provides anti-scald protection and temperature regulation at flow rates as low as 1.75 gpm
- Back-to-back installation is ideal for unique or high-volume jobs
- Order trim separately



Part #	Mfg #	Description	Price
133946	K-2971-KS-NA	3/4" NPT, Screwdriver Stops	

Rite-Temp® Pressure-Balancing Tub & Shower Rough-In Valve

- Wall-mount
- Brass construction
- Maintains water temperature within +/-3° F
- Anti-scald protection and temperature regulation
- Flow rate: 5 gpm @ 45 psi
- Order trim separately
- (P) Prefix = Project Pack



Part #	Mfg #	Description	Price
184651	K-P304-UX-NA	1/2" Pressure-Balancing Valve less Screwdriver Stops, PEX Expansion, P-Pk	
223104	K-P304-PS-NA	1/2" Pressure-Balancing Valve with Screwdriver Stops, PEX Inlets (crimp)	
168656	K-P304-US-NA	1/2" Pressure-Balancing Valve with Stops, Pex Expansion Connections, P-Pk	

* Vibrant Limited Lifetime Warranty

www.plumbsupply.com • Serving our Customers Since 1946 • www.waterconcepts.net

Rough-In Valves

Rite-Temp® Pressure-Balancing Valve Body and Cartridge Kit

- Includes:
 - Valve body
 - Pressure-Balance cartridge
 - Mud guard
 - Rough-in guide
- Once-piece cartridge design
- Flow rate: 5.0 gpm @ 45 psi
- Order trim separately
- (P) Prefix = Project Pack



Part #	Mfg #	Description	Handle(s)	Finish	Price
227338	K-P8304-K-NA	Valve Body & Cartridge Kit, 1/2" NPT & Direct Swt Inlets & Outlets, P-Pk			
226148	K-8304-K-NA	Valve Body & Cartridge Kit, 1/2" NPT & Direct Swt Inlets & Outlets			
227339	K-P8304-KS-NA	Valve Body & Cartridge Kit, 1/2" NPT & Direct Swt Inlets & Outlets w/ Stops, P-Pk			
229091	K-8304-KS-NA	Valve Body & Cartridge Kit, 1/2" NPT & Direct Swt Inlets & Outlets w/ Stops			
226216	K-8304-PX-NA	Valve Body & Cartridge Kit, 1/2" PEX Crimp (F1807) Inlets, 1/2" NPT & Direct Swt Outlets			

Rite-Temp® Valve Body Rough-In

- Includes:
 - Valve body
 - Rough-in guid
 - Test cap
- (P) Prefix = Project Pack



Requires K-8305 Valve Cartridge to complete installation

Part #	Mfg #	Description	Handle(s)	Finish	Price
227342	K-P8300-PX-NA	Valve Body, 1/2" PEX Crimp (F1807) Inlets, 1/2" NPT & Direct Swt Outlets, P-Pk			
226217	K-8300-K-NA	Valve Body, 1/2" NPT & Direct Swt Inlets & Outlets, P-Pk			
227340	K-P8300-K-NA	Valve Body, 1/2" NPT & Direct Swt Inlets & Outlets, P-Pk			

Rite-Temp® Pressure-Balance Cartridge

- Includes:
 - Pressure-Balance cartridge
 - Mud guard
- One-piece cartridge design
- Fits every Kohler® Rite-Temp® trim
- Flow rate: 5 gpm @ 45 psi
- (P) Prefix = Project Pack

Requires K-8300 Valve Body to complete installation

Part #	Mfg #	Description	Handle(s)	Finish	Price
226716	K-8305-NA	Pressure-Balance Cartridge for Rite-Temp®, Requires K-8300 Valve Body			

* Vibrant Limited Lifetime Warranty

www.waterconcepts.net • Serving our Customers Since 1946 • www.plumbsupply.com

Rough-In Valves

Rite-Temp® Pressure-Balancing Tub & Shower Rough-In with Push Button Diverter

- Brass valve body
- Rite-Temp® pressure-balancing diaphragm design
- Integral push button diverter mechanism actuates handshower/showerhead application or showerhead/bath spout application
- Flow rate: 5 gpm @ 45 psi
- Order trim separately



K-11748-K-NA



K-11748-KS-NA

Part #	Mfg #	Description	Price
139392	K-11748-K-NA	Universal Sweat/NPT Connections	
136578	K-11748-KS-NA	Universal Sweat/NPT Connections, Stops	
156569	K-1081410	Divert for K-11748-	

MasterShower® Rough-In Valves

MasterShower® XVII Thermostatic Rough-In Valve

- Wall-mount, single-handle control
- Factory-calibrated comfort setting at 104°F
- Safety stop ensures temperature will not exceed 120°F
- Filter screens



Part #	Mfg #	Description	Price
147378	K-2972-KS-NA	1/2" NPT, Requires K-2974-K Volume Control Valve	
145875	K-2975-KS-NA	3/4" NPT, Requires K-2977-K Volume Control Valve	
145252	K-2976-KS-NA	3/4" NPT, Integral Stops & Volume Control	

MasterShower® Thermostatic Mixer

- Wall-mount
- High-temperature limit setting
- Temperature-balancing mechanism
- Scald hazard prevention
- Integral service stops
- Crossflow prevention
- Serviceable inlet filter screens
- Single outlet
- Independent temperature volume controls
- Flow rate: 7.2 gpm



Part #	Mfg #	Description	Handle(s)	Finish	Price
178038	K-2973-KS-NA	1/2" NPT, Thermostatic Valve with Integrated Volume Control & Stops			

* Vibrant Limited Lifetime Warranty

www.plumbsupply.com • Serving our Customers Since 1946 • www.waterconcepts.net

Rough-In Valves

MasterShower® Volume Control Rough-In Valve

- Allows precise control of amount and intensity of water flow
- Forged brass construction
- Wall-mount
- Flow rate: 10.0 gpm
- 1/4-Turn washerless ceramic valve
- Designed for use with thermostatic mixer valves



Part #	Mfg #	Description	Price
147379	K-2974-K-NA	1/2" NPT	
147197	K-2977-K-NA	3/4" NPT	

MasterShower® 3-Way/2-Way Transfer Rough-In Valve

- Wall-mount
- Brass valve body
- Permits three outlets to be interconnected
- Selection of one or combination of two outlets
- Can be converted from three outlets (360° handle rotation) to two outlets (120° handle rotation)



K-728-K Designed for use with Kohler Tub & Shower Supply Valves

Part #	Mfg #	Description	Price
132327	K-728-K-NA	3/4" Wall-mount 3-Way/2-Way Transfer Valve	

MasterShower® 3-Way/2-Way Diverter Rough-In Valve

- Wall-mount
- Brass valve body
- Trickle flow from any two outlets to a variable flow from a single outlet
- One 3/4" NPT inlet connection
- Three 1/2" NPT outlet connection
- Can be converted from 3 outlets (360° handle rotation) to 2 outlets (120° handle rotation)



Part #	Mfg #	Description	Handle(s)	Finish	Price
151075	K-737-K-NA	3/4" Wall-mount 3-Way/2-Way Diverter Valve			

* Vibrant Limited Lifetime Warranty

www.waterconcepts.net • Serving our Customers Since 1946 • www.plumbsupply.com

Rough-In Valves

Roman Tub Rough-In Valves

Ceramic High Flow Roman Tub Rough-In Valve

- Tub or deck-mount
- Order trim separately
- (P) Prefix = Project Pack



K-300-K

Part #	Mfg #	Description	Price
053703	K-300-K-NA	1/2" Washerless Ceramic	
121711	K-P300-K-NA	1/2" Washerless Ceramic, P-Pk	
053711	K-301-K-NA	3/4" Washerless Ceramic	

Single Control Roman Tub Rough-In Valves

- Wall-mount
- Order trim separately



Part #	Mfg #	Description	Price
053935	K-307-K-NA	1-Piece Ceramic	

Transfer Valve with Integral Check Valves

- Brass construction
- 2 or 3 Way configuration options
- Backflow prevention
- For use with non-diverter bath spouts



408-K-NA

Part #	Mfg #	Description	Handle(s)	Finish	Price
058425	K-408-K-NA	13 to 15 gpm flow rate			
070360	K-409-K-NA	13 to 15 gpm flow rate			

Mounting-Block/Valve for Bath Fillers

- Required for installation of Purist®, Stillness®, Margaux®, and Kelston® bath fillers



Part #	Mfg #	Description	Handle(s)	Finish	Price
174982	K-97339-NA	1/2" Connections			

* Vibrant Limited Lifetime Warranty

www.plumbsupply.com • Serving our Customers Since 1946 • www.waterconcepts.net

Rough-In Valves

Mounting-Block/Valve for Refinia® Bath Filler

- Brass and metal construction
- Test cap and mud guard included
- Required for installation of the K-T97334-4 Refinia® bath filler



Part #	Mfg #	Description	Handle(s)	Finish	Price
185567	K-97342-NA	1/2" Connections			

Mounting-Block/Valve for Loure® Bath Filler

- Brass and metal construction
- Test cap and mud guard included
- Required for installation of the K-T97330-4 Loure® bath filler



Part #	Mfg #	Description	Handle(s)	Finish	Price
185645	K-97343-NA	1/2" Connections			

* Vibrant Limited Lifetime Warranty

www.waterconcepts.net • Serving our Customers Since 1946 • www.plumbsupply.com

Shower Heads, Arms & Flanges

Rainheads

Contemporary Ceiling-Mount Rain Showerhead

- *Katalyst™ air-induction spray*
- (78) Nozzles
- *Optimized sprayface design creates a denser uniform spray*
- *MasterClean™ sprayface resists mineral buildup*
- *Flow rate: 2.5 gpm*
- *1/2" NPT Connection*
- *Showerarm and flange not included*



Part #	Mfg #	Description	Price
132990	K-13688-BN	8", *Brushed Nickel	
169050	K-13688-BV	8", *Brushed Bronze	
133222	K-13688-CP	8", Polished Chrome	
151105	K-13688-SN	8", *Polished Nickel	
133216	K-13689-BN	10", *Brushed Nickel	
183007	K-13689-BV	10", *Brushed Bronze	
133221	K-13689-CP	10", Polished Chrome	
141123	K-13689-SN	10", *Polished Nickel	
222085	K-13690-BGD	12", *Brushed Gold	
183008	K-13690-BV	12", *Brushed Bronze	

Contemporary Ceiling-Mount Rain Showerhead

- *Katalyst™ air-induction spray*
- *Optimized sprayface*
- *MasterClean™ spray nozzles*
- *Flow rate: 2.5 gpm*
- *1/2" NPT Connection*
- *Showerarm and flange not included*



Part #	Mfg #	Finish	Price
140869	K-13695-BN	8", *Brushed Nickel	
138470	K-13695-CP	8", Polished Chrome	
149585	K-13696-BN	10", *Brushed Nickel	
155303	K-13696-BV	10", *Brushed Bronze	
153387	K-13696-CP	10", Polished Chrome	
160458	K-13696-SN	10", *Polished Nickel	

Contemporary 2.0 Square Rain Showerhead

- *Ceiling-mount*
- *Katalyst™ air-induction spray*
- *Optimized sprayface*
- *MasterClean™ spray nozzles*
- *Flow rate: 2.0 gpm*
- *1/2" NPT Connection*
- *Showerarm and flange not included*



Part #	Mfg #	Finish	Price
166633	K-45200-BN	8", *Brushed Nickel	
174985	K-45200-CP	8", Polished Chrome	

Traditional Round Rain Showerhead

- *Ceiling-mount*
- *Katalyst™ air-induction spray*
- *Optimized sprayface*
- *MasterClean™ spray nozzles*
- *1/2" - 14 NPT connection*
- *Showerarm and flange not included*
- *Flow rate: 2.5 gpm*



Part #	Mfg #	Finish	Price
133469	K-13692-BN	8", *Brushed Nickel	
134305	K-13692-BV	8", *Brushed Bronze	
139187	K-13692-CP	8", Polished Chrome	
183009	K-13692-SN	8", *Polished Nickel	
147027	K-13692-2BZ	8", Oil-Rubbed Bronze	
138312	K-13693-AF	10", *French Gold	
135646	K-13693-BN	10", *Brushed Nickel	
186844	K-13693-BV	10", *Brushed Bronze	
148177	K-13693-CP	10", Polished Chrome	
160869	K-13693-SN	10", *Polished Nickel	
190152	K-13693-VNT	10", Vintage Nickel	
147028	K-13693-2BZ	10", Oil-Rubbed Bronze	
159680	K-13694-BN	12", *Brushed Nickel	
189641	K-13694-BV	12", *Brushed Bronze	
148771	K-13694-CP	12", Polished Chrome	
159396	K-13694-SN	12", *Polished Nickel	
147029	K-13694-2BZ	12", Oil-Rubbed Bronze	

* Vibrant Limited Lifetime Finish

www.plumbsupply.com • Serving our Customers Since 1946 • www.waterconcepts.net

Shower Heads, Arms & Flanges

Faucets & Valves

Traditional Round 2.0 Rain Showerhead

- Ceiling-mount
- *Katalyst™* air-induction spray
- Optimized sprayface
- *MasterClean™* spray nozzles
- 1/2" - 14 NPT connection
- Showerarm and flange not included
- Flow rate: 2.0 gpm



Part #	Mfg #	Finish	Price
177452	K-45202-CP	8", Polished Chrome	
177689	K-45202-2BZ	8", Oil-Rubbed Bronze	

WaterTile® Overhead Shower Panel 9-7/8" x 9-7/8"

- Integrated system for ceiling installation
- (4) 22-nozzle sprayheads
- Individually adjustable pivoting sprayheads simulate a gentle summer rain showering experience
- *MasterClean™* sprayface
- 1/2" NPT connections
- Max combined flow rate: 2.5 gpm



Part #	Mfg #	Finish	Price
164089	K-98740-AF	9-7/8"x9-7/8", *Fr Gold	
164093	K-98740-BGD	9-7/8"x9-7/8", *Moderne Br Gold	
157649	K-98740-BN	9-7/8"x9-7/8", *Br Nickel	
164091	K-98740-BV	9-7/8"x9-7/8", *Br Bronze	
158021	K-98740-CP	9-7/8"x9-7/8", Pol Chrome	
164092	K-98740-G	9-7/8"x9-7/8", Br Chrome	
164094	K-98740-SN	9-7/8"x9-7/8", *Pol Nickel	
158308	K-98740-2BZ	9-7/8"x9-7/8", Oil-Rbd Brz	

WaterTile® Ambient Rain® Overhead Shower Panel

- Integrated system for ceiling installations
- (4) 22-nozzle sprayheads
- Low profile design
- *MasterClean™* sprayface
- Requires DTV II digital shower system
- Individually adjustable pivoting sprayheads simulate a gentle summer rain showering experience
- 1/2" NPT connections
- .6 gpm from each sprayhead
- Model **(K-98747-K1-BN)** is for DTV+™



Part #	Mfg #	Finish	Price
159864	K-98741-BN	21" x 21" *Brushed Nickel	
183661	K-98741-CP	21" x 21", Pol Chrome	
163718	K-98741-2BZ	21" x 21", Oil-Rbd Bronze	
184840	K-98741-K1-BN	DVT+ 21" x 21", *Br Nickel	

Showerheads

Alteo® Single-Function Showerhead

- *Katalyst™* air-induction spray
- *MasterClean™* sprayface
- 1/2" NPT Connection
- Showerarm and flange not included



Part #	Mfg #	Finish	Price
147941	K-45123-BN	2.5 gpm, *Brushed Nickel	
157205	K-45123-CP	2.5 gpm, Polished Chrome	
153842	K-45123-2BZ	2.5 gpm, Oil-Rubbed Brz	
183576	K-5240-BN	2.0 gpm, *Brushed Nickel	

Alteo® Multi-Function Showerhead

- *Katalyst™* air-induction spray
- *MasterClean™* spray nozzles
- Flow rate: 2.0 gpm
- 1/2" NPT Connection
- Showerarm and flange not included



Part #	Mfg #	Finish	Price
165349	K-45125-CP	Polished Chrome	
152390	K-45125-2BZ	Oil-Rubbed Bronze	

* Vibrant Limited Lifetime Finish

www.waterconcepts.net • Serving our Customers Since 1946 • www.plumbsupply.com

Shower Heads, Arms & Flanges

Artifacts® Single-Function Showerhead

- *Katalyst™ air-induction spray*
- *MasterClean™ sprayface*
- *6" Wide sprayface*
- *1/2" NPT Connection*
- *Showerarm and flange not included*



Part #	Mfg #	Finish	Price
162102	K-72773-BN	2.5gpm, *Brushed Nickel	
177299	K-72773-BV	2.5gpm, *Brushed Bronze	
165373	K-72773-CP	2.5gpm, Polished Chrome	
165043	K-72773-SN	2.5gpm, *Polished Nickel	
223898	K-72773-VNT	2.5 gpm, Vintage Nickel	
168456	K-72773-2BZ	2.5gpm, Oil-Rubbed Brnz	
168023	K-72774-BN	2.0gpm, *Brushed Nickel	
162832	K-72774-CP	2.0gpm, Polished Chrome	
223587	K-72774-SN	2.0 gpm, *Polished Nickel	
190150	K-72774-VNT	2.0 gpm, Vintage Nickel	

Awaken® Multi-Function Showerhead

- *Wide coverage, intense drenching, and targeted sprays*
- *Thumb tab for diverting sprays*
- *MasterClean™ sprayface*
- *1/2" NPT connection*
- *Flow rate: 2.0 gpm*
- *Traditional design*
- *Showerarm and flange not included*



Part #	Mfg #	Finish	Price
160470	K-72424-BN	3-3/4", *Br. Nickel, B90	
160261	K-72424-CP	3-3/4", Chrome, B90	
158911	K-72425-BN	4-5/16", *Br. Nickel, B110	
160255	K-72425-CP	4-5/16", Chrome, B110	

Awaken® G110 Multi-Function Showerhead

- *Wide coverage, intense drenching, and targeted sprays*
- *Thumb tab for diverting sprays*
- *MasterClean™ sprayface*
- *1/2" NPT connection*
- *Flow rate: 2.0 gpm*
- *Contemporary design*
- *Showerarm and flange not included*



Part #	Mfg #	Finish	Price
160468	K-72418-BN	3-9/16", *Br. Nickel, G90	
160258	K-72418-CP	3-9/16", Chrome, G90	
160426	K-72419-BN	4-5/16", *Brushed Nickel	

Showerheads (Continued)

Awaken® G110 Multi-Function Showerhead

Part #	Mfg #	Finish	Price
160259	K-72419-CP	4-5/16", Polished Chrome	
143014	K-10590-AK-CP	5-5/16", Polished Chrome	

Awaken® G90 Single-Function Showerhead

- *MasterClean™ spray nozzles*
- *3-9/16" Diameter*
- *1/2" -14 NPT connection*
- *Flow rate: 1.75 gpm*



Part #	Mfg #	Finish	Price
174436	K-72417-BN	3-9/16", *Brushed Nickel	
187831	K-72417-CP	3-6/16", Polished Chrome	

Bancroft® Single-Function Showerhead

- *Katalyst™ spray technology*
- *MasterClean™ spray nozzles*
- *Flow rate: 2.5 gpm*
- *1/2" - 14 NPT connection*
- *Single function*
- *Showerarm and flange not included*



Part #	Mfg #	Finish	Price
142299	K-10590-AK-BN	5-5/16", *Brushed Nickel	
172789	K-10590-AK-SN	5-5/16", *Polished Nickel	

Bancroft® 2.5 gpm Single-Function Showerhead

- *Katalyst® air-induction spray*
- *Optimized sprayface with 66 nozzles*
- *Minimizes wasteful overspray*
- *MasterClean™ sprayface*
- *1/2" NPT connection*
- *Showerarm and flange not included*



Part #	Mfg #	Finish	Price
154340	K-10590-AK-2BZ	5-5/16", Oil-Rubbed Brnz	

* Vibrant Limited Lifetime Finish

www.plumbsupply.com • Serving our Customers Since 1946 • www.waterconcepts.net

Shower Heads, Arms & Flanges

Faucets & Valves

Bancroft® 2.5 gpm Multi-Function Showerhead

- Wide, full, aerated, and massage spray functions
- MasterClean™ sprayface
- 1/2" NPT connection
- Flow rate: 2.5 gpm
- Showerarm and flange not included



Part #	Mfg #	Finish	Price
103466	K-10591-BN	5-5/16", *Brushed Nickel	
106869	K-10591-BV	5-5/16", *Brushed Bronze	
091757	K-10591-CP	5-5/16", Polished Chrome	
146020	K-10591-SN	5-5/16", *Polished Nickel	
148765	K-10591-2BZ	5-5/16", Oil-Rubbed Brz	

City Club™ 2.5 gpm Single Function Showerhead

- Wall Mount
- Adjustable Sprayhead
- 1/2" NPT connection
- Showerarm and flange not included



Part #	Mfg #	Finish	Price
185186	K-7351-BV	2.5 gpm, *Brushed Bronze	

Coralais® Single Function Showerhead

- Wall-mount
- 1/2" NPT connection
- Showerarm and flange not included
- Sprayface with flexible nozzles



Part #	Mfg #	Finish	Price
188239	K-11637-CP	2.5 gpm, Polished Chrome	

Devonshire® Single-Function Showerhead

- 5-15/16" Diameter
- Catalyst™ spray technology
- 66 MasterClean™ spray nozzles
- 1/2" NPT connection
- Single function
- Showerarm and flange not included



Part #	Mfg #	Finish	Price
164467	K-10391-AK-BN	2.5 gpm, *Brushed Nickel	
182984	K-10391-AK-BV	2.5 gpm, *Brushed Bronze	
161600	K-10391-AK-CP	2.5 gpm, Polished Chrome	
182985	K-10391-AK-PB	2.5 gpm, *Polished Brass	
183446	K-10391-AK-SN	2.5 gpm, *Polished Nickel	
146949	K-10391-AK-2BZ	2.5 gpm, Oil-Rubbed Brz	

Showerheads (Continued)

Devonshire® Single-Function Showerhead

Part #	Mfg #	Finish	Price
173431	K-45413-BN	2.0 gpm, *Brushed Nickel	
146971	K-45413-2BZ	2.0 gpm, Oil-Rubbed Brz	

Exhale™ Multi-function Showerhead

- Catalyst™ spray technology with air induction ball joint
- Advanced spray engine provides for spray experiences
- 360° rotation of sprayface cycles
- Shower arm and flange not included



Part #	Mfg #	Finish	Price
189105	K-72597-CP	2.0 gpm, Polished Chrome	

Fairfax® 2.5 gpm Single-Function Showerhead

- Catalyst™ spray technology
- 66 MasterClean™ spray nozzles
- 5-1/2"
- 1-2" NPT connection
- Showerarm and flange not included



Part #	Mfg #	Finish	Price
225844	K-12008-AK-CP	2.5 gpm, Polished Chrome	

Fairfax® 2.5 gpm Multi-Function Showerhead

- MasterClean™ sprayface
- 1/2" NPT connection
- Showerarm and flange NOT included



Part #	Mfg #	Finish	Price
130669	K-12009-2BZ	2.5gpm, Oil Rubbed Bronze	

Forté® Single-Function 5-1/2" Showerhead

- Catalyst™ spray technology with air induction ball joint
- 66 MasterClean™ spray nozzles
- 1/2" - 14 NPT connection
- Showerarm and flange not included



Part #	Mfg #	Finish	Price
226671	K-10282-AK-AF	2.5 gpm, *French Gold	
151903	K-10282-AK-BN	2.5 gpm, *Brushed Nickel	

* Vibrant Limited Lifetime Finish

www.waterconcepts.net • Serving our Customers Since 1946 • www.plumbsupply.com

Shower Heads, Arms & Flanges

Showerheads (Continued)

Forté® Single-Function 5-1/2" Showerhead

Part #	Mfg #	Finish	Price
139248	K-10282-AK-CP	2.5 gpm, Polished Chrome	
224818	K-10282-AK-G	2.5 gpm, Brushed Chrome	
183168	K-10282-AK-PB	2.5 gpm, *Polished Brass	
148255	K-10327-CP	2.0 gpm, Polished Chrome	

Forté® 2.5 gpm Multi-Function Showerhead

- MasterClean® spray nozzles
- Full-coverage, therapeutic massage, soft-aerated spray, and water-saving eco spray options
- 1/2" - 14 NPT connection
- Showerarm and flange not included



Part #	Mfg #	Finish	Price
096597	K-10284-AF	5-15/16", *French Gold	
084528	K-10284-BN	5-15/16", *Brushed Nickel	
092039	K-10284-BV	5-15/16", *Brushed Bronze	
082271	K-10284-CP	5-15/16", Polished Chrome	
088585	K-10284-G	5-15/16", Brushed Chrome	
088479	K-10284-PB	5-15/16", *Polished Brass	
157860	K-10284-2BZ	5-15/16", Oil-Rubbed Brz	

Flipside™ 2.5 gpm Multi-Function Showerhead

- Flipstream Technology™
- Four unique, experiential spray patterns
 - Koverage™ (full),
 - Kotton™ (downpour),
 - Kotion™ (soft)
 - Kurrent™ (massage)
- Wall-mount
- Adjustable angle for various user heights
- Showerarm and flange not included



Part #	Mfg #	Finish	Price
133052	K-15996-BN	2.5 gpm, *Brushed Nickel	
133007	K-15996-CP	2.5 gpm, Polished Chrome	
224246	K-15996-SN	2.5 gpm, *Polished Nickel	
171988	K-15996-2BZ	2.5 gpm, Oil-Rubbed Brnz	

Loure™ 2.5 gpm Single-Function Showerhead

- Katalyst® air-induction spray
- (66) MasterClean™ spray nozzles
- 1/2" - 14 NPT connection
- Single-function spray
- Showerarm and flange not included



Part #	Mfg #	Finish	Price
151578	K-14786-BN	*Brushed Nickel	
171520	K-14786-CP	Polished Chrome	

Margaux® Single-Function Wall-Mount Showerhead

- MasterClean® spray nozzles prohibit mineral buildup for easy cleaning
- 1/2" - 14 NPT connection
- Showerarm and flange not included
- (AK) represents Katalyst® air-induction spray



Part #	Mfg #	Finish	Price
156077	K-45410-BN	2.0 gpm, *Brushed Nickel	
140673	K-16244-AK-AF	2.5 gpm, * French Gold	
165959	K-16244-AK-BN	2.5 gpm, *Brushed Nickel	
188545	K-16244-AK-BV	2.5 gpm, *Brushed Bronze	
146376	K-16244-AK-CP	2.5 gpm, Polished Chrome	

Margaux® 2.5 gpm Multi-Function Showerhead

- MasterClean™ sprayface
- 1/2" NPT connection
- Showerarm and flange NOT included



Part #	Mfg #	Finish	Price
111106	K-16245-BN	2.5 gpm, *Brushed Nickel	
122583	K-16245-BV	2.5 gpm, *Brushed Bronze	
117638	K-16245-CP	2.5 gpm, Polished Chrome	
160868	K-16245-SN	2.5 gpm, *Polished Nickel	

MasterShower® Invigorating 2.5 gpm Multi-Function Showerhead

- Spray modes: wide strong spray, concentrated pulse and wide pulse
- Easy-grip for smooth switching between spray options
- MasterClean™ sprayface
- Showerarm and flange not included



Part #	Mfg #	Finish	Price
053749	K-8506-BN	*Brushed Nickel	
053746	K-8506-CP	Polished Chrome	

* Vibrant Limited Lifetime Finish

www.plumbsupply.com • Serving our Customers Since 1946 • www.waterconcepts.net

Shower Heads, Arms & Flanges

Faucets & Valves

MasterShower® Multi-Function Wall-Mount Relaxing 3-Way Showerhead

- Spray modes: wide soft, slow pulse and soft aerated
- Easy-grip for smooth switching between spray options
- Showerarm and flange not included



Part #	Mfg #	Finish	Price
053750	K-8507-BN	2.5 gpm, *Brushed Nickel	
057239	K-8507-CP	2.5 gpm, Polished Chrome	
105033	K-8544-CP	2.0 gpm, Polished Chrome	

Memoirs® 2.0 gpm Single-Function Showerhead

- Katalyst® spray
- MasterClean™ sprayface with (66) nozzles
- 1/2" NPT connection



Part #	Mfg #	Finish	Price
162824	K-457-AK-BN	2.0 gpm, *Brushed Nickel	
144003	K-457-AK-CP	2.0 gpm, Polished Chrome	

Memoirs® 2.5 gpm Multi-Function Showerhead

- MasterClean™ sprayface
- 1/2" NPT connection
- Showerarm and flange not included



Part #	Mfg #	Finish	Price
083155	K-444-BN	2.5 gpm, *Brushed Nickel	
098522	K-444-BV	2.5 gpm, *Brushed Bronze	
081486	K-444-CP	2.5 gpm, Polished Chrome	
173097	K-444-2BZ	2.5 gpm, Oil-Rubbed Brz	

Moxie® 2.5 gpm Single-Function Showerhead with Wireless Speaker

- Water-resistant, removable speaker
- USB charging table included
- Showerarm and flange not included
- Syncs with Bluetooth-enabled devices
- Lithium-ION battery provides 7 hours of runtime



Part #	Mfg #	Finish	Price
159709	K-9245-BN	5", *Brushed Nickel	
154131	K-9245-CP	5", Polished Chrome	
154132	K-9245-0	5", White	

Showerheads (Continued)

Moxie® 2.5 gpm Single-Function Showerhead with Wireless Speaker

Part #	Mfg #	Finish	Price
159710	K-9245-2BZ	5", Oil-Rubbed Bronze	

Moxie™ 2.5 gpm Raincan Showerhead with Wireless Speaker

- Lithium-ION battery
- Syncs with Bluetooth enabled devices
- Water-resistant, removable speaker
- USB charging table included
- Showerarm and flange not included



Part #	Mfg #	Finish	Price
166461	K-99105-BN	8", *Brushed Nickel	
166460	K-99105-CP	8", Polished Chrome	
166462	K-99105-2BZ	8", Oil-Rubbed Bronze	

Moxie® Wireless Speaker

- Speaker insert only



Part #	Mfg #	Finish	Price
161727	K-9246-FBG	Retro Blue	
161725	K-9246-FGN	Chartreuse	
161726	K-9246-FNY	Navy Blue	
161728	K-9246-FRD	Cherry Red	

Pinstripe® 2.5 gpm Single-Function Showerhead

- Katalyst® air induction technology
- MasterClean™ spray nozzles
- 1/2" NPT connection
- Showerarm and flange not included



Part #	Mfg #	Finish	Price
189402	K-13137-AK-CP	5-9/16", Polished Chrome	

* Vibrant Limited Lifetime Finish

www.waterconcepts.net • Serving our Customers Since 1946 • www.plumbsupply.com

Shower Heads, Arms & Flanges

Purist® 2.5 gpm Single-Function Showerhead

- *Katalyst™ spray technology with air induction ball joint*
- *MasterClean™ spray nozzles*
- *1/2" - 14 NPT connection*
- *Showerarm and flange not included*



Part #	Mfg #	Finish	Price
140178	K-965-AK-BN	5-1/2", *Brushed Nickel	
152242	K-965-AK-CP	5-1/2", Polished Chrome	
158852	K-965-AK-SN	5-1/2", *Polished Nickel	

Purist® 2.0 gpm Single-Function Showerhead

- *Katalyst™ spray technology with air induction ball joint*
- *MasterClean™ spray nozzles*
- *1/2" - 14 NPT connection*
- *Showerarm and flange not included*



Part #	Mfg #	Finish	Price
183163	K-939-BN	5-1/2", *Brushed Nickel	

Purist® 2.5 gpm Multi-Function Showerhead

- *MasterClean™ sprayface*
- *1/2" NPT connection*
- *Flow rate: 2.5 gpm*
- *Showerarm and flange not included*



Part #	Mfg #	Finish	Price
109453	K-966-BN	5-1/2", *Brushed Nickel	
152201	K-966-BV	5-1/2", *Brushed Bronze	
086903	K-966-CP	5-1/2", Polished Chrome	
179768	K-966-SN	5-1/2", *Polished Nickel	

MasterShower™ Multi-Function 3-Way Showerhead with Relaxing Spray

- *Spray modes: full coverage, aerated, and massage*
- *Flow rate: 2.6 gpm*
- *Showerarm and flange not included*



Part #	Mfg #	Finish	Price
122908	K-GP85918-BN	*Brushed Nickel	

Revival® Single-Function Showerhead

- *Katalyst® air induction spray*
- *MasterClean™ sprayface*
- *48 Nozzles*
- *1/2" NPT connections*
- *Showerarm and flange not included*



Part #	Mfg #	Finish	Price
183572	K-45411-CP	2.0 GPM, Pol Chrome	

WaterTile® Wall-Mounted Square 54-Nozzle Showerhead with Soothing Spray

- *Fully adjustable, pivoting MasterClean™ sprayface*
- *1/2" NPT connections*
- *Flow rate: 2.2 gpm*



Part #	Mfg #	Finish	Price
118978	K-8022-AF	*French Gold	
086871	K-8022-BN	*Brushed Nickel	
095057	K-8022-BV	*Brushed Bronze	
086263	K-8022-CP	Polished Chrome	
096555	K-8022-G	Brushed Chrome	
149151	K-8022-SN	*Polished Nickel	
174163	K-8022-2BZ	Oil-Rubbed Bronze	

WaterTile® Wall-Mounted Square 22-Nozzle Showerhead with Stimulating Spray

- *Fully adjustable, pivoting MasterClean™ sprayface*
- *1/2" NPT connections*
- *Flow rate: 2.2 gpm*



Part #	Mfg #	Finish	Price
183151	K-8023-BV	*Brushed Bronze	
086264	K-8023-CP	Polished Chrome	
183153	K-8023-SN	*Polished Nickel	

Showerarms

Alteo® Showerarm & Flange

- *Brass construction*
- *1/2" NPT connection*
- *5-3/8" Reach*



Part #	Mfg #	Finish	Price
148791	K-45129-BN	*Brushed Nickel	
172067	K-45129-CP	Polished Chrome	
153841	K-45129-2BZ	Oil-Rubbed Bronze	

* Vibrant Limited Lifetime Finish

www.plumbsupply.com • Serving our Customers Since 1946 • www.waterconcepts.net

Shower Heads, Arms & Flanges

Faucets & Valves

Artifacts® Showerarm and Flange

- Metal construction
- 1/2" NPT connection
- 10-11/16" Reach



Part #	Mfg #	Finish	Price
162139	K-72775-BN	*Brushed Nickel	
177298	K-72775-BV	*Brushed Bronze	
162833	K-72775-CP	Polished Chrome	
165040	K-72775-SN	*Polished Nickel	
190148	K-72775-VNT	Vintage Nickel	
168457	K-72775-2BZ	Oil-Rubbed Bronze	

12" Ceiling Mount Showerarm & Flange

- Brass construction
- 1/2" NPT connection



Part #	Mfg #	Finish	Price
222084	K-7392-BGD	*Moderne Brushed Gold	
133215	K-7392-BN	*Brushed Nickel	
183146	K-7392-BV	*Brushed Bronze	
133224	K-7392-CP	Polished Chrome	
178253	K-7392-SN	*Polished Nickel	
147031	K-7392-2BZ	Oil-Rubbed Bronze	

Loure® Showerarm & Flange

- 7-1/2" Reach
- 1/2" NPT connection



Part #	Mfg #	Finish	Price
145700	K-14679-BN	*Brushed Nickel	
170402	K-14679-CP	Polished Chrome	

Loure® Square Showerarm and Flange

- 8-1/2" Reach
- 1/2" NPT Connection



Part #	Mfg #	Finish	Price
186199	K-99690-BN	*Brushed Nickel	
185643	K-99690-CP	Polished Chrome	

Margaux® Showerarm and Flange

- 10-5/8" reach
- 1/2" NPT connection



Part #	Mfg #	Finish	Price
141677	K-16280-BN	*Brushed Nickel	
114256	K-16280-BV	*Brushed Bronze	
130262	K-16280-CP	Polished Chrome	
145256	K-16280-SN	*Polished Nickel	

Margaux® 90° Showerarm & Flange

- 14-5/8" Reach
- 1/2" NPT connection



Part #	Mfg #	Finish	Price
171243	K-16279-CP	Polished Chrome	
166839	K-16279-SN	*Polished Nickel	

Margaux® 3" Ceiling-Mount Showerarm & Flange

- 1/2" NPT connection



Part #	Mfg #	Finish	Price
160460	K-16287-SN	3", *Polished Nickel	

Margaux® Cast Showerarm

- 6-1/2" Reach
- 1/2" NPT connection



Part #	Mfg #	Finish	Price
111105	K-16281-BN	*Brushed Nickel	
122582	K-16281-BV	*Brushed Bronze	
117637	K-16281-CP	Polished Chrome	
135069	K-16281-SN	*Polished Nickel	

* Vibrant Limited Lifetime Finish

www.waterconcepts.net • Serving our Customers Since 1946 • www.plumbsupply.com

Shower Heads, Arms & Flanges

MasterShower® Ceiling -Mount Showerarm & Flange

- 1/2" NPT connection



Part #	Mfg #	Finish	Price
138313	K-7394-AF	6", *French Gold	
133214	K-7394-BN	6", *Brushed Nickel	
140872	K-7394-BV	6", *Brushed Bronze	
133223	K-7394-CP	6", Polished Chrome	
141124	K-7394-SN	6", *Polished Nickel	
190151	K-7394-VNT	6", Vintage Nickel	
147032	K-7394-2BZ	6", Oil-Rubbed Bronze	
059590	K-7396-BN	3", *Brushed Nickel	
075020	K-7396-BV	3", *Brushed Bronze	
053531	K-7396-CP	3", Polished Chrome	
151106	K-7396-SN	3", *Polished Nickel	
147033	K-7396-2BZ	3", Oil-Rubbed Bronze	

MasterShower® Showerarm & Flange

- Brass construction
- 1/2" NPT Connection



Part #	Mfg #	Finish	Price
162820	K-7395-BN	5-3/8", *Brushed Nickel	
078842	K-7395-CP	5-3/8", Polished Chrome	
071988	K-7395-PB	5-3/8", *Polished Brass	
170637	K-7395-2BZ	5-3/8", Oil-Rubbed Bronze	
075037	K-7397-BN	7-1/2", *Brushed Nickel	
059781	K-7397-CP	7-1/2", Polished Chrome	
147034	K-7397-2BZ	7-1/2", Oil Rubbed Bronze	

Purist® 8-1/2" Showerarm and Flange

- Premium metal construction
- 1/2" NPT connection



Part #	Mfg #	Finish	Price
185181	K-933-BN	8-1/2" *Brushed Nickel	
181280	K-933-CP	8-1/2", Polished Chrome	

Revival® 5-3/8" Showerarm

- 1/2" NPT connection



Part #	Mfg #	Finish	Price
080816	K-16133-AF	5-3/8", *French Gold	
073949	K-16133-BN	5-3/8", *Brushed Nickel	
096896	K-16133-BV	5-3/8", *Brushed Bronze	
073679	K-16133-CP	5-3/8", Polished Chrome	
080202	K-16133-PB	5-3/8", *Polished Brass	
157858	K-16133-2BZ	5-3/8", Oil-Rubbed Bronze	

Right Angle Showerarm and Flange

- Brass construction
- 1/2" NPT connection
- 14-5/8" Reach



Part #	Mfg #	Finish	Price
125722	K-10124-AF	14-5/8", *French Gold	
102528	K-10124-BN	14-5/8", *Brushed Nickel	
103948	K-10124-BV	14-5/8", *Brushed Bronze	
094715	K-10124-CP	14-5/8", Polished Chrome	
137782	K-10124-G	14-5/8", Brushed Chrome	
148320	K-10124-SN	14-5/8", *Polished Nickel	
147022	K-10124-2BZ	14-5/8", Oil-Rubbed Brnz	

Stillness® Showerarm and Flange

- 1/2" NPT connection
- 7-1/2" Reach



Part #	Mfg #	Finish	Price
181477	K-934-CP	7-1/2", Polished Chrome	

* Vibrant Limited Lifetime Finish

www.plumbsupply.com • Serving our Customers Since 1946 • www.waterconcepts.net

Shower Heads, Arms & Flanges

Faucets & Valves

Showerheads

Baliza® Raincan Showerhead

- H2Okinetic® Technology
- Finished sprayface
- WaterSense® certified product: 2.0 gpm @ 80 psi



Part #	Mfg #	Description	Price
171585	87305-PC	Chrome	
168306	87305-RB	Venetian Bronze®	

Baliza® Hydrati 2-in-1 Showerhead

- Integrated H2Okinetic® Technology showerhead and handshower
- Four-setting push button handshower
 - H2Okinetic® Spray
 - H2Okinetic® Spray w/Massage
 - Massage Spray
 - Pause
- Flow rate: 2.5 gpm @ 80 psi



Part #	Mfg #	Description	Price
171552	86200-BN	Brushed Nickel*	
171551	86200-PC	Chrome	
159402	86200-PN	Polished Nickel*	
168734	86200-RB	Venetian Bronze®	

Charlotte™ Raincan Showerhead

- 8-1/4" Diameter
- H2Okinetic™ technology
- Maximum flow rate: 2.5 gpm @ 80 psi



Part #	Mfg #	Description	Price
156698	81385-PNCO	8-1/4" Diameter Cocoa Bronze™/Pol Nickel	
168147	87385-PNCO	5-13/16" Diameter Cocoa Bronze™/Pol Nickel	

Jason Wu Hydrati® 2-in-1 Showerhead

- H2Okinetic® technology spray
- Magedock™ docking system
- Integrated showerhead and handshower
- 4-Setting spray functions
- 60" - 82" Stretchable metal hose
- Maximum flow rate: 2.5 gpm @ 80 psi



Part #	Mfg #	Description	Price
178624	86275-BL	Matte Black	
186513	86275-BN	Brushed Nickel*	
180764	86275-NK	Luxe Nickel*	
159461	86275-PC	Chrome	

Odin Showerhead

- H2Okinetic® technology spray
- 5-3/8" Diameter
- Maximum flow rate: 2.5 gpm @ 80 psi



Part #	Mfg #	Description	Price
178516	87375-BL	Matte Black	
157995	87375-PC	Chrome	

Odin™ Raincan Showerhead

- 8" Diameter
- Maximum flow rate: 2.5 gpm @ 80 psi



Part #	Mfg #	Description	Price
162438	81375-BN	Brushed Nickel*	
186177	81375-PC	Chrome	

Rook™ Multi-Function Showerhead

- 8" Diameter
- H2Okinetic® technology
- Finished spray face
- Four spray settings
 - Invigorating H2Okinetic spray
 - Full body H2Okinetic spray
 - Massage spray & pause
- Watersense® certified product: 2.0 gpm



Part #	Mfg #	Description	Price
223093	87461-NKBL	Luxe Nickel/Matte Black	

* Brilliance® Anti-Tarnish Lifetime Finishes

www.waterconcepts.net • Serving our Customers Since 1946 • www.plumbsupply.com

Shower Heads, Arms & Flanges

RSVP® Two-Function Showerhead

- Full spray, and massage spray
- Flow rate: 2.5 gpm @ 80 psi



Part #	Mfg #	Description	Price
162290	RP48041BN	Brushed Nickel*	
120980	RP48041BZ	Brushed Bronze*	
127004	RP48041PC	Chrome	

Siderna® Raincan Showerhead

- Single-function spray
- H2Okinetic® technology
- 5-3/8" Diameter
- WaterSense® certified product: 2.0 gpm @ 80 psi



Part #	Mfg #	Description	Price
188611	87380-BL	Matte Black	
159083	87380-BN	Brushed Nickel*	
167704	87380-PC	Chrome	

Siderna® Hydrati 2-in-1 Showerhead

- Integrated H2OKinetic® technology
- Four-setting push button handshower
- Flow rate: 2.5 gpm @ 80 psi



Part #	Mfg #	Description	Price
174212	86280-BN	Brushed Nickel*	

Siderna® Ceiling-Mount Showerhead

- Single-function
- Finished spray face
- Touch-Clean® features
- 8-5/8" x 5-3/4" Rectangular raincan showerhead
- Flow rate: 2.5 gpm @ 80 psi



Part #	Mfg #	Description	Price
222413	81380-BL	Matte Black	

Sotria™ H2Okinetic® Raincan Showerhead

- 7" Diameter
- Five spray settings
 - Full spray
 - Full spray with massage
 - Massage spray
 - H2Okinetic® spray
 - Pause
- Finished spray face
- Touch-Clean® nozzles
- WaterSense® certified product: 2.0 gpm @ 80 psi



Part #	Mfg #	Description	Price
223971	87450-BL	Matte Black	

Sotria™ Raincan Showerhead

- H2Okinetic® technology
- 10-3/8" Diameter
- Finished sprayface
- Flow rate: 2.5 gpm @ 80 psi



Part #	Mfg #	Description	Price
177378	81350-BL	Matte Black	

Traditional 9" Touch-Clean® Rain Can Showerhead

- Single-function
- Finished spray face
- Flow Rate: 2.5 gpm @ 80 psi



Part #	Mfg #	Finish	Price
129694	RP52090PC	Chrome	
124301	RP52090BN	Brushed Nickel*	
124215	RP52090RB	Venetian Bronze®	

Traditional Raincan Showerhead

- 11" Diameter
- Maximum flow rate: 2.5 gpm @ 80 psi



Part #	Mfg #	Description	Price
165443	83310-BN	Brushed Nickel*	
223096	83310-NK	Luxe Nickel*	
145728	83310-PC	Chrome	
145234	83310-RB	Venetian Bronze®	

* Brilliance® Anti-Tarnish Lifetime Finishes

www.plumbsupply.com • Serving our Customers Since 1946 • www.waterconcepts.net

Shower Heads, Arms & Flanges

Faucets & Valves

Vesi® Raincan Showerhead

- 8" Diameter
- Maximum flow rate: 2.5 gpm @ 80 psi



Part #	Mfg #	Description	Price
131155	83341-BN	Brushed Nickel*	
171182	83341-BZ	Brushed Bronze*	
131154	83341-PC	Chrome	
177301	83341-RB	Venetian Bronze®	

Virage® Raincan Showerhead

- H2Okinetic® Technology
- Maximum flow rate: 2.5 gpm @ 80 psi



Part #	Mfg #	Description	Price
153335	81330-BN	8"x8", Brushed Nickel*	
176624	81330-BZ	8"x8", Brushed Bronze*	
143547	81330-PC	8"x8", Chrome	
153311	81330-RB	8"x8", Venetian Bronze®	
185740	87330-BN	6"x6", Brushed Nickel*	
163879	87330-PC	6"x6", Chrome	
170001	87330-PN	6"x6", Polished Nickel*	
164985	87330-RB	6"x6", Venetian Bronze®	

Vesi® Single Function Raincan Showerhead

- H2Okinetic® technology
- Finished sprayface matches shell finish
- 5-1/4" x 5-1/4" Square showerhead
- WaterSense® certified product: 2.0 gpm @ 80 psi



Part #	Mfg #	Description	Price
222653	87340-RB	Venetian Bronze	

Vesi® Wall-Mount Showerhead

- Multi-function
- Flow rate: 2.5 gpm @ 80 psi
- Showerarm and flange sold separately



Part #	Mfg #	Description	Price
143398	RP42431	Chrome	
090094	RP42431BN	Brushed Nickel*	
097361	RP42431BZ	Brushed Bronze*	
176455	RP42431RB	Venetian Bronze®	

Vesi® Hydrati 2-in-1 Showerhead

- Four-setting push button handshower
 - H2Okinetic® spray
 - H2Okinetic spray with massage
 - Massage spray
 - Pause
- H2Okinetic® technology
- MagneDock® technology
- Maximum flow rate: 2.5 gpm @ 80 psi



Part #	Mfg #	Description	Price
224535	86201-BZ	Brushed Bronze*	

Showerarms

Baliza® Shower Arm & Flange

- 7" Reach



Part #	Mfg #	Description	Price
181112	RP62929BN	Brushed Nickel*	
159460	RP62929PC	Chrome	
159401	RP62929PN	Polished Nickel*	
149365	RP62929RB	Venetian Bronze®	

Vesi® Ceiling-Mount Showerarm & Flange

- Shower arm with flange
- 1/2" IPS male threads



Part #	Mfg #	Description	Price
138232	RP48985BB	6", Brass*	
177377	RP48985BL	6", Matte Black	
105657	RP48985BN	6", Brushed Nickel*	
107526	RP48985BZ	6", Brushed Bronze*	
223094	RP48985NK	6", Luxe Nickel*	
111314	RP48985PC	6", Chrome	
156697	RP48985PN	6", Polished Nickel*	
124214	RP48985RB	6", Venetian Bronze®	
105658	RP48986-BN	10", Brushed Nickel*	
163825	RP48986-PN	10", Polished Nickel*	

* Brilliance® Anti-Tarnish Lifetime Finishes

www.waterconcepts.net • Serving our Customers Since 1946 • www.plumbsupply.com

Shower Heads, Arms & Flanges

Charlotte® Shower Arm Assembly

- 8" Long shower arm with flange
- Use with 87385 or 81385



Part #	Mfg #	Description	Price
189483	RP70909PC	8", Chrome	
168146	RP70909PN	8", Polished Nickel*	

Brizo® Wall- Mount Showerarm & Flange



Part #	Mfg #	Description	Price
178517	RP74751BL	Matte Black	
222155	RP74751BN	Brushed Nickel*	
180765	RP74751NK	Luxe Nickel*	
184778	RP74751PC	Chrome	

Euro Shower Arm and Flange



Part #	Mfg #	Description	Price
188719	RP71648BL	15", Matte Black	
174047	RP71648BN	15", Brushed Nickel*	

Rook™ Showerarm and Flange



Part #	Mfg #	Description	Price
223092	RP78580NK	7", Luxe Nickel*	
223520	RP78580PN	7", Polished Nickel*	

RSVP® Showerarm



Part #	Mfg #	Description	Price
162289	RP48040BN	7", Brushed Nickel*	
120982	RP48040BZ	7", Brushed Bronze*	
127005	RP48040PC	7", Chrome	

Siderna® Shower Arm & Flange



Part #	Mfg #	Description	Price
158702	RP71650BN	15", Brushed Nickel*	
188612	RP74448BL	7", Matte Black	
159082	RP74448BN	7", Brushed Nickel*	
167705	RP74448PC	7", Chrome	

Siderna® Ceiling-Mount Showerarm & Flange



Part #	Mfg #	Description	Price
153334	RP70764BN	6", Brushed Nickel*	
226387	RP70764BL	6", Matte Black	
176623	RP70764BZ	6", Brushed Bronze*	
163744	RP70764PC	6" Chrome	
153312	RP70764RB	6", Venetian Bronze®	
158801	RP70765PC	10", Chrome	

Traditional Showerarm & Flange

- 16"



Part #	Mfg #	Description	Price
128937	RP54168PC	16", Chrome	
141944	RP54168BN	16", Brushed Nickel*	
118400	RP54168RB	16", Venetian Bronze®	

Vesi Channel® Showerarm & Flange



Part #	Mfg #	Description	Price
158294	RP71649BN	Brushed Nickel*	
189720	RP71649BZ	Brushed Bronze*	
177781	RP71649PC	Chrome	
190412	RP71649PN	Polished Nickel*	

* Brilliance® Anti-Tarnish Lifetime Finishes

www.plumbsupply.com • Serving our Customers Since 1946 • www.waterconcepts.net

Shower Heads, Arms & Flanges

Showerarms (Continued)

Vesi Channel® Showerarm & Flange

Part #	Mfg #	Description	Price
222652	RP71649RB	Venetian Bronze	

Virage® Showerarm



Part #	Mfg #	Description	Price
185739	RP62603BN	Brushed Nickel*	
163881	RP62603PC	Chrome	
170000	RP62603PN	Polished Nickel*	
164987	RP62603RB	Venetian Bronze®	

Faucets & Valves

* Brilliance® Anti-Tarnish Lifetime Finishes

www.waterconcepts.net • Serving our Customers Since 1946 • www.plumbsupply.com

Shower Heads, Arms & Flanges

Showerheads

Addison™ Raincan Single-Setting Showerhead

- H2Okinetic® spray
- Self-cleaning H2Okinetic® spray holes
- 6" Spray face diameter
- 2-3/4" Showerhead length
- WaterSense® certified: 2.0 gpm @ 80 psi



Part #	Mfg #	Finish	Price
139581	RP61265CZ	Champagne Bronze™	
134811	RP61265SS	Stainless*	

H2Okinetic® Raincan Single-Setting Showerhead

- Self-cleaning H2Okinetic® spray holes
- 2-1/2" Showerhead length
- 8" spray face diameter
- Maximum flow: 2.5 gpm @ 80 psi



Part #	Mfg #	Finish	Price
138125	RP61274	Chrome	
130956	RP61274RB	Venetian Bronze®	
139972	RP61274SS	Stainless*	

Arzo® Touch-Clean® Single-Function Showerhead

- 2-1/2" Showerhead length
- 8" Square finished spray face
- Includes showerhead, showerarm and flange
- 16" long shower arm
- All metal
- Maximum flow: 2.5 gpm @ 80 psi



Part #	Mfg #	Finish	Price
127752	57740	Chrome	
125057	57740-SS	Stainless*	

Arzo® Touch-Clean® Raincan Showerhead

- Touch-Clean® spray holes
- 8" Square finished spray face
- 2-1/2" Showerhead length
- All metal
- 16" long shower arm
- Maximum flow: 2.5 gpm @ 80 psi



Part #	Mfg #	Finish	Price
138439	RP53496	Chrome	
136964	RP53496SS	Stainless*	

Arzo® 8" Touch-Clean® Raincan Showerhead

- Features Touch-Clean® spray holes
- Single-setting showerhead -Soft rain spray
- 8" Square spray face
- 2-1/2" Showerhead length
- Maximum flow: 2.5 gpm @ 80 psi



Part #	Mfg #	Finish	Price
119166	RP50841	Chrome	
152079	RP50841-SS	Stainless*	

Ashlyn® Touch-Clean® Raincan Showerhead

- Single-setting showerhead -Full body spray
- 5-1/4" Spray face diameter
- 2-11/16" Showerhead length
- WaterSense certified product: 2.0 gpm @ 80 psi



Part #	Mfg #	Description	Price
175767	RP64859	Chrome	
172453	RP64859-RB	Venetian Bronze®	
173663	RP64859-SS	Stainless*	

Classic Touch-Clean® Showerhead

- Single-setting showerhead Full body spray
- Features Touch-Clean® spray holes
- 2-5/8" Spray face diameter
- 2-1/2" Showerhead length
- Maximum flow: 2.0 gpm @ 80 psi



Part #	Mfg #	Finish	Price
067293	RP38357	Chrome	
146392	RP38357SS	Stainless*	

Dryden™ Touch-Clean® Raincan Showerhead

- Single-setting showerhead -Full body spray
- Features Touch-Clean® spray holes
- 6-1/2" Spray face across
- 3-1/8" Showerhead length
- Maximum flow: 2.5 gpm @ 80 psi



Part #	Mfg #	Finish	Price
129504	RP62283	Chrome	
147192	RP62283CZ	Champagne Bronze™	
131412	RP62283RB	Venetian Bronze®	
135077	RP62283SS	Stainless*	

* Brilliance® Anti-Tarnish Lifetime Finishes

www.plumbsupply.com • Serving our Customers Since 1946 • www.waterconcepts.net

Shower Heads, Arms & Flanges

Faucets & Valves

Dryden™ H2OKinetic® Showerhead

- Single-setting showerhead -H2OKinetic® spray
- Self-cleaning H2OKinetic® spray holes
- 6" Square spray face
- 5-1/8" Showerhead length
- WaterSense® certified: 2.0 gpm @ 80 psi



Part #	Mfg #	Description	Price
163619	RP70171	Chrome	
174558	RP70171-RB	Venetian Bronze®	
155716	RP70171-SS	Stainless*	

Foundations® Single-Setting Showerhead

- 2" Spray face diameter
- 2-7/8" showerhead length
- WaterSense® certified: 2.0 gpm @ 80 psi



Part #	Mfg #	Description	Price
152088	RP44809	Chrome	
188670	RP44809BN	Brushed Nickel	

Lahara 5" Touch-Clean® Raincan Showerhead

- Single-setting showerhead -Full body spray
- Touch-Clean® spray holes
- 5" Spray face across
- 2-3/4" Showerhead length
- Maximum flow: 2.5 gpm @ 80 psi



Part #	Mfg #	Finish	Price
114549	RP51305	Chrome	
160849	RP51305CZ	Champagne Bronze™	
112181	RP51305RB	Venetian Bronze®	
112023	RP51305SS	Stainless*	

Premium Touch-Clean® 3-Setting Showerhead

- Spray settings:
 - Full body
 - Massaging
 - Soft drench
- Touch-Clean® spray holes
- 4-7/8" Spray face diameter
- 4-3/4" Showerhead length
- WaterSense® certified: 2.0 gpm @ 80 psi



Part #	Mfg #	Description	Price
117717	RP43381	Chrome	
168994	RP43381PB	Polished Brass*	
158034	RP43381SS	Stainless*	

Tesla™ Showerhead

- 3-Setting H2OKinetic® showerhead
 - Full body
 - H2OKinetic®
 - Pause
- Self-cleaning H2OKinetic® spray holes
- 7-1/2" Spray face diameter
- 3-1/2" Showerhead length
- Watersense® certified: 2.0 gpm @ 80 psi



Part #	Mfg #	Description	Price
189179	52690	Chrome	
188815	52690-RB	Venetian Bronze®	
181311	52690-SS	Stainless*	

Universal Showerhead

- Single-setting showerhead -Full body spray
- 6" Spray face diameter
- 2-3/4" Showerhead length
- WaterSense® certified: 2.0 gpm @ 80 psi



Part #	Mfg #	Description	Price
160568	RP61181	Chrome	
149683	RP61181BN	Brushed Nickel*	
170235	RP61181OB	Oil-Rubbed Bronze	

* Brilliance® Anti-Tarnish Lifetime Finishes

www.waterconcepts.net • Serving our Customers Since 1946 • www.plumbsupply.com

Shower Heads, Arms & Flanges

Fundamentals™ 2-Setting Showerhead

- Spray settings:
-Pause
-Full body spray
- 3" Showerhead length
- 1-5/8" Spray face diameter
- Maximum flow: 2.0 gpm @ 80 psi



Part #	Mfg #	Finish	Price
108614	52650-PK	Chrome	

Fundamentals™ 2-Setting Showerhead 1"

- Spray settings:
-Pause
-Full body spray
- Brass construction
- 2-1/2" Showerhead length
- 1" Spray face diameter
- Maximum flow: 2.5 gpm @ 80 psi



Part #	Mfg #	Finish	Price
108613	52652-PK	Chrome	

Fundamentals™ Single-Setting Showerhead

- Full body spray
- 1" Spray face diameter
- 2" Showerhead length
- Brass construction
- Maximum flow: 2.5 gpm @ 80 psi



Part #	Mfg #	Description	Price
159913	52654-PK	Chrome	

Fundamentals™ Water-Efficient Showerhead

- Single-setting showerhead
-High efficiency spray
- 2-1/4" Spray face diameter
- 3-3/4" Showerhead length
- WaterSense® certified: 1.5 gpm @ 80 psi



Part #	Mfg #	Finish	Price
120563	52653-PK	Chrome	

Fundamentals™ Touch-Clean® Showerhead

- Single-setting showerhead
-full spray
- 2-7/8" Spray face diameter
- 3-1/2" Showerhead length
- Features Touch-Clean® spray holes



Part #	Mfg #	Finish	Price
150654	52672-PK	2.5 gpm, Chrome	
147248	52672-WH-PK	2.5 gpm, White	
173545	52672-15-BG	1.5 gpm, Chrome	

Fundamentals™ 3-Setting Showerhead

- (3) Spray settings
-Full body spray
-Massage spray
-Crossing full spray
- 3" Spray face diameter
- 3-5/8" Showerhead length
- Maximum flow rate: 2.5 gpm @ 80 psi



Part #	Mfg #	Description	Price
152108	52675-WH-PK	White/Chrome	

Fundamentals™ 2-1/2" Showerhead

- Adjustable spray metal shower head
- 2-1/2" Spray face diameter
- 4-1/4" Showerhead length
- Six spray jets
- Maximum flow: 2.5 gpm @ 80 psi



Part #	Mfg #	Finish	Price
147523	52667-PK	Chrome	
155006	52667-SS-PK	Stainless*	

Universal Contemporary Water-Efficient Showerhead

- Self-cleaning H2OKinetic® spray holes
- 4" Spray face diameter
- 4-1/2" Showerhead length
- H2OKinetic® spray



Part #	Mfg #	Finish	Price
145621	52655	Chrome, 2.0gpm	
163658	52657	Chrome, 2.5gpm	

* Brilliance® Anti-Tarnish Lifetime Finishes

www.plumbsupply.com • Serving our Customers Since 1946 • www.waterconcepts.net

Shower Heads, Arms & Flanges

Faucets & Valves

Fundamentals™ 4-Setting Showerhead

- Spray settings:
 - Pause
 - Full body spray
 - Full spray w/ massage
 - Fast massage
- Touch-Clean® spray holes
- MB = metal ball
- 3" Spray face diameter
- 3-3/4" Showerhead length
- 2.5gpm @ 80psi



Part #	Mfg #	Finish	Price
147349	52102-MB	Chrome	

Fundamentals™ 3" Showerhead

- Four-setting showerhead:
 - Full body spray
 - Massage spray
 - Crossing full spray
 - Crossing full spray w/ massage
- 3" Spray face diameter
- 3-7/8" Showerhead length
- 2.5 gpm @ 80 psi
- (-20 Models 2.0 gpm @ 80 psi)



Part #	Mfg #	Finish	Price
001256	52665-PK	Chrome	
190011	52665-20-PK	Chrome	

Fundamentals™ 3" Touch-Clean® Showerhead

- Single-setting showerhead
 - Full body spa
- Features Touch-Clean® spray holes
- 3" Spray face diameter
- 2-13/4" Showerhead length
- WaterSense® certified: 2.0 gpm @ 80 psi



Part #	Mfg #	Finish	Price
117963	RP43164	Chrome	
114140	RP4316RB	Venetian Bronze®	
105055	RP43164SS	Stainless*	

Universal 3-1/2" Touch-Clean® Showerhead (2)

- Five-setting showerhead
 - Pause
 - Full body spray
 - Full body spray w/ massage
 - Fast massage
 - Soft drench spray
- Features Touch-Clean® spray holes
- 3-3/4" Spray face diameter
- 4-1/4" Showerhead length
- Maximum flow: 2.5 gpm @ 80 psi



Part #	Mfg #	Finish	Price
166822	52678-PK	Chrome	
164046	52678-PB-PK	Polished Brass*	
147521	52678-RB-PK	Venetian Bronze®	
163079	52678-SS-PK	Stainless*	

7-Setting Showerhead

- Settings include:
 - Full body
 - Fast massage
 - Full spray w/ massage
 - Shampoo rinsing
 - Soft drench
 - Soft drench w/ full
 - Pause



Part #	Mfg #	Description	Price
222779	52626-PB-PK	Polished Brass*	

Universal 3-3/8" Touch-Clean® Showerhead

- Five-setting showerhead
 - Pause
 - Full body spray
 - full spray w/ massage
 - Fast massage
 - High-efficiency spray
- Features Touch-Clean® spray holes
- 3-3/8" Spray face diameter
- 3-3/4" Showerhead length
- WaterSense® certified: 2.0 gpm @ 60 psi



Part #	Mfg #	Finish	Price
143426	52634-20-PK	Chrome	
147522	52634SS-20-PK	Stainless*	

* Brilliance® Anti-Tarnish Lifetime Finishes

www.waterconcepts.net • Serving our Customers Since 1946 • www.plumbsupply.com

Shower Heads, Arms & Flanges

Universal Touch-Clean® Showerhead

- Five-setting showerhead
 - Pause
 - Full body spray
 - Full spray w/ massage
 - H2Okinetic® spray
 - Massage spray
- 4-1/8" Spray face diameter
- 5-1/4" Showerhead length
- Self-cleaning H2Okinetic® spray holes
- WaterSense® certified: 2.0 gpm @ 80 psi



Part #	Mfg #	Description	Price
185819	52637-15-PK	Chrome, 1.5 gpm	
173469	52637-20-PK	Chrome	
173387	52637-CZ20-PK	Champagne Bronze™	
172828	52637-PN20-PK	Polished Nickel*	
178008	52637-RB20-PK	Venetian Bronze®	
171305	52637-SS20-PK	Stainless*	

Universal 5-Setting Showerhead

- Five spray patterns
 - Full body spray
 - Full spray with massage
 - Massaging spray
 - Drenching spray
 - Soft drench with full spray
- WaterSense® certified: 2.0 gpm



Part #	Mfg #	Description	Price
228466	52636-SS-PK	Stainless*	

Universal 5-Setting Contemporary Showerhead

- Five spray patterns
 - Pause
 - Full body spray
 - Full spray w/ massage
 - H2Okinetic® spray
 - Massage spray
- Touch-Clean® spray holes
- Self-cleaning H2Okinetic® spray holes
- H2Okinetic® showerhead
- 4-3/16" Spray face diameter
- 3-1/4" Showerhead length
- WaterSense® certified



Part #	Mfg #	Description	Price
174044	52638-15-PK	Chrome, 1.5 gpm	
187829	52638-RB20-PK	Venetian Bronze, 2.0 gpm	

5-Setting Showerhead

- Spray settings:
 - Full body
 - Fast massage
 - Full spray with massage
 - Soft drench
 - Pause
- 4-15/16" Diameter
- 3-11/16" Showerhead length
- Touch-Clean® spray holes
- WaterSense® certified: 2.0gpm @ 80psi



Part #	Mfg #	Description	Price
163625	75554	Chrome	

5-Setting Showerhead

- Touch-Clean® spray holes
- Flow rate: 2.0 gpm @ 80 psi



Part #	Mfg #	Description	Price
223737	RP78575	Chrome	
228076	RP78575SS	Stainless*	

Fundamentals™ 3-5/16" Touch-Clean® Showerhead

- Single-setting showerhead
 - Full body spray
- 3-5/16" Spray face diameter
- 2-13/16" Showerhead length
- Coordinates with Leland® and Lahara®
- WaterSense® certified: 2.5 gpm @ 80 psi



Part #	Mfg #	Finish	Price
084340	RP41589	Chrome	
100253	RP41589RB	Venetian Bronze®	
117475	RP41589SS	Stainless*	

* Brilliance® Anti-Tarnish Lifetime Finishes

www.plumbsupply.com • Serving our Customers Since 1946 • www.waterconcepts.net

Shower Heads, Arms & Flanges

Faucets & Valves

Universal 4-1/2" Touch-Clean® 3-Function Showerhead



- Spray settings:
-Full body spray
-Massage spray
-Soft drench spray
- Features Touch-Clean® spray holes
- 4-1/2" Spray face diameter
- 4" Showerhead length
- Maximum flow: 2.5 gpm @ 80 psi

Part #	Mfg #	Finish	Price
112551	RP48590	Chrome	
113409	RP48590SS	Stainless*	

Universal Water-Efficient H2Okinetic® Showerhead



- Single-setting showerhead
-H2Okinetic® spray
- Self-cleaning H2Okinetic® spray holes
- 3-1/4" Spray face diameter
- 4-3/4" Showerhead length
- WaterSense® certified: 1.5 gpm @ 80 psi

Part #	Mfg #	Finish	Price
117776	RP46384	Chrome	
139671	RP46384SS	Stainless*	

Universal Traditional Water-Efficient Showerhead



- Single-setting H2Okinetic® showerhead
-H2Okinetic® spray
- Self-cleaning H2Okinetic® spray holes
- 3-7/8" Diameter spray face
- 4-1/2" Showerhead length
- WaterSense® certified: 1.5 gpm @ 80 psi

Part #	Mfg #	Finish	Price
128826	RP54752	Chrome	
130320	RP54752RB	Venetian Bronze®	
130319	RP54752SS	Stainless*	

Universal Traditional Water-Efficient Showerhead



- Single-setting H2Okinetic® showerhead
-H2Okinetic® spray
- Self-cleaning H2Okinetic® spray holes
- 3-7/8" Spray face diameter
- 4-1/2" Showerhead length
- WaterSense® certified

Part #	Mfg #	Description	Price
173544	52658-PK	Chrome, 1.5 gpm	
147737	52658-SS-PK	Stainless*, 1.5 gpm	

Showerheads (Continued)

Universal Traditional Water-Efficient Showerhead

Part #	Mfg #	Description	Price
147736	52659-PK	Chrome, 2.0 gpm	
151946	52659-SS-PK	Stainless*, 2.0 gpm	
163114	52660-PK	Chrome, Adj 2.0 to 1.5 gpm	
147738	52660-RB-PK	Venetian Bronze®, Adj 2.0 to 1.5 gpm	
147559	52660-SS-PK	Stainless*, Adj 2.0 to 1.5 gpm	

Universal Single-Setting Showerhead

- Full body spray
- 2.5 gpm @ 80 psi



Part #	Mfg #	Description	Price
125954	52140-VP-PK	Chrome, 2.5 gpm	

Universal Square H2Okinetic® Showerhead

- Single-setting showerhead
-H2Okinetic® spray
- 4" Square spray face
- 2-1/2" Showerhead length
- Self-cleaning H2Okinetic® spray holes
- WaterSense® certified: 1.5 gpm @ 80 psi



Part #	Mfg #	Finish	Price
131941	RP51032	Chrome	
131228	RP51032RB	Venetian Bronze®	
137129	RP51032SS	Stainless*	

Universal Round H2Okinetic® Showerhead

- Single-setting showerhead
-H2Okinetic® spray
- Self-cleaning H2Okinetic® spray holes
- 5-1/2" Spray face diameter
- 2-5/8" Showerhead length
- WaterSense® certified: 2.0 gpm @ 80 psi



Part #	Mfg #	Description	Price
163621	RP70175	Chrome	
180015	RP70175-RB	Venetian Bronze®	
165425	RP70175-SS	Stainless*	

* Brilliance® Anti-Tarnish Lifetime Finishes

www.waterconcepts.net • Serving our Customers Since 1946 • www.plumbsupply.com

Shower Heads, Arms & Flanges

Universal Contemporary Overhead Showerhead

- Single-setting showerhead
- Soft rain spray
- 8-1/2" Spray face diameter
- 3-7/8" Showerhead length
- Brass construction
- Maximum flow: 2.5 gpm @ 80 psi



Part #	Mfg #	Finish	Price
146289	52682	Chrome	
145270	52682-RB	Venetian Bronze®	
145213	52682-SS	Stainless*	

Universal Contemporary Overhead Raincan Showerhead

- Single-setting showerhead
- Soft rain spray
- 6" Spray face across
- 3-1/2" Showerhead length
- Brass construction
- Maximum flow: 2.5 gpm @ 80 psi



Part #	Mfg #	Finish	Price
124312	52689	Chrome	
158652	52689-RB	Venetian Bronze®	
148076	52689-SS	Stainless*	

Universal Contemporary Raincan Showerhead

- 3-Setting H2Okinetic® showerhead
- Pause
- Full body spray
- H2Okinetic® spray
- Self-cleaning H2Okinetic® spray holes
- 7-5/8" Spray face diameter
- 3-1/2" showerhead length
- WaterSense® certified: 2.0 gpm @ 80 psi



Part #	Mfg #	Description	Price
181493	52684	Chrome	
188377	52684-CZ	Champagne Bronze™	
169836	52684-RB	Venetian Bronze®	
171391	52684-SS	Stainless*	

Universal Raincan Showerhead

- Three-setting showerhead
- Full body spray
- Full spray w/ massage
- Massaging spray
- Touch-Clean® spray holes
- 8" Spray face diameter
- Maximum flow: 2.5 gpm @ 80 psi



Part #	Mfg #	Description	Price
173180	75353	Chrome	

Universal Traditional Raincan Showerhead

- 3-Setting H2Okinetic® showerhead
- Pause
- Full body spray
- H2Okinetic® spray
- 8-1/4" Spray face diameter
- 3-7/8" Showerhead length
- Touch-Clean® spray holes
- Self-cleaning H2Okinetic® spray holes
- WaterSense® certified: 2.0 gpm @ 80 psi



Part #	Mfg #	Description	Price
170470	52687	Chrome	
178258	52687-PN	Polished Nickel*	
170017	52687-RB	Venetian Bronze®	
175919	52687-SS	Stainless*	

Universal Transitional Raincan Showerhead Round

- 3-Setting H2Okinetic® showerhead
- Pause
- Full body spray
- H2Okinetic® spray
- 7-3/4" Spray face diameter
- 3-1/2" Showerhead length
- Touch-Clean® spray holes
- Self-cleaning H2Okinetic® spray holes
- WaterSense® certified: 2.0 gpm @ 80 psi



Part #	Mfg #	Description	Price
169876	52688	Chrome	
226889	52688-CZ	Champagne Bronze™	
184225	52688-RB	Venetian Bronze®	
172761	52688-SS	Stainless*	

Faucets & Valves

* Brilliance® Anti-Tarnish Lifetime Finishes

www.plumbsupply.com • Serving our Customers Since 1946 • www.waterconcepts.net

Shower Heads, Arms & Flanges

Faucets & Valves

Universal Transitional Raincan Showerhead Square

- 3-Setting H2Okinetic® showerhead
-Pause
-Full body spray
-H2Okinetic® spray
- Touch-Clean® spray holes
- Self-cleaning H2Okinetic® spray holes
- 7-3/4" Spray face diameter
- 3-3/8" Showerhead length
- WaterSense® certified: 2.0 gpm @ 80 psi



Part #	Mfg #	Description	Price
175793	52686	Chrome	
172582	52686-RB	Venetian Bronze®	
174315	52686-SS	Stainless*	

Universal 8" Touch-Clean® Raincan Showerhead

- 3-Setting showerhead
-Full body spray
-Full spray w/ massage
-Massage spray
- Touch-Clean® spray holes
- 8" Spray face diameter
- 4-3/4" Showerhead length
- Maximum flow: 2.5 gpm @ 80 psi



Part #	Mfg #	Finish	Price
151177	52680	Chrome	
183589	52680-CZ	Champagne Bronze™	
148039	52680-RB	Venetian Bronze®	
147540	52680-SS	Stainless*	

Universal Traditional Raincan Showerhead

- Single-setting showerhead
-full body spray
- 9-3/8" Spray face diameter
- 4-1/2" Shower head length
- Touch-clean® spray holes
- Maximum flow: 2.5 gpm @ 80 psi



Part #	Mfg #	Description	Price
155251	RP72568	Chrome	
156707	RP72568-CZ	Champagne Bronze™	
172169	RP72568-PN	Polished Nickel*	
151100	RP72568-RB	Venetian Bronze®	
150789	RP72568-SS	Stainless*	

Universal 7-1/2" Touch-Clean® Raincan Showerhead

- Single-setting showerhead
-Full body spray
- 7-1/2" Spray face diameter
- 2-3/4" Showerhead length
- WaterSense® certified:
2.5 gpm @ 80 psi



Part #	Mfg #	Finish	Price
109355	RP48686	Chrome	
154521	RP48686CZ	Champagne Bronze™	
107087	RP48686PB	Polished Brass*	
105330	RP48686RB	Venetian Bronze®	
109353	RP48686SS	Stainless*	

Universal 8-3/4" Touch-Clean® Raincan Showerhead

- Single-setting showerhead
-Full body spray
- Touch-Clean® spray holes
- 8-3/4" Spray face diameter
- 2" Showerhead length
- Maximum flow: 2.5 gpm @ 80 psi



Part #	Mfg #	Finish	Price
121164	RP52382	Chrome	
140160	RP52382PB	Polished Brass*	
117370	RP52382RB	Venetian Bronze®	
117613	RP52382SS	Stainless*	

Universal 5-7/8" Touch-Clean® Raincan Showerhead

- Single-setting showerhead
-Full body spray
- Touch-Clean® spray holes
- 5-7/8" Spray face diameter
- 2-1/2" Showerhead length
- Maximum flow: 2.5 gpm @ 80 psi



Part #	Mfg #	Finish	Price
089200	RP42578	Chrome	
088759	RP42578SS	Stainless*	

* Brilliance® Anti-Tarnish Lifetime Finishes

www.waterconcepts.net • Serving our Customers Since 1946 • www.plumbsupply.com

Shower Heads, Arms & Flanges

Universal 5" Touch-Clean® 5-Setting Showerhead

- Spray settings
 - Pause
 - Full body spray
 - Full spray w/ massage
 - Massage spray
 - Soft-drench spray
- Touch-Clean® spray holes
- 5" Spray face diameter
- 3" Showerhead length
- Maximum flow: 2.5 gpm @ 80 psi



Part #	Mfg #	Finish	Price
146612	52683	Chrome	
148075	52683-SS	Stainless*	

Universal Traditional Single-Setting Showerhead

- H2Okinetic® technology
H2Okinetic® spray
- Self-cleaning H2Okinetic®
spray holes
- 8" Spray face diameter
- 3-1/3" Showerhead length
- WaterSense® certified: 2.0gpm @80 psi



Part #	Mfg #	Description	Price
170650	RP70172	Chrome	
173184	RP70172-CZ	Champagne Bronze™	
154081	RP70172-RB	Venetian Bronze®	

Universal Transitional Single-Setting Showerhead

- H2Okinetic® showerhead
-H2Okinetic spray
- Self-cleaning H2Okinetic®
spray holes
- 6-1/2" Spray face diameter
- 3" Showerhead length
- WaterSense® certified: 2.0 gpm @ 80 psi



Part #	Mfg #	Description	Price
148532	RP70173	Chrome	
145829	RP70173-CZ	Champagne Bronze™	
166960	RP70173-RB	Venetian Bronze®	
160299	RP70173-SS	Stainless*	

Universal Raincan Showerhead

- Single-setting showerhead
-Full body spray
- 6" spray face diameter
- 12" adjustable shower arm
- Adjustable up and down 18"
- Showerhead swivels 180°
- Maximum flow: 2.5 gpm @ 80 psi



Part #	Mfg #	Description	Price
153412	52687-PK	Chrome	

Verotm 8-5/8" Touch-Clean® Raincan Showerhead

- Single-setting showerhead
-Full body spray
- Touch-Clean® spray holes
- Showerhead is 8-5/8" across
- 5-11/16" Showerhead length
- Maximum flow: 2.5 gpm @ 80 psi



Part #	Mfg #	Finish	Price
136167	RP62955	Chrome	
170128	RP62955CZ	Champagne Bronze™	
145211	RP62955RB	Venetian Bronze®	
135608	RP62955SS	Stainless*	

Victorian® Touch-Clean® 3-Function Showerhead

- Three-setting showerhead
-Full body spray
-Massage spray
-Soft drench spray
- Touch-Clean® spray holes
- 5-1/2" Spray face diameter
- 4-5/16" Showerhead length
- Maximum flow: 2.5 gpm @ 80 psi



Part #	Mfg #	Finish	Price
058976	RP34355	Chrome	
144582	RP34355-CZ	Champagne Bronze™	
071162	RP34355-RB	Venetian Bronze®	
097715	RP34355-SS	Stainless*	

Faucets & Valves

* Brilliance® Anti-Tarnish Lifetime Finishes

www.plumbsupply.com • Serving our Customers Since 1946 • www.waterconcepts.net

Shower Heads, Arms & Flanges

Faucets & Valves

Temp20® Showerheads

LED digital temperature display, powered by (3) AAA batteries (included) with an estimated two-year battery life

Temp20® Showerhead

- Six-setting showerhead:
 - Full Body spray
 - Full Spray w/ massage
 - Massaging
 - Shampoo Rinsing
 - Shampoo Rinsing w/ massage
 - Soft drench spray
- 4-3/4" Spray face diameter
- 5-1/4" Showerhead length
- Touch-Clean® spray holes
- WaterSense® certified: 2.0 gpm @ 80 psi



Part #	Mfg #	Description	Price
182498	52646-RB-PK	Venetian Bronze®	
177448	52646-SS-PK	Stainless*	

Integrated Showers

ActivTouch Handshower/Showerhead Combo Pack

- Rubber spray holes
- Spray settings:
 - Full body
 - Fast massage
 - Full spray with massage
 - Shampoo rinsing
 - Shampoo rinsing with massage
 - Soft drench
 - Soft drench with massage
 - Soft full
 - Pause
- 60"-82" Hose
- Flow rate: 2.50 gpm @ 80 psi
- (58968) Flow rate: 2.0 gpm @ 80 psi



Part #	Mfg #	Description	Price
188119	58967-PK	Chrome	
185729	58967-SS-PK	Stainless*	
223601	58968-SS-PK	Stainless*	

Classic In2ition® Two-In-One Showerhead

- Integrated showerhead and handshower
- Plated showerhead shell
- 60" to 82" Stretchable metal hose
- 2.5 gpm @ 80 psi
- Showerarm and flange not included
- 5-Setting handshower:
 - Pause
 - Aerated spray
 - Fast massage
 - Full spray with massage
 - Full body spray



Part #	Mfg #	Finish	Price
145689	58466-BC	Brushed Chrome	
146644	58466-SS	Stainless*	

Classic In2ition® Two-In-One Showerhead (2)

- Integrated showerhead and handshower
- 2.5 gpm @ 80 psi
- (4) Spray settings
- 60" to 82" Stretchable metal hose
- Showerarm and flange NOT included



Part #	Mfg #	Finish	Price
146094	58467	Chrome	
122327	58467-SS	Stainless*	

In2ition® Two-In-One Showerhead

- Integrated handshower docks securely into showerhead when not in use
- (4) Spray settings and pause
- 6' Tangle-free hose
- 2.5 gpm @ 80 psi



Part #	Mfg #	Finish	Price
134022	58065	Chrome	
135612	58065-RB	Venetian Bronze®	
134023	58065-SS	Stainless*	

* Brilliance® Anti-Tarnish Lifetime Finishes

www.waterconcepts.net • Serving our Customers Since 1946 • www.plumbsupply.com

Shower Heads, Arms & Flanges

In2ition® Two-In-One Shower (2)

- Integrated showerhead and handshower
- Plated showerhead shell
- 60" to 82" Stretchable metal hose
- 2.5 gpm @ 80 psi
- Showerarm and flange not included
- 5-Setting handshower:
 - Pause
 - Slow massage
 - Fast massage
 - Full spray with massage
 - Full body spray



Part #	Mfg #	Finish	Price
118539	58468	Chrome	

In2ition® Two-In-One Square Showerhead

- Integrated H2Okinetic® showerhead and handshower
- 60" to 82" Stretchable metal hose
- 2.5 gpm @ 80 psi
- 2.0 gpm (58473)
- Showerarm and flange not included
- 4-Setting handshower:
 - Pause
 - H2Okinetic® spray
 - Massage spray
 - H2Okinetic® with massage spray
- MagnaTite® docking



Part #	Mfg #	Description	Price
161135	58470-CZ	Champagne Bronze™	
158838	58470-RB	Venetian Bronze®	
224660	58473	2.0gpm, Chrome	
224659	58473-SS	2.0gpm, Stainless*	

In2ition® Contemporary Two-In-One Showerhead

- Integrated handshower
- 60" - 82" Stretchable metal hose
- Shower arm mount
- Shower arm and flange sold separately
- MagnaTite® docking
- 2.5 gpm @ 80 psi
- 4-Setting handshower:
 - Pause
 - H2Okinetic® spray
 - Massage spray
 - H2Okinetic® w/ massage spray



Part #	Mfg #	Description	Price
155321	58472	Chrome	
169568	58472-RB	Venetian Bronze®	
159008	58472-SS	Stainless*	

In2ition® Traditional Two-In-One Showerhead

- Integrated handshower docks securely into showerhead when not in use
- 60" to 82" Stretchable metal hose
- 2.5 gpm @ 80 psi
- Showerarm and flange not included
- Change spray modes with push button
- 4-Setting handshower:
 - Pause
 - Massage spray
 - H2Okinetic™ spray
 - H2Okinetic™ spray w/ massage



Part #	Mfg #	Description	Price
153400	58471-PK	Chrome	
165488	58471-CZ-PK	Champagne Bronze™	
171598	58471-PN-PK	Polished Nickel*	
152495	58471-RB-PK	Venetian Bronze®	
151569	58471-SS-PK	Stainless*	

Faucets & Valves

* Brilliance® Anti-Tarnish Lifetime Finishes

www.plumbsupply.com • Serving our Customers Since 1946 • www.waterconcepts.net

Shower Heads, Arms & Flanges

Faucets & Valves

In2ition® 4-Setting Two-In-One Showerhead

- Diverter lever sets:
Shower head and hand shower
Shower head only
Hand shower only
- Pause feature
- Touch-Clean® spray holes
- Spray settings:
-Full Body
-Fast Massage
-Full Spray with Massage
- Includes 72 in. hose
- WaterSense® certified: 2.0 gp, @ 80 psi



Part #	Mfg #	Description	Price
190444	58465-PK	Chrome	

In2ition® Two-In-One 5-Setting Showerhead

- Five spray settings:
-Full Body
-Fast Massage
-Full Spray with Massage
-Slow Massage
-Pause
- 82" Hose
- Touch-Clean® spray holes
- WaterSense® Certified: 2.0 gpm



Part #	Mfg #	Description	Price
189580	58569-PK	Chrome	
190357	58569-RB-PK	Venetian Bronze®	
190417	58569-CZ-PK	Champagne Bronze™	
190132	58569-SS-PK	Stainless*	

In2ition® Two-In-One 5-Setting Showerhead

- Five spray settings:
-Full Body
-Fast Massage
-Full Spray with Massage
-Slow Massage
-Pause
- 82" Hose
- Touch-Clean® spray holes
- WaterSense® Certified: 2.0 gpm



Part #	Mfg #	Description	Price
189934	58066	Chrome	
190473	58066-RB	Venetian Bronze®	
189679	58066-SS	Stainless*	

H2Okinetic® In2ition® Two-in-One Showerhead

- Integrated handshower docks securely into showerhead when not in use
- Touch-Clean® nozzles
- 60" to 82" Stretchable metal hose
- 2.0 gpm @ 80 psi
- Showerarm and flange not included
- 5-Spray setting handshower



Part #	Mfg #	Description	Price
176161	58480-PK	Chrome	
189132	58480-CZ-PK	Champagne Bronze™	
188927	58480-PN-PK	Polished Nickel*	
175914	58480-RB-PK	Venetian Bronze®	
175158	58480-SS-PK	Stainless*	

Showerarms & Flanges

Adjustable Showerarm



Part #	Mfg #	Description	Price
111132	UA902-PK	Chrome	

3" Ceiling-Mount Showerarm

- 1/2" IPS male threads
- 3" Long, 2-7/8" outside diameter
- Includes flange



Part #	Mfg #	Description	Price
149538	U4996	Chrome	
170129	U4996-CZ	Champagne Bronze™	
110274	U4996-RB	Venetian Bronze®	
145215	U4996-SS	Stainless*	

6" Ceiling Mount Showerarm and Flange

- 1/2" IPS Male threads
- 6" Long, 2-1/2" diameter
- Includes flange



Part #	Mfg #	Finish	Price
127429	RP61058	Chrome	
143043	RP61058CZ	Champagne Bronze™	
172167	RP61058PN	Polished Nickel*	
126907	RP61058RB	Venetian Bronze®	

* Brilliance® Anti-Tarnish Lifetime Finishes

www.waterconcepts.net • Serving our Customers Since 1946 • www.plumbsupply.com

Shower Heads, Arms & Flanges

Showerarms & Flanges (Continued)

6" Ceiling Mount Showerarm and Flange

Part #	Mfg #	Finish	Price
126996	RP61058SS	Stainless*	

9" Ceiling-Mount Showerarm and Flange

- 1/2" IPS male threads
- 9" Long, 2-7/8" outside diameter
- Includes flange



Part #	Mfg #	Description	Price
147351	U4999	Chrome	
172072	U4999-CZ	Champagne Bronze™	
091205	U4999-RB	Venetian Bronze®	
075690	U4999-SS	Stainless*	

5-1/2" Showerarm

- 1/2" IPS male threads



Part #	Mfg #	Finish	Price
003668	RP6023	Chrome	
171602	RP6023PN	Polished Nickel	
086749	RP6023RB	Venetian Bronze®	
099955	RP6023SS	Stainless*	

7" Showerarm

- 1/2" IPS male threads



Part #	Mfg #	Finish	Price
088072	RP40593	Chrome	
144583	RP40593CZ	Champagne Bronze™	
172826	RP40593PN	Polished Nickel*	
117371	RP40593RB	Venetian Bronze®	
089812	RP40593SS	Stainless*	

15" Curved Showerarm

- 1/2" IPS male threads



Part #	Mfg #	Finish	Price
131866	RP61273	Chrome	
137603	RP61273CZ	Champagne Bronze™	
178330	RP61273PN	Polished Nickel*	
127806	RP61273RB	Venetian Bronze®	

Showerarms & Flanges (Continued)

15" Curved Showerarm

Part #	Mfg #	Finish	Price
130467	RP61273SS	Stainless*	

16" Showerarm

- 1/2" IPS Male threads



Part #	Mfg #	Finish	Price
115430	RP46870	Chrome	
144636	RP46870RB	Venetian Bronze®	
112142	RP46870SS	Stainless*	

13" to 22" Extendable Showerarm

- Brass construction
- 1/2" IPS male threads
- Extends 13"-22" for overhead showering



Part #	Mfg #	Description	Price
155250	U6930	Chrome	
094365	U6930-RB	Venetian Bronze®	
147591	U6930-SS	Stainless*	

6" Showerarm & Flange

- 1/2" IPS Male threads
- 6" Long, 2-3/8" outside diameter
- Includes flange



Part #	Mfg #	Finish	Price
022374	U4993-PK	Chrome	
175378	U4993-CZ	Champagne Bronze™	
168996	U4993-PB	Polished Brass*	
146054	U4993-RB	Venetian Bronze®	
113876	U4993-SS	Stainless*	

2-1/2" OD Showerarm and Flange

- 1/2" IPS Male threads
- 5-1/2" Long, 2-1/2" outside diameter
- Includes flange



Part #	Mfg #	Description	Price
067926	RP31554	Chrome	

* Brilliance® Anti-Tarnish Lifetime Finishes

www.plumbsupply.com • Serving our Customers Since 1946 • www.waterconcepts.net

Shower Heads, Arms & Flanges

Faucets & Valves

Cassidy™ Shower Flange

- 2-3/8" Outside diameter



Part #	Mfg #	Description	Price
168313	RP72562CZ	Champagne Bronze™	
172827	RP72562PN	Polished Nickel*	
154170	RP72562RB	Venetian Bronze®	
156482	RP72562SS	Stainless*	

Dryden™ 2" Shower Flange

- 2" Outside diameter



Part #	Mfg #	Description	Price
129505	RP52144	Chrome	
165864	RP52144CZ	Champagne Bronze™	
121754	RP52144RB	Venetian Bronze®	
127034	RP52144SS	Stainless*	

2-1/2" Shower Flange

- 2-1/2" Outside diameter



Part #	Mfg #	Finish	Price
003670	RP6025	Chrome	
144584	RP6025CZ	Champagne Bronze™	
145301	RP6025OB	Oil Rubbed Bronze	
113918	RP6025RB	Venetian Bronze®	
099957	RP6025SS	Stainless*	

Vero® 2" Shower Flange

- 2" Outside diameter



Part #	Mfg #	Description	Price
138702	RP51034	Chrome	
179912	RP51034CZ	Champagne Bronze	
148040	RP51034RB	Venetian Bronze®	
159416	RP51034SS	Stainless*	

Shower Flange-Beveled Edge

- 2-1/2" Outside diameter



Part #	Mfg #	Description	Price
096659	RP38452	Chrome	
153502	RP38452RB	Venetian Bronze®	
088886	RP38452SS	Stainless*	

Victorian® Shower Flange

- 3" Outside diameter



Part #	Mfg #	Description	Price
060355	RP34356	Chrome	
154520	RP34356CZ	Champagne Bronze™	
171601	RP34356PN	Polished Nickel*	
085173	RP34356RB	Venetian Bronze®	
115147	RP34356SS	Stainless*	

Arzo® Shower Flange

- 2" Square



Part #	Mfg #	Description	Price
112143	RP46872SS	Stainless*	

* Brilliance® Anti-Tarnish Lifetime Finishes

www.waterconcepts.net • Serving our Customers Since 1946 • www.plumbsupply.com

Shower Heads, Arms & Flanges

Plumbing Specialties

Shower Arm

- Chrome plated brass
- 1/2" IPS - Heavy wall thickness



Part #	Mfg #	Size	Finish	Price
008029	1186	8"	Chrome	

Shower Arm Flange



Part #	Mfg #	Flange Style	Finish	Price
008030	1187	Set Screw	CP Die Cast	

Shower Heads, Arms & Flanges

Faucets & Valves

**Lav/Sink/Tub
S-Type Shower Arm**

- Easier shower arm installations
- Wrench locks into shower arm for secure, no slip installation
- Allows shower arm installation with no external damage



Part #	Mfg #	Conn.	Rise	Finish	Price
052512	974-60315	1/2" MIP	10"	Chrome Plated	

Shower Heads, Arms & Flanges

Showerarms

Chrome-Plated Brass Showerarm



Part #	Mfg #	Description	Price
086102	S01-030	6" Arm Only	

S Shaped Shower Arms

- 18"
- S- Shaped



Part #	Mfg #	Description	Price
169985	S0155WB	18" S Shaped Shower Arm	

90 Degree Shower Arm

- 18" Length
- 1/2" Female threads
- fixed escutchion



Part #	Mfg #	Description	Price
166066	S0156WB	18" 90Degree Shower Arm	

Double Offset Showerarm

- 18" Length
- 1/2" Female threads
- Adds 12" to height



Part #	Mfg #	Description	Price
150900	S01058	18" Double Offset Shower Arm	
155786	S0158BN	18" Double Offset Shower Arm	

Showerarm Flanges

Chrome-Plated Shower Flange

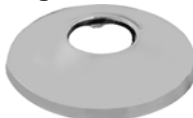

Part #	Mfg #	Description	Price
084304	S01-040	2-1/2" OD with Set Screw	

Shower Heads, Arms & Flanges

Commercial Flanges

**Commercial Cast Brass Flange
with Set Screw**

- -1 Polished chrome



Part #	Mfg #	Size	Price
128893	1119D-1	5/8" OD	



Shower Heads, Arms & Flanges

Shower Supplies

45° Shower Arms

- All Brass Full-wight
- 1/2" IPS x 10"



Part #	Mfg #	Finish	Price
169194	8033-ORB	Oil-Rubbed Bronze	
124597	8033-PCH	Polished Chrome	
126024	8033-SN	Satin Nickel	

8" 90° Shower Arms

- 2" Drop on 90° Bend
- Ideal for Rainheads



Part #	Mfg #	Finish	Price
140261	8040-PEW	Pewter	
166811	8040-SN	Satin Nickel	

30" 90° Shower Arms

- 2" Drop on 90° Bend
- Ideal for Rainheads
- Long Sweep Pattern with Escutcheon



Part #	Mfg #	Finish	Price
173639	8048-PCH	Polished Chrome	

Shower Nipples

- Available in various lengths
- All Brass vertical drop
- 1/2" 801-12
- 3/4" 801-34



Part #	Mfg #	Finish	Price
140813	801-12.24-ORB	1/2"x4" Oil-Rubbed Bronze	
153420	801-12.4-PB	1/2x4" Polished Brass	
120581	801-12.4-PEW	1/2"x4" Pewter	
123368	801-12.4-SN	1/2"x4" Sain Nickel	
133151	801-12.6-ORB	1/2"x6" Oil-Rubbed Bronze	
118565	801-12.6-PEW	1/2"x6" Pewter	
156841	801-12.6-SC	1/2"x6" Satin Chrome	
122350	801-12.6-SN	1/2"x6" Satin Nickel	
145342	801-12.12-ORB	1/2"x12" Oil-Rubbed Bronze	
154544	801-12.12-PCH	1/2"x12" Polished Chrome	
119810	801-12.12-SN	1/2x12" Satin Nickel	
122123	801-12.18-BU	1/2"x18" Bronze Umber	
162160	801-12.18-ORB	1/2"x18" Oil-Rubbed Bronze	
114198	801-12.18-PCH	1/2"x18" Polished Chrome	

Shower Supplies (Continued)

Shower Nipples

Part #	Mfg #	Finish	Price
148516	801-12.24-ORB	1/2"x24" Oil-Rubbed Bronze	
152476	801-12.24-PCH	1/2"x24" Polished Chrome	
171951	801-12.24-SN	1/2"x24" Satin Nickel	
155623	801-34.12-SN	3/4"x12" Satin Nickel	

Support Rods

- Use with 7982 L-Bar with insert
- Can also be used to support long shower arms



Part #	Mfg #	Finish	Price
166889	4012-SN	12" Satin Nickel	
173640	4018-PCH	18" Polished Chrome	
151440	4024-SN	24" Satin Nickel	

Showerheads

Rain Machine® Rain Showerhead

- 8" Diameter
- 1/2" IPS adjustbale brass ball joint to adjust angle of showerhead



Part #	Mfg #	Finish	Price
167612	S208SN	8" Satin Nickel	

Shower Faucets

Faucets & Valves

Single-Handle Shower Trim

Archer® Rite-Temp® 1-Hdl Shower Trim

- Showerhead has MasterClean™ spray nozzles
- Wall-mount
- Flow rate: 2.5 gpm



Requires:

K-304/K-P304 Series Rite-Temp® Valves

or

K-2971-KS 3/4" Pressure-balancing Valve

Part #	Mfg #	Description	Handle(s)	Finish	Price
225906	K-TS11078-4-BN	Shower Trim Only	Lever	*Brushed Nickel	
225905	K-TS11078-4-CP	Shower Trim Only	Lever	Polished Chrome	
225907	K-TS11078-4E-BN	Shower Trim Only, 2.0 gpm	Lever	*Brushed Nickel	

Archer® Rite-Temp® 1-Hdl Shower Valve Trim

Requires:

K-304/K-P304 Series Rite-Temp® Valves

or

K-2971-KS 3/4" Pressure-balancing Valve



Part #	Mfg #	Description	Handle(s)	Finish	Price
166902	K-TS98763-4-BN	Shower Trim Only	ADA Lever	*Brushed Nickel	
232814	K-TS98763-4-CP	Shower Trim Only	ADA Lever	Polished Chrome	

Alteo® Rite-Temp® 1-Hdl Shower Trim

- Premium construction
- MasterClean™ spray nozzles
- Intended for use with Rite-Temp® or HiFlow Rite-Temp® valves
- Heavy-duty slip-fit clamp design and NPT threaded spout

Requires:

K-304/K-P304 Series Rite-Temp® Valves

or

K-2971-KS 3/4" Pressure-balancing Valve



Push-Button Diverter Trim Requires Valve: K-11748-K/KS

Without Push-Button Diverter

Part #	Mfg #	Description	Handle(s)	Finish	Price
225727	K-TS45106-4-CP	Shower Trim Only	ADA Lever	Polished Chrome	
225729	K-TS45106-4-BN	Shower Trim Only	ADA Lever	*Brushed Nickel	
225730	K-TS45106-4-2BZ	Shower Trim Only	ADA Lever	Oil Rubbed Brnze	
225733	K-TS45110-4-BN	Valve Trim Only	ADA Lever	*Brushed Nickel	
225732	K-TS45110-4-CP	Valve Trim Only	ADA Lever	Polished Chrome	
225734	K-TS45110-4-2BZ	Valve Trim Only	ADA Lever	Oil-Rubbed Brnze	

* Vibrant Limited Lifetime Warranty

www.waterconcepts.net • Serving our Customers Since 1946 • www.plumbsupply.com

Shower Faucets

With Push-Button Diverter

Part #	Mfg #	Description	Handle(s)	Finish	Price
144678	K-T45108-4-BN	Shower Trim Only, Pushbutton Diverter	ADA Lever	*Brushed Nickel	
147266	K-T45108-4-CP	Shower Trim Only, Pushbutton Diverter	ADA Lever	Polished Chrome	
160692	K-T45108-4-2BZ	Shower Trim Only, Pushbutton Diverter	ADA Lever	Oil-Rubbed Brnze	
225329	K-T45112-4-CP	Valve Trim Only, Pushbutton Diverter	ADA Lever	Polished Chrome	

Artifacts® Rite-Temp® 1-Hdl Valve Trim

- Metal construction
- Wall-mount



-4



-3M



-9M

Requires:

K-304/K-P304 Series Rite-Temp® Valves
or
K-2971-KS 3/4" Pressure-balancing Valve

Faucets & Valves

Part #	Mfg #	Description	Handle(s)	Finish	Price
232915	K-TS72767-3M-BV	Valve Trim Only	ADA Prong	*Brushed Bronze	
167568	K-TS72767-3M-CP	Valve Trim Only	ADA Prong	Polished Chrome	
190146	K-TS72767-3M-VNT	Valve Trim Only	ADA Prong	Vintage Nickel	
232459	K-TS72767-4-BN	Valve Trim Only	ADA Lever	*Brushed Nickel	
181399	K-TS72767-4-BV	Valve Trim Only	ADA Lever	*Brushed Bronze	
171941	K-TS72767-4-CP	Valve Trim Only	ADA Lever	Polished Chrome	
174118	K-TS72767-4-SN	Valve Trim Only	ADA Lever	*Polished Nickel	
180272	K-TS72767-4-2BZ	Valve Trim Only	ADA Lever	Oil-Rubbed Brnz	
165374	K-TS72767-9M-CP	Valve Trim Only	ADA Swing	Polished Chrome	
183090	K-TS72767-9M-BN	Valve Trim Only	ADA Swing	*Brushed Nickel	
165038	K-TS72767-9M-SN	Valve Trim Only	ADA Swing	*Polished Nickel	

Artifacts® Valve Trim with Push-Button Diverter

- Metal construction
- Front seal plate assembly



-4



-3M



-9M

Requires valve:

K-11748-K
or
K-11748-KS

Part #	Mfg #	Description	Handle(s)	Finish	Price
162101	K-T72768-3M-BN	Valve Trim Only, Push-Button Diverter	ADA Prong	*Brushed Nickel	
162831	K-T72768-3M-CP	Valve Trim Only, Push-Button Diverter	ADA Prong	Polished Chrome	
223894	K-T72768-3M-VNT	Valve Trim Only, Push-Button Diverter	ADA Prong	Vintage Nickel	
183091	K-T72768-4-BN	Valve Trim Only, Push-Button Diverter	ADA Lever	*Brushed Nickel	
225931	K-T72768-4-BV	Valve Trim Only, Push-Button Diverter	ADA Lever	*Brushed Bronze	
166446	K-T72768-4-CP	Valve Trim Only, Push-Button Diverter	ADA Lever	Polished Chrome	
173103	K-T72768-4-SN	Valve Trim Only, Push-Button Diverter	ADA Lever	*Polished Nickel	
168459	K-T72768-4-2BZ	Valve Trim Only, Push-Button Diverter Bronze	ADA Lever	Oil-Rubbed	

* Vibrant Limited Lifetime Warranty

www.plumbsupply.com • Serving our Customers Since 1946 • www.waterconcepts.net

Shower Faucets

Faucets & Valves

Single-Handle Shower Trim (Continued)

Artifacts® Rite-Temp® 1-Hdl Valve Trim

Artifacts® Valve Trim with Push-Button Diverter

Part #	Mfg #	Description	Handle(s)	Finish	Price
185564	K-T72768-9M-BN	Valve Trim Only, Push Button Diverter	ADA Lever	*Brushed Nickel	
176271	K-T72768-9M-CP	Valve Trim Only, Push-Button Diverter	ADA Swing Lever	Polished Chrome	
174462	K-T72768-9M-SN	Valve Trim Only, Push-Button Diverter	ADA Swing Lever	*Polished Nickel	
186474	K-T72768-9M-2BZ	Valve Trim Only, Push-Button Diverter Bronze	ADA Swing Lever	Oil-Rubbed	

Bancroft® Rite-Temp® Pressure-Balancing Shower Valve Trim

- MasterClean™ sprayface
- Includes showerarm with flange
- 2.5 gpm single-function Katalyst® showerhead
- (-P) Ceramic lever handle



Requires:

K-304/K-P304 Series Rite-Temp® Valves

or

K-2971-KS 3/4" Pressure-balancing Valve

Part #	Mfg #	Description	Handle(s)	Finish	Price
227735	K-TS10583-4-BN	Shower Valve Trim	ADA Lever	*Brushed Nickel	
120008	K-TS10583-4-BV	Shower Valve Trim	ADA Lever	*Brushed Bronze	
151323	K-TS10583-4-2BZ	Shower Valve Trim	ADA Lever	Oil-Rubbed Brnze	
089589	K-TS10583-4P-CP	Shower Valve Trim	ADA Ceramic Lever	Polished Chrome	
106164	K-TS10584-4-BN	Valve Trim Only	ADA Lever	*Brushed Nickel	
129027	K-TS10584-4-BV	Valve Trim Only	ADA Lever	*Brushed Bronze	
173349	K-TS10584-4-SN	Valve Trim Only	ADA Lever	*Polished Nickel	
163524	K-TS10584-4P-BN	Valve Trim Only	ADA Ceramic Lever	*Brushed Nickel	
093804	K-TS10584-4P-CP	Valve Trim Only	ADA Ceramic Lever	Polished Chrome	

Composed™ Rite-Temp® 1-Hdl Shower Trim

- Premium material construction with metal handles
- Includes face plate with handle
- Handle controls both on/off activation and temperature setting



Requires:

K-304/K-P304 Series Rite-Temp® Valves

or

K-2971-KS 3/4" Pressure-balancing Valve

Push-Button Diverter Trim Requires Valve: K-11748-K/KS

Part #	Mfg #	Description	Handle(s)	Finish	Price
225520	K-TS73115-4-CP	Valve Trim Only	ADA Lever	Polished Chrome	
224855	K-T73117-4-CP	Valve Trim Only, Push-Button Diverter	ADA Lever	Polished Chrome	

* Vibrant Limited Lifetime Warranty

www.waterconcepts.net • Serving our Customers Since 1946 • www.plumbsupply.com

Shower Faucets

Coralais® Rite Temp® 2.5 gpm 1-Hdl Shower Trim

- Metal construction
- Adjustable spray showerhead, arm and flange
- High temperature limit stop
- 4-7/8" Diverter spout with NPT or slip-fit connection



Requires:

K-304/K-P304 Series Rite-Temp® Valves

or

K-2971-KS 3/4" Pressure-balancing Valve

Part #	Mfg #	Description	Handle(s)	Finish	Price
053771	K-PS15611-4-CP	Shower Trim Only, P-Pk	ADA Lever	Polished Chrome	
225714	K-TS15611-4-CP	Shower Trim Only	ADA Lever	Polished Chrome	
225715	K-TS15611-4-G	Shower Trim Only	ADA Lever	Brushed Chrome	
225716	K-TS15611-4E-CP	Shower Trim Only, 2.0 gpm	ADA Lever	Polished Chrome	
225718	K-TS15621-4-CP	Valve Trim Only	ADA Lever	Polished Chrome	

Devonshire® Rite-Temp® 1-Hdl Shower Trim

- Metal construction
- Brass valve bodies
- Pressure-balancing mechanism of one-piece diaphragm cartridge
- Showerhead, arm and flange
- 5-1/4" Diverter spout



Requires:

K-304/K-P304 Series Rite-Temp® Valves

or

K-2971-KS 3/4" Pressure-balancing Valve

Part #	Mfg #	Description	Handle(s)	Finish	Price
225861	K-TS396-4-BN	Shower Trim Only, 2.5 gpm	ADA Lever	*Brushed Nickel	
225860	K-TS396-4-CP	Shower Trim Only, 2.5 gpm	ADA Lever	Polished Chrome	
225868	K-TS396-4-SN	Shower Trim Only, 2.5 gpm	ADA Lever	*Polished Nickel	
225865	K-TS396-4-2BZ	Shower Trim Only, 2.5 gpm Bronze	ADA Lever	Oil-Rubbed	
225869	K-TS396-4E-CP	Shower Trim Only, 2.0 gpm	ADA Lever	Polished Chrome	
225870	K-TS396-4E-2BZ	Shower Trim Only, 2.0 gpm	ADA Lever	Oil-Rubbed Bronze	
225872	K-TS397-4-BN	Valve Trim Only, 2.5 gpm	ADA Lever	*Brushed Nickel	
225873	K-TS397-4-BV	Valve Trim Only, 2.5 gpm	ADA Lever	*Brushed Bronze	
225871	K-TS397-4-CP	Valve Trim Only, 2.5 gpm	ADA Lever	Polished Chrome	
228503	K-TS397-4-PB	Valve Trim Only, 2.5 gpm	ADA Lever	*Polished Brass	
225874	K-TS397-4-SN	Valve Trim Only, 2.5 gpm	ADA Lever	*Polished Nickel	
146984	K-TS397-4-2BZ	Valve Trim Only, 2.5 gpm Bronze	ADA Lever	Oil Rubbed	

* Vibrant Limited Lifetime Warranty

www.plumbsupply.com • Serving our Customers Since 1946 • www.waterconcepts.net

Shower Faucets

Faucets & Valves

Fairfax® Rite-Temp® 1-Hdl Shower Valve Trim

- Metal construction
- Showerhead, arm and flange
- 4-7/8" Diverter spout, 1/2" IPS connection



Requires:

K-304/K-P304 Series Rite-Temp® Valves

or

K-2971-KS 3/4" Pressure-balancing Valve

Part #	Mfg #	Description	Handle(s)	Finish	Price
225928	K-TS12014-4-BN	Shower Trim Only, 2.5 gpm	ADA Lever	*Brushed Nickel	
225925	K-TS12014-4-CP	Shower Trim Only, 2.5 gpm	ADA Lever	Polished Chrome	
225929	K-TS12014-4-2BZ	Shower Trim Only, 2.5 gpm Bronze	ADA Lever	Oil-Rubbed	
225930	K-TS12014-4E-CP	Shower Trim Only, 2.0 gpm	ADA Lever	*Brushed Nickel	
225933	K-TS12021-4-BN	Valve Trim Only, 2.5 gpm	ADA Lever	*Brushed Nickel	
225932	K-TS12021-4-CP	Valve Trim Only, 2.5 gpm	ADA Lever	Polished Chrome	
225934	K-TS12021-4-2BZ	Valve Trim Only, 2.5 gpm Bronze	ADA Lever	Oil-Rubbed	

Finial® Rite-Temp® Pressure-Balancing 1-Hdl Shower Valve Trim

- Brass construction
- 2.5 gpm Showerhead

Requires:

K-304/K-P304 Series Rite-Temp® Valves

or

K-2971-KS 3/4" Pressure-balancing Valve



Part #	Mfg #	Description	Handle(s)	Finish	Price
080076	K-TS313-4M-AF	Shower Trim Only	ADA Lever	*French Gold	
060041	K-TS313-4M-BN	Shower Trim Only	ADA Lever	*Brushed Nickel	
090329	K-TS313-4M-BV	Shower Trim Only	ADA Lever	*Brushed Bronze	
060193	K-TS313-4M-CP	Shower Trim Only	ADA Lever	Polished Chrome	
086147	K-TS313-4M-SN	Shower Trim Only	ADA Lever	*Polished Nickel	
180593	K-TS313-4M-2BZ	Shower Trim Only Bronze	ADA Lever	Oil-Rubbed	

* Vibrant Limited Lifetime Warranty

www.waterconcepts.net • Serving our Customers Since 1946 • www.plumbsupply.com

Shower Faucets

Forté® Rite-Temp® Pressure-Balancing 1-Hdl Shower Faucet Trim

- Metal construction
- Intended for use with Rite-Temp® or HiFlow Rite-Temp® valves
- Includes faceplate and handle



T10276-4



T10276-4A

Requires:

K-304/K-P304 Series Rite-Temp® Valves
or
K-2971-KS 3/4" Pressure-balancing Valve

Part #	Mfg #	Description	Handle(s)	Finish	Price
225884	K-TS10276-4-BN	Shower Trim Only	ADA Sculpted Lever	*Brushed Nickel	
225882	K-TS10276-4-CP	Shower Trim Only	ADA Sculpted Lever	Polished Chrome	
225883	K-TS10276-4-G	Shower Trim Only	ADA Sculpted Lever	*Brushed Chrome	
225894	K-TS10276-4A-BN	Shower Trim Only	ADA Traditional Lever	*Brushed Nickel	
225892	K-TS10276-4A-CP	Shower Trim Only	ADA Traditional Lever	Polished Chrome	
225893	K-TS10276-4A-G	Shower Trim Only	ADA Traditional Lever	*Brushed Chrome	
225896	K-TS10276-4AE-BN	Shower Trim Only, 2.0gpm	ADA Traditional Lever	*Brushed Nickel	
225952	K-TS10276-4E-BN	Shower Trim Only, 2.0gpm	ADA Sculpted Lever	*Brushed Nickel	
225951	K-TS10276-4E-CP	Shower Trim Only, 2.0gpm	ADA Sculpted Lever	Polished Chrome	
231843	K-TS10277-4-BN	Valve Trim Only	ADA Sculpted Lever	*Brushed Nickel	
226187	K-TS10277-4-CP	Valve Trim Only	ADA Sculpted Lever	Polished Chrome	

Honesty™ Rite-Temp® Pressure-Balancing 1-Hdl Shower Faucet Trim

- Premium metal construction
- Intended for use with Rite-Temp® or HiFlow Rite-Temp® valves
- WaterSense® certified: 2.0 gpm

Requires:

K-304/K-P304 Series Rite-Temp® Valves
or
K-2971-KS 3/4" Pressure-balancing Valve
Push-Button Diverter Trim Requires Valve: K-11748-K/KS



Part #	Mfg #	Description	Handle(s)	Finish	Price
234927	K-TS99761-4-CP	Valve Trim Only, 2.0 gpm	ADA Lever	Polished Chrome	
178268	K-T99762-4-CP	Valve Trim Only, 2.0 gpm w/ Push-Button Diverter	ADA Lever	Polished Chrome	
177482	K-TS997644-CP	Shower Trim Only, 2.0 gpm	ADA Lever	Polished Chrome	

* Vibrant Limited Lifetime Warranty

www.plumbsupply.com • Serving our Customers Since 1946 • www.waterconcepts.net

Shower Faucets

Faucets & Valves

July™ Rite-Temp® Pressure-Balancing 1-Hdl Shower Valve Trim

- Premium construction
- Wall-mount
- WaterSense® certified product: 2.0 gpm



Requires:

K-304/K-P304 Series Rite-Temp® Valves
or
K-2971-KS 3/4" Pressure-balancing Valve

Part #	Mfg #	Description	Handle(s)	Finish	Price
225523	K-TS98009-4-CP	Shower Trim Only, Less Showerhead	Lever	Polished Chrome	
223406	K-TS98008-4-CP	Shower Trim Only	Lever	Polished Chrome	
223407	K-TS98008-4-G	Shower Trim Only	Lever	*Brushed Chrome	
223418	K-TS98147-4-CP	Valve Trim Only	Lever	Polished Chrome	
223419	K-TS98147-4-G	Valve Trim Only	Lever	*Brushed Chrome	

Kelston®™ Rite-Temp® 1-Hdl Shower Valve Trim

- Metal construction, brass valve bodies
- High-temperature limit stop
- Mixing valve cycles from cold to hot
- For use with Rite-Temp® or HiFlow Rite-Temp® valves
- Heavy-duty slip-fit clamp design



Requires:

K-304/K-P304 Series Rite-Temp® Valves
or
K-2971-KS 3/4" Pressure-balancing Valve

Part #	Mfg #	Description	Handle(s)	Finish	Price
225914	K-TS13493-4-BN	Shower Trim Only	ADA Lever	*Brushed Nickel	
225913	K-TS13493-4-CP	Shower Trim Only	ADA Lever	Polished Chrome	
225915	K-TS13493-4-2BZ	Shower Trim Only	ADA Lever	Oil-Rubbed Brz	
225916	K-TS13493-4E-CP	Shower Trim Only, 2.0GPM	ADA Lever	Polished Chrome	
225917	K-TS13493-4E-2BZ	Shower Trim Only, 2.0 GPM	ADA Lever	Oil-Rubbed Brz	
163601	K-TS98762-4-BN	Valve Trim Only	ADA Lever	*Brushed Nickel	
187728	K-TS98762-4-CP	Valve Trim Only	ADA Lever	Polished Chrome	
170253	K-TS98762-4-2BZ	Valve Trim Only	ADA Lever	Oil-Rubbed Brz	

Loure® Rite-Temp® 1-Hdl Shower Trim

- Brass construction
- MasterClean™ spray nozzles
- For use with Rite-Temp® or HiFlow Rite-Temp® valves



Requires:

K-304/K-P304 Series Rite-Temp® Valves
or
K-2971-KS 3/4" Pressure-balancing Valve
Push-Button Diverter Trim Requires Valve: **K-11748-K/KS**

Part #	Mfg #	Description	Handle(s)	Finish	Price
156293	K-T144665-4-BN	Shower Trim Only, with Push-Button Diverter	Lever	*Brushed Nickel	
154959	K-T144665-4-CP	Shower Trim Only, with Push-Button Diverter	Lever	Polished Chrome	

* Vibrant Limited Lifetime Warranty

www.waterconcepts.net • Serving our Customers Since 1946 • www.plumbsupply.com

Shower Faucets

Single-Handle Shower Trim (Continued)

Loure® Rite-Temp® 1-Hdl Shower Trim

Part #	Mfg #	Description	Handle(s)	Finish	Price
144349	K-TS14670-4-BN	Shower Trim Only	Lever	*Brushed Nickel	
224852	K-TS14670-4-CP	Shower Trim Only, 2.5 GPM	Lever	Polished Chrome	
169473	K-TS14670-4-SN	Shower Trim Only	Lever	Polished Nickel	
145329	K-TS14671-4-BN	Valve Trim Only	Lever	*Brushed Nickel	
156034	K-TS146714-CP	Valve Trim Only	Lever	Polished Chrome	
231459	K-TS14671-4-SN	Valve Trim Only	Lever	Polished Nickel	
161713	K-T14668-4-BN	Valve Trim Only, with Push-Button Diverter	Lever	*Brushed Nickel	
181258	K-T14668-4-CP	Valve Trim Only, with Push-Button Diverter	Lever	Polished Chrome	

Margaux® Rite-Temp® 1-Hdl Shower Trim

- Brass construction
- MasterClean™ sprayface
- For use with Rite-Temp® Valve

Requires:

K-304/K-P304 Series Rite-Temp® Valves

or

K-2971-KS 3/4" Pressure-balancing Valve

Push-Button Diverter Trim Requires Valve: K-11748-K/KS



T16234-3

T16234-4

Part #	Mfg #	Description	Handle(s)	Finish	Price
140272	K-TS16234-3-BN	Shower Trim Only	Cross	*Brushed Nickel	
110490	K-TS16234-3-CP	Shower Trim Only	Cross	Polished Chrome	
135701	K-TS16234-3-SN	Shower Trim Only	Cross	*Polished Nickel	
182980	K-TS16234-4-AF	Shower Trim Only	Cross	*French Gold	
227199	K-TS16234-4-BN	Shower Trim Only	Lever	*Brushed Nickel	
177099	K-TS16234-4-BV	Shower Trim Only	Lever	*Brushed Bronze	
107347	K-TS162344-CP	Shower Trim Only	Lever	Polished Chrome	
142650	K-TS16234-4-SN	Shower Trim Only	Lever	*Polished Nickel	
229143	K-TS16235-3-BN	Valve Trim Only	Cross	*Brushed Nickel	
114354	K-TS16235-3-CP	Valve Trim Only	Cross	Polished Chrome	
135429	K-TS16235-4-AF	Valve Trim Only	Lever	*French Gold	
109779	K-TS16235-4-BN	Valve Trim Only	Lever	*Brushed Nickel	
188546	K-TS16235-4-BV	Valve Trim Only	Lever	*Brushed Bronze	
109881	K-T16235-4-CP	Valve Trim Only	Lever	Polished Chrome	
135068	K-TS16235-4-SN	Valve Trim Only	Lever	*Polished Nickel	
181324	K-T98759-4-CP	Valve Trim Only, Push-Button Diverter	Lever	Polished Chrome	
225581	K-T98759-4-SN	Valve Trim Only, Push-Button Diverter	Lever	*Polished Nickel	

* Vibrant Limited Lifetime Warranty

www.plumbsupply.com • Serving our Customers Since 1946 • www.waterconcepts.net

Shower Faucets

Faucets & Valves

Memoirs® Rite-Temp® 1-Hdl Shower Trim

- Metal construction
- Available with cross or lever handles
- For use with Rite-Temp® or HiFlow Rite-Temp® valves

Requires:

K-304/K-P304 Series Rite-Temp® Valves

or

K-2971-KS 3/4" Pressure-balancing Valve



Part #	Mfg #	Description	Handle(s)	Finish	Price
064750	K-TS462-4S-BN	Shower Trim Only	Lever	*Brushed Nickel	
069909	K-TS462-4S-BV	Shower Trim Only	Lever	*Brushed Bronze	
058777	K-TS462-4S-CP	Shower Trim Only	Lever	Polished Chrome	
074956	K-TS462-4V-BN	Shower Trim Only	Decor Lever	*Brushed Nickel	
076927	K-TS462-4V-BV	Shower Trim Only	Decor Lever	*Brushed Bronze	
080341	K-TS4624V-CP	Shower Trim Only	Decor Lever	Polished Chrome	
179421	K-TS462-4V-2BZ	Shower Trim Only	Decor Lever	Oil-Rubbed Brnz	
069307	K-TS463-4S-BN	Valve Trim Only	Lever	*Brushed Nickel	
075916	K-TS463-4S-CP	Valve Trim Only	Lever	Polished Chrome	
082458	K-TS463-4V-BN	Valve Trim Only	Decor Lever	*Brushed Nickel	
228746	K-TS463-4V-BV	Valve Trim Only	Decor Lever	*Brushed Bronze	
079281	K-TS463-4V-CP	Valve Trim Only	Decor Lever	Polished Chrome	
165825	K-TS4634V-2BZ	Valve Trim Only	Decor Lever	Oil-Rubbed Brnz	

Pinstripe® Pure Rite-Temp® 1-Hdl Shower Trim

- Metal construction
- High-temperature limit stop

Requires:

K-304/K-P304 Series Rite-Temp® Valves

or

K-2971-KS 3/4" Pressure-balancing Valve

Push-Button Diverter Trim Requires Valve: K-11748-K/KS



Part #	Mfg #	Description	Handle(s)	Finish	Price
092348	K-TS13134-3A-CP	Shower Trim Only	Cross	Polished Chrome	
163780	K-TS13134-4A-BN	Shower Trim Only	Lever	*Brushed Nickel	
104404	K-TS13134-4A-CP	Shower Trim Only	Lever	Polished Chrome	
100192	K-TS13134-4A-SN	Shower Trim Only	Lever	*Polished Nickel	
152771	K-TS13135-3A-BN	Valve Trim Only	Cross	*Brushed Nickel	
086158	K-TS13135-3A-CP	Valve Trim Only	Cross	Polished Chrome	
084484	K-TS13135-3A-SN	Valve Trim Only	Cross	*Polished Nickel	
167436	K-TS13135-4A-BN	Valve Trim Only	Lever	*Brushed Nickel	
231758	K-TS13135-4A-CP	Valve Trim Only	Lever	Polished Chrome	
162689	K-TS13135-4B-CP	Valve Trim Only, Etched Symmetrical Lines	Lever	Polished Chrome	
187377	K-T98757-4A-CP	Valve Trim Only, Push Button Diverter	Lever	Polished Chrome	
162688	K-T98757-4B-CP	Valve Trim Only, Push Button Diverter	Lever	Polished Chrome	

* Vibrant Limited Lifetime Warranty

www.waterconcepts.net • Serving our Customers Since 1946 • www.plumbsupply.com

Shower Faucets

Purist® Rite-Temp® 1-Hdl Shower Trim

- Brass construction
- Katalyst® Spray Technology

Requires:

K-304/K-P304 Series Rite-Temp® Valves

or

K-2971-KS 3/4" Pressure-balancing Valve

Push-Button Diverter Trim Requires Valve: K-11748-K/KS



Faucets & Valves

Part #	Mfg #	Description	Handle(s)	Finish	Price
082429	K-TS14422-3-BN	Shower Trim Only	Cross	*Brushed Nickel	
065125	K-TS14422-3-CP	Shower Trim Only	Cross	Polished Chrome	
189646	K-T14422-3E-CP	Shower Trim Only, 2.0GPM	Cross	Polished Chrome	
067952	K-TS14422-4-BN	Shower Trim Only,	Lever	*Brushed Nickel	
155778	K-T14422-4E-CP	Shower Trim Only, 2.0GPM	Lever	Polished Chrome	
227810	K-TS14423-3-BV	Valve Trim Only	Cross	*Brushed Bronze	
076113	K-TS14423-4-BN	Valve Trim Only	Lever	*Brushed Nickel	
129624	K-TS14423-4-BV	Valve Trim Only	Lever	*Brushed Bronze	
074139	K-TS14423-4-CP	Valve Trim Only	Lever	Polished Chrome	
141121	K-TS14423-4-SN	Valve Trim Only	Lever	*Polished Nickel	
157792	K-T14501-4-BN	Valve Trim Only, with Push-Button Diverter	Lever	*Brushed Nickel	
154954	K-T14501-4-CP	Valve Trim Only, with Push-Button Diverter	Lever	Polished Chrome	

Refinia® Rite-Temp® 1-Hdl Shower Trim

- Premium construction
- MasterClean™ spray nozzles
- Heavy-duty slip-fit clamp design and NPT threaded spout



Requires:

K-304/K-P304 Series Rite-Temp® Valves

or

K-2971-KS 3/4" Pressure-balancing Valve

Push-Button Diverter Trim Requires Valve: K-11748-K/KS

Part #	Mfg #	Description	Handle(s)	Finish	Price
225799	K-TS53204-BN	Shower Trim Only	ADA Lever	*Brushed Nickel	
225998	K-TS5320-4-CP	Shower Trim Only	ADA Lever	Polished Chrome	
225800	K-TS5320-4E-BN	Shower Trim Only, 2.0 gpm	ADA Lever	*Brushed Nickel	
145068	K-T5319-4-BN	Shower Trim Only, Push Button Diverter	ADA Lever	*Brushed Nickel	
143236	K-T5319-4-CP	Shower Trim Only, Push Button Diverter	ADA Lever	Polished Chrome	
142807	K-T5321-4-BN	Valve Trim Only, Push Button Diverter	ADA Lever	*Brushed Nickel	
172066	K-T5321-4-CP	Valve Trim Only, Push Button Diverter	ADA Lever	Polished Chrome	
225802	K-TS5322-4-BN	Valve Trim Only	ADA Lever	*Brushed Nickel	
225801	K-TS5322-4-CP	Valve Trim Only	ADA Lever	Polished Chrome	

* Vibrant Limited Lifetime Warranty

www.plumbsupply.com • Serving our Customers Since 1946 • www.waterconcepts.net

Shower Faucets

Faucets & Valves

Revival® Rite-Temp® 1-Hdl Shower Trim

- Brass construction

Requires:

K-304/K-P304 Series Rite-Temp® Valves
or
K-2971-KS 3/4" Pressure-balancing Valve



Part #	Mfg #	Description	Handle(s)	Finish	Price
065903	K-TS16114-4A-BN	Shower Trim Only	Traditional Lever	*Brushed Nickel	
093246	K-TS16114-4A-BV	Shower Trim Only	Traditional Lever	*Brushed Bronze	
054681	K-TS16114-4A-CP	Shower Trim Only	Traditional Lever	Polished Nickel	
224609	K-T16114-4A-PB	Shower Trim Only	Traditional Lever	Polished Brass	

Stance® Rite-Temp 1-Hdl Shower Trim

- Brass construction
- MasterClean™ spray nozzles

Requires:

K-304/K-P304 Series Rite-Temp® Valves
or
K-2971-KS 3/4" Pressure-balancing Valve



Push-Button Diverter Trim Requires Valve: K-11748-K/KS



T-T14777-4

Part #	Mfg #	Description	Handle(s)	Finish	Price
233975	K-TS14778-4-BN	Shower Trim Only	Lever	*Brushed Nickel	
138472	K-TS14778-4-CP	Shower Trim Only	Lever	Polished Chrome	
165903	K-TS14780-4-BN	Valve Trim Only	Lever	*Brushed Nickel	
138430	K-TS14780-4-CP	Valve Trim Only	Lever	Polished Chrome	
156548	K-T14777-4-BN	Shower Trim Only, Push Button Diverter	Lever	*Brushed Nickel	
165331	K-T14777-4-CP	Shower Trim Only, Push Button Diverter	Lever	Polished Chrome	
142074	K-T14779-4-BN	Valve Trim Only, Push Button Diverter	Lever	*Brushed Nickel	
150842	K-T14779-4-CP	Valve Trim Only, Push Button Diverter	Lever	Polished Chrome	

Stillness® Rite-Temp 1-Hdl Shower Trim

- Premium metal construction

Requires:

K-304/K-P304 Series Rite-Temp® Valves
or
K-2971-KS 3/4" Pressure-balancing Valve
Push-Button Diverter Trim Requires Valve: K-11748-K/KS



Part #	Mfg #	Description	Handle(s)	Finish	Price
093775	K-TS949-4-BN	Shower Trim Only	Lever	*Brushed Nickel	

* Vibrant Limited Lifetime Warranty

www.waterconcepts.net • Serving our Customers Since 1946 • www.plumbsupply.com

Shower Faucets

Single-Handle Shower Trim (Continued) Stillness® Rite-Temp 1-Hdl Shower Trim

Part #	Mfg #	Description	Handle(s)	Finish	Price
234086	K-TS949-4-CP	Shower Trim Only	Lever	Polished Chrome	
087770	K-TS950-4-BN	Valve Trim Only	Lever	*Brushed Nickel	
061889	K-TS950-4-CP	Valve Trim Only	Lever	Polished Chrome	
226017	K-T1004-4-CP	Valve Trim Only, Push Button Diverter	Lever	Polished Chrome	

Toobi™ Rite-Temp® 1-Hdl Shower Trim

- Metal construction
- Catalyst™ spray technology
- (48) MasterClean™ spray nozzles
- Flow rate: 2.0 gpm

Requires:

K-304/K-P304 Series Rite-Temp® Valves

or

K-2971-KS 3/4" Pressure-balancing Valve

Push-Button Diverter Trim Requires Valve: K-11748-K/KS



Part #	Mfg #	Description	Handle(s)	Finish	Price
149687	K-TS8978-4-BN	Shower Trim Only	Lever	*Brushed Nickel	
152777	K-TS8978-4-CP	Shower Trim Only	Lever	Polished Chrome	
143159	K-T8979-4-BN	Valve Trim Only, Push Button Diverter	Lever	*Brushed Nickel	
155215	K-T8979-4-CP	Valve Trim Only, Push Button Diverter	Lever	Polished Chrome	
143157	K-TS8981-4-BN	Valve Trim Only	Lever	*Brushed Nickel	
234924	K-TS8981-4-CP	Valve Trim Only	Lever	Polished Chrome	

Two-Handle Shower Trim Coralais® 2-Hdl Shower Trim

- Metal construction
- Showerhead, arm and flange
- Reversible 1/2" 1/4-turn washerless ceramic disc valves
- 4-7/8" Diverter spout

Requires valve K-302-K



Part #	Mfg #	Description	Handle(s)	Finish	Price
067315	K-T15211-4-CP	Shower Trim Only	ADA Lever	Polished Chrome	
062715	K-T15225-4-CP	Valve Trim Only	ADA Lever	Polished Chrome	

* Vibrant Limited Lifetime Warranty

www.plumbsupply.com • Serving our Customers Since 1946 • www.waterconcepts.net

Shower Faucets

Faucets & Valves

Performance Shower Valve Trim

- Vibrant finishes have a lifetime limited warranty

Alteo® Transfer Valve Trim

- Metal construction
- Front seal plate assembly



Requires: K-728-K 3/4" Transfer Valve

Part #	Mfg #	Description	Handle(s)	Finish	Price
142511	K-T45121-4-BN	Transfer Trim Only	ADA Metal Lever	*Brushed Nickel	
143973	K-T45121-4-CP	Transfer Trim Only	ADA Metal Lever	Polished Chrome	
153840	K-T45121-4-2BZ	Transfer Trim Only	ADA Metal Lever	Oil-Rubbed Brnz	

Archer® Transfer Valve Trim

- Single lever handle allows control of up to 3 separate components to six different output options



Requires: K-728-K 3/4" in-wall 2- or 3-way Transfer Valve
or
K-737-K MasterShower® 2- or 3-way Diverter Valve

Part #	Mfg #	Description	Handle(s)	Finish	Price
173039	K-T45850-4-BN	Transfer Trim Only	ADA Metal Lever	*Brushed Nickel	
180694	K-T45850-4-CP	Transfer Trim Only	ADA Metal Lever	Polished Chrome	

Artifacts® Transfer Valve Trim

- Single lever handle allows control of up to 3 separate components to six different output options



Requires: K-728-K 3/4" in-wall 2- or 3-way Transfer Valve
or
K-737-K MasterShower® 2- or 3-way Diverter Valve

Part #	Mfg #	Description	Handle(s)	Finish	Price
225784	K-T72770-3M-VNT	Transfer Trim Only	ADA Prong	Vintage Nickel	
166100	K-T72770-4-BN	Transfer Trim Only	ADA Lever	*Brushed Nickel	
169558	K-T72770-4-CP	Transfer Trim Only	ADA Lever	Polished Chrome	
181400	K-T72770-4-BV	Transfer Trim Only	ADA Lever	*Brushed Bronze	
174115	K-T72770-4-SN	Transfer Trim Only	ADA Lever	Polished Nickel	
180273	K-T72770-4-2BZ	Transfer Trim Only	ADA Lever	Oil-Rubbed Brnz	
188591	K-T72770-9M-BN	Transfer Trim Only	ADA Swing	*Brushed Nickel	
186424	K-T72770-9M-CP	Transfer Trim Only	ADA Swing	Polished Chrome	
165045	K-T72770-9M-SN	Transfer Trim Only	ADA Swing	Polished Nickel	
186118	K-T72770-9M-2BZ	Transfer Trim Only	ADA Swing	Oil-Rubbed Brnze	

* Vibrant Limited Lifetime Warranty

www.waterconcepts.net • Serving our Customers Since 1946 • www.plumbsupply.com

Shower Faucets

Artifacts® Volume Control Valve Trim

- Metal construction
- Front seal plate assembly

Requires:

K-2974-K 1/2" Volume Control Valve
or
K-2977-K 3/4" Volume Control Valve



-4



-3M



-9M

Part #	Mfg #	Description	Handle(s)	Finish	Price
186412	K-T727713M-CP	Volume Trim Only	ADA Prong	Polished Chrome	
177053	K-T72771-3M-2BZ	Volume Trim Only	ADA Prong	Oil-Rubbed Brnze	
177223	K-T72771-4-BN	Volume Trim Only	ADA Lever	*Brushed Nickel	
183420	K-T72771-4-SN	Volume Trim Only	ADA Lever	*Polished Nickel	
173809	K-T72771-4-2BZ	Volume Trim Only	ADA Lever	Oil-Rubbed Brnze	

Artifacts® Thermostatic Valve Trim

- Metal construction
- Front seal plate assembly

Requires:

K-2972-KS 1/2" Thermostatic Valve
or
K-2975-KS 3/4" Thermostatic Valve



-9



-3M



-9M

Part #	Mfg #	Description	Handle(s)	Finish	Price
186411	K-T72769-3M-CP	Thermostatic Trim Only	ADA Prong	Polished Chrome	
177052	K-T72769-3M-2BZ	Thermostatic Trim Only	ADA Prong	Oil-Rubbed Brnze	
177222	K-T72769-4-BN	Thermostatic Trim Only	ADA Lever	*Brushed Nickel	
183414	K-T72769-4-SN	Thermostatic Trim Only	ADA Lever	*Polished Nickel	
189247	K-T72769-4-2BZ	Thermostatic Trim Only	ADA Lever	Oil-Rubbed Brnze	
183416	K-T72769-9M-2BZ	Thermostatic Valve Trim	ADA Swing	Oil-Rubbed Brnze	

Bancroft® Stacked Thermostatic Valve Trim

- Brass construction
- Front seal plate assembly

Requires

K-2973-KS 1/2" Stacked Thermostatic Valve
or
K-2976-KS 3/4" Stacked Thermostatic Valve



Part #	Mfg #	Description	Handle(s)	Finish	Price
103809	K-T10594-4-BN	Thermostatic Trim Only	ADA Metal Lever	*Brushed Nickel	
111084	K-T10594-4-BV	Thermostatic Trim Only	ADA Metal Lever	*Brushed Bronze	
099598	K-T10594-4-CP	Thermostatic Trim Only	ADA Metal Lever	Polished Chrome	
181997	K-T10594-4-SN	Thermostatic Trim Only	ADA Metal Lever	*Polished Nickel	
150240	K-T10594-4-2BZ	Thermostatic Trim Only	ADA Metal Lever	Oil-Rubbed Brnze	
113176	K-T10594-4P-CP	Thermostatic Trim Only	ADA Wht Porcelain Lever	Polished Chrome	

* Vibrant Limited Lifetime Warranty

www.plumbsupply.com • Serving our Customers Since 1946 • www.waterconcepts.net

Shower Faucets

Faucets & Valves

Performance Shower Valve Trim (Continued)
Bancroft® Stacked Thermostatic Valve Trim

Part #	Mfg #	Description	Handle(s)	Finish	Price
179772	K-T10594-4P-BN	Thermostatic Trim Only	ADA Wht Porcelain Lever	*Brushed Nickel	

Bancroft® Transfer Valve Trim

- Brass construction
- Front seal plate assembly



Requires: K-728-K 3/4" in-wall 2- or 3-way Transfer Valve
or
K-737-K 3/4" 2- or 3-way Diverter Valve

Part #	Mfg #	Description	Handle(s)	Finish	Price
103810	K-T10595-4-BN	Transfer Trim Only	ADA Metal Lever	*Brushed Nickel	
111081	K-T10595-4-BV	Transfer Trim Only	ADA Metal Lever	*Brushed Bronze	
104051	K-T10595-4-CP	Transfer Trim Only	ADA Metal Lever	Polished Chrome	
173350	K-T10595-4-SN	Transfer Trim Only	ADA Metal Lever	*Polished Nickel	
150241	K-T10595-4-2BZ	Transfer Trim Only	ADA Metal Lever	Oil-Rubbed Brnze	

Bancroft® Volume Control Valve Trim

- Brass construction
- Front seal plate assembly



Requires:
K-2974-K 1/2" Volume Control Valve
or
K-2977-K 3/4" Volume Control Valve

Part #	Mfg #	Description	Handle(s)	Finish	Price
110911	K-T10596-4-BN	Volume Control Trim Only	ADA Metal Lever	*Brushed Nickel	
102626	K-T10596-4-CP	Volume Control Trim Only	ADA Metal Lever	Polished Chrome	
146019	K-T10596-4-SN	Volume Control Trim Only	ADA Metal Lever	*Polished Nickel	
138305	K-T10596-4-2BZ	Volume Control Trim Only Bronze	ADA Metal Lever	Oil-Rubbed	
105157	K-T10596-4P-CP	Volume Control Trim Only	ADA Porcelain Lever	Polished Chrome	

Composed™ Transfer Valve Trim

- Metal construction
- Front seal plate assembly



Requires: K-728-K 3/4" in-wall 2- or 3-way Transfer Valve
or
K-737-K 3/4" 2- or 3-way Diverter Valve

Part #	Mfg #	Description	Handle(s)	Finish	Price
224854	K-T73140-4-CP	Transfer Trim Only	ADA Lever	Polished Chrome	

* Vibrant Limited Lifetime Warranty

www.waterconcepts.net • Serving our Customers Since 1946 • www.plumbsupply.com

Shower Faucets

Devonshire® Transfer Valve Trim

- Brass construction
- Front seal plate assembly



Requires: K-728-K 3/4" in-wall 2- or 3-way Transfer Valve
or
K-737-K 3/4" 2- or 3-way Diverter Valve

Part #	Mfg #	Description	Handle(s)	Finish	Price
091165	K-T376-4-BN	Transfer Trim Only	ADA Lever	*Brushed Nickel	
090304	K-T376-4-BV	Transfer Trim Only	ADA Lever	*Brushed Bronze	
094950	K-T376-4-CP	Transfer Trim Only	ADA Lever	Polished Chrome	
172079	K-T376-4-SN	Transfer Trim Only	ADA Lever	*Polished Nickel	
146974	K-T376-4-2BZ	Transfer Trim Only	ADA Lever	Oil-Rubbed Brnze	

Devonshire® Thermostatic Valve Trim

- Metal construction
- Front seal plate assembly



Requires:
K-2972-KS 1/2" Thermostatic Valve
or
K-2975-KS 3/4" Thermostatic Valve

Part #	Mfg #	Description	Handle(s)	Finish	Price
117653	K-T10357-4-BN	Thermostatic Valve Trim	ADA Lever	*Brushed Nickel	
120681	K-T10357-4-BV	Thermostatic Valve Trim	ADA Lever	*Brushed Bronze	
121709	K-T10357-4-CP	Thermostatic Valve Trim	ADA Lever	Polished Chrome	
146197	K-T10357-4-PB	Thermostatic Valve Trim	ADA Lever	*Polished Brass	
184419	K-T10357-4-SN	Thermostatic Valve Trim	ADA Lever	*Polished Nickel	
146972	K-T10357-4-2BZ	Thermostatic Valve Trim	ADA Lever	Oil-Rubbed Brnze	

Devonshire® Volume Control Valve Trim

- Brass construction
- Front seal plate assembly



Requires:
K-2974-K 1/2" Volume Control Valve
or
K-2977-K 3/4" Volume Control Valve

Part #	Mfg #	Description	Handle(s)	Finish	Price
117655	K-T10358-4-BN	Volume Control Trim Only	ADA Lever	*Brushed Nickel	
120682	K-T10358-4-BV	Volume Control Trim Only	ADA Lever	*Brushed Bronze	
121708	K-T10358-4-CP	Volume Control Trim Only	ADA Lever	Polished Chrome	
146198	K-T10358-4-PB	Volume Control Trim Only	ADA Lever	*Polished Brass	
184420	K-T10358-4-SN	Volume Control Trim Only	ADA Lever	*Polished Nickel	
146973	K-T10358-4-2BZ	Volume Control Trim Only	ADA Lever	Oil-Rubbed Brnze	

* Vibrant Limited Lifetime Warranty

www.plumbsupply.com • Serving our Customers Since 1946 • www.waterconcepts.net

Shower Faucets

Faucets & Valves

Finial® Traditional Transfer Valve Trim

- Brass construction
- Front seal plate assembly



Requires: K-728-K 3/4" in-wall 2- or 3-way Transfer Valve
or
K-737-K 3/4" 2- or 3-way Diverter Valve

Part #	Mfg #	Description	Handle(s)	Finish	Price
100291	K-T10304-4M-BN	Transfer Trim Only	ADA Lever	*Brushed Nickel	

Finial® Traditional Thermostatic Valve Trim

- Metal construction
- Front seal plate assembly



Requires:
K-2972-KS 1/2" Thermostatic Valve
or
K-2975-KS 3/4" Thermostatic Valve

Part #	Mfg #	Description	Handle(s)	Finish	Price
096600	K-T10301-4M-BN	Thermostatic Valve Trim	ADA Lever	*Brushed Nickel	
091561	K-T10301-4M-BV	Thermostatic Valve Trim	ADA Lever	*Brushed Bronze	
091338	K-T10301-4M-CP	Thermostatic Valve Trim	ADA Lever	Polished Chrome	
182954	K-T10301-4M-SN	Thermostatic Valve Trim	ADA Lever	*Polished Nickel	

Finial® Traditional Volume Control Valve Trim

- Brass construction
- Front seal plate assembly



Requires:
K-2974-K 1/2" Volume Control Valve
or
K-2977-K 3/4" Volume Control Valve

Part #	Mfg #	Description	Handle(s)	Finish	Price
096601	K-T10303-4M-BN	Volume Control Trim	ADA Lever	*Brushed Nickel	
091562	K-T10303-4M-BV	Volume Control Trim	ADA Lever	*Brushed Bronze	
108910	K-T10303-4M-CP	Volume Control Trim	ADA Lever	Polished Chrome	
182956	K-T10303-4M-SN	Volume Control Trim	ADA Lever	*Polished Nickel	

* Vibrant Limited Lifetime Warranty

www.waterconcepts.net • Serving our Customers Since 1946 • www.plumbsupply.com

Shower Faucets

Finial® Traditional Stacked Thermostatic Valve Trim

- Brass construction
- Front seal plate assembly



Requires

K-2973-KS 1/2" Stacked Thermostatic Valve

or

K-2976-KS 3/4" Stacked Thermostatic Valve

Part #	Mfg #	Description	Handle(s)	Finish	Price
182955	K-T10302-4M-AF	Stacked Thermostatic Valve Trim	ADA Lever	*French Gold	
100292	K- T10302-4M-BN	Stacked Thermostatic Valve Trim	ADA Lever	*Brushed Nickel	
099694	K- T10302-4M-BV	Stacked Thermostatic Valve Trim	ADA Lever	*Brushed Bronze	
121788	K- T10302-4M-CP	Stacked Thermostatic Valve Trim	ADA Lever	Polished Chrome	
137985	K- T10302-4M-SN	Stacked Thermostatic Valve Trim	ADA Lever	*Polished Nickel	

Forté® Thermostatic Valve Trim

- Metal construction
- Front seal plate assembly



Requires:

K-2972-KS 1/2" Thermostatic Valve

or

K-2975-KS 3/4" Thermostatic Valve

Part #	Mfg #	Description	Handle(s)	Finish	Price
116800	K-T10359-4-BN	Thermostatic Trim Only	ADA Sculpted Lever	*Brushed Nickel	
121306	K-T10359-4-CP	Thermostatic Trim Only	ADA Sculpted Lever	Polished Chrome	
167079	K-T10359-4-G	Thermostatic Trim Only	ADA Sculpted Lever	Brushed Chrome	

Forté® Volume Control Valve Trim

- Brass construction
- Front seal plate assembly



Requires:

K-2974-K 1/2" Volume Control Valve

or

K-2977-K 3/4" Volume Control Valve

Part #	Mfg #	Description	Handle(s)	Finish	Price
119281	K-T10360-4-BN	Volume Control Trim Only	ADA Sculpted Lever	*Brushed Nickel	
116531	K-T10360-4-CP	Volume Control Trim Only	ADA Sculpted Lever	Polished Chrome	
167080	K-T10360-4-G	Volume Control Trim Only	ADA Sculpted Lever	Brushed Chrome	

* Vibrant Limited Lifetime Warranty

www.plumbsupply.com • Serving our Customers Since 1946 • www.waterconcepts.net

Shower Faucets

Faucets & Valves

Forté® Transfer Valve Trim

- Brass construction
- Front seal plate assembly



Requires: K-728-K 3/4" in-wall 2- or 3-way Transfer Valve
or
K-737-K 3/4" 2- or 3-way Diverter Valve

Part #	Mfg #	Description	Handle(s)	Finish	Price
090303	K-T10290-4-BN	Transfer Trim Only	ADA Sculpted Lever	*Brushed Nickel	
090704	K-T10290-4-CP	Transfer Trim Only	ADA Sculpted Lever	Polished Chrome	
096556	K-T10290-4-G	Transfer Trim Only	ADA Sculpted Lever	Brushed Chrome	

Kelston® Transfer Valve Trim

- Metal construction
- Front seal plate assembly



Requires:
K-728-K 3/4" in-wall 2- or 3-way Transfer Valve
or
K-737-K 3/4" 2- or 3-way Diverter Valve

Part #	Mfg #	Description	Handle(s)	Finish	Price
147110	K-T13661-4-BN	Transfer Trim Only	ADA Lever	*Brushed Nickel	
147109	K-T13661-4-CP	Transfer Trim Only	ADA Lever	Polished Chrome	
147003	K-T13661-4-2BZ	Transfer Trim Only	ADA Lever	Oil-Rubbed Bronze	

Loure® Thermostatic Valve Trim

- Brass construction
- Front seal plate assembly



Requires:
K-2972-KS 1/2" Thermostatic Valve
or
K-2975-KS 3/4" Thermostatic Valve

Part #	Mfg #	Description	Handle(s)	Finish	Price
145696	K-T14672-4-BN	Thermostatic Trim Only	ADA Lever	*Brushed Nickel	
156032	K-T14672-4-CP	Thermostatic Trim Only	ADA Lever	Polished Chrome	

Loure® Volume Control Valve Trim

- Brass construction
- Front seal plate assembly



Requires:
K-2974-K 1/2" Volume Control Valve
or
K-2977-K 3/4" Volume Control Valve

Part #	Mfg #	Description	Handle(s)	Finish	Price
145697	K-T14674-4-BN	Volume Control Trim Only	ADA Lever	*Brushed Nickel	

* Vibrant Limited Lifetime Warranty

www.waterconcepts.net • Serving our Customers Since 1946 • www.plumbsupply.com

Shower Faucets

Performance Shower Valve Trim (Continued) Loure® Volume Control Valve Trim

Part #	Mfg #	Description	Handle(s)	Finish	Price
156033	K-T14674-4-CP	Volume Control Trim Only	ADA Lever	Polished Chrome	

Loure® Transfer Valve Trim

Requires:
K-728-K 3/4" in-wall 2- or 3-way Transfer Valve
or
K-737-K 3/4" 2- or 3-way Diverter Valve



Part #	Mfg #	Description	Handle(s)	Finish	Price
145330	K-T14673-4-BN	Transfer Trim Only	ADA Lever	*Brushed Nickel	
139114	K-T14673-4-CP	Transfer Trim Only	ADA Lever	Polished Chrome	

MasterShower® Transfer Valve Trim

- Brass construction
- Front seal plate assembly

Requires:
K-728-K 3/4" in-wall 2- or 3-way Transfer Valve
or
K-737-K 3/4" 2- or 3-way Diverter Valve



Part #	Mfg #	Description	Handle(s)	Finish	Price
156637	K-T10185-7-CP	Transfer Valve Trim Only	Knob	Polished Chrome	

MasterShower® Thermostatic Valve Trim

- Brass construction
- Front seal plate assembly

Requires:
K-2972-KS 1/2" Thermostatic Valve
or
K-2975-KS 3/4" Thermostatic Valve



Part #	Mfg #	Description	Handle(s)	Finish	Price
182952	K-T10182-7-BN	Thermostatic Trim Only	Knob	*Brushed Nickel	
141590	K-T10182-7-CP	Thermostatic Trim Only	Knob	Polished Chrome	

* Vibrant Limited Lifetime Warranty

www.plumbsupply.com • Serving our Customers Since 1946 • www.waterconcepts.net

Shower Faucets

Faucets & Valves

MasterShower® Volume Control Valve

- Brass construction
- Front seal plate assembly

Requires:

K-2974-K 1/2" Volume Control Valve
or
K-2977-K 3/4" Volume Control Valve



Part #	Mfg #	Description	Handle(s)	Finish	Price
182953	K-T10184-7-BN	Volume Control Trim	Knob	*Brushed Nickel	
141591	K-T10184-7-CP	Volume Control Trim	Knob	Polished Chrome	

Margaux® Thermostatic Valve Trim

- Brass construction
- Front seal plate assembly

Requires:

K-2972-KS 1/2" Thermostatic Valve
or
K-2975-KS 3/4" Thermostatic Valve



Part #	Mfg #	Description	Handle(s)	Finish	Price
114258	K-T16239-3-BV	Thermostatic Trim Only	ADA Cross	*Brushed Bronze	
117695	K-T16239-3-CP	Thermostatic Trim Only	ADA Cross	Polished Chrome	
152152	K-T16239-3-SN	Thermostatic Trim Only	ADA Cross	*Polished Nickel	
120554	K-T16239-4-BN	Thermostatic Trim Only	ADA Lever	*Brushed Nickel	
115701	K-T16239-4-CP	Thermostatic Trim Only	ADA Lever	Polished Chrome	
160871	K-T16239-4-SN	Thermostatic Trim Only	ADA Lever	*Polished Nickel	

Margaux® Volume Control Valve Trim

- Brass construction
- Front seal plate assembly

Requires:

K-2974-K 1/2" Volume Control Valve
or
K-2977-K 3/4" Volume Control Valve



Part #	Mfg #	Description	Handle(s)	Finish	Price
114259	K-T16241-3-BV	Volume Control Trim Only	ADA Cross	*Brushed Bronze	
117696	K-T16241-3-CP	Volume Control Trim Only	ADA Cross	Polished Chrome	
152155	K-T16241-3-SN	Volume Control Trim Only	ADA Cross	*Polished Nickel	
120555	K-T16241-4-BN	Volume Control Trim Only	ADA Lever	*Brushed Nickel	
127387	K-T16241-4-CP	Volume Control Trim Only	ADA Lever	Polished Chrome	
160872	K-T16241-4-SN	Volume Control Trim Only	ADA Lever	*Polished Nickel	

* Vibrant Limited Lifetime Warranty

www.waterconcepts.net • Serving our Customers Since 1946 • www.plumbsupply.com

Shower Faucets

Margaux® Transfer Valve Trim

- Brass construction
- Front seal plate assembly



Requires:

K-728-K 3/4" in-wall 2- or 3-way Transfer Valve
or
K-737-K 3/4" 2- or 3-way Diverter Valve

Part #	Mfg #	Description	Handle(s)	Finish	Price
176333	K-T16242-3-BN	Transfer Valve Trim Only	Cross	*Brushed Nickel	
184124	K-T16242-4-AF	Transfer Valve Trim Only	ADA Lever	*French Gold	
108760	K-T16242-4-BN	Transfer Valve Trim Only	ADA Lever	*Brushed Nickel	
188547	K-T16242-4-BV	Transfer Valve Trim Only	ADA Lever	*Brushed Bronze	
107352	K-T16242-4-CP	Transfer Valve Trim Only	ADA Lever	Polished Chrome	
135074	K-T16242-4-SN	Transfer Valve Trim Only	ADA Lever	*Polished Nickel	

Memoirs® Stately Transfer Valve Trim

- Brass construction
- Front seal plate assembly



Requires:

K-728-K 3/4" in-wall 2- or 3-way Transfer Valve
or
K-737-K 3/4" 2- or 3-way Diverter Valve

Part #	Mfg #	Description	Handle(s)	Finish	Price
090053	K-T10424-4V-BN	Transfer Valve Trim Only	ADA Decor Lever	*Brushed Nickel	
095146	K-T10424-4V-BV	Transfer Valve Trim Only	ADA Decor Lever	*Brushed Bronze	
093508	K-T10424-4V-CP	Transfer Valve Trim Only	ADA Decor Lever	Polished Chrome	
165826	K-T10424-4V-2BZ	Transfer Valve Trim Only	ADA Decor Lever	Oil-Rubbed Brnze	

Memoirs® Stately Thermostatic Valve Trim

- Brass construction
- Front seal plate assembly



Requires:

K-2972-KS 1/2" Thermostatic Valve
or
K-2975-KS 3/4" Thermostatic Valve

Part #	Mfg #	Description	Handle(s)	Finish	Price
182957	K-T10421-4S-BN	Valve Trim Only	ADA Faceted Lever	*Brushed Nickel	
103893	K-T10421-4V-BN	Valve Trim Only	ADA Decor Lever	*Brushed Nickel	

* Vibrant Limited Lifetime Warranty

www.plumbsupply.com • Serving our Customers Since 1946 • www.waterconcepts.net

Shower Faucets

Faucets & Valves

Memoirs® Stately Stacked Thermostatic Valve Trim

- Patented K-joint installation
- Ergonomic handle is ADA-compliant
- Trim requires valve to complete



Requires

K-2973-KS 1/2" Stacked Thermostatic Valve
or
K-2976-KS 3/4" Stacked Thermostatic Valve

Part #	Mfg #	Description	Handle(s)	Finish	Price
182958	K-T10422-4S-CP	Stacked Thermostatic Valve Trim	ADA Lever	Polished Chrome	
186591	K-T10422-4V-2BZ	Stacked Thermostatic Valve Trim	ADA Decor Lever	Oil-Rubbed Brnze	

Memoirs® Volume Control Trim

- Brass construction
- Front seal plate assembly



Requires:

K-2974-K 1/2" Volume Control Valve
or
K-2977-K 3/4" Volume Control Valve

Part #	Mfg #	Description	Handle(s)	Finish	Price
182959	K-T10423-4S-BN	Volume Control Trim	ADA Faceted Lever	*Brushed Nickel	
142324	K-T10423-4S-BV	Volume Control Trim	ADA Faceted Lever	*Brushed Bronze	
102090	K-T10423-4V-BN	Volume Control Trim	ADA Decor Lever	*Brushed Nickel	
100874	K-T10423-4V-BV	Volume Control Trim	ADA Decor Lever	*Brushed Bronze	
089147	K-T10423-4V-CP	Volume Control Trim	ADA Decor Lever	Polished Chrome	

Pinstripe® Thermostatic Valve trim

- Brass construction
- Front seal plate assembly
- Model (K-T13173-4A-BN) comes with pure design



Requires:

K-2972-KS 1/2" Thermostatic Valve
or
K-2975-KS 3/4" Thermostatic Valve

Part #	Mfg #	Description	Handle(s)	Finish	Price
182969	K-T13173-4A-BN	Valve Trim Only, Pure Design	ADA Lever	*Brushed Nickel	
180917	K-T13173-4B-CP	Valve Trim Only	ADA Lever	Polished Chrome	

* Vibrant Limited Lifetime Warranty

www.waterconcepts.net • Serving our Customers Since 1946 • www.plumbsupply.com

Shower Faucets

Pinstripe® Volume Control Trim

- Brass construction
- Front seal plate assembly



Requires:

K-2974-K 1/2" Volume Control Valve
or
K-2977-K 3/4" Volume Control Valve

Part #	Mfg #	Description	Handle(s)	Finish	Price
182970	K-T13174-3B-SN	Valve Trim Only	ADA Cross	*Polished Nickel	
187257	K-T13174-4A-CP	Valve Trim Only	ADA Lever	Polished Chrome	
180918	K-T13174-4B-CP	Valve Trim Only	ADA Lever	Polished Chrome	

Pinstripe® Transfer Valve Trim with Pure Design

- Brass construction
- Front seal plate assembly
- Model **(K-T13175-3B-CP)** includes etched symmetrical lines



Requires:

K-728-K 3/4" in-wall 2- or 3-way Transfer Valve
or
K-737-K 3/4" 2- or 3-way Diverter Valve

Part #	Mfg #	Description	Handle(s)	Finish	Price
152772	K-T13175-3A-BN	Transfer Trim Only	Cross	*Brushed Nickel	
140943	K-T13175-3A-CP	Transfer Trim Only	Cross	Polished Chrome	
162236	K-T13175-3B-CP	Transfer Trim Only, Etched Symmetrical Lines	Cross	Polished Chrome	
163781	K-T13175-4A-BN	Transfer Trim Only	Lever	*Brushed Nickel	
110256	K-T13175-4A-CP	Transfer Trim Only	Lever	Polished Chrome	
182971	K-T13175-4B-SN	Transfer Trim Only	Lever	*Polished Nickel	

Purist® Transfer Valve Trim

- Brass construction
- Front seal plate assembly



K-T14491-3



K-T14491-4

Requires:

K-728-K 3/4" in-wall 2- or 3-way Transfer Valve
or
K-737-K 3/4" 2- or 3-way Diverter Valve

Part #	Mfg #	Description	Handle(s)	Finish	Price
162442	K-T14491-3-BN	Transfer Trim Only	Cross	*Brushed Nickel	
144443	K-T14491-3-CP	Transfer Trim Only	Cross	Polished Chrome	
148315	K-T14491-3-SN	Transfer Trim Only	Cross	*Polished Nickel	
091680	K-T14491-4-BN	Transfer Trim Only	ADA Lever	*Brushed Nickel	
153093	K-T14491-4-BV	Transfer Trim Only	ADA Lever	*Brushed Bronze	
094455	K-T14491-4-CP	Transfer Trim Only	ADA Lever	Polished Chrome	
131003	K-T14491-4-SN	Transfer Trim Only	ADA Lever	*Polished Nickel	

* Vibrant Limited Lifetime Warranty

www.plumbsupply.com • Serving our Customers Since 1946 • www.waterconcepts.net

Shower Faucets

Faucets & Valves

Purist® Thermostatic Valve Trim

- Brass construction
- Front seal plate assembly



Requires:
K-2972-KS 1/2" Thermostatic Valve
or
K-2975-KS 3/4" Thermostatic Valve

Part #	Mfg #	Description	Handle(s)	Finish	Price
091679	K-T14488-4-BN	Thermostatic Trim Only	ADA Lever	*Brushed Nickel	
092815	K-T14488-4-CP	Thermostatic Trim Only	ADA Lever	Polished Chrome	
182972	K-T14488-4-SN	Thermostatic Trim Only	ADA Lever	*Polished Nickel	

Purist® Volume Control Valve Trim

- Brass construction
- Front seal plate assembly



Requires:
K-2974-K 1/2" Volume Control Valve
or
K-2977-K 3/4" Volume Control Valve

Part #	Mfg #	Description	Handle(s)	Finish	Price
098371	K-T14490-4-BN	Volume Control Trim	ADA Lever	*Brushed Nickel	
092816	K-T14490-4-CP	Volume Control Trim	ADA Lever	Polished Chrome	
182973	K-T14490-4-SN	Volume Control Trim	ADA Lever	*Polished Nickel	

Purist® Thermostatic Stacked Valve Trim

- Patented K-joint
- Wall-Mount installation
- Trim requires valve to be complete



Requires
K-2973-KS 1/2" Stacked Thermostatic Valve
or
K-2976-KS 3/4" Stacked Thermostatic Valve

Part #	Mfg #	Description	Handle(s)	Finish	Price
188577	K-T14489-4-BV	Stacked Thermostatic Trim	ADA Lever	*Brushed Bronze	

Revival® Thermostatic Valve Trim

- Brass construction
- Front seal plate assembly



Requires:
K-2972-KS 1/2" Thermostatic Valve
or
K-2975-KS 3/4" Thermostatic Valve

Part #	Mfg #	Description	Handle(s)	Finish	Price
091082	K-T16175-4-BN	Thermostatic Trim Only	ADA Scroll Lever	*Brushed Nickel	
099897	K-T16175-4-BV	Thermostatic Trim Only	ADA Scroll Lever	*Brushed Bronze	

* Vibrant Limited Lifetime Warranty

www.waterconcepts.net • Serving our Customers Since 1946 • www.plumbsupply.com

Shower Faucets

Performance Shower Valve Trim (Continued)

Revival® Thermostatic Valve Trim

Part #	Mfg #	Description	Handle(s)	Finish	Price
101242	K-T16175-4-CP	Thermostatic Trim Only	ADA Scroll Lever	Polished Chrome	
183166	K-T16175-4-PB	Thermostatic Trim Only	ADA Scroll Lever	*Polished Brass	

Revival® Volume Control Valve Trim

- Brass construction
- Front seal plate assembly



Requires:

K-2974-K 1/2" Volume Control Valve

or

K-2977-K 3/4" Volume Control Valve

Part #	Mfg #	Description	Handle(s)	Finish	Price
091083	K-T16177-4-BN	Volume Control Trim	ADA Lever	*Brushed Nickel	
182975	K-T16177-4-BV	Volume Control Trim	ADA Lever	*Brushed Bronze	
101243	K-T16177-4-CP	Volume Control Trim	ADA Lever	Polished Chrome	
182976	K-T16177-4-PB	Volume Control Trim	ADA Lever	*Polished Brass	

Refinia® Transfer Valve Trim

- Brass construction
- Front seal plate assembly



Requires:

K-728-K 3/4" in-wall 2- or 3-way Transfer Valve

or

K-737-K 3/4" 2- or 3-way Diverter Valve

Part #	Mfg #	Description	Handle(s)	Finish	Price
141711	K-T5326-4-BN	Transfer Trim Only	ADA Lever	*Brushed Nickel	
141712	K-T5326-4-CP	Transfer Trim Only	ADA Lever	Polished Chrome	

Stance® Thermostatic Valve Trim

- Brass construction
- Front seal plate assembly



Requires:

K-2972-KS 1/2" Thermostatic Valve

or

K-2975-KS 3/4" Thermostatic Valve

Part #	Mfg #	Description	Handle(s)	Finish	Price
134407	K-T14781-4-BN	Thermostatic Trim Only	ADA Lever	*Brushed Nickel	
156015	K-T14781-4-CP	Thermostatic Trim Only	ADA Lever	Polished Chrome	

* Vibrant Limited Lifetime Warranty

www.plumbsupply.com • Serving our Customers Since 1946 • www.waterconcepts.net

Shower Faucets

Faucets & Valves

Stance® Volume Control Valve Trim

- Brass construction
- Front seal plate assembly



Requires:
K-2974-K 1/2" Volume Control Valve
or
K-2977-K 3/4" Volume Control Valve

Part #	Mfg #	Description	Handle(s)	Finish	Price
134410	K-T14782-4-BN	Volume Control Trim	ADA Lever	*Brushed Nickel	
156014	K-T14782-4-CP	Volume Control Trim	ADA Lever	Polished Chrome	

Stance® 3-Way Transfer Valve Trim

- Brass construction
- Front seal plate assembly



Requires:
K-728-K 3/4" in-wall 2- or 3-way Transfer Valve
or
K-737-K 3/4" 2- or 3-way Diverter Valve

Part #	Mfg #	Description	Handle(s)	Finish	Price
168293	K-T14783-4-BN	Transfer Trim Only	ADA Lever	*Brushed Nickel	
138431	K-T14783-4-CP	Transfer Trim Only	ADA Lever	Polished Chrome	

Stillness® Transfer Valve Trim

- Brass construction
- Front seal plate assembly



Requires:
K-728-K 3/4" in-wall 2- or 3-way Transfer Valve
or
K-737-K 3/4" 2- or 3-way Diverter Valve

Part #	Mfg #	Description	Handle(s)	Finish	Price
090240	K-T10944-4-BN	Transfer Trim Only	ADA Lever	*Brushed Nickel	
091099	K-T10944-4-CP	Transfer Trim Only	ADA Lever	Polished Chrome	

Toobi™ Transfer Valve Trim

- Brass construction
- Front seal plate assembly



Requires:
K-728-K 3/4" in-wall 2- or 3-way Transfer Valve
or
K-737-K 3/4" 2- or 3-way Diverter Valve

Part #	Mfg #	Description	Handle(s)	Finish	Price
159776	K-T8984-4-BN	Transfer Trim Only	ADA Lever	*Brushed Nickel	
148624	K-T8984-4-CP	Transfer Trim Only	ADA Lever	Polished Chrome	

* Vibrant Limited Lifetime Warranty

www.waterconcepts.net • Serving our Customers Since 1946 • www.plumbsupply.com

Shower Faucets

Shower Packages

Bancroft® Essentials Performance Shower Package

- Multi-Function showerhead and handheld shower
- Includes:
 - Handshower
 - Showerhead
 - Showerarm with diverter
 - Shower hose
 - Slidebar kit
 - RiteTemp® valve trim

Requires Valve: K-304-K/KS



Faucets & Valves

Part #	Mfg #	Description	Handle(s)	Finish	Price
159682	K-10828-4-BN	Shower Package	ADA Lever	*Brushed Nickel	
103996	K-10828-4-CP	Shower Package	ADA Lever	Polished Chrome	

Commercial Shower Faucets

Industrial Exposed Shower with Reversible Yoke

- Two-handle industrial exposed shower
- Solid brass construction for durability and reliability
- For 6" centers
- Four-arm handles
- Velvet® valves with brass valve bodies
- Adjustable showerhead delivers 2.5 gallons per minute spray
- Yoke reversible for either top or bottom supplies
- Wall-mount brackets



Part #	Mfg #	Description	Handle(s)	Finish	Price
155744	K-7254-CP	Industrial Exposed Shower with Showerhead	Cross	Polished Chrome	

* Vibrant Limited Lifetime Warranty

www.plumbsupply.com • Serving our Customers Since 1946 • www.waterconcepts.net

Shower Faucets

Shower Trim

Baliza® Tempassure Thermostatic Shower Trim

- Fits MultiChoice® universal rough-in valve
- Independent temperature and volume control
- H2Okinetic® spray technology
- 7- 1/8" Raincan showerhead
- 7" Showerarm
- WaterSense® certified: 2.0 gpm @ 80 psi



Part #	Mfg #	Description	Handle(s)	Finish	Price
141938	T60005-BN	Valve Trim Only	ADA Lever	Brushed Nickel*	
229566	T60005-BZ	Valve Trim Only	ADA Lever	Brushed Bronze*	
158927	T60005-PC	Valve Trim Only	ADA Lever	Chrome	
159400	T60005-PN	Valve Trim Only	ADA Lever	Polished Nickel*	
170978	T60005-RB	Valve Trim Only	ADA Lever	Venetian Bronze®	
175329	T60205-BN	Shower Trim Only	ADA Lever	Brushed Nickel*	
171318	T60205-BZ	Shower Trim Only	ADA Lever	Brushed Bronze*	
184104	T60205-PC	Shower Trim Only	ADA Lever	Chrome	
175472	T60205-PN	Shower Trim Only	ADA Lever	Polished Nickel*	
170960	T60205-RB	Shower Trim Only	ADA Lever	Venetian Bronze®	

Charlotte™ Tempassure® Thermostatic Shower Trim

- Fits MultiChoice® universal rough-in valve
- Independent temperature and volume control
- H2Okinetic® spray technology
- 5-13/16" Raincan showerhead
- 8" Shower arm and flange
- WaterSense® certified product: 2.0 gpm @ 80 psi



Part #	Mfg #	Description	Handle(s)	Finish	Price
168173	T60085-PC	Valve Trim Only	ADA Lever	Chrome	
147476	T60085-PNCO	Valve Trim Only	ADA Lever	Cocoa Bronze™/Pol Nickel	
180676	T60285-BN	Shower Trim Only	ADA Lever	Brushed Nickel*	
222919	T60285-PC	Shower Trim Only	ADA Lever	Chrome	
222841	T60285-PN	Shower Trim Only	ADA Lever	Polished Nickel*	
144793	T60285-PNCO	Shower Trim Only	ADA Lever	Cocoa Bronze™/Pol Nickel	

* Brilliance® Anti-Tarnish Lifetime Finishes

www.waterconcepts.net • Serving our Customers Since 1946 • www.plumbsupply.com

Shower Faucets

Loki™ Pressure Balance Shower Trim

- Fits MultiChoice® universal rough-in valve (R60000 Series)
- Temperature only controlled with handle
- 120° Maximum handle rotation
- Single function H2Okinetic® showerhead
- WaterSense® certified product: 2.0 gpm @ 80 psi



Part #	Mfg #	Description	Handle(s)	Finish	Price
180745	T60P220-BN	Shower Trim Only	ADA Lever	Brushed Nickel*	
185543	T60P220-PC	Shower Trim Only	ADA Lever	Chrome	

Odin™ Tempassure® Thermostatic Shower Trim

- Fits MultiChoice® universal rough-in valve
- Independent temperature and volume control
- H2Okinetic® spray technology
- 5-3/8" Raincan showerhead
- 16" Shower arm and flange
- WaterSense® certified product: 2.0 gpm @ 80 psi



Part #	Mfg #	Description	Handle(s)	Finish	Price
178515	T60075-BL	Valve Trim Only	ADA Lever	Matte Black	
160591	T60075-BN	Valve Trim Only	ADA Lever	Brushed Nickel*	
156844	T60075-PC	Valve Trim Only	ADA Lever	Chrome	
176991	T60275-BL	Shower Trim Only	ADA Lever	Matte Black	
160587	T60275-BN	Shower Trim Only	ADA Lever	Brushed Nickel*	
160051	T60275-PC	Shower Trim Only	ADA Lever	Chrome	

Providence™ Belle Pressure Balance Shower Trim

- Fits MultiChoice® universal rough-in valve
- H2Okinetic® spray technology
- Handle adjusts temperature
- 7-1/8" Raincan showerhead
- 7" Shower arm
- WaterSense® certified product: 2.0 gpm @ 80 psi



Part #	Mfg #	Description	Handle(s)	Finish	Price
160644	T60P210-BN	Shower Trim Only	ADA Lever	Brushed Nickel*	
157988	T60P210-PC	Shower Trim Only	ADA Lever	Chrome	
175144	T60P210-PN	Shower Trim Only	ADA Lever	Polished Nickel*	
177603	T60P210-RB	Shower Trim Only	ADA Lever	Venetian Bronze®	

* Brilliance® Anti-Tarnish Lifetime Finishes

www.plumbsupply.com • Serving our Customers Since 1946 • www.waterconcepts.net

Shower Faucets

Rook™ Tempassure® Thermostatic Shower Trim

- Fits Multichoice® universal rough-in valve
- H20kinetic® spray technology
- Handle adjusts temperature
- 8" Raincan showerhead
- 7" Shower arm
- WaterSense® certified product: 2.0 gpm @ 80 psi



Part #	Mfg #	Description	Handle(s)	Finish	Price
188967	T60061-PC	Valve Trim Only	ADA Lever	Chrome	
189245	T60061-RB	Valve Trim Only	ADA Lever	Venetian Bronze®	
227071	T60061-NK	Valve Trim Only	ADA Lever	Luxe Nickel*	
185779	T60261-NK	Shower Trim Only	ADA Lever	Luxe Nickel*	
188717	T60261-NKBL	Shower Trim Only	ADA Lever	Luxe Nickel /Matte Black*	
224444	T60261-PN	Shower Trim Only	ADA Lever	Polished Nickel*	
186084	T60261-RB	Shower Trim Only	ADA Lever	Venetian Bronze*	

RSVP® Tempassure® Shower Trim

- Fits Multichoice® universal rough-in valve
- Independent temperature and volume control
- 2-Function 5-7/8" x 3-7/8" raincan showerhead
- 6-3/4" Shower arm
- Flow rate: 2.5 gpm @ 80 psi



Part #	Mfg #	Description	Handle(s)	Finish	Price
119119	T60290-PC	Shower Trim Only	ADA Lever	Chrome	

Siderna® Tempassure® Thermostatic Shower Trim

- Fits MultiChoice® universal rough-in valve
- Independent temperature and volume control
- 8-5/8" Raincan showerhead
- 16" Shower arm and flange
- Flow rate: 2.5 gpm @ 80 psi



Part #	Mfg #	Description	Handle(s)	Finish	Price
162476	T60080-BL	Valve Trim Only	ADA Lever	Matte Black	
159079	T60080-BN	Valve Trim Only	ADA Lever	Brushed Nickel*	
141646	T60080-PC	Valve Trim Only	ADA Lever	Chrome	
162478	T60280-BL	Shower Trim Only	ADA Lever	Matte Black	
162592	T60280-BN	Shower Trim Only	ADA Lever	Brushed Nickel*	
143847	T60280-PC	Shower Trim Only	ADA Lever	Chrome	

* Brilliance® Anti-Tarnish Lifetime Finishes

www.waterconcepts.net • Serving our Customers Since 1946 • www.plumbsupply.com

Shower Faucets

Sotria® TempAssure® Thermostatic Shower Trim

- Fits MultiChoice® universal rough-in valve
- H2Okynamic® spray technology
- Handle adjusts temperature
- WaterSense® certified product: 2.0 gpm @ 80 psi



Part #	Mfg #	Description	Handle(s)	Finish	Price
177374	T60050-BL	Valve Trim Only	ADA Lever	Matte Black	
179626	T60050-NK	Valve Trim Only	ADA Lever	Luxe Nickel*	
177373	T60250-BL	Shower Trim Only	ADA Lever	Matte Black	
181331	T60250-NK	Shower Trim Only	ADA Lever	Luxe Nickel*	
184214	T60250-PC	Shower Trim Only	ADA Lever	Chrome	
179427	T60250-PN	Shower Trim Only	ADA Lever	Polished Nickel*	

Traditional Tempassure® Thermostatic Shower Trim

- Fits MultiChoice® universal rough-in valve
- Handle adjusts temperature
- Flow rate: 2.5 gpm @ 80 psi



Part #	Mfg #	Description	Handle(s)	Finish	Price
112067	T60010-RB	Valve Trim Only	ADA Lever	Venetian Bronze®	
126549	T60210-BN	Shower Trim Only	ADA Lever	Brushed Nickel*	
136997	T60210-PC	Shower Trim Only	ADA Lever	Chrome	
115185	T60210-PN	Shower Trim Only	ADA Lever	Polished Nickel*	
103912	T60210-RB	Shower Trim Only	ADA Lever	Venetian Bronze®	

Virage™ Tempassure® Thermostatic Shower Trim

- Single-function
- H2Okynamic® technology
- Lever volume control handle, temperature adjustment dial
- WaterSense® certified product: 2 gpm @ 80 psi
- Requires R60000-UNBX rough-in valve (sold separately)



Part #	Mfg #	Description	Handle(s)	Finish	Price
143198	T60030-BN	Valve Trim Only	ADA Lever	Brushed Nickel*	
149262	T60030-PC	Valve Trim Only	ADA Lever	Chrome	
137492	T60030-RB	Valve Trim Only	ADA Lever	Venetian Bronze®	
134891	T60230-BN	Shower Trim Only	ADA Lever	Brushed Nickel*	
132569	T60230-BZ	Shower Trim Only	ADA Lever	Brushed Bronze*	

* Brilliance® Anti-Tarnish Lifetime Finishes

www.plumbsupply.com • Serving our Customers Since 1946 • www.waterconcepts.net

Shower Faucets

Shower Trim (Continued)

Virage™ Tempassure® Thermostatic Shower Trim

Part #	Mfg #	Description	Handle(s)	Finish	Price
129975	T60230-PC	Shower Trim Only	ADA Lever	Chrome	
165830	T60230-PN	Shower Trim Only	ADA Lever	Polished Nickel*	
147684	T60230-RB	Shower Trim Only	ADA Lever	Venetian Bronze®	

Vesi® Tempassure® Thermostatic Shower Trim

- Fits MultiChoice® universal rough-in valve
- Lever volume control handle, temperature adjustment dial
- 3-Function shower head
- Flow Rate: 2.50 gpm @ 80 psi
- Requires R60000-UNBX rough-in valve (sold separately)



Part #	Mfg #	Description	Handle(s)	Finish	Price
104198	T60040-BN	Valve Trim Only	ADA Lever	Brushed Nickel*	
222654	T60040-RB	Valve Trim Only	ADA Lever	Venetian Bronze	
104149	T60240-BN	Shower Trim Only	ADA Lever	Brushed Nickel*	

Vesi Channel Pressure Balance Shower Trim

- Fits MultiChoice® universal rough-in valve
- Handle adjusts temperature
- Flow rate: 2.0 gpm



Part #	Mfg #	Description	Handle(s)	Finish	Price
183271	T60P240-BN	Shower Trim Only	ADA Lever	Brushed Nickel*	
189725	T60P240-BZ	Shower Trim Only	ADA Lever	Brushed Bronze*	

Diverter Shower Trim

Baliza Diverter Trim

- 2 Individual positions, 1 shared position
- 1/2" Universal inlets/outlets
- Cartridge ships with trim
- Requires rough-in valve R60700



Part #	Mfg #	Description	Handle(s)	Finish	Price
175330	T60805-BN	Diverter Trim, 3-Setting	ADA Lever	Brushed Nickel*	
171319	T60805-BZ	Diverter Trim, 3-Setting	ADA Lever	Brushed Bronze*	
173268	T60805-PC	Diverter Trim, 3-Setting	ADA Lever	Chrome	
186749	T60805-PN	Diverter Trim, 3-Setting	ADA Lever	Polished Nickel*	
217401	T60805-RB	Diverter Trim, 3-Setting	ADA Lever	Venetian Bronze®	

* Brilliance® Anti-Tarnish Lifetime Finishes

www.waterconcepts.net • Serving our Customers Since 1946 • www.plumbsupply.com

Shower Faucets

Charlotte™ Diverter Trim

- 2 Individual positions, 1 shared position (T60885)
- 3 Individual positions, 3 shared positions (T60985)
- 1/2" Universal inlets/outlets
- Cartridge ships with trim
- Requires rough-in valve R60700



Part #	Mfg #	Description	Handle(s)	Finish	Price
171232	T60885-PC	Diverter Trim, 3-Setting	ADA Lever	Chrome	
222842	T60885-PN	Diverter Trim, 3-Setting	ADA Lever	Polished Nickel*	
147475	T60885-PNCO	Diverter Trim, 3-Setting	ADA Lever	Cocoa Bronze™/Pol Nickel	
148741	T60985-PNCO	Diverter Trim, 6-Setting	ADA Lever	Cocoa Bronze™/Pol Nickel	

Odin™ Diverter Trim

- 2 Individual positions, 1 shared position (T60875)
- 3 Individual positions, 3 shared positions (T60975)
- 1/2" Universal inlets/outlets
- Cartridge ships with trim
- Requires rough-in valve R60700



Part #	Mfg #	Description	Handle(s)	Finish	Price
160589	T60875-BN	Diverter Trim, 3-Setting	ADA Lever	Brushed Nickel*	
157189	T60875-PC	Diverter Trim, 3-Setting	ADA Lever	Chrome	
166503	T60975-BN	Diverter Trim, 6-Setting	ADA Lever	Brushed Nickel*	
157994	T60975-PC	Diverter Trim, 6-Setting	ADA Lever	Chrome	

Rook™ Diverter Trim

- 2 individual positions, 1 shared position
- 1/2" Universal inlets/outlets
- Cartridge ships with trim
- Requires rough-in valve R60700



Part #	Mfg #	Description	Handle(s)	Finish	Price
185780	T60861-NK	Diverter Trim, 3-Setting	ADA Lever	Luxe Nickel*	
188968	T60861-PC	Diverter Trim, 3-Setting	ADA Lever	Chrome	
227116	T60961-NK	Diverter Trim, 6-Setting	ADA Lever	Luxe Nickel*	

RSVP Diverter Trim

- 2 Individual positions, 1 shared position (T60890)
- 3 Individual positions, 3 shared positions (T60990)
- 1/2" Universal inlets/outlets
- Cartridge ships with trim
- Requires rough-in valve R60700



Part #	Mfg #	Description	Handle(s)	Finish	Price
170276	T60890-BN	Diverter Trim, 3-Setting	ADA Lever	Brushed Nickel*	
141156	T60890-PC	Diverter Trim, 3-Setting	ADA Lever	Chrome	
177207	T60990-PC	Diverter Trim, 6-Setting	ADA Lever	Chrome	

* Brilliance® Anti-Tarnish Lifetime Finishes

www.plumbsupply.com • Serving our Customers Since 1946 • www.waterconcepts.net

Shower Faucets

Siderna® Diverter Trim

- 2 Individual positions, 1 shared position (T60880)
- 3 Individual positions, 3 shared positions (T60980)
- 1/2" Universal inlets/outlets
- Cartridge ships with trim
- Requires rough-in valve R60700



Part #	Mfg #	Description	Handle(s)	Finish	Price
188615	T60880-BL	Diverter Trim, 3-Setting	ADA Lever	Matte Black	
159080	T60880-BN	Diverter Trim, 3-Setting	ADA Lever	Brushed Nickel*	
141647	T60880-PC	Diverter Trim, 3-Setting	ADA Lever	Chrome	
162477	T60980-BL	Diverter Trim, 6-Setting	ADA Lever	Matte Black	
161830	T60980-BN	Diverter Trim, 6-Setting	ADA Lever	Brushed Nickel*	
143848	T60980-PC	Diverter Trim, 6-Setting	ADA Lever	Chrome	

Sotria Diverter Trim

- 2 Individual positions, 1 shared position (T60850)
- 1/2" Universal inlets/outlets
- Cartridge ships with trim
- Requires rough-in valve R60700



Part #	Mfg #	Description	Handle(s)	Finish	Price
177379	T60850-BL	Diverter Trim, 3-Setting	ADA Lever	Matte Black	
181332	T60850-NK	Diverter Trim, 3-Setting	ADA Lever	Luxe Nickel*	
184216	T60850-PC	Diverter Trim, 3-Setting	ADA Lever	Chrome	

Traditional Diverter Trim

- 2 Individual positions, 1 shared position (T60810)
- 3 Individual positions, 3 shared positions (T60910)
- 1/2" Universal inlets/outlets
- Cartridge ships with trim
- Requires rough-in valve R60700



Part #	Mfg #	Description	Handle(s)	Finish	Price
144967	T60810-BN	Diverter Trim, 3-Setting	ADA Lever	Brushed Nickel*	
155232	T60810-PC	Diverter Trim, 3-Setting	ADA Lever	Chrome	
175145	T60810-PN	Diverter Trim, 3-Setting	ADA Lever	Polished Nickel*	
147343	T60810-RB	Diverter Trim, 3-Setting	ADA Lever	Venetian Bronze®	
144968	T60910-BN	Diverter Trim, 6-Setting	ADA Lever	Brushed Nickel*	
155690	T60910-PC	Diverter Trim, 6-Setting	ADA Lever	Chrome	
150705	T60910-RB	Diverter Trim, 6-Setting	ADA Lever	Venetian Bronze®	

* Brilliance® Anti-Tarnish Lifetime Finishes

www.waterconcepts.net • Serving our Customers Since 1946 • www.plumbsupply.com

Shower Faucets

Vesi® Diverter Trim

- 2 Individual positions, 1 shared position (T60840)
- 3 Individual positions, 3 shared positions (T60940)
- 1/2" Universal inlets/outlets
- Cartridge ships with trim
- Requires rough-in valve R60700



Part #	Mfg #	Description	Handle(s)	Finish	Price
162436	T60840-BN	Diverter Trim, 3-Setting	ADA Lever	Brushed Nickel*	
162659	T60840-BZ	Diverter Trim, 3-Setting	ADA Lever	Brushed Bronze*	
164349	T60840-PC	Diverter Trim, 3-Setting	ADA Lever	Chrome	
222655	T60840-RB	Diverter Trim, 3-Setting	ADA Lever	Venetian Bronze	
159862	T60940-BN	Diverter Trim, 6-Setting	ADA Lever	Brushed Nickel*	

Virage Diverter Trim

- 2 Individual positions, 1 shared position (T60830)
- 3 Individual positions, 3 shared positions (T60930)
- 1/2" Universal inlets/outlets
- Cartridge ships with trim
- Requires rough-in valve R60700



Part #	Mfg #	Description	Handle(s)	Finish	Price
149845	T60830-BN	Diverter Trim, 3-Setting	ADA Lever	Brushed Nickel*	
158217	T60830-BZ	Diverter Trim, 3-Setting	ADA Lever	Brushed Bronze*	
149263	T60830-PC	Diverter Trim, 3-Setting	ADA Lever	Chrome	
165831	T60830-PN	Diverter Trim, 3-Setting	ADA Lever	Polished Nickel*	
173286	T60830-RB	Diverter Trim, 3-Setting	ADA Lever	Venetian Bronze®	
153333	T60930-BN	Diverter Trim, 6-Setting	ADA Lever	Brushed Nickel*	
163743	T60930-PC	Diverter Trim, 6-Setting	ADA Lever	Chrome	
159770	T60930-RB	Diverter Trim, 6-Setting	ADA Lever	Venetian Bronze®	

Thermostatic Valve Trim

Charlotte™ Sensori® Thermostatic Valve Trim

- Thermostatic cartridge ships with trim
- High temperature limit stop - 120°
- Requires rough-in valve R6600-WS



Part #	Mfg #	Description	Handle(s)	Finish	Price
155369	T66T085-BN	Thermostatic Trim	ADA Lever	Brushed Nickel*	
168177	T66T085-PC	Thermostatic Trim	ADA Lever	Chrome	

* Brilliance® Anti-Tarnish Lifetime Finishes

www.plumbsupply.com • Serving our Customers Since 1946 • www.waterconcepts.net

Shower Faucets

Faucets & Valves

Odin™ Sensori® Thermostatic Valve Trim

- Thermostatic cartridge ships with trim
- High temperature limit stop - 120°
- Requires rough-in valve R66000-WS



Part #	Mfg #	Description	Handle(s)	Finish	Price
223387	T66T075-BL	Thermostatic Trim	ADA Lever	Matte Black	
157192	T66T075-PC	Thermostatic Trim	ADA Lever	Chrome	

Rook™ Sensori® Thermostatic Valve Trim

- Thermostatic cartridge ships with trim
- High temperature limit stop - 120°
- Requires rough-in valve R66000-WS



Part #	Mfg #	Description	Handle(s)	Finish	Price
223091	T66T060-NKBL	Thermostatic Trim	ADA Lever	Luxe Nickel/Matte Blk*	
185521	T66T060-RB	Thermostatic Trim	ADA Lever	Venetian Bronze®	

Siderna® Thermostatic Valve Trim

- Thermostatic cartridge ships with trim
- High temperature limit stop - 120°
- Requires rough-in valve R66000-WS



Part #	Mfg #	Description	Handle(s)	Finish	Price
138961	T66T080-BN	Thermostatic Trim	ADA Lever	Brushed Nickel*	
158800	T66T080-PC	Thermostatic Trim	ADA Lever	Chrome	

Sotria™ Sensori® Thermostatic Valve Trim

- Thermostatic cartridge ships with trim
- High temperature limit stop - 120°
- Requires rough-in valve R6600-WS



Part #	Mfg #	Description	Handle(s)	Finish	Price
179653	T66T050-NK	Thermostatic Trim	ADA Lever	Luxe Nickel*	

Traditional Sensori® Thermostatic Valve Trim

- Thermostatic cartridge ships with trim
- High temperature limit stop - 120°
- Requires rough-in valve R66000-WS



Part #	Mfg #	Description	Handle(s)	Finish	Price
181110	T66T036-BN	Thermostatic Trim	ADA Lever	Brushed Nickel*	

* Brilliance® Anti-Tarnish Lifetime Finishes

www.waterconcepts.net • Serving our Customers Since 1946 • www.plumbsupply.com

Shower Faucets

Thermostatic Valve Trim (Continued) Traditional Sensori® Thermostatic Valve Trim

Part #	Mfg #	Description	Handle(s)	Finish	Price
145726	T66T036-PC	Thermostatic Trim	ADA Lever	Chrome	
128361	T66T036-RB	Thermostatic Trim	ADA Lever	Venetian Bronze®	
148360	T66T038-BN	Thermostatic Trim	ADA Cross	Brushed Nickel*	
165675	T66T038-PC	Thermostatic Trim	ADA Cross	Chrome	

Vesi Sensori® Thermostatic Valve Trim

- Thermostatic cartridge ships with trim
- High temperature limit stop - 120°
- Requires rough-in valve R66000-WS



Part #	Mfg #	Description	Handle(s)	Finish	Price
189721	T66T040-BZ	Thermostatic Trim	ADA Lever	Brushed Bronze*	

Virage Sensori® Thermostatic Valve Trim

- Thermostatic cartridge ships with trim
- High temperature limit stop - 120°
- Requires rough-in valve R66000-WS



Part #	Mfg #	Description	Handle(s)	Finish	Price
148047	T66T030-BN	Thermostatic Trim	ADA Lever	Brushed Nickel*	
146531	T66T030-PC	Thermostatic Trim	ADA Lever	Chrome	
170002	T66T030-PN	Thermostatic Trim	ADA Lever	Polished Nickel*	
148035	T66T030-RB	Thermostatic Trim	ADA Lever	Venetian Bronze®	

Volume Control Trim

Charlotte™ Volume Control Trim

- Recommended working pressure 45-60 psi
- Requires rough-in valve R66600



Part #	Mfg #	Description	Handle(s)	Finish	Price
155370	T66685-BN	Volume Control Trim	ADA Lever	Brushed Nickel*	
168175	T66685-PC	Volume Control Trim	ADA Lever	Chrome	

Odin™ Sensori® Volume Control Trim

- Recommended working pressure 45-60 psi
- Requires rough-in valve R66600



Part #	Mfg #	Description	Handle(s)	Finish	Price
223388	T66675-BL	Volume Control Trim	ADA Lever	Matte Black	
157193	T66675-PC	Volume Control Trim	ADA Lever	Chrome	

* Brilliance® Anti-Tarnish Lifetime Finishes

www.plumbsupply.com • Serving our Customers Since 1946 • www.waterconcepts.net

Shower Faucets

Rook™ Sensori® Volume Control Trim

- Recommended working pressure 45-80 psi
- Requires rough-in valve R66600



Part #	Mfg #	Description	Handle(s)	Finish	Price
223098	T66660-NKBL	Volume Control Trim	ADA Lever	Luxe Nkl/Matte Blk	
185522	T66660-RB	Volume Control Trim	ADA Lever	Venetian Bronze®	

Siderna® Sensori® Volume Control Trim

- Recommended working pressure 45-60 psi
- Requires rough-in valve R66000
- Flush mount installation

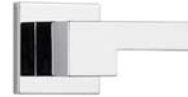

Part #	Mfg #	Description	Handle(s)	Finish	Price
138962	T66680-BN	Volume Control Trim	ADA Lever	Brushed Nickel*	
166851	T66680-PC	Volume Control Trim	ADA Lever	Chrome	

Traditional Sensori® Volume Control Trim

- Recommended working pressure of 45-80 psi
- Requires rough-in valve R66600



Part #	Mfg #	Description	Handle(s)	Finish	Price
181111	T66636-BN	Volume Control Trim	ADA Lever	Brushed Nickel*	
145727	T66636-PC	Volume Control Trim	ADA Lever	Chrome	
128362	T66636-RB	Volume Control Trim	ADA Lever	Venetian Bronze®	
148362	T66638-BN	Volume Control Trim	ADA Cross	Brushed Nickel*	
146429	T66638-BZ	Volume Control Trim	ADA Cross	Brushed Bronze*	
165676	T66638-PC	Volume Control Trim	ADA Cross	Chrome	
145233	T66638-RB	Volume Control Trim	ADA Cross	Venetian Bronze®	

Vesi Sensori® Volume Control Trim

- Recommended working pressure of 45-80 psi
- Requires rough-in valve R66600



Part #	Mfg #	Description	Handle(s)	Finish	Price
189722	T66640-BZ	Volume Control Trim	ADA Lever	Brushed Bronze*	

Virage Sensori® Volume Control Trim

- Recommended working pressure of 45-80 psi
- Requires rough-in valve R66600



Part #	Mfg #	Description	Handle(s)	Finish	Price
148046	T66630-BN	Volume Control Trim	ADA Lever	Brushed Nickel*	
146532	T66630-PC	Volume Control Trim	ADA Lever	Chrome	
170003	T66630-PN	Volume Control Trim	ADA Lever	Polished Nickel*	
148036	T66630-RB	Volume Control Trim	ADA Lever	Venetian Bronze®	

* Brilliance® Anti-Tarnish Lifetime Finishes

www.waterconcepts.net • Serving our Customers Since 1946 • www.plumbsupply.com

Shower Faucets

Monitor® 13 Series Shower Trim Classic Monitor® 13 Series 1-Hdl Shower Trim

- Fits MultiChoice™ universal valve
- Includes cartridge
- Handle adjusts temperature
- Touch-Clean® showerhead
- Sweat onto 1/2" CWT or thread onto 1/2" IPS
- WaterSense® certified product: 2.0 gpm @ 80 psi
- (H2O Model) 1.5 gpm @ 80 psi



H2O

Faucets & Valves

Part #	Mfg #	Description	Handle(s)	Finish	Price
092580	T13020	Valve Trim Only	ADA Lever	Chrome	
135846	T13020-SS	Valve Trim Only	ADA Lever	Stainless*	
164345	T13020-SSDPE	Valve Trim Only, 1" Deeper Escutcheon	ADA Lever	Stainless*	
092585	T13220	Shower Trim Only	ADA Lever	Chrome	
134430	T13220-SS	Shower Trim Only	ADA Lever	Stainless*	
092587	T13220-SHC	Shower Trim Only, 3-Function Showerhead	ADA Lever	Chrome	
092590	T13220-PBSHC	Shower Trim Only, 3-Function Showerhead	ADA Lever	Polished Brass*	
174001	T13220-SSSHC	Shower Trim Only, 3-Function Showerhead	ADA Lever	Stainless*	
092630	T13222	Shower Trim Only	Clear Knob	Chrome	
124988	T13220-H2OT	Shower Trim Only, 1.5 gpm H2O Showerhead	ADA Lever	Chrome	
135315	T13220-SSH2OT	Shower Trim Only, 1.5 gpm H2O Showerhead	ADA Lever	Stainless*	

Foundations® Core-B Monitor® 13 Series 1-Hdl Shower Trim

- Fits MultiChoice® universal valve
- Single-function pressure balance cartridge
- Handle adjusts temperature
- Full body spray showerhead
- WaterSense® certified product: 2.0 gpm @ 80 psi



Part #	Mfg #	Description	Handle(s)	Finish	Price
135543	BT13010	Valve Trim Only	ADA Lever	Chrome	
139743	BT13010-SS	Valve Trim Only	ADA Lever	Stainless	
133788	BT13210	Shower Trim Only	ADA Lever	Chrome	
139319	BT13210-SS	Shower Trim Only	ADA Lever	Stainless*	

* Brilliance® Anti-Tarnish Lifetime Finishes

www.plumbsupply.com • Serving our Customers Since 1946 • www.waterconcepts.net

Shower Faucets

Faucets & Valves

Monitor® 13 Series Commercial 1-Hdl Shower Trim

- Fits MultiChoice® universal valve
- Single-function pressure balance cartridge
- Handle adjusts temperature
- Red/blue indicator
- Touch-Clean® showerhead
- WaterSense® certified product: 2.0 gpm @ 80 psi



Part #	Mfg #	Description	Handle(s)	Finish	Price
107820	T13091	Valve Trim Only	ADA Lever	Chrome	
123152	T13291	Shower Trim Only	ADA Lever	Chrome	
161746	T13291-LHD	Shower Trim Only, Less Showerhead	ADA Lever	Chrome	
188227	T13291-SSLHD	Shower Trim Only, Less Showerhead	ADA Lever	Stainless*	

Monitor® 14 Series Shower Trim

Addison™ Monitor® 14 Series 1-Hdl Shower Trim

- Fits MultiChoice® universal valve
- Single-function pressure balance cartridge
- Handle adjusts temperature
- H2Okinetic® 6" showerhead
- Self-cleaning H2Okinetic® spray holes
- WaterSense® certified product: 2.0 gpm @ 80 psi



Part #	Mfg #	Description	Handle(s)	Finish	Price
131864	T14092	Valve Trim Only	ADA Lever	Chrome	
137944	T14092-CZ	Valve Trim Only	ADA Lever	Champagne Bronze™	
125982	T14092-RB	Valve Trim Only	ADA Lever	Venetian Bronze®	
127961	T14092-SS	Valve Trim Only	ADA Lever	Stainless*	
129077	T14292	Shower Trim Only	ADA Lever	Chrome	
125981	T14292-RB	Shower Trim Only	ADA Lever	Venetian Bronze®	
128708	T14292-SS	Shower Trim Only	ADA Lever	Stainless*	
174473	T14292-LHD	Shower Trim Only, Less Showerhead	ADA Lever	Chrome	

Ara™ Monitor® 14 Series 1-Hdl Shower Trim

- Fits MultiChoice® universal valve
- Single-function pressure balance cartridge
- Handle adjusts temperature
- H2Okinetic™ 6" showerhead
- Self-cleaning H2Okinetic® spray holes
- WaterSense® certified product: 2.0 gpm @ 80 psi



Part #	Mfg #	Description	Handle(s)	Finish	Price
164422	T14067	Valve Trim Only	ADA Lever	Chrome	
168012	T14067-SS	Valve Trim Only	ADA Lever	Stainless*	
166432	T14267	Shower Trim Only	ADA Lever	Chrome	
168011	T14267-SS	Shower Trim Only	ADA Lever	Stainless*	
177014	T14267-LHD	Shower Trim Only, Less Showerhead	ADA lever	Chrome	

* Brilliance® Anti-Tarnish Lifetime Finishes

www.waterconcepts.net • Serving our Customers Since 1946 • www.plumbsupply.com

Shower Faucets

Monitor® 14 Series Shower Trim (Continued)

Ara™ Monitor® 14 Series 1-Hdl Shower Trim

Part #	Mfg #	Description	Handle(s)	Finish	Price
176237	T14267-SSLHD	Shower Trim Only, Less Showerhead	ADA lever	Stainless*	

Arzo® Monitor® 14 Series 1-Hdl Shower Trim

- Fits MultiChoice® universal valve
- Includes cartridge
- H2Okinetic® technology
- Touch-Clean® showerhead
- Handle adjusts temperature
- Hot/cold indicators
- WaterSense® certified product: 2.0 gpm @ 80 psi



Part #	Mfg #	Description	Handle(s)	Finish	Price
110900	T14086-SS	Valve Trim Only	ADA Lever	Stainless*	
110915	T14286	Shower Trim Only	ADA Lever	Chrome	
110916	T14286-SS	Shower Trim Only	ADA Lever	Stainless*	

Ashlyn® Monitor® 14 Series 1-Hdl Shower Trim

- Fits MultiChoice® universal valve
- Single-function pressure balance cartridge
- Red/blue pad print indicators on handle
- Handle adjusts temperature
- Touch-Clean® 5-1/4" raincan showerhead
- WaterSense® certified product: 2.0gpm @ 80 psi



Part #	Mfg #	Description	Handle(s)	Finish	Price
173181	T14064	Valve Trim Only	ADA Lever	Chrome	
170994	T14064-RB	Valve Trim Only	ADA Lever	Venetian Bronze®	
170947	T14064-SS	Valve Trim Only	ADA Lever	Stainless*	
172336	T14264	Shower Trim Only	ADA Lever	Chrome	
172037	T14264-RB	Shower Trim Only	ADA Lever	Venetian Bronze®	
171218	T14264-SS	Shower Trim Only	ADA Lever	Stainless*	
188131	T14264-LHD	Shower Trim Only, Less Showerhead	ADA Lever	Chrome	
189847	T14264-RBLHD	Shower Trim Only, Less Showerhead	ADA Lever	Venetian Bronze®	
173742	T14264-SSLHD	Shower Trim Only, Less Showerhead	ADA Lever	Stainless*	

* Brilliance® Anti-Tarnish Lifetime Finishes

www.plumbsupply.com • Serving our Customers Since 1946 • www.waterconcepts.net

Shower Faucets

Faucets & Valves

Cassidy™ Monitor® 14 Series Shower Trim

- Fits MultiChoice® universal valve
- Single-function pressure balance cartridge
- H2Okinetic® technology 8" showerhead
- Self-cleaning H2Okinetic® spray holes
- Handle adjusts temperature
- WaterSense® certified product: 2.0 gpm @ 80 psi



Part #	Mfg #	Description	Handle(s)	Finish	Price
156283	T14097-CZLHP	Valve Trim Only	Less Handle	Champagne Bronze™	
151513	T14097-LHP	Valve Trim Only	Less Handle	Chrome	
171600	T14097-PNLHP	Valve Trim Only	Less Handle	Polished Nickel*	
156726	T14097-RBLHP	Valve Trim Only	Less Handle	Venetian Bronze®	
152713	T14097-SSLHP	Valve Trim Only	Less Handle	Stainless*	
165487	T14297-CZLHP	Shower Trim Only	Less Handle	Champagne Bronze™	
151993	T14297-LHP	Shower Trim Only	Less Handle	Chrome	
159383	T14297-PNLHP	Shower Trim Only	Less Handle	Polished Nickel*	
152945	T14297-RBLHP	Shower Trim Only	Less Handle	Venetian Bronze®	
153496	T14297-SSLHP	Shower Trim Only	Less Handle	Stainless*	
172022	T14297-LHP-LHD	Shower Trim Only, Less Showerhead	Less Handle	Chrome	
168815	T14297-SSLHP-LH	Shower Trim Only, Less Showerhead	Less Handle	Stainless*	

Compel® Monitor® 14 Series 1-Hdl Shower Trim

- Fits MultiChoice® universal valve
- Single-function pressure balance cartridge
- Red/blue pad print escutcheon
- H2Okinetic® 5-1/2" raincan showerhead
- Self-cleaning H2Okinetic® spray holes
- Handle adjusts temperature
- WaterSense® certified product: 2.0 gpm @ 80 psi



Part #	Mfg #	Description	Handle(s)	Finish	Price
156842	T14061	Valve Trim Only	ADA Lever	Chrome	
156905	T14061-SS	Valve Trim Only	ADA Lever	Stainless*	
150798	T14261	Shower Trim Only	ADA Lever	Chrome	
156713	T14261-SS	Shower Trim Only	ADA Lever	Stainless*	
161015	T14261-LHD	Shower Trim Only, Less Showerhead	ADA Lever	Chrome	
168470	T14261-SSLHD	Shower Trim Only, Less Showerhead	ADA Lever	Stainless*	

* Brilliance® Anti-Tarnish Lifetime Finishes

www.waterconcepts.net • Serving our Customers Since 1946 • www.plumbsupply.com

Shower Faucets

Dryden™ Monitor® 14 Series 1-Hdl Shower Trim

- Fits MultiChoice® universal valve
- Single-function pressure balance cartridge
- Handle adjusts temperature
- Touch-Clean® showerhead



H2O Showerhead

Part #	Mfg #	Description	Handle(s)	Finish	Price
116638	T14051	Valve Trim Only	ADA Lever	Chrome	
179988	T14051-CZ	Valve Trim Only	ADA Lever	Champagne Bronze™	
117059	T14051-RB	Valve Trim Only	ADA Lever	Venetian Bronze®	
117060	T14051-SS	Valve Trim Only	ADA Lever	Stainless*	
116295	T14251	Shower Trim Only, 2.5 gpm	ADA Lever	Chrome	
143553	T14251-CZ	Shower Trim Only, 2.5 gpm	ADA Lever	Champagne Bronze™	
116298	T14251-SS	Shower Trim Only, 2.5 gpm	ADA Lever	Stainless*	
116297	T14251-RB	Shower Trim Only, 2.5 gpm	ADA Lever	Venetian Bronze®	
175350	T14251-LHD	Shower Trim Only, Less Showerhead	ADA Lever	Chrome	
152868	T14251-H2O	Shower Trim Only, 2.0 gpm, H2OKinetic®	ADA Lever	Chrome	
166103	T14251-RBH2O	Shower Trim Only, 2.0 gpm, H2OKinetic®	ADA Lever	Venetian Bronze®	
155827	T14251-SSH2O	Shower Trim Only, 2.0 gpm, H2OKinetic®	ADA Lever	Stainless*	

Lahara® Monitor® 14 Series 1-Hdl Shower Trim

- Fits MultiChoice® universal valve
- Single-function pressure balance cartridge
- Handle adjusts temperature
- Touch-Clean® full body showerhead
- 120° Maximum handle rotation
- WaterSense® certified product: 2.0 gpm @ 80 psi



Part #	Mfg #	Description	Handle(s)	Finish	Price
119196	T14038	Valve Trim Only	ADA Lever	Chrome	
112180	T14038-RB	Valve Trim Only	ADA Lever	Venetian Bronze®	
113294	T14038-SS	Valve Trim Only	ADA Lever	Stainless*	
110980	T14238	Shower Trim Only	ADA Lever	Chrome	
110982	T14238-RB	Shower Trim Only	ADA Lever	Venetian Bronze®	
110984	T14238-SS	Shower Trim Only	ADA Lever	Stainless*	
128933	T14238-SSH2O	Shower Trim Only, H2OKinetic® Showerhead	ADA Lever	Stainless*	
171222	T14238-LHD	Shower Trim Only, Less Showerhead	ADA Lever	Chrome	
170049	T14238-SSLHD	Shower Trim Only, Less Showerhead	ADA Lever	Stainless*	

* Brilliance® Anti-Tarnish Lifetime Finishes

www.plumbsupply.com • Serving our Customers Since 1946 • www.waterconcepts.net

Shower Faucets

Faucets & Valves

Leland® Monitor® 14 Series 1-Hdl Shower Trim

- Fits MultiChoice® universal valve
- Single function pressure balance cartridge
- Handle adjusts temperature
- Hot/cold indicator
- Touch-Clean 3-setting showerhead
- WaterSense® certified product: 2.0 gpm @ 80 psi



Part #	Mfg #	Description	Handle(s)	Finish	Price
181158	T14278RBSHCCE R	Shower Trim Only	ADA Lever	Venetian Bronze®	
164970	T14278SSSHCCR	Shower Trim Only	ADA Lever	Stainless*	

Linden™ Monitor® 14 Series Scald-Guard® 1-Hdl Shower Trim

- Fits MultiChoice® universal valve
- Single-function pressure balance cartridge
- Handle adjusts temperature
- Hot/cold indicators
- Red/blue pad print escutcheon (LHD model)
- Touch-Clean® showerhead
- Maximum flow rate: 2.5 gpm @ 80 psi
- WaterSense® certified product: 2.0 gpm @ 80 psi (H2O Model)



Part #	Mfg #	Description	Handle(s)	Finish	Price
144225	T14094	Valve Trim Only	ADA Lever	Chrome	
156704	T14094-CZ	Valve Trim Only	ADA Lever	Champagne Bronze™	
144328	T14094-RB	Valve Trim Only	ADA Lever	Venetian Bronze®	
144144	T14094-SS	Valve Trim Only	ADA Lever	Stainless*	
190196	T14293	Shower Trim Only	ADA Lever	Chrome	
222401	T14293-RB	Shower Trim Only	ADA Lever	Venetian Bronze®	
223872	T14293-SS	Shower Trim Only	ADA Lever	Stainless*	
144715	T14294	Shower Trim Only	ADA Lever	Chrome	
145524	T14294-CZ	Shower Trim Only	ADA Lever	Champagne Bronze™	
143566	T14294-RB	Shower Trim Only	ADA Lever	Venetian Bronze®	
143754	T14294-SS	Shower Trim Only	ADA Lever	Stainless*	
186870	T14294-LHD	Shower Trim Only, Less Showerhead	ADA Lever	Chrome	
154143	T14294-H2O	Shower Trim Only, H2Okynamic® Showerhead	ADA Lever	Chrome	
147541	T14294-RBH2O	Shower Trim Only, H2Okynamic® Showerhead	ADA Lever	Stainless*	

* Brilliance® Anti-Tarnish Lifetime Finishes

www.waterconcepts.net • Serving our Customers Since 1946 • www.plumbsupply.com

Shower Faucets

Trinsic® Monitor 14 Series 1-Hdl Shower Trim

- Fits MultiChoice® universal valve
- Single-function pressure balance cartridge
- Red/blue pad print escutcheon
- Handle adjusts temperature
- H2Okinetic® water-efficient 5-1/2" showerhead
- Self-cleaning H2Okinetic® spray holes
- WaterSense® certified product: 2.0 gpm @ 80 psi



Part #	Mfg #	Description	Handle(s)	Finish	Price
153077	T14059	Valve Trim Only	ADA Lever	Chrome	
153078	T14059-CZ	Valve Trim Only	ADA Lever	Champagne Bronze™	
153079	T14059-RB	Valve Trim Only	ADA Lever	Venetian Bronze®	
153080	T14059-SS	Valve Trim Only	ADA Lever	Stainless*	
153081	T14259	Shower Trim Only	ADA Lever	Chrome	
153082	T14259-CZ	Shower Trim Only	ADA Lever	Champagne Bronze™	
153083	T14259-RB	Shower Trim Only	ADA Lever	Venetian Bronze®	
153084	T14259-SS	Shower Trim Only	ADA Lever	Stainless*	
159917	T17259-LHD	Shower Trim Only, Less Showerhead	ADA Lever	Chrome	
174516	T14259-SSLHD	Shower Trim Only, Less Showerhead	ADA Lever	Stainless*	

Tesla® Monitor 14 Series Shower Trim

- Fits MultiChoice® universal valve
- Single-function pressure balance cartridge
- Handle adjusts temperature
- Red/blue indicators
- H2Okinetic® 3-setting showerhead
- Self-cleaning H2Okinetic® spray holes
- WaterSense® certified product: 2.0 gpm @ 80 psi



Part #	Mfg #	Description	Handle(s)	Finish	Price
189289	T14052-SS	Valve Trim Only	ADA Lever	Stainless*	
189240	T14252	Shower Trim Only	ADA Lever	Chrome	
183780	T14252-SS	Shower Trim Only	ADA Lever	Stainless*	
189163	T14252-SSLHD	Shower Trim Only, Less Showerhead	ADA Lever	Stainless*	

Vero Monitor® 14 Series 1-Hdl Shower Trim

- For use with MultiChoice® universal rough valve body
- Single-function pressure balance cartridge
- Handle adjusts temperature
- Touch-Clean® 8-5/8" showerhead
- H2Okinetic® 6" showerhead (with H2O model)
- Maximum flow rate: 2.5 gpm @ 80 psi
- WaterSense® certified product: 2.0 gpm @ 80 psi (with H2O model)



Part #	Mfg #	Description	Handle(s)	Finish	Price
134775	T14053	Valve Trim Only	ADA Lever	Chrome	
179911	T14053-CZ	Valve Trim Only	ADA Lever	Champagne Bronze™	

* Brilliance® Anti-Tarnish Lifetime Finishes

www.plumbsupply.com • Serving our Customers Since 1946 • www.waterconcepts.net

Shower Faucets

Monitor® 14 Series Shower Trim (Continued)

Vero Monitor® 14 Series 1-Hdl Shower Trim

Part #	Mfg #	Description	Handle(s)	Finish	Price
134776	T14053-SS	Valve Trim Only	ADA Lever	Stainless*	
151387	T14053-RB	Valve Trim Only	ADA Lever	Venetian Bronze®	
134777	T14253	Shower Trim Only	ADA Lever	Chrome	
173121	T14253-CZ	Shower Trim Only	ADA Lever	Champagne Bronze™	
141895	T14253-H2O	Shower Trim Only	ADA Lever	Chrome	
158653	T14253-RB	Shower Trim Only	ADA Lever	Venetian Bronze®	
134778	T14253-SS	Shower Trim Only	ADA Lever	Stainless*	
173348	T14253-LHD	Shower Trim Only, Less Showerhead	ADA Lever	Chrome	
150722	T14253-RBH2O	Shower Trim Only, H2Okinetic®	ADA Lever	Venetian Bronze®	
144346	T14253-SSH2O	Shower Trim Only, H2Okinetic®	ADA Lever	Stainless*	

Victorian Monitor® 14 Series 1-Hdl Shower Trim

- Fits MultiChoice® universal valve
- Single-function pressure balance cartridge
- Handle adjusts temperature (sold separately)
- Touch-Clean® 3-setting showerhead
- Flow rate: 2.5 gpm @ 80 psi
- WaterSense® certified product: 1.5 gpm @ 80 psi (H2O Model)



Part #	Mfg #	Description	Handle(s)	Finish	Price
112082	T14055-RBLHP	Valve Trim Only	Less Handle	Venetian Bronze®	
111600	T14055-SSLHP	Valve Trim Only	Less Handle	Stainless*	
092737	T14255-LHP	Shower Trim Only	Less Handle	Chrome	
092743	T14255-RBLHP	Shower Trim Only	Less Handle	Venetian Bronze®	
092744	T14255-SSLHP	Shower Trim Only	Less Handle	Stainless*	
152757	T14255-H2OLHP	Shower Trim Only, H2Okinetic®	Less Handle	Chrome	

Windemere® Monitor® 14 1-Hdl Shower Trim

- Fits MultiChoice® universal valve
- Single-function pressure balance cartridge
- Handle adjusts temperature
- Full body 6" showerhead
- WaterSense® certified product: 2.0 gpm @ 80 psi



Part #	Mfg #	Description	Handle(s)	Finish	Price
157497	BT14096	Valve Trim Only	ADA Lever	Chrome	
143873	BT14096-OB	Valve Trim Only	ADA Lever	Oil Rubbed Bronze	
136144	BT14096-SS	Valve Trim Only	ADA Lever	Stainless*	
135569	BT14296	Shower Trim Only	ADA Lever	Chrome	

* Brilliance® Anti-Tarnish Lifetime Finishes

www.waterconcepts.net • Serving our Customers Since 1946 • www.plumbsupply.com

Shower Faucets

Monitor® 14 Series Shower Trim (Continued)

Windemere® Monitor® 14 1-Hdl Shower Trim

Part #	Mfg #	Description	Handle(s)	Finish	Price
131931	BT14296-OB	Shower Trim Only	ADA Lever	Oil Rubbed Bronze	
135495	BT14296-SS	Shower Trim Only	ADA Lever	Stainless*	

Monitor® 17 Series Shower Trim

Addison™ Monitor® 17 Series Shower Trim

- Fits MultiChoice® universal valve
- Dual function pressure balance cartridge
- dial adjusts temperature, handle adjusts volume
- H2Okynamic® 6" showerhead
- Self-cleaning H2Okynamic® spray holes
- WaterSense® certified product: 2.0 gpm @ 80 psi



Part #	Mfg #	Description	Handle(s)	Finish	Price
132428	T17092	Valve Trim Only	ADA Lever	Chrome	
137601	T17092-CZ	Valve Trim Only	ADA Lever	Champagne Bronze™	
130313	T17092-RB	Valve Trim Only	ADA Lever	Venetian Bronze®	
132985	T17092-SS	Valve Trim Only	ADA Lever	Stainless*	
128353	T17292	Shower Trim Only	ADA Lever	Chrome	
126708	T17292-RB	Shower Trim Only	ADA Lever	Venetian Bronze®	
128434	T17292-SS	Shower Trim Only	ADA Lever	Stainless*	

Ara™ Monitor® 17 Series Shower Trim

- Fits MultiChoice® universal valve
- Dual-function pressure balance cartridge
- Red/blue indicator
- Handle adjusts volume, dial adjusts temperature
- H2Okynamic® 6" showerhead
- Self-cleaning H2Okynamic® spray holes
- WaterSense® certified product: 2.0 gpm @ 80 psi



Part #	Mfg #	Description	Handle(s)	Finish	Price
165656	T17067	Valve Trim Only	ADA Lever	Chrome	
162243	T17067-SS	Valve Trim Only	ADA Lever	Stainless*	
171860	T17267	Shower Trim Only	ADA Lever	Chrome	
162249	T17267-SS	Shower Trim Only	ADA Lever	Stainless*	

* Brilliance® Anti-Tarnish Lifetime Finishes

www.plumbsupply.com • Serving our Customers Since 1946 • www.waterconcepts.net

Shower Faucets

Faucets & Valves

Ashlyn™ Monitor® 17 Series Shower Trim

- Fits MulticChoice® universal valve
- Dual-function pressure balance cartridge
- Red/blue pad print indicators
- Handle adjusts temperature, dial adjusts volume
- Touch-Clean® 5-1/4" showerhead
- WaterSense® certified product: 2.0 gpm @ 80 psi



Part #	Mfg #	Description	Handle(s)	Finish	Price
177023	T17064	Valve Trim Only	ADA Lever	Chrome	
222400	T17064-RB	Valve Trim Only	ADA Lever	Venetian Bronze®	
174314	T17064-SS	Valve Trim Only	ADA Lever	Stainless*	
174058	T17264	Shower Trim Only	ADA Lever	Chrome	
170921	T17264-SS	Shower Trim Only	ADA Lever	Stainless*	
178390	T17264-RB	Shower Trim Only	ADA Lever	Venetian Bronze®	

Ashlyn™ Monitor 17 Series Shower Trim with In2ition Showerhead

- Fits MulticChoice® universal valve
- Dual-function pressure balance cartridge
- In2ition integrated showerhead and handshower
- Handle adjusts temperature, dial adjusts volume
- Features Touch-Clean® spray holes
- 5-Setting handshower
- Soft-Touch® grip
- 69" Long UltraFlex® hose
- WaterSense® certified product: 2.0 gpm @ 80 psi



Part #	Mfg #	Description	Handle(s)	Finish	Price
173063	T17264-I	Shower Trim Only, In2ition Showerhead	ADA Lever	Chrome	
171775	T17264-RB-I	Shower Trim Only, In2ition Showerhead	ADA Lever	Venetian Bronze®	
172466	T17264-SS-I	Shower Trim Only, In2ition Showerhead	ADA Lever	Stainless*	

Cassidy™ Monitor® 17 Series Shower Trim

- Fits MultiChoice® universal valve
- Dual-function pressure balance cartridge
- Handle adjusts volume, dial adjusts temperature
- H2Okinetic 8" showerhead
- Self-cleaning H2Okinetic® spray holes
- WaterSense® certified product: 2.0 gpm @ 80 psi



Part #	Mfg #	Description	Handle(s)	Finish	Price
151516	T17097	Valve Trim Only	ADA Lever	Chrome	
168312	T17097-CZ	Valve Trim Only	ADA Lever	Champagne Bronze™	
176412	T17097-PN	Valve Trim Only	ADA Lever	Polished Nickel*	
151960	T17097-RB	Valve Trim Only	ADA Lever	Venetian Bronze®	

* Brilliance® Anti-Tarnish Lifetime Finishes

www.waterconcepts.net • Serving our Customers Since 1946 • www.plumbsupply.com

Shower Faucets

Monitor® 17 Series Shower Trim (Continued)

Cassidy™ Monitor® 17 Series Shower Trim

Part #	Mfg #	Description	Handle(s)	Finish	Price
153889	T17097-SS	Valve Trim Only	ADA Lever	Stainless*	
151997	T17297	Shower Trim Only	ADA Lever	Chrome	
156180	T17297-CZ	Shower Trim Only	ADA Lever	Champagne Bronze™	
153326	T17297-PN	Shower Trim Only	ADA Lever	Polished Nickel	
150950	T17297-RB	Shower Trim Only	ADA Lever	Venetian Bronze®	
151767	T17297-SS	Shower Trim Only	ADA Lever	Stainless*	

Classic Monitor® 17 Series Shower Trim

- Fits MultiChoice® universal valve
- Dual-function pressure balance cartridge
- Red/blue indicator
- Handle adjusts volume, dial adjusts temperature
- Touch-Clean® 3-setting showerhead
- H2Okinetic® 6" showerhead with self-cleaning spray holes (H2O Model)
- WaterSense® certified product: 2.0 gpm @ 80 psi



Faucets & Valves

Part #	Mfg #	Description	Handle(s)	Finish	Price
092708	T17230	Shower Trim Only	ADA Lever	Chrome	
155275	T17230-SS	Shower Trim Only	ADA Lever	Stainless*	
153773	T17230-H2O	Shower Trim Only, H2O Showerhead	ADA Lever	Chrome	
171300	T17230-SSH2O	Shower Trim Only, H2O Showerhead	ADA Lever	Stainless*	

Compel™ Monitor 17 Series Shower Trim

- Fits MultiChoice® universal valve
- Dual-function pressure balance cartridge
- Red/blue indicator
- Handle adjusts volume, dial adjusts temperature
- H2Okinetic® 5-1/2" showerhead with self-cleaning spray holes
- WaterSense® certified product: 2.0 gpm @ 80 psi



Part #	Mfg #	Description	Handle(s)	Finish	Price
162531	T17061	Valve Trim Only	ADA Lever	Chrome	
156708	T17061-SS	Valve Trim Only	ADA Lever	Stainless*	
153741	T17261	Shower Trim Only	ADA Lever	Chrome	
158118	T17261-SS	Shower Trim Only	ADA Lever	Stainless*	

* Brilliance® Anti-Tarnish Lifetime Finishes

www.plumbsupply.com • Serving our Customers Since 1946 • www.waterconcepts.net

Shower Faucets

Faucets & Valves

Dryden™ Monitor® 17 Series Shower Trim

- Fits MultiChoice® universal valve
- Handle adjusts volume, dial adjusts temperature
- Touch-Clean® 6-9/16" showerhead
- H2Okinetic® 6" showerhead and self-cleaning spray holes (H2O model)
- Flow rate: 2.5 gpm @ 80 psi
- WaterSense® certified product: 2.0 gpm @ 80 psi (H2O model)



H2O

Part #	Mfg #	Description	Handle(s)	Finish	Price
117061	T17051	Valve Trim Only	ADA Lever	Chrome	
143503	T17051-CZ	Valve Trim Only	ADA Lever	Champagne Bronze™	
224891	T17051-PN	Valve Trim Only	ADA Lever	Polished Nickel*	
117197	T17051-RB	Valve Trim Only	ADA Lever	Venetian Bronze®	
117198	T17051-SS	Valve Trim Only	ADA Lever	Stainless*	
116303	T17251	Shower Trim Only	ADA Lever	Chrome	
159269	T17251-CZ	Shower Trim Only	ADA Lever	Champagne Bronze™	
175029	T17251-PN	Shower Trim Only	ADA Lever	Polished Nickel*	
116305	T17251-RB	Shower Trim Only	ADA Lever	Venetian Bronze®	
116306	T17251-SS	Shower Trim Only	ADA Lever	Stainless*	
167373	T17251-H2O	Shower Trim Only, H2Okinetic® Showerhead	ADA Lever	Chrome	
166665	T17251-CZH2O	Shower Trim Only, H2Okinetic® Showerhead	ADA Lever	Champagne Bronze™	
226636	T17251-PNH2O	Shower Trim Only, H2Okinetic® Showerhead	ADA Lever	Polished Nickel*	
139209	T17251-RBH2O	Shower Trim Only, H2Okinetic® Showerhead	ADA Lever	Venetian Bronze®	
154022	T17251-SSH2O	Shower Trim Only, H2Okinetic® Showerhead	ADA Lever	Stainless*	

Lahara™ Monitor® 17 Series Shower Trim with Volume Control

- Fits MultiChoice® universal valve
- Dual-function pressure balance cartridge
- Handle adjusts temperature, dial adjusts temperature
- Touch-Clean® 5" showerhead
- H2Okinetic® 6-1/2" showerhead with self-cleaning spray holes (H2O model)
- Maximum flow rate: 2.5 gpm @ 80 psi
- WaterSense® certified product: 2.0 gpm @ 80 psi (H2O model)



H2O

Part #	Mfg #	Description	Handle(s)	Finish	Price
110990	T17038	Valve Trim Only	ADA Lever	Chrome	
155805	T17038-CZ	Valve Trim Only	ADA Lever	Champagne Bronze™	
110994	T17038-RB	Valve Trim Only	ADA Lever	Venetian Bronze®	
110996	T17038-SS	Valve Trim Only	ADA Lever	Stainless*	
110997	T17238	Shower Trim Only	ADA Lever	Chrome	
154977	T17238-CZ	Shower Trim Only	ADA Lever	Champagne Bronze™	
110999	T17238-RB	Shower Trim Only	ADA Lever	Venetian Bronze®	
111001	T17238-SS	Shower Trim Only	ADA Lever	Stainless*	
154842	T17238-H2O	Shower Trim Only, H2Okinetic® Showerhead	ADA Lever	Chrome	

* Brilliance® Anti-Tarnish Lifetime Finishes

www.waterconcepts.net • Serving our Customers Since 1946 • www.plumbsupply.com

Shower Faucets

Monitor® 17 Series Shower Trim (Continued)

Lahara™ Monitor® 17 Series Shower Trim with Volume Control

Part #	Mfg #	Description	Handle(s)	Finish	Price
168070	T17238-RBH2O	Shower Trim Only, H2Okinetic® Showerhead	ADA Lever	Venetian Bronze®	
153667	T17238-SSH2O	Shower Trim Only, H2Okinetic® Showerhead	ADA Lever	Stainless*	

Linden™ Monitor® 17 Series Shower Trim

- Fits MultiChoice® universal valve
- Dual-function pressure balance cartridge
- Handle adjusts volume, dial adjusts temperature
- H2Okinetic® 6-1/2" showerhead
- Self-cleaning H2Okinetic® spray holes
- WaterSense® certified product: 2.0 gpm @ 80 psi



Part #	Mfg #	Description	Handle(s)	Finish	Price
225780	T17093	Valve Trim Only	ADA Lever	Chrome	
226461	T17093-SS	Valve Trim Only	ADA Lever	Stainless*	
144338	T17094	Valve Trim Only	ADA Lever	Chrome	
144581	T17094-CZ	Valve Trim Only	ADA Lever	Champagne Bronze™	
143323	T17094-RB	Valve Trim Only	ADA Lever	Venetian Bronze®	
143642	T17094-SS	Valve Trim Only	ADA Lever	Stainless*	
225564	T17293	Shower Trim Only	ADA Lever	Chrome	
226552	T17293-RB	Shower Trim Only	ADA Lever	Venetian Bronze®	
146278	T17294	Shower Trim Only	ADA Lever	Chrome	
144730	T17294-CZ	Shower Trim Only	ADA Lever	Champagne Bronze™	
143330	T17294-RB	Shower Trim Only	ADA Lever	Venetian Bronze®	
143886	T17294-SS	Shower Trim Only	ADA Lever	Stainless*	

Linden™ Monitor® 17 Series Shower Trim with In2ition® Two-in-One Shower

- Fits MultiChoice® universal valve
- Dual function pressure balance control
- Handle adjusts volume; dial adjusts temperature
- 4-Setting, In2ition® integrated showerhead and handshower
- Features Touch-Clean® spray holes
- 69" Long UltraFlex® hose
- WaterSense® certified product: 2.0 gpm @ 80 psi



Part #	Mfg #	Description	Handle(s)	Finish	Price
227569	T17293-I	Shower Trim Only, In2ition Showerhead	ADA lever	Chrome	
143815	T17294-I	Shower Trim Only, In2ition Showerhead	ADA Lever	Chrome	
147449	T17294-CZ-I	Shower Trim Only, In2ition Showerhead	ADA Lever	Champagne Bronze™	

* Brilliance® Anti-Tarnish Lifetime Finishes

www.plumbsupply.com • Serving our Customers Since 1946 • www.waterconcepts.net

Faucets & Valves

Shower Faucets

Faucets & Valves

Monitor® 17 Series Shower Trim (Continued)

Linden™ Monitor® 17 Series Shower Trim with In2ition® Two-in-One Shower

Part #	Mfg #	Description	Handle(s)	Finish	Price
143310	T17294-RB-I	Shower Trim Only, In2ition Showerhead	ADA Lever	Venetian Bronze®	
143530	T17294-SS-I	Shower Trim Only, In2ition Showerhead	ADA Lever	Stainless*	

Tesla® Monitor 17 Series H2Okinetic® Shower Trim

- Fits MultiChoice® universal valve
- Dual-function pressure balance cartridge
- Red/blue indicators
- Handle adjust volume, dial adjusts temperature
- H2Okinetic® 3-Setting 7-1/2" showerhead
- Self-cleaning H2Okinetic® spray holes
- WaterSense® certified product: 2.0 gpm @ 80 psi



Part #	Mfg #	Description	Handle(s)	Finish	Price
184955	T17052	Valve Trim Only	ADA Lever	Chrome	
229491	T17052-PN	Valve Trim Only	ADA Lever	Polished Nickel	
185037	T17252	Shower Trim Only, H2O Showerhead	ADA Lever	Chrome	
182299	T17252-PN	Shower Trim Only, H2O Showerhead	ADA Lever	Polished Nickel*	
181116	T17252-SS	Shower Trim Only, H2O Showerhead	ADA Lever	Stainless*	

Trinsic® Monitor® 17 Series Shower Trim

- Fits MultiChoice® universal valve
- Dual-function pressure balance cartridge
- Red/blue indicator
- Handle adjusts volume, dial adjusts temperature
- H2Okinetic® 5-1/2" showerhead
- Self-cleaning H2Okinetic® spray holes
- Watersense® certified product: 2.0 gpm @ 80 psi



Part #	Mfg #	Description	Handle(s)	Finish	Price
155074	T17059	Valve Trim Only	ADA Lever	Chrome	
181859	T17059-CZ	Valve Trim Only	ADA Lever	Champagne Bronze™	
166174	T17059-RB	Valve Trim Only	ADA Lever	Venetian Bronze®	
160095	T17059-SS	Valve Trim Only	ADA Lever	Stainless*	
151410	T17259	Shower Trim Only	ADA Lever	Chrome	
181860	T17259-CZ	Shower Trim Only	ADA Lever	Champagne Bronze™	
173511	T17259-RB	Shower Trim Only	ADA Lever	Venetian Bronze®	
156457	T17259-SS	Shower Trim Only	ADA Lever	Stainless*	
187858	T17259-SSLHD	Shower Trim Only, Less Showerhead	ADA Lever	Stainless*	

* Brilliance® Anti-Tarnish Lifetime Finishes

www.waterconcepts.net • Serving our Customers Since 1946 • www.plumbsupply.com

Shower Faucets

Vero Monitor® 17 Series Shower Trim

- Fits MultiChoice® universal valve
- Dual-function pressure balance cartridge
- Hot/cold indicator(s)
- Handle adjusts volume, dial adjusts temperature
- Touch-Clean® 8-5/8" showerhead
- H2Okinetic® 6" showerhead and self-cleaning spray holes (H2O model)
- Maximum flow rate: 2.5 gpm @ 80 psi
- WaterSense® certified product: 2.0 gpm @ 80 psi (H2O model)



-H2O

Part #	Mfg #	Description	Handle(s)	Finish	Price
137211	T17053	Valve Trim Only, 2.5 gpm Full Body Spray	ADA Lever	Chrome	
146148	T17053-RB	Valve Trim Only, 2.5 gpm Full Body Spray	ADA Lever	Venetian Bronze®	
137152	T17053-SS	Valve Trim Only, 2.5 gpm Full Body Spray	ADA Lever	Stainless*	
137210	T17253	Shower Trim Only, 2.5 gpm Full Body Spray	ADA Lever	Chrome	
171284	T17253-CZ	Shower Trim Only, 2.5 gpm Full Body Spray	ADA Lever	Champagne Bronze™	
146666	T17253-RB	Shower Trim Only, 2.5 gpm Full Body Spray	ADA Lever	Venetian Bronze®	
137153	T17253-SS	Shower Trim Only, 2.5 gpm Full Body Spray	ADA Lever	Stainless*	
137234	T17253-H2O	Shower Trim Only, 2.0 gpm H2Okinetic Spray	ADA Lever	Chrome	
143243	T17253-CZH2O	Shower Trim Only, 2.0 gpm H2Okinetic Spray	ADA Lever	Champagne Bronze™	
153196	T17253-RBH2O	Shower Trim Only, 2.0 gpm H2Okinetic Spray	ADA Lever	Venetian Bronze®	
140802	T17253-SSH2O	Shower Trim Only, 2.0 gpm H2Okinetic Spray	ADA Lever	Stainless*	

Victorian® Monitor® 17 Series Shower Trim with Volume Control

- Fits MultiChoice™ universal valve
- Dual-function pressure balance cartridge
- Handle adjusts volume, dial adjusts temperature
- Hot/cold indicator
- Touch-Clean® 3-setting showerhead
- H2Okinetic® 8" showerhead and self-cleaning spray holes (H2O model)
- Maximum flow rate: 2.5 gpm @ 80 psi
- WaterSense® certified product: 2.0 gpm @ 80 psi (H2O model)



H2O

Part #	Mfg #	Description	Handle(s)	Finish	Price
092841	T17255	Shower Trim Only	ADA Lever	Chrome	
150528	T17255-CZ	Shower Trim Only	ADA Lever	Champagne Bronze™	
092845	T17255-PB	Shower Trim Only	ADA Lever	Polished Brass	
092847	T17255-RB	Shower Trim Only	ADA Lever	Venetian Bronze®	
092848	T17255-SS	Shower Trim Only	ADA Lever	Stainless*	
154563	T17255-H2O	Shower Trim Only, H2O Showerhead	ADA Lever	Chrome	
173150	T17255-RBH2O	Shower Trim Only, H2O Showerhead	ADA Lever	Venetian Bronze®	

* Brilliance® Anti-Tarnish Lifetime Finishes

www.plumbsupply.com • Serving our Customers Since 1946 • www.waterconcepts.net

Shower Faucets

Faucets & Valves

TempAssure® 17T Series Shower Trim

Addison® TempAssure® 17T Series Shower Trim

- Fits MultiChoice® universal valve
- Dual-function thermostatic cartridge
- Handle adjusts volume, dial adjusts temperature
- H2Okinetic® 8" showerhead
- Self-cleaning H2Okinetic® spray holes
- Requires R10000-UNBX rough-in valve, order separately
- Maximum flow rate: 2.5 gpm @ 80 psi



Part #	Mfg #	Description	Handle(s)	Finish	Price
127658	T17T092	Valve Trim Only	ADA Lever	Chrome	
139580	T17T092-CZ	Valve Trim Only	ADA Lever	Champagne Bronze™	
128750	T17T092-RB	Valve Trim Only	ADA Lever	Venetian Bronze®	
129782	T17T092-SS	Valve Trim Only	ADA Lever	Stainless*	
128480	T17T292	Shower Trim Only	ADA Lever	Chrome	
140634	T17T292-CZ	Shower Trim Only	ADA Lever	Champagne Bronze™	
130664	T17T292-RB	Shower Trim Only	ADA Lever	Venetian Bronze®	
128782	T17T292-SS	Shower Trim Only	ADA Lever	Stainless*	

Ara® TempAssure® 17T Series Shower Trim

- Fits MultiChoice® universal valve
- Dual-function thermostatic cartridge
- Red/blue indicator
- Handle adjusts volume, dial adjusts temperature
- H2Okinetic® 6" showerhead
- Self-cleaning H2Okinetic® spray holes
- WaterSense® certified product: 2.0 gpm @ 80 psi



Part #	Mfg #	Description	Handle(s)	Finish	Price
186420	T17T067-SS	Valve Trim Only	ADA Lever	Stainless*	
166359	T17T267	Shower Trim Only	ADA Lever	Chrome	
177472	T17T267-SS	Shower Trim Only	ADA Lever	Stainless*	

Cassidy™ TempAssure® 17T Series Shower Trim

- Fits MultiChoice® universal valve
- Dual-function thermostatic valve cartridge
- Hot/cold indicator
- Handle adjusts volume, dial adjusts temperature
- Touch-Clean® 9-3/8" full body showerhead
- Maximum flow rate: 2.5 gpm @ 80 psi



Part #	Mfg #	Description	Handle(s)	Finish	Price
170886	T17T097	Valve Trim Only	ADA Lever	Chrome	
159730	T17T097-RB	Valve Trim Only	ADA Lever	Venetian Bronze®	
166399	T17T097-SS	Valve Trim Only	ADA Lever	Stainless*	
164875	T17T297	Shower Trim Only	ADA Lever	Chrome	

* Brilliance® Anti-Tarnish Lifetime Finishes

www.waterconcepts.net • Serving our Customers Since 1946 • www.plumbsupply.com

Shower Faucets

TempAssure® 17T Series Shower Trim (Continued)

Cassidy™ TempAssure® 17T Series Shower Trim

Part #	Mfg #	Description	Handle(s)	Finish	Price
180466	T17T297-CZ	Shower Trim Only	ADA Lever	Champagne Bronze™	
164759	T17T297-PN	Shower Trim Only	ADA Lever	Polished Nickel*	
151568	T17T297-RB	Shower Trim Only	ADA Lever	Venetian Bronze®	
151699	T17T297-SS	Shower Trim Only	ADA Lever	Stainless*	

Compel® TempAssure® 17T Series Shower Trim

- Fits MultiChoice® universal valve
- Dual-function thermostatic cartridge
- Red/blue indicator
- Handle adjusts volume, dial adjusts temperature
- H2Okinetic® 7-3/4" 3-setting showerhead
- Self-cleaning H2Okinetic® spray holes
- WaterSense® certified product: 2.0 gpm @ 80 psi



Part #	Mfg #	Description	Handle(s)	Finish	Price
186507	T17T261-H2O	Shower Trim Only	ADA Lever	Chrome	
180260	T17T261-SSH2O	Shower Trim Only	ADA Lever	Stainless*	

Dryden™ TempAssure® 17T Series Shower Trim

- Fits MultiChoice® universal valve
- Dual-function thermostatic cartridge
- Handle adjusts volume, dial adjusts temperature
- Hot/cold indicator(s)
- Touch-Clean® 6-9/16" full body showerhead
- Maximum flow rate: 2.5 gpm @ 80 psi



Part #	Mfg #	Description	Handle(s)	Finish	Price
117199	T17T051	Valve Trim Only	ADA Lever	Chrome	
117201	T17T051-RB	Valve Trim Only	ADA Lever	Venetian Bronze®	
117202	T17T051-SS	Valve Trim Only	ADA Lever	Stainless*	
117029	T17T251	Shower Trim Only	ADA Lever	Chrome	
152695	T17T251-CZ	Shower Trim Only	ADA Lever	Champagne Bronze™	
117027	T17T251-RB	Shower Trim Only	ADA Lever	Venetian Bronze®	
117026	T17T251-SS	Shower Trim Only	ADA Lever	Stainless*	

* Brilliance® Anti-Tarnish Lifetime Finishes

www.plumbsupply.com • Serving our Customers Since 1946 • www.waterconcepts.net

Shower Faucets

Faucets & Valves

Lahara® TempAssure® 17T Series Shower Trim

- Fits MultiChoice® universal valve
- Dual-function thermostatic cartridge
- Handle adjusts volume, dial adjusts temperature
- Hot/cold indicator(s)
- Touch-Clean® 5" full body showerhead
- Maximum flow rate: 2.5 gpm @ 80 psi



Part #	Mfg #	Description	Handle(s)	Finish	Price
111006	T17T038	Valve Trim Only	ADA Lever	Chrome	
111008	T17T038-RB	Valve Trim Only	ADA Lever	Venetian Bronze®	
111009	T17T038-SS	Valve Trim Only	ADA Lever	Stainless*	
111010	T17T238	Shower Trim Only	ADA Lever	Chrome	
111014	T17T238-SS	Shower Trim Only	ADA Lever	Stainless*	

Angular Modern 14 Series Temp2O® Shower Trim

- Fits MultiChoice® universal valve
- Single-function pressure balance cartridge
- Temp2O® technology
- Digital temperature display with color indication
- Battery operated 3 (AAA) included
- Fahrenheit and Celsius options at install
- **Order handle separately (LHP)**
- Handle adjusts temperature



Part #	Mfg #	Description	Handle(s)	Finish	Price
227380	T14001-T20-LHP	Valve Only	Less Handle	Chrome	
173914	T14001-SST20-LH P	Valve Only	Less Handle	Stainless*	

Traditional 14 Series Temp2O® Shower Trim

- Fits MultiChoice® universal valve
- Single-function pressure balance cartridge
- Temp2O® technology
- Digital temperature display with color indication
- Battery operated 3 (AAA) included
- Fahrenheit and Celsius options at install
- **Order handle separately (LHP)**
- Handle adjusts temperature



Part #	Mfg #	Description	Handle(s)	Finish	Price
168735	T1400-RBT20-LH P	Valve Only	Less Handle	Venetian Bronze®	

* Brilliance® Anti-Tarnish Lifetime Finishes

www.waterconcepts.net • Serving our Customers Since 1946 • www.plumbsupply.com

Shower Faucets

Transitional 14 Series Temp2O® Shower Trim

- Fits MultiChoice® universal rough valve
- Single-function pressure balance cartridge
- Temp2O® technology
- Digital temperature display with color indication
- Battery operated, (3 AAA) included
- Fahrenheit and Celsius options at install
- **Order handle separately (LHP)**
- Handle adjusts temperature



Part #	Mfg #	Description	Handle(s)	Finish	Price
177446	T14003-SST20-LH P	Valve Trim Only	Less Handle	Stainless*	

Trinsic® TempAssure® 17T Series Shower Trim

- Fits MultiChoice® universal valve
- Dual-function thermostatic cartridge
- Handle adjusts volume, dial adjusts temperature
- Hot/cold indicator (s)
- H2OKinetic® 7-3/4" three-setting showerhead
- Self-cleaning H2OKinetic® spray holes
- Touch-Clean® spray holes
- Maximum flow rate: 2.0 gpm @ 80 psi



Part #	Mfg #	Description	Handle(s)	Finish	Price
180014	T17T059-RB	Valve Trim Only	ADA Lever	Venetian Bronze®	
182809	T17T059-SS	Valve Trim Only	ADA Lever	Stainless*	
182829	T17T259-H2O	Shower Trim Only	ADA Lever	Chrome	
187383	T17T259-CZH2O	Shower Trim Only	ADA Lever	Champagne Bronze™	
228810	T17T259-RBH2O	Shower Trim Only	ADA Lever	Venetian Bronze®	
187860	T17T259-SSH2O	Shower Trim Only	ADA Lever	Stainless*	

Vero® TempAssure® 17T Series Shower Trim

- Fits MultiChoice® universal valve
- Dual-function thermostatic cartridge
- Handle adjusts volume, dial adjusts temperature
- Hot/cold indicator
- Touch-Clean® 8-5/8" full body showerhead
- Maximum flow rate: 2.5 gpm @ 80 psi



Part #	Mfg #	Description	Handle(s)	Finish	Price
135645	T17T053	Valve Trim Only	ADA Lever	Chrome	
173609	T17T053-RB	Valve Trim Only	ADA Lever	Venetian Bronze®	
137128	T17T053-SS	Valve Trim Only	ADA Lever	Stainless*	
135493	T17T253	Shower Trim Only	ADA Lever	Chrome	
152031	T17T253-RB	Shower Trim Only	ADA Lever	Venetian Bronze®	
139460	T17T253-SS	Shower Trim Only	ADA Lever	Stainless*	

* Brilliance® Anti-Tarnish Lifetime Finishes

www.plumbsupply.com • Serving our Customers Since 1946 • www.waterconcepts.net

Shower Faucets

Faucets & Valves

Victorian® TempAssure® 17T Series Shower Trim

- Fits MultiChoice® universal valve
- Dual-function thermostatic cartridge
- Hot/cold indicator
- Handle adjusts volume, dial adjusts temperature
- Touch-Clean® 3-function showerhead
- Maximum flow rate: 2.5 gpm @ 80 psi



Part #	Mfg #	Description	Handle(s)	Finish	Price
161032	T17T055	Valve Trim Only	ADA Lever	Chrome	
145825	T17T055-CZ	Valve Trim Only	ADA Lever	Champagne Bronze™	
107863	T17T055-RB	Valve Trim Only	ADA Lever	Venetian Bronze®	
108537	T17T055-SS	Valve Trim Only	ADA Lever	Stainless*	
112665	T17T255	Shower Trim Only	ADA Lever	Chrome	
103631	T17T255-RB	Shower Trim Only	ADA Lever	Venetian Bronze®	
103033	T17T255-SS	Shower Trim Only	ADA Lever	Stainless*	

Custom Shower System Trim

Addison™ 1-Hdl Diverter Trim

- 3-Setting diverters have (2) individual positions, (1) shared position
- 6-Setting diverters have (3) individual positions, (3) shared positions
- Requires R11000 rough-in (sold separately)
- Includes cartridge



Part #	Mfg #	Description	Handle(s)	Finish	Price
140585	T11892	3-Setting 2-Port Diverter Only Trim	ADA Lever	Chrome	
143525	T11892-CZ	3-Setting 2-Port Diverter Only Trim	ADA Lever	Champagne Bronze™	
135362	T11892-RB	3-Setting 2-Port Diverter Only Trim	ADA Lever	Venetian Bronze®	
135399	T11892-SS	3-Setting 2-Port Diverter Only Trim	ADA Lever	Stainless*	
135017	T11992	6-Setting 3-Port Diverter Only Trim	ADA Lever	Chrome	
135018	T11992-CZ	6-Setting 2-Port Diverter Only Trim	ADA Lever	Champagne Bronze™	
135020	T11992-RB	6-Setting 3-Port Diverter Only Trim	ADA Lever	Venetian Bronze®	
135021	T11992-SS	6-Setting 3-Port Diverter Only Trim	ADA Lever	Stainless*	

Angular Modern Monitor® 17 Series Valve Trim with 3-Setting Integrated Diverter

- 3-Setting diverter trim
- 2-Handle trim with separate temperature dial
- Control volume and water temperature independently with two separate handles for more refined control of your shower experience
- Monitor® pressure balance valve keeps water temperature within a safe $\pm 3^{\circ} F$ ($\pm 1.6^{\circ} C$), helping to protect you from sudden changes in hot or cold water pressure



Requires Valve: R22000

Part #	Mfg #	Description	Handle(s)	Finish	Price
229899	T27867	3-Setting, Diverter Only Trim	ADA Lever	Chrome	

* Brilliance® Anti-Tarnish Lifetime Finishes

www.waterconcepts.net • Serving our Customers Since 1946 • www.plumbsupply.com

Shower Faucets

Ara® 1-Hdl Diverter Trim

- 3-Setting diverters have (2) individual positions, (1) shared position
- 6-Setting diverters have (3) individual positions, (3) shared positions
- Requires R11000 rough-in (sold separately)
- Includes cartridge



Part #	Mfg #	Description	Handle(s)	Finish	Price
170070	T11867	3-Setting 2-Port Diverter Only Trim	ADA Lever	Chrome	
162250	T11867-SS	3-Setting 2-Port Diverter Only Trim	ADA Lever	Stainless*	
176786	T11967	6-Setting 3-Port Diverter Only Trim	ADA Lever	Chrome	
162244	T11967-SS	6-Setting 3-Port Diverter Only Trim	ADA Lever	Stainless*	

Ashlyn™ 1-Hdl Diverter Trim

- 3-Setting diverters have (2) individual positions, (1) shared position
- 6-Setting diverters have (3) individual positions, (3) shared positions
- Requires R11000 rough-in (sold separately)
- Includes cartridge



Part #	Mfg #	Description	Handle(s)	Finish	Price
174456	T11864	3-Setting 2-Port Diverter Only Trim	ADA Lever	Chrome	
172342	T11864-RB	3-Setting 2-Port Diverter Only Trim	ADA Lever	Venetian Bronze®	
170527	T11864-SS	3-Setting 2-Port Diverter Only Trim	ADA Lever	Stainless*	
179974	T11964	6-Setting 3-Port Diverter Only Trim	ADA Lever	Chrome	
180610	T11964-RB	6-Setting 3-Port Diverter Only Trim	ADA Lever	Venetian Bronze®	
182917	T11964-SS	6-Setting 3-Port Diverter Only Trim	ADA Lever	Stainless*	

Cassidy™ 1-Hdl Diverter Trim

- **-LHP Less Handle Package**
- 1/2" Rough-in
- 3-Setting diverters have (2) individual positions, (1) shared positions
- 6-Setting diverters have (3) individual positions, (3) shared positions
- Diverter valve **R11000** required
- Includes cartridge



Part #	Mfg #	Description	Handle(s)	Finish	Price
168310	T11897-CZLHP	3-Setting 2-Port Diverter Only Trim	Less Handle	Champagne Bronze™	
152237	T11897-LHP	3-Setting 2-Port Diverter Only Trim	Less Handle	Chrome	
158845	T11897-PNLHP	3-Setting 2-Port Diverter Only Trim	Less Handle	Polished Nickel*	
150951	T11897-RBLHP	3-Setting 2-Port Diverter Only Trim	Less Handle	Venetian Bronze®	
151986	T11897-SSLHP	3-Setting 2-Port Diverter Only Trim	Less Handle	Stainless*	
185318	T11997-CZLHP	6-Setting 3-Port Diverter Only Trim	Less Handle	Champagne Bronze™	
163799	T11997-LHP	6-Setting 3-Port Diverter Only Trim	Less Handle	Chrome	
161954	T11997-PNLHP	6-Setting 3-Port Diverter Only Trim	Less Handle	Polished Nickel*	
156996	T11997-RBLHP	6-Setting 3-Port Diverter Only Trim	Less Handle	Venetian Bronze®	
151700	T11997-SSLHP	6-Setting 3-Port Diverter Only Trim	Less Handle	Stainless*	

* Brilliance® Anti-Tarnish Lifetime Finishes

www.plumbsupply.com • Serving our Customers Since 1946 • www.waterconcepts.net

Shower Faucets

Faucets & Valves

Compel® 1-Hdl Diverter Trim

- **-LHP Less Handle Package**
- 1/2" Rough-in
- 3-Setting diverters have (2) individual positions, (1) shared positions
- 6-Setting diverters have (3) individual positions, (3) shared positions
- Diverter valve **R11000** required
- Includes cartridge



Part #	Mfg #	Description	Handle(s)	Finish	Price
159271	T11861	3-Setting 2-Port Diverter Only Trim	ADA Lever	Chrome	
164427	T11861-SS	3-Setting 2-Port Diverter Only Trim	ADA Lever	Stainless*	
153742	T11961	6-Setting 3-Port Diverter Only Trim	ADA Lever	Chrome	
161981	T11961-SS	6-Setting 3-Port Diverter Only Trim	ADA Lever	Stainless*	

Dryden™ Collection 1-Hdl Multi-Function Diverter Trim

- Coordinates with all Delta Dryden™ bath suites
- 1/2" Rough-in
- 3-Setting diverters have (2) individual positions, (1) shared position
- 6-Setting diverters have (3) individual positions, (3) shared positions
- Requires R11000 rough-in (sold separately)
- Includes valve cartridge



Part #	Mfg #	Description	Handle(s)	Finish	Price
134758	T11851	3-Setting 2-Port Diverter Only Trim	ADA Lever	Chrome	
155249	T11851-CZ	3-Setting 2-Port Diverter Only Trim	ADA Lever	Champagne Bronze™	
175034	T11851-PN	3-Setting 2-Port Diverter Only Trim	ADA Lever	Polished Nickel*	
134759	T11851-RB	3-Setting 2-Port Diverter Only Trim	ADA Lever	Venetian Bronze®	
134760	T11851-SS	3-Setting 2-Port Diverter Only Trim	ADA Lever	Stainless*	
134762	T11951	6-Setting 3-Port Diverter Only Trim	ADA Lever	Chrome	
160832	T11951-CZ	6-Setting 3-Port Diverter Only Trim	ADA Lever	Champagne Bronze®	
175030	T11951-PN	6-Setting 3-Port Diverter Only Trim	ADA Lever	Polished Nickel*	
134763	T11951-RB	6-Setting 3-Port Diverter Only Trim	ADA Lever	Venetian Bronze®	
134764	T11951-SS	6-Setting 3-Port Diverter Only Trim	ADA Lever	Stainless*	

Innovations® Collection 1-Hdl Multi-Function Diverter Trim

- 3-Setting diverters have (2) individual positions, (1) shared position
- 6-Setting diverters have (3) individual positions, (3) shared positions
- Requires R11000 rough-in
- 1/2" Rough-in
- Includes cartridge



Part #	Mfg #	Description	Handle(s)	Finish	Price
134196	T11800	3-Setting 2-Port Diverter Only Trim	ADA Lever	Chrome	
154978	T11800-CZ	3-Setting 2-Port Diverter Only Trim	ADA Lever	Champagne Bronze™	
181893	T11800-PB	3-Setting 2-Port Diverter Only Trim	ADA Lever	Polished Brass*	
134548	T11800-RB	3-Setting 2-Port Diverter Only Trim	ADA Lever	Venetian Bronze®	
134024	T11800-SS	3-Setting 2-Port Diverter Only Trim	ADA Lever	Stainless*	
134674	T11900	6-Setting 3-Port Diverter Only Trim	ADA Lever	Chrome	

* Brilliance® Anti-Tarnish Lifetime Finishes

www.waterconcepts.net • Serving our Customers Since 1946 • www.plumbsupply.com

Shower Faucets

Custom Shower System Trim (Continued)

Innovations® Collection 1-Hdl Multi-Function Diverter Trim

Part #	Mfg #	Description	Handle(s)	Finish	Price
134309	T11900-RB	6-Setting 3-Port Diverter Only Trim	ADA Lever	Venetian Bronze®	
134673	T11900-SS	6-Setting 3-Port Diverter Only Trim	ADA Lever	Stainless*	

Linden™ 1-Hdl Diverter Trim

- 3-Setting diverters have (2) individual positions, (1) shared position
- 6-Setting diverters have (3) individual positions, (3) shared positions
- Requires R11000 rough-in (sold separately)
- Includes cartridge



Part #	Mfg #	Description	Handle(s)	Finish	Price
147744	T11894	3-Setting 2-Port Diverter Only Trim	ADA Lever	Chrome	
156705	T11894-CZ	3-Setting 2-Port Diverter Only Trim	ADA Lever	Champagne Bronze®	
143311	T11894-RB	3-Setting 2-Port Diverter Only Trim	ADA Lever	Venetian Bronze®	
143641	T11894-SS	3-Setting 2-Port Diverter Only Trim	ADA Lever	Stainless*	
144743	T11994	6-Setting 3-Port Diverter Only Trim	ADA Lever	Chrome	
154519	T11994-CZ	6-Setting 3-Port Diverter Only Trim	ADA Lever	Champagne Bronze™	
150877	T11994-SS	6-Setting 3-Port Diverter Only Trim	ADA Lever	Stainless*	
144744	T11994-RB	6-Setting 3-Port Diverter Only Trim	ADA Lever	Venetian Bronze®	

Tesla® 1-Hdl Diverter Trim

- 3-Setting diverters have (2) individual positions, (1) shared position
- 6-Setting diverters have (3) individual positions, (3) shared positions
- Requires R11000 rough-in (sold separately)
- Includes cartridge



Part #	Mfg #	Description	Handle(s)	Finish	Price
185039	T11852	3-Setting 2-Port Diverter Only Trim	ADA Lever	Chrome	
182336	T11852-PN	3-Setting 2-Port Diverter Only Trim	ADA Lever	Polished Nickel*	
182334	T11852-SS	3-Setting 2-Port Diverter Only Trim	ADA Lever	Stainless*	
188240	T11952	6-Setting 3-Port Diverter Only Trim	ADA Lever	Chrome	
224766	T11952-SS	6-Setting 3-Port Diverter Only Trim	ADA Lever	Stainless*	

* Brilliance® Anti-Tarnish Lifetime Finishes

www.plumbsupply.com • Serving our Customers Since 1946 • www.waterconcepts.net

Shower Faucets

Faucets & Valves

Traditional TempAssure® 17T Series Valve Trim with 3-Setting Integrated Diverter

- 3-Setting diverter has (2) individual positions, (1) shared position
- 2-handle trim with separate temperature dial
- Control volume and water temperature independently with two separate handles for more refined control of your shower experience
- TempAssure® Thermostatic cartridge measures and monitors the temperature of the water and automatically adjusts to maintain a more precise water temperature



Requires Valve: R22000

Part #	Mfg #	Description	Handle(s)	Finish	Price
226548	T27T897-SS	17T TempAssure w/ 3-Setting Diverter	ADA Lever	Stainless*	

Traditional Monitor® 14 Series Valve Trim with 3-Setting Integrated Diverter

- 3-Setting diverter has (2) individual positions, (1) shared position
- 2-Handle trim
- Monitor® pressure balance valve keeps water temperature within a safe $\pm 3^{\circ} F$ ($\pm 1.6^{\circ} C$), helping to protect you from sudden changes in hot or cold water pressure



Requires Valve R22000

Part #	Mfg #	Description	Handle(s)	Finish	Price
228598	T24897-SS	Monitor14 w/ 3-Setting Integrated Diverter	ADA Lever	Stainless*	

Trinsic® 1-Hdl Diverter Trim

- 3-Setting diverters have (2) individual positions, (1) shared position
- 6-Setting diverters have (3) individual positions, (3) shared positions
- Requires R11000 rough-in (sold separately)
- RP75137 adds 1" to max installation thickness
- Includes cartridge



Part #	Mfg #	Description	Handle(s)	Finish	Price
153351	T11859	3-Setting 2-Port Diverter Only Trim	ADA Lever	Chrome	
226888	T11859-CZ	3-Setting 2-Port Diverter Only Trim	ADA Lever	Champagne Bronze™	
158184	T11859-RB	3-Setting 2-Port Diverter Only Trim	ADA Lever	Venetian Bronze®	
160744	T11859-SS	3-Setting 2-Port Diverter Only Trim	ADA Lever	Stainless*	
166065	T11959	6-Setting 3-Port Diverter Only Trim	ADA Lever	Chrome	
173970	T11959-RB	6-Setting 3-Port Diverter Only Trim	ADA Lever	Venetian Bronze®	
167669	T11959-SS	6-Setting 3-Port Diverter Only Trim	ADA Lever	Stainless*	

* Brilliance® Anti-Tarnish Lifetime Finishes

www.waterconcepts.net • Serving our Customers Since 1946 • www.plumbsupply.com

Shower Faucets

Vero® 1-Handle Diverter Trim

- Coordinates with all Delta Vero® styled bath suites
- 1/2" Rough-in
- 3-Setting diverters have (2) individual positions, (1) shared position
- 6-Setting diverters have (3) individual positions, (3) shared positions
- Includes valve cartridge
- For use with R11000 diverter rough-in (sold separately)



Part #	Mfg #	Description	Handle(s)	Finish	Price
135494	T11853	3-Setting 2-Port Diverter Only Trim	ADA Lever	Chrome	
171286	T11853-CZ	3-Setting 2-Port Diverter Only Trim	ADA Lever	Champagne Bronze™	
146150	T11853-RB	3-Setting 2-Port Diverter Only Trim	ADA Lever	Venetian Bronze®	
135821	T11853-SS	3-Setting 2-Port Diverter Only Trim	ADA Lever	Stainless*	
138700	T11953	6-Setting 3-Port Diverter Only Trim	ADA Lever	Chrome	
147408	T11953-RB	6-Setting 3-Port Diverter Only Trim	ADA Lever	Venetian Bronze®	
137130	T11953-SS	6-Setting 3-Port Diverter Only Trim	ADA Lever	Stainless*	

Victorian® 1-Hdl Multi-Function Diverter Trim

- Coordinates with all Delta Victorian® bath suites
- 1/2" Rough-in
- 3-Setting diverters have (2) individual positions, (1) shared position
- 6-Setting diverters have (3) individual positions, (3) shared positions
- Requires R11000 rough-in (sold separately)



Part #	Mfg #	Description	Handle(s)	Finish	Price
134752	T11855-RB	3-Setting 2-Port Diverter Only Trim	ADA Lever	Venetian Bronze®	
146408	T11855-CZ	3-Setting 2-Port Diverter Only Trim	ADA Lever	Champagne Bronze™	
134755	T11955	3-Setting 2-Port Diverter Only Trim	ADA Lever	Chrome	
134756	T11955-RB	6-Setting 3-Port Diverter Only Trim	ADA Lever	Venetian Bronze®	

XO Jetted Module Diverter Trim

- Must order R18000-XO rough valve separately
- MultiChoice® rough valve and R1827-XO
- H2Okinetic™ jets rotate 30°
- (3) individual positions, (3) shared positions
- Each jet flows at .75 gpm @ 60 psi
- Total unit flows at 2.5 gpm @ 80 psi



Part #	Mfg #	Description	Handle(s)	Finish	Price
153144	T18017-XO	2 H2Okinetic™ Body Sprays	Lever	Chrome	
156558	T18017-RBXO	2 H2Okinetic™ Body Sprays	Lever	Venetian Bronze®	
153665	T18017-SSXO	2 H2Okinetic™ Body Sprays	Lever	Stainless*	
142737	T18037-XO	2 H2Okinetic™ Body Sprays	Lever	Chrome	

* Brilliance® Anti-Tarnish Lifetime Finishes

www.plumbsupply.com • Serving our Customers Since 1946 • www.waterconcepts.net

Shower Faucets

Faucets & Valves

Commercial MultiChoice™ Universal Valve Trim
Commercial Teck™ ADA 1-Hdl Shower Trim

- Fits MultiChoice® universal valve
- Red/blue label on escutcheon
- Vacuum breaker
- ADA compliant, adjustable handshower slide or showerhead with arm and flange
- Vandal-resistant blade handle
- Handle adjusts temperature
- Back-to-back capability
- 1/2" Universal inlets/outlets
- Male threads with stops; please select valve with screwdriver stops



Part #	Mfg #	Description	Handle(s)	Finish	Price
138721	T13H132	Shower Trim Only, 1.5 gpm	ADA Lever	Chrome	
135549	T13H152	Shower Only, Handshower 24" SS Grab Bar 70"HoseADA Lever		Chrome/White	
095261	T13H153	Shower Only, 24" Grab Bar, 70" Vinyl Hose, 2.5 gpm ADA Lever Blade		Chrome	

* Brilliance® Anti-Tarnish Lifetime Finishes

www.waterconcepts.net • Serving our Customers Since 1946 • www.plumbsupply.com



Shower Faucets

Shower Trim

Hardwater® 2-Hdl Shower Trim

- 8"cc
- Body cast of high copper content brass
- Ceramaflow ceramic disc cartridge
- Regular showerhead with black spray plate
- Maximum showerhead 2.5 gpm @ 80 psi
- Pressure-compensating flow control
- Slip-fit diverter spout
- Ejector tee



Faucets & Valves

Part #	Mfg #	Description	Handle(s)	Finish	Price
029694	58-460	Shower Only Trim, IPS/Sweat, Slide Escutcheon	ADA Hardwater®	Chrome	

*Physical Vapor Deposition (PVD) Limited Lifetime Finish

www.plumbsupply.com • Serving our Customers Since 1946 • www.waterconcepts.net

Shower Faucets

Single-Handle Shower Trim

P4B Builders Series 1-Hdl Shower Trim

- Washerless pressure balance valve
- CC and IP
- Less stops
- Maximum flow rate: 2.5 gpm @ 80 psi



-D Models

-D models have decorative showerhead

Part #	Mfg #	Description	Handle(s)	Finish	Price
141379	P4B-720C	Shower Trim w/ Pressure Balance Valve	ADA Lever	Chrome	
142986	P4B-720BN	Shower Trim w/ Pressure Balance Valve	ADA Lever	Brushed Nickel	
141382	P4B-720ORB	Shower Trim w/ Pressure Balance Valve	ADA Lever	Oil Rubbed Bronze	
153958	P4B-700C	Valve Trim Only w/ Pressure Balance Valve	ADA Lever	Chrome	

Job Pack Models

Less Valve - Must order pressure balancing valve separate

Part #	Mfg #	Description	Handle(s)	Finish	Price
155192	P4B-720CJP	Shower Trim Only, Less Valve	ADA Lever	Chrome	
235537	P4B-720CDJP	Shower Trim Only w/Decorative Showerhead, Less Valve	ADA Lever	Chrome	
235534	P4B-720BNDJP	Shower Trim Only w/Decorative Showerhead, Less Valve	ADA Lever	Brushed Nickel	

P4C Classic Series 1-Hdl Shower Trim

- Washerless pressure balance valve
- CC and IP
- Less stops
- Max flow rate: 2.5 gpm @ 80 psi



Part #	Mfg #	Description	Handle(s)	Finish	Price
141395	P4C-720C	Shower Trim Only	ADA Lever	Chrome	

Shower Faucets

Two-Handle Shower Trim
P4V Value Series 2-Hdl Shower Trim

- Non-pressure balance
- Washerless cartridges
- Acrylic round handles
- Max flow rate: 2.0 gpm @ 80 psi



Part #	Mfg #	Description	Handle(s)	Finish	Price
153267	P4V-822C	Shower Trim Only	Acrylic Round	Chrome	

Faucets & Valves

Shower Faucets

Faucets & Valves

Posi-Temp Shower Trim

90° Posi-Temp® 1-Hdl Shower Trim

- Fits M•PACT® system
- 6" Diameter spray head
- Full spray
- Flow rate: 2.5 gpm or EP 1.75 gpm



Requires Valve: 2520

Part #	Mfg #	Description	Handle(s)	Finish	Price
157732	TS2712EP	Shower Trim Only, 1.75 gpm	ADA Lever	Chrome	
130739	TS2712	Shower Trim Only, 2.5 gpm	ADA Lever	Chrome	
143954	TS2712BN	Shower Trim Only, 2.5 gpm	ADA Lever	Brushed Nickel	
143558	TS2711	Valve Trim Only, 2.5 gpm	ADA Lever	Chrome	
147964	TS2711BN	Valve Trim Only, 2.5 gpm	ADA Lever	Brushed Nickel	

Align™ Posi-Temp® 1-Hdl Shower Trim

- Fits M•PACT® system
- 3-5/8" Diameter spray head
- Full spray
- Max flow: 2.5 gpm



Requires Valve: 2520

Part #	Mfg #	Description	Handle(s)	Finish	Price
186493	T2192	Shower Trim Only	ADA Lever	Chrome	
178158	T2192BN	Shower Trim Only	ADA Lever	Brushed Nickel	
170260	T2192EP	Shower Trim Only, 1.75 gpm	ADA Lever	Chrome	
171857	T2192EPBN	Shower Trim Only, 1.75 gpm	ADA Lever	Brushed Nickel	
226105	T2192NHBN	Shower Trim Only, Less Showerhead	ADA Lever	Brushed Nickel	
179861	T2191	Valve Trim Only	ADA Lever	Chrome	
178093	T2191BN	Valve Trim Only	ADA Lever	Brushed Nickel	

Arris® Posi-Temp® 1-Hdl Shower Trim

- Fits M•PACT® system
- 10" Diameter spray head
- Full spray
- Flow rate: 2.5 gpm or EP 2.0 gpm



Requires Valve: 2520

Part #	Mfg #	Description	Handle(s)	Finish	Price
228103	TS22002EP	Shower Trim Only, 2.0 gpm	ADA Lever	Chrome	

*Lifeshine® Anti-Tarnish Lifetime Finish

www.waterconcepts.net • Serving our Customers Since 1946 • www.plumbsupply.com

Shower Faucets

Brantford™ Posi-Temp® 1-Hdl Shower Trim

- Fits M•PACT® system
- Easy Clean® XLT single-function showerhead, arm and flange
- EP Suffix - indicates eco-performance
- Max flow: 2.5 gpm or EP 1.75 gpm



Requires Valve: 2520

Part #	Mfg #	Description	Handle(s)	Finish	Price
106867	T2152	Shower Trim Only	ADA Lever	Chrome	
102297	T2152BN	Shower Trim Only	ADA Lever	Brushed Nickel	
102292	T2152ORB	Shower Trim Only	ADA Lever	Oil Rubbed Bronze	
183267	T2152EPORB	Shower Trim Only, 1.75 gpm	ADA Lever	Oil Rubbed Bronze	
225048	T2252EP	Shower Trim Only, 8" 1.75 gpm Showerhead	ADA Lever	Chrome	
225364	T2252EPBN	Shower Trim Only, 8" 1.75 gpm Showerhead	ADA Lever	Brushed Nickel	
134885	T2152NHBN	Shower Trim Only, Less Showerhead	ADA Lever	Brushed Nickel	
141584	T2152NHORB	Shower Trim Only, Less Showerhead	ADA Lever	Oil Rubbed Bronze	
148208	T2151	Valve Trim Only	ADA Lever	Chrome	
111024	T2151BN	Valve Trim Only	ADA Lever	Brushed Nickel	
102291	T2151ORB	Valve Trim Only	ADA Lever	Oil Rubbed Bronze	

Caldwell Posi-Temp® 1-Hdl Shower Trim

- Fits M•PACT® system
- 4" Diameter spray head, full spray
- 1/2" IPS connections
- 1222 Cartridge
- WaterSense® Certified: 2.0 gpm



Part #	Mfg #	Description	Handle(s)	Finish	Price
229158	82495C	Shower Trim Only, 2.0 gpm	ADA Lever	Chrome	

Chateau® Posi-Temp® 1-Hdl Shower Trim

- Fits M•PACT® system
- Adjustable temperature limit stop
- Easy-Clean® XL single-function showerhead, arm and flange
- Flow rate: 2.5 gpm or EP 1.75 gpm



Requires Valve: 2520

Part #	Mfg #	Description	Handle(s)	Finish	Price
191628	T182	Shower Trim Only (Bulk 12/Pk)	Acrylic Knob	Chrome	
037060	TL182	Shower Trim Only (Bulk 12/Pk)	ADA Lever	Chrome	
152042	TL182EP	Shower Trim Only, 1.75 gpm	ADA Lever	Chrome	
157585	TL181	Valve Trim Only	ADA Lever	Chrome	
019892	L2352	Shower Trim Only	ADA Lever	Chrome	

*Lifeshine® Anti-Tarnish Lifetime Finish

www.plumbsupply.com • Serving our Customers Since 1946 • www.waterconcepts.net

Shower Faucets

Faucets & Valves

Chateau® Standard 1-Hdl Shower Trim

- Metal construction
- Built on M-PACT common valve system
- Adjustable temperature limit stop
- Easy Clean® XL single-function showerhead, arm and flange
- Valve sold separately



Part #	Mfg #	Description	Handle(s)	Finish	Price
193158	TL473	Shower Trim Only (Bulk 12/Pk)	ADA Lever	Chrome	
191630	T473	Shower Trim Only	Acrylic Knob	Chrome	

Dartmoor™ Posi-Temp® 1-Hdl Shower Trim

- Fits M•PACT® system
- 4" Diameter showerhead
- Full spray
- Flow rate: 2.5 gpm



Requires Valve: 2520

Part #	Mfg #	Description	Handle(s)	Finish	Price
189424	T2182	Shower Trim Only	ADA Lever	Chrome	
227432	T2182BN	Shower Trim Only	ADA Lever	Brushed Nickel	
222889	T2182ORB	Shower Trim Only	ADA Lever	Oil Rubbed Bronze	
224239	T2181	Valve Trim Only	ADA Lever	Chrome	
225166	T2181BN	Valve Trim Only	ADA Lever	Brushed Nickel	

Eva™ Posi-Temp® 1-Hdl Shower Trim

- Fits M•PACT® system
- Easy Clean® XLT single-function showerhead, arm and flange
- Flow rate: 2.5 gpm or EP 1.75 gpm



Requires Valve: 2520

Part #	Mfg #	Description	Handle(s)	Finish	Price
094490	T2132	Shower Trim Only	ADA Lever	Chrome	
095676	T2132BN	Shower Trim Only	ADA Lever	Brushed Nickel	
096054	T2132ORB	Shower Trim Only	ADA Lever	Oil Rubbed Bronze	
226512	T2232EP	Shower Trim Only, 8" 1.75gpm Showerhead	ADA Lever	Chrome	
224746	T2232EPBN	Shower Trim Only, 8" 1.75gpm Showerhead	ADA Lever	Brushed Nickel	
189154	T2130ORB	Valve Trim Only	ADA Lever	Oil Rubbed Bronze	
103009	T2131	Valve Trim Only	ADA Lever	Chrome	
104567	T2131BN	Valve Trim Only	ADA Lever	Brushed Nickel	
099683	T2131ORB	Valve Trim Only	ADA Lever	Oil Rubbed Bronze	
137062	T2132NHBN	Shower Trim Only, Less Showerhead	ADA Lever	Brushed Nickel	
132963	T2132NHORB	Shower Trim Only, Less Showerhead	ADA Lever	Oil Rubbed Bronze	

*Lifeshine® Anti-Tarnish Lifetime Finish

www.waterconcepts.net • Serving our Customers Since 1946 • www.plumbsupply.com

Shower Faucets

Posi-Temp Shower Trim (Continued)

Eva™ Posi-Temp® 1-Hdl Shower Trim

Part #	Mfg #	Description	Handle(s)	Finish	Price
214368	T62132NH	Shower Trim Only, Less Showerhead	ADA Lever	Chrome	

Icon™ Posi-Temp® 1-Hdl Shower Trim

- Fits M•PACT® system
- 5-7/8" Diameter showerhead
- Full spray
- Flow rate: 2.5 gpm



Requires Valve: 2520

Part #	Mfg #	Description	Handle(s)	Finish	Price
096176	TS2142BN	Shower Trim Only	ADA Lever	Brushed Nickel	

Kingsley™ Posi-Temp® 1-Hdl Shower Trim

- Fits M•PACT® system
- Moenflo® XL single-function showerhead, arm and flange
- Flow rate: 2.5 gpm or EP 1.75 gpm



Requires Valve: 2520

Part #	Mfg #	Description	Handle(s)	Finish	Price
070914	T2112	Shower Trim Only	ADA Lever	Chrome	
083601	T2112BN	Shower Trim Only	ADA Lever	Brushed Nickel	
077215	T2112ORB	Shower Trim Only	ADA Lever	Oil Rubbed Bronze	
161362	T2112P	Shower Trim Only	ADA Lever	Polished Brass	
073944	T2112WR	Shower Trim Only	ADA Lever	Wrought Iron	
180569	T2112NHBN	Shower Trim Only, Less Showerhead	ADA Lever	Brushed Nickel	
077652	T2111	Valve Trim Only	ADA Lever	Chrome	
088715	T2111BN	Valve Trim Only	ADA Lever	Brushed Nickel	
083243	T2111ORB	Valve Trim Only	ADA Lever	Oil Rubbed Bronze	
161364	T2111P	Valve Trim Only	ADA Lever	Polished Brass	

*Lifeshine® Anti-Tarnish Lifetime Finish

www.plumbsupply.com • Serving our Customers Since 1946 • www.waterconcepts.net

Shower Faucets

Faucets & Valves

Rothbury™ Posi-Temp® 1-Hdl Shower Trim

- Fits M•PACT® system
- 6-1/2" Diameter spray head
- Single function, full spray
- 1/2" CC connections
- Flow rate: 2.5 gpm



Requires Valve: 2520

Part #	Mfg #	Description	Handle(s)	Finish	Price
122028	TS2212	Shower Trim Only	ADA Lever	Chrome	
198370	TS2212BN	Shower Trim Only	ADA Lever	Brushed Nickel	
112108	TS2212ORB	Shower Trim Only	ADA Lever	Oil Rubbed Bronze	
203410	TS2211	Valve Trim Only	ADA Lever	Chrome	
147537	TS2211BN	Valve Trim Only	ADA Lever	Brushed Nickel	
122078	TS2211ORB	Valve Trim Only	ADA Lever	Oil Rubbed Bronze	

Voss™ Posi-Temp® 1-Hdl Shower Trim

- Fits M•PACT® system
- 4-1/16" Diameter spray head
- Single function, full spray
- Flow rate: 2.5 gpm



Requires Valve: 2520

Part #	Mfg #	Description	Handle(s)	Finish	Price
150273	T2692	Shower Trim Only	ADA Lever	Chrome	
150369	T2692BN	Shower Trim Only	ADA Lever	Brushed Nickel	
160098	T2692ORB	Shower Trim Only	ADA Lever	Oil Rubbed Bronze	
212882	T2692NH	Shower Trim Only, Less Showerhead	ADA Lever	Chrome	
176963	T2692NHBN	Shower Trim Only, Less Showerhead	ADA Lever	Brushed Nickel	
212482	T2692NHORB	Shower Trim Only, Less Showerhead	ADA Lever	Oil Rubbed Bronze	
150543	T2691	Valve Trim Only	ADA Lever	Chrome	
160292	T2691BN	Valve Trim Only	ADA Lever	Brushed Nickel	
152281	T2691ORB	Valve Trim Only	ADA Lever	Oil Rubbed Bronze	

Waterhill™ Posi-Temp® 1-Hdl Shower Trim

- Fits M•PACT® system
- 10" Diameter spray head
- Single-function, full spray
- Flow rate: 2.5 gpm



Requires Valve: 2520

Part #	Mfg #	Description	Handle(s)	Finish	Price
154266	TS312	Shower Trim Only	ADA Lever	Chrome	
112232	TS312ORB	Shower Trim Only	ADA Lever	Oil Rubbed Bronze	

*Lifeshine® Anti-Tarnish Lifetime Finish

www.waterconcepts.net • Serving our Customers Since 1946 • www.plumbsupply.com

Shower Faucets

Weymouth™ Posi-Temp® 1-Hdl Shower Trim

- Fits M•PACT® system
- 9" Diameter Immersion™ rain shower head
- Flow rate: 2.5 gpm or EP 2.0 gpm



Requires Valve: 2520

Part #	Mfg #	Description	Handle(s)	Finish	Price
181597	TS32102NL	Shower Trim Only	ADA Lever	Polished Nickel	
159815	TS32102EP	Shower Trim Only, 2.0 gpm	ADA Lever	Chrome	
156109	TS3210	Valve Trim Only	ADA Lever	Chrome	
183892	TS3210NL	Valve Trim Only	ADA Lever	Polished Nickel	

Wynford™ Posi-Temp® 1-Hdl Shower Trim

- Fits M•PACT® system
- 5-7/8" Diameter spray head
- Single function, full spray
- Flow rate: 1.75 gpm



Requires Valve: 2520

Part #	Mfg #	Description	Handle(s)	Finish	Price
188034	T4502	Shower Trim Only	ADA Lever	Chrome	
178607	T4502BN	Shower Trim Only	ADA Lever	Brushed Nickel	
181590	T4502ORB	Shower Trim Only	ADA Lever	Oil Rubbed Bronze	
218916	T4501	Valve Trim Only	ADA Lever	Chrome	
216437	T4501BN	Valve Trim Only	ADA Lever	Brushed Nickel	
228306	T4501ORB	Valve Trim Only	ADA Lever	Oil Rubbed Bronze	

Moentrol® Shower Trim

90° Moentrol® 1-Hdl Shower Trim

- Fits M•PACT® system
- 6" Diameter spray head
- Single function, full spray
- Flow rate: 2.5 gpm



Requires Valve: 3510

Part #	Mfg #	Description	Handle(s)	Finish	Price
139926	TS3715	Shower Trim Only	ADA Lever	Chrome	
151185	TS3715BN	Shower Trim Only	ADA Lever	Brushed Nickel	
139135	TS3711	Valve Trim Only	ADA Lever	Chrome	

*Lifeshine® Anti-Tarnish Lifetime Finish

www.plumbsupply.com • Serving our Customers Since 1946 • www.waterconcepts.net

Shower Faucets

Faucets & Valves

Align® Moentrol® 1-Hdl Shower Trim

- Fits M•PACT® system
- 6" Diameter spray head
- Single function, full spray
- Flow rate: 2.5 gpm



Requires Valve: 3510

Part #	Mfg #	Description	Handle(s)	Finish	Price
177550	T3292	Shower Trim Only	ADA Lever	Chrome	
176385	T3292BN	Shower Trim Only	ADA Lever	Brushed Nickel	
177265	T3291	Valve Trim Only	ADA Lever	Chrome	

Icon™ Moentrol® 1-Hdl Shower Trim

- Fits M•PACT® system
- 5-7/8" Diameter spray head
- Single function, full spray
- 1225 Cartridge design
- Flow rate: 2.5 gpm



Requires Valve: 3510

Part #	Mfg #	Description	Handle(s)	Finish	Price
197620	TS2155	Shower Trim Only	ADA Lever	Chrome	
150164	TS2155BN	Shower Trim Only	ADA Lever	Brushed Nickel	
127095	TS2154	Valve Trim Only	ADA Lever	Chrome	
150866	TS2154BN	Valve Trim Only	ADA Lever	Brushed Nickel	

Kingsley® Moentrol® 1-Hdl Shower Trim

- Fits M•PACT® system
- 4-3/8" Diameter spray head
- Single function, full spray
- Flow rate: 2.5 gpm



Requires Valve: 3510

Part #	Mfg #	Description	Handle(s)	Finish	Price
070932	T3112	Shower Trim Only	ADA Lever	Chrome	
095635	T3112BN	Shower Trim Only	ADA Lever	Brushed Nickel	
094822	T3112ORB	Shower Trim Only	ADA Lever	Oil Rubbed Bronze	
214713	T3112P	Shower Trim Only	ADA Lever	Polished Brass	
136827	T3111	Valve Trim Only	ADA Lever	Chrome	
074528	T3111BN	Valve Trim Only	ADA Lever	Brushed Nickel	
169364	T3111P	Valve Trim Only	ADA Lever	Polished Brass	

*Lifeshine® Anti-Tarnish Lifetime Finish

www.waterconcepts.net • Serving our Customers Since 1946 • www.plumbsupply.com

Shower Faucets

Legend® Moentrol® 1-Hdl Shower Trim

- Fits M•PACT® system
- Single function showerhead
- Flow rate: 2.5 gpm



Requires Valve: 3510

Part #	Mfg #	Description	Handle(s)	Finish	Price
193104	TL171	Shower Trim Only	ADA Lever	Chrome	

Voss™ Moentrol® 1-Hdl Shower Trim

- Fits M•PACT® system
- 6" Diameter spray head
- Single function, full spray
- Flow rate: 2.5 gpm



Requires Valve: 3510

Part #	Mfg #	Description	Handle(s)	Finish	Price
153510	T3692	Shower Trim Only	ADA Lever	Chrome	
155031	T3692BN	Shower Trim Only	ADA Lever	Brushed Nickel	
152810	T3692ORB	Shower Trim Only	ADA Lever	Oil Rubbed Bronze	
207703	T3691	Valve Trim Only	ADA Lever	Chrome	
188937	T3691BN	Valve Trim Only	ADA Lever	Brushed Nickel	
175496	T3691ORB	Valve Trim Only	ADA Lever	Oil Rubbed Bronze	

Wynford™ Moentrol® 1-Hdl Shower Trim

- Fits M•PACT® system
- 7" Diameter spray head
- Single function, full spray
- Flow rate: 2.5 gpm



Requires Valve: 3510

Part #	Mfg #	Description	Handle(s)	Finish	Price
187258	T5502	Shower Trim Only	ADA Lever	Chrome	
189836	T5502BN	Shower Trim Only	ADA Lever	Brushed Nickel	
187015	T5502NL	Shower Trim Only	ADA Lever	Polished Nickel	
181283	T5502ORB	Shower Trim Only	ADA Lever	Oil Rubbed Bronze	
218841	T5501	Valve Trim Only	ADA Lever	Chrome	
185270	T5501BN	Valve Trim Only	ADA Lever	Brushed Nickel	

*Lifeshine® Anti-Tarnish Lifetime Finish

www.plumbsupply.com • Serving our Customers Since 1946 • www.waterconcepts.net

Shower Faucets

Faucets & Valves

Icon™ Moentrol® with Transfer Valve

- Fits M•PACT® system
- Two independent, one shared position
- 1/2" cc connection
- Not recommended for tub spout application
- Showerhead sold separately



Requires Valve: 3330

Part #	Mfg #	Description	Handle(s)	Finish	Price
197521	TS4112	Valve Trim Only, Moentrol w/ Transfer	ADA Lever	Chrome	
197242	TS4112BN	Valve Trim Only, Moentrol w/ Transfer	ADA Lever	Brushed Nickel	

Kingsley® Moentrol® with Transfer Valve

- Fits M•PACT® system
- Two independent, one shared position
- 1/2" cc connection
- Not recommended for tub spout application
- Showerhead sold separately



Requires Valve: 3330

Part #	Mfg #	Description	Handle(s)	Finish	Price
176135	T4111	Valve Trim Only, Moentrol w/ Transfer	ADA Lever	Chrome	
146510	T4111BN	Valve Trim Only, Moentrol w/ Transfer	ADA Lever	Brushed Nickel	
083244	T4111ORB	Valve Trim Only, Moentrol w/ Transfer	ADA Lever	Oil Rubbed Bronze	
216047	T4111P	Valve Trim Only, Moentrol w/ Transfer	ADA Lever	Polished Brass	

Rothbury™ Moentrol® with Transfer

- Fits M•PACT® system
- Two independent, one shared position
- 1/2" cc connection
- Not recommended for tub spout application
- Showerhead sold separately



Requires Valve: 3330

Part #	Mfg #	Description	Handle(s)	Finish	Price
198497	TS4211	Valve Trim Only, Moentrol w/ Transfer	ADA Lever	Chrome	
167438	TS4211BN	Valve Trim Only, Moentrol w/ Transfer	ADA Lever	Brushed Nickel	
119070	TS4211ORB	Valve Trim Only, Moentrol w/ Transfer	ADA Lever	Oil Rubbed Bronze	

*Lifeshine® Anti-Tarnish Lifetime Finish

www.waterconcepts.net • Serving our Customers Since 1946 • www.plumbsupply.com

Shower Faucets

ExactTemp Shower Trim

Moen ExactTemp® Thermostatic Shower Trim

- Fits M•PACT® system
- Allows you to dial in and maintain your idea temperature for more precise temperature control; 3/4" volume control valve allows optimum water flow in homes with 1/2" or 3/4" plumbing
- 7" Immersion™ spray head with full spray
- Flow rate: 2.5 gpm



For use with S3371, 3/4" Thermostatic Valve and S3600, Volume Control Valve

Part #	Mfg #	Description	Handle(s)	Finish	Price
157840	TS3400	Shower Trim Only, Thermostatic	ADA Lever	Chrome	
095816	TS3400BN	Shower Trim Only, Thermostatic	ADA Lever	Brushed Nickel	
103407	TS3400ORB	Shower Trim Only, Thermostatic	ADA Lever	Oil Rubbed Bronze	
144398	TS3411BN	Valve Trim Only, Thermostatic	ADA Lever	Brushed Nickel	
108132	TS3411ORB	Valve Trim Only, Thermostatic	ADA Lever	Oil Rubbed Bronze	

Weymouth® ExactTemp® Thermostatic Valve Trim

- Fits M•PACT® system
- Showerhead sold separately
- Separate volume control valve required



Requires Valve: S 3371, 3/4" Thermostatic Valve

Part #	Mfg #	Description	Handle(s)	Finish	Price
225628	TS32110BN	Valve Trim Only, Thermostatic	ADA Lever	Brushed Nickel	

Volume Control Trim

90° Volume Control Trim

- Single function



Requires Thermostatic Valve: S3371

Volume Control Valve: S3600

Part #	Mfg #	Description	Handle(s)	Finish	Price
190026	TS300	Volume Control Trim Only	ADA Lever	Chrome	
141008	TS3300BN	Volume Control Trim Only	ADA Lever	Brushed Nickel	

*Lifeshine® Anti-Tarnish Lifetime Finish

www.plumbsupply.com • Serving our Customers Since 1946 • www.waterconcepts.net

Shower Faucets

Faucets & Valves

Arris™ Volume Control Trim

- Single function



Requires Thermostatic Valve: S3371
Volume Control Valve: S3600

Part #	Mfg #	Description	Handle(s)	Finish	Price
175133	TS33003	Volume Control Trim Only	ADA Lever	Chrome	
169031	TS33003BN	Volume Control Trim Only	ADA Lever	Brushed Nickel	

Icon™ Volume Control Trim

- Single function



Requires Thermostatic Valve: S3371
Volume Control Valve: S3600

Part #	Mfg #	Description	Handle(s)	Finish	Price
209763	TS3200	Volume Control Trim Only	ADA Lever	Chrome	
156157	TS3200BN	Volume Control Trim Only	ADA Lever	Brushed Nickel	

Moen Volume Control Trim

- Single function



Requires Thermostatic Valve: S3371
Volume Control Valve: S3600

Part #	Mfg #	Description	Handle(s)	Finish	Price
110475	TS3600	Volume Control Trim Only	ADA Lever	Chrome	
095820	TS3600BN	Volume Control Trim Only	ADA Lever	Brushed Nickel	
096199	TS3600ORB	Volume Control Trim Only	ADA Lever	Oil Rubbed Bronze	

Rothbury™ Volume Control Trim

- Single function



Requires Thermostatic Valve: S3371
Volume Control Valve: S3600

Part #	Mfg #	Description	Handle(s)	Finish	Price
180826	TS3820	Volume Control Trim Only	ADA Lever	Chrome	
207945	TS820BN	Volume Control Trim Only	ADA Lever	Brushed Nickel	
182222	TS3820ORB	Volume Control Trim Only	ADA Lever	Oil Rubbed Bronze	

*Lifeshine® Anti-Tarnish Lifetime Finish

www.waterconcepts.net • Serving our Customers Since 1946 • www.plumbsupply.com

Shower Faucets

Waterhill™ Volume Control Trim

- Single function

Requires Thermostatic Valve: S3371
Volume Control Valve: S3600



Part #	Mfg #	Description	Handle(s)	Finish	Price
196957	TS514BN	Volume Control Trim Only	ADA Lever	Brushed Nickel	

Weymouth™ Volume Control Trim

- Single function
- 3/4" IPS connections

Requires Thermostatic Valve: S3371
Volume Control Valve: S3600



Part #	Mfg #	Description	Handle(s)	Finish	Price
205897	TS52104	Volume Control Trim Only	ADA Lever	Chrome	
216685	TS52104BN	Volume Control Trim Only	ADA Lever	Brushed Nickel	
210300	TS52104NL	Volume Control Trim Only	ADA Lever	Polished Nickel	
144164	TS52104ORB	Volume Control Trim Only	ADA Lever	Oil Rubbed Bronze	

Thermostatic Valve Trim

90° ExactTemp® Thermostatic Valve Trim

- ExactTemp® thermostatic valve allows you to dial in and maintain your ideal temperature for more precise temperature control
- Built on the Moen M•PACT common valve system
- 3/4" IPS connections

Requires Thermostatic Valve: S3371
Volume Control Valve: S3600



Part #	Mfg #	Description	Handle(s)	Finish	Price
190027	TS3100	Thermostatic Trim Only	ADA Lever	Chrome	
180460	TS3100BN	Thermostatic Trim Only	ADA Lever	Brushed Nickel	

*Lifeshine® Anti-Tarnish Lifetime Finish

www.plumbsupply.com • Serving our Customers Since 1946 • www.waterconcepts.net

Shower Faucets

Faucets & Valves

Arris™ ExactTemp® Thermostatic Valve Trim

- ExactTemp® thermostatic valve allows you to dial in and maintain your ideal temperature for more precise temperature control
- Built on M•PACT® common valve system
- 3/4" IPS connections



Requires Thermostatic Valve: S3371
Volume Control Valve: S3600

Part #	Mfg #	Description	Handle(s)	Finish	Price
179487	TS33002	Thermostatic Trim Only	ADA Lever	Chrome	
181325	TS33002BN	Thermostatic Trim Only	ADA Lever	Brushed Nickel	

Rothbury™ ExactTemp Thermostatic Valve Trim

- ExactTemp® thermostatic valve allows you to dial in and maintain your ideal temperature for more precise temperature control
- Built on M•PACT® common valve system
- 3/4" IPS connections



Requires Thermostatic Valve: S3371
Volume Control Valve: S3600

Part #	Mfg #	Description	Handle(s)	Finish	Price
182221	TS760ORB	Thermostatic Trim Only	ADA Lever	Oil Rubbed Bronze	

Weymouth™ ExactTemp® Thermostatic Valve Trim

- ExactTemp® thermostatic valve allows you to dial in and maintain your ideal temperature for more precise temperature control
- Built on M•PACT® common valve system
- 3/4" IPS connections



Requires Thermostatic Valve: S3371
Volume Control Valve: S3600

Part #	Mfg #	Description	Handle(s)	Finish	Price
176305	TS32110ORB	Thermostatic Trim Only	ADA Lever	Oil Rubbed Bronze	

Vertical Spa Digital Control

- 4 Outlets
- Precise flow rate and temperature control
- 3/4" CC, CPVC inlet connectors; outlet push-fit crimp ring PEX
- Includes: 30 ft Data cable



Requires loDIGITAL® S3384 Valve

Part #	Mfg #	Description	Handle(s)	Finish	Price
180904	TS420ORB	Digital Valve Control	N/A	Oil Rubbed Bronze	

*Lifeshine® Anti-Tarnish Lifetime Finish

www.waterconcepts.net • Serving our Customers Since 1946 • www.plumbsupply.com

Shower Faucets

Transfer Valve Trim 90° Transfer Valve Trim

- Fits M•PACT® system
- Two independent, one shared position
- 1/2" CC



Requires Valve: 3372 or 3375

Part #	Mfg #	Description	Handle(s)	Finish	Price
159212	TS4172	Transfer Valve Trim Only	ADA Lever	Chrome	
149931	TS4172BN	Transfer Valve Trim Only	ADA Lever	Brushed Nickel	

Align™ Transfer Valve Trim

- Fits M•PACT® system
- Two independent, one shared position
- 1/2" CC



Requires Valve: 3372 or 3375

Part #	Mfg #	Description	Handle(s)	Finish	Price
177267	T4191	Transfer Valve Trim Only	ADA Lever	Chrome	
176386	T4191BN	Transfer Valve Trim Only	ADA Lever	Brushed Nickel	

Kingsley™ Transfer Valve Trim

- Fits M•PACT® system
- Two independent, one shared position
- 1/2" CC



Requires Valve: 3372 or 3375

Part #	Mfg #	Description	Handle(s)	Finish	Price
218901	T4311	Transfer Valve Trim Only	ADA Lever	Chrome	
171115	T4311BN	Transfer Valve Trim Only	ADA Lever	Brushed Nickel	
172898	T4311ORB	Transfer Valve Trim Only	ADA Lever	Oil Rubbed Bronze	

Moen Transfer Valve Trim

- Metal construction
- Two independent, one shared position
- 1/2" CC



Requires Valve: 3372

Part #	Mfg #	Description	Handle(s)	Finish	Price
131045	T4171	Transfer Valve Trim Only	ADA Lever	Chrome	
133034	T4171BN	Transfer Valve Trim Only	ADA Lever	Brushed Nickel	
138866	T4171ORB	Transfer Valve Trim Only	ADA Lever	Oil Rubbed Bronze	

*Lifeshine® Anti-Tarnish Lifetime Finish

www.plumbsupply.com • Serving our Customers Since 1946 • www.waterconcepts.net

Shower Faucets

Faucets & Valves

Voss™ Transfer Valve Trim

- Fits M•PACT® valve system
- Two independent, one shared position
- 1/2" CC



Requires Valve: 3372 or 3375

Part #	Mfg #	Description	Handle(s)	Finish	Price
150274	T4611	Transfer Valve Trim Only	ADA Lever	Chrome	
152229	T4611BN	Transfer Valve Trim Only	ADA Lever	Brushed Nickel	
152811	T4611ORB	Transfer Valve Trim Only	ADA Lever	Oil Rubbed Bronze	

Waterhill® Transfer Valve Trim

- Fits M•PACT® valve system
- Two independent, one shared position
- 1/2" CC



Requires Valve: 3372 or 3375

Part #	Mfg #	Description	Handle(s)	Finish	Price
215286	TS325BN	Transfer Valve Trim Only	ADA Lever	Brushed Nickel	
184585	TS325ORB	Transfer Valve Trim Only	ADA Lever	Oil Rubbed Bronze	

Weymouth™ Transfer Valve Trim

- Fits M•PACT® system
- Two independent, one shared position
- 1/2" CC



Requires Valve: 3372 or 3375

Part #	Mfg #	Description	Handle(s)	Finish	Price
184232	TS32205NL	Transfer Valve Trim Only	ADA Lever	Polished Nickel	

Wynford™ Transfer Valve Trim

- Fits M•PACT® system
- Two independent, one shared position
- 1/2" CC



Requires Valve: 3372 or 3375

Part #	Mfg #	Description	Handle(s)	Finish	Price
188037	T4511	Transfer Valve Trim Only	ADA Lever	Chrome	
218545	T4511BN	Transfer Valve Trim Only	ADA Lever	Brushed Nickel	

*Lifeshine® Anti-Tarnish Lifetime Finish

www.waterconcepts.net • Serving our Customers Since 1946 • www.plumbsupply.com

Shower Faucets

Shower Trim
Basement Shower Fitting

- *Renew valves & seats*
- *Cast brass body*
- *Chrome-plated body & fittings*
- *C-N-I fits all unions*
- *Flow rated @ 2.5 gpm*



Faucets & Valves

Part #	Mfg #	Description	Price
010495	38	Cast Brass Shower Fitting with Soap Dish, Showerhead & Arm	

Shower Faucets

Add-A-Shower

Add-A-Shower Complete Unit

- Bathcock with diverter spout
- Chrome-plated plastic showerhead
- 61" Rise with 12" rod and riser support
- 24" x 42" Oval aluminum shower rod with 36" ceiling rod and support



Part #	Mfg #	Description	Price
222644	S10-069	Complete Unit w/S10-074 Diverter	
084358	S10-070	Complete Unit w/S10-080 Diverter	

Shower Heads

Water Saver Shower Head

- Chrome plated brass
- Aerating
- Restricts Water To 2-2.5GPM



Part #	Mfg #	Description	Price
176424	S01-013	1" Chrome Aerating Water Saver Brass Showerhead	
187227	S01-014	1" Chrome Aerating Water Saver Brass Showerhead w/ Shutoff	

Steam Generator Components

Invigoration™ Series Steam Generators

- *Fast-Response® technology produces steam in just one minute instead of waiting four minutes*
- *Power Clean™ technology automatic cleaning feature at the touch of a button*
- *Compatible with the KOHLER DTV+ showering system*



Faucets & Valves

Requires K-5557 Control Kit or K-5548-K1 Adapter Kit

Part #	Mfg #	Description	Price
184917	K-5525-NA	5kW, Fast-Response® 84 Cubic Feet	
184918	K-5526-NA	7kW Fast-Response® 112 Cubic Feet	
184919	K-5529-NA	9kW Fast-Response® 240 Cubic Feet	
184920	K-5531-NA	11kW, Fast-Response® 317 Cubic Feet	
184921	K-5533-NA	13kW Fast-Response® 447 Cubic Feet	
184922	K-5535-NA	15kW Fast-Response® 500 Cubic Feet	
184924	K-5539-NA	18kW Fast-Response® 480 Cubic Feet	
184925	K-5543-NA	22kW, Fast-Response® 634 Cubic Feet	
184926	K-5546-NA	26kW, Fast-Response® 894 Cubic Feet	
184927	K-5547-NA	30kW, Fast Response® 1000 Cubic Feet	

Control Kits

Invigoration™ Series Steam Generator Control Kit

- *For use with Invigoration™ Series 5kW - 15kW steam generators*
- *Circular steam head protracts from finished wall, allowing steam to evenly dispense throughout shower*
- *Easily adjustable control panel allows user to set temperature (90 - 125°F range) and steam session duration*
- *20-Minute safety shutoff*
- *Steam head features an integral aromatherapy well for adding scents*
- *Fast-Response® technology produces a luxurious steam shower in 60 seconds*
- *Power Clean™ technology offers one-touch automatic cleaning and safe maintenance*



Part #	Mfg #	Description	Price
184928	K-5557-BN	*Brushed Nickel	
184932	K-5557-BV	*Brushed Bronze	
184929	K-5557-CP	Polished Chrome	
184930	K-5557-SN	*Polished Nickel	

Steam Generator Components

Invigoration™ Series Tandem Steam Generator Kit

- For use with Invigoration™ Series 18kW - 30kW Steam Generators
- Fast-Response® technology produces a luxurious steam shower in 60 seconds
- Quick-connect RJ-12 cord and connector
- Mounting arm and gasket
- Digital clock
- Two thermostatic steam heads with aromatherapy reservoirs
- Adjustable time and temperature settings between 90 and 125°F
- Controls the Power Clean feature.
- 20-minute safety shutoff



Faucets & Valves

Part #	Mfg #	Description	Color	Price
184826	K-5558-CP	Polished Chrome		

DTV+™ Steam Adapter Kit

- For use with steam generators between 5 and 15 kilowatts.
- Allows steam generator to be controlled with DTV+ controller.
- Adjustable time and temperature settings between 90 and 125°F
- Includes steam head, temperature sensor, and adapter.
- 20-minute safety shutoff.
- Aromatherapy reservoir on steam head.



Requires DTV+ shower components (sold separately)

Part #	Mfg #	Description	Color	Price
184934	K-5548-K1-BN	*Brushed Nickel		
184937	K-5548-K1-BV	*Brushed Bronze		
184933	K-5548-K1-CP	Polished Chrome		
184935	K-5548-K1-SN	*Polished Nickel		

Tub & Shower Faucets

Single-Handle Tub & Shower Trim

Alteo® Rite-Temp® 1-Hdl Tub & Shower Trim with Diverter

- Premium construction
- MasterClean™ spray nozzles
- 2.5 gpm Showerhead
- Intended for use with Rite-Temp® or HiFlow Rite-Temp® valves
- Heavy-duty slip-fit clamp design and NPT threaded spout



Requires:

K-304/K-P304 Series Rite-Temp® Valves

or

K-2971-KS 3/4" Pressure-balancing Valve

Part #	Mfg #	Description	Handle(s)	Finish	Price
225725	K-TS45104-4-BN	Tub & Shower Trim, Pushbutton Diverter	ADA Lever	*Brushed Nickel	
225724	K-TS45104-4-CP	Tub & Shower Trim, Pushbutton Diverter	ADA Lever	Polished Chrome	
225726	K-TS45104-4-2BZ	Tub & Shower Trim, Pushbutton Diverter	ADA Lever	Oil Rubbed Bronze	

Archer™ Rite-Temp® 1-Hdl Tub & Shower Trim

- Metal construction
- Intended for use with Rite-Temp or Hi Flow Rite-Temp valves
- High-temperature limit setting
- Mixing valve cycles from "cold" to "hot"
- 6-1/2" Diverter spout, 1/2" IPS connection



Requires:

K-304/K-P304 Series Rite-Temp® Valves

or

K-2971-KS 3/4" Pressure-balancing Valve

Part #	Mfg #	Description	Handle(s)	Finish	Price
225900	K-TS11077-4-CP	Tub & Shower Trim, 2.5 GPM	ADA Lever	Polished Chrome	
224670	K-T11077-4E-BN	Tub & Shower Trim, 2.0 GPM	ADA Lever	*Brushed Nickel	

Bancroft® Rite-Temp® 1-Hdl Tub & Shower Trim

- Metal construction
- 5-3/4" Diverter spout, NPT or Slip-fit connection
- (-P) ADA porcelain handle lever
- (K-TS10582) includes slip fit spout



Requires:

K-304/K-P304 Series Rite-Temp® Valves

or

K-2971-KS 3/4" Pressure-balancing Valve

Part #	Mfg #	Description	Handle(s)	Finish	Price
226203	K-TS10581-4-BN	Tub & Shower Trim	ADA Lever	*Brushed Nickel	
114250	K-TS10581-4-BV	Tub & Shower Trim	ADA Lever	*Brushed Bronze	
231236	K-TS10581-4-CP	Tub & Shower Trim	ADA Lever	Polished Chrome	
103487	K-T10581-4-SN	Tub & Shower Trim	ADA Lever	*Polished Nickel	
104658	K-TS10581-4P-BN	Tub & Shower Trim	ADA Porcelain Lever	*Brushed Nickel	

* Vibrant Limited Lifetime Warranty

www.plumbsupply.com • Serving our Customers Since 1946 • www.waterconcepts.net

Tub & Shower Faucets

Faucets & Valves

Single-Handle Tub & Shower Trim (Continued)

Bancroft® Rite-Temp® 1-Hdl Tub & Shower Trim

Part #	Mfg #	Description	Handle(s)	Finish	Price
094944	K-TS10581-4P-CP	Tub & Shower Trim	ADA Porcelain Lever	Polished Chrome	
098001	K-TS10581-4P-SN	Tub & Shower Trim	ADA Porcelain Lever	*Polished Nickel	
182960	K-TS10582-4-SN	Tub & Shower Trim, Slip Fit Spout	ADA Lever	*Polished Nickel	
183392	K-TS10582-4-2BZ	Tub & Shower Trim, Slip Fit Spout	ADA Lever	Oil-Rubbed Bronze	

Coralais® Mixing Valve 1-Hdl Tub & Shower Trim

- Metal construction
- Adjustable spray showerhead, arm and flange
- High temperature limit stop
- 4-7/8" Diverter spout with NPT or slip-fit connection
- (-S) Slip-fit spout



Requires valve K-304-KJ-KPI-KS

Part #	Mfg #	Description	Handle(s)	Finish	Price
226201	K-TS15601-4-CP	Tub & Shower Trim	ADA Lever	Polished Chrome	
225710	K-TS15601-4-G	Tub & Shower Trim	ADA Lever	Brushed Chrome	
226202	K-TS15601-4S-CP	Tub & Shower Trim, Slip Diverter	ADA Lever	Polished Chrome	
225712	K-TS15601-4S-G	Tub & Shower Trim, Slip Diverter	ADA Lever	Brushed Chrome	
225711	K-PS15601-4-CP	Tub & Shower Trim, P-Pk	ADA Lever	Polished Chrome	
225713	K-PS15601-4S-CP	Tub & Shower Trim, Slip Diverter, P-Pk	ADA Lever	Polished Chrome	

Devonshire® Rite-Temp® 1-Hdl Tub & Shower Trim

- Metal construction
- Brass valve bodies
- Pressure-balancing mechanism of one-piece diaphragm cartridge
- 2.5 gpm showerhead, arm and flange
- 5-1/4" Diverter spout
- (-S) Slip-fit spout
- (E) 2.0 gpm

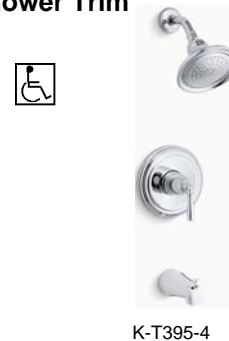

Requires:

K-304/K-P304 Series Rite-Temp® Valves
or

K-2971-KS 3/4" Pressure-balancing Valve

Part #	Mfg #	Description	Handle(s)	Finish	Price
225809	K-TS395-4-BN	Tub & Shower Trim	ADA Lever	*Brushed Nickel	
225810	K-TS395-4-BV	Tub & Shower Trim	ADA Lever	*Brushed Bronze	
225808	K-TS395-4-CP	Tub & Shower Trim	ADA Lever	Polished Chrome	
094402	K-TS395-4-PB	Tub & Shower Trim	ADA Lever	*Polished Brass	
181952	K-TS395-4-SN	Tub & Shower Trim	ADA Lever	*Polished Nickel	

* Vibrant Limited Lifetime Warranty

www.waterconcepts.net • Serving our Customers Since 1946 • www.plumbsupply.com

Tub & Shower Faucets

Single-Handle Tub & Shower Trim (Continued) Devonshire® Rite-Temp® 1-Hdl Tub & Shower Trim

Part #	Mfg #	Description	Handle(s)	Finish	Price
225811	K-TS395-4-2BZ	Tub & Shower Trim	ADA Lever	Oil-Rubbed Bronze	
225814	K-TS395-4E-2BZ	Tub & Shower Trim, 2.0 GPM	ADA Lever	Oil-Rubbed Bronze	
225816	K-TS395-4S-BN	Tub & Shower Trim, Slip-Fit Diverter Spout	ADA Lever	*Brushed Nickel	
225815	K-TS395-4S-CP	Tub & Shower Trim, Slip-Fit Diverter Spout	ADA Lever	Polished Chrome	
225817	K-TS395-4S-2BZ	Tub & Shower Trim, Slip-Fit Diverter Spout	ADA Lever	Oil-Rubbed Bronze	
225859	K-TS395-4SE-2BZ	Tub & Shower Trim, Slip-Fit Diverter Spout, 2.0 GPM	ADA Lever	Oil-Rubbed Bronze	

Fairfax® Rite-Temp® 1-Hdl Tub & Shower Trim

- Metal construction
- Showerhead, arm and flange
- 4-7/8" Diverter spout, 1/2" IPS connection



Requires:

K-304/K-P304 Series Rite-Temp® Valves
or

K-2971-KS 3/4" Pressure-balancing Valve

Part #	Mfg #	Description	Handle(s)	Finish	Price
225918	K-TS12007-4-CP	Tub & Shower Trim, Diverter Spout	ADA Lever	Polished Chrome	
225919	K-TS12007-4-BN	Tub & Shower Trim, Diverter Spout	ADA Lever	*Brushed Nickel	
225920	K-TS12007-4-2BZ	Tub & Shower Trim, Diverter Spout	ADA Lever	Oil-Rubbed Bronze	

Finial® Rite-Temp® 1-Hdl Tub & Shower Trim

- Brass construction
- Push-button diverter
- 5-3/4" spout with NPT connection



Requires Valve: K-305-KI-KS Rite-Temp® with push-button diverter

Part #	Mfg #	Description	Handle(s)	Finish	Price
107933	K-T312-4M-AF	Tub & Shower Trim, Push-Button Diverter	Traditional Lever	*French Gold	
059246	K-T312-4M-BN	Tub & Shower Trim, Push-Button Diverter	Traditional Lever	*Brushed Nickel	
139370	K-T312-4M-CP	Tub & Shower Trim, Push-Button Diverter	Traditional Lever	Polished Chrome	
082821	K-T312-4M-SN	Tub & Shower Trim, Push-Button Diverter	Traditional Lever	*Polished Nickel	
180604	K-T312-4M-2BZ	Tub & Shower Trim, Push-Button Diverter	Traditional Lever	Oil-Rubbed Bronze	

* Vibrant Limited Lifetime Warranty

www.plumbsupply.com • Serving our Customers Since 1946 • www.waterconcepts.net

Tub & Shower Faucets

Faucets & Valves

Forté® Rite-Temp® Pressure-Balancing 1-Hdl Tub & Shower Trim

- Metal construction
- Intended for use with Rite-Temp® or HiFlow Rite-Temp® valves
- Includes faceplate and handle
- 5-1/4" NPT Diverter spout
—(K-TS10275) Slip-fit spout



Requires:

K-304/K-P304 Series Rite-Temp® Valves
or
K-2971-KS 3/4" Pressure-balancing Valve

Part #	Mfg #	Description	Handle(s)	Finish	Price
225877	K-TS10274-4-BN	Tub & Shower Trim	ADA Sculpted Lever	*Brushed Nickel	
225875	K-TS10274-4-CP	Tub & Shower Trim	ADA Sculpted Lever	Polished Chrome	
225876	K-TS10274-4-G	Tub & Shower Trim	ADA Sculpted Lever	Brushed Chrome	
225888	K-TS10274-4A-BN	Tub & Shower Trim	ADA Traditional Lever	*Brushed Nickel	
225885	K-TS10274-4A-CP	Tub & Shower Trim	ADA Traditional Lever	Polished Chrome	
225887	K-TS10274-4A-G	Tub & Shower Trim	ADA Traditional Lever	Brushed Chrome	
225881	K-TS10275-4-BN	Tub & Shower Trim with Slip-Fit Spout	ADA Sculpted Lever	*Brushed Nickel	
225879	K-TS10275-4-CP	Tub & Shower Trim with Slip-Fit Spout	ADA Sculpted Lever	Polished Chrome	

Honesty™ Rite-Temp® Pressure-Balancing 1-Hdl Tub & Shower Trim

- Premium construction
- Single function showerhead
- WaterSense® certified product: 2.0 gpm

Requires Valve: K-11748-K or K-11748-KS



Part #	Mfg #	Description	Handle(s)	Finish	Price
178232	K-T99763-4-CP	Tub & Shower Trim with Push-Button Diverter	ADA Lever	Polished Chrome	

* Vibrant Limited Lifetime Warranty

www.waterconcepts.net • Serving our Customers Since 1946 • www.plumbsupply.com

Tub & Shower Faucets

July™ Rite-Temp® Pressure-Balancing 1-Hdl Tub & Shower Trim

- Premium construction
- Single function showerhead
- WaterSense® certified product: 2.0 gpm



Faucets & Valves

Requires:

K-304/K-P304 Series Rite-Temp® Valves
or

K-2971-KS 3/4" Pressure-balancing Valve

Part #	Mfg #	Description	Handle(s)	Finish	Price
225524	K-T98007-4-CP	Tub & Shower Trim, Slip-fit Diverter Spout, Less Head	ADA Lever	Polished Chrome	
223403	K-TS98006-4-CP	Tub & Shower Trim, Slip-fit Diverter Spout	ADA Lever	Polished Chrome	
223404	K-TS98006-4-G	Tub & Shower Trim, Slip-fit Diverter Spout	ADA Lever	Brushed Chrome	

Kelston®™ Rite-Temp® 1-Hdl Tub & Shower Trim

- Metal construction, brass valve bodies
- High-temperature limit stop
- Mixing valve cycles from cold to hot
- For use with Rite-Temp® or HiFlow Rite-Temp® valves
- Heavy-duty slip-fit clamp design



Requires:

K-304/K-P304 Series Rite-Temp® Valves
or

K-2971-KS 3/4" Pressure-balancing Valve

Part #	Mfg #	Description	Handles	Finish	Price
225909	K-TS13492-4-BN	Tub & Shower Trim, NPT Slip-Fit Diverter Spout	ADA Lever	*Brushed Nickel	
225908	K-TS13492-4-CP	Tub & Shower Trim, NPT Slip-Fit Diverter Spout	ADA Lever	Polished Chrome	
225910	K-TS13492-4-2BZ	Tub & Shower Trim, NPT Slip-Fit Diverter Spout	ADA Lever	Oil-Rubbed Bronze	

Loure® Rite-Temp® 1-Hdl Tub & Shower Trim

- Brass construction
- Push-button diverter
- MasterClean® spray nozzles prohibit mineral build-up



Requires Valve:

K-11748-K

or

K-11748-KS

Part #	Mfg #	Description	Handle(s)	Finish	Price
170481	K-T14664-4-BN	Tub & Shower Trim, Push Button Diverter	Lever	*Brushed Nickel	
156037	K-T14664-4-CP	Tub & Shower Trim, Push Button Diverter	Lever	Polished Chrome	
182974	K-T14664-4-SN	Tub & Shower Trim, Push Button Diverter	Lever	*Polished Nickel	

* Vibrant Limited Lifetime Warranty

www.plumbsupply.com • Serving our Customers Since 1946 • www.waterconcepts.net

Tub & Shower Faucets

Margaux® Rite-Temp® 1-Hdl Tub & Shower Trim

- Brass construction
- MasterClean® sprayface
- Model (K-T16233) includes push-button diverter

Requires Valve: K-304-K or K-304-KS

Push-Button Diverter Trim Requires Valve: K-11748-K/KS



Part #	Mfg #	Description	Handle(s)	Finish	Price
134193	K-TS16225-3-BN	Tub & Shower Trim	Cross	*Brushed Nickel	
115419	K-TS16225-3-CP	Tub & Shower Trim	Cross	Polished Chrome	
182977	K-TS16225-4-AF	Tub & Shower Trim	Lever	*French Gold	
167737	K-TS16225-4-BN	Tub & Shower Trim	Lever	*Brushed Nickel	
233790	K-TS16225-4-CP	Tub & Shower Trim	Lever	Polished Chrome	
145255	K-TS16225-4-SN	Tub & Shower Trim	Lever	*Polished Nickel	
182978	K-T16233-3-CP	Tub & Shower Trim, Push-Button Diverter	Cross	Polished Chrome	
182979	K-T16233-3-SN	Tub & Shower Trim, Push-Button Diverter	Cross	*Polished Nickel	

Pinstripe® Pure Rite-Temp® Pressure-Balancing 1-Hdl Tub & Shower Trim

- Push-button diverter
- For use with valves with diverters

Requires Valve:

K-11748-K

or

K-11748-KS



Part #	Mfg #	Description	Handle(s)	Finish	Price
091482	K-T13133-3A-BN	Tub & Shower Trim, Push Button Diverter	Cross	*Brushed Nickel	
188988	K-T13133-3A-CP	Tub & Shower Trim, Push Button Diverter	Cross	Polished Chrome	
111913	K-T13133-3A-SN	Tub & Shower Trim, Push Button Diverter	Cross	*Polished Nickel	
084110	K-T13133-3B-CP	Tub & Shower Trim, Push Button Diverter & Pinstripe	Cross	Polished Chrome	
091159	K-T13133-3B-SN	Tub & Shower Trim, Push Button Diverter & Pinstripe	Cross	*Polished Nickel	
109568	K-T13133-4A-BN	Tub & Shower Trim, Push Button Diverter	Lever	*Brushed Nickel	
129747	K-T13133-4A-CP	Tub & Shower Trim, Push Button Diverter	Lever	Polished Chrome	
173480	K-T13133-4A-SN	Tub & Shower Trim, Push Button Diverter	Lever	*Polished Nickel	

* Vibrant Limited Lifetime Warranty

www.waterconcepts.net • Serving our Customers Since 1946 • www.plumbsupply.com

Tub & Shower Faucets

Purist® Rite-Temp® Pressure Balancing 1-Hdl Tub & Shower

- *Push-button diverter*
- *Premium metal construction*
- *For use with valves with diverters*

Requires Valve:
K-11748-K
or
K-11748-KS



Faucets & Valves

Part #	Mfg #	Description	Handle(s)	Finish	Price
183680	K-T14420-4-SN	Tub & Shower Trim, Push Button Diverter	Lever	*Polished Nickel	
167358	K-T14421-3-CP	Tub & Shower Trim, Push Button Diverter	Cross	Polished Chrome	
105986	K-T14421-4-BN	Tub & Shower Trim, Push Button Diverter	Lever	*Brushed Nickel	
071158	K-T14421-4-CP	Tub & Shower Trim, Push Button Diverter	Lever	Polished Chrome	
178255	K-T14421-4-SN	Tub & Shower Trim, Push Button Diverter	Lever	*Polished Nickel	
171806	K-T14421-4E-CP	Tub & Shower Trim, Push Button Diverter, 2.0 GPM	Lever	Polished Chrome	

Refinia® Rite-Temp® 1-Hdl Tub & Shower Trim

- *Premium construction*
- *MasterClean™ spray nozzles*
- *Intended for use with Rite-Temp® or HiFlow Rite-Temp® valves*
- *Heavy-duty slip-fit clamp design and NPT threaded spout*

Requires:
K-304/K-P304 Series Rite-Temp® Valves
or
K-2971-KS 3/4" Pressure-balancing Valve



Part #	Mfg #	Description	Handle(s)	Finish	Price
225737	K-TS5318-4-BN	Tub & Shower Trim	Lever	*Brushed Nickel	
225738	K-TS5318-4E-BN	Tub & Shower Trim, 2.0 GPM	Lever	*Brushed Nickel	
225736	K-TS5318-4-CP	Tub & Shower Trim	Lever	Polished Chrome	

Revival® Rite-Temp® 1-Hdl Tub & Shower Trim

- *Premium construction*
- *Single function showerhead with showerarm*

Requires:
K-304/K-P304 Series Rite-Temp® Valves
or
K-2971-KS 3/4" Pressure-balancing Valve



Part #	Mfg #	Description	Handle(s)	Finish	Price
129050	K-T16115-4A-BN	Tub & Shower Trim, Pushbutton Diverter	Traditional Lever	*Brushed Nickel	
083239	K-T16115-4A-BV	Tub & Shower Trim, Pushbutton Diverter	Traditional Lever	*Brushed Bronze	
075516	K-T16115-4A-CP	Tub & Shower Trim, Pushbutton Diverter	Traditional Lever	Polished Chrome	

* Vibrant Limited Lifetime Warranty

www.plumbsupply.com • Serving our Customers Since 1946 • www.waterconcepts.net

Tub & Shower Faucets

Faucets & Valves

Single-Handle Tub & Shower Trim (Continued)
Revival® Rite-Temp® 1-Hdl Tub & Shower Trim

Part #	Mfg #	Description	Handle(s)	Finish	Price
059500	K-T16115-4-BN	Tub & Shower Trim, Pushbutton Diverter	Scroll Lever	*Brushed Nickel	
095194	K-T16115-4-BV	Tub & Shower Trim, Pushbutton Diverter	Scroll Lever	*Brushed Bronze	
166935	K-T16115-4-CP	Tub & Shower Trim, Pushbutton Diverter	Scroll Lever	Polished Chrome	

Toobi® Rite-Temp® 1-Hdl Tub & Shower Trim

- Metal construction
- (48) MasterClean™ spray nozzles with Katalyst™ spray technology
- (3) Color options included for the bath spout outlet and showerhead trim ring - white, green, or black
- Push-button diverter
- Flow rate: 2.0 gpm

Requires Valve:
K-11748-K
or
K-11748-KS



Part #	Mfg #	Description	Handle(s)	Finish	Price
159803	K-T8975-4-BN	Tub & Shower Trim, Pushbutton Diverter	Lever	*Brushed Nickel	
154963	K-T8975-4-CP	Tub & Shower Trim, Pushbutton Diverter	Lever	Polished Chrome	

Two-Handle Tub & Shower Trim
Coralais® 2-Hdl Tub & Shower Trim

- Metal construction
- Showerhead, arm and flange
- Reversible 1/2" 1/4-turn washerless ceramic disc valves
- 4-7/8" NPT diverter spout



Requires valve K-302-K

Part #	Mfg #	Description	Handle(s)	Finish	Price
061694	K-T15201-4-CP	Tub & Shower, NPT Diverter Spout	ADA Lever	Polished Chrome	

Revival® 2-Hdl Tub & Shower Trim

- Brass construction, brass valve bodies
- 1/2" quarter-turn washerless ceramic disc valves
- Available with scroll or traditional lever handles
- Diverter spout
- For 8" centers
- Valve included



Part #	Mfg #	Description	Handle(s)	Finish	Price
182409	K-16213-4-CP	Tub & Shower, Diverter Spout	Scroll Lever	Polished Chrome	
163760	K-16213-4A-PB	Tub & Shower, Diverter Spout	Traditional Lever	*Polished Brass	

* Vibrant Limited Lifetime Warranty

www.waterconcepts.net • Serving our Customers Since 1946 • www.plumbsupply.com

Tub & Shower Faucets

Tub & Shower Trim

Baliza Tempassure® Thermostatic Tub & Shower Trim

- Features H2Okinetic® technology
- TempAssure® thermostatic medium flow valving
- Fits MultiChoice® universal valve
- Independent temperature and volume control
- 7-1/8" Round raincan showerhead
- WaterSense® certified product: 2.0 gpm @ 80 psi



Part #	Mfg #	Description	Handle(s)	Finish	Price
143803	T60405-BN	7-1/8" Pull-up Diverter Spout	ADA Lever	Brushed Nickel*	
144000	T60405-PC	7-1/8" Pull-up Diverter Spout	ADA Lever	Chrome	
170005	T60405-PN	7-1/8" Pull-up Diverter Spout	ADA Lever	Polished Nickel*	
170959	T60405-RB	7-1/8" Pull-up Diverter Spout	ADA Lever	Venetian Bronze®	

Charlotte™ Tempassure® Thermostatic Tub & Shower Trim

- Features H2Okinetic® technology
- TempAssure® thermostatic medium flow valving
- Fits MultiChoice® universal valve
- Independent temperature and volume control
- 5-13/16" Round raincan showerhead
- 8" Shower arm
- WaterSense® certified product: 2.0 gpm @ 80 psi



Part #	Mfg #	Description	Handle(s)	Finish	Price
170568	T60485-BN	8-3/8" Pull-Down Diverter Spout	ADA Lever	Brushed Nickel*	
170569	T60485-PC	8-3/8" Pull-Down Diverter Spout	ADA Lever	Chrome	
156583	T60485-PNCO	8-3/8" Pull-Down Diverter Spout Nkl	ADA Lever	Cocoa Brz™/Pol	

Loki® Pressure Balance Tub & Shower Trim

- Features H2Okinetic® technology
- Fits MultiChoice® universal valve
- Handle adjusts temperature
- 5-3/8" Showerhead
- WaterSense® certified product: 2.0 gpm @ 80 psi



Part #	Mfg #	Description	Handle(s)	Finish	Price
161617	T60P420-PC	5-1/2" Pull-Down Diverter Spout	ADA Lever	Chrome	

* Brilliance® Anti-Tarnish Lifetime Finishes

www.plumbsupply.com • Serving our Customers Since 1946 • www.waterconcepts.net

Tub & Shower Faucets

Faucets & Valves

Odin™Tempassure® Thermostatic Tub & Shower Trim

- Features H2Okynamic® technology
- TempAssure® thermostatic medium flow valving
- Fits MultiChoice® universal valve
- Independent temperature and volume control
- 5-3/8" Showerhead
- 16" Shower arm and flange
- WaterSense® certified product: 2.0 gpm @ 80 psi



Part #	Mfg #	Description	Handle(s)	Finish	Price
176994	T60475-BL	5-1/2" Pull-Down Diverter Spout	ADA Lever	Matte Black	
165338	T60475-BN	5-1/2" Pull-Down Diverter Spout	ADA Lever	Brushed Nickel*	
177505	T60475-PC	5-1/2" Pull-Down Diverter Spout	ADA Lever	Chrome	

Siderna Tempassure® Thermostatic Tub & Shower Trim

- TempAssure® thermostatic medium flow valving
- Fits MultiChoice® universal valve
- Independent temperature and volume control
- 8-5/8" x 5-3/4" Rectangle single-function raincan showerhead
- 16" Shower arm
- Maximum flow rate: 2.5 gpm @ 80 psi



Part #	Mfg #	Description	Handle(s)	Finish	Price
177334	T60480-BL	7" Pull-Down Diverter Spout	ADA Lever	Matte Black	
175340	T60480-BN	7" Pull-Down Diverter Spout	ADA Lever	Brushed Nickel*	
151872	T60480-PC	7" Pull-Down Diverter Spout	ADA Lever	Chrome	

Sotria™ Tempassure® Thermostatic Tub & Shower Trim

- Fits MultiChoice® universal valve
- Multi-Function H2Okynamic® showerhead
- Independent temperature and volume control
- WaterSense® certified product: 2.0 gpm @ 80 psi



Part #	Mfg #	Description	Handle(s)	Finish	Price
222411	T60450-BL	9" Pull-Up Diverter Spout	ADA Lever	Matte Black	
178248	T60450-PC	9" Pull-Up Diverter Spout	ADA Lever	Chrome	

* Brilliance® Anti-Tarnish Lifetime Finishes

www.waterconcepts.net • Serving our Customers Since 1946 • www.plumbsupply.com

Tub & Shower Faucets

Tresa® Pressure Balance Tub & Shower Trim

- Features H2Okinetic® technology
- Single-function pressure balance cartridge
- Fits MultiChoice® universal valve
- Handle adjusts temperature
- 7-1/8" Raincan showerhead
- 7" Shower arm
- WaterSense certified product: 2.0 gpm @ 80 psi



Part #	Mfg #	Description	Handle(s)	Finish	Price
176453	T60P410-BN	7" Pull-Up Diverter Spout	ADA Lever	Brushed Nickel*	
171586	T60P410-PC	7" Pull-Up Diverter Spout	ADA Lever	Chrome	

Vesi® Channel Pressure Balance Tub & Shower Trim

- Features H2Okinetic® technology
- Single-function pressure balance cartridge
- Fits MultiChoice® universal valve
- Handle adjusts temperature
- 5-1/4" Showerhead
- WaterSense® certified product: 2 gpm @ 80 psi



Part #	Mfg #	Description	Handle(s)	Finish	Price
165257	T60P440-BN	6-1/2" Pull-Up Diverter Spout	ADA Lever	Brushed Nickel*	

Vesi Tempassure® Thermostatic Tub & Shower Trim

- TempAssure® thermostatic medium flow valving
- Fits MultiChoice® universal rough valve
- Independent temperature and column control
- 5" Showerhead with three spray functions



Part #	Mfg #	Description	Handle(s)	Finish	Price
188602	T60440-RB	6-1/2" Pull-Up Diverter Spout	ADA Lever	Venetian Bronze®	

* Brilliance® Anti-Tarnish Lifetime Finishes

www.plumbsupply.com • Serving our Customers Since 1946 • www.waterconcepts.net

Tub & Shower Faucets

Virage Tempassure® Thermostatic Tub & Shower Trim

- Features H2Okinetic® technology
- TempAssure® thermostatic medium flow valving
- Fits MultiChoice® universal valve
- Independent temperature and volume control
- 6" Square raincan showerhead
- WaterSense® certified product: 2.0 gpm @ 80 psi



Faucets & Valves

Part #	Mfg #	Description	Handle(s)	Finish	Price
135417	T60430-BN	7-3/4" Pull-down Diverter Spout	ADA Lever	Brushed Nickel*	
169193	T60430-PC	7-3/4" Pull-down Diverter Spout	ADA Lever	Chrome	
173283	T60430-RB	7-3/4" Pull-down Diverter Spout	ADA Lever	Venetian Bronze®	

* Brilliance® Anti-Tarnish Lifetime Finishes

www.waterconcepts.net • Serving our Customers Since 1946 • www.plumbsupply.com

Tub & Shower Faucets

Monitor® 13 Series Tub & Shower Trim

Classic Monitor® 13 Series 1-Hdl Tub & Shower Trim

- Fits MultiChoice™ universal valve
- Includes cartridge
- Handle adjusts temperature
- Touch-Clean® showerhead
- Sweat onto 1/2" CWT or thread onto 1/2" IPS
- "-LHD" & "-SLHD" models have pad printed red/blue temperature indication less showerhead
- WaterSense® certified product: 2.0 gpm @ 80 psi
- H2O Model: 1.5 gpm @ 80 psi



Faucets & Valves

Part #	Mfg #	Description	Handle(s)	Finish	Price
092591	T13420	Tub & Shower Trim, 5-1/2" Pull-Up Diverter Spout	ADA Lever	Chrome	
134431	T13420-SS	Tub & Shower Trim, 5-1/2" Pull-Up Diverter Spout	ADA Lever	Stainless*	
114939	T13420-H2O	T&S Trim, 5-1/2" DivSpout, H2OKinetic® Showerhead	ADA Lever	Chrome	
128425	T13420-H2OT	T&S Complete,5-1/2" Div Spout, H2OKinetic® Showerhead	ADA Lever	Chrome	
092594	T13420-PD	Tub & Shower Trim, 6" Pull-Down Diverter Spout	ADA Lever	Chrome	
135314	T13420-SSH2OT	T&S Complete,5-1/2" Div Spout, H2OKinetic® Showerhead	ADA Lever	Stainless*	
136066	T13420-SSPD	Tub & Shower Trim, 6" Pull-Down Diverter Spout	ADA Lever	Stainless*	
092633	T13422	Tub & Shower Trim, 5-1/2" Pull-Up Diverter Spout	Clear Knob	Chrome	
092636	T13422-PDSOS	T&S Trim, 6" Div Spout, Slip-On Spout for 1/2" C.W.T.	Clear Knob	Chrome	
130188	T13491-LHD	T&S Trim, Less Showerhead 4-3/4" Diverter Spout	ADA Lever	Chrome	

Classic Monitor® 13 Series 1-Hdl Tub & Shower Trim

- Fits MultiChoice™ universal valve
- Handle adjusts temperature
- TouchClean®
- 3-Setting showerhead:
 - Full Body
 - Massaging
 - Soft drench
- Sweat onto 1/2" C.W.T or thread onto 1/2" IPS
- (T13420-SHCCER) Slip-on spout for 1/2" C.W.T.
- WaterSense® certified product: 2.0 gpm, @ 80 psi



Part #	Mfg #	Description	Handle(s)	Finish	Price
092596	T13420-SHC	Tub & Shower Trim, 5-1/2" Pull-Up Diverter Spout	ADA lever	Chrome	
174002	T13420-SSHC	Tub & Shower Trim, 5-1/2" Pull-Up Diverter Spout	ADA lever	Stainless*	
166690	T13420-SHCCER	T&S Trim, 7" Slip-On Div Spout, MultiChoice® Ceramic Cartridge	ADA Lever	Chrome	
157014	T13420-PBSHCCER	T&S Trim, 7" Slip-On Div Spout, MultiChoice® Ceramic Cartridge	ADA Lever	Polished Brass*	
092598	T13420-PBSHCPD	Tub & Shower Trim, 6" Pull-Down Div Spt	ADA Lever	Polished Brass*	

* Brilliance® Anti-Tarnish Lifetime Finishes

www.plumbsupply.com • Serving our Customers Since 1946 • www.waterconcepts.net

Tub & Shower Faucets

Faucets & Valves

Foundations® Monitor® 13 Series 1-Hdl Tub & Shower Trim

- Fits MultiChoice® universal valve
- Handle adjusts temperature
- Full body 2" showerhead
- Slip onto 1/2" CWT
- Removable threaded adapter for 1/2" IPS
- WaterSense® certified product
- 2.0 gpm @ 80 psi



Part #	Mfg #	Description	Handle(s)	Finish	Price
133789	BT13410	Tub & Shower Trim, 5-3/8" Pull-Up Tub Spout	ADA Lever	Chrome	
139320	BT13410-SS	Tub & Shower Trim, 5-3/8" Pull-Up Tub Spout	ADA Lever	Stainless*	

Monitor® 14 Series Tub & Shower Trim

Addison™ Monitor® 14 Series 1-Hdl Tub & Shower Trim

- Fits MultiChoice™ universal valve
- Handle adjusts temperature
- Sweat onto 1/2" C.W.T or thread onto 1/2" IPS
- H2Okinetic technology® 6" rain can showerhead
- Self-cleaning H2Okinetic® spray holes
- WaterSense® certified product
- 2.0 gpm @ 80 psi



Part #	Mfg #	Description	Handle(s)	Finish	Price
128169	T14492	Tub & Shower Trim, 7-1/2" Pull-Up Diverter Spout	ADA Lever	Chrome	
137913	T14492-CZ	Tub & Shower Trim, 7-1/2" Pull-Up Diverter Spout	ADA Lever	Champagne Bronze™	
129835	T14492-RB	Tub & Shower Trim, 7-1/2" Pull-Up Diverter Spout	ADA Lever	Venetian Bronze®	
130260	T14492-SS	Tub & Shower Trim, 7-1/2" Pull-Up Diverter Spout	ADA Lever	Stainless*	

Ara™ Monitor® 14 Series 1-Hdl Tub & Shower Trim

- Fits MultiChoice™ universal valve
- Single-function pressure balance cartridge
- Handle adjusts temperature
- 7-1/8" Pull-up diverter spout
- Sweat onto 1/2" CWT or thread onto 1/2" IPS
- (T14467, T14467-SS) WaterSense® certified product: 2.0 gpm @ 80 psi



Part #	Mfg #	Description	Handle(s)	Finish	Price
165653	T14467	Tub & Shower Trim, 7-1/8" Div Spout, H2O Showerhead	ADA Lever	Chrome	
162251	T14467-SS	Tub & Shower Trim, 7-1/8" Div Spout, H2O Showerhead	ADA Lever	Stainless*	
180995	T14467-LHD	Tub & Shower Trim, 7-1/8" Div Spt, Less Head	ADA Lever	Chrome	
177469	T14467-SSLHD	Tub & Shower Trim, 7-1/8" Div Spt Less Head	ADA Lever	Stainless*	

* Brilliance® Anti-Tarnish Lifetime Finishes

www.waterconcepts.net • Serving our Customers Since 1946 • www.plumbsupply.com

Tub & Shower Faucets

Ara™ Monitor 14 Series 1-Hdl Tub & Shower Trim with H2Okinetic®

- Fits MultiChoice™ universal valve
- Handle adjusts temperature
- H2Okinetic® 4" raincan showerhead
- Self-Cleaning H2Okinetic® spray holes
- Sweat onto 1/2" C.W.T. or thread onto 1/2" IPS
- WaterSense® certified product: 2.0 gpm @ 80 psi



Part #	Mfg #	Description	Handle(s)	Finish	Price
174340	T14467-H2O	Tub & Shower Trim, 7-1/8" Diverter Spout	ADA Lever	Chrome	
175937	T14467-SSH2O	Tub & Shower Trim, 7-1/8" Diverter Spout	ADA Lever	Stainless*	

Ara™ Temp2O® Angular Modern 1-Hdl Tub & Shower Trim

- Fits MultiChoice™ universal valve
- Touch-Clean® spray holes
- Temp2O® Technology
- Self-cleaning H2Okinetic® spray holes
- Digital temperature display with color indication
- Handle adjusts temperature
- Sweat onto 1/2" CWT or thread onto 1/2" IPS
- 3-Setting H2Okinetic® 8" raincan showerhead
- WaterSense® certified product: 2.0 gpm @ 80 psi



Part #	Mfg #	Description	Handle(s)	Finish	Price
173079	T14401-T2O	Tub & Shower Trim, 7-1/8" Pull-Up Div Spout	ADA Lever	Chrome	
176971	T14401-SSH2O	Tub & Shower Trim, 7-1/8" Pull-Up Div Spout	ADA Lever	Stainless*	

Arzo® Monitor® 14 Series 1-Hdl Tub & Shower Trim

- Fits MultiChoice™ universal valve
- Handle adjusts temperature
- Sweat onto 1/2" CWT or thread onto 1/2" IPS
- H2Okinetic® 6" raincan shower head
- Self-cleaning spray head
- WaterSense® certified product: 2.0 gpm @ 80 psi



Part #	Mfg #	Description	Handle(s)	Finish	Price
110917	T14486	Tub & Shower Trim, 7-1/8" Pull-Up Div Spout	ADA Lever	Chrome	
110918	T14486-SS	Tub & Shower Trim, 7-1/8" Pull-Up Div Spout	ADA Lever	Stainless*	

* Brilliance® Anti-Tarnish Lifetime Finishes

www.plumbsupply.com • Serving our Customers Since 1946 • www.waterconcepts.net

Tub & Shower Faucets

Faucets & Valves

Ashlyn™ Monitor® 14 Series 1-Hdl Tub & Shower Trim

- Fits MultiChoice™ universal valve
- Sweat onto 1/2" CWT or thread onto 1/2" IPS
- Handle adjusts temperature
- Touch-Clean® 5-1/4" raincan showerhead
- WaterSense® certified product: 2.0 gpm @ 80 psi
- **(-LHD) Showerhead Sold Separately**



Part #	Mfg #	Description	Handle(s)	Finish	Price
173154	T14464	Tub & Shower Trim, 7-15/16" Pull-Up Diverter Spout	ADA Lever	Chrome	
173156	T14464-RB	Tub & Shower Trim, 7-15/16 " Pull-Up Diverter Spout	ADA Lever	Venetian Bronze®	
170526	T14464-SS	Tub & Shower Trim, 7-15/16 " Pull-Up Diverter Spout	ADA Lever	Stainless*	
222505	T14464-LHD	Tub & Shower Trim, 7-15/16" Pull-Up Divr Spt Less Head	ADA Lever	Chrome	
228394	T14464-RBLHD	Tub & Shower Trim, 7-15/16" Pull-Up Divr Spt Less Head	ADA Lever	Venetian Bronze®	
185951	T14464-SSLHD	Tub & Shower Trim, 7-15/16" Diverter Spout Less Head	ADA Lever	Stainless*	

Cassidy™ Monitor 14 Series 1-Hdl Tub & Shower Trim

- Fits MultiChoice™ universal valve
- Handle adjusts temperature
- Sweat onto 1/2" CWT or thread onto 1/2" IPS
- H2Okinetic® 8" raincan showerhead with self-cleaning spray holes
- WaterSense® certified product: 2.0 gpm @ 80 psi
- **(-LHP) Handle sold separately**



Part #	Mfg #	Description	Handle(s)	Finish	Price
151996	T14497-LHP	Tub & Shower Trim, 7-2/3" Div Spt	Less Handles	Chrome	
182756	T14497-CZLHP	Tub & Shower Trim, 7-2/3" Div Spt	Less Handles	Champagne Bronze™	
153341	T14497-PNLHP	Tub & Shower Trim, 7-2/3" Div Spt	Less Handles	Polished Nickel*	
152960	T14497-RBLHP	Tub & Shower Trim, 7-2/3" Div Spt	Less Handles	Venetian Bronze®	
153498	T14497-SSLHP	Tub & Shower Trim, 7-2/3" Div Spt	Less Handles	Stainless*	
174088	T14497-LHP-LHD	Tub & Shower Trim, 7-2/3" Div Spt, Less Showerhead	Less Handles	Chrome	
171306	T14497-SSLHP-LHD	Tub & Shower Trim, 7-2/3" Div Spt, Less Showerhead	Less Handles	Stainless*	

* Brilliance® Anti-Tarnish Lifetime Finishes

www.waterconcepts.net • Serving our Customers Since 1946 • www.plumbsupply.com

Tub & Shower Faucets

Compel™ Monitor 14 Series 1-Hdl Tub & Shower Trim

- Fits MultiChoice™ universal valve
- Handle adjusts temperature
- H2Okinetic® 5-1/2" raincan showerhead
- Self-cleaning H2Okinetic® spray holes
- Sweat onto 1/2" CWT or thread onto 1/2" IPS
- WaterSense® certified product: 2.0 gpm @ 80 psi



Faucets & Valves

Part #	Mfg #	Description	Handle(s)	Finish	Price
157512	T14461	Tub & Shower Trim, 7" Pull-Down Spout	ADA Lever	Chrome	
161007	T14461-LHD	Tub & Shower Trim, 7" Pull-Down Spout, Less Head	ADA Lever	Chrome	
156779	T14461-SS	Tub & Shower Trim, 7" Pull-Down Spout	ADA Lever	Stainless*	

Dryden™ Monitor® 14 Series 1-Hdl Tub & Shower Trim

- Fits MultiChoice® universal valve
- Handle adjusts temperature
- Touch-Clean® rain can showerhead
- Sweat onto 1/2" CWT or thread onto 1/2" IPS
- 2.5 gpm @ 80 psi
- H2O Model: WaterSense® certified 2.0 gpm @ 80 psi



Part #	Mfg #	Description	Handle(s)	Finish	Price
116299	T14451	Tub & Shower Trim, 7-1/2" Pull-Up Spout	ADA Lever	Chrome	
158508	T14451-CZ	Tub & Shower Trim, 7-1/2" Pull-Up Spout	ADA Lever	Champagne Bronze™	
116301	T14451-RB	Tub & Shower Trim, 7-1/2" Pull-Up Spout	ADA Lever	Venetian Bronze®	
116302	T14451-SS	Tub & Shower Trim, 7-1/2" Pull-Up Spout	ADA Lever	Stainless*	
162272	T14451-H2O	Tub & Shower Trim, 7-1/2" Pull-Up Spout H2O Showerhead	ADA Lever	Chrome	
226544	T14451-PNH2O	Tub & Shower Trim, 7-1/2" Pull-Up Spout H2O Showerhead	ADA Lever	Polished Nickel*	
168325	T14451-RBH2O	Tub & Shower Trim, 7-1/2" Pull-Up Spout H2O Showerhead	ADA Lever	Venetian Bronze®	
171798	T14451-SSH2O	Tub & Shower Trim, 7-1/2" Pull-Up Spout H2O Showerhead	ADA Lever	Stainless*	
174474	T14451-LHD	Tub & Shower Trim, 7-1/2" Less Showerhead	ADA Lever	Chrome	

Lahara™ Monitor® 14 Series 1-Hdl Tub & Shower Trim

- Fits MultiChoice™ universal valve
- Handle adjusts temperature
- Sweat onto 1/2" C.W.T. or thread onto 1/2" IPS
- Touch-Clean® full body showerhead
- WaterSense® certified product
- 2.0 gpm @ 80 psi



Part #	Mfg #	Description	Handle(s)	Finish	Price
110985	T14438	Tub & Shower Trim, 6-3/4" Pull-Up Spout	ADA Lever	Chrome	

* Brilliance® Anti-Tarnish Lifetime Finishes

www.plumbsupply.com • Serving our Customers Since 1946 • www.waterconcepts.net

Tub & Shower Faucets

Monitor® 14 Series Tub & Shower Trim (Continued)

Lahara™ Monitor® 14 Series 1-Hdl Tub & Shower Trim

Part #	Mfg #	Description	Handle(s)	Finish	Price
156450	T14438-CZ	Tub & Shower Trim, 6-3/4" Pull-Up Spout	ADA Lever	Champagne Bronze™	
110987	T14438-RB	Tub & Shower Trim, 6-3/4" Pull-Up Spout	ADA Lever	Venetian Bronze®	
110988	T14438-SS	Tub & Shower Trim, 6-3/4" Pull-Up Spout	ADA Lever	Stainless*	
132447	T14438-RBH2O	Tub & Shower Trim, 5-1/2" Spout, H2Ok kinetic Showerhead	ADA Lever	Venetian Bronze®	
180448	T14438-LHD	Tub & Shower Trim, 6-3/4" Pull-Up Spout Less Showerhead	ADA Lever	Chrome	
170039	T14438-SSLHD	Tub & Shower Trim, 6-3/4" Pull-Up Spout Less Showerhead	ADA Lever	Stainless*	

Leland® Monitor® 14 Series Tub & Shower Trim

- Fits MultiChoice™ universal valve
- Handle adjusts temperature
- Sweat onto 1/2" CWT or thread onto 1/2" IPS
- Touch-Clean™ 4-setting showerhead
- WaterSense® certified product: 2.0 gpm @ 80 psi



Part #	Mfg #	Description	Handle(s)	Finish	Price
169503	T14478-RBSHCCER	Tub & Shower Trim, 5-1/2" Pull-Up Diverter Spout	ADA Lever	Venetian Bronze®	
164706	T14478-SSSHCCER	Tub & Shower Trim, 5-1/2" Pull-Up Diverter Spout	ADA Lever	Stainless*	

Linden™ Monitor® 14 Series 1-Hdl Tub & Shower Trim

- Fits MultiChoice™ universal valve
- Handle adjusts temperature
- Sweat onto 1/2" CWT or thread onto 1/2" IPS
- Touch-Clean® showerhead
- 2.5 gpm @ 80 psi
- H2O Model -WaterSense® certified: 1.5 gpm @ 80 psi



T14494

H2O

T14493

Part #	Mfg #	Description	Handle(s)	Finish	Price
225483	T14493	Tub & Shower Trim, 6-1/2" Tub Spout	ADA Lever	Chrome	
222402	T14493-RB	Tub & Shower Trim, 6-1/2" Tub Spout	ADA Lever	Venetian Bronze®	
223249	T14493-SS	Tub & Shower Trim, 6-1/2" Tub Spout	ADA Lever	Stainless*	
144713	T14494	Tub & Shower Trim, 6-1/2" Tub Spout	ADA Lever	Chrome	
143316	T14494-RB	Tub & Shower Trim, 6-1/2" Tub Spout	ADA Lever	Venetian Bronze®	
143399	T14494-SS	Tub & Shower Trim, 6-1/2" Tub Spout	ADA Lever	Stainless*	
154145	T14494-H2O	Tub & Shower Trim, 6-1/2" Tub Spout, H2Ok kinetic®	ADA Lever	Chrome	
172877	T14494-RBH2O	Tub & Shower Trim, 6-1/2" Tub Spout, H2Ok kinetic®	ADA Lever	Venetian Bronze®	
163981	T14494-SSH2O	Tub & Shower Trim, 6-1/2" Tub Spout, H2Ok kinetic®	ADA Lever	Stainless*	

* Brilliance® Anti-Tarnish Lifetime Finishes

www.waterconcepts.net • Serving our Customers Since 1946 • www.plumbsupply.com

Tub & Shower Faucets

Tesla® Monitor® 14 Series 1-Hdl Tub & Shower Trim

- Fits MultiChoice® universal valve
- Handle adjusts temperature
- Sweat onto 1/2" C.W.T. or thread onto 1/2" IPS
- H2Okinetic® 7-1/2" showerhead
- WaterSense® certified: 2.0 gpm @ 80 psi



Part #	Mfg #	Description	Handle(s)	Finish	Price
184440	T14452-SS	Tub & Shower Trim, 5-1/2" Pull-Up Div Spout	ADA Lever	Stainless*	
186917	T14452-LHD	Tub & Shower Trim, 5-1/2" Pull-Up Div Spout, LESS Head	ADA Lever	Chrome	

Trinsic™ Monitor® 14 Series 1-Hdl Tub & Shower Trim

- Fits MultiChoice® universal valve
- Handle adjusts temperature
- H2Okinetic® 5-1/2" showerhead
- Sweat onto 1/2" C.W.T. or thread onto 1/2" IPS
- WaterSense® certified product: 2.0 gpm @ 80 psi



Part #	Mfg #	Description	Handle(s)	Finish	Price
153086	T14459	Tub & Shower Trim, 6-1/8" Diverter Spout	ADA Lever	Chrome	
153087	T14459-CZ	Tub & Shower Trim, 6-1/8" Diverter Spout	ADA Lever	Champagne Bronze™	
153088	T14459-RB	Tub & Shower Trim, 6-1/8" Diverter Spout	ADA Lever	Venetian Bronze®	
153089	T14459-SS	Tub & Shower Trim, 6-1/8" Diverter Spout	ADA Lever	Stainless*	
160461	T14459-LHD	Tub & Shower Trim, 6-1/8" Div Spout, Less Head	ADA Lever	Chrome	
178605	T14459-SSLHD	Tub & Shower Trim, 6-1/8" Div Spout, Less Head	ADA Lever	Stainless*	

Temp2O® Traditional 14 Series 1-Hdl Tub & Shower Trim

- Fits MultiChoice™ universal valve
- Temp2O™ technology
- 3-Setting 8" H2Okinetic® raincan showerhead
- Handle adjusts temperature
- Sweat onto 1/2" CWT or thread onto 1/2" IPS
- Touch-Clean® spray holes
- Self-cleaning H2Okinetic® spray holes
- WaterSense® certified product: 2.0 gpm @ 80 psi



Part #	Mfg #	Description	Handle(s)	Finish	Price
168076	T14400-T2O	Tub & Shower Trim, 6-1/2" Pull-Up Tub Spout	ADA Lever	Chrome	
172017	T14400-SST2O	Tub & Shower Trim, 6-1/2" Pull-Up Tub Spout	ADA Lever	Stainless*	

* Brilliance® Anti-Tarnish Lifetime Finishes

www.plumbsupply.com • Serving our Customers Since 1946 • www.waterconcepts.net

Tub & Shower Faucets

Faucets & Valves

Transitional 14 Series Temp2O® 1-Hdl Tub & Shower

- Fits MultiChoice™ universal valve
- Temp2O™ Technology
- H2Okinetic® Three-setting showerhead
- Handle adjusts temperature
- Self-cleaning H2Okinetic® spray holes
- Touch-Clean® spray holes
- Sweat onto 1/2" CWT or thread onto 1/2" IPS
- WaterSense® certified product: 2.0 gpm @ 80 psi



Part #	Mfg #	Description	Handle(s)	Finish	Price
174950	T14403-PNT2O	Tub & Shower Trim, 6-3/4" Pull-Up Div Spout	ADA Lever	Polished Nickel*	
185338	T14403-SST2O	Tub & Shower Trim, 6-3/4" Pull-Up Div Spout	ADA Lever	Stainless*	

Vero™ Monitor® 14 Series 1-Hdl Tub & Shower Trim

- Fits MultiChoice™ universal valve
- Handle adjusts temperature
- Sweat onto 1/2" CWT or thread onto 1/2" IPS
- Maximum flow rate: 2.5 gpm @ 80 psi
- H2O Model-WaterSense® certified: 2.0 gpm @ 80 psi



H2O

Part #	Mfg #	Description	Handle(s)	Finish	Price
134783	T14453	T&S Trim, 7-1/8" Div Spout, Touch-Clean® Head	ADA Lever	Chrome	
159333	T14453-RB	T&S Trim, 7-1/8" Div Spout, Touch-Clean® Head	ADA Lever	Venetian Bronze®	
134784	T14453-SS	T&S Trim, 7-1/8" Div Spout, Touch-Clean® Head	ADA Lever	Stainless*	
188279	T14453-LHD	T&S Trim, 7-1/8" Div Spout, Less Showerhead	ADA Lever	Chrome	
155691	T14453-H2O	T&S Trim, 7-1/8" Div Spout, H2Okinetic® Head	ADA Lever	Chrome	
150724	T14453-RBH2O	T&S Trim, 7-1/8" Div Spout, H2Okinetic® Head	ADA Lever	Venetian Bronze®	
150516	T14453-SSH2O	T&S Trim, 7-1/8" Div Spout, H2Okinetic® Head	ADA Lever	Stainless*	

Victorian® Monitor® 14 Series 1-Hdl Tub & Shower Trim

- Fits MultiChoice™ universal valve
- Handle adjusts temperature
- Sweat onto 1/2" CWT or thread onto 1/2" IPS
- 2.5 gpm @ 80 psi
- H2O model-WaterSense® certified: 1.5 gpm @ 80 psi



Part #	Mfg #	Description	Handle(s)	Finish	Price
092745	T14455-LHP	T&S Trim, 6-1/2" Div Spout, Touch-Clean® Head	Less Handle	Chrome	
092751	T14455-RBLHP	T&S Trim, 6-1/2" Div Spout, Touch-Clean® Head	Less Handle	Venetian Bronze®	
169764	T14455-SSH2OLHP	T&S Trim, 6-1/2" Div Spout, H2Okinetic® Head	Less Handle	Stainless*	

* Brilliance® Anti-Tarnish Lifetime Finishes

www.waterconcepts.net • Serving our Customers Since 1946 • www.plumbsupply.com

Tub & Shower Faucets

Monitor® 14 Series Tub & Shower Trim (Continued) Victorian® Monitor® 14 Series 1-Hdl Tub & Shower Trim

Part #	Mfg #	Description	Handle(s)	Finish	Price
092752	T14455-SSLHP	T&S Trim, 6-1/2" Div Spout, Touch-Clean® Head	Less Handle	Stainless*	

Windemere® Monitor® 14 Series 1-Hdl Tub & Shower Trim

- Fits MultiChoice™ universal valve
- Handle adjusts temperature
- Slip onto 1/2" C.W.T.
- Removable threaded adapter for 1/2" IPS
- Full body 6" raincan showerhead
- WaterSense® certified product
- 2.0 gpm @ 80 psi



Part #	Mfg #	Description	Handle(s)	Finish	Price
132753	BT14496	Tub & Shower Trim, 5-3/8" Pull-Up Div Spout	ADA Lever	Chrome	
133543	BT14496-OB	Tub & Shower Trim, 5-3/8" Pull-Up Div Spout	ADA Lever	Oil Rubbed Bronze	
135987	BT14496-SS	Tub & Shower Trim, 5-3/8" Pull-Up Div Spout	ADA Lever	Stainless*	

Monitor® 17 Series Tub & Shower Trim

Addison™ Monitor® 17 Series Tub & Shower Trim

- Fits MultiChoice™ universal valve
- Handle adjusts volume
- Dial adjusts temperature
- Sweat onto 1/2" C.W.T. or thread into 1/2" IPS
- H2Okinetic® technology® 6" showerhead
- Self-cleaning H2Okinetic® spray holes
- WaterSense® certified product: 2.0 gpm @ 80 psi



Part #	Mfg #	Description	Handle(s)	Finish	Price
128424	T17492	Tub & Shower Trim, 7-1/2" Pull-Up Diverter Spout	ADA Lever	Chrome	
139329	T17492-CZ	Tub & Shower Trim, 7-1/2" Pull-Up Diverter Spout	ADA Lever	Champagne Bronze™	
129202	T17492-RB	Tub & Shower Trim, 7-1/2" Pull-Up Diverter Spout	ADA Lever	Venetian Bronze®	
128428	T17492-SS	Tub & Shower Trim, 7-1/2" Pull-Up Diverter Spout	ADA Lever	Stainless*	

* Brilliance® Anti-Tarnish Lifetime Finishes

www.plumbsupply.com • Serving our Customers Since 1946 • www.waterconcepts.net

Tub & Shower Faucets

Faucets & Valves

Ara™ Monitor® 17 Series Tub & Shower Trim

- Fits MultiChoice™ universal valve
- H2Okinetic® 6" showerhead
- Handle adjusts volume, dial adjusts temperature
- Sweat onto 1/2" C.W.T. or thread onto 1/2" IPS
- Self-cleaning H2Okinetic® spray holes
- WaterSense® certified product: 2.0 gpm @ 80 psi



Part #	Mfg #	Description	Handle(s)	Finish	Price
170071	T17467	Tub & Shower Trim, 7-1/8" Pull-Up Div Spout	ADA Lever	Chrome	
180017	T17467-SS	Tub & Shower Trim, 7-1/8" Pull-Up Div Spout	ADA Lever	Stainless*	

Ashlyn® Monitor® 17 Series Tub & Shower Trim

- Fits MultiChoice® universal valve
- Handle adjusts volume, dial adjusts temperature
- Sweat onto 1/2" CWT or thread onto 1/2" IPS
- Touch-Clean® 5-1/4" raincan showerhead
- WaterSense® certified product: 2.0 gpm @ 80 psi



Part #	Mfg #	Description	Handle(s)	Finish	Price
174262	T17464	Tub & Shower Trim, 7-15/16" Pull-Up Div Spt	ADA Lever	Chrome	
185273	T17464-RB	Tub & Shower Trim, 7-15/16" Pull-Up Div Spt	ADA Lever	Venetian Bronze®	
176649	T17464-SS	Tub & Shower Trim, 7-15/16" Pull-Up Div Spt	ADA Lever	Stainless*	

Ashlyn® Monitor® 17 Series Tub & Shower Trim with In2ition®

- Fits MultiChoice™ universal valve
- In2ition® intergrated showerhead and hand shower
- Touch-Clean® spray holes
- Handle adjusts volume, dial adjusts temperature
- Sweat onto 1/2" CWT or thread onto 1/2" IPS
- In2ition integrated showerhead and handshower
- 5-Setting handshower with Soft-Touch® grip
- 69" long UltraFlex® hose
- Plated spray face
- Maximum flow rate: 2.5 gpm @ 80 psi



Part #	Mfg #	Description	Handle(s)	Finish	Price
174455	T17464-I	Tub & Shower Trim, 7-15/16" Pull-Up Div Spt	ADA Lever	Chrome	
171776	T17464-RB-I	Tub & Shower Trim, 7-15/16" Pull-Up Div Spt	ADA Lever	Venetian Bronze®	
172467	T17464-SS-I	Tub & Shower Trim, 7-15/16" Pull-Up Div Spt	ADA Lever	Stainless*	

* Brilliance® Anti-Tarnish Lifetime Finishes

www.waterconcepts.net • Serving our Customers Since 1946 • www.plumbsupply.com

Tub & Shower Faucets

Cassidy™ Monitor 17 Series Tub & Shower Trim

- Fits MultiChoice™ universal valve
- H2Okinetic® 8" raincan showerhead
- Handle adjusts volume, dial adjusts temperature
- Sweat onto 1/2" CWT or thread onto 1/2" IPS
- Self-cleaning H2Okinetic® spray holes
- WaterSense® certified product: 2.0 gpm @ 80 psi



Part #	Mfg #	Description	Handle(s)	Finish	Price
152236	T17497	Tub & Shower Trim, 7-2/3" Pull-Up Div Spout	ADA Lever	Chrome	
188608	T17497-CZ	Tub & Shower Trim, 7-2/3" Pull-Up Div Spout	ADA Lever	Champagne Bronze™	
172788	T17497-PN	Tub & Shower Trim, 7-2/3" Pull-Up Div Spout	ADA Lever	Polished Nickel*	
151959	T17497-RB	Tub & Shower Trim, 7-2/3" Pull-Up Div Spout	ADA Lever	Venetian Bronze®	
151983	T17497-SS	Tub & Shower Trim, 7-2/3" Pull-Up Div Spout	ADA Lever	Stainless*	

Classic Monitor® 17 Series Tub & Shower Trim

- Fits MultiChoice™ universal valve
- Handle adjusts volume, dial adjusts temperature
- Sweat onto 1/2" CWT or thread onto 1/2" IPS
- Touch-Clean® 3-setting showerhead
- WaterSense certified product: 2.0 gpm @ 80 psi



SOS=Slip-on spout for 1/2" C.W.T



Part #	Mfg #	Description	Handle(s)	Finish	Price
092714	T17430	Tub & Shower Trim, 6-1/8" Div Spout	ADA Lever	Chrome	
092721	T17430-SOS	Tub & Shower Trim, 6-1/8" Div Spout w/ SOS	ADA Lever	Chrome	
153925	T17430-SS	Tub & Shower Trim, 6-1/8" Div Spout	ADA Lever	Stainless*	
155193	T17430-SSSOS	Tub & Shower Trim, 6-1/8" Div Spt w/ SOS	ADA Lever	Stainless*	

Compel™ Monitor® 17 Series Tub & Shower Trim

- Fits MultiChoice™ universal valve
- Handle adjusts volume, dial adjusts temperature
- H2Okinetic® 5-1/2" raincan showerhead
- Self-cleaning H2Okinetic® spray holes
- Sweat onto 1/2" CWT or thread onto 1/2" IPS
- WaterSense® certified: 2.0 gpm @ 80 psi



Part #	Mfg #	Description	Handle(s)	Finish	Price
151179	T1746	Tub & Shower Trim, 7" Pull-Up Tub Spout	ADA Lever	Chrome	
161484	T17461-SS	Tub & Shower Trim, 7" Pull-Up Tub Spout	ADA Lever	Stainless*	

* Brilliance® Anti-Tarnish Lifetime Finishes

www.plumbsupply.com • Serving our Customers Since 1946 • www.waterconcepts.net

Tub & Shower Faucets

Faucets & Valves

Dryden™ Monitor® 17 Series Tub & Shower Trim

- Fits MultiChoice™ universal valve
- Handle adjusts volume, dial adjusts temperature
- Sweat onto 1/2" CWT or thread onto 1/2" IPS
- 2.5 gpm @ 80 psi
- H2O model-WaterSense® certified: 2.0 gpm @ 80 psi



Part #	Mfg #	Description	Handle(s)	Finish	Price
116307	T17451	T&S Trim, 7-1/2" Div Spout, Touch-Clean® Head	ADA Lever	Chrome	
146210	T17451-CZ	T&S Trim, 7-1/2" Div Spout, Touch-Clean® Head	ADA Lever	Champagne Bronze™	
178257	T17451-PN	T&S Trim, 7-1/2" Div Spout, Touch-Clean® Head	ADA Lever	Polished Nickel*	
116309	T17451-RB	T&S Trim, 7-1/2" Div Spout, Touch-Clean® Head	ADA Lever	Venetian Bronze®	
116310	T17451-SS	T&S Trim, 7-1/2" Div Spout, Touch-Clean® Head	ADA Lever	Stainless*	
167372	T17451-H2O	T&S Trim, 7-1/2" Div Spout, H2Okinetic® Head	ADA Lever	Chrome	
132424	T17451-SSH2O	T&S Trim, 7-1/2" Div Spout, H2Okinetic® Head	ADA Lever	Stainless*	

Lahara™ Monitor® 17 Series Tub & Shower Trim

- Fits MultiChoice™ universal valve
- Handle adjusts temperature, dial adjusts temperature
- Sweat onto 1/2" C.W.T or thread onto 1/2" IPS
- 2.5 gpm @ 80 psi
- H2O model-WaterSense® certified: 2.0 gpm @ 80 psi



Part #	Mfg #	Description	Handle(s)	Finish	Price
111002	T17438	T&S Trim, 6-3/4" Div Spout, Touch-Clean® Head	ADA Lever	Chrome	
190192	T17438-CZ	T&S Trim, 6-3/4" Div Spout, Touch-Clean® Head	ADA Lever	Champagne Bronze™	
111004	T17438-RB	T&S Trim, 6-3/4" Div Spout, Touch-Clean® Head	ADA Lever	Venetian Bronze®	
111005	T17438-SS	T&S Trim, 6-3/4" Div Spout, Touch-Clean® Head	ADA Lever	Stainless*	
172474	T17438-H2O	T&S Trim, 6-3/4" Div Spout, H2Okinetic® Head	ADA Lever	Chrome	
160802	T17438-SSH2O	T&S Trim, 6-3/4" Div Spout, H2Okinetic® Head	ADA Lever	Stainless*	

Linden™ Monitor® 17 Series Tub & Shower Trim

- Fits MultiChoice™ universal valve
- Handle adjusts volume, dial adjusts temperature
- Sweat onto 1/2" CWT or thread onto 1/2" IPS
- H2Okinetic® 6-1/2" raincan showerhead
- Self-cleaning H2Okinetic® spray holes
- WaterSense® certified product, 2.0 gpm @ 80 psi



T17494

T17493



Part #	Mfg #	Description	Handle(s)	Finish	Price
190199	T17493	Tub & Shower Trim, 6-1/2" Pull-Up Div Spout	ADA Lever	Chrome	

* Brilliance® Anti-Tarnish Lifetime Finishes

www.waterconcepts.net • Serving our Customers Since 1946 • www.plumbsupply.com

Tub & Shower Faucets

Monitor® 17 Series Tub & Shower Trim (Continued)

Linden™ Monitor® 17 Series Tub & Shower Trim

Part #	Mfg #	Description	Handle(s)	Finish	Price
227835	T17493-SS	Tub & Shower Trim, 6-1/2" Pull-Up Div Spout	ADA Lever	Stainless	
144786	T17494	Tub & Shower Trim, 6-1/2" Pull-Up Div Spout	ADA Lever	Chrome	
144071	T17494-RB	Tub & Shower Trim, 6-1/2" Pull-Up Div Spout	ADA Lever	Venetian Bronze®	
143647	T17494-SS	Tub & Shower Trim, 6-1/2" Pull-Up Div Spout	ADA Lever	Stainless*	

Linden™ Monitor® 17 Series Shower Trim with In2ition®

- Fits MultiChoice™ universal valve
- In2ition® integrated showerhead and handshower
- Touch-Clean® spray holes
- Four-setting handshower
- 69" Long UltraFlex® hose
- Handle adjusts volume; dial adjusts temperature
- Sweat into 1/2" CWT or thread onto 1/2" IPS
- 2.5 gpm @ 80 psi



Part #	Mfg #	Description	Handle(s)	Finish	Price
143817	T17494-I	Tub & Shower Trim, 6-1/2" Div Spout w/ Handshower	ADA Lever	Chrome	
144075	T17494-CZ-I	Tub & Shower Trim, 6-1/2" Div Spout w/ Handshower	ADA Lever	Champagne Brz™	
144263	T17494-RB-I	Tub & Shower Trim, 6-1/2" Div Spout w/ Handshower	ADA Lever	Venetian Bronze®	
143643	T17494-SS-I	Tub & Shower Trim, 6-1/2" Div Spout w/ Handshower	ADA Lever	Stainless*	

Tesla® Monitor® 17 Series Tub & Shower Trim

- Fits MultiChoice™ universal valve
- Handle adjusts volume, dial adjusts temperature
- Sweat onto 1/2" C.W.T or thread onto 1/2" IPS
- H2Okinetic® 3-Setting 7-1/2" raincan showerhead
- Self-cleaning H2Okinetic® spray holes
- WaterSense® certified product: 2.0 gpm @ 80 psi



Part #	Mfg #	Description	Handle(s)	Finish	Price
188062	T17452	Tub & Shower Trim, 5-1/2" Pull-Up Diverter Spout	ADA Lever	Chrome	
181217	T17452-SS	Tub & Shower Trim, 5-1/2" Pull-Up Diverter Spout	ADA Lever	Stainless*	

* Brilliance® Anti-Tarnish Lifetime Finishes

www.plumbsupply.com • Serving our Customers Since 1946 • www.waterconcepts.net

Tub & Shower Faucets

Faucets & Valves

Trinsic® Monitor 17 Series Tub & Shower Trim

- Fits MultiChoice™ universal valve
- Handle adjusts volume, dial adjusts temperature
- Sweat onto 1/2" C.W.T or thread onto 1/2" IPS
- H2Okinetic® 5-1/2" raincan showerhead
- Self-cleaning H2Okinetic® spray holes
- WaterSense® certified product: 2.0 gpm @ 80 psi



Part #	Mfg #	Description	Handle(s)	Finish	Price
153350	T17459	Tub & Shower Trim, 6-1/8" Pull-Up Diverter Spout	ADA Lever	Chrome	
179562	T17459-CZ	Tub & Shower Trim, 6-1/8" Pull-Up Diverter Spout	ADA Lever	Champagne Bronze™	
172057	T17459-RB	Tub & Shower Trim, 6-1/8" Pull-Up Diverter Spout	ADA Lever	Venetian Bronze®	
156458	T17459-SS	Tub & Shower Trim, 6-1/8" Pull-Up Diverter Spout	ADA Lever	Stainless*	

Vero™ Monitor® 17 Series Tub & Shower Trim

- Fits MultiChoice® universal valve
- Handle adjusts temperature, dial adjusts volume
- Sweat onto 1/2" CWT or thread onto 1/2" IPS
- Maximum flow rate: 2.5 gpm @ 80 psi
- H2O Model flow rate-WaterSense® certified: 2.0 gpm @ 80 psi



H2O

Part #	Mfg #	Description	Handle(s)	Finish	Price
147589	T17453	T&S Trim, 7-1/8" Div Spout, Touch-Clean® Head	ADA Lever	Chrome	
146149	T17453-CZ	T&S Trim, 7-1/8" Div Spout, Touch-Clean® Head	ADA Lever	Champagne Bronze™	
154169	T17453-RB	T&S Trim, 7-1/8" Div Spout, Touch-Clean® Head	ADA Lever	Venetian Bronze®	
135685	T17453-SS	T&S Trim, 7-1/8" Div Spout, Touch-Clean® Head	ADA Lever	Stainless*	
137220	T17453-H2O	T&S Trim, 7-1/8" Div Spout, H2Okinetic® Head	ADA Lever	Chrome	
137219	T17453-SSH2O	T&S Trim, 7-1/8" Div Spout, H2Okinetic® Head	ADA Lever	Stainless*	

* Brilliance® Anti-Tarnish Lifetime Finishes

www.waterconcepts.net • Serving our Customers Since 1946 • www.plumbsupply.com

Tub & Shower Faucets

Victorian™ Monitor® 17 Series Tub & Shower Trim

- Fits MultiChoice™ universal valve
- Handle adjusts volume, dial adjusts temperature
- Sweat onto 1/2" CWT or thread onto 1/2" IPS
- 2.5 gpm @ 80 psi
- H2O Model-WaterSense® certified: 2.0 gpm @ 80 psi



H2O

Faucets & Valves

Part #	Mfg #	Description	Handle(s)	Finish	Price
092849	T17455	T&S Trim, 6-1/2" Div Spout, Touch-Clean® Head	ADA Lever	Chrome	
170224	T17455-CZ	T&S Trim, 6-1/2" Div Spout, Touch-Clean® Head	ADA Lever	Champagne Bronze™	
092855	T17455-RB	T&S Trim, 6-1/2" Div Spout, Touch-Clean® Head	ADA Lever	Venetian Bronze®	
092856	T17455-SS	T&S Trim, 6-1/2" Div Spout, Touch-Clean® Head	ADA Lever	Stainless*	
162314	T17455-RBH2O	T&S Trim, 6-1/2" Div Spout, H2Okinetic® Head	ADA Lever	Venetian Bronze®	
163294	T17455-SSH2O	T&S Trim, 6-1/2" Div Spout, H2Okinetic® Head	ADA Lever	Stainless*	

TempAssure® 17T Series Tub & Shower Trim

Addison® TempAssure® 17T Series Tub & Shower Trim

- Fits MultiChoice™ universal valve
- Handle adjusts volume, dial adjusts temperature
- Sweat onto 1/2" CWT or thread onto 1/2" IPS
- H2Okinetic 8" raincan showerhead
- Self-cleaning H2Okinetic® spray holes
- 2.0 gpm @ 80 psi



Part #	Mfg #	Description	Handle(s)	Finish	Price
184873	T17T492	Tub & Shower Trim, 7-1/2" Pull-Up Div Spout	ADA Lever	Chrome	

Ara® TempAssure® 17T Series Tub & Shower Trim

- Fits MultiChoice® universal valve
- Handle adjusts volume, dial adjusts temperature
- Sweat onto 1/2" CWT or thread onto 1/2" IPS
- H2Okinetic® 6" raincan showerhead
- Self-cleaning H2Okinetic® spray holes
- WaterSense® certified product: 2.0 gpm



Part #	Mfg #	Description	Handle(s)	Finish	Price
177474	T17T467	Tub & Shower Trim, 7-1/8" Pull-Up Div Spout	ADA Lever	Chrome	
177475	T17T467-SS	Tub & Shower Trim, 7-7/8" Pull-Up Div Spout	ADA Lever	Stainless*	

* Brilliance® Anti-Tarnish Lifetime Finishes

www.plumbsupply.com • Serving our Customers Since 1946 • www.waterconcepts.net

Tub & Shower Faucets

Faucets & Valves

Cassidy™ TempAssure® 17T Series Tub & Shower Trim

- Fits MultiChoice® universal valve
- Handle adjusts volume, dial adjusts temperature
- Sweat into 1/2" C.W.T. or thread into 1/2" IPS
- Touch-Clean® 9-3/8" raincan showerhead
- Flow rate: 2.5 gpm @ 80 psi



Part #	Mfg #	Description	Handle(s)	Finish	Price
212109	T17T497	Tub & Shower Trim, 7-2/3" Pull-Up Diverter Spout	ADA Lever	Chrome	
173984	T17T497-RB	Tub & Shower Trim, 7-2/3" Pull-Up Diverter Spout	ADA Lever	Venetian Bronze®	
155377	T17T497-SS	Tub & Shower Trim, 7-2/3" Pull-Up Diverter Spout	ADA Lever	Stainless*	

Compel® TempAssure® Series 17T Tub & Shower Trim

- Fits MultiChoice™ universal valve
- Handle adjusts volume, dial adjusts temperature
- Sweat onto 1/2" CWT or thread onto 1/2" IPS
- H2Okinetic 7-3/4" raincan showerhead
- Self-cleaning H2Okinetic® spray holes
- Touch-Clean® spray holes
- WaterSense® certified product: 2.0 gpm @ 80 psi



Part #	Mfg #	Description	Handle(s)	Finish	Price
182289	T17T461-SSH2O	Tub & Shower Trim, 7" Pull-Up Diverter Spout	ADA Lever	Stainless*	

Dryden™ TempAssure® 17T Series Tub & Shower Trim

- Fits MultiChoice® universal valve
- Handle adjusts volume, dial adjusts temperature
- Sweat onto 1/2" CWT or thread onto 1/2" IPS
- Touch-Clean® 6-9/16" raincan showerhead
- Flow rate: 2.5 gpm @ 80 psi



Part #	Mfg #	Description	Handle(s)	Finish	Price
117207	T17T451-SS	Tub & Shower Trim, 6-1/4" Pull-Up Diverter Spout	ADA Lever	Stainless*	

* Brilliance® Anti-Tarnish Lifetime Finishes

www.waterconcepts.net • Serving our Customers Since 1946 • www.plumbsupply.com

Tub & Shower Faucets

Lahara® TempAssure® 17T Series Tub & Shower Trim

- Fits MultiChoice® universal valve
- Handle adjusts volume, dial adjusts temperature
- Sweat onto 1/2" C.W.T or thread onto 1/2" IPS
- Touch-Clean® 5" raincan showerhead
- Flow rate: 2.5 gpm @ 80 psi



Part #	Mfg #	Description	Handle(s)	Finish	Price
111015	T17T438	Tub & Shower Trim, 7" Pull-Up Diverter Spout	ADA Lever	Chrome	
111019	T17T438-SS	Tub & Shower Trim, 7" Pull-Up Diverter Spout	ADA Lever	Stainless*	
111018	T17T438-RB	Tub & Shower Trim, 7" Pull-Up Diverter Spout	ADA Lever	Venetian Bronze®	

Tesla™ TempAssure® 17T Series Tub & Shower Trim

- Fits MultiChoice® universal valve
- Handle adjusts volume, dial adjusts temperature
- Pull-up diverter spout
- 3-Setting H2Okinetic® showerhead
- WaterSense® certified product: 2.0 gpm @ 80 psi



Part #	Mfg #	Description	Handle(s)	Finish	Price
224765	T17T452-SS	Tub & Shower Trim, 5-1/2" Pull-Up Diverter Spout	ADA Lever	Stainless*	

Trinsic® TempAssure® 17T Series Tub & Shower Trim

- Fits MultiChoice® universal valve
- Handle adjusts volume, dial adjusts temperature
- Slip-on spout for 1/2" C.W.T.
- H2Okinetic® 7-3/4" raincan showerhead
- Touch-Clean® spray holes
- Self-cleaning H2Okinetic® spray holes
- WaterSense® certified product: 2.0 gpm @ 80 PSI



Part #	Mfg #	Description	Handle(s)	Finish	Price
180253	T17T459-H2O	Tub & Shower Trim, 6-3/16" Pull-Up Div Spout	ADA Lever	Chrome	
180946	T17T459-SSH2O	Tub & Shower Trim, 6-3/16" Pull-Up Div Spout	ADA Lever	Stainless*	
186754	T17T459-RBH2O	Tub & Shower Trim, 6-3/16" Pull-Up Div Spout	ADA Lever	Venetian Bronze®	

* Brilliance® Anti-Tarnish Lifetime Finishes

www.plumbsupply.com • Serving our Customers Since 1946 • www.waterconcepts.net

Tub & Shower Faucets

Vero™ TempAssure® 17T Series Tub & Shower Trim

- Fits MultiChoice™ universal valve
- Handle adjusts temperature, dial adjusts volume
- Sweat onto 1/2" CWT or thread onto 1/2" IPS
- Touch-Clean® 8-5/8" raincan showerhead
- Maximum flow rate: 2.5 gpm @ 80 psi



Faucets & Valves

Part #	Mfg #	Description	Handle(s)	Finish	Price
172634	T17T453	Tub & Shower Trim, 7-1/8" Diverter Spout	ADA Lever	Chrome	

* Brilliance® Anti-Tarnish Lifetime Finishes

www.waterconcepts.net • Serving our Customers Since 1946 • www.plumbsupply.com

Tub & Shower Faucets

Chateau 2-Hdl Tub & Shower Trim

- Metal construction
- 1/2" connections: IPS-exterior, CC-Interior
- Dual control
- 1224 Cartridge design
- Max flow: 2.5 gpm or EP 1.75 gpm



Part #	Mfg #	Description	Handle(s)	Finish	Price
007245	2919	Tub & Shower Trim, 5-1/2" Diverter Spout	Acrylic Knob	Chrome	
142258	2995	Tub & Shower Trim, Knob Handle Diverter	Acrylic Knob	Chrome	
231341	2919EP	Tub & Shower Trim, 5-1/2" Diverter Spout, 1.75 gpm	Acrylic Knob	Chrome	

Single-Handle Tub & Shower Trim

90°™ Posi-Temp® 1-Hdl Tub & Shower Trim

- Fits M•PACT® system
- 1/2" CC connections
- Adjustable temperature limit stop
- 7-1/4" Diverter tub spout
- Max flow: 2.5 gpm or EP 1.75 gpm



Requires Valve: 2520

Part #	Mfg #	Description	Handle(s)	Finish	Price
139946	TS2713	Tub & Shower Trim	ADA Lever	Chrome	
141002	TS2713BN	Tub & Shower Trim	ADA Lever	Brushed Nickel	

Align™ Posi-Temp® 1-Hdl Tub & Shower Trim

- Fits M•PACT® system
- Adjustable Temperature limit stop
- 7-3/8" Tub spout length
- Max flow: 2.5 gpm or EP 1.75 gpm



Requires Valve: 2520

Part #	Mfg #	Description	Handle(s)	Finish	Price
174196	T2193	Tub & Shower Trim	ADA Lever	Chrome	
186109	T2193BN	Tub & Shower Trim	ADA Lever	Brushed Nickel	
180636	T2193NH	Tub & Shower Trim, Less Showerhead	ADA Lever	Chrome	
170257	T2193EP	Tub & Shower Trim	ADA Lever	Chrome	
179496	T3293	Tub & Shower Trim	ADA Lever	Chrome	

*Lifeshine® Anti-Tarnish Lifetime Finish

www.plumbsupply.com • Serving our Customers Since 1946 • www.waterconcepts.net

Tub & Shower Faucets

Faucets & Valves

Arris™ Posi-Temp® 1-Hdl Tub & Shower Trim

- Fits M•PACT® system
- 10" Immersion™ rainhead
- 6-3/4" Tub spout
- EP Suffix - indicates eco-performance
- Max flow: 2.5 gpm or EP 1.75 gpm



Requires Valve: 2520

Part #	Mfg #	Description	Handle(s)	Finish	Price
175357	TS22003EP	Tub & Shower Trim	ADA Lever	Chrome	
190292	TS2203BN	Tub & Shower Trim	ADA Lever	Brushed Nickel	

Brantford™ Posi-Temp® 1-Hdl Tub & Shower Trim

- Fits M•PACT® system
- Easy Clean® XLT single-function showerhead, arm and flange
- 6-1/2" Slip fit diverter spout
- EP Suffix - indicates eco-performance
- Max flow: 2.5 gpm or EP 1.75 gpm



2153

Requires Valve: 2520

Part #	Mfg #	Description	Handle(s)	Finish	Price
108178	T2153	Tub & Shower Trim	ADA Lever	Chrome	
102298	T2153BN	Tub & Shower Trim	ADA Lever	Brushed Nickel	
102293	T2153ORB	Tub & Shower Trim	ADA Lever	Oil Rubbed Bronze	
188382	T2153EPBN	Tub & Shower Trim, 1.75gpm	ADA Lever	Brushed Nickel	
183266	T2153EPORB	Tub & Shower Trim, 1.75gpm	ADA Lever	Oil Rubbed Bronze	
202527	T2153NHBN	Tub & Shower Trim, Less Showerhead	ADA Lever	Brushed Nickel	
227874	T2253EPBN	Tub & Shower Trim, 8" 1.75gpm Showerhead	ADA Lever	Brushed Nickel	
226285	T2253EPORB	Tub & Shower Trim, 8" 1.75gpm Showerhead	ADA Lever	Oil Rubbed Bronze	

Chateau® Posi-Temp® 1-Hdl Tub & Shower Trim

- Fits M•PACT® system
- Adjustable temperature limit stop
- Easy-Clean® XL single-function showerhead, arm and flange
- 5-1/2" Slip fit diverter tub spout
- Flow rate: 2.5 gpm



TL471

Requires Valve: 2520

Part #	Mfg #	Description	Handle(s)	Finish	Price
037059	TL183	Tub & Shower Trim (Bulk 12/Pk)	ADA Lever	Chrome	
089635	TL183BC	Tub & Shower Trim (Bulk 12/Pk)	ADA Lever	Brushed Chrome	
193674	TL471	Tub & Shower Trim (Bulk 12/Pk)	ADA Lever	Chrome	

*Lifeshine® Anti-Tarnish Lifetime Finish

www.waterconcepts.net • Serving our Customers Since 1946 • www.plumbsupply.com

Tub & Shower Faucets

Chateau® Posi-Temp® 1-Hdl Tub & Shower Trim

- 4-Port pressure balancing cycling valve design without volume control
- Adjustable temperature limit stop
- Easy Clean® XL single-function showerhead, arm and flange
- Valve sold separately
- Flow rate: 2.5 gpm



L2353

Part #	Mfg #	Description	Handle(s)	Finish	Price
020308	L2353	Tub & Shower Trim, 5-1/2" Tub Spout	Clear Knob	Chrome	
191629	T183	Tub & Shower Trim, H&C Indicators, 5-1/2" Tub Spout	Clear Knob	Chrome	
191632	T471	Tub & Shower Trim, 5-1/2" Tub Spout	Clear Knob	Chrome	

Dartmoor™ Posi-Temp® 1-Hdl Tub & Shower Trim

- Fits M•PACT® system
- Adjustable temperature limit stop
- 1222 cartridge design
- Includes showerhead, arm, flange, and tub spout
- 7-3/8" diverter tub spout
- Flow rate: 2.5 gpm or EP 1.75 gpm



Requires Valve: 2520

Part #	Mfg #	Description	Handle(s)	Finish	Price
228792	T2183	Tub & Shower Trim	ADA Lever	Chrome	
222894	T2183ORB	Tub & Shower Trim	ADA Lever	Oil Rubbed Bronze	

Eva™ Posi-Temp® 1-Hdl Tub & Shower Trim

- Fits M•PACT® system
- Easy Clean® XLT single-function showerhead, arm and flange
- 7" Slip fit diverter tub spout
- Flow rate: 2.5 gpm (EP) 1.75 gpm
- -NH Models: Showerhead sold separately



Requires Valve: 2520

Part #	Mfg #	Description	Handle(s)	Finish	Price
094489	T2133	Tub & Shower Trim, 2.5 gpm	ADA Lever	Chrome	
095677	T2133BN	Tub & Shower Trim, 2.5 gpm	ADA Lever	*Brushed Nickel	
098474	T2133ORB	Tub & Shower Trim	ADA Lever	Oil Rubbed Bronze	
226511	T2233EP	Tub & Shower Trim, 1.75 gpm 8" Showerhead	ADA Lever	Chrome	
176810	T2133EPBN	Tub & Shower Trim, 1.75 gpm	ADA Lever	*Brushed Nickel	
178593	T2133EPORB	Tub & Shower Trim, 1.75 gpm	ADA Lever	Oil Rubbed Bronze	
214366	T62133NH	Tub & Shower Trim, Less Showerhead	ADA Lever	Chrome	
167391	T2133NHBN	Tub & Shower Trim, Less Showerhead	ADA Lever	Brushed Nickel	
202854	T2133NHORB	Tub & Shower Trim, Less Showerhead	ADA Lever	Oil Rubbed Bronze	

*Lifeshine® Anti-Tarnish Lifetime Finish

www.plumbsupply.com • Serving our Customers Since 1946 • www.waterconcepts.net

Tub & Shower Faucets

Faucets & Valves

Kingsley™ Posi-Temp® 1-Hdl Tub & Shower Trim

- Fits M•PACT® system
- Moenflo® XL single-function showerhead, arm and flange
- 6" Slip fit diverter tub spout



Requires Valve: 2520

Part #	Mfg #	Description	Handle(s)	Finish	Price
070915	T2113	Tub & Shower Trim	ADA Lever	Chrome	
078571	T2113BN	Tub & Shower Trim	ADA Lever	*Brushed Nickel	
077213	T2113ORB	Tub & Shower Trim	ADA Lever	Oil Rubbed Bronze	
079639	T2113WR	Tub & Shower Trim	ADA Lever	Wrought Iron	

Method™ Posi-Temp® 1-Hdl Tub & Shower Trim

- Fits M•PACT® system
- 5-7/8" Diverter tub spout
- 1222 Cartridge design
- Flow rate: 2.5 gpm



Requires Valve: 2520

Part #	Mfg #	Description	Handle(s)	Finish	Price
137868	T2803	Tub & Shower Trim	ADA Lever	Chrome	
134862	T2803BN	Tub & Shower Trim	ADA Lever	*Brushed Nickel	

Rothbury™ Posi-Temp® 1-Hdl Tub & Shower Trim

- Fits M•PACT® system
- 6-1/2" Diameter spray head, full spray
- 7-5/8" Slip fit diverter tub spout
- Flow rate: 2.5 gpm

Requires Valve: 2520



Part #	Mfg #	Description	Handle(s)	Finish	Price
180824	TS2213	Tub & Shower Trim, 2.5 gpm	ADA Lever	Chrome	
124661	TS2231BN	Tub & Shower Trim, 2.5 gpm	ADA Lever	Brushed Nickel	
122079	TS2213ORB	Tub & Shower Trim, 2.5 gpm	ADA Lever	Oil Rubbed Bronze	

*Lifeshine® Anti-Tarnish Lifetime Finish

www.waterconcepts.net • Serving our Customers Since 1946 • www.plumbsupply.com

Tub & Shower Faucets

Voss™ Posi-Temp® 1-Hdl Tub & Shower Trim

- Fits M•Pact® system
- 7-3/4" Tub spout length
- Flow rate: 2.5 gpm or 1.75 gpm



Requires Valve: 2520

Part #	Mfg #	Description	Handle(s)	Finish	Price
152101	T2693	Tub & Shower Trim	ADA Lever	Chrome	
151294	T2693BN	Tub & Shower Trim	ADA Lever	Brushed Nickel	
153396	T2693ORB	Tub & Shower Trim	ADA Lever	Oil Rubbed Bronze	
150546	T2693EP	Tub & Shower Trim, 1.75 gpm	ADA Lever	Chrome	
212353	T2693NH	Tub & Shower Trim, Less Showerhead	ADA Lever	Chrome	
152715	T2693NHBN	Tub & Shower Trim, Less Showerhead	ADA Lever	Brushed Nickel	
210192	T2693NHORB	Tub & Shower Trim, Less Showerhead	ADA Lever	Oil Rubbed Bronze	

Waterhill® Posi-Temp® 1-Hdl Tub & Shower Trim

- Fits M•PACT® system
- 10" Diameter rain shower head
- 6-3/4" Slip fit diverter tub spout
- Flow rate: 2.5 gpm or EP 1.75 gpm



Requires Valve: 2520

Part #	Mfg #	Description	Handle(s)	Finish	Price
200052	TS314	Tub & Shower Trim	ADA Lever	Chrome	
208181	TS314BN	Tub & Shower Trim	ADA Lever	Brushed Nickel	
187910	TS314ORB	Tub & Shower Trim	ADA Lever	Oil Rubbed Bronze	

Weymouth™ Posi-Temp® 1-Hdl Tub & Shower Trim

- Fits M•PACT® system
- 9" Diameter rain shower head
- 6-3/4" Slip fit diverter tub spout
- Flow rate: 2.5 gpm



Requires Valve: 2520

Part #	Mfg #	Description	Handle(s)	Finish	Price
172109	TS32104	Tub & Shower Trim	ADA Lever	Chrome	
181749	TS32104BN	Tub & Shower Trim	ADA Lever	Brushed Nickel	

*Lifeshine® Anti-Tarnish Lifetime Finish

www.plumbsupply.com • Serving our Customers Since 1946 • www.waterconcepts.net

Tub & Shower Faucets

Faucets & Valves

Wynford™ Posi-Temp® 1-Hdl Tub & Shower Trim

- Fits M•PACT® system
- 5-7/8" Diameter
- 6-1/2" Slip fit diverter tub spout
- WaterSense® certified: 1.75 gpm



Requires Valve: 2520

Part #	Mfg #	Description	Handle(s)	Finish	Price
187216	T4503	Tub & Shower Trim	ADA Lever	Chrome	
217680	T4503BN	Tub & Shower Trim	ADA Lever	Brushed Nickel	
184815	T4503NL	Tub & Shower Trim	ADA Lever	Polished Nickel	
189589	T4503ORB	Tub & Shower Trim	ADA Lever	Oil Rubbed Bronze	
224186	T4503NHBN	Tub & Shower Trim, Less Showerhead	ADA Lever	Brushed Nickel	
187259	T5503	Tub & Shower Trim, 2.5gpm 7" Showerhead	ADA Lever	Chrome	
187014	T5503NL	Tub & Shower Trim, 2.5gpm 7" Showerhead	ADA Lever	Polished Nickel	

Moentrol Tub & Shower Trim

90° Moentrol® 1-Hdl Tub & Shower Trim

- Fits M•PACT® system
- Equipped with Moentrol® pressure-balancing control valve: control allows you to adjust both water volume and temperature
- Immersion™ 6" spray head
- Full spray
- 7-1/4" Tub spout length
- Flow rate: 2.5 gpm



Requires Valve: 3510

Part #	Mfg #	Description	Handle(s)	Finish	Price
171263	TS3713	Tub & Shower Trim	ADA Lever	Chrome	

Legend® Moentrol® 1-Hdl Tub & Shower Trim

- Fits M•PACT® system
- Moentrol® pressure-balancing control valve
- 2-1/2" Spray head
- 5-1/2" Slip fit diverter spout
- Flow rate: 2.5 gpm



Requires Valve: 3510

Part #	Mfg #	Description	Handle(s)	Finish	Price
193105	TL172	Tub & Shower Trim	ADA Lever	Chrome	

*Lifeshine® Anti-Tarnish Lifetime Finish

www.waterconcepts.net • Serving our Customers Since 1946 • www.plumbsupply.com

Tub & Shower Faucets

Kingsley® Moentrol® 1-Hdl Tub & Shower Trim

- Fits M•PACT® system
- Moentrol® pressure-balancing control valve
- 4-3/8" Showerhead
- 5-1/2" Tub spout length
- Flow rate: 2.5 gpm



Requires Valve: 63100, 3500 series

Part #	Mfg #	Description	Handle(s)	Finish	Price
070933	T3113	Tube & Shower Trim	ADA Lever	Chrome	
087883	T3113BN	Tube & Shower Trim	ADA Lever	Brushed Nickel	
094826	T3113ORB	Tube & Shower Trim	ADA Lever	Oil Rubbed Bronze	

Voss™ Moentrol® 1-Hdl Tub & Shower Trim

- Fits M•PACT® system
- Moentrol® pressure-balancing control valve
- 6" Immersion™ rain shower, full spray
- 7-15/16" Tub spout length
- Flow rate: 2.5 gpm



Requires Valve: 63100, 3500 series

Part #	Mfg #	Description	Handle(s)	Finish	Price
153258	T3693BN	Tub & Shower Trim	ADA Lever	Brushed Nickel	

*Lifeshine® Anti-Tarnish Lifetime Finish

www.plumbsupply.com • Serving our Customers Since 1946 • www.waterconcepts.net



Tub & Shower Faucets

Tub & Shower Trim

Hardwater® 2-Hdl Tub & Shower Trim

- Body cast of high copper content brass
- Ceramaflow ceramic disc cartridge
- Regular showerhead with black spray plate
- Maximum showerhead 2.5 gpm @ 80 psi
- Pressure-compensating flow control
- Slip-fit diverter spout
- Ejector tee



58-400

Part #	Mfg #	Description	Handle(s)	Finish	Price
106635	58-400	8"cc T&S Trim, IPS/Sweat, Thread Escutcheon	ADA Hardwater®	Chrome	
029695	58-420	8"cc T&S Trim, IPS/Sweat, Slide Escutcheon	ADA Hardwater®	Chrome	

Gerber Classics 3-Hdl Tub & Shower Trim

- Cast brass body
- Regular showerhead with black spray plate
- Maximum showerhead: 2.5 gpm @ 80 psi
- Pressure-compensating flow control
- Compression stems
- Zinc die cast tub spout
- Three valve with center diverter
- 1/2" IPS/Sweat connections



Part #	Mfg #	Description	Handle(s)	Finish	Price
004714	48-030	8"cc T&S Trim, Thread Escutcheon	ADA Wing	Chrome	

*Physical Vapor Deposition (PVD) Limited Lifetime Finish

www.waterconcepts.net • Serving our Customers Since 1946 • www.plumbsupply.com

Tub & Shower Faucets

Single-Handle Tub & Shower Trim

P4B Builders Series 1-Hdl Tub & Shower Faucet

- Washerless pressure balance valve
- Slip fit diverter spout
- CC and IP
- Less stops
- Maximum flow rate: 2.0 gpm @ 80 psi
- -JP Models: Trim Only



Part #	Mfg #	Description	Handle(s)	Finish	Price
234718	P4B-730C	Tub & Shower, Slip-Fit Diverter Spout	ADA Lever Blade	Chrome	
141380	P4B-730BN	Tub & Shower, Slip-Fit Diverter Spout	ADA Lever Blade	Brushed Nickel	
141381	P4B-730ORB	Tub & Shower, Slip-Fit Diverter Spout	ADA Lever Blade	Oil Rubbed Bronze	
151680	P4B-730CJP	Tub & Shower, Slip-Fit Diverter Spout	ADA Lever Blade	Chrome	
235536	P4B-730CDJP	Tub & Shower, Slip-Fit DivSpt w/Decorative Shwrhd	ADA Lever Blade	Chrome	
235532	P4B-730BNDJP	Tub & Shower, Slip-Fit DivSpt w/Decorative Shwrhd	ADA Lever Blade	Brushed Nickel	

P4C Classic Series 1-Hdl Tub & Shower Trim

- Washerless pressure balance valve
- Slip fit diverter spout
- CC and IP
- Less stops
- Maximum flow rate: 2.5 gpm @ 80 psi



Part #	Mfg #	Description	Handle(s)	Finish	Price
141394	P4C-730C	Tub & Shower, Slip-Fit Diverter	ADA Lever Blade	Chrome	
151472	P4C-732C	Tub & Shower, Slip-Fit Diverter	Crystal Ball Handle	Chrome	

Two-Handle Tub & Shower Trim

P4V Value Series 2-Hdl Tub & Shower Trim

- Non-pressure balanced
- Slip fit diverter spout
- IP Rough
- Maximum flow rate: 2.5 gpm @ 80 psi



Part #	Mfg #	Description	Handle(s)	Finish	Price
141397	P4V-830C	Tub & Shower, Slip-Fit Diverter	Round Metal	Chrome	
158739	P4V-832C	Tub & Shower, Slip-Fit Diverter	Crystal Ball	Chrome	



Tub & Shower Faucets

Three-Handle Tub & Shower Trim P4V Value Series 3-Hdl Tub & Shower Trim

- Non-pressure balanced
- Washerless cartridges
- Metal round handles
- Non-diverter spout
- Max flow rate: 2.0 gpm @ 80 psi



Faucets & Valves

Part #	Mfg #	Description	Handle(s)	Finish	Price
234715	P4V-870C	Tub & Shower, Slip-Fit Non-Diverter Spout	Round Metal	Chrome	

Tub Faucets

Two-Handle Roman Tub Trim Alteo™ 2-Hdl Deck-Mount Tub Trim

- Bath- or deck-mount installation
- Metal construction
- 7-5/8" Spout



T45115-4 Requires valve K-300-K/KR or K-301-K
T45117-4 Requires valve K-438-K

Non-Diverter Spout

Part #	Mfg #	Description	Handle(s)	Finish	Price
141715	K-T45115-4-BN	High-Arch Non-Diverter Spout	ADA Lever	*Brushed Nickel	
141716	K-T45115-4-CP	High-Arch Non-Diverter Spout	ADA Lever	Polished Chrome	
149754	K-T45115-4-2BZ	High-Arch Non-Diverter Spout	ADA Lever	Oil Rubbed Bronze	

Diverter Spout

Part #	Mfg #	Description	Handle(s)	Finish	Price
141724	K-T45117-4-BN	High-Arch, Diverter Spout	ADA Lever	*Brushed Nickel	
141723	K-T45117-4-CP	High-Arch, Diverter Spout	ADA Lever	Polished Chrome	
166497	K-T451174-2BZ	High-Arch, Diverter Spout	ADA Lever	Oil-Rubbed Bronze	

Antique™ 2-Hdl Bath Faucet

- Bath- or deck-mount
- 9-5/8" Spout with diverter
- Brass construction
- Oval handles
- Handshower



Part #	Mfg #	Description	Handle(s)	Finish	Price
182398	K-110-9B-CP	Floor- or Wall-Mount	Oval	Polished Chrome	

Antique™ Riser Tubes and Cross Connection

- 8" Width
- Brass construction
- Floor-mount installation



Part #	Mfg #	Description	Handle(s)	Finish	Price
183462	K-127-2BZ	Floor Mount 2-1/4" High, 8" Width	-	Oil-Rubbed Bronze	
182406	K-128-SN	Floor-Mount 31-1/2" High, 8" Width	-	*Polished Nickel	

* Vibrant Limited Lifetime Warranty

www.plumbsupply.com • Serving our Customers Since 1946 • www.waterconcepts.net

Tub Faucets

Antique™ Bath Faucet Wall-Mount Adapter Kit



Part #	Mfg #	Description	Handle(s)	Finish	Price
077968	K-101-BN	Wall-Mount	-	*Brushed Nickel	
077123	K-101-CP	Wall-Mount	-	Polished Chrome	
165628	K-101-2BZ	Wall-Mount	-	Oil-Rubbed Bronze	

Archer® 2-Hdl Deck-Mount Tub Trim with Non-Diverter Spout

- Bath- or deck-mount installation
- Metal construction
- High-arch non-diverter spout



Requires Valve: K-300-K/KR or K-301-K

Part #	Mfg #	Description	Handle(s)	Finish	Price
183398	K-T45849-4-BN	High-Arch Non-Diverter Spout	ADA Lever	*Brushed Nickel	
182043	K-T45849-4-CP	High-Arch Non-Diverter Spout	ADA Lever	Polished Chrome	

Bancroft® 2-Hdl Deck-Mount Tub Trim with 7" Spout

- Bath- or deck-mount installation
- Slip-fit spout



T10592-4 Requires Valve K-438-K

T10585-4 Requires Valve K-300-K/KR or K-301-K

Non-Diverter Spout

Part #	Mfg #	Description	Handle(s)	Finish	Price
099266	K-T10585-4-BN	7" Non-Diverter Spout	ADA Lever	* Brushed Nickel	
120009	K-T10585-4-BV	7" Non-Diverter Spout	ADA Lever	* Brushed Bronze	
088081	K-T10585-4-CP	7" Non-Diverter Spout	ADA Lever	Polished Chrome	
134420	K-T10585-4-2BZ	7" Non-Diverter Spout	ADA Lever	Oil-Rubbed Bronze	
179773	K-T10585-4P-BN	7" Non-Diverter Spout	ADA White Ceramic Lever	*Brushed Nickel	
089588	K-T10585-4P-CP	7" Non-Diverter Spout	ADA White Ceramic Lever	Polished Chrome	

Diverter Spout

Part #	Mfg #	Description	Handle(s)	Finish	Price
100090	K-T10592-4-BN	7" Diverter Spout	ADA Lever	* Brushed Nickel	
141443	K-T10592-4-BV	7" Diverter Spout	ADA Lever	* Brushed Bronze	
103939	K-T10592-4-CP	7" Diverter Spout	ADA Lever	Polished Chrome	
116734	K-T10592-4-SN	7" Diverter Spout	ADA Lever	* Polished Nickel	
153388	K-T10592-4-2BZ	7" Diverter Spout	ADA Lever	Oil-Rubbed Bronze	
120383	K-T10592-4P-BN	7" Diverter Spout	ADA White Ceramic Lever	* Brushed Nickel	

* Vibrant Limited Lifetime Warranty

www.waterconcepts.net • Serving our Customers Since 1946 • www.plumbsupply.com

Tub Faucets

Two-Handle Roman Tub Trim (Continued) Bancroft® 2-Hdl Deck-Mount Tub Trim with 7" Spout Diverter Spout

Part #	Mfg #	Description	Handle(s)	Finish	Price
105019	K-T10592-4P-CP	7" Diverter Spout	ADA White Ceramic Lever	Polished Chrome	

Composed® 2-Hdl Deck-Mount Tub Trim

- 8-1/4" Reach, 6-7/16" high spout
- Deck-mount installation
- 3" Maximum deck thickness
- Maximum flow rate: 12 gpm



Part #	Mfg #	Description	Handle(s)	Finish	Price
229557	K-73081-4-CP	8-1/4" Non-Diverter Spout	ADA Lever	Chrome	

Coralais® 2-Hdl Deck-Mount Tub Trim with 8" Non-Diverter Slip-Fit Spout

- Bath- or deck-mount installation
- 1/2" Ceramic valves



-4, Lever Handles



-7, Acrylic Handles

Requires valve K-300-KJ-KR or K-301-K

Part #	Mfg #	Description	Handle(s)	Finish	Price
062910	K-T15290-4-CP	8" Spout	ADA Lever	Polished Chrome	
067371	K-T15290-4-G	8" Spout	ADA Lever	* Brushed Chrome	
063052	K-T15290-7-CP	8" Spout	Sculptured Acrylic Knobs	Polished chrome	

Coralais® 2-Hdl Rim-Mount Tub Trim with 5-1/2" Non-Diverter Slip-Fit Spout

- Bath- or deck-mount.
- 1/2" Ceramic valves



Requires valve K-300-KJ-KR or K-301-K

Part #	Mfg #	Description	Handle(s)	Finish	Price
064057	K-T15294-4-CP	5-1/2" Spout	ADA Lever	Polished Chrome	
069512	K-T15294-4-G	5-1/2" Spout	ADA Lever	Brushed Chrome	

Devonshire® 2-Hdl Deck-/Rim-Mount Tub Trim for High-Flow Valve with Spout

- Brass construction
- Flexible connections



K-T387-4



K-T398-4

K-T387 Requires valve K-438-K
K-T398 Requires valve K-300-KJ-KR or K-301-K

8-15/16" Diverter Spout

Part #	Mfg #	Description	Handle(s)	Finish	Price
100791	K-T387-4-BN	Diverter Spout	ADA Lever	* Brushed Nickel	
107375	K-T387-4-BV	Diverter Spout	ADA Lever	* Brushed Bronze	
116516	K-T387-4-CP	Diverter Spout	ADA Lever	Polished Chrome	
146975	K-T387-4-2BZ	Diverter Spout	ADA Lever	Oil-Rubbed Bronze	

* Vibrant Limited Lifetime Warranty

www.plumbsupply.com • Serving our Customers Since 1946 • www.waterconcepts.net

Tub Faucets

9" Non-Diverter Spout

Part #	Mfg #	Description	Handle(s)	Finish	Price
068219	K-T398-4-BN	Non-Diverter Spout	ADA Lever	*Brushed Nickel	
087676	K-T398-4-BV	Non-Diverter Spout	ADA Lever	*Brushed Bronze	
068218	K-T398-4-CP	Non-Diverter Spout	ADA Lever	Polished Chrome	
172076	K-T398-4-SN	Non-Diverter Spout	ADA Lever	*Polished Nickel	
146985	K-T398-4-2BZ	Non-Diverter Spout	ADA Lever	Oil-Rubbed Bronze	

Fairfax® 2-Hdl Deck-Mount Tub Trim

- Bath- or deck-mount installation
- 8-7/8" High-arch non-diverter spout with slip-fit connection



Requires valve K-300-K/KR or K-301-K

Part #	Mfg #	Description	Handle(s)	Finish	Price
057321	K-T12885-4-BN	8-7/8" Spout Reach	ADA Lever	* Brushed Nickel	
056050	K-T12885-4-CP	8-7/8" Spout Reach	ADA Lever	Polished Chrome	
129496	K-T12885-4-2BZ	8-7/8" Spout Reach	ADA Lever	Oil-Rubbed Bronze	

Finial® Traditional 2-Hdl Dual Control Wall-Mounted Lavatory Sink Faucet Trim

- Brass construction
- Less drain
- Stationary spout
- 9-3/4" Spout reach
- Quarter-turn washerless ceramic disc valves
- 1.2 gpf flow rate



Requires two-handle ceramic valve K-410-K

Part #	Mfg #	Description	Handle(s)	Finish	Price
142138	K-T343-4M-BN	9-3/4" Spout Reach	ADA Lever	*Brushed Nickel	
152065	K-T343-4M-BV	9-3/4" Spout Reach	ADA Lever	*Brushed Bronze	
142139	K-T343-4M-CP	9-3/4" Spout Reach	ADA Lever	Polished Chrome	

Forté® 2-Hdl Sculpted Deck-Mount Tub Trim for High-Flow Valve with 7" Spout

- Brass construction
- Fluid design lines



K-T10278-4



K-T10278-4A

T10278-4/4A Requires valve K-300-K/KR or K-301-K

T10292-4/4A Requires valve K-438-K

Non-Diverter Spout

Part #	Mfg #	Description	Handle(s)	Finish	Price
074193	K-T10278-4-BN	7" Non-Diverter Spout	ADA Sculpted Lever	* Brushed Nickel	
071119	K-T10278-4-CP	7" Non-Diverter Spout	ADA Sculpted Lever	Polished Chrome	
072248	K-T10278-4-G	7" Non-Diverter Spout	ADA Sculpted Lever	Brushed Chrome	
076641	K-T10278-4A-BN	7" Non-Diverter Spout	ADA Traditional Lever	*Brushed Nickel	
074925	K-T10278-4A-CP	7" Non-Diverter Spout	ADA Traditional Lever	Polished Chrome	

* Vibrant Limited Lifetime Warranty

www.waterconcepts.net • Serving our Customers Since 1946 • www.plumbsupply.com

Tub Faucets

Two-Handle Roman Tub Trim (Continued)

Forté® 2-Hdl Sculpted Deck-Mount Tub Trim for High-Flow Valve with 7" Spout Non-Diverter Spout

Part #	Mfg #	Description	Handle(s)	Finish	Price
072795	K-T10278-4A-G	7" Non-Diverter Spout	ADA Traditional Lever	Brushed Chrome	

Diverter Spout

Part #	Mfg #	Description	Handle(s)	Finish	Price
101737	K-T10292-4-BN	7" Diverter Spout	ADA Sculpted Lever	* Brushed Nickel	
103190	K-T10292-4-CP	7" Diverter Spout	ADA Sculpted Lever	Polished Chrome	
107086	K-T10292-4-G	7" Diverter Spout	ADA Sculpted Lever	Brushed Chrome	
108121	K-T10292-4A-BN	7" Diverter Spout	ADA Traditional Lever	* Brushed Nickel	
123190	K-T10292-4A-CP	7" Diverter Spout	ADA Traditional Lever	Polished Chrome	

Finial® Traditional 2-Hdl Deck-Mount Tub Faucet Trim for High-Flow Valve with 7-1/2" Non-Diverter Spout

- Deck-mount installation
- Slip-fit, high-arch spout



Requires Valve K-300-K/KR or K-301-K

Part #	Mfg #	Description	Handle(s)	Finish	Price
075052	K-T314-4M-AF	7-1/2" Non-Diverter Spout	ADA Lever Handles	* French Gold	
059245	K-T314-4M-BN	7-1/2" Non-Diverter Spout	ADA Lever Handle	* Brushed Nickel	
090328	K-T314-4M-BV	7-1/2" Non-Diverter Spout	ADA Lever Handles	* Brushed Bronze	
060194	K-T314-4M-CP	7-1/2" Non-Diverter Spout	ADA Lever Handles	Polished Chrome	
061725	K-T314-4M-SN	7-1/2" Non-Diverter Spout	ADA Lever Handles	* Polished Nickel	
180596	K-T314-4M-2BZ	7-1/2" Non-Diverter Spout	ADA Lever Handles	Oil-Rubbed Bronze	

Kelston™ 2-Hdl Deck-Mount Tub Trim

- Bath- or deck-mount installation
- High-arch non-diverter spout with slip-fit connection
- 6-1/2" Stationary spout
- 9-1/4" Inlet to outlet



T13494-4 Requires valve K-300-K/KR or K-301-K

Part #	Mfg #	Description	Handle(s)	Finish	Price
124523	K-T13494-4-BN	6-1/2" Spout Reach	ADA Lever	* Brushed Nickel	
156464	K-T13494-4-CP	6-1/2" Spout Reach	ADA Lever	Polished Chrome	
147002	K-T13494-4-2BZ	6-1/2" Spout Reach	ADA Lever	Oil-Rubbed Bronze	

* Vibrant Limited Lifetime Warranty

www.plumbsupply.com • Serving our Customers Since 1946 • www.waterconcepts.net

Tub Faucets

Faucets & Valves

Loure® 2-Hdl Deck-Mount Tub Faucet with 6-1/2" Non-Diverter Spout

- Deck-mount installation
- 12.0 Gpm flow rate

Valve Included



Part #	Mfg #	Description	Handle(s)	Finish	Price
159658	K-15285-4-BN	6-1/2" Non-Diverter Spout	Lever Handles	* Brushed Nickel	
183471	K-15285-4-CP	6-1/2" Non-Diverter Spout	Lever Handles	Polished Chrome	

Margaux® 2-Hdl Deck-Mount Tub Faucet for High-Flow Valve with 7" Spout

- Bath- or deck-mount installation
- Ceramic disc valves
- Slip-fit spout



T16236-3/4 Requires valve K-438-K

T16237 Requires valve K-300K/KR or K-301-K

Diverter Spout

Part #	Mfg #	Description	Handle(s)	Finish	Price
140270	K-T16236-3-BN	Diverter Spout	Cross Handles	* Brushed Nickel	
114260	K-T16236-3-BV	Diverter Spout	Cross Handles	* Brushed Bronze	
118149	K-T16236-3-CP	Diverter Spout	Cross Handles	Polished Chrome	
127744	K-T16236-4-BN	Diverter Spout	ADA Lever Handles	* Brushed Nickel	
182981	K-T16236-4-BV	Diverter Spout	ADA Lever Handles	* Brushed Bronze	
112654	K-T16236-4-CP	Diverter Spout	ADA Lever Handles	Polished Chrome	
135065	K-T16236-4-SN	Diverter Spout	ADA Lever Handles	* Polished Nickel	

Non-Diverter Spout

Part #	Mfg #	Description	Handle(s)	Finish	Price
176332	K-T16237-3-BN	Non-Diverter Spout	Cross Handles	*Brushed Nickel	
110492	K-T16237-3-CP	Non-Diverter Spout	Cross Handles	Polished Chrome	
135431	K-T16237-4-AF	Non-Diverter Spout	ADA Lever Handles	* French Gold	
106168	K-T16237-4-BN	Non-Diverter Spout	ADA Lever Handles	* Brushed Nickel	
141182	K-T16237-4-BV	Non-Diverter Spout	ADA Lever Handles	* Brushed Bronze	
107353	K-T16237-4-CP	Non-Diverter Spout	ADA Lever Handles	Polished Chrome	
135974	K-T16237-4-SN	Non-Diverter Spout	ADA Lever Handles	* Polished Nickel	

* Vibrant Limited Lifetime Warranty

www.waterconcepts.net • Serving our Customers Since 1946 • www.plumbsupply.com

Tub Faucets

Memoirs® Stately 2-Hdl Deck-Mount Tub Trim

- Bath- or deck-mount installation
- Diverter spout with 6-5/16" reach
- 3 Handle styles available
- (K-T469-4V-2BZ) non-diverter model



-3S Cross Handles



-4S Lever Handles



-4V Deco Handles

K-T428 Requires high flow valve: **K-438-K**

K-T469 Requires high flow valve **K-301-K-NA**

Part #	Mfg #	Description	Handle(s)	Finish	Price
182982	K-T428-4S-BN	6-5/16" Spout Reach, W/Diverter	ADA Lever	* Brushed Nickel	
097846	K-T428-4S-CP	6-5/16" Spout Reach, W/Diverter	ADA Lever	Polished Chrome	
104446	K-T428-4V-BN	6-5/16" Spout Reach, W/Diverter	ADA Deco Lever	* Brushed Nickel	
114829	K-T428-4V-BV	6-5/16" Spout Reach, W/Diverter	ADA Deco Lever	* Brushed Bronze	
109784	K-T428-4V-CP	6-5/16" Spout Reach, W/Diverter	ADA Deco Lever	* Polished Nickel	
187059	K-T469-4V-2BZ	6-5/16" Spout Reach, Non-diverter	ADA Deco Lever	Oil-Rubbed Bronze	

Oblo® 2-Hdl Bath-or-Deck-Mount Tub Trim with Slip-Fit 7-1/2" Diverter Spout

- 13" High spout
- Fluid design lines



Requires valve **K-300-K/KR** or **K-301-K**

Part #	Mfg #	Description	Handle(s)	Finish	Price
121509	K-T10059-9-BN	7-1/2" Spout Reach	Oval	* Brushed Nickel	
134301	K-T10059-9-CP	7-1/2" Spout Reach	Oval	Polished Chrome	

Pinstripe® 2-Hdl Deck-Mount Tub Faucet with 7-1/16" Non-Diverter Slip-Fit Spout

- Available with lever or cross handles
- Etched detailing on spout and handles on -3B and -4B models



Part #	Mfg #	Description	Handle(s)	Finish	Price
140849	K-T13140-3A-CP	Non-Diverter Spout	Cross Handles	Polished Chrome	
182967	K-T13140-3B-CP	Non-Diverter Spout with Etched Design	Cross Handles	Polished Chrome	
089947	K-T13140-3B-SN	Non-Diverter Spout with Etched Design	Cross Handles	* Polished Nickel	
163779	K-T13140-4A-BN	Non-Diverter Spout	ADA Widespread Lever Handles	* Brushed Nickel	
127031	K-T13140-4A-CP	Non-Diverter Spout	ADA Widespread Lever Handles	Polished Chrome	
112663	K-T13140-4A-SN	Non-Diverter Spout	ADA Lever Handles	* Polished Nickel	
095171	K-T13140-4B-CP	Non-Diverter Spout with Etched Design	ADA Lever Handles	Polished Chrome	

* Vibrant Limited Lifetime Warranty

www.plumbsupply.com • Serving our Customers Since 1946 • www.waterconcepts.net

Tub Faucets

Purist® 2-Hdl Deck-Mount Tub Faucet with 7-1/2" Non-Diverter Slip-Fit Spout

• Bath- or deck-mount installation

Requires valve K-300-K/KR or K-301-K



-4 Lever Handles

-3 Cross Handles

Part #	Mfg #	Description	Handle(s)	Finish	Price
182810	K-14430-CP	Spout Only, 7-1/2" reach	Less Handles	Polished Chrome	
093123	K-T14428-3-BN	7- 1/2" Spout Reach	Cross Handles	* Brushed Nickel	
105653	K-T14428-3-BV	7-1/2" Spout Reach	Cross Handles	* Brushed Bronze	
067402	K-T14428-3-CP	7-1/2" Spout Reach	Cross Handles	Polished Chrome	
090737	K-T14428-3-SN	7-1/2" Spout Reach	Cross Handles	* Polished Nickel	
226952	K-T14428-4-BGD	7-1/2" Spout Reach	ADA Lever Handles	* Brushed Gold	
083829	K-T14428-4-BN	7-1/2" Spout Reach	ADA Lever Handles	* Brushed Nickel	
093381	K-T14428-4-BV	7-1/2" Spout Reach	ADA Lever Handles	* Brushed Bronze	
081204	K-T14428-4-CP	7-1/2" Spout Reach	ADA Lever Handles	Polished Chrome	
170480	K-T14428-4-SN	7-1/2" Spout Reach	ADA Lever Handles	* Polished Nickel	

Refinia® 2-Hdl Deck-Mount Tub Faucet Trim for High-Flow Valve with High-Arc Stationary Spout

- Bath- or deck-mount installation
- Metal construction



T5323-4 Requires valve K-300-K/KR or K-301-K

T5324-4 Requires valve K-438-K

Non-Diverter Spout

Part #	Mfg #	Description	Handle(s)	Finish	Price
141705	K-T5323-4-BN	7-7/16" Non-Diverter Spout	ADA Lever	*Brushed Nickel	
141706	K-T5323-4-CP	7-7/16" Non-Diverter Spout	ADA Lever	Polished Chrome	

Diverter Spout

Part #	Mfg #	Description	Handle(s)	Finish	Price
141707	K-T5324-4-BN	7-7/16" Diverter Spout	ADA Lever	*Brushed Nickel	
141708	K-T5324-4-CP	7-7/16" Diverter Spout	ADA Lever	Polished Chrome	

* Vibrant Limited Lifetime Warranty

www.waterconcepts.net • Serving our Customers Since 1946 • www.plumbsupply.com

Tub Faucets

Revival® 2-Hdl Deck-Mount Tub Faucet for High-Flow Valve

- Deck-mount installation
— (K-T16119) 9-5/8" spout reach
- Bath-mount installation
— (K-T16122) 6-5/8" spout reach
- 6-1/4" spout height



-4, Scroll Lever Handles



-4A, Traditional Lever Handles

Requires valve K-300-K/KR or K-301-K

Part #	Mfg #	Description	Handle(s)	Finish	Price
072506	K-T16119-4-BN	9-5/8" Spout Reach	Scroll Lever Handles	* Brushed Nickel	
058397	K-T16119-4-CP	9-5/8" Spout Reach	Scroll Lever Handles	Polished Chrome	
057231	K-T16119-4-PB	9-5/8" Spout Reach	Scroll Lever Handles	* Polished Brass	
065916	K-T16119-4A-BN	9-5/8" Spout Reach	Traditional Lever Handles	* Brushed Nickel	
078302	K-T16119-4A-BV	9-5/8" Spout Reach	Traditional Lever Handles	* Brushed Bronze	
053994	K-T16119-4A-CP	9-5/8" Spout Reach	Traditional Lever Handles	Polished Chrome	
066677	K-T16119-4A-PB	9-5/8" Spout Reach	Traditional Lever Handles	* Polished Brass	
075235	K-T16122-4-BN	6-5/8" Spout Reach	Scroll Lever Handles	* Brushed Nickel	
059465	K-T16122-4-CP	6-5/8" Spout Reach	Scroll Lever Handles	* Polished Chrome	
055643	K-T16122-4-PB	6-5/8" Spout Reach	Scroll Lever Handles	* Polished Brass	
078403	K-T16122-4A-BN	6-5/8" Spout Reach	Traditional Lever Handles	* Brushed Nickel	
189431	K-T16122-4A-PB	6-5/8" Spout Reach	Traditional Lever Handles	* Polished Brass	

Stillness® 2-Hdl Deck-Mount Tub Faucet with 6-7/8" Non-Diverter Slip-Fit High-Arc Spout

- Bath- or deck-mount installation

Requires high-flow valve K-300-K/KR or K-301-K



Part #	Mfg #	Description	Handle(s)	Finish	Price
074806	K-T954-4-BN	6-7/8" Non-Diverter Spout	ADA Lever Handles	* Brushed Nickel	
060612	K-T954-4-CP	6-7/8" Non-Diverter Spout	ADA Lever Handles	Polished Chrome	

One-Handle Tub Faucets

Loure® 1-Hdl Deck-Mount Tub Faucet with 6-1/2" Non-Diverter Spout

- Single control ceramic remote valve

Valve Included



Part #	Mfg #	Description	Handle(s)	Finish	Price
163690	K-14675-4-BN	6-1/2" Non-Diverter Spout	Single Lever Handle	* Brushed Nickel	
139934	K-14675-4-CP	6-1/2" Non-Diverter Spout	Single Lever Handle	Polished Chrome	

* Vibrant Limited Lifetime Warranty

www.plumbsupply.com • Serving our Customers Since 1946 • www.waterconcepts.net

Tub Faucets

Faucets & Valves

Toobi™ 1-Hdl Deck-Mount Tub Faucet with Handshower

- Spout with pull diverter, 8-13/16" reach
- Single-control cylinder handle
- Escutcheon plates
- Includes white, green and black spout insert color options
- Handshower includes adjustable sprayface with 60" length hose



For Floor Mount Installation, use riser tubes K-18492

Part #	Mfg #	Description	Handle(s)	Finish	Price
143158	K-8973-7-BN	8-13/16" Spout	Single Handle Knob	* Brushed Nickel	
167291	K-8973-7-CP	8-13/16" Spout	Single Handle Knob	Polished Chrome	

Stance® 1-Hdl Deck-Mount High-Flow Tub Faucet with Single-Control Remote Valve and 9" Spout



Diverter Spout

Part #	Mfg #	Description	Handle(s)	Finish	Price
134411	K-14774-4-BN	8-1/4" Diverter Spout	Single Lever Handle	* Brushed Nickel	
145688	K-14774-4-CP	8-1/4" Diverter Spout	Single Lever Handle	Polished Chrome	

Non-Diverter Spout

Part #	Mfg #	Description	Handle(s)	Finish	Price
139155	K-14775-4-BN	8-1/4" Non-Diverter Spout	Single Lever Handle	* Brushed Nickel	
139347	K-14775-4-CP	8-1/4" Non-Diverter Spout	Single Lever Handle	Polished Chrome	

Symbol® 1-Hdl Tub Faucet with 8" Diverter Spout Handshower

- Bath- or deck-mount installation
- Push-button diverter
- Handshower included with 60" hose
- Optional riser-mount installation when used with K-18492 riser tubs



Part #	Mfg #	Description	Handle(s)	Finish	Price
101863	K-18486-4-BN	8" Spout Reach	Single Lever Handle	* Brushed Nickel	
104159	K-18486-4-CP	8" Spout Reach	Single Lever Handle	Polished Chrome	

* Vibrant Limited Lifetime Warranty

www.waterconcepts.net • Serving our Customers Since 1946 • www.plumbsupply.com

Tub Faucets

Floor Mount Tub Faucets

Finial® Traditional Floor-or Wall-Mount Faucet with Lever Handles, 9-5/8" Diverter Spout, & Handshower

- Solid brass construction
- Brass valve bodies
- Polished finish accents
- One-piece ceramic valve
- Traditional handshower with 69" hose



Part #	Mfg #	Description	Handle(s)	Finish	Price
079382	K-331-4M-BN	9-5/8" Spout Reach	Lever	*Brushed Nickel	
076966	K-331-4M-BV	9-5/8" Spout Reach	Lever	*Brushed Bronze	
133269	K-331-4M-CP	9-5/8" Spout Reach	Lever	Polished Chrome	
161881	K-331-4M-2BZ	9-5/8" Spout Reach	Lever	Oil-Rubbed Bronze	

Kelston® 1-Hdl Floor-Mount Tub Faucet with 8-3/4" Spout Reach

- Includes K-72776 handshower and hose
- Flow rate: 6 gpm

Requires K-97339 Mounting-Block



Part #	Mfg #	Description	Handle(s)	Finish	Price
226439	K-T97332-4-BN	8-3/4" Spout Reach	Lever	Brushed Nickel	
183293	K-T97332-4-CP	8-3/4" Spout Reach	Lever	Polished Chrome	
183667	K-T97332-4-2BZ	8-3/4" Spout Reach	Lever	Oil-Rubbed Bronze	

Loure® 1-Hdl Floor Mount Bath Filler with 6-9/16" Spout Reach

- Includes K-45203 handshower and hose
- Flow Rate: 6 gpm @ 45 psi
- Requires K-97343-NA mounting-block



Part #	Mfg #	Description	Handle(s)	Finish	Price
184143	K-T97330-4-CP	6-9/16" Spout Reach	Lever	Polished Chrome	

* Vibrant Limited Lifetime Warranty

www.plumbsupply.com • Serving our Customers Since 1946 • www.waterconcepts.net

Tub Faucets

Faucets & Valves

Margaux® 1-Hdl Floor-Mount Tub Faucet with 4-5/16" Spout Reach

- Includes K-45203 handshower and hose
- Flow rate: 6 gpm

Requires K-97339 Mounting-Block



Part #	Mfg #	Description	Handle(s)	Finish	Price
224471	K-T97331-4-BN	4-5/16" Spout Reach	Lever	*Brushed Nickel	
181191	K-T97331-4-CP	4-5/16" Spout Reach	Lever	Polished Chrome	

Purist® 1-Hdl Floor-Mount Tub Filler

- 12-1/16" Spout reach
- Includes K-10257 handshower and hose
- Flow rate: 6 gpm

Requires K-97339 Mounting-Block



Part #	Mfg #	Description	Handle(s)	Finish	Price
174981	K-T97328-4-BN	12-1/16" Spout Reach	Lever	* Brushed Nickel	
179749	K-T97328-4-CP	12-1/16" Spout Reach	Lever	Polished Chrome	

Refinia® 1-Hdl Floor-Mount Tub Filler

- 8-1/2" Spout reach
- Includes K-72420 Awaken B90 2.0 gpm handshower and 60" shower hose
- Flow rate: 7 gpm
- Requires K-97342-NA mounting-block



Part #	Mfg #	Description	Handle(s)	Finish	Price
185566	K-T97334-4-BN	8-1/2" Spout Reach	Lever	*Brushed Nickel	
223678	K-T97334-4-CP	8-1/2" Spout Reach	Lever	Polished Chrome	

* Vibrant Limited Lifetime Warranty

www.waterconcepts.net • Serving our Customers Since 1946 • www.plumbsupply.com

Tub Faucets

Stillness® 1-Hdl Floor-Mount Tub Faucet

- 8-1/2" Spout reach
- Includes K-10257 handshower and hose
- Flow rate: 6 gpm

Requires K-97339 Mounting-Block



Part #	Mfg #	Description	Handle(s)	Finish	Price
176947	K-T97344-4-CP	8-1/2" Spout Reach	Lever	Polished Chrome	

Tub Faucet Components (Spouts and Handles)

Alteo® Valve Trim Handles

- Two-handle bat- or deck- or wall-mount installation
- Metal construction



Requires Valve: K-300-K/KR, K-301-K, or K-302-K

Part #	Mfg #	Description	Handle(s)	Finish	Price
141722	K-T45119-4-BN	Handle Trim Only	ADA Lever	*Brushed Nickel	
141721	K-T45119-4-CP	Handle Trim Only	ADA Lever	Polished Chrome	
154100	K-T45119-4-2BZ	Handle Trim Only	ADA Lever	Oil-Rubbed Bronze	

Artifacts® Deck-Mount Bath Spout with Arc Design

- 9" Reach, 5-1/4" high spout
- Brass construction
- Ceramic disc valves
- Flow rate: 15 gpm
- Handle trim sold separately



Part #	Mfg #	Description	Handle(s)	Finish	Price
174430	K-72778-BN	9" Non-Diverter Spout	Less Handle Trim	*Brushed Nickel	
181402	K-72778-BV	9" Non-Diverter Spout	Less Handle Trim	* Brushed Bronze	
173102	K-72778-SN	9" Non-Diverter Spout	Less Handle Trim	* Polished Nickel	
180274	K-72778-2BZ	9" Non-Diverter Spout	Less Handle Trim	Oil-Rubbed Bronze	

* Vibrant Limited Lifetime Warranty

www.plumbsupply.com • Serving our Customers Since 1946 • www.waterconcepts.net

Tub Faucets

Artifacts® Deck-Mount Bath Spout with Flare Design

- 9" Reach, 4-3/4" high spout
- Brass construction
- Ceramic disc valves
- Flow rate: 15 gpm
- Handle trim sold separately



Part #	Mfg #	Description	Handle(s)	Finish	Price
177220	K-72777-BN	9" Non-Diverter Spout	Less Handle Trim	*Brushed Nickel	
222669	K-72777-BV	9" Non-Diverter Spout	Less Handle Trim	*Brushed Bronze	
167566	K-72777-CP	9" Non-Diverter Spout	Less Handle Trim	Polished Chrome	
181719	K-72777-SN	9" Non-Diverter Spout	Less Handle Trim	* Polished Nickel	
184807	K-72777-VNT	9" Non-Diverter Spout	Less Handle Trim	Vintage Nickel	
168451	K-72777-2BZ	9" Non-Diverter Spout	Less Handle Trim	Oil-Rubbed Bronze	

Artifacts® Deck-Mount Bath Handle Trim

- Premium metal construction
- Deck-mount
- Bath spout sold separately



Lever



Prong



Swing

Part #	Mfg #	Description	Handle(s)	Finish	Price
183421	K-T98071-3M-BN	Less Spout	ADA Prong	*Brushed Nickel	
183423	K-T98071-3M-BV	Less Spout	ADA Prong	*Brushed Bronze	
167567	K-T98071-3M-CP	Less Spout	ADA Prong	Polished Chrome	
183424	K-T98071-3M-SN	Less Spout	ADA Prong	*Polished Nickel	
184808	T-98071-3M-VNT	Less Spout	ADA Prong	Vintage Nickel	
168452	K-T98071-3M-2BZ	Less Spout	ADA Prong	Oil-Rubbed Bronze	
174431	K-T98071-4-BN	Less Spout	ADA Lever	*Brushed Nickel	
181404	K-T98071-4-BV	Less Spout	ADA Lever	*Brushed Bronze	
171944	K-T98071-4-CP	Less Spout	ADA Lever	Polished Chrome	
173100	K-T98071-4-SN	Less Spout	ADA Lever	* Polished Nickel	
173811	K-T98071-4-2BZ	Less Spout	ADA Lever	Oil-Rubbed Bronze	
183089	K-T98071-9M-BN	Less Spout	Swing Lever	*Brushed Nickel	
183426	K-T98071-9M-CP	Less Spout	Swing Lever	Polished Chrome	
183427	K-T98071-9M-SN	Less Spout	Swing Lever	*Polished Nickel	
183429	K-T98071-9M-2BZ	Less Spout	Swing Lever	Oil-Rubbed Bronze	

* Vibrant Limited Lifetime Warranty

www.waterconcepts.net • Serving our Customers Since 1946 • www.plumbsupply.com

Tub Faucets

Bancroft® Deck-Mount Valve Trim with Metal Lever Handles

- Bath- or deck-mount installation
- High-flow valve trim
- Spout sold separately



Requires Valve K-300-K/KR or K-301-K

Part #	Mfg #	Description	Handle(s)	Finish	Price
150537	K-T10587-4P-BN	Handle Trim Only	ADA White Ceramic Lever	*Brushed Nickel	
121808	K-T10587-4P-CP	Handle Trim Only	ADA White Ceramic Lever	Polished Chrome	
151324	K-T10587-4-2BZ	Handle Trim Only	ADA Lever	Oil-Rubbed Bronze	

Fairfax® Deck or Wall-Mount Tub Trim Handles

- Brass construction
- Less spout
- Handles only sold as pair
- Lifetime limited



Part #	Mfg #	Description	Handle(s)	Finish	Price
183393	K-T12887-4-2BZ	-	ADA Lever	Oil-Rubbed Bronze	

Laminar Deck-Mount Bath Filler Spout

- Solid brass construction



Part #	Mfg #	Description	Handle(s)	Finish	Price
111512	K-8360-BN	13" Spout Reach, Non Diverter	-	*Brushed Nickel	
118108	K-8360-CP	13" Spout Reach, Non Diverter	-	Polished Chrome	

Memoirs® Stately Deck-Mount High-Flow Bath Valve Trim and Deco Lever Handles

- Brass construction



Requires Valve: K-300-K or K-301-K

Part #	Mfg #	Description	Handle(s)	Finish	Price
094147	K-T467-4V-BN	Deck-Mount, High-Flow	Deco Lever	*Brushed Nickel	
097100	K-T467-4V-BV	Deck-Mount, High-Flow	Deco Lever	*Brushed Bronze	
181030	K-T467-4V-CP	Deck-Mount, High-Flow	Deco Lever	Polished Chrome	

* Vibrant Limited Lifetime Warranty

www.plumbsupply.com • Serving our Customers Since 1946 • www.waterconcepts.net

Tub Faucets

Pinstripe® Pure Deck-Mount Valve Trim Handles

- Metal construction
- Bath- or deck-mount
- Available with cross or lever handles



Requires Valve: K-300-K/Kr or K-301-K

Part #	Mfg #	Description	Handle(s)	Finish	Price
182968	K-T13141-4A-BN	Handles Only	ADA Lever	*Brushed Nickel	

Purist® Deck-Mount Valve Trim Handles

- Brass construction
- Bath- or deck-mount
- Brass valve bodies



Requires: K-300-K/KR 1/2" high-flow valve
or
K-301-K 3/4" high-flow valve
or
K-302-K 2-Hdl 1/2" valve

Part #	Mfg #	Description	Handle(s)	Finish	Price
222086	K-T14429-3-BGD	Deck-Mount	Cross	*Moderne Brushed Gold	

* Vibrant Limited Lifetime Warranty

www.waterconcepts.net • Serving our Customers Since 1946 • www.plumbsupply.com

Tub Faucets

MultiChoice™ Universal Wall-Mount Tub Trim

Ashlyn™ Monitor® 14 Series 1-Hdl Tub Only Trim

- Fits MultiChoice™ universal valve
- Handle adjusts temperature
- Sweat onto 1/2" C.W.T. or thread onto 1/2" IPS



Part #	Mfg #	Description	Handle(s)	Finish	Price
178458	T14164	Tub Trim Only, 7-15/16" Non-Diverter Spout	ADA Lever	Chrome	
170525	T14164-SS	Tub Trim Only, 7-15/16" Non-Diverter Spout	ADA Lever	Stainless*	

Classic Monitor® 13 Series 1-Hdl Tub Trim

- Fits MultiChoice™ universal valve
- Handle adjusts temperature
- Thread onto 1/2" IPS



Part #	Mfg #	Description	Handle(s)	Finish	Price
092581	T13120	Tub Trim Only, 5-1/4" Non-Diverter Spout	ADA Lever	Chrome	
092582	T13120-LTS	Tub Trim Only, 7" Non-Diverter Spout	ADA Lever	Chrome	

Linden™ Monitor 14 Series Tub Trim

- Fits MultiChoice™ universal valve
- Handle adjusts temperature
- 6-1/2" Non-diverter tub spout



T14193-SS



T14194-SS

Part #	Mfg #	Description	Handle(s)	Finish	Price
226839	T14193-SS	Tub Trim Only, 6-1/2" Non-Diverter Spout	ADA Lever	Stainless*	
144841	T14194-RB	Tub Trim Only, 6-1/2" Non-Diverter Spout	ADA Lever	Venetian Bronze®	
145250	T14194-SS	Tub Trim Only, 6-1/2" Non-Diverter Spout	ADA Lever	Stainless*	

* Brilliance® Anti-Tarnish Lifetime Finishes

www.plumbsupply.com • Serving our Customers Since 1946 • www.waterconcepts.net

Tub Faucets

Faucets & Valves

Free Standing Tub Fillers

Ara® Floor Mount Tub Filler Trim

- 8-3/16" Reach, 40-7/16" high spout
- 39-1/4" From deck to outlet
- 60"-82" stretchable metal hose
- Auto resetting diverter
- Pivot handshower holder
- Dual integral check valve on handshower
- Handshower flow rate: 2.0 gpm @ 80 psi



Part #	Mfg #	Description	Handle(s)	Finish	Price
228154	T4767-SSFL	1-Hole, with Handshower	ADA Lever	Stainless*	

Contemporary Floor Mount Tub Filler Trim

- 8" Reach, 41" high swivel spout
- 37" From deck to outlet
- Swivel spout
- Handle adjusts temperature, pivoting handshower arm
- Touch-Clean® handshower includes double check valves
- 60"-82" stretchable metal hose
- Flow rate: 6.0 gpm @ 60 psi
- Handshower flow rate: 2.0 gpm @ 80 psi



Part #	Mfg #	Description	Handle(s)	Finish	Price
163782	T4759-FL	1-Hole, with Handshower	ADA Lever	Chrome	
175699	T4759-CZFL	1-Hole, with Handshower	ADA Lever	Champagne Bronze™	
167049	T4759-RBFL	1-Hole, with Handshower	ADA Lever	Venetian Bronze®	
162182	T4759-SSFL	1-Hole, with Handshower	ADA Lever	Stainless*	

Tesla® Floor Mount Tub Filler Trim

- 9" Reach, 41-1/2" high spout
- 40-1/8" From deck to outlet
- Handle adjusts temperature
- Pivot handshower arm
- H2Okinetic® 4-setting handshower includes double check valves for backflow prevention
- Self-cleaning H2Okinetic® spray holes
- 60"-82" Stretchable hose
- Flow rate: 10.0 gpm @ 60 psi
- Handshower flow rate: 2.0 gpm @ 80 psi



Part #	Mfg #	Description	Handle(s)	Finish	Price
187265	T4752-FL	1-Hole, with Handshower	ADA Lever	Chrome	

* Brilliance® Anti-Tarnish Lifetime Finishes

www.waterconcepts.net • Serving our Customers Since 1946 • www.plumbsupply.com

Tub Faucets

Free Standing Tub Fillers (Continued)

Tesla® Floor Mount Tub Filler Trim

Part #	Mfg #	Description	Handle(s)	Finish	Price
229500	T4752-PNFL	1-Hole, with Handshower	ADA Lever	Polished Nickel	
189164	T4752-SSFL	1-Hole, with Handshower	ADA Lever	Stainless*	

Cassidy™ Floor Mount Tub Filler Trim

- 8-1/2" Reach, 42-1/2" high swivel spout
- 40" From deck to outlet
- Handle adjusts temperature
- Pivoting handshower arm
- 60"-82" Stretchable hose
- H2Okinetic® 3-Setting handshower includes double check valves
- Self-cleaning H2Okinetic® spray holes
- Flow rate: 10.0 gpm @ 60 psi
- Handshower flow rate: 2.0 gpm @ 80 psi



Faucets & Valves

Order handle separately (LHP)

Part #	Mfg #	Description	Handle(s)	Finish	Price
178716	T4797-FL-LHP	1-Hole, with Handshower	Less Handle	Chrome	
222136	T4797-CZFL-LHP	1-Hole, with Handshower	Less Handle	Champagne Bronze™	
225204	T4797-PNFL-LHP	1-Hole, with Handshower	Less Handle	Polished Nickel	
168551	T4797-RBFL-LHP	1-Hole, with Handshower	Less Handle	Venetian Bronze®	
174148	T4797-SSFL-LHP	1-Hole, with Handshower	Less Handle	Stainless*	

Two-Handle Roman Tub Trim Packs

Addison™ 2-Hdl Roman Tub Trim

- Requires rough-in kit
- 8-7/8" Reach, 8-1/8" high rigid slip-on spout
- 5-3/4" From deck to aerator
- 2-3/4" Diameter scalloped handle bases



T2792

T4792

(T4792 Model)

- Touch-Clean® full body handshower includes double check valves for backflow prevention
- Handshower flow rate: 2.0 gpm @ 60 psi

Part #	Mfg #	Description	Handle(s)	Finish	Price
128423	T2792	3-Hole 8"-16"cc	ADA Lever	Chrome	
125980	T2792-RB	3-Hole 8"-16"cc	ADA Lever	Venetian Bronze®	
128427	T2792-SS	3-Hole 8"-16"cc	ADA Lever	Stainless*	
131446	T4792	4-Hole 8"-16"cc, Handshower	ADA Lever	Chrome	
137746	T4792-CZ	4-Hole 8"-16"cc, Handshower	ADA Lever	Champagne Bronze™	
126445	T4792-RB	4-Hole 8"-16"cc, Handshower	ADA Lever	Venetian Bronze®	
132290	T4792-SS	4-Hole 8"-16"cc, Handshower	ADA Lever	Stainless*	

* Brilliance® Anti-Tarnish Lifetime Finishes

www.plumbsupply.com • Serving our Customers Since 1946 • www.waterconcepts.net

Tub Faucets

Faucets & Valves

Ara™ 2-Hdl Roman Tub Trim

- Requires rough-in kit
- 8-3/16" Reach, 6-11/16" high rigid spout
- 5-11/16" From deck to aerator
- 2-1/2" Square handle bases



T2767



T4767

(T4768) Model

- H2Okinetic® handshower includes double check valves
- Self-cleaning H2Okinetic® spray holes
- Handshower flow rate: 2.0 gpm @ 80 psi

Part #	Mfg #	Description	Handle(s)	Finish	Price
166550	T2767	3-Hole 8"-16"cc	ADA Lever	Chrome	
162245	T2767-SS	3-Hole 8"-16"cc	ADA Lever	Stainless*	
180887	T4767	4-Hole 8"-16"cc, 2.0 gpm Handshower	ADA Lever	Chrome	
182277	T4767-SS	4-Hole 8"-16"cc, 2.0 gpm Handshower	ADA Lever	Stainless*	

Ara™ 2-Hdl Roman Tub Trim with Channel Spout

- Requires rough-in kit
- 9" Reach, 6-11/16" high rigid spout
- 5-3/8" From deck to aerator
- 2-1/2" Square handle bases



Part #	Mfg #	Description	Handle(s)	Finish	Price
173563	T2768	3-Hole 8"-16"cc, Channel Spout	ADA Lever	Chrome	
160231	T2768-SS	3-Hole 8"-16"cc, Channel Spout	ADA Lever	Stainless*	
189892	T4768	4-Hole 8"-16"cc, 2.0 gpm Handshower & Channel Spout ADA Lever	ADA Lever	Chrome	
165749	T4768-SS	4-Hole 8"-16"cc, 2.0 gpm Handshower & Channel Spout ADA Lever	ADA Lever	Stainless*	

Arzo® 2-Hdl Roman Tub Trim

- Requires rough-in kit
- 8-1/4" Reach, 6-1/2" high spout
- 5" From deck to aerator
- Handshower flow rate: 2.5 gpm @ 60 psi



Part #	Mfg #	Description	Handle(s)	Finish	Price
110893	T2786-SS	3-Hole 8"-16"cc	ADA Lever	Stainless*	

* Brilliance® Anti-Tarnish Lifetime Finishes

www.waterconcepts.net • Serving our Customers Since 1946 • www.plumbsupply.com

Tub Faucets

Ashlyn™ 2-Hdl Roman Tub Trim

- Requires rough-in kit
- 8-3/8" Reach, 6-5/8" high rigid spout
- 5-1/2" From deck to aerator
- Red/blue indicators
- 2-5/8" Diameter handle bases



(T4764 Model)

- 5-Setting handshower includes double check valves for backflow prevention
- Touch-Clean® spray holes
- Handshower flow rate: 2.0 gpm @ 80 psi

Part #	Mfg #	Description	Handle(s)	Finish	Price
173153	T2764	3-Hole 8"-16"cc	ADA Lever	Chrome	
172038	T2764-RB	3-Hole 8"-16"cc	ADA Lever	Venetian Bronze®	
173095	T2764-SS	3-Hole 8"-16"cc	ADA Lever	Stainless*	
180170	T4764	4-Hole 8"-16"cc, w/ Handshower	ADA Lever	Chrome	
171539	T4764-RB	4-Hole 8"-16"cc, w/ Handshower	ADA Lever	Venetian Bronze®	
173518	T4764-SS	4-Hole 8"-16"cc, w/ Handshower	ADA Lever	Stainless*	

Cassidy™ 2-Hdl Roman Tub Trim

- Requires rough-in kit
- 10-3/32" Reach, 9-11/32" high rigid slip-on spout
- 6-19/32" From deck to aerator
- Handles sold separately



T2797-

T4797-

(T4797-LHP Model)

- Three-setting H2Okinetic™ handshower -H2Okinetic™ spray, massage spray, and pause
- Self-cleaning H2Okinetic® spray holes
- Handshower includes double check valves for backflow prevention
- Handshower flow rate: 2.0 gpm @ 80 psi

Part #	Mfg #	Description	Handle(s)	Finish	Price
152933	T2797-CZLHP	3-Hole, 8"-16"cc	Less Handles	Champagne Bronze™	
151502	T2797-LHP	3-Hole, 8"-16"cc	Less Handles	Chrome	
152935	T2797-PNLHP	3-Hole, 8"-16"cc	Less Handles	Polished Nickel*	
152936	T2797-RBLHP	3-Hole, 8"-16"cc	Less Handles	Venetian Bronze®	
152937	T2797-SSLHP	3-Hole, 8"-16"cc	Less Handles	Stainless*	
152950	T4797-CZLHP	4-Hole, 8"-16"cc with Handshower	Less Handles	Champagne Bronze™	
152944	T4797-LHP	4-Hole, 8"-16"cc with Handshower	Less Handles	Chrome	
152951	T4797-PNLHP	4-Hole, 8"-16"cc with Handshower	Less Handles	Polished Nickel*	
151694	T4797-RBLHP	4-Hole, 8"-16"cc with Handshower	Less Handles	Venetian Bronze®	
151697	T4797-SSLHP	4-Hole, 8"-16"cc with Handshower	Less Handles	Stainless*	

* Brilliance® Anti-Tarnish Lifetime Finishes

www.plumbsupply.com • Serving our Customers Since 1946 • www.waterconcepts.net

Tub Faucets

Faucets & Valves

Cassidy™ 2-Hdl Low Arc Spout Tub Trim

- Requires rough-in kit
- 10-3/32" Reach, 6-11/16" high rigid slip-on spout
- 4-11/32" From deck to aerator
- Handles sold separately
- 2-3/4" Diameter handle bases



T2795-

T4795-

(T4795-LHP Model)

- H2Okinetic™ handshower includes double check valve for backflow prevention
- 3-Setting handshower
- Self-cleaning H2Okinetic® spray holes
- Handshower flow rate: 2.0 gpm @ 80 psi

Part #	Mfg #	Description	Handle(s)	Finish	Price
152835	T2795-CZLHP	3-Hole, 8"-16"cc	Less Handles	Champagne Bronze™	
152834	T2795-LHP	3-Hole, 8"-16"cc	Less Handles	Chrome	
152930	T2795-PNLHP	3-Hole, 8"-16"cc	Less Handles	Polished Nickel*	
152931	T2795-RBLHP	3-Hole, 8"-16"cc	Less Handles	Venetian Bronze®	
152932	T2795-SSLHP	3-Hole, 8"-16"cc	Less Handles	Stainless*	
152938	T4795-LHP	4-Hole, 8"-16"cc with Handshower	Less Handles	Chrome	
152939	T4795-CZLHP	4-Hole, 8"-16"cc with Handshower	Less Handles	Champagne Bronze™	
152940	T4795-PNLHP	4-Hole, 8"-16"cc with Handshower	Less Handles	Polished Nickel*	
152369	T4795-RBLHP	4-Hole, 8"-16"cc with Handshower	Less Handles	Venetian Bronze™	
152941	T4795-SSLHP	4-Hole, 8"-16"cc with Handshower	Less Handles	Stainless*	

Cassidy™ Roman Tub Handshower with Transfer Valve

- Ledge or wall-mount transfer valve for maximum 1-3/4" deck thickness
- 69" long UltraFlex® hose
- Handle mounts on deck only
- 2-3/4" diameter handle base
- H2Okinetic® handshower includes double check valves for backflow prevention
- Self-cleaning H2Okinetic® spray holes
- Flow rate: 2.0 gpm @ 80 psi



Order handles separately (LHP)

Handle Options Include: H595, H597, or H598

Part #	Mfg #	Description	Handle(s)	Finish	Price
152982	RP72767LHP	2-Hole, 4"-18cc"	Less Handles	Chrome	
152983	RP72767CZLHP	2-Hole, 4"-18cc"	Less Handles	Champagne Bronze™	
152984	RP72767PNLHP	2-Hole, 4"-18cc"	Less Handles	Polished Nickel*	
152985	RP72767RBLHP	2-Hole, 4"-18cc"	Less Handles	Venetian Bronze®	
152986	RP72767SSLHP	2-Hole, 4"-18cc"	Less Handles	Stainless*	

* Brilliance® Anti-Tarnish Lifetime Finishes

www.waterconcepts.net • Serving our Customers Since 1946 • www.plumbsupply.com

Tub Faucets

Traditional Roman Tub Handshower with Transfer Valve

- Ledge or wall-mount transfer valve for maximum 1-3/4" deck thickness
- 69" Long UltraFlex® hose
- Touch-Clean® handshower includes double check valves for backflow prevention
- Handle mounts on deck only
- 2-5/8" diameter handle base
- WaterSense® certified: 2.0 gpm @ 80 psi



Order handles separately (LHP)

Part #	Mfg #	Description	Handle(s)	Finish	Price
162206	RP33791CZLHP	2-Hole, 4"-18"cc	Less Handles	Champagne Bronze™	

Roman Tub Handshower Wand

- 7 1/2" long
- 2 1/2" diameter spray face
- Hand Shower includes double check valves for backflow prevention
- WaterSense® certified: 2.0 gpm @ 80 psi

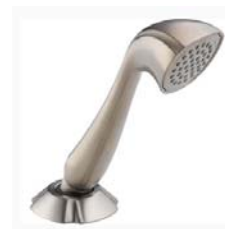

Part #	Mfg #	Description	Handle(s)	Finish	Price
155100	RP61283SS	Stainless*			

Classic Roman Tub Handshower with Transfer Valve

- Ledge or wall-mount transfer valve for maximum 1-3/4" deck thickness
- 69" Long UltraFlex® hose
- 2-19/32" Diameter handle base
- Handle mounts on deck only
- Handshower includes double check valves for backflow prevention
- Touch-Clean® spray holes
- Soft-Touch® handle
- WaterSense certified: 2.0 gpm @ 80 psi



Part #	Mfg #	Description	Handle(s)	Finish	Price
003477	RP14979	2-Hole, 4"-18"cc	Less Handles	Chrome	
137196	RP14979SS	2-Hole, 4"-18"cc	Less Handles	Stainless*	

* Brilliance® Anti-Tarnish Lifetime Finishes

www.plumbsupply.com • Serving our Customers Since 1946 • www.waterconcepts.net

Tub Faucets

Faucets & Valves

Classic 2-Hdl Roman Tub Trim

- Requires rough-in kit
- 8-1/8" Reach, 7-1/2" High
- 4-4/5" From deck to outlet
- 2-19/32" Diameter handle bases



(T4705 Model)

- 7-1/2" Reach, 5-3/16" high rigid slip-on spout
- 3-1/4" From deck to aerator
- Touch-Clean® handshower includes double check valves for backflow prevention
- Handshower flow rate: 2.0 gpm @ 60 psi

Part #	Mfg #	Description	Handle(s)	Finish	Price
134645	T2705	3-Hole, 8"-16"cc	ADA Lever	Chrome	
134562	T2705-SS	3-Hole, 8"-16"cc	ADA Lever	Stainless*	
106910	T4705	4-Hole, 8"-16"cc	ADA Lever	Chrome	
137332	T4705-SS	4-Hole, 8"-16"cc	ADA Lever	Stainless*	
093055	T2710	3-Hole, 8"-16"cc Low Spout	Acrylic Knob	Chrome	

Compel® 2-Hdl Roman Tub Trim

- Requires rough-in kit
- 8-3/4" reach, 8-1/4" high rigid slip-on spout
- 4-3/4" From deck to aerator
- 2-1/2" Diameter handle bases



(T4761 Model)

- Touch-Clean® handshower includes double check valves for backflow prevention
- Handshower flow rate: 2.0 gpm @ 80 psi

Part #	Mfg #	Description	Handle(s)	Finish	Price
157503	T2761	3-Hole, 8"-16"cc	ADA Lever	Chrome	
157480	T2761-SS	3-Hole, 8"-16"cc	ADA Lever	Stainless*	
154547	T4761	4-Hole, 8"-16"cc w/ Handshower	ADA Lever	Chrome	
164973	T4761-SS	4-Hole, 8"-16"cc w/ Handshower	ADA Lever	Stainless*	

Dryden® 2-Hdl Roman Tub Trim

- Requires rough-in kit
- 9" Reach, 7-3/4" high rigid slip-on spout
- 4" From deck to aerator



(T4751-LHP Model)

- Touch-Clean® full body handshower includes double check valves for backflow prevention
- Handshower flow rate: 2.0 gpm @ 80 psi

Part #	Mfg #	Description	Handle(s)	Finish	Price
116254	T2751	3-Hole, 8"-16"cc	ADA Lever	Chrome	
160600	T2751-CZ	3-Hole, 8"-16"cc	ADA Lever	Champagne Bronze™	

* Brilliance® Anti-Tarnish Lifetime Finishes

www.waterconcepts.net • Serving our Customers Since 1946 • www.plumbsupply.com

Tub Faucets

Two-Handle Roman Tub Trim Packs (Continued)

Dryden® 2-Hdl Roman Tub Trim

Part #	Mfg #	Description	Handle(s)	Finish	Price
187681	T2751-PN	3-Hole, 8"-16"cc	ADA Lever	Polished Nickel*	
116289	T2751-RB	3-Hole, 8"-16"cc	ADA Lever	Venetian Bronze®	
116290	T2751-SS	3-Hole, 8"-16"cc	ADA Lever	Stainless*	
116291	T4751	4-Hole, 8"-16"cc w/ Handshower	ADA Lever	Chrome	
168433	T4751-CZ	4-Hole, 8"-16"cc w/ Handshower	ADA Lever	Champagne Bronze™	
175054	T4751-PN	4-Hole, 8"-16"cc w/ Handshower	ADA Lever	Polished Nickel*	
116293	T4751-RB	4-Hole, 8"-16"cc w/ Handshower	ADA Lever	Venetian Bronze®	
116294	T4751-SS	4-Hole, 8"-16"cc w/ Handshower	ADA Lever	Stainless*	

Foundations® Roman Tub Trim

- Requires rough-in kit
- 6-7/8" Reach, 4-1/2" high rigid slip-on spout
- 3" From deck to aerator
- 2-7/16" Diameter handle bases



Part #	Mfg #	Description	Handle(s)	Finish	Price
136068	BT2710	3-Hole, 8"-16"cc	ADA Lever	Chrome	
140289	BT2710SS	3-Hole, 8"-16"cc	ADA Lever	Stainless*	

Windemere® 2-Hdl Roman Tub Trim

- Requires rough-in kit
- 7-11/16" Reach, 7-5/16" high rigid slip-on spout
- 5-11/32" From deck to aerator
- 2-3/8" Diameter handle bases



Part #	Mfg #	Description	Handle(s)	Finish	Price
138413	BT2796	3-Hole, 8"-16"cc	ADA Lever	Chrome	
135262	BT2796-OB	3-Hole, 8"-16"cc	ADA Lever	Oil Rubbed Bronze	
137029	BT2796-SS	3-Hole, 8"-16"cc	ADA Lever	Stainless*	

Lahara® 2-Hdl Roman Tub Trim

- Requires rough-in kit
- 8-3/4" Reach, 8-1/2" high rigid slip-on spout
- 5-3/8" From deck to aerator
- 2-5/8" Diameter scalloped handle bases



(T4738 Model)

- Touch-Clean® full body handshower includes double check valves for backflow prevention
- Handshower flow rate: 2.0 gpm @ 80 psi

Part #	Mfg #	Description	Handle(s)	Finish	Price
110777	T2738	3-Hole, 8"-16"cc	ADA Lever	Chrome	

* Brilliance® Anti-Tarnish Lifetime Finishes

www.plumbsupply.com • Serving our Customers Since 1946 • www.waterconcepts.net

Tub Faucets

Faucets & Valves

Two-Handle Roman Tub Trim Packs (Continued)

Lahara® 2-Hdl Roman Tub Trim

Part #	Mfg #	Description	Handle(s)	Finish	Price
155122	T2738-CZ	3-Hole, 8"-16"cc	ADA Lever	Champagne Bronze™	
110971	T2738-RB	3-Hole, 8"-16"cc	ADA Lever	Venetian Bronze®	
110972	T2738-SS	3-Hole, 8"-16"cc	ADA Lever	Stainless*	
110973	T4738	4-Hole, 8"-16"cc, Handshower	ADA Lever	Chrome	
189997	T4738-CZ	4-Hole, 8"-16"cc, Handshower	ADA Lever	Champagne Bronze™	
110976	T4738-RB	4-Hole, 8"-16"cc, Handshower	ADA Lever	Venetian Bronze®	
110977	T4738-SS	4-Hole, 8"-16"cc, Handshower	ADA Lever	Stainless*	

Linden™ 2-Hdl Roman Tub Trim

- Requires rough-in kit
- 8-3/8" Reach, 7-7/8" high rigid slip-on spout
- 5-1/2" From deck to aerator
- 2-3/8" Diameter handle bases



T2794

T4794

(T4794-LHP Model)
**Handshower includes double check valves for backflow prevention
Touch-Clean® Handshower**
Handshower flow rate: 2.0 gpm @ 60 psi

Part #	Mfg #	Description	Handle(s)	Finish	Price
147204	T2794	3-Hole 8"-16"cc	ADA Lever	Chrome	
145522	T2794-CZ	3-Hole 8"-16"cc	ADA Lever	Champagne Bronze™	
143315	T2794-RB	3-Hole 8"-16"cc	ADA Lever	Venetian Bronze®	
144339	T2794-SS	3-Hole 8"-16"cc	ADA Lever	Stainless*	
144638	T4794	4-Hole 8"-16"cc, Handshower	ADA Lever	Chrome	
156773	T4794-CZ	4-Hole 8"-16"cc, Handshower	ADA Lever	Champagne Bronze™	
143376	T4794-SS	4-Hole 8"-16"cc, Handshower	ADA Lever	Stainless*	
143615	T4794-RB	4-Hole 8"-16"cc, Handshower	ADA Lever	Venetian Bronze®	

Linden™ 2-Hdl Roman Tub Trim

- Requires rough-in kit
- 8-3/8" Reach, 7-7/8" high rigid slip-on spout
- 5-1/2" From deck to aerator
- 2-3/8" Diameter handle bases



T2793

T4793

(T4793-LHP Model)
**Handshower includes double check valves for backflow prevention
Touch-Clean® Handshower**
Handshower flow rate: 2.0 gpm @ 60 psi

Part #	Mfg #	Description	Handle(s)	Finish	Price
190198	T2793	3-Hole 8"-16"cc	ADA Lever	Chrome	
225097	T2793-SS	3-Hole 8"-16"cc	ADA Lever	Stainless	

* Brilliance® Anti-Tarnish Lifetime Finishes

www.waterconcepts.net • Serving our Customers Since 1946 • www.plumbsupply.com

Tub Faucets

Tesla® 2-Hdl Roman Tub Trim

- Requires rough-in kit
- 8-1/16" reach, 7-1/2" high slip-on rigid spout
- 6-1/4" From deck to aerator
- 2" x 2-1/2" diameter handle bases



T2752

T4752

(T4752 Model)

H2Okinetic® Handshower has four settings
Includes double check valves for backflow prevention

Self-cleaning H2Okinetic® spray holes
Handshower flow rate: 2.0 gpm @ 60 psi

Part #	Mfg #	Description	Handle(s)	Finish	Price
185042	T2752	3-Hole 8"-16"cc	ADA Lever	Chrome	
223739	T2752-SS	3-Hole 8"-16"cc	ADA Lever	Stainless*	
189283	T4752	4-Hole 8"-16"cc, Handshower	ADA Lever	Chrome	
222195	T4752-PN	4-Hole 8"-16"cc, Handshower	ADA Lever	Polished Nickel	
181162	T4752-SS	4-Hole 8"-16"cc, Handshower	ADA Lever	Stainless*	

Trinsic™ 2-Hdl Roman Tub Trim

- Requires rough-in kit
- 10" Reach, 10" high rigid slip-on spout
- 5-7/8" From deck to aerator
- 2-1/2" Diameter handle bases



T2759

T4759

(T4795-LHP Model)

- Touch-Clean® full body handshower includes double check valves for backflow prevention
- Handshower flow rate: 2.0 gpm @ 80 psi

Part #	Mfg #	Description	Handle(s)	Finish	Price
153059	T2759	3-Hole 8"-16"cc	ADA Lever	Chrome	
153060	T2759-CZ	3-Hole 8"-16"cc	ADA Lever	Champagne Bronze™	
153061	T2759-RB	3-Hole 8"-16"cc	ADA Lever	Venetian Bronze®	
153062	T2759-SS	3-Hole 8"-16"cc	ADA Lever	Stainless*	
153063	T4759	4-Hole 8"-16"cc, Handshower	ADA Lever	Chrome	
153064	T4759-CZ	4-Hole 8"-16"cc, Handshower	ADA Lever	Champagne Bronze™	
153066	T4759-RB	4-Hole 8"-16"cc, Handshower	ADA Lever	Venetian Bronze®	
153067	T4759-SS	4-Hole 8"-16"cc, Handshower	ADA Lever	Stainless*	

* Brilliance® Anti-Tarnish Lifetime Finishes

www.plumbsupply.com • Serving our Customers Since 1946 • www.waterconcepts.net

Tub Faucets

Faucets & Valves

Vero™ 2-Hdl Roman Tub Trim

- Requires rough-in kit
- 8-3/4" Reach, 9-15/16" high rigid slip-on spout
- 5-31/32" From deck to spout
- 2-7/16" Handle bases
- Minimum 2-1/2" clearance to backsplash recommended



T2753



T4753

(T4753-LHP Model)

Handshower includes double check valves for backflow prevention
 Touch-Clean® full body handshower
 Handshower flow rate: 2.5 gpm @ 80 psi

Part #	Mfg #	Description	Handle(s)	Finish	Price
134771	T2753	3-Hole 8"-16"cc	ADA Lever	Chrome	
170131	T2753-CZ	3-Hole 8"-16"cc	ADA Lever	Champagne Bronze™	
156626	T2753-RB	3-Hole 8"-16"cc	ADA Lever	Venetian Bronze®	
134772	T2753-SS	3-Hole 8"-16"cc	ADA Lever	Stainless*	
134773	T4753	4-Hole 8"-16"cc, Handshower, Diverter Spout	ADA Lever	Chrome	
154742	T4753-CZ	4-Hole 8"-16"cc, Handshower, Diverter Spout	ADA Lever	Champagne Bronze™	
134774	T4753-SS	4-Hole 8"-16"cc, Handshower, Diverter Spout	ADA Lever	Stainless*	

Victorian® 2-Hdl Roman Tub Trim

- Requires rough-in kit
- 8-3/4" Reach, 7-1/2" high rigid slip-on spout
- 2-5/8" Diameter handle bases
- Handles sold separately

(T4755-LHP Model):

Touch-Clean® full body handshower
 Includes double check valves for backflow prevention
 Handshower flow rate: 2.0 gpm @ 80 psi

Part #	Mfg #	Description	Handle(s)	Finish	Price
093087	T2755-LHP	3-Hole 8"-16"cc	Less Handles	Chrome	
145818	T2755-CZLHP	3-Hole 8"-16"cc	Less Handles	Champagne Bronze™	
093093	T2755-RBLHP	3-Hole 8"-16"cc	Less Handles	Venetian Bronze®	
093094	T2755-SSLHP	3-Hole 8"-16"cc	Less Handles	Stainless*	
093095	T4755-LHP	4-Hole 8"-16"cc, Handshower	Less Handles	Chrome	
153937	T4755-CZLHP	4-Hole 8"-16"cc, Handshower	Less Handles	Champagne Bronze™	
093096	T4755-RBLHP	4-Hole 8"-16"cc, Handshower	Less Handles	Venetian Bronze®	
093097	T4755-SSLHP	4-Hole 8"-16"cc, Handshower	Less Handles	Stainless*	

* Brilliance® Anti-Tarnish Lifetime Finishes

www.waterconcepts.net • Serving our Customers Since 1946 • www.plumbsupply.com

Tub Faucets

Roman Tub Trim

Baliza® 2-Hdl Roman Tub Trim

- 8-15/16" Reach, 7-25/64" high
- 5-7/8" From deck to aerator
- 2-1/2" Maximum deck thickness
- Requires rough-in valve R62707 (T67305)
- Requires rough-in valve R64707 (T67405)
- HANDLES SOLD SEPARATELY (HL605, HX605)



T64705-PCLHP w/ HX605 Handles

Part #	Mfg #	Description	Handle(s)	Finish	Price
141936	T67405-BNLHP	4-Hole 2.0 gpm Handshower, Slip-on Spout	Less Handles	Brushed Nickel*	
171310	T67405-BZLHP	4-Hole 2.0 gpm Handshower, Slip-on Spout	Less Handles	Brushed Bronze*	
173814	T67405-PCLHP	4-Hole 2.0 gpm Handshower, Slip-on Spout	Less Handles	Chrome	
134671	T67405-PNLHP	4-Hole 2.0 gpm Handshower, Slip-on Spout	Less Handles	Polished Nickel*	

Rook™ Roman Tub Trim

- 9-13/16" Reach, 7" high spout
- 3-1/2" From deck to aerator
- 2-1/2" Maximum deck thickness
- Requires rough-in valve for four hole R64707
- Requires rough-in valve for three hole R62707
- HANDLES SOLD SEPARATELY (HL660, HX660)



T67461-RBLHP w/ HL660-RB Handles

Part #	Mfg #	Description	Handle(s)	Finish	Price
223101	T67461-NKBLHP	4-Hole 2.0 gpm Handshower, Channel Spout	Less Handles	Luxe Nkl/Matte Blk	
185519	T67461-RBLHP	4-Hole 2.0 gpm Handshower, Channel Spout	Less Handles	Venetian Bronze®	

Charlotte™ 2-Hdl Roman Tub Trim

- 9" Reach, 9-1/8" high spout
- 6" From deck to aerator
- 2-1/2" Maximum deck thickness
- Requires rough-in valve R62707 (T67385)
- Requires rough-in valve R64707 (T67485)
- HANDLES SOLD SEPARATELY (HL685)



T67485-PCLHP w/ HL685-PC Handles

Part #	Mfg #	Description	Handle(s)	Finish	Price
150766	T67385-PNCOLHP	3-Hole, Slip-On Spout	Less Handles	Cocoa Bronze™/Pol Nickel	
167645	T67385-PNLHP	3-Hole, Slip-On Spout	Less Handles	Polished Nickel*	
171230	T67485-PCLHP	4-Hole 2.0 gpm Handshower, Slip-On Spout	Less Handles	Chrome	
144791	T67485-PNCOLHP	4-Hole 2.0 gpm Handshower, Slip-On Spout	Less Handles	Cocoa Bronze™/Pol Nickel	
155367	T67485-PNLHP	4-Hole 2.0 gpm Handshower, Slip-On Spout	Less Handles	Polished Nickel*	

* Brilliance® Anti-Tarnish Lifetime Finishes

www.plumbsupply.com • Serving our Customers Since 1946 • www.waterconcepts.net

Tub Faucets

Odin™ Roman Tub Trim

- 9" Reach, 11-1/2" high spout
- 6-1/2" From deck to aerator
- 2-3/4" Maximum deck thickness
- Requires rough-in valve R62707 (T67375)
- Requires rough-in valve R64707 (T67475)



Part #	Mfg #	Description	Handle(s)	Finish	Price
178520	T67375-BL	3-Hole, Slip-on Spout	ADA Lever	Matte Black	
157993	T67375-PC	3-Hole, Slip-on Spout	ADA Lever	Chrome	
185562	T67475-BN	4-Hole 2.0 gpm Handshower, Slip-on Spout	ADA Lever	Brushed Nickel*	
168707	T67475-PC	4-Hole 2.0 gpm Handshower, Slip-on Spout	ADA Lever	Chrome	

Providence™ Belle 2-Hdl Roman Tub Trim

- 9" Reach, 8-1/4" high spout
- 5" From deck to aerator
- 1-1/4" Maximum deck thickness
- Order RP18504 for additional 1" mounting aids
- Rough and trim included
- Flow rate: 18 gpm @ 60 psi
- HANDLES SOLD SEPARATELY (HK33H, HK37H, HK36)



6726-PCLHP w/ HK37H-PC Handles

Part #	Mfg #	Description	Handle(s)	Finish	Price
108796	6726-BNLHP	3-Hole	Less Handles	Brushed Nickel*	
074582	6726-PCLHP	3-Hole	Less Handles	Chrome	

Quiessence® 1-Hdl Roman Tub Trim

- 8-3/4" Reach, 7" high spout
- 5-1/4" From deck to aerator
- 3" Maximum deck thickness
- Wedge and maple wood accents included
- Rough and trim included
- 12.28 gpm @ 60 psi
- Handshower: 2.0 gpm @ 80 psi



Part #	Mfg #	Description	Handle(s)	Finish	Price
142904	67214-BN	3-Hole	ADA Lever	Brushed Nickel*	
159916	67214-PC	3-Hole	ADA Lever	Chrome	

* Brilliance® Anti-Tarnish Lifetime Finishes

www.waterconcepts.net • Serving our Customers Since 1946 • www.plumbsupply.com

Tub Faucets

RSVP® 2-Hdl Roman Tub Trim

- 9-3/4" Reach, 8" high spout
- 4" From deck to aerator
- 3" Maximum deck thickness
- Decorative finials available (RP48904, and RP47959)
- Requires rough-in valve R62707 (T67390)
- Requires rough-in valve R64707 (T67490)
- 18.5 gpm @ 60 psi
- HANDLES SOLD SEPARATELY (HL790, or HX790)



T67490-PC w/ HL790-PC Handles

Part #	Mfg #	Description	Handle(s)	Finish	Price
160247	T67490-BN	4-Hole	Less Handles	Brushed Nickel*	
141154	T67490-PC	4-Hole	Less Handles	Chrome	

Siderna® 2-Hdl Roman Tub Trim

- 10-15/16" Reach, 9-3/4" high spout
- 5-7/16" From deck to aerator
- 2-1/2" Maximum deck thickness
- 18 gpm @ 60 psi
- Requires rough-in valve R62707
- HANDLES SOLD SEPARATELY (HL680, HL681, or HL682)



T67380-PCLHP w/ HL680-PC Handles

Part #	Mfg #	Description	Handle(s)	Finish	Price
155289	T67380-BNLHP	3-Hole	Less Handles	Brushed Nickel*	
231644	T67380-BLLHP	3-Hole	Less Handles	Matte Black	
181626	T67380-PCLHP	3-Hole	Less Handles	Chrome	
162484	T67480-BLLHP	4-Hole, Matching Handshower	Less Handles	Matte Black	
176450	T67480-BNLHP	4-Hole, Matching Handshower	Less Handles	Brushed Nickel*	
168303	T67480-PCLHP	4-Hole, Matching Handshower	Less Handles	Chrome	

Sotria™ 2-Hdl Roman Tub Trim

- 9-3/8" Reach, 7-1/2" high spout
- 5-7/8" From deck to aerator
- Requires rough-in valve R62707 (T67350)
- Requires rough-in valve R64707 (T67450)



Part #	Mfg #	Description	Handle(s)	Finish	Price
222676	T67350-PC	3-Hole	ADA Lever	Chrome	
225071	T67450-BL	4-Hole, 2.0 gpm Handshower	ADA Lever	Matte Black	
177247	T67450-NK	4-Hole, 2.0 gpm Handshower	ADA Lever	Luxe Nickel*	

* Brilliance® Anti-Tarnish Lifetime Finishes

www.plumbsupply.com • Serving our Customers Since 1946 • www.waterconcepts.net

Tub Faucets

Tresa® 2-Hdl Roman Tub Trim

- 9" Reach, 8-1/2" high spout
- 5" From deck to aerator
- 2-1/2" Maximum deck thickness
- Requires rough-in valve R62707
- 20 gpm @ 60 psi



Part #	Mfg #	Description	Handle(s)	Finish	Price
172781	T67336-PN	3-Hole	ADA Lever	Polished Nickel*	
147261	T67336-RB	3-Hole	ADA Lever	Venetian Bronze®	
185901	T67338-PC	3-Hole	ADA Lever	Chrome	
175141	T67338-PN	3-Hole	ADA Cross	Polished Nickel*	

Tresa® 2-Hdl Roman Tub Trim with Cross Handles

- 9" Reach, 8-1/2" high spout
- 5" From deck to aerator
- 2-1/2" Maximum deck thickness
- Requires rough-in valve R64707 (T67438)
- Requires rough-in valve R2707 (T67338)
- 18.5 gpm @ 60 psi



Part #	Mfg #	Description	Handle(s)	Finish	Price
137925	T67438-BN	4-Hole, 2.0 gpm Handshower	Cross Handles	Brushed Nickel*	
171916	T67438-PC	4-Hole, 2.0 gpm Handshower	Cross Handles	Chrome	
171917	T67438-PN	4-Hole, 2.0 gpm Handshower	Cross Handles	Polished Nickel*	
125587	T67438-RB	4-Hole, 2.0 gpm Handshower	Cross Handles	Venetian Bronze®	

Vesi® Channel 2-Hdl Roman Tub Trim

- 9" Reach, 6-1/4" high
- 3-1/4" From deck to aerator
- 2-1/2" Maximum deck thickness
- 18 gpm @ 60 psi
- Requires rough-in valve R62707 (T6745)
- Requires rough-in valve R64707 (T67745)



Part #	Mfg #	Description	Handle(s)	Finish	Price
130805	T6745-BN	3-Hole	Lever Handles	Brushed Nickel*	
135231	T6745-BZ	3-Hole	Lever Handles	Brushed Bronze*	
096069	T67745-BN	4-Hole, 2.0 gpm Handshower	Lever Handles	Brushed Nickel*	
159675	T67745-BZ	4-Hole, 2.0 gpm Handshower	Lever Handles	Brushed Bronze*	

* Brilliance® Anti-Tarnish Lifetime Finishes

www.waterconcepts.net • Serving our Customers Since 1946 • www.plumbsupply.com

Tub Faucets

Vesi® Curve 2-Hdl Roman Tub Trim

- 9" Reach, 6-3/4" high spout
- 4" From deck to aerator
- 2-1/2" Maximum deck thickness
- 18 gpm @ 60 psi
- Requires rough-in valve R62707



Part #	Mfg #	Description	Handle(s)	Finish	Price
159861	T6740-BN	3-Hole	ADA Lever	Brushed Nickel*	
117635	T6740-PC	3-Hole	ADA Lever	Chrome	
160276	T67740-BN	4-Hole, 2.0 gpm Handshower	ADA Lever	Brushed Nickel*	

Virage® 2-Hdl Roman Tub Trim

- 9-5/16" Reach, 8-5/16" high spout
- 5-11/16" From deck to aerator
- 2-1/2" Maximum deck thickness
- Requires rough-in valve R62707 (T67330)
- Requires rough-in valve R64707 (T67430)
- Maximum flow rate: 20 gpm @ 60 psi



Part #	Mfg #	Description	Handle(s)	Finish	Price
165444	T67330-BN	3-Hole, Slip-On Spout	ADA Lever	Brushed Nickel*	
181852	T67330-BZ	3-Hole, Slip-On Spout	ADA Lever	Brushed Bronze*	
129979	T67330-PC	3-Hole, Slip-On Spout	ADA Lever	Chrome	
169998	T67330-PN	3-Hole, Slip-On Spout	ADA Lever	Polished Nickel*	
133557	T67430-BN	4-Hole, 2.0 gpm Handshower Slip-On Spout	ADA Lever	Brushed Nickel*	
146530	T67430-PC	4-Hole, 2.0 gpm Handshower Slip-On Spout	ADA Lever	Chrome	
139476	T67430-RB	4-Hole, 2.0 gpm Handshower Slip-On Spout	ADA Lever	Venetian Bronze®	

1-Hdl Freestanding Tub Fillers

Odin™ Single Handle Freestanding Tub Filler

- Floor mounted
- Solid brass construction
- 8-7/8" Reach, 40-1/2" high
- 35-7/16" From floor to spout outlet
- High flow ceramic mixing cartridge
- Indexing handshower holder
- Handshower flow rate: 2.0 gpm @ 80 psi
- 60" - 82" Stretchable metal hose
- 14.5 gpm @ 60 psi With R70100
- 12 gpm @ 60 psi With R70100-WS
- Drain and rough-in valves sold separately



Part #	Mfg #	Description	Handle(s)	Finish	Price
171028	T70175-PC	1-Hole, H2Okinetic® Handshower	ADA Lever	Chrome	

* Brilliance® Anti-Tarnish Lifetime Finishes

www.plumbsupply.com • Serving our Customers Since 1946 • www.waterconcepts.net

Tub Faucets

Faucets & Valves

Rook™ Single Handle Freestanding Tub Filler

- Floor mounted
- Solid brass construction
- 9-13/16" Reach, 38-5/16" high
- 34-7/8" From floor to spout outlet
- High flow ceramic mixing cartridge
- Auto resetting diverter
- Certified dual check valves in handshower
- Drain no included
- Includes single-function handshower - 2.0 GPM
60"-82" stretchable finished metal hose



Requires Rough-In:
R701 00-WS with integrated stops
or
R70100 without stops, provides maximum flow

Part #	Mfg #	Description	Handle(s)	Finish	Price
227070	T70161-NK	1-Hole, 2.0 GPM Handshower	ADA Lever	Luxe Nickel	

Siderna® Single-Handle Freestanding Tub Filler

- Floor mounted
- Solid brass construction
- 9-5/16" Reach, 40-1/2" high
- 35-13/32" From floor to spout outlet
- High flow ceramic mixing cartridge
- Indexing handshower holder
- Handshower flow rate: 2.0 gpm @ 80 psi
- 60" - 82" Stretchable metal hose
- 14.5 gpm @ 60 psi With R70100
- 12 gpm @ 60 psi With R70100-WS
- Drain and rough-in valves sold separately



Part #	Mfg #	Description	Handle(s)	Finish	Price
175599	T70180-BN	1-Hole, Touch-Clean® Handshower	ADA Lever	Brushed Nickel*	
226385	T70180-BL	1-Hole, Touch-Clean® Handshower	ADA Lever	Matte Black	
169310	T70180-PC	1-Hole, Touch-Clean® Handshower	ADA Lever	Chrome	

* Brilliance® Anti-Tarnish Lifetime Finishes

www.waterconcepts.net • Serving our Customers Since 1946 • www.plumbsupply.com

Tub Faucets

Sotria™ Single-Handle Freestanding Tub Filler

- Floor mounted
- Solid brass construction
- 11-11/16" Reach, 39" high
- 35-5/16" From floor to spout outlet
- High flow ceramic mixing cartridge
- Indexing handshower holder
- Handshower flow rate: 2.0 gpm @ 80 psi
- 60" - 82" Stretchable metal hose
- 14.5 gpm @ 60 psi With R70100
- 12 gpm @ 60 psi With R70100-WS
- Drain and rough-in valves sold separately



Part #	Mfg #	Description	Handle(s)	Finish	Price
174107	T70150-NK	1-Hole, H2Okinetic® Handshower	ADA Lever	Luxe Nickel*	
179426	T70150-PN	1-Hole, H2Okinetic® Handshower	ADA Lever	Polished Nickel*	

Virage® Single-Handle Freestanding Tub Filler

- Floor mounted
- Solid brass construction
- 9-5/16" Reach, 40-1/2" high
- 35-13/32" From floor to spout outlet
- High flow ceramic mixing cartridge
- Indexing handshower holder
- Handshower flow rate: 2.0 gpm @ 80 psi
- 60" - 82" Stretchable metal hose
- 14.5 gpm @ 60 psi With R70100
- 12 gpm @ 60 psi With R70100-WS
- Drain and rough-in valves sold separately



Part #	Mfg #	Description	Handle(s)	Finish	Price
165271	T70130-BN	1-Hole, H2Okinetic® Handshower	ADA Lever	Brushed Nickel*	
165909	T70130-PC	1-Hole, H2Okinetic® Handshower	ADA Lever	Chrome	
187887	T70130-RB	1-Hole, H2Okinetic® Handshower	ADA Lever	Venetian Bronze®	

* Brilliance® Anti-Tarnish Lifetime Finishes

www.plumbsupply.com • Serving our Customers Since 1946 • www.waterconcepts.net

Tub Faucets

2-Hdl Freestanding Tub Fillers

Body Assembly + Trim Kit + Floor, Deck, or Wall Mount Components + Rough (Floor Mount Only) = Completed Set

Traditional Two-Handle Freestanding Tub Filler Body Assembly

- Solid brass construction
- High flow ceramic control valves
- Handshower cradle rotates 90° in either direction
- 12 gpm @ 60 psi With R70200
- 10 gpm @ 60 psi With R70200-WS



Part #	Mfg #	Description	Handle(s)	Finish	Price
173484	T70210-BNLHP	2-Hole Floor, Deck, or Wall Mounted Installation	-	Brushed Nickel*	
165672	T70210-PCLHP	2-Hole Floor, Deck, or Wall Mounted Installation	-	Chrome	
172170	T70210-PNLHP	2-Hole Floor, Deck, or Wall Mounted Installation	-	Polished Nickel*	
172604	T70210-RBLHP	2-Hole Floor, Deck, or Wall Mounted Installation	-	Venetian Bronze®	

Charlotte™ Tub Filler Trim

- 8-1/4" Reach (deck & floor mount)
- 10-5/8" Reach (wall mount)
- Bi-directional diverter lever handle
- Handshower includes dual check valves for backflow prevention
- 60" - 82" Stretchable metal hose



Part #	Mfg #	Description	Handle(s)	Finish	Price
173485	T70385-BN	2.0 gpm Handshower	Lever Handles	Brushed Nickel*	
173660	T70385-PC	2.0 gpm Handshower	Lever Handles	Chrome	
172171	T70385-PN	2.0 gpm Handshower	Lever Handles	Polished Nickel*	

Traditional Tub Filler Trim Kit

- 8-1/4" Reach (deck & floor mount)
- 10-1/2" Reach (wall mount)
- Bi-directional diverter lever handle
- Handshower includes dual check valves for backflow prevention
- 60" - 82" Stretchable metal hose



Part #	Mfg #	Description	Handle(s)	Finish	Price
182499	T70336-BN	2.0 gpm Handshower	Lever Handles	*Brushed Nickel	
165671	T70336-PC	2.0 gpm Handshower	Lever Handles	Chrome	
172603	T70336-RB	2.0 gpm Handshower	Lever Handles	Venetian Bronze®	

* Brilliance® Anti-Tarnish Lifetime Finishes

www.waterconcepts.net • Serving our Customers Since 1946 • www.plumbsupply.com

Tub Faucets

Tub Filler Accessories

Baliza® Tub Filler Risers



RP73764



RP73765

Part #	Mfg #	Description	Handle(s)	Finish	Price
182500	RP73764-BN	Dual Column Design, Wall Mount	-	Brushed Nickel*	
181906	RP73765-BN	Dual Column Design, Deck-Mount	-	Brushed Nickel*	
173326	RP73765-RB	Dual Column Design, Deck-Mount	-	Venetian Bronze*	

Baliza® Tub Filler Spout Reach Extensions

- Solid brass construction
- 8" center to center; insulated to control surface condensation and heat
- Provides 2" of additional spout reach for the wall, deck & floor mount configurations
- Must order in conjunction with wall mount unions, floor mount risers, or deck mount risers



Part #	Mfg #	Description	Handle(s)	Finish	Price
222865	RP80157PC	8" center-to-center	-	Chrome	

Traditional Floor Mount Tub Filler Risers

- Solid brass construction
- 38" Overall height (risers only)
- 31-3/4" - 32-11/16" From floor to spout outlet depending on tub filler trim kit
- Optional riser extension set (RP73767) provides 2" of additional spout height
- Insulated to control surface condensation and heat
- Rough-in valve sold separately



Part #	Mfg #	Description	Handle(s)	Finish	Price
173487	RP73766BN	Dual column design, 8" center-to-center	-	Brushed Nickel*	
165673	RP73766PC	Dual column design, 8" center-to-center	-	Chrome	
172172	RP73766PN	Dual column design, 8" center-to-center	-	Polished Nickel*	
172602	RP73766RB	Dual column design, 8" center-to-center	-	Venetian Bronze®	

* Brilliance® Anti-Tarnish Lifetime Finishes

www.plumbsupply.com • Serving our Customers Since 1946 • www.waterconcepts.net

Tub Faucets

Faucets & Valves

Two-Handle Roman Tub Trim

90° 2-Hdl Roman Tub Trim

- Fits M•PACT® system
- 9" Reach, 4-3/4" high spout
- 4-1/4" From deck to aerator



Requires Valve: 4793

w/ Handshower Requires: 9793

Part #	Mfg #	Description	Handle(s)	Finish	Price
132633	TS903	3-Hole, 10" - 24" Centers	ADA Lever	Chrome	

Align® 2-Hdl Roman Tub Trim

- Fits M•PACT® system
- 7.90" Spout reach



Requires Valve: 4793

w/ Handshower Requires: 9793

Part #	Mfg #	Description	Handle(s)	Finish	Price
146176	TS903BN	3-Hole, 10" - 24" Centers	ADA Lever	Brushed Nickel	
202157	TS904	4-Hole, 10" - 24" Centers, 2.0 gpm Handshower	ADA Lever	Chrome	
147963	TS904BN	4-Hole, 10" - 24" Centers, 2.0 gpm Handshower	ADA Lever	Brushed Nickel	
177263	T393	3-Hole	ADA Lever	Chrome	
219182	T393BN	3-Hole	ADA Lever	Brushed Nickel	
223516	T394	4-Hole, 2.0 gpm Handshower	ADA Lever	Chrome	

Arris™ 2-Hdl Roman Tub Trim

- Fits M•PACT® system
- 8.08" Spout reach



Requires Valve: 4793

w/ Handshower Requires Valve: 9793

Part #	Mfg #	Description	Handle(s)	Finish	Price
160880	TS93003	3-Hole, 10" - 24" Centers	ADA Lever	Chrome	
184652	TS93003BN	3-Hole, 10" - 24" Centers	ADA Lever	Brushed Nickel	
178069	TS93004	4-Hole, 10" - 24" Centers, 2.0 gpm Handshower	ADA Lever	Chrome	

Brantford™ 2-Hdl Roman Tub Trim

- Fits M•PACT® system
- 7-1/4" Spout reach
- 7-1/4" From deck to aerator



Requires Valve: 4793

w/ Handshower Requires Valve: 9793

Part #	Mfg #	Description	Handle(s)	Finish	Price
126008	T933	3-Hole, 10" - 24" Centers	ADA Lever	Chrome	

*Lifeshine® Anti-Tarnish Lifetime Finish

www.waterconcepts.net • Serving our Customers Since 1946 • www.plumbsupply.com

Tub Faucets

Two-Handle Roman Tub Trim (Continued) Brantford™ 2-Hdl Roman Tub Trim

Part #	Mfg #	Description	Handle(s)	Finish	Price
102296	T933BN	3-Hole, 10" - 24" Centers	ADA Lever	Brushed Nickel	
102289	T933ORB	3-Hole, 10" - 24" Centers	ADA Lever	Oil Rubbed Bronze	
111593	T924	4-Hole, 10" - 24" Centers, 2.0 gpm Handshower	ADA Lever	Chrome	
108122	T924BN	4-Hole, 10" - 24" Centers, 2.0 gpm Handshower	ADA Lever	Brushed Nickel	
108188	T924ORB	4-Hole, 10" - 24" Centers, 2.0 gpm Handshower	ADA Lever	Oil Rubbed Bronze	

Brantford 2-Hdl Garden Tub Trim

- Fits M•PACT® system
- 6-3/8" Spout reach, 6" spout height
- 4-1/2" From deck to aerator



Requires Valve: 4793

Part #	Mfg #	Description	Handle(s)	Finish	Price
138741	T4943	3-Hole, 10"-24" Centers	ADA Lever	Chrome	
110181	T4943BN	3-Hole, 10"-24" Centers	ADA Lever	Brushed Nickel	
105275	T4943ORB	3-Hole, 10"-24" Centers	ADA Lever	Oil Rubbed Bronze	

Chateau® 2-Hdl Roman Tub Trim

- Fits M•PACT® system
- 9" Spout reach



Requires Valve: 4793

w/ Handshower Requires Valve: 9793

Part #	Mfg #	Description	Handle(s)	Finish	Price
087523	T990	3-Hole, 10" - 24" Centers	ADA Lever	Chrome	
031379	T999	3-Hole, 10" - 24" Centers	Acrylic Knob	Chrome	

Dartmoor™ 2-Hdl Roman Tub Trim

- Fits M•PACT® system
- 8-7/16" Reach, 7" high spout
- 4-5/8" From deck to aerator



Requires Valve: 4793

w/ Handshower Requires Valve: 9793

Part #	Mfg #	Description	Handle(s)	Finish	Price
225803	T683	3-Hole, 10" - 24" Centers	ADA Lever	Chrome	

*Lifeshine® Anti-Tarnish Lifetime Finish

www.plumbsupply.com • Serving our Customers Since 1946 • www.waterconcepts.net

Tub Faucets

Eva™ 2-Hdl Roman Tub Trim

- Fits M•PACT® system
- 7.67" Spout reach



Requires Valve: 4793

w/ Handshower Requires Valve: 9793

Part #	Mfg #	Description	Handle(s)	Finish	Price
094491	T943	3-Hole, 10" - 24" Centers	ADA Lever	Chrome	
097631	T943BN	3-Hole, 10" - 24" Centers	ADA Lever	Brushed Nickel	
096184	T943ORB	3-Hole, 10" - 24" Centers	ADA Lever	Oil Rubbed Bronze	
095679	T944BN	4-Hole, 10" - 24" Centers w/ 2.0 gpm Handshower	ADA Lever	Brushed Nickel	
099675	T944ORB	4-Hole, 10" - 24" Centers w/ 2.0 gpm Handshower	ADA Lever	Oil Rubbed Bronze	

Kingsley® 2-Hdl Roman Tub Trim

- Fits M•PACT® system
- 9" Spout reach
- 7" From deck to aerator



Requires Valve: 4793

w/ Handshower Requires Valve: 9793

Part #	Mfg #	Description	Handle(s)	Finish	Price
195208	T920	3-Hole, 10" - 24" Centers	ADA Lever	Chrome	
079237	T920BN	3-Hole, 10" - 24" Centers	ADA Lever	Brushed Nickel	
077214	T920ORB	3-Hole, 10" - 24" Centers	ADA Lever	Oil Rubbed Bronze	
187402	T920P	3-Hole, 10" - 24" Centers	ADA Lever	Polished Brass	
084794	T920WR	3-Hole, 10" - 24" Centers	ADA Lever	Wrought Iron	
083853	T922BN	4-Hole, 10" - 24" Centers	ADA Lever	Brushed Nickel	
081258	T922ORB	4-Hole, 10" - 24" Centers	ADA Lever	Oil Rubbed Bronze	

Method™ 2-Hdl Roman Tub Trim

- Fits M•PACT® system
- 7-1/2" Spout reach
- 1/8" to 2-5/8" Deck thickness



Requires Valve: 9793

w/ Handshower Requires Valve: 9793

Part #	Mfg #	Description	Handle(s)	Finish	Price
153348	T987	4-Hole, 10" - 24" Centers, 2.0 gpm Handshower	ADA Lever	Chrome	

*Lifeshine® Anti-Tarnish Lifetime Finish

www.waterconcepts.net • Serving our Customers Since 1946 • www.plumbsupply.com

Tub Faucets

Rothbury™ 2-Hdl Roman Tub Trim

- Fits M•PACT® system
- 8" Spout reach
- 1/8" to 2-5/8" Deck thickness



Requires Valve: 4793

w/ Handshower Requires Valve: 9793

Part #	Mfg #	Description	Handle(s)	Finish	Price
164543	TS923	3-Hole, 10" - 24" Centers	ADA Lever	Chrome	
180827	TS925	4-Hole, 10" - 24" Centers w/ 2.0 gpm Handshower	ADA Lever	Chrome	

Voss™ 2-Hdl Roman Tub Trim

- Fits M•PACT® system
- 7.50" Spout reach
- 1/8" to 2-3/4" Deck thickness



Requires Valve: 4793

w/ Handshower Requires Valve: 9793

Part #	Mfg #	Description	Handle(s)	Finish	Price
150272	T693	3-Hole, 10" - 24" Centers	ADA Lever	Chrome	
152227	T693BN	3-Hole, 10" - 24" Centers	ADA Lever	Brushed Nickel	
153394	T693ORB	3-Hole, 10" - 24" Centers	ADA Lever	Oil Rubbed Bronze	
160291	T694BN	4-Hole, 10" - 24" Centers, 2.0 gpm Handshower	ADA Lever	Brushed Nickel	
152279	T694ORB	4-Hole, 10" - 24" Centers, 2.0 gpm Handshower	ADA Lever	Oil Rubbed Bronze	

Waterhill® 2-Hdl Roman Tub Trim

- Fits M•PACT® system
- 8-7/8" Spout reach
- 4-13/16" From deck to aerator



Requires Valve: 4793

w/ Handshower Requires Valve: 9793

Part #	Mfg #	Description	Handle(s)	Finish	Price
106413	TS214ORB	3-Hole, 10" - 24" Centers	ADA Lever	Oil Rubbed Bronze	

*Lifeshine® Anti-Tarnish Lifetime Finish

www.plumbsupply.com • Serving our Customers Since 1946 • www.waterconcepts.net

Tub Faucets

Faucets & Valves

Weymouth™ 2-Hdl Roman Tub Trim

- Fits M•PACT® system
- 8.10" Spout reach
- 1/8" to 2-5/8" Deck thickness



Pictured w/ Cross Handles

Requires Valve: 4793

w / Handshower Requires Valve: 9793

Part #	Mfg #	Description	Handle(s)	Finish	Price
176301	TS22103ORB	3-Hole, 10" - 24" Centers	ADA Lever	Oil Rubbed Bronze	
165868	TS21102BN	4-Hole, 10" - 24" Centers, 2.0 gpm Handshower	Cross	Brushed Nickel	
226095	TS21104BN	4-Hole, 10" - 24" Centers, 2.0 gpm Handshower	ADA Lever	Brushed Nickel	
181595	TS21104ORB	4-Hole, 10" - 24" Centers, 2.0 gpm Handshower	ADA Lever	Oil Rubbed Bronze	

Wynford™ 2-Hdl Roman Tub Trim

- Fits M•PACT® system
- 7.1/2" Spout reach



Requires Valve: 4793

w/ Handshower Requires Valve: 9793

Part #	Mfg #	Description	Handle(s)	Finish	Price
190258	T653	3-Hole, 10" - 24" Centers	ADA Lever	Chrome	
220058	T653BN	3-Hole, 10" - 24" Centers	ADA Lever	Brushed Nickel	
184809	T653NL	3-Hole, 10" - 24" Centers	ADA Lever	Polished Nickel	
181282	T653ORB	3-Hole, 10" - 24" Centers	ADA Lever	Oil Rubbed Bronze	
187213	T657	3-Hole, 10" - 24" Centers	ADA Cross	Chrome	
187214	T658	4-Hole, 10" - 24" Centers w/ Handshower	ADA Cross	Chrome	
219769	T658BN	4-Hole, 10" - 24" Centers w/ Handshower	ADA Cross	Brushed Nickel	

Freestanding Tub Fillers

Arris™ 1-Hdl Freestanding Tub Filler

- Fits M•PACT® valve system
- Single-function handshower and shower
- 11" Spout reach
- Floor mount
- Handshower flow rate: 2.0 gpm



Requires Valve: TS50100

Part #	Mfg #	Description	Handle(s)	Finish	Price
170175	S93005	11" Spout Reach, 2.0gpm Handshower	ADA Lever	Chrome	

*Lifeshine® Anti-Tarnish Lifetime Finish

www.waterconcepts.net • Serving our Customers Since 1946 • www.plumbsupply.com

Tub Faucets

Weymouth® 2-Hdl Freestanding Tub Filler

- Fits M•PACT® valve system
- Single-function handshower and shower
- 9" Spout reach
- 3/4" MNPT connections
- 59" Double interlock spiral metal hose
- Floor mount
- Handshower flow rate: 2.0 gpm



Requires: TS25105 Risers
TS50200 Rough-In Kit

Part #	Mfg #	Description	Handle(s)	Finish	Price
225631	S22110BN	9" Spout Reach, 2.0 gpm Handshower	ADA Lever	Brushed Nickel	

*Lifeshine® Anti-Tarnish Lifetime Finish

www.plumbsupply.com • Serving our Customers Since 1946 • www.waterconcepts.net



Tub Faucets

Two-Handle Tub Trim

P4B Builder Series 2-Hdl Roman Tub Faucet

- Ceramic cartridges
- High flow loose rough-in
- Maximum flow rate: 4.0 gpm @ 60 psi



Faucets & Valves

Part #	Mfg #	Description	Handle(s)	Finish	Price
141383	P4B-900C	3-Hole	ADA Metal Lever	Chrome	
141384	P4B-900BN	3-Hole	ADA Metal Lever	Brushed Nickel	
141385	P4B-900ORB	3-Hole	ADA Metal Lever	Oil Rubbed Bronze	

Tub Faucets

Tub Trim

39 Cast Brass 2-Hdl Bath Faucet

- Renew valves & seats
- Cast brass body on 3-3/8" centers
- Chrome finish
- Chrome metal dome type handles



Part #	Mfg #	Description	Price
010496	39	Bath Faucet with Nozzle	
026950	39C	Bath Faucet with Code Spout	

Tub Faucets

Faucets & Valves

Tub Spouts

Standard Tub Spout with Front Diverter

- Tapered threads
- Slip connects to 5/8" O.D. with 1-3/8" adjustment

Part #	Mfg #	Length	Material	Price
184085	972-35	5-1/4"	Chrome-Plated Zinc	

SmartSpout™ Shower Diverter & Repair Adapter Kit

- For 1/2" copper tube
- Installs directly onto 1/2" copper stub out with #2 Phillips screwdriver
- Slip-fit convenience; secure, clean, tight to finished wall eliminating the need to caulk
- 5-1/4" overall length in three finish options
- Free dry seal pipe collar included with every SmartSpout™
- Optional copper extension adapter available
- Reduced end fits inside type M or type L copper to extend the length of the stub out



Part #	Mfg #	Finish	Clamshell	Price
184086	972-361PK2	Chrome	Yes	

Standard Two Hole Blank Tub Faceplate



Part #	Mfg #	Finish	2" Screws	Price
156743	974-60102	Chrome-Plated Steel	Two	

Tub Spouts

Tub Spouts

Alteo® Non-Diverter Tub Spout



Part #	Mfg #	Description	Finish	Price
144679	K-45133-BN	7-1/2" Reach	*Brushed Nickel	
153487	K-45133-CP	7-1/2" Reach	Polished Chrome	
170274	K-45133-2BZ	7-1/2" Reach	Oil-Rubbed Bronze	

Alteo® Diverter Tub Spout



		Description	Finish	
147969	K-45131-BN	6-1/2" Reach	*Brushed Nickel	
152420	K-45131-CP	6-1/2" Reach	Polished Chrome	
182292	K-45131-2BZ	6-1/2" Reach	Oil-Rubbed Bronze	

Artifacts® Wall-Mount Spout with Flare Design

- Metal construction



		Description	Finish	
162100	K-72791-BN	8" Reach	*Brushed Nickel	
166449	K-72791-CP	8" Reach	Polished Chrome	
174116	K-72791-SN	8" Reach	*Polished Nickel	
223896	K-72791-VNT	8" Reach	Vintage Nickel	
170523	K-72791-2BZ	8" Reach	Oil-Rubbed Bronze	

Artifacts® Non-Diverter Tub Spout with Turned Design

- Metal construction



		Description	Finish	
168022	K-72792-BN	8-7/16" Reach	*Brushed Nickel	
225935	K-72792-BV	8-7/16" Reach	*Brushed Bronze	
162834	K-72792-CP	8-7/16" Reach	Polished Chrome	
174461	K-72792-SN	8-7/16" Reach	*Polished Nickel	

* Vibrant Limited Lifetime Warranty

www.plumbsupply.com • Serving our Customers Since 1946 • www.waterconcepts.net

Tub Spouts

Bancroft® Wall-Mount Diverter Bath Spout

- Metal construction
- (K-10589) includes slip-fit connection



		Description	Finish
162201	K-10588-AF	5-3/4" Reach	*French Gold
130194	K-10588-BN	5-3/4" Reach	*Brushed Nickel
189640	K-10588-BV	5-3/4" Reach	*Brushed Bronze
097866	K-10588-CP	5-3/4" Reach	Polished Chrome
173110	K-10588-SN	5-3/4" Reach	*Polished Nickel
166280	K-10589-BN	5-3/4" Reach with Slip-fit Connection	*Brushed Nickel
121493	K-10589-CP	5-3/4" Reach with Slip-fit Connection	Polished Chrome
182988	K-10589-SN	5-3/4" Reach with Slip-fit Connection	*Polished Nickel

Coralais® Non-Diverter Tub Spout with NPT Connection



		Description	Finish
095975	K-15135-CP	4-7/8" Reach, NPT Connection	Polished Chrome
153619	K-15135-G	4-7/8" Reach, NPT Connection	Brushed Chrome

Coralais® Diverter Tub Spout



NPT Connection

Part #	Mfg #	Description	Handle(s)	Finish	Price
105547	K-15136-BN		4-7/8" Reach	*Brushed Nickel	
067310	K-15136-CP		4-7/8" Reach	Polished Chrome	
073896	K-15136-G		4-7/8" Reach	Brushed Chrome	
129500	K-15136-PB		4-7/8" Reach	*Polished Brass	
058480	K-15138-CP		8" Reach, NPT Connection	Polished Chrome	

Slip-Fit Connection

Part #	Mfg #	Description	Handle(s)	Finish	Price
074785	K-15136-S-BN		4-7/8" Reach, Slip-Fit Connection	*Brushed Nickel	
060794	K-15136-S-CP		4-7/8" Reach, Slip-Fit Connection	Polished Chrome	
135660	K-15136-S-G		4-7/8" Reach, Slip-Fit Connection	Brushed Chrome	
060717	K-15136-S-PB		4-7/8" Reach, Slip-Fit Connection	*Polished Brass	

* Vibrant Limited Lifetime Warranty

www.waterconcepts.net • Serving our Customers Since 1946 • www.plumbsupply.com

Tub Spouts

Devonshire Non-Diverter Tub Spout with NPT Connection



		Description	Finish
085076	K-373-BN	4-7/16" Reach, NPT Connection	*Brushed Nickel
108388	K-373-CP	4-7/16" Reach, NPT Connection	Polished Chrome
158579	K-373-PB	4-7/16" Reach, NPT Connection	*Polished Brass

Devonshire Diverter Tub Spout with Slip-Fit Connection



		Description	Finish
182858	K-389-S-CP	4-7/16" Reach, Diverter Slip Fit Connection	Polished Chrome
080750	K-389-S-BN	4-7/16" Reach, Diverter Slip Fit Connection	*Brushed Nickel
117124	K-389-S-BV	4-7/16" Reach, Diverter Slip Fit Connection	*Brushed Bronze
182859	K-389-S-PB	4-7/16" Reach, Diverter Slip Fit Connection	*Polished Brass
146967	K-389-S-2BZ	4-7/16" Reach, Diverter Slip Fit Connection	Oil-Rubbed Bronze

Forté® Diverter Tub Spout with 1/2" NPT Connection and Sculpted Lift Rod



		Description	Finish
087527	K-10280-4-BN	5-1/4" Reach, 1/2" NPT Connection	*Brushed Nickel
072075	K-10280-4-CP	5-1/4" Reach, 1/2" NPT Connection	Polished Chrome
127682	K-10280-4-G	5-1/4" Reach, 1/2" NPT Connection	Brushed Chrome

Loure® Non-Diverter Tub Spout



		Description	Finish
145890	K-14676-BN	9-3/4" Reach	*Brushed Nickel
159671	K-14676-CP	9-3/4" Reach	Polished Chrome

* Vibrant Limited Lifetime Warranty

www.plumbsupply.com • Serving our Customers Since 1946 • www.waterconcepts.net

Tub Spouts

Faucets & Valves

Memoirs® Stately Diverter Tub Spout with NPT Connection



		Description	Finish
088893	K-496-V-BN	6" Reach, NPT Connection	*Brushed Nickel
154455	K-496-V-BV	6" Reach, NPT Connection	*Brushed Bronze
088776	K-496-V-CP	6" Reach, NPT Connection	Polished Chrome
173099	K-496-2BZ	6" Reach, NPT Connection	Oil-Rubbed Bronze

Purist® Non-Diverter Bath Spout with 90° Arc



		Description	Finish
085530	K-14427-BN	7-3/4" Reach, 90° Arc	*Brushed Nickel
074138	K-14427-CP	7-3/4" Reach, 90° Arc	Polished Chrome
178254	K-14427-SN	7-3/4" Reach, 90° Arc	*Polished Nickel

Toobi™ Non-Diverter Bath Spout with 1/2" NPT Connection



		Description	Finish
156152	K-3962-BN	6-3/4" Reach, 1/2" NPT Connection	*Brushed Nickel
154693	K-3962-CP	6-3/4" Reach, 1/2" NPT Connection	Polished Chrome

Refinia® Diverter Tub Spout

- 5/8" O.D. slip-fit or 1/2" NPT connection



		Description	Finish
145407	K-5327-BN	6-3/4" Reach, 5/8" OD Slip-Fit or 1/2" NPT Connection	*Brushed Nickel
160899	K-5327-CP	6-3/4" Reach, 5/8" OD Slip-Fit or 1/2" NPT Connection	Polished Chrome

* Vibrant Limited Lifetime Warranty

www.waterconcepts.net • Serving our Customers Since 1946 • www.plumbsupply.com

Tub Spouts

Refinia® Non-Diverter Tub Spout

- 5/8" O.D. slip-fit or 1/2" NPT connection



		Description	Finish
149467	K-5328-BN	6-1/2" Reach, 5/8" OD Slip-Fit or 1/2" NPT Connection	*Brushed Nickel
145520	K-5328-CP	6-1/2" Reach, 5/8" OD Slip-Fit or 1/2" NPT Connection	Polished Chrome

Souris® Sheetflow Non-Diverter Tub Spout with 1/2" NPT Connection

- Requires minimum 6 gpm flow rate from supply valve
- 6-5/8"W x 4-7/8"H



		Description	Finish
156292	K-6946-BN	5-5/16" Reach, 1/2" Slip-Fit Connection	*Brushed Nickel
114684	K-6946-CP	5-5/16" Reach, 1/2" Slip-Fit Connection	Polished Chrome
105490	K-6946-PB	5-5/16" Reach, 1/2" Slip-Fit Connection	Polished Brass

Stance® Wall-Mount Tub Spout with 1/2" NPT Connection

- Brass construction



		Description	Finish
139622	K-14795-CP	7-7/8" Reach, 1/2" Slip-Fit Connection	Polished Chrome

Standard Diverter Tub Spout

- Solid brass construction



		Description	Finish
183622	K-6855-2BZ	IPS Connection	Oil-Rubbed Bronze
152170	K-85555-2BZ	IPS Connection	Oil-Rubbed Bronze
081693	GP85555-BN	IPS Connection	*Brushed Nickel
103917	GP85555-CP	IPS Connection	Polished Chrome
115373	GP85556-CP	Slip-Fit Connection	Polished Chrome

* Vibrant Limited Lifetime Warranty

www.plumbsupply.com • Serving our Customers Since 1946 • www.waterconcepts.net

Tub Spouts

Faucets & Valves

Diverter Tub Spouts

Addison™ Pull-Up Diverter Tub Spout

- 7-1/2" Long
- Thread onto 1/2" IPS nipple



Part #	Mfg #	Description	Price
137425	RP61269SS	Stainless*	

Ashlyn™ Diverter Tub Spout

- 7-15/16" Length
- Thread onto 1/2" IPS



Part #	Mfg #	Description	Price
187894	RP77091	Chrome	
179607	RP77091SS	Stainless*	
175219	RP770091RB	Venetian Bronze®	

Dryden™ Pull-Up Diverter Tub Spout

- 7/2" Length
- Thread onto 1/2" IPS nipple



Part #	Mfg #	Description	Price
180119	RP52148PN	Polished Nickel*	
118525	RP52148SS	Stainless*	

Lahara® Pull-Up Diverter Tub Spout

- 6-3/4" Length
- Thread onto 1/2" IPS nipple



Part #	Mfg #	Finish	Price
122471	RP51303	Chrome	
155806	RP51303CZ	Champagne Bronze™	
117832	RP51303RB	Venetian Bronze®	
113295	RP51303SS	Stainless*	

Leland® Diverter Tub Spout

- 6-1/2" Length
- Thread onto 1/2" IPS nipple



Part #	Mfg #	Finish	Price
109404	RP42915RB	Venetian Bronze®	
109599	RP42915SS	Stainless*	

Vero® Diverter Tub Spout

- 7-1/8" Length
- Thread onto 1/2" IPS nipple



Part #	Mfg #	Description	Price
136539	RP53419	Chrome	
151394	RP53419RB	Venetian Bronze®	
135444	RP53419SS	Stainless*	

RP47841 Diverter Tub Spout



Part #	Mfg #	Description	Price
187261	RP47841OB	Oil Rubbed Bronze	

RP61357 Diverter Tub Spout

- 5-3/8" Length
- Thread onto 1/2" IPS nipple



Part #	Mfg #	Description	Price
163620	RP61357	Chrome	
186372	RP61357OB	Oil Rubbed Bronze	

* Brilliance® Anti-Tarnish Lifetime Finishes

www.waterconcepts.net • Serving our Customers Since 1946 • www.plumbsupply.com

Tub Spouts

RP73371 Diverter Tub Spout

- 6-1/8" Length
- Thread onto 1/2" IPS nipple



Part #	Mfg #	Description	Price
159281	RP73371	Chrome	
164424	RP73371SS	Stainless*	

RP34357 Pull-Up Diverter Spout

- 7-1/2" Length
- Thread onto 1/2" IPS nipple



Part #	Mfg #	Description	Price
169275	RP34357CZ	Champagne Bronze™	
074878	RP34357SS	Stainless*	

RP52153 Pull-Up Diverter Spout

- 6-1/2" Length
- Thread onto 1/2" IPS nipple



Part #	Mfg #	Description	Price
223423	RP52153CZ	Champagne Bronze™	
175385	RP52153RB	Venetian Bronze®	
155378	RP52153SS	Stainless*	

RP72565 Pull-Up Diverter Spout

- 7-2/3" Length
- Thread onto 1/2" IPS nipple



Part #	Mfg #	Description	Price
163967	RP72565	Chrome	
170688	RP72565CZ	Champagne Bronze™	
162209	RP72565PN	Polished Nickel*	
163175	RP72565RB	Venetian Bronze®	
172165	RP72565SS	Stainless*	

RP19895 Diverter Tub Spout

- 5-1/2" Long
- Thread onto 1/2" IPS nipple



Part #	Mfg #	Finish	Price
047170	RP19895	Chrome	

RP19820 Diverter Tub Spout

- 5-1/2" Length
- Slip onto 1/2" CST



Part #	Mfg #	Finish	Price
003581	RP19820	Chrome	
159831	RP19820SS	Stainless*	

RP81273 Diverter Tub Spout

- Slip-On



Part #	Mfg #	Description	Price
227895	RP81273SS	Stainless	

RP73372 Diverter Tub Spout

- 7" Length
- Thread onto 1/2" IPS nipple



Part #	Mfg #	Description	Price
156843	RP73372	Chrome	
156906	RP73372SS	Stainless*	

RP5834 Diverter Tub Spout

- 5-1/2" Long
- Thread onto 1/2" IPS nipple



Part #	Mfg #	Finish	Price
003651	RP5834	Chrome	

Faucets & Valves

* Brilliance® Anti-Tarnish Lifetime Finishes

www.plumbsupply.com • Serving our Customers Since 1946 • www.waterconcepts.net

Tub Spouts

Faucets & Valves

RP17453 Diverter Tub Spout

- 6" Long
- Thread onto 1/2" IPS nipple



Part #	Mfg #	Finish	Price
003523	RP17453	Chrome	
096806	RP17453SS	Stainless*	

RP5836 Diverter Tub Spout

- 6-1/8" Length
- Slip onto 1/2" CWT

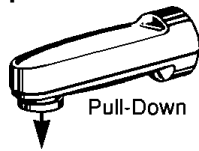

Part #	Mfg #	Finish	Price
003653	RP5836	Chrome	

U1075-PK Diverter Tub Spout

- 5-1/4" Length
- Thread onto 1/2" or 3/4" IPS nipple



Part #	Mfg #	Description	Price
154662	U1075-PK	Chrome	
174510	U1075-PB-PK	Polished Brass*	

RP64721 Pull-Up Diverter Tub Spout

- 7" Length
- Removable threaded adapter for 1/2" IPS



Part #	Mfg #	Description	Price
147568	RP64721	Chrome	
173461	RP64721OB	Oil-Rubbed Bronze	
162666	RP64721SS	Stainless*	

Handshower Diverter Tub Spout

- Thread onto 1/2" or 3/4" IPS



U1072-PK



U1010PK

Part #	Mfg #	Description	Price
001158	U1072-PK	5-1/4", 1/2" CWT Slip Fit, Chrome	
001154	U1010-PK	6-1/2", Threads onto 1/2" or 3/4" IPS, Chrome	
149133	U1010-SS-PK	6-1/2", Threads onto 1/2" or 3/4" IPS, Stainless	

RP75435 Diverter Tub-Spout

- 7-1/10" Length
- Thread onto 1/2" IPS nipple



Part #	Mfg #	Description	Price
187193	RP75435	Chrome	
171153	RP75435SS	Stainless*	

RP49094 Pull-Up Diverter Spout



Part #	Mfg #	Description	Price
154205	RP49094BN	Brushed Nickel*	

Non-Diverter Tub Spouts

Addison™ Non-Diverter Tub Spout



Part #	Mfg #	Description	Price
223420	RP54863CZ	Champagne Bronze™	

* Brilliance® Anti-Tarnish Lifetime Finishes

www.waterconcepts.net • Serving our Customers Since 1946 • www.plumbsupply.com

Tub Spouts

Ashlyn® Non-Diverter Tub Spout



Part #	Mfg #	Description	Price
185332	RP77092SS	Stainless*	

Dryden™ Non-Diverter Tub Spout

- 7-1/2" Length
- Thread onto 1/2" IPS nipple



Part #	Mfg #	Description	Price
129020	RP54323SS	Stainless*	

Lahara® Non-Diverter Tub Spout

- 6-3/4" Length
- Sweat onto 1/2" C.W.T. or thread onto 1/2" IPS



Part #	Mfg #	Description	Price
125098	RP53237	Chrome	
149439	RP53237CZ	Champagne Bronze™	
119644	RP53237RB	Venetian Bronze®	
121140	RP53237SS	Stainless*	

Vero™ Non-Diverter Tub Spout

- 7" Length
- Threads into nose of spout



Part #	Mfg #	Finish	Price
123317	RP48333	Chrome	

RP43028 Non-Diverter Tub Spout

- 7-1/2" Length
- Thread onto 1/2" IPS nipple
- Coordinates with Victorian®, Cassidy™, and Linden™



Part #	Mfg #	Description	Price
084517	RP43028	Chrome	
156282	RP43028CZ	Champagne Bronze™	
088992	RP43028SS	Stainless	

RP5833 Non-Diverter Tub Spout

- 4-3/4" Length
- Thread onto 1/2" IPS nipple -



Part #	Mfg #	Finish	Price
003650	RP5833	Chrome	

RP62149 Non-Diverter Tub Spout

- 5-3/8" Length
- Coordinates with Foundations® and Windemere®



Part #	Mfg #	Description	Price
161987	RP62149	Chrome	

RP64722 Non-Diverter Tub Spout

- 7" Length
- Removable threaded adapter for 1/2" IPS
- Coordinates with Foundations® and Windemere®



Part #	Mfg #	Description	Price
156695	RP64722	Chrome	
159725	RP64722OB	Oil-Rubbed Bronze	
159503	RP64722SS	Stainless*	

RP80132SS Non-Diverter Tub Spout



Part #	Mfg #	Description	Price
189293	RP80132SS	Stainless	

* Brilliance® Anti-Tarnish Lifetime Finishes

www.plumbsupply.com • Serving our Customers Since 1946 • www.waterconcepts.net

Tub Spouts

Tub Spouts

Baliza® Tub Spout

- Solid brass construction
- Pull-up diverter tub spout
- 7" Long



Part #	Mfg #	Description	Handle(s)	Finish	Price
160851	RP49094	7" Length, Diverter	Chrome		

Brizo® Non Diverter Tub Spout



		Description	Finish	
093908	RP37762	6-7/8" Length, Non-Diverter	Chrome	
144916	RP37762-BN	6-7/8" Length, Non-Diverter	Brushed Nickel*	
156700	RP37762-PN	6-7/8" Length, Non-Diverter	Polished Nickel*	
165010	RP37762-RB	6-7/8" Length, Non-Diverter	Venetian Bronze®	

Charlotte® Tub Spout Assembly

- Solid brass construction
- Pull-down diverter tub spout
- 8 3/8" long



Part #	Mfg #	Description	Handle(s)	Finish	Price
157365	RP70908PNCO	8-3/8" Length, Diverter	Cocoa Bronze™/Polished Nickel		

Modern Tub Spout Assembly

- Solid brass construction
- Pull-down diverter tub spout
- 5-5/2" long



Part #	Mfg #	Description	Handle(s)	Finish	Price
160594	RP54873BN	5-1/2" Length, Non-Diverter	Brushed Nickel*		
161848	RP54874BN	5-1/2" Length, Diverter	Brushed Nickel*		
156845	RP54874PC	5-1/2" Length, Diverter	Chrome		

Rook™ Channel Non-Diverter Tub Spout

- Solid brass construction
- Non-diverter tub spout
- 9-1/2" Long



Part #	Mfg #	Description	Handle(s)	Finish	Price
185632	RP78583NK	9-1/2" Length, Non-Diverter	Luxe Nickel*		

* Brilliance® Anti-Tarnish Lifetime Finishes

www.waterconcepts.net • Serving our Customers Since 1946 • www.plumbsupply.com

Tub Spouts

Sotria™ Non Diverter Tub Spout

- Solid brass construction
- Non-diverter tub spout
- 9" Long



Part #	Mfg #	Description	Handle(s)	Finish	Price
179652	RP74646NK	9" Length, Non-Diverter	Luxe Nickel*		

Vesi® Tub Spout-Pull Up-Diverter

- Solid brass construction
- Pull-up diverter tub spout
- 6-1/2" Long



Part #	Mfg #	Description	Handle(s)	Finish	Price
184814	RP49126BN	6-1/2" Length, Diverter	Brushed Nickel*		

* Brilliance® Anti-Tarnish Lifetime Finishes

www.plumbsupply.com • Serving our Customers Since 1946 • www.waterconcepts.net

Tub Spouts

Diverter Tub Spouts

Brantford® Diverter Tub Spout

- 7-1/4" Length
- 1/2" IPS connections



Part #	Mfg #	Description	Finish	Price
189243	3814	7-1/4" Diverter Spout Only	Chrome	
219791	3814BN	7-1/4" Diverter Spout Only	Brushed Nickel	
189333	3814ORB	7-1/4" Diverter Spout Only	Oil Rubbed Bronze	

Rothbury™ Diverter Tub Spout

- 7-5/8" Length
- 1/2" Slip fit



Part #	Mfg #	Description	Finish	Price
147554	S3859BN	7-5/8" Diverter Spout Only	Brushed Nickel	

Waterhill® Diverter Tub Spout

- 6-3/4" Length
- 1/2" Slip fit



Part #	Mfg #	Description	Finish	Price
113874	S114ORB	6-3/4" Diverter Tub Spout	Oil Rubbed Bronze	

Weymouth™ Diverter Tub Spout

- 1/2" Slip fit



Part #	Mfg #	Description	Finish	Price
176394	S12104	Tub Spout Only, 6-3/4"	Chrome	

Diverter Spout

- 7-1/4" Reach



Part #	Mfg #	Description	Finish	Price
150239	3857	Tub Spout Only, 7-1/4"	Chrome	
118661	3857BN	Tub Spout Only, 7-1/4"	Brushed Nickel	
136832	3857ORB	Tub Spout Only, 7-1/4"	Oil Rubbed Bronze	

*Lifeshine® Anti-Tarnish Lifetime Finish

www.waterconcepts.net • Serving our Customers Since 1946 • www.plumbsupply.com

Tub Spouts

Moen Diverter Spout

- 5-1/2" Spout length



Part #	Mfg #	Description	Finish	Price
113173	3801	Tub Spout Only, 5-1/2"	Chrome	

Diverter Tub Spout

- 5-1/2" Spout Length
- 1/2" Slip Fit



Part #	Mfg #	Description	Finish	Price
195701	3808	Tub Spout Only, 5-1/2"	Chrome	

Diverter Tub Spout

- 5-1/2" Spout Length
- 1/2" Slip fit



Part #	Mfg #	Description	Finish	Price
007268	3931	Tub Spout Only, 5-1/2"	Chrome	

Diverter Tub Spout



Part #	Mfg #	Description	Finish	Price
007262	3911	Tub Spout Only, 5-1/2"	Chrome	

Non-Diverter Tub Spouts

Brantford® Non-Diverter Tub Spout

- 1/2" Slip fit



Part #	Mfg #	Description	Finish	Price
153680	3858BN	Tub Spout Only, 7-1/4"	Brushed Nickel	

*Lifeshine® Anti-Tarnish Lifetime Finish

www.plumbsupply.com • Serving our Customers Since 1946 • www.waterconcepts.net

Tub Spouts

Faucets & Valves

Rothbury™ Non-Diverter Tub Spout

- 7-5/8" Length
- 1/2" Slip fit connections



Part #	Mfg #	Description	Finish	Price
221020	S3860	7-5/8" Non-Diverter Spout Only	Chrome	
198915	S3860BN	7-5/8" Non-Diverter Spout Only	Brushed Nickel	
222607	S3860ORB	7-5/8" Non-Diverter Spout Only	Oil Rubbed Bronze	

Moen Non-Diverter Tub Spout

- 7" Length
- 1/2" IPS



Part #	Mfg #	Description	Finish	Price
097118	3828	Tub Spout Only, 7"	Chrome	

Moen Non-Diverter Tub Spouts

- 7" Length
- 1/2" Slip fit



Part #	Mfg #	Description	Finish	Price
087586	3829	Tub Spout Only, 7"	Chrome	
088716	3829BN	Tub Spout Only, 7"	Brushed Nickel	

*Lifeshine® Anti-Tarnish Lifetime Finish

www.waterconcepts.net • Serving our Customers Since 1946 • www.plumbsupply.com

Tub Spouts

Bath Faucets

- Code Pattern Bath cock
- Goose neck spout
- Chrome plated Brass body



Part #	Mfg #	Description	Price
157575	B49-002	Tub Faucet w/ Goose neck spout	

Standard Chrome-Plated Diverter Spout



Part #	Mfg #	Size	Conn	Material	Price
052690	D01-001	1/2" FIP	Nose	Zamak	
156790	D03-001	1/2" FIP	Nose	Zamak	

Add-A-Shower Diverter Bathcock

- Code Pattern
- Anti-Syphon Diverter
- Chrome



Part #	Mfg #	Description	Price
157134	S10-074	Add a shower with Anti-syphon Diverter Bathcock	

Diverter Spout with Bottom Connection



Part #	Mfg #	Description	Price
161002	D03-011	3/4"x1/2" FIP Diverter Spout w/ 1/2 Bottom connection	

Diverter Spout with Top Connection

- Brass plated zamak



Part #	Mfg #	Description	Price
189572	D03-010	3/4"x1/2" FIP Diverter Spout w/ Top Connection	

Tub Spouts Slip Tub Spout

- 1/2" CTS
- Slip on
- Chrome plated



Part #	Mfg #	Description	Price
154999	D01-021	Slip on Tub Spout	

Diverter Tub Spouts Diverter Spouts

- 7" Diverter Spout
- 1/2" CTS Slip on
- Chrome plated



Part #	Mfg #	Description	Price
169652	D01025	7" Slip on Diverter Spout	

Peerless Faucets

Faucets & Valves

Kitchen and Bar Faucets

Kitchen Pull-Out Faucet

- 7-1/6" Reach, 8-1/16" high spout swivels 120°
- 5-3/8" From deck to aerator
- Single lever control
- WaterSense® certified: 1.8 gpm



Part #	Mfg #	Description	Handle(s)	Finish	Price
186604	P18550LF	1- or 3-Hole 8"cc, Pull-Out Spray	Lever	Chrome	
186605	P18550LF-SS	1- or 3-Hole 8"cc, Pull-Out Spray	Lever	Stainless	

Single Handle Kitchen Faucet

- 8" Reach, 7-1/2" high spout swivels 360°
- 5-1/8" From deck to aerator
- Single lever control
- WaterSense® certified: 1.8 gpm



Part #	Mfg #	Description	Handle(s)	Finish	Price
147952	P110LF	3-Hole 8"cc, Less Side Spray	Lever	Chrome	
155203	P115LF	4-Hole 8"cc, With Side Spray	Lever	Chrome	

Single Handle Kitchen Faucet

- 8" Reach, 7-1/2" high spout swivels 360°
- 5-1/8" From deck to aerator
- Single lever control
- WaterSense® certified: 1.8 gpm



Part #	Mfg #	Description	Handle(s)	Finish	Price
225947	P114LF	3-Hole, 8"cc, With Side Spray	Lever	Chrome	

Two-Handle Kitchen Faucet

- 8-1/16" Reach, 6-1/16" high spout
- 4-13/16" From deck to aerator
- Single lever control
- Lead Free
- 1/2" - 14 NPSM threaded male inlet shanks
- WaterSense® certified: 1.8 gpm



Part #	Mfg #	Description	Handle(s)	Finish	Price
188080	P226LF	4-Hole, 8"cc With Side Spray	Blade Lever	Chrome	
174015	P221LF	3-Hole, 8"cc Less Side Spray	Blade Lever	Chrome	

* Brilliance® Anti-Tarnish Lifetime Finishes

www.waterconcepts.net • Serving our Customers Since 1946 • www.plumbsupply.com

Peerless Faucets

Two-Handle Kitchen Faucet

- 9" Spout reach, 12-1/2" high arc spout
- 8-5/8" From deck to aerator
- 1/2" - 14 NPSM threaded male inlet adapters
- WaterSense® Certified: 1.8 gpm



Part #	Mfg #	Description	Handle(s)	Finish	Price
160343	P299568LF	3-Hole 8"cc, Less Side Spray	Blade Lever	Chrome	

Two-Handle Bar/Prep Faucet

- 5-1/32" Spout reach
- 7-7/8" From deck to aerator
- 1/2"-14 NPSM threaded male inlet shanks
- WaterSense® Certified: 1.8 gpm @ 60 psi



Part #	Mfg #	Description	Handle(s)	Finish	Price
189928	P288LF	3-Hole 4"cc, Less Side Spray	Blade Lever	Chrome	

Lavatory Faucets

Single Handle Lavatory Faucet

- 3-29/32" Spout reach
- Single handle lavatory
- 1/2" - 14 NPSM threaded male inlet adapters
- Flow rate: 1.5 gpm @ 60 psi



Part #	Mfg #	Description	Handle(s)	Finish	Price
155204	P136LF	3-Hole 4"cc, Plastic Pop-Up	Lever	Chrome	
155205	P136LF-M	3-Hole 4"cc, Metal Pop-Up	Lever	Chrome	
186607	P136LF-BN-M	3-Hole 4"cc, Metal Pop-Up	Lever	Brushed Nickel	

Single Handle Lavatory Faucet

- 3-29/32" Spout reach
- 1-23/32" From deck to aerator
- 1/2"-14 NPSM threaded male inlet adapters
- WaterSense® certified: 1.2 gpm



Part #	Mfg #	Description	Handle(s)	Finish	Price
189925	P138LF-M	3-Hole 4"cc, Metal Grid Drain	Lever	Chrome	

* Brilliance® Anti-Tarnish Lifetime Finishes

www.plumbsupply.com • Serving our Customers Since 1946 • www.waterconcepts.net

Peerless Faucets

Faucets & Valves

Single Handle Lavatory Faucet

- 4" Spout Reach
- 1/4" O.D. copper supply lines
- Pop-Up drain
- WaterSense® Certified: 1.5 gpm



Part #	Mfg #	Description	Handle(s)	Finish	Price
221812	P188620LF-M	3-Hole 4"cc, Plastic Pop-Up	Lever	Chrome	

Two-Handle Lavatory Faucet

- 4" Spout reach
- Two-handle lavatory
- 1/2" -14 NPSM threaded male inlet adapters
- Flow rate: 1.5 gpm @ 60 psi



Part #	Mfg #	Description	Handle(s)	Finish	Price
147951	P246LF-M	3-Hole 4"cc, Metal Pop-Up	Lever	Chrome	

Bathroom Faucets

Shower Trim

- Single function operation
- Touch-Clean showerhead
- Flow rate: 1.5 gpm

Requires R10000 Rough-In Valve



Part #	Mfg #	Description	Handle(s)	Finish	Price
171148	PTT188763	Shower Trim Only	Lever	Chrome	
186603	PTT188763-BN	Shower Trim Only	Lever	Brushed Nickel	

Tub & Shower Trim

- Single function operation
- Touch-Clean showerhead
- Flow rate: 1.5 gpm



Part #	Mfg #	Description	Handle(s)	Finish	Price
171147	PTT188773	Tub & Shower Trim Only	Lever	Chrome	
186606	PTT188773-BN	Tub & Shower Trim Only	Lever	Brushed Nickel	

* Brilliance® Anti-Tarnish Lifetime Finishes

www.waterconcepts.net • Serving our Customers Since 1946 • www.plumbsupply.com

Peerless Faucets

Showerheads

A+ Type Showerhead

- 1.5 GPM



Faucets & Valves

Part #	Item #	Description	Price
226344	RP75572	1.5 GPM Showerhead	

* Brilliance® Anti-Tarnish Lifetime Finishes

www.plumbsupply.com • Serving our Customers Since 1946 • www.waterconcepts.net

Wall Hydrants

Wall Faucets

Model 14 Freezeless Wall Faucet

- 3/4" Male hose thread nozzle
- Permanent stainless steel seat will not wire draw
- EPDM Packing to prevent leaking
- Full circle threads on valve body and retainer
- No lead solder
- Standard "O" size seat washer
- Powder-coated, die cast aluminum handle standard
- Adjustable polycarbonate flange
- Maximum pressure: 125 psi
- Maximum temperature: 120°F



1/2" MIP x 1/2" Female Swt Inlet

Part #	Mfg #	Thickness	Handle	Price
011670	14CP-6-MH	6"	Metal	
011674	14CP-8-MH	8"	Metal	
011665	14CP-10-MH	10"	Metal	
011666	14CP-12-MH	12"	Metal	
011667	14CP-14-MH	14"	Metal	
011668	14CP-18-MH	18"	Metal	

1/4" MIP x 3/4" Female Swt Inlet

Part #	Mfg #	Thickness	Handle	Price
233236	14CP3-10-MH	10"	Metal	

Model 17 Anti-Siphon Freezeless Wall Faucet

- 3/4" Male hose thread nozzle
- Permanent stainless steel seat will not wire draw
- EPDM Packing to prevent leaking
- Full circle threads on valve body and retainer
- No lead solder
- Standard "O" size seat washer
- Power-coated, die cast aluminum handle
- Vacuum breaker cap and body and adjustable polycarbonate flange
- Maximum pressure: 125 psi
- Maximum temperature: 120°F



Copper Swt Inlet

- 1/2" K, L or M inside and 3/4" M only outside

Part #	Mfg #	Thickness	Handle	Price
011690	17C-12-MH	12"	Metal	

1/2" MIP x 1/2" Female Swt Inlet

Part #	Mfg #	Thickness	Handle	Price
059484	17CP-4-MH	4"	Metal	
011687	17CP-6-MH	6"	Metal	
011688	17CP-8-MH	8"	Metal	
011683	17CP-10-MH	10"	Metal	
011684	17CP-12-MH	12"	Metal	
011685	17CP-14-MH	14"	Metal	
011686	17CP-18-MH	18"	Metal	
052677	17CP-24-MH	24"	Metal	

1/2" Wirsbo/Uponor Inlet

Part #	Mfg #	Thickness	Handle	Price
126713	17W-8	8"	-	
126714	17W-10	10"	-	
110108	17W-12	12"	-	
126715	17W-14	14"	-	

1/2" PEX Tube Inlet

Part #	Mfg #	Thickness	Handle	Price
132238	17PX-8	8"	-	
106270	17PX-10-MH	10"	Metal	
076406	17PX-12-MH	12"	Metal	

3/4" PEX Tube Inlet

Part #	Mfg #	Thickness	Handle	Price
105970	17PX3-18-MH	18"	Metal	

Model 19 Anti-Siphon Freezeless Wall Faucet

- 3/4" Male hose thread nozzle
- Permanent stainless steel seat will not wire draw
- EPDM Packing to prevent leaking
- No lead solder
- Standard "O" size seat washer
- Power-coated, die cast aluminum handle
- Adjustable wall flange
- Maximum pressure: 125 psi
- Maximum temperature: 120°F



1/2" MIP x 1/2" Female Swt Inlet

Part #	Mfg #	Thickness	Handle	Price
084038	19CP-8	8"	-	
082384	19CP-10	10"	-	
082385	19CP-12	12"	-	
085823	19CP-14	14"	-	

Wall Hydrants

1/2" PEX Inlet

Part #	Mfg #	Thickness	Handle	Price
148048	19PX-1212	1/2"	-	

Models 22/V22 Freezeless Hot & Cold Wall Faucet

- 3/4" Male hose thread nozzle
- Permanent stainless steel seat will not wire draw
- EPDM Packing to prevent leaking
- No lead solder
- Standard "O" seat washer
- Power-coated die cast aluminum oval handle
- Maximum pressure: 125 psi
- Maximum temperature: 120°F
- Full circle threads on valve body and retainer
- Internal, resetting pressure relief valves prevents casing tube from bursting in freezing conditions even if a hose is unintentionally left on
- Built-in vent float style vacuum breaker
- Faucet drains automatically when hose is removed



1/2" MIP x 1/2" Female Copper Swt Inlet

Part #	Mfg #	Thickness	Handle	Price
041207	22CP-8-MH	8"	Metal	
041208	22CP-10-MH	10"	Metal	
041209	22CP-12-MH	12"	Metal	

3/4" MIP x 3/4" Female Copper Swt Inlet

Part #	Mfg #	Thickness	Handle	Price
149598	22CP3-12	12"	-	

1/2" MIP x 1/2" Swt Inlet Vertical-Mounted

- Rough brass
- For slab construction



Part #	Mfg #	Thickness	Handle	Price
079604	V22CP-10-MH	10"	Metal	
057074	V22CP-12-MH	12"	Metal	

3/4" MIP x 3/4" Swt Inlet Vertical-Mounted



Part #	Mfg #	Thickness	Handle	Price
149599	V22CP3-12	12"	-	

Model 25 Anti-Siphon Automatic Draining Freezeless Wall Faucet

- Brass finish
- Molded nitrile valve suitable for hot water
- No lead solder
- Hemispherical cushion
- type plunger
- Delrin Stem screw
- Brass head nut
- Metal handle
- Maximum pressure: 125 psi
- Maximum temperature: 120°F



1/2" MIP x 1/2" Female Swt Inlet

Part #	Mfg #	Thickness	Handle	Price
011699	25CP10	10"	Metal	
011700	25CP12	12"	Metal	
011701	25CP14	14"	Metal	

Model 27 Backflow Protected Automatic Draining Freezeless Wall Faucet

- Brass finish
- Molded nitrile valve suitable for hot water
- No lead solder
- Hemispherical cushion type plunger
- Delrin stem screw
- Brass head nut
- Maximum pressure: 125 psi
- Maximum temperature: 120°F



1/2" MIP x 1/2" Female Swt Inlet

Part #	Mfg #	Thickness	Handle	Price
138902	27CP-3TK	3" w/Tee Key	Metal	

Wall Hydrants

Faucets & Valves

Non-Freeze Area Wall Faucets

Model 24/B24 Anti-Siphon Commercial Wall Faucet

- Designed for mild climate areas
- EPDM Packing prevents leaking
- Adjustable brass nut with deep stem guard
- Standard "O" size washer
- Furnished with polycarbonate wheel handle and loose tee key
- Maximum pressure: 125 psi
- Maximum temperature: 120°F



1/2" FIP Inlet with Vacuum Breaker Anti-Siphon Wall Faucet

Part #	Mfg #	Size	Finish	Handle	Price
017531	24P1/2-PC-MH	1/2"	Pol Chr	Metal	
011694	24P1/2-BR	1/2"	Rgh Brs	Poly	

3/4" FIP Inlet with Vacuum Breaker Anti-Siphon Wall Faucet

Part #	Mfg #	Size	Finish	Handle	Price
011697	24P3/4-MH	3/4"	Chrome	Metal	
011696	24P3/4-PCMH	3/4"	Pol Chr	Metal	
011695	24P3/4-BRMH	3/4"	Rgh Brs	Metal	

1/2" Copper Tube x 1/2" MIP Inlet

Part #	Mfg #	Size	Finish	Handle	Price
022638	24CP-MH	1/2"	Chrome	Metal	

Wall Hydrants

Model 67/B67 Backflow Protected Freezeless Wall Hydrant

- Permanent type brass valve body with hemispherical seating surface
- 1-Piece valve plunger accurately controls both flow and drainage with a minimum number of turns and without need for adjustment
- Drain is under nozzle away from hands of operator and with a lip to divert water away from building
- Copper tube casing
- No lead solder
- Hardened stainless steel stem resists damage
- Loose key operates hydrant
- 3/8" Solid brass operating rod
- Maximum pressure: 125 psi
- Maximum temperature: 120°F



3/4" Copper Water Tube

Part #	Mfg #	Size	Finish	Handle	Price
011739	67C-8	8"	Chrome	Tee Key	
011734	67C-10	10"	Chrome	Tee Key	
011735	67C-12	12"	Chrome	Tee Key	
011736	67C-14	14"	Chrome	Tee Key	
049800	67C-16	16"	Chrome	Tee Key	
011737	67C-18	18"	Chrome	Tee Key	

Model 67 Box Assembly

Part #	Mfg #	Description	Price
089253	67BX	For Converting 65 and 67 to Box Type	

Wall Hydrants

Commercial Hydrants

Non-Freeze Wall Hydrant

- *Chrome face*
- *Integral vacuum breaker*
- *3/4" Hose connection, 3/4" x 1" male pipe connection*
- *All bronze head, seat casing and internal working parts*
- *Bronze wall casing & loose key*



Part #	Mfg #	Wall Thickness	Price
062532	HY-420-12	12"	

Wall Hydrants

Sillcocks

T-550 CPVC 1/4-Turn Frostproof Sillcock (CTS)

- *Soft Touch Handle™*
- *Brass cap*
- *Anti-siphon and automatic*
- *Integrated CPVC connection*
- *Fits 1/2" CTS CPVC tubing without adapter*



Faucets & Valves

Part #	Mfg #	Size	Price
083590	108-153	1/2" x 8"	
083591	108-154	1/2" x 10"	
083592	108-155	1/2" x 12"	
083593	108-156	1/2" x 14"	

Wall Hydrants

Valve Accessories

Flowlock Hose Bibb Lock

- *Locking device for hose thread valves*
- *Fits all 3/4" hose thread outlets*
- *Easy to install, no tools required*
- *Heavy duty non-rusting material*
- *Anodized finish*
- *Includes (2) keys*

Part #	Mfg #	Description	Price
126301	103-501RP	Carton of (8) Locks Keyed Alike	

Yard Hydrants

Faucets & Valves

Yard Hydrants

Model Y34 & Y1 Freezeless Iowa® Yard Hydrant

- Adjustable link provides easy and positive adjustment of the lever lock tension
- Rod guide eliminates side pull on rod, reduces wear on packing, packing nut and stem
- Simple cam can be set to automatically obtain the same flow each time or lock against accidental opening
- Graphite packing for lubricity and long life
- 1-Piece variable flow plunger
- 3/8" Galvanized steel operating rod
- Tapped 1/8" NPT drain hole
- 3/4" Brass male hose nozzle
- Maximum pressure: 125 psi
- Maximum temperature: 120°F



3/4" FIP Inlet

Part #	Mfg #	Bury Depth	Price
011641	Y34-3	3'	
011642	Y34-4	4'	
011643	Y34-5	5'	
011644	Y34-6	6'	

1" FIP Inlet

Part #	Mfg #	Bury Depth	Price
011639	Y1-5	5'	
011640	Y1-6	6'	

Model Y2 Automatic Draining Freezeless Yard Hydrant

- Drains when shut off even with hose attached
- Backflow protected with 50HF
- For filling field spray equipment, cleaning tools, lawn and garden, watering livestock
- Immediate water flow even in sub-zero
- Adjustable link, rod guide
- Flow finder with lock
- Graphite packing for lubricity and long life
- 1-Piece variable flow plunger
- 3/8" Galvanized steel operating rod
- 1" NPT Female inlet
- 1-1/4" Galvanized steel pipe casing
- Tapped 1/8" NPT drain hole
- 3/4" Male hose thread nozzle
- Maximum pressure: 125 psi
- Maximum temperature: 120°F



Part #	Mfg #	Bury Depth	Price
107908	Y2-5	5'	

Commercial Roof Hydrants

Model RHY2 Freezeless Roof Hydrant

- Rod guide
- Adjustable link
- 1-Piece variable flow plunger
- Automatic drain feature
- All repairs can be made from top of unit without removing hydrant
- 1" NPT Female inlet
- 1-1/4" Galvanized pipe
- Double check valve
- Maximum pressure: 125 psi
- Maximum temperature: 120°F



Part #	Mfg #	Description	Price
108847	RHY2	Hydrant with Boot and Well Seal	
128265	RHY2MS	RHY2 and RH-MS Mounting System	



Yard Hydrants

Thermaline® Sanitary Water Connectors

Thermaline Freezeless Sanitary Water Connector

- *Designed to provide water service to mobile homes*
- *Also ideal for livestock waterers*
- *Brass casting head with 3/4"NPT outlet*



Part #	Mfg #	Bury Depth	Price
011636	THERM-4	4'	
011637	THERM-5	5'	

Yard Hydrants

Frost Proof Yard Hydrants

Standard 3/4" Anyflow Frost Proof

- 3/4" NPT Inlet in heavy casting
- 3/4" Brass hose thread outlet
- Stainless steel operating rod
- Teflon packing
- Automatic self-adjusting plunger
- 1" Galvanized stand pipe and 7/16" galvanized operating rod



Part #	Mfg #	Size & Length	Price
042251	AF7504	3/4" x 4' Bury	
006542	AF7505	3/4" x 5' Bury	

Fire Safety

AQUASAFE® Looped Fire Safety Systems

Flat Plate Concealed Sprinkler

- *Threads onto stainless steel adapter fitting*
- *Includes protective cap and cup*
- *NSF & UL Approved*



Part #	Mfg #	Description	Price
122574	Q74300BR	RFC43 Bronze 165°F Sprinkler	

Recessed Sprinkler Wrench



Part #	Mfg #	Description	Price
104041	Q7500200	Wrench for Recessed Sprinklers	

**ProPEX® LF Brass Fire Sprinkler Adapter
(PEX x PEX x FNPT)**

- *Connects residential fire sprinklers to AQUAPEX tubing*
- *NSF and UL Approved for combining plumbing and fire sprinkler systems*



Part #	Mfg #	Description	Price
132198	LF7707575	Adapter Tee, 3/4"x3/4"x1/2"	
134020	LF7701010	Adapter Tee, 1"x1"x1/2"	
133923	F7000005	Fire Sprinkler Adapter Push-On Nut, 25-Pack	

Fire Safety

Aqua-PEX Fittings

Aquacenter™ Manifolds

Valved Manifold Kit

- Made of durable EP
- Suitable for hot and cold-water distribution systems
- Includes manifold, red and blue valve clips, labels, valve-turning tool and installation instructions
- Valved manifold inlets, couplings, caps, swivel adapters and assembly/mounting brackets sold separately



Part #	Mfg #	Description	Price
066211	Q2110300	3 Outlet with 1/2" ProPEX®	
066212	Q2110400	4 Outlet with 1/2" ProPEX®	

Aquacenter™ Manifold Accessories

Valved End Cap

- Assembly/mounting brackets are required and sold separately



Part #	Mfg #	Description	Price
066251	Q2121250	For Aquacenter Valved Manifolds	

Stop Coupling

- For use with Aquacenter™ valved manifolds
- Assembly/mounting brackets are required and sold separately



Part #	Mfg #	Description	Price
066250	Q2121251	For Aquacenter Valved Manifolds	

Flo-Through Coupling

- For use with Aquacenter™ valved manifolds
- Assembly/mounting brackets are required and sold separately



Part #	Mfg #	Size	Price
066248	Q2121313	1-1/2"	

ProPEX® Inlet

- For use with Aquacenter™ valved manifolds



Part #	Mfg #	Size	Price
066245	Q2120750	3/4"	
066246	Q2121000	1"	

Aquacenter™ Manifold Mounting Bracket



Part #	Mfg #	Description	Price
066253	Q2120020	Aquacenter® Mounting Bracket	

EP Manifolds

EP Branch Manifold Tee

- Features 3/4" inlet with 1/2" ProPEX® branch outlets
- Made of engineered plastic, which is proven in demanding hot-water applications



Part #	Mfg #	Size	# Outlets	Price
108571	Q2237550	3/4"	3	
068482	Q2247550	3/4"	4	
125989	Q2267550	3/4"	6	
126734	Q2277550	3/4"	7	
137844	Q2287550	3/4"	8	
075385	Q2261050	1"	6	
163870	Q2281051	1"	8	
126735	Q2101051	1"	10	
137846	Q2121051	1"	12	

EP Flow-Through Manifold

- Made of EP, suitable for hot-water applications
- 1/2" ProPEX® branch outlets
- ProPEX® tool is required
- ProPEX® Rings required, sold separately



Part #	Mfg #	Inlet x Outlet	# Outlets	Price
068480	Q2227557	3/4" x 3/4"	2	
068481	Q2237557	3/4" x 3/4"	3	
073319	Q2247557	3/4" x 3/4"	4	
108574	Q2267557	3/4" x 3/4"	6	
075386	Q2241057	1" x 3/4"	4	
095903	Q2261057	1" x 3/4"	6	

Pipe Fittings

Aqua-PEX Fittings

EP Opposing-Port Multi-Port Tee

- Designed for all residential, commercial or multi-family applications
- Ideal for a zone plumbing application
- Does not require an access panel



Q2337550



Q2347550

Part #	Mfg #	Size	# Outlets	Price
122571	Q2337550	3/4"	3	
122572	Q2347550	3/4"	4	

EP Flow-Through Opposing-Port Multi-Port Tee

- Made of EP, suitable for hot-water applications
- 3/4" ProPEX® branch outlets
- ProPEX® tool required
- ProPEX® Rings required, sold separately



Part #	Mfg #	Description	Price
151153	Q2337557	3/4" 3	

Copper Manifolds

1" Copper ProPEX® Branch Manifold with 3/4" ProPEX® Inlets

- 1" Type "L" copper manifold with 1/2" ProPEX® brass fittings brazed to manifold trunk and one 3/4" ProPEX® fitting brazed to manifold end
- ProPEX® tool required
- ProPEX® rings required, sold separately



Part #	Mfg #	Description	Price
031529	Q2827550	8 Outlets	

1" Copper ProPEX® Flow-Through Manifold

- 1" Type "L" copper manifold with 1/2" ProPEX® brass fittings brazed to manifold trunk and two 3/4" ProPEX® fittings brazed to manifold ends
- ProPEX® tool required
- ProPEX® rings sold separately



Part #	Mfg #	Description	Price
032069	Q2807557	4 Outlets	
032068	Q2817557	6 Outlets	
032070	Q2827557	8 Outlets	

ProPEX® Brass Fittings

ProPEX® Brass Coupling (PEX x PEX)

- Use to make PEX to PEX connections
- Suitable with AQUAPEX® and hePEX™ plus tubing
- ProPEX® tool and ProPEX® rings required, sold separately



Part #	Mfg #	Size	Price
043563	Q4546363	5/8" x 5/8"	

ProPEX® Brass Sweat Adapter (PEX x CU)

- Use to transition AQUAPEX® and hePEX™ plus tubing to copper pipe
- ProPEX® tool and ProPEX® rings required, sold separately



Part #	Mfg #	Size	Price
042797	Q4516375	5/8" x 3/4"	
104096	Q4512020	2" x 2"	

ProPEX® Brass Fitting Adapter (PEX x CU)

- Use to transition AQUAPEX® tubing to copper fittings
- ProPEX® tool and ProPEX® rings required (sold separately)



Part #	Mfg #	Size	Price
085652	Q4506350	5/8" x 1/2"	
042956	Q4506375	5/8" x 3/4"	
034035	Q4507550	3/4" x 1/2"	
030150	Q4507510	3/4" x 1"	

ProPEX® Brass Male Threaded Adapter (PEX x MIP)

- Use to connect Uponor™ AQUAPEX® and hePEX™ plus tubing to male NPT threads
- ProPEX® tool and ProPEX® rings required (sold separately)



Part #	Mfg #	Size	Price
041164	Q4527510	3/4" x 1"	

ProPEX® Brass Female Threaded Adapter (PEX x FIP)

- Use to connect Uponor™ AQUAPEX® and hePEX™ plus tubing to female NPT threads
- ProPEX® tool and ProPEX® rings required (sold separately)



Part #	Mfg #	Size	Price
041167	Q4577510	3/4" x 1"	

Pipe Fittings

Aqua-PEX Fittings

ProPEX® Brass Swivel Faucet Adapter (PEX x NPSM)

- Use to connect 3/8" or 1/2" AQUAPEX® tubing to male NPSM faucet connections
- ProPEX® tool and ProPEX® rings required (sold separately)



Part #	Mfg #	Size	Price
053641	Q4655050	1/2" x 1/2"	

ProPEX® 90° Brass Elbow (PEX x PEX)

- ProPEX® tool and ProPEX® rings required (sold separately)



Part #	Mfg #	Size	Price
107571	Q4710625	5/8" x 5/8"	
024836	Q4711000	1" x 1"	
104098	Q4712000	2" x 2"	

ProPEX® Brass 90° Elbow (PEX x MIP)

- Makes connections for 1/2" AQUAPEX to 1/2" MIP
- ProPEX® tool and ProPEX® rings required (sold separately)



Part #	Mfg #	Size	Price
143517	Q4743850	1/2" x 3/8" MIP	

ProPEX® Brass Reducing Tee (PEX x PEX x PEX)

- ProPEX® tool and ProPEX® rings required (sold separately)



Part #	Mfg #	Size	Price
034228	Q4705575	1/2" x 1/2" x 3/4"	
022615	Q4707557	3/4" x 1/2" x 3/4"	
096228	Q4707710	3/4" x 3/4" x 1"	
024839	Q4701775	1" x 3/4" x 3/4"	
080819	Q4701751	1" x 3/4" x 1"	
111045	Q4702215	2" x 2" x 1-1/2"	

AQUAPEX® Riser

- 3/8" OD
- Must be installed with delrin rings (included)



Part #	Mfg #	Size	Type	Price
044629	F1072512	3/8" OD x 12"	Lavatory	
042345	F1072520	3/8" OD x 20"	Lavatory	
042346	F1072530	3/8" OD x 30"	Lavatory	

ProPEX® Brass Fittings (Continued) AQUAPEX® Riser

Part #	Mfg #	Size	Type	Price
109680	F1072536	3/8" OD x 36"	Lavatory	
035459	F1082512	3/8" OD x 12"	Closet	

ProPEX® LF Water Heater Adapter (PEX x FIP)

- Lead free



Part #	Mfg #	Description	Price
077934	LF2957575	3/4" x 3/4" x 18"	

ProPEX® Copper Tub Elbow (1/2" PEX x 1/2" CU)

- Provides a 90° transition from tub and shower valve to AQUAPEX®
- ProPEX® tool and ProPEX® rings required (sold separately)



Part #	Mfg #	Size	Price
035474	Q2875050	3" x 6"	

ProPEX® Copper Stub Elbow (PEX x CU)

- Provides a 90° transition from AQUAPEX® to copper
- ProPEX® tool and ProPEX® rings required (sold separately)



Part #	Mfg #	Size	Leg Lengths	Price
048180	Q2897575	3/4" x 3/4"	4" x 8"	

ProPEX® EP Fittings

ProPEX® EP Coupling (PEX x PEX)

- Engineer plastic coupling makes PEX to PEX connections for hePEX plus and AQUAPEX tubing
- ProPEX® tool and ProPEX® rings required (sold separately)



Part #	Mfg #	Size	Price
033959	Q4773838	3/8" x 3/8"	
033958	Q4775050	1/2" x 1/2"	
115454	Q4775075	1/2" x 3/4"	
123915	Q4776363	5/8" x 5/8"	
033957	Q4777575	3/4" x 3/4"	
114394	Q4777510	3/4" x 1"	

Pipe Fittings

Aqua-PEX Fittings

ProPEX® EP Fittings (Continued)

ProPEX® EP Coupling (PEX x PEX)

Part #	Mfg #	Size	Price
033956	Q4771010	1" x 1"	
147256	Q4771307	1-1/4" x 3/4"	
137672	Q4771310	1-1/4" x 1"	
136963	Q4771313	1-1/4" x 1-1/4"	
136983	Q4771507	1-1/2" x 3/4"	
130444	Q4771510	1-1/2" x 1"	
134221	Q4771513	1-1/2" x 1-1/4"	
134219	Q4771515	1-1/2" x 1-1/2"	
130691	Q4772015	2" x 1-1/2"	
118971	Q4772020	2" x 2"	
185089	Q4773030	3" x 3"	

ProPEX® EP Elbow (PEX x PEX)

- ProPEX® tool and ProPEX® rings required (sold separately)



Part #	Mfg #	Size	Price
033960	Q4760500	1/2" x 1/2"	
033961	Q4760750	3/4" x 3/4"	
033962	Q4761000	1" x 1"	
110318	Q4761250	1-1/4" x 1-1/4"	
099642	Q4761500	1-1/2" x 1-1/2"	
118977	Q4762000	2" x 2"	
185092	Q4763000	3" x 3"	

ProPEX® EP 45° Elbow (PEX x PEX)

- Engineer plastic elbow makes PEX to PEX connections for Uponor PEX tubing supply in return mains
- ProPEX tool require, rings sold separately



Part #	Mfg #	Description	Price
161798	Q4761515	1-1/2" x 1-1/2"	
163626	Q4762020	2" x 2"	
185289	Q4763030	3" x 3"	

ProPEX® EP Tee (PEX x PEX x PEX)

- ProPEX® tool and ProPEX® rings required (sold separately)



Part #	Mfg #	Size	Price
033991	Q4755050	1/2" x 1/2" x 1/2"	
034000	Q4757575	3/4" x 3/4" x 3/4"	
033999	Q4751010	1" x 1" x 1"	
113322	Q4751313	1-1/4" x 1-1/4" x 1-1/4"	
108731	Q4751515	1-1/2" x 1-1/2" x 1-1/2"	
118972	Q4752000	2" x 2" x 2"	

ProPEX® EP Reducing Tee (PEX x PEX x PEX)

- ProPEX® tool and ProPEX® rings required (sold separately)



Part #	Mfg #	Size	Price
108098	Q4755575	1/2" x 1/2" x 3/4"	
033997	Q4757555	3/4" x 1/2" x 1/2"	
033996	Q4757557	3/4" x 1/2" x 3/4"	
033998	Q4757550	3/4" x 3/4" x 1/2"	
114590	Q4757710	3/4" x 3/4" x 1"	
033994	Q4751775	1" x 3/4" x 3/4"	
033995	Q4751751	1" x 3/4" x 1"	
033993	Q4751150	1" x 1" x 1/2"	
033992	Q4751175	1" x 1" x 3/4"	
108736	Q4751317	1-1/4" x 1" x 3/4"	
110317	Q4751311	1-1/4" x 1" x 1"	
108737	Q4751337	1-1/4" x 1-1/4" x 3/4"	
108735	Q4751331	1-1/4" x 1-1/4" x 1"	
101210	Q4751511	1-1/2" x 1" x 1"	
161795	Q4751505	1-1/2" x 1" x 1-1/2"	
150436	Q4751537	1-1/2" x 1-1/4" x 3/4"	
132742	Q4751533	1-1/2"x1-1/4"x1-1/4"	
161796	Q4751550	1-1/2" x 1-1/2" x 1/2"	
136984	Q4751557	1-1/2" x 1-1/2" x 3/4"	
087320	Q4751551	1-1/2" x 1-1/2" x 1"	
108729	Q4751553	1-1/2" x 1-1/2" x 1-1/4"	
111038	Q4752575	2" x 1-1/2" x 3/4"	
118973	Q4752051	2" x 1-1/2" x 1"	
111040	Q4752053	2" x 1-1/2" x 1-1/4"	
162295	Q4752152	2" x 1-1/2" x 2"	
161797	Q4752250	2" x 2" x 1/2"	
118974	Q4752275	2" x 2" x 3/4"	

Pipe Fittings

Aqua-PEX Fittings

ProPEX® EP Fittings (Continued)

ProPEX® EP Reducing Tee (PEX x PEX x PEX)

Part #	Mfg #	Size	Price
118975	Q4752210	2" x 2" x 1"	
111044	Q4752213	2" x 2" x 1-1/4"	
118976	Q4752215	2" x 2" x 1-1/2"	
185287	Q4753220	3" x 2" x 2"	
185288	Q4753310	3" x 3" x 1"	
185106	Q4753315	3" x 3" x 1-1/2"	

ProPEX® EP Plug (PEX)

- For pressure testing and permanent plug installations
- ProPEX® tool and ProPEX® rings required (sold separately)



Part #	Mfg #	Size	Price
027963	Q4350500	1/2"	
034229	Q4350750	3/4"	
034230	Q4351000	1"	
114947	Q4351250	1-1/4"	
114948	Q4351500	1-1/2"	
154868	Q4352000	2"	

ProPEX® EP Swivel Faucet Adapter

- Use to connect 1/2" AQUAPEX® tubing to male NPSM faucet connections
- ProPEX® tool and ProPEX® rings required (sold separately)



Part #	Mfg #	Size	Price
044746	Q4360500	1/2"	

ProPEX® EP Stop Valve



Part #	Mfg #	Description	Price
117796	Q4905038	Angle Stop Valve for 1/2" PEX	
118897	Q4935038	Straight Stop Valve for 1/2" PEX	

ProPEX® Lead-Free Branch Manifolds

ProPEX® LF 1" Copper Valved Manifold with ProPEX® Ball Valves

- Type "L" copper features 1/2" ProPEX® outlets
- A soldered valve connection allows for simple and easy isolation of individual loops
- Sections can sweat together to extend the number of outlets using a standard 1" copper coupling
- Do not exceed accepted flow rates for 1" nominal copper
- Both 1" ends are copper pipe size and require a copper end cap, coupling or transition fitting to make the proper system connection
- ProPEX® tool and ProPEX® rings required (sold separately)



Part #	Mfg #	Outlet Size	No of Outlets	Price
049243	LF2500400	1/2"	4	
048401	LF2500600	1/2"	6	
048403	LF2500800	1/2"	8	
048404	LF2501000	1/2"	10	
048405	LF2501200	1/2"	12	

ProPEX® LF 1" Copper Branch Manifold (PEX)

- Type "L" copper features 1/2" ProPEX® outlets
- Sections can sweat together to extend the number of outlets using a standard 1" copper coupling
- Do not exceed accepted flow rates for 1" nominal copper
- ProPEX® tool and ProPEX® rings required (sold separately)



Part #	Mfg #	Outlet Size	No of Outlets	Price
025310	LF2801050	1/2"	4	
025311	LF2811050	1/2"	6	
025312	LF2821050	1/2"	8	
027981	LF2831050	1/2"	10	
027982	LF2841050	1/2"	12	

Aqua-PEX Fittings

ProPEX® Lead-Free Brass Fittings

ProPEX® LF Brass 90° Elbow (PEX x PEX)



Part #	Mfg #	Size	Price
022601	LF4710750	3/4" x 3/4"	

ProPEX® LF Brass 90° Elbow (PEX x MIP)



Part #	Mfg #	Size	Price
062421	LF4125050	1/2" x 1/2" MIP	

ProPEX® LF Drop Ear Brass Elbow (PEX x FIP)



Part #	Mfg #	Size	Price
084295	LF4235038	1/2" x 3/8"	
127137	LF4235050	1/2" x 1/2"	
147535	LF4237575	3/4" x 3/4"	
159479	LF4231010	1" x 1"	

ProPEX® LF Brass Coupling (PEX x PEX)



Part #	Mfg #	Size	Price
024837	LF4541010	1" x 1"	
022611	LF4545050	1/2" x 1/2"	
026475	LF4545075	1/2" x 3/4"	
022612	LF4547575	3/4" x 3/4"	
055085	LF4547510	1" x 3/4"	

ProPEX® LF Brass Tee (PEX)



Part #	Mfg #	Size	Price
029336	LF4701010	1" x 1" x 1"	
022613	LF4705050	1/2" x 1/2" x 1/2"	
022035	LF4707575	3/4" x 3/4" x 3/4"	

ProPEX® LF Brass Reducing Tee (PEX)



Part #	Mfg #	Size	Price
043682	LF4701150	1" x 1" x 1/2"	
024838	LF4701175	1" x 1" x 3/4"	
022616	LF4707550	3/4" x 3/4" x 1/2"	

ProPEX® LF Brass Female Adapter (PEX x NPT)



Part #	Mfg #	Size	Price
022606	LF4575050	1/2" x 1/2"	
034032	LF4575075	1/2" x 3/4"	
022607	LF4577575	3/4" x 3/4"	
029337	LF4571010	1" x 1"	
111037	LF4572020	2" x 2"	

ProPEX® LF Brass Male Adapter (PEX x NPT)



Part #	Mfg #	Size	Price
022605	LF4525050	1/2" x 1/2"	
022037	LF4525075	1/2" x 3/4"	
022040	LF4527575	3/4" x 3/4"	
041166	LF4521075	1" x 3/4"	
029338	LF4521010	1" x 1"	
084140	LF4521313	1-1/4" x 1-1/4"	
070887	LF4521515	1-1/2" x 1-1/2"	
111034	LF4511020	2" x 2"	
185292	LF4523030	3" x 3"	

Pipe Fittings

Aqua-PEX Fittings

ProPEX® LF Brass Sweat Adapter (PEX x CU)



Part #	Mfg #	Size	Price
022603	LF4515050	1/2" x 1/2"	
022604	LF4515075	1/2" x 3/4"	
034031	LF4517550	3/4" x 1/2"	
022036	LF4517575	3/4" x 3/4"	
025313	LF4517510	3/4" x 1"	
024840	LF4511010	1" x 1"	
079466	LF4511313	1-1/4" x 1-1/4"	
112506	LF4511515	1-1/2" x 1-1/2"	
185291	LF4513030	3" x 3"	

ProPEX® LF Brass Fitting Adapter (PEX x CU)



Part #	Mfg #	Size	Price
022608	LF4505050	1/2" x 1/2"	
034036	LF4505075	1/2" x 3/4"	
022609	LF4507575	3/4" x 3/4"	
160607	LF4507510	3/4" x 1"	
034034	LF4501010	1" x 1"	
152504	LF4501515	1-1/2" x 1-1/2"	
111032	LF4502020	2" x 2"	

ProPEX® LF Brass Stub Elbow (PEX x CU)



Part #	Mfg #	Conn	Leg Size(s)	Price
024514	LF2865050	1/2"	3-1/2" x 8"	
026616	LF2895050	1/2"	8" x 13"	

ProPEX® LF Copper Tub Elbow (PEX x CU)



Part #	Mfg #	Size	Price
022599	LF2885050	3" x 4"	

ProPEX® LF Copper Straight Stub (PEX x CU)



Part #	Mfg #	Size	Price
038781	LF2935050	1/2" x 1/2" 8"	
032616	LF2945050	1/2" x 1/2" 15"	
185290	LF2963030	3" x 3"	

ProPEX® Stainless Steel Fittings

ProPEX® Stainless Steel Male Threaded Adapter (PEX x NPT)



- 316 SS
- ProPEX® tool is required, rings sold separately

Part #	Mfg #	Description	Price
132157	Q8525050	1/2" x 1/2"	
131351	Q8521010	1" x 1"	

Compression Insert



- AQUAPEX® stainless steel inserts
- Must be used with compression straight and angle stops
- Do not substitute similar inserts

Part #	Mfg #	Size	Price
031702	F5400250	1/4"	
024086	F5400500	1/2"	

ProPEX® Outlet Boxes and Accessories

ProPEX® Washing Machine Outlet Box



- Includes (2) 1/2" lead-free color-coded hot and cold valves
- Box can be mounted with the valves either on the top or bottom
- Snap-on cover plate accommodates up to 1" drywall

Part #	Mfg #	Description	Price
117268	LF5930500	1/2" Lead-Free Brass Valve	

Ice Maker Box with Support Brackets (LF Brass)



- High-impact polystyrene box, frame and support brackets
- Snap-in frame includes a 1/2" lead-free brass valve with 1/4" OD compression connection

Part #	Mfg #	Description	Price
116666	LF5955025	1/2" Lead-Free Brass Valve	

Pipe Fittings

Aqua-PEX Fittings

ProPEX® LF In-Line Ice Maker Tee & Valve

- In-line tee with valve, ProPEX® tool and ProPEX® rings required (sold separately)



Part #	Mfg #	Size	Price
041170	LF4455050	1/2" PEX x 1/2" PEX x 1/4" O.D.	
164490	LF4785025	1/2" PEX x 1/4" O.D.	

ProPEX® Brass Plugs (PEX)

- Terminates the end of PEX tubing
- Installed for temporary or permanent usage
- ProPEX® tool and ProPEX® rings required (sold separately)



Part #	Mfg #	Description	Price
045202	Q4536363	5/8"	
022618	Q4537575	3/4"	

ProPEX® Rings

- A ProPEX® ring is required to make a proper ProPEX® connection
- Red and blue print on the rings distinguishes hot and cold lines



Part #	Mfg #	Description	Price
025842	4690512	1/2" Blue w/Stop	
042798	Q4680625	5/8" Black	
123524	Q4690756	3/4" Blue w/Stop	
139817	Q4691000	1" Black w/Stop	
112440	Q4691250	1-1/4" Black w/Stop	
060530	Q4691500	1-1/2" Black w/Stop	
111047	Q4692000	2" Black w/Stop	
185107	Q4693000	3" Black w/Stop	

Installation Fittings & Tools

Finish Sleeve - Chrome (PEX)

- Slides over 3/8" and 1/2" AQUAPEX® connected to point-of-use valve
- Provides protection and improves appearance



Part #	Mfg #	Size	Price
031783	F5600500	1/2"	

Plastic Bend Support

- Glass reinforced nylon
- Provides rigid 90° bend and sleeve for Uponor™ ProPEX™plus and AQUAPEX® tubing



Part #	Mfg #	Size	Price
036591	A5250500	1/2"	
041393	A5150750	3/4"	

Plastic Drop Ear Bend Support

- Glass reinforced nylon
- Provides rigid 90° bend and connection free stub-out from a stud wall or floor



Part #	Mfg #	Size	Price
038158	F5200500	1/2"	

Metal Straight-Thru Support

- Zinc-plated
- Provides rigid straight-thru support for 1/2" AQUAPEX® tubing as it exits a floor



Part #	Mfg #	Size	Price
031525	F5140500	1/2"	

Metal Drop Ear Bend Support

- Zinc-plated
- Provides rigid 90° bend and connection free stub-out for 3/8" or 1/2" PEX tubing products



Part #	Mfg #	Size	Price
022598	F5120500	1/2"	

PEX Wall Support Bracket

- Provides rigid, straight-through support for AQUAPEX® tubing and copper stubs



Part #	Mfg #	Description	Price
116226	A5750500	1/2" & 3/4" PEX Support Bracket	

Pipe Fittings

Aqua-PEX Fittings

PEX Rail - Plastic (PEX)

- Use to secure Uponor™ PEX tubing products to concrete floors and wood subfloors
- Tube spacing on rail is every 2"
- Suitable floor fastening hardware required (sold separately)
- Do not use PEX rails in joist heating applications



Part #	Mfg #	Size	Price
030779	A5700500	1/2" x 6-1/2'	
019017	A5700625	5/8" x 61-1/2'	

ProPEX® 201 Corded Expander Tool Kit

- 110V, Electro-hydraulic
- 2" PEX Installations
- H-Series expander heads
- Includes 2" head



Part #	Mfg #	Description	Price
121332	A6272000	Includes 2" Expander Head	

ProPEX® Hand (Manual) Expander Tool

- Tool-hardened heads, providing a more consistent and even expansion of the tubing
- Includes:
 - 1/2", 3/4" and 1" Heads
 - Tool lubricant
 - Sturdy carrying case
- Note: The 3/8" and 5/8" expander heads used in Uponor™ Radiant Floor Heating systems are sold separately



Part #	Mfg #	Description	Price
022623	Q6295075	Includes 1/2", 3/4" & 1" Heads	

Replacement Head for Hand Expander Tool and ProPEX 150 Expander Tool

- The standard expander heads are used on ProPEX 150 and hand expander tools



Part #	Mfg #	Description	Price
044125	Q6310500	1/2" ProPEX Expander Head	

Graphite Grease

- ProPEX® Expander tool spare part
- Note: wipe cone clean prior to applying grease and spread only small amount over cone head



Part #	Mfg #	Description	Price
038157	Q5590028	Graphite Grease	

Aqua-Pex Stop Valves

ProPEX® Stop Valves

ProPEX® LF Brass Stop Valve - Full Port (PEX x OD)

- Used for point-of-use shut-off at the fixture
- Connect 1/2" Uponor AQUAPEX® tubing to 3/8" OD risers



Part #	Mfg #	Size	Type	Price
029671	LF4855038	1/2" x 3/8"	Angle	
029670	LF4865038	1/2" x 3/8"	Straight	

ProPEX® LF Brass Compression Stop Valve (PEX x OD)

Part #	Mfg #	Size	Type	Price
022602	LF4410500	1/2" x 3/8"	Angle	

ProPEX® Full Port Stop Valve (PEX x Tube OD)

- Chrome-plated
- Standard point-of-use valve for shut-off at fixture
- Connects 1/2" AQUAPEX® (5/8" OD) to 3/8" OD riser
- 1/4 Turn shut-off



Part #	Mfg #	Size	Type	Price
076187	Q4885038	1/2" x 3/8"	Straight	

Aqua-PEX Fittings

Floor Sleeves

Straight Floor Sleeve

- Rigid support for flexible 1/2" CTS tubing
- Use to support tube up through sub-floor going directly to the fixture

Part #	Mfg #	Floor Support	Price
119235	550-FP2	1/2" CTS	

PEX Brackets & Hangers

Sidewinder™ Metal Bend Supports

- Forms tight 90° bends in flexible CTS tube without kinking
- Nail plate models have unique open corner allowing tube to be inserted after bracket is installed and tubing end has been plugged
- Pre-drilled hole for 3/8" rebar —Allows installer to use a ground stake for flexible CTS tube
- Mount several Sidewinders™ to PowerBar™ to organize pipes underground before the pour



Part #	Mfg #	Flexible CTS/PEX Tube Size	Price
076211	550-M2	1/2"	
119234	550-MP2	1/2" With Nail Plate	
183489	550-MP3	3/4" With Nail Plate	
076212	550-M3	3/4"	

PEX Simple Bend Support

- 90° Bend radius
- 40% Glass-filled nylon



Part #	Mfg #	Size	Price
183490	550-PB2	1/2"	

PowerPEX® Systems—ASTM F1807

PowerPEX® BranchMaster™ F1807 PEX Manifold

- 1/2" F1807 PEX branches
- 3/4" F1807 PEX x spin closed trunk
- 1" Type L copper trunk
- Branches are 2" on-center
- Great as a secondary manifold
- No lead



Part #	Mfg #	Size	Quantity	Price
183779	672X0390PK	1/2"	3	
066140	672X0490	1/2"	4	

PowerPEX® Systems—ASTM F1807 (Continued)

PowerPEX® BranchMaster™ F1807 PEX Manifold

Part #	Mfg #	Size	Quantity	Price
183781	672X0490PK	1/2"	4	
128513	672X0690	1/2"	6	
183783	672X0690PK	1/2"	6	
183786	672X0790	1/2"	7	
128514	672X0890	1/2"	8	
183787	672X0990	1/2"	9	
147130	672X1090	1/2"	10	
147139	672X1290	1/2"	12	

PowerPEX® BranchMaster™ F1807 Manifold

- 1/2" F1807 PEX branches
- 3/4" Male sweat x spin closed trunk
- 1" Type L copper trunk
- Branches are 2" on-center
- 3/4" Male sweat connection provides flexibility
- No lead



Part #	Mfg #	Size	Quantity	Price
068035	672X0430	1/2"	4	
076700	672X0630	1/2"	6	
076701	672X0830	1/2"	8	
076702	672X1230	1/2"	12	

PowerPEX® BranchMaster™ Female Swt Manifold

- 3/4" Female sweat branches
- 1-1/4" Male sweat x 1-1/4" male sweat trunk
- 1-1/4" Type L copper trunk
- Branches are 4" on-center
- Press-fitting compatible



Part #	Mfg #	Size	Quantity	Price
166528	67745L-08334	3/4"	8	

PowerPEX® BranchMaster™ Male Sweat Manifold

- 3/4" Male sweat branches
- 1-1/2" Male sweat x 1-1/2" male sweat trunk
- 1-1/2" Type L copper trunk
- Branches are 3" on-center
- Press-fitting compatible



Part #	Mfg #	Size	Quantity	Price
186421	6796L-12333	3/4"	12	

Pipe Fittings

Aqua-PEX Fittings

PowerPEX® BranchMaster™ PEX Valved Manifold

- 1/2" F1807 PEX branches
- 1" Male sweat x 1" female sweat trunk
- 1" Type L copper trunk
- Branches are 2" on-center (unless noted)
- Brazed branches
- No lead

Part #	Mfg #	Size	Quantity	Price
174287	672XV0442	1/2"	4	

PowerPex® Systems—ASTM F1960

PowerPex® No Lead Brass Ball Valve

- Chrome-plated ball, blowout-proof stem



Part #	Mfg #	Size	Price
225349	648WG2FP	1/2"	
225340	648WG3FP	3/4"	
225339	648WG6FP	1-1/2"	
225338	648WG7FP	2"	

PowerPEX® Lead Free Brass Elbow

- Full flow—no restriction
- One-piece no lead brass



Part #	Mfg #	F1960 PEX x F1960 PEX	Price
160778	642WG2	1/2" x 1/2"	

PowerPEX® Lead Free Brass Straight Adapters

- FIP x PEX
- One-piece no lead brass



Part #	Mfg #	FIP x F1960 PEX	Price
187548	647WG2	1/2" x 1/2"	
187547	647WG3	3/4" x 3/4"	
183763	647WG4	1" x 1"	

PowerPEX® BranchMaster™ F1960 PEX Manifolds (3/4" MSwt x Spin Closed Trunks)

- 1/2" F1960 PEX ball valve branches
- 1" Type L copper trunk
- Branches are 2" on-center

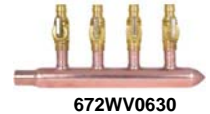

Part #	Mfg #	Size	Quantity	Price
178244	672WV0430	1/2"	4	
178245	672WV0630	1/2"	6	
178246	672WV0830	1/2"	8	

PowerPEX® BranchMaster™ F1960 PEX Manifolds (1" MSwt x 1" MSwt Trunks)

- 1/2" F1960 ball valve branches
- Branches are 1-1/2" on-center
- 1" Type L copper trunk

Part #	Mfg #	Size	Quantity	Price
222275	672WV0644	1/2"	6	
181336	672WV1244	1/2"	12	

Aqua-PEX Fittings

ProPEX® Expander Heads



49-16-2404

49-16-2408

Part #	Mfg #	Size	For:	Price
135839	49-16-2404	1/2"	Most Uponor	
153044	49-16-2405	5/8"	Most Uponor	
135841	49-16-2408	1"	Most Uponor	

Black Steel Fittings

Threaded Black Malleable Iron Fittings

150# Black MI Hex Bushing



Part #	Size	Price
013564	1/4" x 1/8"	
015101	3/8" x 1/8"	
015079	3/8" x 1/4"	
013282	1/2" x 1/8"	
013263	1/2" x 1/4"	
013325	1/2" x 3/8"	
014853	3/4" x 1/8"	
014844	3/4" x 1/4"	
014904	3/4" x 3/8"	
014800	3/4" x 1/2"	
013014	1" x 1/8"	
012749	1" x 1/4"	
013444	1" x 3/8"	
012368	1" x 1/2"	
013407	1" x 3/4"	
012951	1-1/4" x 1/4"	
012990	1-1/4" x 3/8"	
012932	1-1/4" x 1/2"	
012969	1-1/4" x 3/4"	
012881	1-1/4" x 1"	
012656	1-1/2" x 1/2"	
012699	1-1/2" x 3/4"	
012559	1-1/2" x 1"	
012610	1-1/2" x 1-1/4"	
014055	2" x 1/2"	
014247	2" x 3/4"	
013957	2" x 1"	
014035	2" x 1-1/4"	
013981	2" x 1-1/2"	
014180	2-1/2" x 3/4"	
014130	2-1/2" x 1-1/2"	
014147	2-1/2" x 2"	
014516	3" x 2"	
014554	3" x 2-1/2"	
015383	4" x 2"	
015414	4" x 2-1/2"	
015426	4" x 3"	

150# Black MI Cap



Part #	Size	Price
013649	1/8"	
013455	1/4"	
014966	3/8"	
013026	1/2"	
014605	3/4"	
012168	1"	
012750	1-1/4"	
012369	1-1/2"	
013744	2"	
013982	2-1/2"	
014307	3"	
015193	4"	

150# Black MI Cross



Part #	Size	Price
013028	1/2"	
014607	3/4"	
012170	1"	
012753	1-1/4"	
013746	2"	

150# Black MI Half Coupling

Part #	Size	Price
049364	1/2"	
049365	3/4"	
049367	1"	
049374	1-1/4"	
049379	1-1/2"	
049381	2"	

Black Steel Merchant Coupling



Part #	Size	Price
013650	1/8"	
013456	1/4"	
014968	3/8"	
013027	1/2"	
014606	3/4"	
012169	1"	
012751	1-1/4"	
012370	1-1/2"	
013745	2"	
014056	2-1/2"	
014308	3"	
015194	6"	

150# Black MI 45° Elbow



Part #	Size	Price
013662	1/8"	
013476	1/4"	
014988	3/8"	
013058	1/2"	
014637	3/4"	
012196	1"	
012776	1-1/4"	
012395	1-1/2"	
013766	2"	
014315	3"	

150# Black MI 45° Street Elbow



Part #	Size	Price
013657	1/8"	
013469	1/4"	
014982	3/8"	
013048	1/2"	

Pipe Fittings

Black Steel Fittings

Threaded Black Malleable Iron Fittings (Continued)

150# Black MI 45° Street Elbow

Part #	Size	Price
014626	3/4"	
012185	1"	
012766	1-1/4"	
012385	1-1/2"	
013757	2"	

150# Black MI 90° Elbow



Part #	Size	Price
013663	1/8"	
013477	1/4"	
014989	3/8"	
013059	1/2"	
014638	3/4"	
012197	1"	
012777	1-1/4"	
012396	1-1/2"	
013767	2"	
014066	2-1/2"	
014316	3"	
015201	4"	

150# Black MI 90° Street Elbow



Part #	Size	Price
013658	1/8"	
013470	1/4"	
014983	3/8"	
013049	1/2"	
014627	3/4"	
012186	1"	
012768	1-1/4"	
012386	1-1/2"	
013758	2"	

150# Black MI 90° Reducing Elbow



Part #	Size	Price
013266	1/2" x 1/4"	
013330	1/2" x 3/8"	
014810	3/4" x 1/2"	
012397	1" x 1/2"	
013414	1" x 3/4"	
012972	1-1/4" x 3/4"	
012887	1-1/4" x 1"	
012563	1-1/2" x 1"	
012616	1-1/2" x 1-1/4"	
014038	2" x 1-1/4"	
013985	2" x 1-1/2"	
014149	2-1/2" x 2"	

150# Black MI Reducing Coupling



Part #	Size	Price
013565	1/4" x 1/8"	
015102	3/8" x 1/8"	
015080	3/8" x 1/4"	
013283	1/2" x 1/8"	
013264	1/2" x 1/4"	
013326	1/2" x 3/8"	
014845	3/4" x 1/4"	
014905	3/4" x 3/8"	
014801	3/4" x 1/2"	
013445	1" x 3/8"	
012371	1" x 1/2"	
013408	1" x 3/4"	
012933	1-1/4" x 1/2"	
012970	1-1/4" x 3/4"	
012882	1-1/4" x 1"	
012657	1-1/2" x 1/2"	
012700	1-1/2" x 3/4"	
012560	1-1/2" x 1"	
012611	1-1/2" x 1-1/4"	
014057	2" x 1/2"	

Threaded Black Malleable Iron Fittings (Continued)

150# Black MI Reducing Coupling

Part #	Size	Price
014248	2" x 3/4"	
013958	2" x 1"	
014036	2" x 1-1/4"	
013983	2" x 1-1/2"	
014141	2-1/2" x 1-1/4"	
014131	2-1/2" x 1-1/2"	
014148	2-1/2" x 2"	
014480	3" x 1-1/2"	
014517	3" x 2"	
014555	3" x 2-1/2"	
015384	4" x 2-1/2"	
015427	4" x 3"	

150# Black MI Tee



Part #	Size	Price
013659	1/8"	
013472	1/4"	
014984	3/8"	
013050	1/2"	
014628	3/4"	
012188	1"	
012769	1-1/4"	
012387	1-1/2"	
013759	2"	
014061	2-1/2"	
014312	3"	

Black Steel Fittings

150# Black MI Reducing Run/Outlet Tee



Part #	Size	Price
014835	3/4" x 1/2" x 1/2"	
012660	1" x 1/2" x 1/2"	
012702	1" x 1/2" x 3/4"	
013436	1" x 3/4" x 1/2"	
013440	1" x 3/4" x 3/4"	
012987	1-1/4" x 3/4" x 3/4"	
012983	1-1/4" x 3/4" x 1"	
012912	1-1/4" x 1" x 1/2"	
012947	1-1/4" x 1" x 3/4"	
012906	1-1/4" x 1" x 1"	
012582	1-1/2" x 1" x 1"	
029429	1-1/2" x 1" x 1-1/4"	
012651	1-1/2" x 1-1/4" x 1/2"	
012654	1-1/2" x 1-1/4" x 3/4"	
012643	1-1/2" x 1-1/4" x 1"	
012647	1-1/2" x 1-1/4" x 1-1/4"	
014050	2" x 1-1/4" x 1-1/4"	
014013	2" x 1-1/2" x 1"	
014025	2" x 1-1/2" x 1-1/4"	
014017	2" x 1-1/2" x 1-1/2"	

150# Black MI Reducing Run Tee



Part #	Size	Price
013281	1/2" x 1/4" x 1/2"	
013355	1/2" x 3/8" x 1/2"	
014839	3/4" x 1/2" x 3/4"	
012562	1" x 1/2" x 1"	
013432	1" x 3/4" x 1"	
012985	1-1/4" x 3/4" x 1-1/4"	
012908	1-1/4" x 1" x 1-1/4"	
012672	1-1/2" x 1/2" x 1-1/2"	
012717	1-1/2" x 3/4" x 1-1/2"	
012584	1-1/2" x 1" x 1-1/2"	

Threaded Black Malleable Iron Fittings (Continued)

150# Black MI Reducing Run Tee

Part #	Size	Price
014060	2" x 1" x 2"	
014028	2" x 1-1/2" x 2"	

150# Black MI Reducing Outlet Tee



Part #	Size	Price
015141	3/8" x 3/8" x 1/2"	
013248	1/2" x 1/2" x 1/4"	
013256	1/2" x 1/2" x 3/8"	
014899	3/4" x 3/4" x 1/4"	
014892	3/4" x 3/4" x 1/2"	
012347	1" x 1" x 1/4"	
012343	1" x 1" x 1/2"	
012742	1" x 1" x 3/4"	
012923	1-1/4" x 1-1/4" x 1/2"	
012928	1-1/4" x 1-1/4" x 3/4"	
012918	1-1/4" x 1-1/4" x 1"	
012597	1-1/2" x 1-1/2" x 1/2"	
012603	1-1/2" x 1-1/2" x 3/4"	
012589	1-1/2" x 1-1/2" x 1"	
012593	1-1/2" x 1-1/2" x 1-1/4"	
014231	2" x 2" x 1/2"	
014236	2" x 2" x 3/4"	
014211	2" x 2" x 1"	
014226	2" x 2" x 1-1/4"	
014217	2" x 2" x 1-1/2"	
014173	2-1/2" x 2-1/2" x 3/4"	

150# Black MI Bull Tee



Part #	Size	Price
013252	1/2" x 1/2" x 3/4"	
014888	3/4" x 3/4" x 1"	

Threaded Black Malleable Iron Fittings (Continued)

150# Black MI Bull Tee

Part #	Size	Price
012340	1" x 1" x 1-1/4"	

Black MI 150# Square Head Plug - Solid



Part #	Size	Price
013652	1/8"	
013461	1/4"	
014973	3/8"	
013038	1/2"	
014615	3/4"	
012174	1"	
012757	1-1/4"	
012376	1-1/2"	
013751	2"	
014059	2-1/2"	
014310	3"	

150# Black MI Floor Flange



Part #	Size	Price
013032	1/2"	
014610	3/4"	
012172	1"	
012372	1-1/2"	
013748	2"	

Black Malleable Iron Unions

150# Black MI All Iron Union



Part #	Size	Price
013661	1/8"	
013474	1/4"	

Pipe Fittings



Black Steel Fittings

Black Malleable Iron Unions (Continued)

150# Black MI All Iron Union

Part #	Size	Price
014986	3/8"	
013052	1/2"	
014630	3/4"	
012190	1"	
012771	1-1/4"	
012389	1-1/2"	
013761	2"	
014063	2-1/2"	
014314	3"	

Black Steel Nipples



Standard Weight Black Steel Nipples



1/8" Std Wt Black Steel Nipple

Part #	Size	Price
013666	1/8" x Close	
013687	1/8" x 1-1/2"	
013689	1/8" x 2"	
013692	1/8" x 2-1/2"	
013699	1/8" x 3"	
013708	1/8" x 3-1/2"	
013710	1/8" x 4"	
013712	1/8" x 4-1/2"	
013714	1/8" x 5"	
013716	1/8" x 5-1/2"	
013719	1/8" x 6"	

1/4" Std Wt Black Steel Nipple

Part #	Size	Price
013482	1/4" x Close	
013543	1/4" x 1-1/2"	
013577	1/4" x 2"	
013581	1/4" x 2-1/2"	
013586	1/4" x 3"	

Standard Weight Black Steel Nipples (Continued)

1/4" Std Wt Black Steel Nipple

Part #	Size	Price
013590	1/4" x 3-1/2"	
013599	1/4" x 4"	
013602	1/4" x 4-1/2"	
013605	1/4" x 5"	
013609	1/4" x 5-1/2"	
013614	1/4" x 6"	
026453	1/4" x 12"	

3/8" Std Wt Black Steel Nipple

Part #	Size	Price
014997	3/8" x Close	
015064	3/8" x 1-1/2"	
015110	3/8" x 2"	
015114	3/8" x 2-1/2"	
015119	3/8" x 3"	
015123	3/8" x 3-1/2"	
015147	3/8" x 4"	
015152	3/8" x 4-1/2"	
015156	3/8" x 5"	
015161	3/8" x 5-1/2"	
015167	3/8" x 6"	

1/2" Std Wt Black Steel Nipple

Part #	Size	Price
013079	1/2" x Close	
013228	1/2" x 1-1/2"	
013291	1/2" x 2"	
013296	1/2" x 2-1/2"	
013303	1/2" x 3"	
013310	1/2" x 3-1/2"	
013360	1/2" x 4"	
013366	1/2" x 4-1/2"	
013371	1/2" x 5"	
013377	1/2" x 5-1/2"	
013382	1/2" x 6"	
035602	1/2" x 6-1/2"	
013387	1/2" x 7"	
035601	1/2" x 7-1/2"	
013389	1/2" x 8"	
035604	1/2" x 8-1/2"	
013394	1/2" x 9"	
013219	1/2" x 10"	

Standard Weight Black Steel Nipples (Continued)

1/2" Std Wt Black Steel Nipple

Part #	Size	Price
013226	1/2" x 11"	
013217	1/2" x 12"	
013284	1/2" x 18"	
013301	1/2" x 24"	
013309	1/2" x 30"	
020745	1/2" x 36"	
020746	1/2" x 48"	
027200	1/2" x 60"	

3/4" Std Wt Black Steel Nipple

Part #	Size	Price
014656	3/4" x Close	
014792	3/4" x 1-1/2"	
014860	3/4" x 2"	
014866	3/4" x 2-1/2"	
014873	3/4" x 3"	
014878	3/4" x 3-1/2"	
014914	3/4" x 4"	
014919	3/4" x 4-1/2"	
014925	3/4" x 5"	
014929	3/4" x 5-1/2"	
014936	3/4" x 6"	
014942	3/4" x 7"	
014944	3/4" x 8"	
014946	3/4" x 9"	
014787	3/4" x 10"	
014790	3/4" x 11"	
014785	3/4" x 12"	
027211	3/4" x 18"	
027210	3/4" x 24"	
114381	3/4" x 30"	
053834	3/4" x 36"	
053833	3/4" x 48"	
114382	3/4" x 60"	

1" Std Wt Black Steel Nipple

Part #	Size	Price
012208	1" x Close	
013034	1" x 2"	
013235	1" x 2-1/2"	
013396	1" x 3"	
013401	1" x 3-1/2"	

Pipe Fittings



Black Steel Fittings

Standard Weight Black Steel Nipples (Continued)

1" Std Wt Black Steel Nipple

Part #	Size	Price
013459	1" x 4"	
013547	1" x 4-1/2"	
013618	1" x 5"	
013624	1" x 5-1/2"	
013634	1" x 6"	
021038	1" x 7"	
013651	1" x 8"	
013723	1" x 9"	
012334	1" x 10"	
057394	1" x 11"	
012373	1" x 12"	
073411	1" x 18"	
073413	1" x 24"	
114385	1" x 30"	
114386	1" x 36"	
114387	1" x 48"	
114388	1" x 60"	

1-1/4" Std Wt Black Steel Nipple

Part #	Size	Price
012798	1-1/4" x Close	
012954	1-1/4" x 2"	
012958	1-1/4" x 2-1/2"	
012962	1-1/4" x 3"	
012966	1-1/4" x 3-1/2"	
012992	1-1/4" x 4"	
012996	1-1/4" x 4-1/2"	
012999	1-1/4" x 5"	
013002	1-1/4" x 5-1/2"	
013005	1-1/4" x 6"	
013010	1-1/4" x 8"	
012904	1-1/4" x 10"	
012896	1-1/4" x 12"	

1-1/2" Std Wt Black Steel Nipple

Part #	Size	Price
012427	1-1/2" x Close	
012677	1-1/2" x 2"	
012687	1-1/2" x 2-1/2"	
012692	1-1/2" x 3"	
012696	1-1/2" x 3-1/2"	
012722	1-1/2" x 4"	

Standard Weight Black Steel Nipples (Continued)

1-1/2" Std Wt Black Steel Nipple

Part #	Size	Price
012725	1-1/2" x 4-1/2"	
012727	1-1/2" x 5"	
012730	1-1/2" x 5-1/2"	
012733	1-1/2" x 6"	
012738	1-1/2" x 7"	
012739	1-1/2" x 8"	
012578	1-1/2" x 10"	
012658	1-1/2" x 12"	

2" Std Wt Black Steel Nipple

Part #	Size	Price
013802	2" x Close	
014229	2" x 2-1/2"	
014240	2" x 3"	
014244	2" x 3-1/2"	
014260	2" x 4"	
014265	2" x 4-1/2"	
014270	2" x 5"	
014274	2" x 5-1/2"	
014280	2" x 6"	
014286	2" x 7"	
014288	2" x 8"	
014292	2" x 9"	
013973	2" x 10"	
013964	2" x 12"	

2-1/2" Std Wt Black Steel Nipple

Part #	Size	Price
014078	2-1/2" x Close	
014177	2-1/2" x 3"	
014178	2-1/2" x 3-1/2"	
014182	2-1/2" x 4"	
014184	2-1/2" x 4-1/2"	
014186	2-1/2" x 5"	
014188	2-1/2" x 5-1/2"	
014190	2-1/2" x 6"	
014194	2-1/2" x 8"	
014127	2-1/2" x 12"	

3" Std Wt Black Steel Nipple

Part #	Size	Price
014342	3" x Close	
014570	3" x 3"	
014585	3" x 3-1/2"	
014611	3" x 4"	
014802	3" x 4-1/2"	
014948	3" x 5"	
014953	3" x 5-1/2"	
014955	3" x 6"	
014959	3" x 7"	
014972	3" x 8"	
014471	3" x 10"	
014467	3" x 12"	

4" Std Wt Black Steel Nipple

Part #	Size	Price
015218	4" x Close	
175254	4" x 3-1/2"	
015470	4" x 4"	
015496	4" x 6"	
015500	4" x 7"	
015501	4" x 8"	
015352	4" x 10"	
015349	4" x 12"	

Black Steel Nipple Sets

25 Pack Black Steel Nipple Assortment

Part #	Size	Price
013035	1/2"	
014612	3/4"	

54 Pack Black Steel Nipple Assortment

Part #	Size	Price
013749	2" Special-6	

60 Pack Black Steel Nipple Assortment

Part #	Size	Price
012173	1"	
012756	1-1/4"	

Pipe Fittings

Black Steel Nipples



Black Steel Nipples



Black Steel Fittings

66 Pack Black Steel Nipple Assortment

Part #	Size	Price
013036	1/2"	
014613	3/4"	

Standard Weight Black Steel Nipples



3/4" Std Wt Black Steel Nipple

Part #	Size	Price
014941	3/4" x 6-1/2"	

Brass Fittings

Standard Brass Fittings Brass Hex Bushing - Threaded



Part #	Mfg #	Size	Price
013566	80110-402	1/4" x 1/8"	
015081	80110-604	3/8" x 1/4"	
013285	80110-802	1/2" x 1/8"	
013265	80110-804	1/2" x 1/4"	
013328	80110-806	1/2" x 3/8"	
014854	80110-1202	3/4" x 1/8"	
014846	80110-1204	3/4" x 1/4"	
014906	80110-1206	3/4" x 3/8"	
014803	80110-1208	3/4" x 1/2"	
012377	80110-1608	1" x 1/2"	
013410	80110-1612	1" x 3/4"	
012934	80110-2008	1-1/4" x 1/2"	
012971	80110-2012	1-1/4" x 3/4"	
012659	80110-2408	1-1/2" x 1/2"	
012701	80110-2412	1-1/2" x 3/4"	
012561	80110-2416	1-1/2" x 1"	
012613	80110-2420	1-1/2" x 1-1/4"	
087906	80110-3212	2" x 3/4"	
025419	80110-3216	2" x 1"	
014037	80110-3220	2" x 1-1/4"	
013984	80110-3224	2" x 1-1/2"	
052436	80110-4032	2-1/2" x 2"	

Brass Cap - Threaded



Part #	Mfg #	Size	Price
013462	80108-04	1/4"	
014974	80108-06	3/8"	
013039	80108-08	1/2"	
014616	80108-12	3/4"	
012176	80108-16	1"	
012760	80108-20	1-1/4"	
012378	80108-24	1-1/2"	
013752	80108-32	2"	

Brass Coupling - Threaded



Part #	Mfg #	Size	Price
013653	80103-02	1/8"	

Standard Brass Fittings (Continued) Brass Coupling - Threaded

Part #	Mfg #	Size	Price
014975	80103-06	3/8"	
013040	80103-08	1/2"	
014617	80103-12	3/4"	
012177	80103-16	1"	
012761	80103-20	1-1/4"	
012379	80103-24	1-1/2"	
064494	80103-32	2"	

Brass Reducing Coupling - Threaded



Part #	Mfg #	Size	Price
027581	80119-0402	1/4" x 1/8"	
015082	80119-0604	3/8" x 1/4"	
013329	80119-0806	1/2" x 3/8"	
036471	80119-1206	3/4" x 3/8"	
014804	80119-1208	3/4" x 1/2"	
013411	80119-1612	1" x 3/4"	
012884	80119-2016	1-1/4" x 1"	
104881	80119-2416	1-1/2" x 1"	
012614	80119-2420	1-1/2" x 1-1/4"	
050014	80119-3224	2" x 1-1/2"	

Brass 45° Elbow - Threaded



Part #	Mfg #	Size	Price
013046	80107-08	1/2"	
014624	80107-12	3/4"	
012182	80107-16	1"	
012383	80107-24	1-1/2"	

Brass 45° Street Elbow - Threaded



Part #	Mfg #	Size	Price
026780	80124-08	1/2"	

Pipe Fittings

Brass Fittings

Brass 90° Elbow - Threaded



Part #	Mfg #	Size	Price
013468	80100-04	1/4"	
014980	80100-06	3/8"	
013047	80100-08	1/2"	
014625	80100-12	3/4"	
012183	80100-16	1"	
012765	80100-20	1-1/4"	
012384	80100-24	1-1/2"	
013755	80100-32	2"	

Brass 90° Reducing Elbow - Threaded

Part #	Mfg #	Size	Price
020519	80105-0402	1/4" x 1/8"	
077706	80105-1208	3/4" x 1/2"	
013413	80105-1612	1" x 3/4"	

Brass 90° Street Elbow - Threaded



Part #	Mfg #	Size	Price
013656	80116-02	1/8"	
013466	80116-04	1/4"	
013043	80116-08	1/2"	
014621	80116-12	3/4"	
012179	80116-16	1"	

Brass Square Head Solid Plug - Threaded



Part #	Mfg #	Size	Price
013655	80114-02	1/8"	
013465	80114-04	1/4"	
014976	80114-06	3/8"	
013042	80114-08	1/2"	
012178	80114-16	1"	
012762	80114-20	1-1/4"	
012380	80114-24	1-1/2"	
013753	80114-32	2"	

Brass Tee - Threaded



Part #	Mfg #	Size	Price
013467	80101-04	1/4"	
014977	80101-06	3/8"	
013044	80101-08	1/2"	
014622	80101-12	3/4"	
012180	80101-16	1"	
012763	80101-20	1-1/4"	
012381	80101-24	1-1/2"	
013754	80101-32	2"	

Brass Reducing Tee - Threaded



Part #	Mfg #	Size	Price
014898	80106-12120	3/4" x 3/4" x 1/2"	
	8		
013412	80106-16161	1" x 1" x 3/4"	
	2		

Brass Union - Threaded



Part #	Mfg #	Size	Price
031701	80104-04	1/4"	
014978	80104-06	3/8"	
013045	80104-08	1/2"	
014623	80104-12	3/4"	
012181	80104-16	1"	
012764	80104-20	1-1/4"	
012382	80104-24	1-1/2"	
019574	80104-32	2"	

Red Brass Nipples



1/8" Red Brass Nipple

Part #	Size	Price
013667	1/8" x Close	
030821	1/8" x 1-1/2"	
013690	1/8" x 2"	

Pipe Fittings



Brass Fittings

Red Brass Nipples (Continued)

1/8" Red Brass Nipple

Part #	Size	Price
013693	1/8" x 2-1/2"	
013700	1/8" x 3"	
013721	1/8" x 6"	

1/4" Red Brass Nipple

Part #	Size	Price
013544	1/4" x 1-1/2"	
013600	1/4" x 4"	
013615	1/4" x 6"	

3/8" Red Brass Nipple

Part #	Size	Price
014998	3/8" x Close	
015065	3/8" x 1-1/2"	
015111	3/8" x 2"	
015115	3/8" x 2-1/2"	
015120	3/8" x 3"	
015124	3/8" x 3-1/2"	
015148	3/8" x 4"	
015153	3/8" x 4-1/2"	
015157	3/8" x 5"	
015162	3/8" x 5-1/2"	
015168	3/8" x 6"	

1/2" Red Brass Nipple

Part #	Size	Price
013080	1/2" x Close	
013229	1/2" x 1-1/2"	
013292	1/2" x 2"	
013297	1/2" x 2-1/2"	
013304	1/2" x 3"	
013311	1/2" x 3-1/2"	
013361	1/2" x 4"	
013367	1/2" x 4-1/2"	
013372	1/2" x 5"	
013378	1/2" x 5-1/2"	
013383	1/2" x 6"	

3/4" Red Brass Nipple

Part #	Size	Price
014657	3/4" x Close	
014793	3/4" x 1-1/2"	

Red Brass Nipples (Continued)

3/4" Red Brass Nipple

Part #	Size	Price
014861	3/4" x 2"	
014867	3/4" x 2-1/2"	
014874	3/4" x 3"	
014879	3/4" x 3-1/2"	
014915	3/4" x 4"	
014920	3/4" x 4-1/2"	
014926	3/4" x 5"	
014930	3/4" x 5-1/2"	
014937	3/4" x 6"	
048185	3/4" x 8"	
048184	3/4" x 12"	

1" Red Brass Nipple

Part #	Size	Price
012209	1" x Close	
013041	1" x 2"	
013236	1" x 2-1/2"	
013397	1" x 3"	
013402	1" x 3-1/2"	
013464	1" x 4"	
013548	1" x 4-1/2"	
013619	1" x 5"	
013625	1" x 5-1/2"	
013635	1" x 6"	
048183	1" x 12"	

1-1/4" Red Brass Nipple

Part #	Size	Price
012799	1-1/4" x Close	
012955	1-1/4" x 2"	
012959	1-1/4" x 2-1/2"	
012963	1-1/4" x 3"	
012993	1-1/4" x 4"	
012997	1-1/4" x 4-1/2"	
013000	1-1/4" x 5"	
013003	1-1/4" x 5-1/2"	
013006	1-1/4" x 6"	

1-1/2" Red Brass Nipple

Part #	Size	Price
012428	1-1/2" x Close	
012678	1-1/2" x 2"	
012688	1-1/2" x 2-1/2"	

Pipe Fittings

Brass Fittings

Red Brass Nipples (Continued)

1-1/2" Red Brass Nipple

Part #	Size	Price
012693	1-1/2" x 3"	
025894	1-1/2" x 3-1/2"	
012723	1-1/2" x 4"	
051927	1-1/2" x 4-1/2"	
051925	1-1/2" x 5"	
051924	1-1/2" x 5-1/2"	
012734	1-1/2" x 6"	

2" Red Brass Nipple

Part #	Size	Price
013803	2" x Close	
014230	2" x 2-1/2"	
014241	2" x 3"	
032231	2" x 3-1/2"	
014261	2" x 4"	
054282	2" x 5"	
014281	2" x 6"	

Brass Hex Nipples (MIP x MIP)



Part #	Size	Price
013654	1/8"	



Test Plugs

TP Series Test Plug

- Temperature and pressure probe inserts into the test plug for test readings
- Economical means of balancing heating and air conditioning systems
- Pressure gauge adapter has 0.076" dia probe of stainless steel with brass union nut



TP-N - Test Plug for Natural Gas and Petroleum Products

- Temperature range: -40° - 200°F

Part #	Mfg #	Model	Type/Color	Size	Price
156597	0123012	TPN	Neoprene/Blue	1/4"	
156598	0123013	TPN	Neoprene/Blue	1/2"	

Test Plugs (Continued)

TP Series Test Plug

TP-N - Test Plug for Natural Gas and Petroleum Products

Part #	Mfg #	Model	Type/Color	Size	Price
157248	0123014	LFTP-GA1		1/4"	

LFDPTG-1 Combination Pressure and Temperature Gauges, Bottom-Entry

- Black enamel steel case
- Kostil polymer window
- Tin alloy welding
- 1/2" Lead Free* Brass NPT
- Pressure gauge ASME Type "B" accuracy
- Copper alloy Bourdon pressure element
- Bimetal spiral spring temperature element



Part #	Mfg #	Model	Size	Price
156942	0121663	LFDPTG-1	-	3"



Red Brass Pipe Nipples

- Meets ASTM B687



Part #	Mfg #	Size	Price
154252	N20-006	1/8" x 4"	
013483	N21-000	1/4" x Close	
013578	N21-002	1/4" x 2"	
013582	N21-003	1/4" x 2-1/2"	
013587	N21-004	1/4" x 3"	
053792	N21-008	1/4" x 5"	
062200	N25-014	1" x 8"	

Bronze Pipe Fittings

Bronze 45° Elbow



Part #	Mfg #	Size	Price
121486	B74-042	1/4"	

Brass Fittings

Bronze 90° Elbow



Part #	Mfg #	Size	Price
052595	B74-001	1/8"	

Bronze Solid Square Head Plug



Part #	Mfg #	Size	Price
014620	B74-305	3/4"	

Bronze Coupling/Reducer



Part #	Mfg #	Size	Price
013463	B74-122	1/4"	

Bronze Hex Bushing



Part #	Mfg #	Size	Price
015103	B74-201	3/8" x 1/8"	
012883	B74-218	1-1/4" x 1"	

Brass Hose Fittings

Brass Adapter (MHT x MIP)



Part #	Mfg #	Size	Price
014809	G20-002	3/4" MHT x 1/2" MIP	
014891	G20-003	3/4" MHT x 3/4" MIP	
122418	G20-004	3/4" MHT x 1/2" MIP	

Brass Adapter (MHT x MHT)



Part #	Mfg #	Size	Price
014885	G20-008	3/4" MHT x 3/4" MHT (1/2" FIP Tap)	

Brass Adapter (MHT x FIP)



Part #	Mfg #	Size	Price
014808	G20-010	3/4" MHT x 1/2" FIP	
014884	G20-011	3/4" MHT x 3/4" FIP	

Brass Adapter (FHT x MIP)



Part #	Mfg #	Size	Price
014807	G20-015	3/4" FHT x 1/2" MIP	
014883	G20-016	3/4" FHT x 3/4" MIP	

Brass Adapter (FHT x FIP)



Part #	Mfg #	Size	Price
014806	G20-020	3/4" FHT x 1/2" FIP	
014882	G20-021	3/4" FHT x 3/4" FIP	

Brass Garden Hose Fitting (Swivel FHT x FHT)



Part #	Mfg #	Size	Price
045386	G20-030	3/4" FHT x 3/4" FHT	
162035	G20-130	3/4" FHT x 3/4" FHT LF	

Brass Fittings

Brass Garden Hose Fitting (Swivel FHT x FIP)



Part #	Mfg #	Size	Price
045376	G20-031	3/4" FHT x 1/2" FIP	
045374	G20-032	3/4" FHT x 3/4" FIP	
162036	G20-131	3/4" FHT x 1/2" FIPLF	
162037	G20-132	3/4" FHT x 3/4" FIP	

Brass Male Hose Barb (Hose Barb x MIP)



Part #	Mfg #	Size	Price
045381	G20-042	5/8" HB x 3/4" MHT	

Brass Female Hose Barb (Hose BarbxFHT)



Part #	Mfg #	Description	Price
162038	G20-136	1/2ID X 3/4FGH LF SWIVEL	
162039	G20-137	5/8ID X 3/4FGH LF SWIVEL	
162040	G20-138	3/4ID X 3/4FGH LF SWIVEL	

Brass Male Hose Barb



Part #	Mfg #	Description	Price
162041	G20-141	1/2"HBx 3/4" MGH	
162042	G20-142	5/8"HBx 3/4" MGH	
162043	G20-143	3/4"HBx 3/4" MGH	

Brass Hose Barb to Female Pipe



Part #	Mfg #	Description	Price
164701	G26-046	1/4" Barb x 3/8" FIP	

Brass Hose Fittings (Continued)

Brass Hose Barb to Female Pipe

Part #	Mfg #	Description	Price
222471	G26-066	3/8" Barb x 3/8" FIP	

Brass Hose Barb to Male Pipe



Part #	Mfg #	Description	Price
189220	G25-046	1/4"Barb x 3/8" MIP	
189221	G25-056	5/16" Barb x 3/8" MIP	

Garden Hose Shut-Off

- *Buna-N seals*



Part #	Mfg #	Description	Price
117406	G20-053	3/4" Dual Hose Wye Shut-Off Forged Brass	

Garden Hose Wye

- *3/4"x3/4" Brass*
- *Lead Free*
- *Garden Hose Connection*



Part #	Mfg #	Description	Price
162044	G20-150	3/4"x3/4" Brass Lead Free Wye	

Brass Garden Hose Cap



Part #	Mfg #	Size	Price
014618	G20-055	3/4" FHT	

Brass Fittings

Garden Hose Washer



Part #	Mfg #	Description	Price
045377	G20-057	3/4", Vinyl	



Brass Flare Fittings Brass Flare Seal Cap



Part #	Mfg #	Size	Price
013505	440	1/4"	
015024	440	3/8"	
013119	440	1/2"	
015571	440	5/8"	

Brass Flare Coupling (Flr x Flr)



Part #	Mfg #	Size	Price
013561	406	1/4" x 1/4"	
015137	406	3/8" x 3/8"	
015075	406	3/8" x 1/2"	
013345	406	1/2" x 3/8"	
013241	406	1/2" x 1/2"	
013320	406	1/2" x 3/4"	
015593	406	5/8" x 1/2"	
015601	406	5/8" x 3/4"	
014824	406	3/4" x 1/2"	

Brass Flare 90° Elbow (Flr x Flr)



Part #	Mfg #	Size	Price
015138	500	3/8" x 3/8"	
015594	500	5/8" x 1/2"	

Brass Flare Fittings (Continued)

Brass Flare 90° Elbow (Flr x Flr)

Part #	Mfg #	Size	Price
015602	500	5/8" x 3/4"	

Brass Flare 90° Elbow (Flr x MIP)



Part #	Mfg #	Size	Price
028993	409	1/4" x 1/4"	
015095	409	3/8" x 1/4"	
015140	409	3/8" x 3/8"	
015130	409	3/8" x 3/4"	
013244	409	1/2" x 1/2"	
013323	409	1/2" x 3/4"	
015596	409	5/8" x 1/2"	
015604	409	5/8" x 3/4"	

Brass Flare Short Nut



Part #	Mfg #	Size	Price
013506	441-S	1/4"	
015026	441-S	3/8"	
013121	441-S	1/2"	
015573	441-S	5/8"	
014692	441-S	3/4"	

Brass Flare Short Forged Nut



Part #	Mfg #	Size	Price
013511	6401-S	1/4"	
015027	6401-S	3/8"	
013122	6401-S	1/2"	
015574	6401-S	5/8"	

Brass Flare Plug



Part #	Mfg #	Size	Price
013507	439	1/4"	

Brass Flare Fittings

Brass Flare Fittings (Continued)

Brass Flare Plug

Part #	Mfg #	Size	Price
015028	439	3/8"	
013123	439	1/2"	

Brass Flare Swivel Connector



Part #	Mfg #	Size	Price
031005	700	1/4"	
013120	700	1/2"	
015572	700	5/8"	

Brass Flare Tee (Flr x Flr x Flr)



Part #	Mfg #	Size	Price
013508	404	1/4"	
015029	404	3/8"	
013124	404	1/2"	
015576	404	5/8"	

Brass Flare Union (Flr x Flr)



Part #	Mfg #	Size	Price
013509	402	1/4"	
015030	402	3/8"	
013125	402	1/2"	
015577	402	5/8"	
014694	402	3/4"	

Brass Flare Reducing Union (Flr x Flr)

Part #	Mfg #	Size	Price
013350	506	1/2" x 3/8"	

Brass Flare Half-Union (Flr x MIP)



Part #	Mfg #	Size	Price
013562	408	1/4" x 1/4"	
013598	408	1/4" x 3/8"	
013552	408	1/4" x 1/2"	
015094	408	3/8" x 1/4"	
015139	408	3/8" x 3/8"	
015077	408	3/8" x 1/2"	
015129	408	3/8" x 3/4"	
013347	408	1/2" x 3/8"	
013243	408	1/2" x 1/2"	
013322	408	1/2" x 3/4"	
015595	408	5/8" x 1/2"	
015603	408	5/8" x 3/4"	
014825	408	3/4" x 1/2"	

Brass OD Compression Fittings

Brass Compression Fittings

Brass Coupling (Comp x FIP)



Part #	Mfg #	Size	Price
013557	66	1/4"	
013569	66	1/4" x 1/8"	
015133	66	3/8"	
015105	66	3/8" x 1/8"	
015088	66	3/8" x 1/4"	
015072	66	3/8" x 1/2"	
013237	66	1/2"	
013338	66	1/2" x 3/8"	
034709	66	7/8" x 3/4"	

Brass Connector (Comp x MIP)



Part #	Mfg #	Size	Price
013558	68	1/4"	
013570	68	1/4" x 1/8"	
013596	68	1/4" x 3/8"	
013551	68	1/4" x 1/2"	
054620	68	5/16" x 1/4"	
015134	68	3/8"	
015104	68	3/8" x 1/8"	
015089	68	3/8" x 1/4"	
015073	68	3/8" x 1/2"	
013238	68	1/2"	
013339	68	1/2" x 3/8"	
015605	68	5/8" x 3/8"	
015590	68	5/8" x 1/2"	
015600	68	5/8" x 3/4"	
014886	68	3/4"	
015781	68	7/8" x 3/4"	

Brass Compression Cap



Part #	Mfg #	Size	Price
022300	61-CX	3/8"	

Brass 90° Elbow (Comp x Comp)



Part #	Mfg #	Size	Price
013560	65	1/4"	
015136	65	3/8"	
013240	65	1/2"	
015611	65	5/8"	

Brass 90° Elbow (Comp x MIP)



Part #	Mfg #	Size	Price
013559	69	1/4"	
013571	69	1/4" x 1/8"	
013597	69	1/4" x 3/8"	
015135	69	3/8"	
015090	69	3/8" x 1/4"	
015074	69	3/8" x 1/2"	
013239	69	1/2"	
013340	69	1/2" x 3/8"	
015591	69	5/8" x 1/2"	

Brass Insert



Part #	Mfg #	Size	Hose ID	Price
013490	61P	1/4"	0.17	
015007	61P	3/8"	0.25	

Brass Compression Nut



Part #	Mfg #	Size	Price
013492	61	1/4"	
015008	61	3/8"	
013091	61	1/2"	
015563	61	5/8"	
015769	61	7/8"	

Brass OD Compression Fittings

Brass Compression Sleeve



Part #	Mfg #	Size	Price
013670	60	1/8"	
013493	60	1/4"	
015009	60	3/8"	
013092	60	1/2"	
015564	60	5/8"	

Brass Compression Plug

Part #	Mfg #	Size	Price
026028	39	3/8"	

Delrin Plastic Compression Sleeve



Part #	Mfg #	Size	Price
013489	60P	1/4"	
015006	60P	3/8"	

Brass Compression Tee



Part #	Mfg #	Size	Price
013494	64	1/4"	
015010	64	3/8"	
013093	64	1/2"	
015565	64	5/8"	

Brass Compression Union



Part #	Mfg #	Size	Price
013671	62	1/8"	
013495	62	1/4"	
015011	62	3/8"	
015091	62	3/8" x 1/4"	
013094	62	1/2"	
013341	62R	1/2" x 3/8"	
015566	62	5/8"	
015606	62R	5/8" x 3/8"	
015592	62R	5/8" x 1/2"	

Brass Compression Fittings (Continued)

Brass Compression Union

Part #	Mfg #	Size	Price
014669	62	3/4"	
015771	62	7/8"	

Brass Needle Valves

Brass 90° Needle Valve (Comp x MIP)

Part #	Mfg #	Size	Price
013491	09103-0404	1/4"	



Brass Compression Fittings

Brass Compression Cap

- Style 61C



Part #	Mfg #	Size	Price
046827	C74-001	1/4"	

Brass Compression Sleeve

- Style 60



Part #	Mfg #	Size	Price
015770	C74-011	7/8"	

Brass Connector (Comp x FIP)

- Style 66



Part #	Mfg #	Size	Price
015589	C74-054	5/8" Comp x 1/2" FIP	
020847	C74-118	5/8" Comp x 3/4" FIP	

Brass 90° Elbow (Comp x FIP)

- Style 70



Part #	Mfg #	Size	Price
057224	C74-078	3/8" Comp x 1/2" FIP	

Brass OD Compression Fittings

Brass 90° Compression Elbow

- Lead free



Part #	Mfg #	Description	Price
160889	C74-112LF	7/8" x 7/8" Comp	

Brass Compression Tee

- Style 64



Part #	Mfg #	Size	Price
102653	C74-037	3/8" x 3/8" x 1/4"	

Brass Adapter (Comp x Swt)

- Lead free



Part #	Mfg #	Size	Price
124601	C74-093	3/8" Comp x 1/2" Swt	

Brass Compression Delrin Sleeve

- Style 60P



Part #	Mfg #	Size	Price
087211	C74-098	1/2"	
116812	C74-099	5/8"	

Brass Add-A-Line Tee

- Brass Compression
- Male x male x female
- Lead free



Part #	Mfg #	Description	Price
180601	C74251LF	3/8" x 3/8" x 1/4"	
180602	C74250LF	3/8" x 3/8" x 3/8"	

Streamline

A BRAND OF MUELLER INDUSTRIES

Brass EZ Connect Fittings EZ Connect Adapter Tee (MIP x Comp)



Part #	Mfg #	Size	Price
128437	993-015RP	3/8" x 1/4"	
129189	993-016RP	3/8" x 3/8"	

AMC

Threaded Sleeve Fittings

- 2-Piece construction - nut & body
- Use with copper, brass, aluminum & plastic tubing
- Temperature range: -65° - +250°F

Nut with Break-Away Sleeve

Part #	Mfg #	Size	Price
020264	181-SP	1/8"	
013488	181-SP	1/4"	

Cast Iron Fittings

**Threaded Black Cast Iron
Fittings**

125# Black CI 90° Elbow

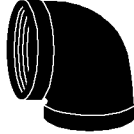

Part #	Size	Price
013077	1/2"	
014655	3/4"	
012207	1"	
013801	2"	

**Flanged Black Cast Iron
Fittings**

125# Black CI Companion Flange

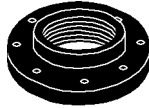

Part #	Size	Price
012728	1-1/2" x 5"	
014282	2" x 6"	
014193	2-1/2" x 7"	
014960	3" x 7-1/2"	
015503	4" x 9"	

Chrome-Plated Fittings

Chrome-Plated Brass Fittings

Chrome-Plated 125# Brass Coupling - Threaded



Part #	Mfg #	Size	Price
015012	81103-06	3/8"	
013095	81103-08	1/2"	

Chrome-Plated 125# Brass 90° Elbow - Threaded



Part #	Mfg #	Size	Price
015014	81100-06	3/8"	
013108	81100-08	1/2"	



Chrome-Plated Pipe Nipples



Part #	Mfg #	Size	Price
013081	N16-100	1/2" x Close	
032775	N16-900	1/2" x 12"	
162921	N17-600	3/4" x 6"	

Chrome-Plated Adapters

Female to Male Faucet Adapter for Price Phister®, Kohler®

- Chrome-plated brass



Part #	Mfg #	Description	Price
170363	A01-032	3/4"-27 x 55/64"	

Male to Male Faucet Adapter for Kohler®, Union®, Savoy®

- Chrome-plated brass



Part #	Mfg #	Description	Price
154799	A01-033	13/16"-27 x 55/64"-27	

Faucet to Garden Hose Adapter

- Threads: 15/16"-27 male x 55/64"-27 female x 3/4" MGH



Part #	Mfg #	Description	Finish	Price
051788	A01-040	Dual Threads	CP Brass	

Chrome-Plated Fittings

Chrome Plated Street 90°

- Chrome Plated Brass
- Lead Free



Part #	Mfg #	Description	Price
171131	B50103LF	1" Chrome plated Street 90	



Chrome-Plated Brass Nipples



3/8" Chrome-Plated Brass Nipple

Part #	Size	Price
014999	3/8" x Close	
015066	3/8" x 1-1/2"	
015112	3/8" x 2"	
015116	3/8" x 2-1/2"	
015121	3/8" x 3"	
015125	3/8" x 3-1/2"	
015149	3/8" x 4"	
015154	3/8" x 4-1/2"	
015158	3/8" x 5"	
015163	3/8" x 5-1/2"	
015169	3/8" x 6"	

Pipe Fittings



Chrome-Plated Nipples

1/2" Chrome-Plated Brass Nipple

Part #	Size	Price
013230	1/2" x 1-1/2"	
013293	1/2" x 2"	
013298	1/2" x 2-1/2"	
013305	1/2" x 3"	
013312	1/2" x 3-1/2"	
013362	1/2" x 4"	
013368	1/2" x 4-1/2"	
013373	1/2" x 5"	
013379	1/2" x 5-1/2"	
013384	1/2" x 6"	

Copper Grooved CTS Fittings

Gruvlok® CTS Couplings for Grooved End Pipe

6400 CTS Rigid Coupling

Part #	Mfg #	Size	Price
121575	6400	2"	
121577	6400	2-1/2"	
121578	6400	3"	
121579	6400	4"	

6402 CTS SlideLOK™ Coupling

- Designed to be used with copper tube sizes 2" - 4" and produces a secure, rigid joint connection



Part #	Mfg #	Size	Price
169710	6402	2"	
169711	6402	2-1/2"	
169713	6402	3"	
169714	6402	4"	

Grooved End Pipe CTS Fittings

6050 CTS 90° Elbow



Part #	Mfg #	Size	Price
121584	6050	2-1/2"	
121586	6050	4"	
121588	6050	6"	

6051 CTS 45° Elbow



Part #	Mfg #	Size	Price
121595	6051	2"	
121596	6051	2-1/2"	
121597	6051	3"	

Grooved End Pipe CTS Fittings (Continued)

6051 CTS 45° Elbow

Part #	Mfg #	Size	Price
121598	6051	4"	
121600	6051	6"	

6060 CTS Tee

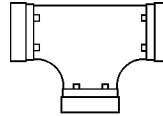

Part #	Mfg #	Size	Price
121602	6060	2"	
121604	6060	2-1/2"	
121603	6060	3"	
121605	6060	4"	
121606	6060	5"	
121607	6060	6"	

6061 CTS Reducing Tee (Grv x Grv x Grv)

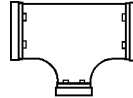

Part #	Mfg #	Size	Price
121609	6061	2-1/2" x 2"	
121610	6061	3" x 2"	
121611	6061	3" x 2-1/2"	
121612	6061	4" x 2"	
121613	6061	4" x 2-1/2"	
121614	6061	4" x 3"	
121617	6061	6" x 2-1/2"	
121618	6061	6" x 3"	

6072 CTS Concentric Reducer (Grv x Grv)

Part #	Mfg #	Size	Price
121622	6072	2-1/2" x 2"	
121623	6072	3" x 2"	
121624	6072	3" x 2-1/2"	
121626	6072	4" x 2-1/2"	
121627	6072	4" x 3"	
121631	6072	6" x 4"	
121633	6072	8" x 6"	

6084 CTS Flange Adapter

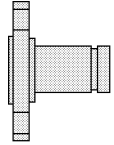

Part #	Mfg #	Size	Price
124669	6084	3"	
121994	6084	4"	

Copper Pressure Fittings

Cast Copper Pressure Fittings

Female Adapter (C x FIP)

- *Leaded brass*



Part #	Size	Price
064111	4" 4-1/8" OD x 4"	

Copper Cross (C x C x C x C)

- *Lead-free brass*



Part #	Size	Price
013064	1/2"	
014643	3/4"	

Copper 90° Drop Ear Elbow (C x C)

- *Lead-free brass*



Part #	Size	Price
013067	1/2"	
014645	3/4"	

Copper 90° Drop Ear Elbow (C x FIP)

- *Lead-free brass*



Part #	Size	Price
013066	1/2"	
014644	3/4"	
005587	1"	

Copper 90° Reducing Drop Ear Elbow (C x FIP)

- *Lead-free brass*



Part #	Size	Price
013331	1/2" x 3/8"	
014811	3/4" x 1/2"	

Copper 90° Adapter Elbow (C x FIP)

- *Lead-free brass*



Part #	Size	Price
013071	1/2"	
014647	3/4"	
012202	1"	
012793	1-1/4"	
012414	1-1/2"	

Copper 90° Reducing Adapter Elbow (C x FIP)

- *Lead-free brass*



Part #	Size	Price
013333	1/2" x 3/8"	
013416	1" x 3/4"	
013317	1/2" x 3/4"	
014813	3/4" x 1/2"	

Copper 90° Elbow (C x MIP)

- *Lead-free brass*



Part #	Size	Price
014664	3/4"	
013089	1/2"	
012217	1"	

Copper 90° Flanged Sink Elbow (C x FIP)

- *Lead-free brass*



Part #	Size	Price
013070	1/2"	

Pipe Fittings

Copper Pressure Fittings

125# Copper Companion Flange (C)

- Lead-free brass



Part #	Size	Price
166262	2"	
166263	2-1/2"	
166264	3"	
166266	4"	
166267	5"	
166268	6"	

Copper Baseboard Tee (C x FIP x C)

- Lead-free brass



Part #	Size	Price
013290	1/2" x 1/8" x 1/2"	
014859	3/4" x 1/8" x 3/4"	
013021	1" x 1/8" x 1"	

Copper Tee (C x C x FIP)

- Lead-free brass



Part #	Size	Price
013247	1/2"	
014651	3/4"	

Copper Reducing Tee (C x C x FIP)

- Lead-free brass



Part #	Size	Price
013249	1/2" x 1/2" x 1/4"	
014893	3/4" x 3/4" x 1/2"	
013253	1/2" x 1/2" x 3/4"	

Copper Drop Ear Tee (C x C x C)

- Lead-free brass



Part #	Size	Price
114095	1/2"	

Copper Drop Ear Tee (C x C x FIP)

- Lead-free brass



Part #	Size	Price
013072	1/2"	

Copper Union (C x C)

- Lead-free brass



Part #	Size	OD Size	Price
014352	3"		
014090	2-1/2"		

Copper Union (C x M)

- Leaded brass



Part #	Size	Price
069274	1/2"	
035531	3/4"	

(Cast Copper Pressure Fittings)

Copper Flush Male Adapter (C x M)



Part #	Mfg #	Size	Price
024626	704-F	1/2"	

Pipe Fittings

Copper Pressure Fittings

Tee (C x C x F)



Part #	Mfg #	Size	Price
013249	712R-LF	1/2" x 1/2" x 1/4"	
013253	712BH-LF	1/2" x 1/2" x 3/4"	
014893	712R-LF	3/4" x 3/4" x 1/2"	

90° Elbow (C x F)



Part #	Mfg #	Size	Price
013071	707-3-LF	1/2"	
014647	707-3-LF	3/4"	
012202	707-3-LF	1"	
012793	707-3-LF	1-1/4"	
012414	707-3-LF	1-1/2"	
013333	707-3R-LF	1/2" x 3/8"	
013317	707-3R-LF	1/2" x 3/4"	
014813	707-3R-LF	3/4"x1/2"	

Union (C x F)



Part #	Mfg #	Size	Price
070566	733-3	1/2"	
052604	733-3	3/4"	

90° Elbow (C x M)



Part #	Mfg #	Size	Price
013089	707-4	1/2"	
014664	707-4	3/4"	
012217	707-4	1"	

Union (C x M)



Part #	Mfg #	Size	Price
069274	733-4	1/2"	
035531	733-4	3/4"	

Drop Adapter (Ftg x M)



Part #	Mfg #	Size	Price
028509	7042	2-1/2"	

Union (C x C)



Part #	Mfg #	Size	Price
012818	733-LF	1-1/4"	
012449	733-LF	1-1/2"	
013819	733-LF	2"	
014090	733-LF	2-1/2"	
014352	733-LF	3"	

90° Drop Elbow (C x F)



Part #	Mfg #	Size	Price
013066	707-3-5-LF	1/2"	
014644	707-3-5-LF	3/4"	
005587	707-3-5-LF	1"	
013331	707-3-5R-LF	1/2" x 3/8"	
014811	707-3-5R-LF	3/4" x 1/2"	

Pipe Fittings

Copper Pressure Fittings

90° Drop Elbow (C x C)



Part #	Mfg #	Size	Price
	707-5-LF	1/2"	
	707-5-LF	3/4"	

Special Drop Adapter (C x F)



Part #	Mfg #	Size	Price
035678	7035	3/4"	

Drop Tee (C x C x F)



Part #	Mfg #	Size	Price
013072	712-5	1/2"	

90° Flanged Sink Elbow (C x F)



Part #	Mfg #	Size	Price
013070	708-LF	1/2"	

150# Companion Flange (C)



Part #	Mfg #	Size	Price
170019	771-LF	2"	
170020	771-LF	2-1/2"	
170021	771-LF	3"	
170022	771-LF	4"	
170023	771-LF	5"	

**(Cast Copper Pressure Fittings)
(Continued)**

150# Companion Flange (C)

Part #	Mfg #	Size	Price
170024	771-LF	6"	



**Wrot Copper Pressure Fittings
Adapter (C x FIP)**



Part #	Nom Size	OD Size	Price
013665	1/8"	1/4" OD x 1/8"	
013481	1/4"	3/8" OD x 1/4"	
014994	3/8"	1/2" OD x 3/8"	
013069	1/2"	5/8" OD x 1/2"	
014646	3/4"	7/8" OD x 3/4"	
012201	1"	1-1/8" OD x 1"	
012792	1-1/4"	1-3/8" OD x 1-1/4"	
012413	1-1/2"	1-5/8" OD x 1-1/2"	
013789	2"	2-1/8" OD x 2"	
014070	2-1/2"	2-5/8" OD x 2-1/2"	

Female Reducing Adapter (C x FIP)



Part #	Size	Price
013549	1/8" x 1/2"	1/4" OD x 1/2"
015084	3/8" x 1/4"	1/2" OD x 1/4"
015069	3/8" x 1/2"	1/2" OD x 1/2"
013267	1/2" x 1/4"	5/8" OD x 1/4"
013332	1/2" x 3/8"	5/8" OD x 3/8"
013316	1/2" x 3/4"	5/8" OD x 3/4"
014812	3/4" x 1/2"	7/8" OD x 1/2"
014783	3/4" x 1"	7/8" OD x 1"
013415	1" x 3/4"	1-1/8" OD x 3/4"
012348	1" x 1-1/4"	1-1/8" OD x 1-1/4"

Pipe Fittings

Copper Pressure Fittings

Adapter (Ftg x FIP)



Part #	Nom Size	OD Size	Price
013073	1/2"	5/8" OD x 1/2"	
014650	3/4"	7/8" OD x 3/4"	
012813	1"	1-1/8" OD x 1"	
012808	1-1/4"	1-3/8" OD x 1-1/4"	
012418	1-1/2"	1-5/8" OD x 1-1/2"	
013792	2"	2-1/8" OD x 2"	

Adapter (C x MIP)



Part #	Nom Size	OD Size	Price
013487	1/4"	3/8" OD x 1/4"	
015003	3/8"	1/2" OD x 3/8"	
013088	1/2"	5/8" OD x 1/2"	
014663	3/4"	7/8" OD x 3/4"	
012215	1"	1-1/8" OD x 1"	
012805	1-1/4"	1-3/8" OD x 1-1/4"	
012434	1-1/2"	1-5/8" OD x 1-1/2"	
013809	2"	2-1/8" OD x 2"	
014081	2-1/2"	2-5/8" OD x 2-1/2"	
014345	3"	3-1/8" OD x 3"	
015221	4"	4-1/8" OD x 4"	

**Copper Male Reducing Adapter
(C x MIP)**



Part #	Size	Price
012681	1-1/2" x 2"	
013993	2" x 1-1/2"	
015087	3/8" x 1/4"	1/2" OD x 1/4"
013550	1/4" x 1/2"	3/8" OD x 1/2"
015071	3/8" x 1/2"	1/2" OD x 1/2"
013271	1/2" x 1/4"	5/8" OD x 1/4"
123271	1/2" x 1"	5/8" OD x 1"
013336	1/2" x 3/8"	5/8" OD x 3/8"
013318	1/2" x 3/4"	5/8" OD x 3/4"
014818	3/4" x 1/2"	7/8" OD x 1/2"

Wrot Copper Pressure Fittings (Continued)

**Copper Male Reducing Adapter
(C x MIP)**

Part #	Size	Price
014784	3/4" x 1" 7/8" OD x 1"	
013421	1" x 3/4" 1-1/8" OD x 3/4"	
012349	1" x 1-1/4" 1-1/8" OD x 1-1/4"	
012893	1-1/4" x 1" 1-3/8" OD x 1"	
012913	1-1/4" x 1-1/2" 1-3/8" OD x 1-1/2"	
012628	1-1/2" x 1-1/4" 1-5/8" OD x 1-1/4"	

Adapter (Ftg x MIP)



Part #	Nom Size	OD Size	Price
013090	1/2"	5/8" OD x 1/2"	
014667	3/4"	7/8" OD x 3/4"	
012216	1"	1-1/8" OD x 1"	
012806	1-1/4"		
012436	1-1/2"		
013791	2"		

Flush Bushing (Ftg x C)



Part #	Nom Size	OD Size	Price
015085	3/8" x 1/8"	1/2" x 1/4"	
013268	1/2" x 1/4"	5/8" x 3/8"	
013334	1/2" x 3/8"	5/8" x 1/2"	
015588	5/8" x 1/2"	3/4" x 5/8"	
014814	3/4" x 1/2"	7/8" x 5/8"	
054329	3/4" x 5/8"	7/8" x 3/4"	
012415	1" x 1/2"	1-1/8" x 5/8"	
013417	1" x 3/4"	1-1/8" x 7/8"	
012888	1-1/4" x 1"	1-3/8" x 1-1/8"	
012622	1-1/2" x 1-1/4"	1-5/8" x 1-3/8"	

Pipe Fittings

Copper Pressure Fittings

Flush Bushing (Ftg x FIP)



Part #	Nom Size	OD Size	Price
013287	1/2" x 1/8"	5/8" OD x 1/8"	
013269	1/2" x 1/4"	5/8" OD x 1/4"	

Tube Cap (C)



Part #	Nom Size	OD Size	Price
013479	1/4"	3/8" OD	
014990	3/8"	1/2" OD	
013060	1/2"	5/8" OD	
014639	3/4"	7/8" OD	
012198	1"	1-1/8" OD	
012778	1-1/4"	1-3/8" OD	
012398	1-1/2"	1-5/8" OD	
013768	2"	2-1/8" OD	
014067	2-1/2"	2-5/8" OD	
014317	3"	3-1/8" OD	
015202	4"	4-1/8" OD	

Coupling with Roll Stops (C x C)



Part #	Nom Size	OD Size	Price
013664	1/8"	1/4" OD	
014200	3/16"	5/16" OD	

Coupling with Dimpled Stops (C x C)



Part #	Nom Size	OD Size	Price
013480	1/4"	3/8" OD	
014992	3/8"	1/2" OD	
013062	1/2"	5/8" OD	
015561	5/8"	3/4" OD	
014641	3/4"	7/8" OD	

Wrot Copper Pressure Fittings (Continued)

Coupling with Dimpled Stops (C x C)

Part #	Nom Size	OD Size	Price
012200	1"	1-1/8" OD	
012780	1-1/4"	1-3/8" OD	
012400	1-1/2"	1-5/8" OD	
013770	2"	2-1/8" OD	
014069	2-1/2"	2-5/8" OD	
014319	3"	3-1/8" OD	
015204	4"	4-1/8" OD	

Slip Coupling (C x C)



Part #	Nom Size	OD Size	Price
013496	1/4"	3/8" OD	
013109	1/2"	5/8" OD	
014682	3/4"	7/8" OD	
012219	1"	1-1/8" OD	
012807	1-1/4"	1-3/8" OD	
012439	1-1/2"	1-5/8" OD	
013810	2"	2-1/8" OD	
014084	2-1/2"	2-5/8" OD	
014347	3"	3-1/8" OD	

Reducing Coupling (C x C)



Part #	Nom Size	OD Size	Price
013572	1/4" x 1/8"	3/8" x 1/4"	
015106	3/8" x 1/8"	1/2" x 1/4"	
015092	3/8" x 1/4"	1/2" x 3/8"	
023351	3/8" x 5/16" OD	1/2" x 5/16"	
027548	1/2" x 1/8"	5/8" x 1/4"	
013272	1/2" x 1/4"	5/8" x 3/8"	
013343	1/2" x 3/8"	5/8" x 1/2"	
014291	5/8" x 1/2"	3/4" x 5/8"	
014909	3/4" x 3/8"	7/8" x 1/2"	
014822	3/4" x 1/2"	7/8" x 5/8"	
014934	3/4" x 5/8"	7/8" x 3/4"	
012437	1" x 1/2"	1-1/8" x 5/8"	
013422	1" x 3/4"	1-1/8" x 7/8"	
012938	1-1/4" x 1/2"	1-3/8" x 5/8"	
012977	1-1/4" x 3/4"	1-3/8" x 7/8"	

Copper Pressure Fittings

Wrot Copper Pressure Fittings (Continued)

Reducing Coupling (C x C)

Part #	Nom Size	OD Size	Price
012894	1-1/4" x 1"	1-3/8" x 1-1/8"	
012664	1-1/2" x 1/2"	1-5/8" x 5/8"	
012707	1-1/2" x 3/4"	1-5/8" x 7/8"	
012567	1-1/2" x 1"	1-5/8" x 1-1/8"	
012629	1-1/2" x 1-1/4"	1-5/8" x 1-3/8"	
014082	2" x 1/2"	2-1/8" x 5/8"	
014253	2" x 3/4"	2-1/8" x 7/8"	
013963	2" x 1"	2-1/8" x 1-1/8"	
014041	2" x 1-1/4"	2-1/8" x 1-3/8"	
013994	2" x 1-1/2"	2-1/8" x 1-5/8"	
030948	2-1/2" x 1"	2-5/8" x 1-1/8"	
014133	2-1/2" x 1-1/2"	2-5/8" x 1-5/8"	
014152	2-1/2" x 2"	2-5/8" x 2-1/8"	
014483	3" x 1-1/2"	3-1/8" x 1-5/8"	
014521	3" x 2"	3-1/8" x 2-1/8"	
014557	3" x 2-1/2"	3-1/8" x 2-5/8"	
015387	4" x 2"	4-1/8" x 2-1/8"	
015430	4" x 3"	4-1/8" x 3-1/8"	
054576	6" x 3"	6-1/8" x 3-1/8"	

45° Elbow (C x C)



Part #	Nom Size	OD Size	Price
013502	1/4"	3/8" OD	
015022	3/8"	1/2" OD	
013117	1/2"	5/8" OD	
015570	5/8"	3/4" OD	
014690	3/4"	7/8" OD	
012228	1"	1-1/8" OD	
012820	1-1/4"	1-3/8" OD	
012450	1-1/2"	1-5/8" OD	
013820	2"	2-1/8" OD	
014091	2-1/2"	2-5/8" OD	
014353	3"	3-1/8" OD	
015227	4"	4-1/8" OD	

45° Elbow (Ftg x C)



Part #	Nom Size	OD Size	Price
013497	1/4"	3/8" OD	
015017	3/8"	1/2" OD	
013112	1/2"	5/8" OD	
015567	5/8"	3/4" OD	
014685	3/4"	7/8" OD	
012223	1"	1-1/8" OD	
012814	1-1/4"	1-3/8" OD	
012444	1-1/2"	1-5/8" OD	
013815	2"	2-1/8" OD	
014087	2-1/2"	2-5/8" OD	
014349	3"	3-1/8" OD	
032446	4"	4-1/8" OD	

90° Close Rough Elbow (C x C)



Part #	Nom Size	OD Size	Price
013672	1/8"	1/4" OD	
013503	1/4"	3/8" OD	
015023	3/8"	1/2" OD	
013118	1/2"	5/8" OD	
020819	5/8"	3/4" OD	
014691	3/4"	7/8" OD	
012229	1"	1-1/8" OD	
012821	1-1/4"	1-3/8" OD	
012451	1-1/2"	1-5/8" OD	
013821	2"	2-1/8" OD	
014092	2-1/2"	2-5/8" OD	
014354	3"	3-1/8" OD	
015228	4"	4-1/8" OD	

Copper Pressure Fittings

90° Close Rough Reducing Elbow (C x C)



Part #	Nom Size	OD Size	Price
013273	1/2" x 1/4"	5/8" OD x 3/8" OD	
014823	3/4" x 1/2"	7/8" OD x 5/8" OD	
012438	1" x 1/2"	1-1/8" OD x 5/8" OD	
013423	1" x 3/4"	1-1/8" OD x 7/8" OD	
012631	1-1/2" x 1-1/4"	1-5/8" OD x 1-3/8" OD	

90° Close Rough Street Elbow (Ftg x C)



Part #	Nom Size	OD Size	Price
013498	1/4"	3/8" OD	
015018	3/8"	1/2" OD	
013113	1/2"	5/8" OD	
015568	5/8"	3/4" OD	
014686	3/4"	7/8" OD	
012224	1"	1-1/8" OD	
012815	1-1/4"	1-3/8" OD	
012445	1-1/2"	1-5/8" OD	
013816	2"	2-1/8" OD	
014195	2-1/2"	2-5/8" OD	
014350	3"	3-1/8" OD	
015225	4"	4-1/8" OD	

90° Long Radius Elbow (C x C)



Part #	Nom Size	OD Size	Price
013485	1/4"	3/8" OD	
015002	3/8"	1/2" OD	
013086	1/2"	5/8" OD	
015562	5/8"	3/4" OD	
014661	3/4"	7/8" OD	
015768	7/8"	1" OD	

Wrot Copper Pressure Fittings (Continued)

90° Long Radius Elbow (C x C)

Part #	Nom Size	OD Size	Price
012213	1"	1-1/8" OD	
012803	1-1/4"	1-3/8" OD	
012432	1-1/2"	1-5/8" OD	
013807	2"	2-1/8" OD	
026335	2-1/2"	2-5/8" OD	

90° Long Radius Street Elbow (Ftg x C)



Part #	Nom Size	OD Size	Price
038358	1/4"	3/8" OD	
015001	3/8"	1/2" OD	
013085	1/2"	5/8" OD	
014290	5/8"	3/4" OD	
014660	3/4"	7/8" OD	
012212	1"	1-1/8" OD	
012802	1-1/4"	1-3/8" OD	
012431	1-1/2"	1-5/8" OD	
013806	2"	2-1/8" OD	
029652	2-1/2"	2-5/8" OD	

Return Bend (C x C)



Part #	Size	Price
014681	3/4" x 2-1/2"	

Fitting Reducer (Ftg x C)



Part #	Nom Size	OD Size	Price
013568	1/4" x 1/8"	3/8" x 1/4"	
015086	3/8" x 1/4"	1/2" x 3/8"	
013270	1/2" x 1/4"	5/8" x 3/8"	
013335	1/2" x 3/8"	5/8" x 1/2"	
023361	5/8" x 1/2"	3/4" x 5/8"	
014815	3/4" x 1/2"	7/8" x 5/8"	

Copper Pressure Fittings

Wrot Copper Pressure Fittings (Continued)

Fitting Reducer (Ftg x C)

Part #	Nom Size	OD Size	Price
014933	3/4" x 5/8"	7/8" x 3/4"	
012417	1" x 1/2"	1-1/8" x 5/8"	
013418	1" x 3/4"	1-1/8" x 7/8"	
012936	1-1/4" x 1/2"	1-3/8" x 5/8"	
012974	1-1/4" x 3/4"	1-3/8" x 7/8"	
012889	1-1/4" x 1"	1-3/8" x 1-1/8"	
012661	1-1/2" x 1/2"	1-5/8" x 5/8"	
012704	1-1/2" x 3/4"	1-5/8" x 7/8"	
012564	1-1/2" x 1"	1-5/8" x 1-1/8"	
012623	1-1/2" x 1-1/4"	1-5/8" x 1-3/8"	
014072	2" x 1/2"	2-1/8" x 5/8"	
014250	2" x 3/4"	2-1/8" x 7/8"	
013960	2" x 1"	2-1/8" x 1-1/8"	
014040	2" x 1-1/4"	2-1/8" x 1-3/8"	
013990	2" x 1-1/2"	2-1/8" x 1-5/8"	
014142	2-1/2" x 1-1/4"	2-5/8" x 1-3/8"	
014132	2-1/2" x 1-1/2"	2-5/8" x 1-5/8"	
014150	2-1/2" x 2"	2-5/8" x 2-1/8"	
014482	3" x 1-1/2"	3-1/8" x 1-5/8"	
014520	3" x 2"	3-1/8" x 2-1/8"	
014556	3" x 2-1/2"	3-1/8" x 2-5/8"	
015385	4" x 2"	4-1/8" x 2-1/8"	
015428	4" x 3"	4-1/8" x 3-1/8"	
015465	4" x 3-1/2"	4-1/8" x 3-5/8"	

Tube Strap - Two-Hole



Part #	Size	Price
013500	1/4" OD	
015020	3/8" OD	
013115	1/2" OD	
014688	3/4" OD	
012226	1" OD	
012810	1-1/4" OD	
012448	1-1/2" OD	
013818	2" OD	

Tee (C x C x C)



Part #	Nom Size	OD Size	Price
013499	1/4"	3/8" OD	
015019	3/8"	1/2" OD	
013114	1/2"	5/8" OD	
015569	5/8"	3/4" OD	
014687	3/4"	7/8" OD	
012225	1"	1-1/8" OD	
012817	1-1/4"	1-3/8" OD	
012447	1-1/2"	1-5/8" OD	
014089	2-1/2"	2-5/8" OD	
014351	3"	3-1/8" OD	
015226	4"	4-1/8" OD	

Bullhead Tee (C x C x C)



Part #	Nom Size	OD Size	Price
015142	3/8" x 1/2"	1/2" x 5/8"	
013254	1/2" x 3/4"	5/8" x 7/8"	
014889	3/4" x 1"	7/8" x 1-1/8"	
012341	1" x 1-1/4"	1-1/8" x 1-3/8"	
012339	1" x 1-1/2"	1-1/8" x 1-5/8"	
012602	1-1/2" x 2"	1-5/8" x 2-1/8"	

Reducing Tee (C x C x C)



Part #	Nom Size	OD Size	Price
013358	1/2" x 3/8" x 3/8"	5/8" x 1/2" x 1/2"	
013250	1/2" x 1/4"	5/8" x 3/8"	
013257	1/2" x 3/8"	5/8" x 1/2"	
014837	3/4" x 1/2" x 1/2"	7/8" x 5/8" x 5/8"	
014841	3/4" x 1/2" x 3/4"	7/8" x 5/8" x 7/8"	
014902	3/4" x 3/8"	7/8" x 1/2"	
014895	3/4" x 1/2"	7/8" x 5/8"	
012665	1" x 1/2" x 1/2"	1-1/8" x 5/8" x 5/8"	
012708	1" x 1/2" x 3/4"	1-1/8" x 5/8" x 7/8"	
012568	1" x 1/2" x 1"	1-1/8" x 5/8" x 1-1/8"	

Copper Pressure Fittings

Wrot Copper Pressure Fittings (Continued) Reducing Tee (C x C x C)

Part #	Nom Size	OD Size	Price
013438	1" x 3/4" x 1/2"	1-1/8" x 7/8" x 5/8"	
013442	1" x 3/4" x 3/4"	1-1/8" x 7/8" x 7/8"	
013434	1" x 3/4" x 1"	1-1/8" x 7/8" x 1-1/8"	
012345	1" x 1/2"	1-1/8" x 5/8"	
012744	1" x 3/4"	1-1/8" x 7/8"	
043373	1-1/4" x 1-1/2"	1-3/8" x 1-5/8"	
014053	1-1/4" x 1/2" x 1-1/4"	1-3/8" x 5/8" x 1-3/8"	
012986	1-1/4" x 3/4" x 1/2"	1-3/8" x 7/8" x 5/8"	
012989	1-1/4" x 3/4" x 3/4"	1-3/8" x 7/8" x 7/8"	
012984	1-1/4" x 3/4" x 1"	1-3/8" x 7/8" x 1-1/8"	
020820	1-1/4" x 3/4" x 1-1/4"	1-3/8" x 7/8" x 1-3/8"	
012914	1-1/4" x 1" x 1/2"	1-3/8" x 1-1/8" x 5/8"	
012949	1-1/4" x 1" x 3/4"	1-3/8" x 1-1/8" x 7/8"	
012907	1-1/4" x 1" x 1"	1-3/8" x 1-1/8" x 1-1/8"	
012910	1-1/4" x 1" x 1-1/4"	1-3/8" x 1-1/8" x 1-3/8"	
012925	1-1/4" x 1/2"	1-3/8" x 5/8"	
012930	1-1/4" x 3/4"	1-3/8" x 7/8"	
012920	1-1/4" x 1"	1-3/8" x 1-1/8"	
012673	1-1/2" x 1/2" x 1-1/2"	1-5/8" x 5/8" x 1-5/8"	
012720	1-1/2" x 3/4" x 3/4"	1-5/8" x 7/8" x 7/8"	
012716	1-1/2" x 3/4" x 1"	1-5/8" x 7/8" x 1-1/8"	
012719	1-1/2" x 3/4" x 1-1/4"	1-5/8" x 7/8" x 1-3/8"	
012718	1-1/2" x 3/4" x 1-1/2"	1-5/8" x 7/8" x 1-5/8"	
012588	1-1/2" x 1" x 1/2"	1-5/8" x 1-1/8" x 5/8"	
012675	1-1/2" x 1" x 3/4"	1-5/8" x 1-1/8" x 7/8"	
012583	1-1/2" x 1" x 1"	1-5/8" x 1-1/8" x 1-1/8"	
012585	1-1/2" x 1" x 1-1/2"	1-5/8" x 1-1/8" x 1-5/8"	
012655	1-1/2" x 1-1/4" x 3/4"	1-5/8" x 1-3/8" x 7/8"	
012644	1-1/2" x 1-1/4" x 1"	1-5/8" x 1-3/8" x 1-1/8"	
012649	1-1/2" x 1-1/4" x 1-1/4"	1-5/8" x 1-3/8" x 1-3/8"	
026358	1-1/2" x 1-1/4" x 1-1/2"	1-5/8" x 1-3/8" x 1-5/8"	
012599	1-1/2" x 1/2"	1-5/8" x 5/8"	
012605	1-1/2" x 3/4"	1-5/8" x 7/8"	
012591	1-1/2" x 1"	1-5/8" x 1-1/8"	
012595	1-1/2" x 1-1/4"	1-5/8" x 1-3/8"	
014153	2" x 1/2" x 2"	2-1/8" x 5/8" x 2-1/8"	
014258	2" x 3/4" x 2"	2-1/8" x 7/8" x 2-1/8"	
013978	2" x 1" x 1"	2-1/8" x 1-1/8" x 1-1/8"	
014088	2" x 1" x 2"	2-1/8" x 1-1/8" x 2-1/8"	
014049	2" x 1-1/4" x 1"	2-1/8" x 1-3/8" x 1-1/8"	
014051	2" x 1-1/4" x 1-1/4"	2-1/8" x 1-3/8" x 1-3/8"	
014054	2" x 1-1/4" x 2"	2-1/8" x 1-3/8" x 2-1/8"	
014052	2" x 1-1/2" x 1/2"	2-1/8" x 1-5/8" x 5/8"	
014034	2" x 1-1/2" x 3/4"	2-1/8" x 1-5/8" x 7/8"	

Wrot Copper Pressure Fittings (Continued) Reducing Tee (C x C x C)

Part #	Nom Size	OD Size	Price
014015	2" x 1-1/2" x 1"	2-1/8" x 1-5/8" x 1-1/8"	
014026	2" x 1-1/2" x 1-1/4"	2-1/8" x 1-5/8" x 1-3/8"	
014020	2" x 1-1/2" x 1-1/2"	2-1/8" x 1-5/8" x 1-5/8"	
014031	2" x 1-1/2" x 2"	2-1/8" x 1-5/8" x 2-1/8"	
014233	2" x 1/2"	2-1/8" x 5/8"	
014238	2" x 3/4"	2-1/8" x 7/8"	
014213	2" x 1"	2-1/8" x 1-1/8"	
014227	2" x 1-1/4"	2-1/8" x 1-3/8"	
014221	2" x 1-1/2"	2-1/8" x 1-5/8"	
013817	2"	2-1/8" OD	
014139	2-1/2" x 1-1/2" x 2"	2-5/8" x 1-5/8" x 2-1/8"	
064485	2-1/2" x 2" x 3/4"	2-5/8" x 2-1/8" x 7/8"	
014161	2-1/2" x 2" x 1"	2-5/8" x 2-1/8" x 1-1/8"	
014162	2-1/2" x 2" x 1-1/4"	2-5/8" x 2-1/8" x 1-3/8"	
021097	2-1/2" x 2" x 1-1/2"	2-5/8" x 2-1/8" x 1-5/8"	
014175	2-1/2" x 2" x 2"	2-5/8" x 2-1/8" x 2-1/8"	
014170	2-1/2" x 1/2"	2-5/8" x 5/8"	
014174	2-1/2" x 3/4"	2-5/8" x 7/8"	
014165	2-1/2" x 1"	2-5/8" x 1-1/8"	
014169	2-1/2" x 1-1/4"	2-5/8" x 1-3/8"	
014167	2-1/2" x 1-1/2"	2-5/8" x 1-5/8"	
014172	2-1/2" x 2"	2-5/8" x 2-1/8"	
014566	3" x 2" x 2"	3-1/8" x 2-1/8" x 2-1/8"	
057309	3" x 2" x 3"	3-1/8" x 2-1/8" x 2-1/8"	
064483	3" x 2-1/2" x 2"	3-1/8" x 2-5/8" x 2-1/8"	
014586	3" x 1/2"	3-1/8" x 5/8"	
014599	3" x 3/4"	3-1/8" x 7/8"	
014575	3" x 1"	3-1/8" x 1-1/8"	
014579	3" x 1-1/2"	3-1/8" x 1-5/8"	
014593	3" x 2"	3-1/8" x 2-1/8"	
014598	3" x 2-1/2"	3-1/8" x 2-5/8"	
021514	4" x 1-1/4"	4-1/8" x 1-3/8"	
026854	4" x 3"	4-1/8" x 3-1/8"	

Copper Union (C x C)



Part #	Size	Price
013116	1/2"	
014689	3/4"	
012227	1"	

Copper Pressure Fittings

Wrot Copper Pressure Fittings (Continued)

Copper Union (C x C)

Part #	Size		Price
012818	1-1/4"	1-3/8"OD	
012449	1-1/2"	1-5/8"OD	
013819	2"	2-1/8"OD	



Preformed Copper for Sweat

Sweat Bullet™ No Lead Spin Closed Stub-Out

- *Stub Out* – Turn your variable job site costs into fixed job costs 
- *Stub Out* – Reduce job site and shop costs such as measuring, cutting, cleaning, fluxing, assembling and soldering
- *Stub Out* – 1-1/4" – 2" CTS Bullets available for quote
- *Stub Out* – accepts sweat, push-fitting and compression valves
- *Polished Nickel-Plated (N)* – Eliminates the need for sleeving or tinning and solders with standard flux
- *Bracketed Stub Out* – Perfect for stubbing up through the floor for closets or lavs
- *Bracketed Stub Out* – Square O Strap is crimped to tube 12" from each end

Part #	Mfg #	Copper Type	CTS	Length	Price
027594	622-L08N	L	1/2"	8"	
108531	622-L12	L	1/2"	12"	
027595	622-M06	M	1/2"	6"	
183717	622-M06PK	M	1/2"	6"	
183718	622-M08	M	1/2"	8"	
183719	622-M12	M	1/2"	12"	
183720	622-M15	M	1/2"	15"	
183721	623-L06	L	3/4"	6"	
135659	624-L24	L	1"	24"	

No Lead Offset Riser Fitting

- Saves three solder joints
- Made from type L copper tube 

Part #	Mfg #	MSwt x FSwt	Price
226820	616-15	1/2" x 1/2"	

No Lead Stub-Out Elbow



- L copper
- A stub-out, cap and elbow in one full flow fitting—even better time saver than straight stub outs
- Full flow—no restrictions
- Accepts sweat, push-fitting and compression valves
- Square O Strap is crimped onto tube for solid attachment to bracket or stub

Female Swt with Square O Strap™

Part #	Mfg #	Conn.	Size	Radius	Price
140267	609-L246E	1/2" CTS	3-1/2" x 6"	1-1/4"	

Female Sweat

Part #	Mfg #	Conn.	Size	Radius	Price
183526	609-L246	1/2" CTS	3-1/2" x 6"	1-1/4"	

Tub Spout Elbow



- 1-1/4" Radius fits all valve rough-ins
- 1/2" CTS Connection
- **Male sweat** with square o strap or with wall block plate—Connect tub valve to spout nipple in one easy step—Square o strap & wall block are crimped to tube
- **MIP Swivel:**—No soldering with easy swivel thread installation
- **Fixed MIP:** with or without wall block plate—No soldering with male thread connection
- **FIP Swivel:**—No soldering with easy swivel thread installation—Do **NOT** use pipe dope or teflon tape on FIP threads

Male Sweat (MSwt x 1/2" CTS)

Part #	Mfg #	Size	Price
020710	613-57	5" x 7"	
181707	613-67	6" x 7"	
089057	613-87	8" x 7"	

Male Sweat with Wall Block (MSwt x 1/2" CTS)

Part #	Mfg #	Size	Price
116056	612-57	5" x 7"	

FIP Swivel (FIP x 1/2" CTS)

Part #	Mfg #	Size	Price
183528	613-57Y	5" x 7"	

Copper Pressure Fittings

Copper Star™ Tube Locking Nut

- 20 Gauge solid copper
- Slides over and locks copper tube into place
- Prevents tube from sliding backward



Part #	Mfg #	I.D. x O.D.	Price
064577	612-2	1/2" CTS x 2" Tube Nut	

Shower WallNut™ Showerarm Adapter

- Bagged
- Stub out to shower arm connection is made outside the finished wall.
- No hidden leaks behind the wall that promote mold growth
- Stub out with copper tube, just like other fixtures
- No pipe seal tape or pipe joint compound needed on shower arm threads



Part #	Mfg #	Escutcheon	Price
064892	616-02C	Chrome-Plated Steel	
168816	616-02RB	Oil-Rubbed Bronze	
183716	616-02SN	Satin Nickel	

Shower-Lock Tub/Shower Elbow

- Locknut threads can be trimmed after installation
- Internal 1/2" FIP thread for shower arm or tub nipple
- For use on shower risers, tub spouts and non-pressure fitting applications



Part #	Mfg #	FSwt x FIP	Price
067264	616-2	1/2" x 1/2"	

Full-Slip Sweat Repair Couplings with Sweat Connection

- Perfect for repair of coldhot water lines



Part #	Mfg #	Slips Over	Length	Price
064578	600-212	1/2" CTS	12"	
183521	600-212PK	1/2" CTS	12"	
064580	600-312	3/4" CTS	12"	
183522	600-312PK	3/4" CTS	12"	

WalLet™ Wall Termination Fitting

- One-piece, forged brass fitting with rigid mounting plate
- Secure loose or fragile wall penetrations reduce the risk of leaks
- Ideal for back mounted faucets, sillcocks, threaded stops, shower rain heads, body-spray systems, and pot fillers



Part #	Mfg #	MIP x FSwt	Price
169164	615-214	1/2" x 1/2"	

Copper PEX Fittings

PowerPEX® F1807 PEX Crimp Ring

- Pure, annealed copper rings
- For use with PEX SDR-9 piping only
- Do not use with PB pipe



Part #	Mfg #	Size	Price
168712	649X1	3/8" PEX	
069180	649X2	1/2" PEX	
069181	649X3	3/4" PEX	
095776	649X4	1" PEX	

PowerPEX® F1380 X F1807 Straight Adapter

- One-piece solid copper
- F1380 No lead polybutylene x F1807 copper coupling with crimp rings
- Great for adapting PB lines to new PEX lines
- Each adapter is bagged with one natural copper PB crimp ring and one black copper PEX crimp ring



Part #	Mfg #	PB x PEX	Price
180443	645X2GPK2	1/2" x 1/2"	

PowerPEX® F1807 V-Sleeve™ Compression System

- V-Sleeves are to be used with ASTM F1807 and F2159 PEX fittings in conjunction with any SDR 9 PEX tubing manufactured to the ASTM F876 or ASTM F877
- Visibility of tube fully inserted in sleeve and to tube stop on fitting
- 360° Visibility of crimped sleeve
- Sleeve can be pre-loaded onto fitting
- 360° Compression on all sealing surface areas
- V-Sleeve must be installed using a Sioux Chief 305-8_TX compression tool
- Third-party tested to ASTM F877



Part #	Mfg #	Size	Material	Price
149259	649TX2	1/2"	Stainless Steel	
149260	649TX3	3/4"	Stainless Steel	

Copper Pressure Fittings

Copper PEX Fittings (Continued)

PowerPEX® F1807 V-Sleeve™ Compression System

Part #	Mfg #	Size	Material	Price
166407	649TX4	1"	Stainless Steel	

Standard Stub-Out Elbow

- Polished nickel-plated
- Accepts sweat and compression valves
- Combines easy adapting of copper stub-outs with easy installation of PEX systems



Part #	Mfg #	Connection	CTS	Length	Price
085711	630X248	1/2" PEX	1/2"	8"	

Square O Strap™ Stub-Out Elbow (F1807 PEX)

- Accepts sweat and compression valves
- Combines easy adapting of copper stub-outs with easy installation of PEX systems
- Affix easily to edge bracket or any backing board to provide solid installations

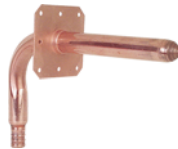

Part #	Mfg #	Connection	CTS	Length	Price
085262	630X248E	1/2" PEX	1/2"	8"	

PowerPEX F1807 Bullet™ Lead Free Stub-Out

- **Spin closed stub out**
—Type L copper
- **Bracketed stub out**
—Perfect for stubbing through floor for closets or lavs
—Square O Strap is crimped to tube 8" from spin closed end on 638X212E
—Type L copper
- **Open ended stub out**
—Type L copper



638X208

Part #	Mfg #	PEX	CTS	Stub Out	Price
085263	638X208	1/2"	1/2"	Spin Closed	
178326	638X212E	1/2"	1/2"	Bracketed	
183740	638X312	3/4"	3/4"	Spin Closed	

PowerPEX® F1807 Copper Straight Adapter

- One-piece solid copper
- No lead



643X2

Part #	Mfg #	Connection	Price
147608	643X2	1/2" PEX x 1/2" MSwt	

Copper PEX Fittings (Continued)

PowerPEX® F1807 Copper Straight Adapter

Part #	Mfg #	Connection	Price
153540	643X3	3/4" PEX x 3/4" MSwt	
153538	643X4	1" PEX x 1" MSwt	
153539	643X43	3/4" PEX x 1" MSwt	

PowerPEX® F1807 Tub/Shower Pressure Connector

- Perfect for sweat connection to standard tub and shower valves
- MIP & FIP Swivel connections means no torch at the tub and shower valve
- Made from Type L copper tube
- Elongated tailpiece allows for rigid bracket attachment



Part #	Mfg #	Connection	Price
085461	632X243	1/2" F1807 PEX x 1/2" MSwt	

PowerPEX® F1807 Elbow Adapter

- Great multipurpose sweat x PEX elbow
- One-piece solid copper



632X225

Part #	Mfg #	Connection	Price
169181	632X122	3/8" F1807 PEX x 1/2" MSwt	
080419	632X222	1/2" F1807 PEX x 1/2" MSwt	
093142	632X225	1/2" F1807 PEX x 1/2" FSwt	

PowerPEX® F1960 Standard Stub-Out Elbow

- No lead
- Accepts sweat, push-fitting and compression valves
- Combines easy adapting of copper stub-outs with easy installation of F1960 PEX system



630WG248

Part #	Mfg #	PEX	CTS	Size	Radius	Price
168028	630WG248	1/2"	1/2"	4" x 8"	1-1/4"	
168039	630WG348	3/4"	3/4"	6" x 8"	1-3/4"	
185555	630WG4612	1"	1"	6" x 12"	2"	

Copper Pressure Fittings

PowerPEX® F1960 Standard Stub-Out Elbow (Square O Strap—No Lead)

- Accepts sweat, push-fitting and compression valves
- Combines easy adapting of copper stub-outs with easy installation of F1960 PEX system
- Square O Straps affix easily to the Edge bracket or any backing board to provide solid installations
—Straps are identical to radius size
- Multiple mounting holes allow for installations on sides, bottom, or top



630WG248E

Part #	Mfg #	PEX	CTS	Size	Radius	Price
164830	630WG348E	3/4"	3/4"	6" x 8"	1-3/4"	
164828	630WG4612E	1"	1"	6" x 12"	2"	

PowerPEX® F1960 No Lead Bullet™ Stub-Out

- Standard spin closed
- Type L copper
- Accepts sweat, push-fitting and compression valves



638WG215

Part #	Mfg #	F1960 PEX	CTS	Length	Price
173519	638WG208	1/2"	1/2"	8"	
173858	638WG215	1/2"	1/2"	15"	

PowerPEX® F1807 Stub-Out Elbow—No Lead

- **Standard**
— Accepts sweat, push-fitting and compression valves
— Combines easy adapting of copper stub-outs with easy installation of PEX system
— One piece Type L Copper
— Tube stops formed into each fitting
- **Polish Nickel-Plated**
— Push-fitting systems are not compatible with nickel-plated stub out elbows

Standard

Part #	Mfg #	PEX/CTS	Size	Radius	Price
183724	630X146	3/8"/1/2"	3-1/2"x6"	1-1/4"	
183727	630x468	1"/1"	6"x12"	2"	

PowerPEX® F1807 Square O Strap Stub-Out Elbow

- Accepts sweat, push-fitting and compression valves w/ Type L Copper
- Combines easy adapting of copper stub-outs with easy installation of PEX system
- Square O Straps affix easily to the edge bracket or any backing board to provide solid installations
- Rad. = radius



630X246E

Part #	Mfg #	PEX CTS	Size	Rad.	Strap	Price
183726	630X246E	(1/2")	4" x 12"	1-1/4"	1-3/4"	

Copper PEX Fittings (Continued)

PowerPEX® F1807 Square O Strap Stub-Out Elbow

Part #	Mfg #	PEX CTS	Size	Rad.	Strap	Price
224229	630X348E	(3/4")	4-1/2"x8"	1-3/4"	2"	

PowerPEX F1960 Tub/Shower Pressure Connector

- Perfect for sweat connection to standard tub/shower valves
- MIP and FIP swivel connections no torch at the tub/shower valve
- Type L Copper / 1-1/4" radius
- Elongated tailpiece allows for rigid bracket attachment



632WG263

Part #	Mfg #	Connection	Size	Price
183728	632WG263	(1/2") PEX x MSwt	6" x 2-1/4"	



Copper Wrot Pressure Stub-Outs

Air Chamber or Stub-Out



Part #	Mfg #	Size	Price
013390	620	1/2" x 8"	

45° Elbow (C x C)



Part #	Mfg #	Size	Price
032033	606	1/8"	
026847	606	6"	

90° Elbow Close Rough (C x C)



Part #	Mfg #	Size	Price
026848	607	6"	

Pipe Fittings

Copper Pressure Fittings

90° Elbow Long Radius
(C x C)



Part #	Mfg #	Size	Price
162191	607-LT	1/8"	

Reducing Coupling
(C x C)



Part #	Mfg #	Size	Price
075910	600R	5/8" x 3/8"	
026850	600R	6" x 4"	

Tee
(C x C x C)



Part #	Mfg #	Size	Price
033622	611-BH	1-1/4" x 1-1/4" x 2"	
054575	611	6"	

Tube Cap
(C x C)



Part #	Mfg #	Size	Price
089592	617	5/8"	

Pipe Fittings



Copper Fittings - Cleaned & Bagged

Copper Kleen-Fit™ Pressure Fittings

101-R Copper Reducing Coupling with Stop (C x C)



Part #	Mfg #	Size	OD Size	Price
115470	10230697	1/2" x 3/8"	5/8" x 1/2"	
127002	10230719	3/4" x 3/8"	7/8" x 1/2"	

104 Copper Male Adapter (C x M)



Part #	Mfg #	Size	OD Size	Price
130414	10230312	1/2"	5/8" x 1/2"	

107-C Copper 90° Close Rough Elbow (C x C)



Part #	Mfg #	Size	OD Size	Price
084695	10231289	3/4"	7/8"	

118 Copper Reducer Fitting (Ftg x C)



Part #	Mfg #	Size	OD Size	Price
100335	10232065	3/4" x 1/2"	7/8" x 5/8"	



Wrot Copper Pressure Fittings

Tube Cap (C) - Cleaned/Bagged



Part #	Nom Size	OD Size	Price
091183	1/2"	5/8" OD	
093869	3/4"	7/8" OD	
100329	1"	1-1/8" OD	

Coupling with Dimpled Stops (C x C) - Cleaned/Bagged



Part #	Nom Size	OD Size	Price
084721	1/2"	5/8" OD	
084698	3/4"	7/8" OD	
084621	1"	1-1/8" OD	

Reducing Coupling (C x C) - Cleaned/Bagged (1)



Part #	Nom Size	OD Size	Price
106355	1" x 1/2"	1-1/8" x 5/8"	

Reducing Coupling (C x C) - Cleaned/Bagged



Part #	Nom Size	OD Size	Price
106376	3/4" x 1/2"	7/8" x 5/8"	
106377	1" x 1/2"	1-1/8" x 5/8"	
106380	1" x 3/4"	1-1/8" x 7/8"	

45° Elbow (C x C) - Cleaned/Bagged



Part #	Nom Size	OD Size	Price
102458	1/2"	5/8" OD	
102455	3/4"	7/8" OD	
084624	1"	1-1/8" OD	

45° Elbow (Ftg x C) - Cleaned/Bagged



Part #	Nom Size	OD Size	Price
106450	1/2"	5/8" OD	
104396	3/4"	7/8" OD	

Pipe Fittings

Copper Fittings - Cleaned & Bagged

Wrot Copper Pressure Fittings (Continued)

45° Elbow (Ftg x C) - Cleaned/Bagged

Part #	Nom Size	OD Size	Price
106451	1"	1-1/8" OD	

90° Elbow (C x C) - Cleaned/Bagged



Part #	Nom Size	OD Size	Price
084705	1/2"	5/8" OD	
084617	1"	1-1/8" OD	

90° Close Rough Elbow (Ftg x C) - Cleaned/Bagged



Part #	Nom Size	OD Size	Price
106455	1/2"	5/8" OD	
104395	3/4"	7/8" OD	
106456	1"	1-1/8" OD	

90° Long Radius Elbow (C x C) - Cleaned/Bagged



Part #	Nom Size	OD Size	Price
097945	1"	1-1/8" OD	

Tee (C x C x C) - Cleaned/Bagged



Part #	Nom Size	OD Size	Price
084757	1/2"	5/8" OD	
084701	3/4"	7/8" OD	
084714	3/4" x 1/2"	7/8" x 5/8"	
084715	3/4" x 1/2" x 1/2"	7/8" x 5/8" x 5/8"	
084758	3/4" x 1/2" x 3/4"	7/8" x 5/8" x 7/8"	

Wrot Copper Pressure Fittings (Continued)

Tee (C x C x C) - Cleaned/Bagged

Part #	Nom Size	OD Size	Price
084710	1"	1-1/8" OD	
106469	1" x 1/2" x 3/4"	1-1/8" x 5/8" x 7/8"	
100339	1" x 1/2" x 1"	1-1/8" x 5/8" x 1-1/8"	
084731	1" x 3/4" x 1/2"	1-1/8" x 7/8" x 5/8"	
084716	1" x 1/2"	1-1/8" x 5/8"	
106466	1-1/2"	1-5/8" OD	
106500	2" x 1" x 2"	2-1/8" x 1-1/8" x 2-1/8"	
100343	2" x 1"	2-1/8" x 1-1/8"	



Copper DWV Fittings

Copper QTite™ Push-Fit Fittings

- Joins copper and CPVC tube from 1/2" to 2"
- Joins PEX tube from 1/2" to 1"
- Operating temperature: 0° to 250°F
- Maximum working pressure: 200 psi
- True "o-ring" design for leak free seals
- Pre-lubed for quick installation



904 QTite™ Male Adapter (C x M)

Part #	Mfg #	Size	Price
012679	904	1-1/2"	



Cast Brass DWV Fittings

Cast Brass Marvel Threaded Adapter (C x SJ)



Part #	Size	Price
012435	1-1/2"	

Cast Brass Cleanout with Plug (Ftg x Cleanout)



Part #	Size	Price
012455	1-1/2"	
013774	2"	

Cast Brass Test Tee with Plug (C x C x Cleanout)



Part #	Size	Price
012409	1-1/2"	
013784	2"	

Cast Brass P-Trap (C x C)



Part #	Size	Price
012404	1-1/2"	
013776	2"	

Cast Copper Return Bend (C x C)



Part #	Size	Price
013777	2"	

Wrot DWV Copper Fittings

Wrot Copper Trap Adapter (Ftg x SJ)



Part #	Size	Price
012419	1-1/2" x 1-1/2" OD	

Wrot Copper Trap Adapter (C x SJ)



Part #	Size	Price
012809	1-1/4" x 1-1/4" OD	
012630	1-1/2" x 1-1/4" OD	
012441	1-1/2" x 1-1/2" OD	

Wrot Copper Threaded Adapter (C x FIP)



Part #	Size	Price
012783	1-1/4"	
012403	1-1/2"	

Pipe Fittings

Copper DWV Fittings

Wrot DWV Copper Fittings (Continued)

Wrot Copper Threaded Adapter (C x FIP)

Part #	Size	Price
013773	2"	

Wrot Copper Threaded Adapter (C x MIP)



Part #	Size	Price
012784	1-1/4"	
013775	2"	

Wrot Copper Coupling (C x C)



Part #	Size	Price
012782	1-1/4"	
012617	1-1/2" x 1-1/4"	
012402	1-1/2"	
013986	2" x 1-1/2"	
013772	2"	
014320	3"	

Wrot Copper Reducing Coupling (Ftg x C)



Part #	Size	Price
012618	1-1/2" x 1-1/4"	
013987	2" x 1-1/2"	
014519	3" x 2"	

Wrot Copper Repair Coupling (C x C)



Part #	Size	Price
013068	1-1/2"	
013779	2"	

Wrot Copper 22-1/2° Elbow (C x C)



Part #	Size	Price
012689	1-1/2"	
013786	2"	

Wrot Copper 45° Elbow (C x C)



Part #	Size	Price
012790	1-1/4"	
012411	1-1/2"	
013787	2"	
014331	3"	

Wrot Copper 45° Elbow (Ftg x C)



Part #	Size	Price
012785	1-1/4"	
012405	1-1/2"	
013780	2"	
014325	3"	

Copper DWV Fittings

Wrot Copper 90° Elbow (C x C)



Part #	Size	Price
012791	1-1/4"	
012412	1-1/2"	
013788	2"	
014333	3"	

Wrot Copper 90° Elbow (Ftg x C)



Part #	Size	Price
012786	1-1/4"	
012406	1-1/2"	
013781	2"	

Wrot Copper 45° Wye (C x C x C)



Part #	Size	Price
012410	1-1/2"	
014219	2" x 1-1/2"	
013785	2"	

Wrot Copper Sanitary Tee (C x C x C)



Part #	Size	Price
012787	1-1/4"	
012619	1-1/2" x 1-1/4"	

Wrot DWV Copper Fittings (Continued)

Wrot Copper Sanitary Tee (C x C x C)

Part #	Size	Price
012407	1-1/2"	
014018	2" x 1-1/2" x 1-1/2"	
014029	2" x 1-1/2" x 2"	
014039	2" x 1-1/4"	
014218	2" x 1-1/2"	
013782	2"	
014327	3"	

Wrot Copper Test Cap (C)



Part #	Size	Price
012788	1-1/4"	
012408	1-1/2"	
013783	2"	



Wrot DWV Copper Fittings

Wrot Copper Test Cap (C)



Part #	Mfg #	Size	Price
027855	917B	1/2"	
027856	917B	3/4"	

Wrot Copper Trap Adapter (Ftg x SJ)



Part #	Mfg #	Size	Price
012624	901-2-7R	1-1/2" x 1-1/4" OD	

Pipe Fittings

Copper DWV Fittings

Wrot Copper Trap Adapter (FIP x SJ)



Part #	Mfg #	Size	Price
029419	903-7	1-1/2" x 1-1/4" OD	
044826	903-7	1-1/2" x 1-1/2" OD	

Wrot Copper Trap Adapter (MIP x SJ)

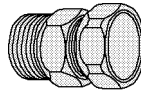

Part #	Mfg #	Size	Price
035755	904-7	1-1/4" x 1-1/4" OD	
029421	904-7	1-1/2" x 1-1/2" OD	

Wrot Copper Threaded Adapter (C x MIP)



Part #	Mfg #	Size	Price
019463	904	1-1/2" x 1-1/4"	

Cast Copper DWV Fittings

Cast Copper Threaded Piece Adapter (C x MIP)



Part #	Mfg #	Size	Price
023821	802-F	1-1/4"	
020249	802-F	2"	

Cast Copper Threaded Adapter (C x MIP)



Part #	Mfg #	Size	Price
108622	804	1-1/2"	
108608	804	2"	

Cast Copper Double Tee (C x C x C x C)



Part #	Mfg #	Size	Price
029192	835R	2" x 2" x 1-1/2" x 1-1/2"	
065471	835	2"	

Cast Copper 45° Wye (C x C x C)



Part #	Mfg #	Size	Price
104417	810	1-1/4"	



DWV Fittings

DWV Slip Joint Adapter

- Brass marvel thread
- Sweat on to copper DWV pipe to make slip joint connections



Part #	FSwt x Slip Joint Thread	Price
183382	1-1/4" x 1-1/4"	
183383	1-1/2" x 1-1/2"	
183384	2" x 2"	

Pipe Fittings



CPVC Schedule 80 Fittings

CPVC Sch 80 Fittings

CPVC Sch 80 Special Reinforced Female Adapter (Soc x SR FIPT)

Part #	Mfg #	Size	Price
118045	835-007CSR	3/4"	
118046	835-010CSR	1"	
112907	835-015CSR	1-1/2"	
104189	835-020CSR	2"	
112908	835-030CSR	3"	
077816	835-040CSR	4"	

CPVC Sch 80 Male Adapter (Soc x MIPT)



Part #	Mfg #	Size	Price
056489	836-005C	1/2"	
086755	836-010C	1"	
088827	836-015C	1-1/2"	
103244	836-020C	2"	
112919	836-060C	6"	

CPVC Sch 80 Reducer Bushing Flush Style (Soc x Spgt)

Part #	Mfg #	Size	Price
137626	837-101C	3/4" x 1/2"	
112922	837-166C	1-1/4" x 1/2"	
112924	837-168C	1-1/4" x 1"	
112926	837-210C	1-1/2" x 3/4"	
112931	837-249C	2" x 1"	
112933	837-251C	2" x 1-1/2"	
112934	837-289C	2-1/2" x 1"	
112935	837-290C	2-1/2" x 1-1/4"	
112936	837-291C	2-1/2" x 1-1/2"	
112940	837-336C	3" x 1-1/4"	
112941	837-337C	3" x 1-1/2"	
112942	837-338C	3" x 2"	
112943	837-339C	3" x 2-1/2"	
108160	837-420C	4" x 2"	
112944	837-528C	6" x 2"	
112945	837-529C	6" x 2-1/2"	
112946	837-530C	6" x 3"	
112948	837-578C	8" x 2"	
104186	837-580C	8" x 3"	

CPVC Sch 80 Fittings (Continued)

CPVC Sch 80 Reducer Bushing Flush Style (Soc x Spgt)

Part #	Mfg #	Size	Price
112949	837-582C	8" x 4"	
112950	837-585C	8" x 6"	

CPVC Sch 80 Reducer Bushing Flush Style (Spgt x FIPT)

Part #	Mfg #	Size	Price
129459	838-072C	1/2" x 1/4"	

CPVC Sch 80 Coupling (Soc)



Part #	Mfg #	Size	Price
138815	829-005C	1/2"	
094811	829-007C	3/4"	
100544	829-010C	1"	
112874	829-012C	1-1/4"	
088825	829-015C	1-1/2"	
075102	829-020C	2"	
087750	829-025C	2-1/2"	
072191	829-030C	3"	
075117	829-040C	4"	
112876	829-060C	6"	

CPVC Sch 80 Reducing Coupling (Soc)



Part #	Mfg #	Size	Price
138813	829-101C	3/4" x 1/2"	
112880	829-210C	1-1/2" x 3/4"	
112881	829-211C	1-1/2" x 1"	
112884	829-248C	2" x 3/4"	
112886	829-251C	2" x 1-1/2"	
112887	829-291C	2-1/2" x 1-1/2"	
104191	829-339C	3" x 2-1/2"	
112895	829-420C	4" x 2"	
112896	829-421C	4" x 2-1/2"	
112898	829-528C	6" x 2"	
112899	829-529C	6" x 2-1/2"	

Pipe Fittings



CPVC Schedule 80 Fittings

CPVC Sch 80 Fittings (Continued)

CPVC Sch 80 Reducing Coupling (Soc)

Part #	Mfg #	Size	Price
112900	829-530C	6" x 3"	
112904	829-585C	8" x 6"	

CPVC Sch 80 90° Elbow (Soc)



Part #	Mfg #	Size	Price
056488	806-005C	1/2"	
064988	806-007C	3/4"	
100543	806-010C	1"	
064987	806-012C	1-1/4"	
088826	806-015C	1-1/2"	
077777	806-020C	2"	
087751	806-025C	2-1/2"	
072190	806-030C	3"	
075103	806-040C	4"	
079688	806-060C	6"	
079686	806-080C	8"	

CPVC Sch 80 Special Reinforced 90° Elbow (Soc x SR FIPT)



Part #	Mfg #	Size	Price
143596	807-005CSR	1/2"	

CPVC Sch 80 90° Street Elbow (Soc)



Part #	Mfg #	Size	Price
077781	809-040C	4"	
112853	809-060C	6"	
112854	809-080C	8"	

CPVC Sch 80 45° Elbow (Soc)



Part #	Mfg #	Size	Price
086757	817-005C	1/2"	
094810	817-007C	3/4"	
112855	817-012C	1-1/4"	
100539	817-015C	1-1/2"	
075101	817-020C	2"	
112856	817-025C	2-1/2"	
075105	817-040C	4"	
112864	817-080C	8"	

CPVC Sch 80 45° Street Elbow (Soc)



Part #	Mfg #	Size	Price
112870	827-020C	2"	
112871	827-025C	2-1/2"	
077780	827-040C	4"	
112873	827-080C	8"	

CPVC Sch 80 Tee (Soc)



Part #	Mfg #	Size	Price
138547	801-005C	1/2"	
112803	801-012C	1-1/4"	
112804	801-015C	1-1/2"	
083376	801-020C	2"	
112805	801-025C	2-1/2"	
079685	801-060C	6"	



CPVC Schedule 80 Fittings

CPVC Sch 80 Reducing Tee (Soc)



Part #	Mfg #	Size	Price
138548	801-101C	3/4" x 3/4" x 1/2"	
135671	801-131C	1" x 1" x 3/4"	
112812	801-168C	1-1/4" x 1-1/4" x 1"	
112814	801-209C	1-1/2" x 1-1/2" x 1/2"	
112816	801-211C	1-1/2" x 1-1/2" x 1"	
112818	801-247C	2" x 2" x 1/2"	
112820	801-249C	2" x 2" x 1"	
112827	801-292C	2-1/2" x 2-1/2" x 2"	
112833	801-338C	3" x 3" x 2"	
108159	801-420C	4" x 4" x 2"	
112838	801-422C	4" x 4" x 3"	
112839	801-528C	6" x 6" x 2"	
112840	801-529C	6" x 6" x 2-1/2"	
112841	801-530C	6" x 6" x 3"	
112842	801-532C	6" x 6" x 4"	
112843	801-582C	8" x 8" x 4"	
112844	801-585C	8" x 8" x 6"	

CPVC Sch 80 Cap (Soc)



Part #	Mfg #	Size	Price
139292	847-005C	1/2"	
144076	847-007C	3/4"	
083389	847-010C	1"	
112952	847-015C	1-1/2"	
083388	847-020C	2"	
112953	847-025C	2-1/2"	
112955	847-060C	6"	

CPVC Sch 80 Flange Van Stone Style with Plastic Ring (Soc)

Part #	Mfg #	Size	Price
112968	854-025C	2-1/2"	
112969	854-030C	3"	
112970	854-040C	4"	
112973	854-080C	8"	

CPVC Sch 80 Flange Van Stone Style with Plastic Ring (FIPT)

Part #	Mfg #	Size	Price
112975	855-025C	2-1/2"	
112977	855-030C	3"	
112978	855-040C	4"	

CPVC Sch 80 Flange Van Stone Style with Plastic Ring (Spgt)

Part #	Mfg #	Size	Price
078213	856-040C	4"	

CPVC Sch 80 Old Style Union with Viton O-Ring (Soc)



Part #	Mfg #	Size	Price
103243	857-020C	2"	

CPVC Sch 80 Union with Viton O-Rings (Soc)



Part #	Mfg #	Size	Price
112960	8057-020C	2"	
112962	8057-025C	2-1/2"	
112963	8057-030C	3"	
112965	8057-040C	4"	
112967	8057-060C	6"	

CPVC Sch 80 Industrial Fittings

CPVC Sch 80 Reducer Coupling (SOC)

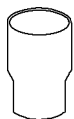

Part #	Mfg #	Size	Price
056486	829-130C	1" x 1/2"	

CPVC (CTS) Fittings

CPVC/CTS Fittings

**CPVC Ball Valve
(Slip x Slip)**



Part #	Mfg #	Size	Price
013168	92190	1/2"	
014676	92195	3/4"	



CPVC/CTS Fittings

**CPVC Coupling
(Slip x Slip)**



Part #	Mfg #	Size	Price
014820	4701	3/4" x 1/2"	
014673	4701T	3/4" IPS x 3/4" CTS	

**CPVC 90° Elbow
(Slip x Slip)**



Part #	Mfg #	Size	Price
013107	4707	1/2"	
014680	4707	3/4"	

**CPVC 90° Street Elbow
(Spgt x Slip)**



Part #	Mfg #	Size	Price
013104	4707-2	1/2"	
014677	4707-2	3/4"	

**CPVC 90° Drop Ear Elbow
(Slip x Slip)**



Part #	Mfg #	Size	Price
013100	4707-5	1/2"	

**CPVC 90° Drop Ear Elbow
(Slip x FIP)**



• Includes washer

Part #	Mfg #	Size	Price
013099	4707-3-5	1/2"	

CPVC 45° Street Elbow (Spgt x Slip)

Part #	Mfg #	Size	Price
031009	4706-2	1/2"	

**CPVC Tee
(Slip x Slip x Slip)**



Part #	Mfg #	Size	Price
013105	4711	1/2"	
014678	4711	3/4"	
014821	4711	3/4" x 1/2"	

**CPVC Reducer Bushing
(Spgt x Slip)**



Part #	Mfg #	Size	Price
014819	4718	3/4" x 1/2"	

Pipe Straps for CPVC

Part #	Mfg #	Size	Price
014675	4724	3/4"	

CPVC Sch 40 Fittings

**CPVC Sch 40 Coupling
(Soc)**



Part #	Mfg #	Size	Price
013098	5101	1/2"	
014671	5101	3/4"	

CPVC Sch 40 45° Elbow (Soc)



Part #	Mfg #	Size	Price
013106	5106	1/2"	
014679	5106	3/4"	

Pipe Fittings

CPVC (CTS) Fittings

CPVC Sch 40 Female Adapter (Soc x FIP)



Part #	Mfg #	Size	Price
013101	5103	1/2"	
014672	5103	3/4"	

CPVC Sch 40 Male Adapter (Soc x MIP)



Part #	Mfg #	Size	Price
013102	5104	1/2"	
014674	5104	3/4"	

CPVC Sch 40 Cap (Soc)



Part #	Mfg #	Size	Price
013097	5117	1/2"	
014670	5117	3/4"	

Snap-On Strap Polypropylen - CPVC-CTS 4724



Part #	Mfg #	Size	Price
013103	M213400	1/2"	



CPVC/CTS Valves

CPVC CTS Ball Valve (Soc)

- EPDM O-Ring

Part #	Mfg #	Size	Price
039563	1922-007	3/4"	

CPVC/CTS Fittings

CPVC CTS Union (Soc w/EPDM O-Ring Seal)

- Maximum internal pressure: 100 psi @ 180°F

Part #	Mfg #	Size	Price
074831	4197-005	1/2"	



CPVC Adapters

Metal Head™ Straight Adapter Male Swt x CPVC

- Perfect for connecting sillcocks, laundry boxes, water service connections, etc.
- All fittings are production tested to ensure maximum quality and a leak-free connection
- Use caution when soldering whenever possible, solder with CPVC socket facing downward. If CPVC joint is above solder joint, plug temporarily with nipple and cap to prevent chimney effect. Always apply torch to female fitting, not to the adapter. Perform all solder joints a minimum of: 10" from 1/2" and 3/4" CPVC sockets 18" from 1" and 1 1/4" CPVC sockets 20" from 1 1/2" CPVC socket 22" from 2" CPVC socket Use a commercial heat blocking agent between solder joint and CPVC joint.



Part #	Mfg #	Connection	Price
183745	643-C311	(3/4") CPVC x M SWT	

PowerPEX® F1807 PEX Crimp x Metal Head™ CPVC

- Straight adapter, no lead, & quick and easy transition
- Perfect for hooking up PEX underground water service lines to CPVC in-house piping systems

Part #	Mfg #	Connection	Price
183757	645XC3	(3/4") CPVC x PEX	
183758	645XC34	1" CPVC x 3/4" PEX	
183759	645XC4	(1") CPVC x PEX	

Pipe Fittings

Dielectric Unions

Dielectric Fittings

Dielectric Nipple

- Prevents corrosion, lime and scale buildup
- Adds years of life to any water system
- For use on water heaters, dishwashers, water purification systems



Part #	Mfg #	Size	Price
144219	D06-500	1" MIP x 3" Length	
144220	D06-525	1-1/4" MIP x 4" Length	
144221	D06-550	1-1/2" MIP x 4" Length	
144222	D06-600	2" MIP x 4" Length	
076215	D06-753	3/4" MIP x 3" Length	

Dielectric Union Gasket

- 200 Degree temperature Rating
- For Water



Part #	Mfg #	Description	Price
170453	D06-875	3/4"	



Dielectric Unions

3000 Series Dielectric Union/Fitting

- Protects against destructive effect of galvanic and stray current corrosion
- For residential, commercial and industrial

LF3002 Dielectric Union FIP Thread to Solder



Part #	Mfg #	Model	Size	Price
158092	0009873	LF3002	1"	

LF3004 Dielectric Unions FIP thread to FIP Thread

Part #	Mfg #	Model	Size	Price
158093	0821934	LF3004	1-1/2"	

Dielectric Union (MIP x Swt)



Part #	Mfg #	Model	Size	Price
158083	0009870	LF3005A	1/2"	
158084	0009871	LF3005A	3/4"	

MIP Thread to Female Solder Connections Dielectric Union



Part #	Mfg #	Model	Size	Price
158096	0821937	LF3007	3/4" x 1/2"	

Flanged Iron Pipe Thread to Copper Solder Joint Dielectric Union



Part #	Mfg #	Model	Size	Price
158094	0821747	LF3100	2-1/2"	
158095	0821748	LF3100	3"	

301 Series Dielectric Union/Fitting

- Protects against destructive effect of galvanic and stray current corrosion
- For residential, commercial and industrial

Dielectric Union (FIP x Swt)



Part #	Mfg #	Model	Size	Price
158085	0009890	LF301	1/2" FIP	
158086	0009891	LF301	3/4" FIP	
158087	0009892	LF301	1" FIP	
158088	0009893	LF301	1-1/4" FIP	
158089	0009894	LF301	1-1/2" FIP	
158090	0009895	LF301	2" FIP	
158091	0009896	LF301	3/4" x 1/2"	



Dielectric Unions

Dielectric Union (MIP x Swt)

Part #	Mfg #	Model	Size	Price
191039	301-205NL	301-205NL	1/2" x 3/4"	

Accessories and Parts

Accessories

Part #	Mfg #	Description	Price
164513	0889142	1/2" Bolt Insulator	
002556	0889144	5/8" Bolt Insulator	
164514	0889148	7/8" Bolt Insulator	
030597	0889146	3/4" Bolt Insulator	



Extra-Heavy Fittings

Xtra-Heavy Black Malleable Fittings

300# Black MI XH 90° Elbow



Part #	Size	Price
013057	1/2"	
014636	3/4"	
027550	1-1/4"	
012394	1-1/2"	
013765	2"	

300# Black MI XH Coupling



Part #	Size	Price
013054	1/2"	
014633	3/4"	
012752	1-1/4"	
012192	1"	
012391	1-1/2"	
013763	2"	

300# Black MI XH Tee



Part #	Size	Price
013055	1/2"	
014635	3/4"	

Xtra-Heavy Black Malleable Unions

300# Black MI XH Ground Joint Union



Part #	Size	Price
013056	1/2"	
014631	3/4"	
012772	1-1/4"	
012393	1-1/2"	

Xtra-Heavy Black Malleable Unions (Continued)

300# Black MI XH Ground Joint Union

Part #	Size	Price
013764	2"	

Black Steel Nipples



Xtra-Heavy Sch 80 Black Steel Nipples



1/8" XH Sch 80 Black Steel Nipple

Part #	Size	Price
175258	1/8" x 2"	
175259	1/8" x 2-1/2"	
175260	1/8" x 3"	
175261	1/8" x 3-1/2"	
175262	1/8" x 4"	
175263	1/8" x 4-1/2"	
175264	1/8" x 5"	

1/4" XH Sch 80 Black Steel Nipple

Part #	Size	Price
013486	1/4" x Close	
013546	1/4" x 1-1/2"	
013580	1/4" x 2"	
013584	1/4" x 2-1/2"	
013589	1/4" x 3"	
013592	1/4" x 3-1/2"	
034053	1/4" x 4"	
013604	1/4" x 4-1/2"	
013608	1/4" x 5"	
175265	1/4" x 5-1/2"	
013617	1/4" x 6"	

3/8" XH Sch 80 Black Steel Nipple

Part #	Size	Price
016848	3/8" x 1-1/2"	
031014	3/8" x 2"	
015118	3/8" x 2-1/2"	
028995	3/8" x 3"	

Pipe Fittings



Extra-Heavy Fittings

**Xtra-Heavy Sch 80 Black Steel Nipples
(Continued)**

3/8" XH Sch 80 Black Steel Nipple

Part #	Size	Price
027578	3/8" x 3-1/2"	
015151	3/8" x 4"	
175266	3/8" x 4-1/2"	
015160	3/8" x 5"	
028996	3/8" x 5-1/2"	

1/2" XH Sch 80 Black Steel Nipple

Part #	Size	Price
013087	1/2" x Close	
013295	1/2" x 2"	
013300	1/2" x 2-1/2"	
013308	1/2" x 3"	
013314	1/2" x 3-1/2"	
013365	1/2" x 4"	
013370	1/2" x 4-1/2"	
013376	1/2" x 5"	
013381	1/2" x 5-1/2"	
013386	1/2" x 6"	

3/4" XH Sch 80 Black Steel Nipple

Part #	Size	Price
014662	3/4" x Close	
014864	3/4" x 2"	
014869	3/4" x 2-1/2"	
014877	3/4" x 3"	
014881	3/4" x 3-1/2"	
014918	3/4" x 4"	
014923	3/4" x 4-1/2"	
014932	3/4" x 5-1/2"	
014940	3/4" x 6"	
182023	3/4" x 6-1/2"	

1" XH Sch 80 Black Steel Nipple

Part #	Size	Price
012214	1" x Close	
013216	1" x 2"	
013246	1" x 2-1/2"	
013400	1" x 3"	
013541	1" x 4"	
013622	1" x 5"	
013628	1" x 5-1/2"	

**Xtra-Heavy Sch 80 Black Steel Nipples
(Continued)**

1" XH Sch 80 Black Steel Nipple

Part #	Size	Price
013640	1" x 6"	

1-1/4" XH Sch 80 Black Steel Nipple

Part #	Size	Price
012804	1-1/4" x Close	
012957	1-1/4" x 2"	
012961	1-1/4" x 2-1/2"	
012968	1-1/4" x 3-1/2"	
012995	1-1/4" x 4"	
020017	1-1/4" x 4-1/2"	
017023	1-1/4" x 5"	

1-1/2" Black Steel XH Sch 80 Nipple

Part #	Size	Price
012684	1-1/2" x 2"	
012691	1-1/2" x 2-1/2"	
012695	1-1/2" x 3"	
012698	1-1/2" x 3-1/2"	
019140	1-1/2" x 4"	
026781	1-1/2" x 4-1/2"	
030137	1-1/2" x 5"	
012732	1-1/2" x 5-1/2"	
012737	1-1/2" x 6"	

2" XH Sch 80 Black Steel Nipple

Part #	Size	Price
013808	2" x Close	
014232	2" x 2-1/2"	
014246	2" x 3-1/2"	
014264	2" x 4"	
027198	2" x 5"	
032031	2" x 5-1/2"	
014285	2" x 6"	

2-1/2" XH Sch 80 Black Steel Nipple

Part #	Size	Price
175267	2-1/2" x 3"	
175268	2-1/2" x 5-1/2"	

Pipe Fittings

**Black Steel
Nipples**



**Black Steel
Nipples**



Extra-Heavy Fittings

3" XH Sch 80 Black Steel Nipple

Part #	Size	Price
175269	3" x 3-1/2"	
175270	3" x 4-1/2"	
175271	3" x 5-1/2"	
175272	3" x 6"	

Pipe Fittings



Flexible Couplings

Band-Seal® Specialty Couplings

- Shielded transition couplings join similar and dissimilar pipe sizes and pipe materials
- Resists shear forces while maintaining alignment
- Corrosion-resistant 300 Series stainless steel components
- Internal rubber sleeve reduces noise and vibration
- Neoprene rubber sleeve conforms to ASTM C 564



C Series

- CI= Cast Iron
- PL= Schedule 40 Plastic
- ST= Steel

300 Series Stainless Steel Worm Drive Clamping Mechanisms are standard on all Couplings

Part #	Mfg #	Description	Price
135775	C 320	3" CI to 2" CI, PL or ST	

CP Series

- CI= Cast Iron
- PL= Schedule 40 Plastic
- ST= Steel
- XH CI= Extra Heavy Cast Iron

Part #	Mfg #	Description	Price
007139	CP 150	1-1/2" CI, PL or ST to 1-1/2" CI, PL or ST	
007140	CP 200	2" CI, PL or ST to 2" CI, PL or ST	
007141	CP 215	2" CI, PL or ST to 1-1/2" CI, PL or ST	
007142	CP 33	3" CI to 3" PL, ST or XH CI	
007143	CP 43	4" CI to 3" PL, ST or XH CI	
007144	CP 44	4" CI to 4" PL, ST or XH CI	
063377	CP 55	5" CI to 5" PL, ST or XH CI	
063379	CP 66	6" CI to 6" PL, ST or XH CI	
055439	CP 88	8" CI to 8" PL, ST or XH CI	

CK Series

- CI= Cast Iron
- K= Copper
- PL= Schedule 40 Plastic
- ST= Steel

Part #	Mfg #	Description	Price
007131		1-1/2" CI, PL or ST to 1-1/4" K or 1" PL or ST	

Band-Seal® Specialty Couplings (Continued)

CK Series

Part #	Mfg #	Description	Price
007132	CK1125	1-1/2" CI, PL or ST to 1-1/2" K or 1-1/4" PL or ST	
007133	CK115	2" CI, PL or ST to 1-1/4" K or 1" PL or ST	
007134	CK 215	2" CI, PL or ST to 1-1/2" K or 1-1/4" PL or ST	
007135	CK 22	2" CI, PL or ST to 2" K	
138807	CK 315	3" CI to 1-1/2" K or 1-1/4" PL or ST	
076967	CK 32	3" CI to 2" K	
007136	CK33	3" CI to 3" K	
007137	CK 43	4" CI to 3" K	
007138	CK 44	4" CI to 4" K	

K Series

- K= Copper
- PL= Schedule 40 Plastic
- ST= Steel

Part #	Mfg #	Description	Price
170794	K 075	3/4" K to 3/4" K (O.D. 0.0875")	
110461	K 1125	1-1/2" K or 1-1/4" PL, ST to 1-1/4" K or 1" PL, ST	
007145	K 150	1-1/2" K or 1-1/4" PL, ST to 1-1/2" K or 1-1/4" PL, ST	
007146	K 200	2" K to 2" K	
069234	K 300	3" K to 3" K	

KC Series

- CI= Cast Iron
- K= Copper
- PL= Schedule 40 Plastic
- ST= Steel
- T= Tubular

Part #	Mfg #	Description	Price
030882	KC 32	3" K to 2" CI, PL or ST	
054046	KC 43	4" K to 3" CI, PL or ST	

Pipe Fittings



Flexible Couplings

P Series

- CI= Cast Iron
- K= Copper
- PL= Schedule 40 Plastic
- ST= Steel
- XH CI= Extra Heavy Cast Iron

Part #	Mfg #	Description	Price
170795	P 075	3/4" PL, ST or 1" K to 3/4" PL, ST or 1" K	
162701	P 100	1" PL, ST or 1-1/4" K to 1" PL, ST or 1-1/4" K	
170796	P 175	3/4" PL, ST or 1" K to 1" PL, ST or 1-1/4" K	
079865	P 250	2-1/2" PL or ST to 2-1/2" PL or ST	
078996	P 300	3" PL, ST or XH CI to 3" PL, ST or XH CI	
075318	P 400	4" PL, ST or XH CI to 4" PL, ST or XH CI	
160474	P 430	4" PL, ST or XH CI to 3" PL, ST or XH CI	

PK Series

- CI= Cast Iron
- K= Copper
- PL= Schedule 40 Plastic
- ST= Steel
- XH CI= Extra heavy Cast Iron

Part #	Mfg #	Description	Price
007147	PK 33	3" PI, ST or XH CI to 3" K	

T Series

- CI= Cast Iron
- PL= Schedule 40 Plastic
- ST= Steel
- T= Tubular

Part #	Mfg #	Description	Price
021665	T 150	1-1/2" T to 1-1/2" CI, PL or ST	
115022	T 215	1-1/2" T to 2" CI, PL or ST	

TWC & TWP Series

- CI= Cast Iron
- TWP= Thin wall Plastic
- PL= Schedule 40 Plastic
- ST= Steel
- XH CI= Extra Heavy Cast Iron

Part #	Mfg #	Description	Price
044261	TWC 44	4" TWP to 3" CI	
044263	TWP 44	4" TWP to 4" PL, ST or XH CI	

Flex-Seal® Couplings

- Flexible rubber couplings connect any 2 pipes without use of bushing's
- Sleeve manufactured of molded natural and synthetic rubber
- Leak proof seal
- (2) 300 Series SS worm drive clamping bands
- Conforms to ASTM C 425, ASTM C 1173 and ISO 9002



MR56 Series - CI/PL to CI/PL

- Cast iron or plastic to cast iron or plastic

Part #	Mfg #	Description	Price
003037	MR56-125	1-1/2" Tbg/Cpr or 1-1/4" PL to 1-1/2" Tbg/Cpr or 1-1/4" PL	
003038	MR56-15	1-1/2" CI/PL to 1-1/2" CI/PL	
003039	MR56-15/125	1-1/4" CI/PL to 1-1/2" Tbg/Cpr or 1-1/4" PL	
003040	MR56-215	2" CI/PL to 1-1/2" CI/PL	
003041	MR56-22	2" CI/PL to 2" CI/PL	
003025	MR56-32	3" CI/PL to 2" CI/PL	
003042	MR56-33	3" CI/PL to 3" CI/PL	
003043	MR56-42	4" CI/PL to 2" CI/PL	
003044	MR56-43	4" CI/PL to 3" CI/PL	
003045	MR56-44	4" CI/PL to 4" CI/PL	
052674	MR56-54	5" CI/PL to 4" CI/PL	
036055	MR56-55	5" CI/PL to 5" CI/PL	
003046	MR56-64	6" CI/PL to 4" CI/PL	
003047	MR56-66	6" CI/PL to 6" CI/PL	
095771	MR56-86	8" CI/PL to 6" CI/PL	
003048	MR56-88	8" CI/PL to 8" CI/PL	
003035	MR56-1010	10" CI/PL to 10" CI/PL	

MR01 Series - Clay to Clay

Part #	Mfg #	Description	Price
003027	MR01-44	4" CL to 4" CL	
003029	MR01-66	6" CL to 6" CL	
003030	MR01-88	8" CL to 8" CL	

Pipe Fittings



Flexible Couplings

MR02 Series - Clay to CI/PL

- Clay to cast iron or plastic

Part #	Mfg #	Description	Price
003031	MR02-44	4" CL to 4" CI/PL	
003032	MR02-64	6" CL to 4" CI/PL	
003033	MR02-66	6" CL to 6" CI/PL	
003034	MR02-88	8" CL to 8" CI/PL	
019029	MR02-1212	12" CL to 12" CI/PL	

Flex-Seal® Adjustable Repair Couplings

- Flexible rubber couplings connect any two pipes without use of bushing's
- Sleeve manufactured of molded natural and synthetic rubber
- Sealing o-rings under each sealing clamp band
- (2) Surgical grade 316 stainless steel nut and bolt clamping bands



MR02 Series - Clay to CI/PL (2)

- Clay to cast iron or plastic

Part #	Mfg #	Description	Price
043362	MR02 44 ARC	4" CL to 4" CI/PL	
043364	MR02 64 ARC	6" CL to 4" CI/PL	
043363	MR02 66 ARC	6" CL to 6" CI/PL	

MR56 Series - CI/PL to CI/PL

- Cast iron or plastic to cast iron or plastic

Part #	Mfg #	Description	Price
084837	MR56 22 ARC	2" CI/PL to 2" CI/PL	
031825	MR56 33 ARC	3" CI/PL to 3" CI/PL	
031826	MR56 44 ARC	4" CI/PL to 4" CI/PL	
049769	MR56 64 ARC	6" CI/PL to 4" CI/PL	
031827	MR56 66 ARC	6" CI/PL to 6" CI/PL	
106437	MR56 88 ARC	8" CI/PL to 8" CI/PL	

Flex-Seal®

Compression Joint Sealer

- Joins bell and spigot pipe

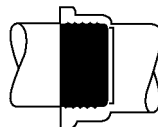

Part #	Mfg #	Description	Price
005671	MR22U 139	2" CI SV Hub to 1-1/2" Sch 40 PL, ST	
005672	MR22U 205	2" CI SV Hub to 2" Sch 40 PL, ST, CI XH	
005674	MR33U 205	3" CI SV Hub to 2" Sch 40 PL, ST, CI XH	

Flex-Seal® (Continued)

Compression Joint Sealer

Part #	Mfg #	Description	Price
005675	MR33U 305	3" CI SV Hub to 3" Sch 40 PL, ST, CI XH	
005676	MR44U 205	4" CI SV Hub to 2" Sch 40 PL, ST, CI XH	
005677	MR44U 305	4" CI SV Hub to 3" Sch 40 PL, ST, CI XH	
086488	MR44UX 305	4" CI XH Hub to 3" Sch 40 PL, ST, CI XH	
005678	MR44U 405	4" CI SV Hub to 4" Sch 40 PL, ST, CI XH	

Compression O-Ring

- Used in joining 6" inside diameter pipe to 4" outside diameter CI/Sch 40 PL/ST pipe

Part #	Mfg #	Description	Price
095777	MR64	Compression O Ring	

Drain Piping to Tubular Trap



Part #	Mfg #	Description	Price
114882	MRDTC-150	1-1/4" or 1-1/2" x 1-1/4" or 1-1/2"	

Coupling Shear Ring

Part #	Mfg #	Size	Price
125562	3803012	3"	
124757	3804010	4"	
124758	3806015	6"	



Flexible Couplings

Band-Seal® End Caps

End Cap

- Reusable
- Strong-molded "x" braces against head pressures and axially tapered design distributes and dissipates internal stress
- Needs no plastic liner
- Made of high quality rubber
- Resists water and ozone
- Tight fitting, molded internal cone is integral part of end cap
- For use with cast iron, steel, PVC, and ABS piping materials



Part #	Mfg #	Size	Price
002738	0701-011	1-1/2"	
002739	0702-019	2"	
002740	0703-017	3"	
002741	0704-015	4"	
046504	0706-028	6"	
090251	0708-016	8"	



Couplings

Hi-Torq 125 Coupling



Part #	Mfg #	Size	Price
002742	10015	1-1/2"	
002743	10020	2"	
002744	10030	3"	
002745	10040	4"	
002746	10060	6"	



Flexible Couplings

One-Piece Eccentric Couplings

- Aligns the inside wall of the two pipes
- Provides an obstruction free flow
- Meets ASTM C 1173 and D 5936
- 300 Series stainless steel clamp

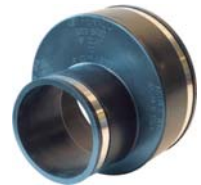

Part #	Mfg #	Description	Price
139647	1002-64EC	6" Clay to 4" CI or PL	

Eccentric Reducer

Part #	Mfg #	Description	Price
139648	6.625-4.500REB	6.625" PL x 4.5" PL	

Tubular Drain Pipe Connector

- Alter or repairs any combination of brass or plastic drain pipe



TC-150



DTC-150

Part #	Mfg #	Description	Price
192847	TC-150	Tubular Drain Pipe Connector	
192838	DTC-150	Drain & Trap Connector	



DFW Flexible Sewer Saddles

Plastic Sewer Saddle Tee with Clamps

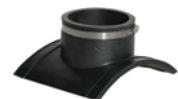

Part #	Mfg #	Pipe Size	Price
018217	DFW-4T/C	4"	

Flexible Couplings

Flexible Saddles

- *Elastomeric construction provides maximum strength and flexibility*



Part #	Mfg #	Description	Price
062129	DFW-4Y/C	4" Wye with Clamps	
120005	33S248	Full Serrated Clamps for Saddle Skirts	

Flexible Gas Fittings

AutoSnap® Fittings & Accessories

AutoSnap® Straight Fitting

- Brass



Part #	Mfg #	Size	Price
164302	FGP-SFST-375	3/8"	
164303	FGP-SFST-500	1/2"	
164304	FGP-SFST-750	3/4"	
164305	FGP-SFST-1000	1"	

AutoSnap® Reducing Tee

- CounterStrike/ All Outlets



Part #	Mfg #	Size	Price
163466	FGP-TF750-T500	3/4" x 3/4" x 1/2"	
163469	FGP-TF1000-T75	1" x 1" x 3/4"	

AutoSnap® Coupling

- Brass



Part #	Mfg #	Size	Price
183274	FGP-SCPLG-375	3/8"	
183275	FGP-SCPLG-500	1/2"	
183276	FGP-SCPLG-750	3/4"	
183279	FGP-SCPLG-1000	1"	

AutoSnap® Flange Fittings

- Brass and Stainless Steel plate



Part #	Mfg #	Size	Price
183282	FGP-SRFG-375	3/8"	
183284	FGP-SRFG-500	1/2"	
183286	FGP-SRFG-750	3/4"	
183287	FGP-SRFG-1000	1"	

AutoSnap® Wallbox with Valve



Part #	Mfg #	Size	Price
183281	FGP-SWBTM-500	1/2"	

AutoFlare® Fittings & Accessories

AutoFlare® PS-II MNPT Adapter



Part #	Mfg #	Size	Price
119635	FGP-UGF-500	1/2"	
119636	FGP-UGF-750	3/4"	
124302	FGP-UGF-1000	1"	

AutoFlare® Straight Mechanical Fitting



FGP-FST FGP-FSTF

Part #	Mfg #	Size	Price
107504	FGP-FST-500	1/2"	
112498	FGP-FST-750	3/4"	
112497	FGP-FST-1000	1"	
119556	FGP-FST-1250	1-1/4"	
124677	FGP-FST-1500	1-1/2"	

AutoFlare® Spare Split Ring



Part #	Mfg #	Size	Price
107505	FGP-RING-500	1/2"	
119609	FGP-RING-750	3/4"	
119610	FGP-RING-1000	1"	

Flexible Gas Fittings

AutoFlare® Meter Termination



Part #	Mfg #	Size	Termination	Price
115086	FGP-MT6-500	1/2"	6"	
115087	FGP-MT6-750	3/4"	6"	
115088	FGP-MT6-1000	1"	6"	

AutoFlare® Termination Mount Fitting



Part #	Mfg #	Size	Price
118993	FGP-TM-500	1/2"	

AutoFlare® Bracket & Stub-Out



FGP-FPT-500

Part #	Mfg #	Description	Price
118481	FGP-FPT-500	1/2" Fireplace Stub-Out	
119613	FGP-ASP-500	1/2" x 2-1/2" Appliance Stub-Out	

AutoFlare® Outlet Tee



Part #	Mfg #	Size	Price
122482	FGP-TF500-T500	1/2"	
122483	FGP-TF750-T750	3/4"	

AutoFlare® Coupling



Part #	Mfg #	Size	Price
117345	FGP-CPLG-500	1/2"	

AutoFlare® Fittings & Accessories (Continued)

AutoFlare® Coupling

Part #	Mfg #	Size	Price
120386	FGP-CPLG-750	3/4"	
120387	FGP-CPLG-1000	1"	

AutoFlare® Flange Fitting



BFF-500

BFF-750

Part #	Mfg #	Size	Material	Price
112496	FGP-BFF-500	1/2"	Brass	
112495	FGP-BFF-750	3/4"	Brass	
112494	FGP-BFF-1000	1"	Brass	

AutoFlare® 90° Elbow Flange Fitting



Part #	Mfg #	Size	Material	Price
130582	FGP-ELLB-500	1/2"	Brass	

AutoFlare® 90° Elbow Flange Valve



Part #	Mfg #	Size	Material	Price
119611	FGP-BF-90V-500	1/2"	Brass	

Pipe Fittings

Flexible Gas Fittings

TracPipe® Accessories & Tools

Manifold

- (4) Ports 1/2" female



FGP-MI-PC



FGP-MB2

Part #	Mfg #	Description	Price
119617	FGP-MI-PC	4" x 1/2" Coated	
119618	FGP-MB2	Bracket for Use with FGP-MI-PC Only	

Pressure Regulator

- Cast housing suitable for outdoor use
- Includes an approved vent limiter



Part #	Mfg #	Regulator	Size	Price
119631	FGP-REG-3	2 psi, 8"wc	1/2"	

TracPipe® Protection Devices

Striker Plate

- Hardened carbon steel

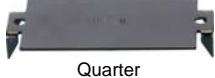

Quarter



Half



Full

Part #	Mfg #	Size	Material	Price
119621	FGP-SP-025	3" x 2"	Quarter	
119622	FGP-SP-050	3" x 7"	Half	
119623	FGP-SP-075	3" x 8"	Half	
119624	FGP-SP-100	3" x 12"	Full	

Floppy Steel Conduit



Part #	Mfg #	Fits	Size	Length	Price
119625	FGP-FPY-500CT	1/2"	1"	1'	
119626	FGP-FPY-750CT	3/4"	1-1/4"	1'	
119627	FGP-FPY-1000CT	1"	1-1/2"	1'	

Silicon Tape



Part #	Mfg #	Size	Color	Price
119628	FGP-915-10H-12	1" x 12 yds	Yellow	
119629	FGP-915-10H-12BL	1" x 12 yds	Black	

Leak Check

- Non-corrosive solution

Part #	Mfg #	Description	Price
119630	FGP-LCS	1 Quart	

Bonding Clamp

Part #	Mfg #	Description	Price
119619	FGP-GC-1	For 3/8" - 3/4" TracPipe	
119620	FGP-GC-2	For 1" - 1-1/4" TracPipe	

Wall Outlet Boxes



Part #	Mfg #	Description	Price
112493	FGP-WBTM-500	Metal Box with 1/2" Valve, Fire Rated	
121236	FGP-WBTM-750	Metal Box with 3/4" Valve, Fire Rated	

Flexible Gas Fittings

Wardflex Fittings

Wardflex Male Mechanical Joint

- Approved for concealed use
- One corrugation crush seal
- Reusable
- 3/8" through 1-1/4" patented STEPSAVER fittings
- 1-1/2" and 2" fittings - Reliable gasket seal



Part #	Mfg #	Size	Price
190546	WF201	3/8" x 1/2"	
190547	WF202	1/2"	
190548	WF203	3/4"	
193108	WF204	1" x 3/4"	
194253	WF205	1" x 1"	
196153	WF206	1-1/4"	
196871	WF207	1-1/2"	

Wardflex Female Mechanical Joint

- Approved for concealed use
- One corrugation crush seal
- Reusable
- 3/8" through 1-1/4" patented STEPSAVER fitting
- 1-1/2" and 2" fittings - Reliable gasket seal



Part #	Mfg #	Size	Price
193911	WF251	1/2"	
193912	WF252	3/4"	
193914	WF254	1"	

Wardflex Mechanical Coupling

- Approved for concealed use
- One corrugation crush seal
- Reusable
- 3/8" through 1-1/4" patented STEPSAVER fittings
- 1-1/2" and 2" fittings - Reliable gasket seal



Part #	Mfg #	Size	Price
193915	WF261	1/2"	
193916	WF262	3/4"	
193917	WF263	1"	

Wardflex Male Termination Fitting

- Provides fixed point termination on wall or floor
- One corrugation crush seal
- Reusable
- 3/8" through 1-1/4" patented STEPSAVER fittings
- Base Plate Steel



Part #	Mfg #	Size	Price
190550	WF271	1/2"	
193954	WF272	3/4"	
201548	WF274	1"	

Wardflex Male Outdoor Termination Fitting

- Provides fixed point termination on wall or floor
- One corrugation crush seal
- Reusable
- 3/8" through 1-1/4" patented STEPSAVER fittings
- Base Plate Steel
- Outdoor fittings are supplied w/o-rings



Part #	Mfg #	Size	Price
190558	WF281	1/2"	
190559	WF282	3/4"	
195777	WF284	1"	

Wardflex Mechanical Tees

- Approved for concealed use
- One corrugation crush seal
- Reusable
- 3/8" through 1-1/4" patented STEPSAVER fittings
- 1-1/2" and 2" fittings - Reliable gasket seal



Part #	Mfg #	Size	Price
193918	WF351	1/2"	
193919	WF365	3/4" x 3/4" x 1/2"	
199212	WF366	3/4" x 1/2" x 1/2"	
193920	WF352	3/4"	
199622	WF353	1"	
199924	WF358	1" x 1" x 1/2"	
199969	WF357	1" x 1" x 3/4"	

Pipe Fittings

Flexible Gas Fittings

Appliance Stub Out

- Fixed termination point with male NPT connections
- Stub Out Pipe - schedule 40 steel pipe
- Plate - 14 Gauge Steel
- Coating - Black Paint, except threads



Part #	Mfg #	Size	Price
193941	WF381	1/2"	
193940	WF382	3/4"	

Meter Stub Out

- Fixed termination point with male NPT connections
- Stub Out Pipe - schedule 40 steel pipe
- Plate - 14 Gauge Steel
- Coating - Black Paint, except threads



Part #	Mfg #	Size	Price
195148	WF3992	1/2" x 6"	

Cross Manifolds

- Multiple sizes and configurations
- Female NPT connections
- Central distribution center
- Malleable Iron



Part #	Mfg #	Size	Price
209839	WF606	1" x 3/4"	

Striker Plates

- Provides protection from puncture threats where tubing is concealed and restricted
- Striker plate - 16 gauge 1050 steel
- Hardness - Rockwell 30-40c



Part #	Mfg #	Size	Price
190554	WF610	1.50" x 3.25"	

Wardflex Fittings (Continued)

Striker Plates

Part #	Mfg #	Size	Price
190553	WF611	6.50" x 3.25"	
190552	WF612	11.50" x 3.25"	

Stripwound Conduit



Part #	Mfg #	Size	Price
196305	WF623	1/2" x 12"	
196306	WF625	3/4" x 12"	

Tubing Cutters



Part #	Mfg #	Size	Price
190555	WF662	3/8" to 3/4"	
200734	WF664	3/4" to 1-1/4"	

Flush Mount Gas Valve Kit

- Provides flush mount termination for appliance connections
- White Box



Part #	Mfg #	Size	Price
195149	WF701	1/2"	
209097	WF702	3/4"	

Bounding Clamps



Part #	Mfg #	Size	Price
198634	WF800	3/8-1"	

Pipe Fittings

Flexible Gas Fittings

Gas Fittings

SnapFast® Deluxe Quick-Disconnect

- Includes nipple and coupling

Part #	Mfg #	Size	Price
138022	A75	3/4"	
138023	A100	1"	



Gas Appliance Connector Fittings

Steel - (OD Flr x FIP)

Part #	Mfg #	Description	Price
138345	AU1-8S	1/2" OD Flr x 1/2" FIP	

Flo Control PVC Fittings

Compression Fittings

PVC IPS Comp Coupling



Part #	Mfg #	IPS Size	Body Length	Price
229181	CPC-0500	1/2"	4"	
229182	CPC-0500	3/4"	4-1/4"	
229183	CPC-1000	1"	4-1/2"	
229185	CPC-1250	1-1/4"	5"	
229190	CPC-1500	1-1/2"	5-1/2"	
229191	CPC-2000	2"	6"	
229192	CPC-2500	2-1/2"	8"	
229198	CPC-4000	4"	10"	

Expansion Repair Couplings

PVC Flo-Span™ Expansion Coupling

- Non-union

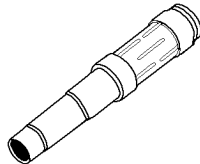

Part #	Mfg #	IPS Size	Body Length	Price
132426	117-12	1-1/4"	9"	
004410	117-15	1-1/2"	10"	

PVC Pro-Span™ PVC Repair Coupling

- Non-union



Part #	Mfg #	IPS Size	Price
004412	118-25	2-1/2"	
018078	118-30	3"	
004413	118-40	4"	

Galvanized Steel Fittings

Galvanized Malleable Iron Fittings

Threaded 150# Galv MI 45° Elbow



Part #	Size	Price
013683	1/8"	
013524	1/4"	
015043	3/8"	
013151	1/2"	
014721	3/4"	
012252	1"	
012844	1-1/4"	
012474	1-1/2"	
013839	2"	

Threaded 150# Galv MI 45° Street Elbow



Part #	Size	Price
013678	1/8"	
013519	1/4"	
013146	1/2"	
014715	3/4"	
012246	1"	
012468	1-1/2"	
013833	2"	

Threaded 150# Galv MI 90° Elbow



Part #	Size	Price
013684	1/8"	
013525	1/4"	
015044	3/8"	
013152	1/2"	
014722	3/4"	
012253	1"	
012845	1-1/4"	
012475	1-1/2"	
013840	2"	

Threaded 150# Galv MI 90° Street Elbow



Part #	Size	Price
013679	1/8"	
013520	1/4"	
015039	3/8"	
013147	1/2"	
014716	3/4"	
012247	1"	
012838	1-1/4"	
012469	1-1/2"	
013834	2"	

Threaded 150# Galv MI 90° Reducing Elbow



Part #	Size	Price
013354	1/2" x 3/8"	
014912	3/4" x 3/8"	
014830	3/4" x 1/2"	
012466	1" x 1/2"	
013426	1" x 3/4"	
012941	1-1/4" x 1/2"	

Threaded 150# Galv MI Half Coupling

Part #	Size	Price
034950	1/2"	
049366	3/4"	
049370	1"	
049376	1-1/4"	
049380	1-1/2"	
026312	2"	

Galv MI Merchant Coupling



Part #	Size	Price
013675	1/8"	
013514	1/4"	
015034	3/8"	
013135	1/2"	
014704	3/4"	
012238	1"	
012830	1-1/4"	
012460	1-1/2"	
013828	2"	
014359	3"	

Threaded 150# Galv MI Reducer



Part #	Size	Price
013575	1/4" x 1/8"	
015098	3/8" x 1/4"	
013277	1/2" x 1/4"	
013353	1/2" x 3/8"	
014857	3/4" x 1/8"	
014850	3/4" x 1/4"	
014911	3/4" x 3/8"	
014829	3/4" x 1/2"	
012465	1" x 1/2"	
013425	1" x 3/4"	
012915	1-1/4" x 1/2"	
012979	1-1/4" x 3/4"	
012898	1-1/4" x 1"	
012711	1-1/2" x 3/4"	
012571	1-1/2" x 1"	
012633	1-1/2" x 1-1/4"	
014255	2" x 3/4"	
013967	2" x 1"	
014043	2" x 1-1/4"	
013997	2" x 1-1/2"	
014135	2-1/2" x 1-1/2"	
014523	3" x 2"	

Pipe Fittings

Galvanized Steel Fittings

Threaded 150# Galv MI Tee



Part #	Size	Price
013680	1/8"	
013521	1/4"	
015040	3/8"	
013148	1/2"	
014717	3/4"	
012248	1"	
012839	1-1/4"	
012470	1-1/2"	
013835	2"	

Threaded 150# Galv MI Reducing Run/Outlet Tee



Part #	Size	Price
013359	1/2" x 3/8" x 3/8"	
014838	3/4" x 1/2" x 1/2"	
012669	1" x 1/2" x 1/2"	
013439	1" x 3/4" x 1/2"	
013443	1" x 3/4" x 3/4"	
012916	1-1/4" x 1" x 1/2"	
012950	1-1/4" x 1" x 3/4"	

Threaded 150# Galv MI Reducing Run Tee



Part #	Size	Price
014842	3/4" x 1/2" x 3/4"	
013435	1" x 3/4" x 1"	

Threaded 150# Galv MI Reducing Outlet Tee



Part #	Size	Price
013259	1/2" x 1/2" x 3/8"	
014896	3/4" x 3/4" x 1/2"	
012346	1" x 1" x 1/2"	
012745	1" x 1" x 3/4"	
012931	1-1/4" x 1-1/4" x 3/4"	
012921	1-1/4" x 1-1/4" x 1"	
012606	1-1/2" x 1-1/2" x 3/4"	
012592	1-1/2" x 1-1/2" x 1"	
014239	2" x 2" x 3/4"	
014214	2" x 2" x 1"	
014222	2" x 2" x 1-1/2"	

Threaded 150# Galv MI Cross



Part #	Size	Price
013136	1/2"	

Threaded 150# Galv MI Hex Bushing

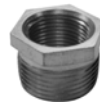

Part #	Size	Price
013574	1/4" x 1/8"	
015107	3/8" x 1/8"	
015097	3/8" x 1/4"	
013288	1/2" x 1/8"	
013276	1/2" x 1/4"	
013352	1/2" x 3/8"	
014856	3/4" x 1/8"	
014849	3/4" x 1/4"	
014910	3/4" x 3/8"	
014826	3/4" x 1/2"	
012828	1" x 1/4"	
013447	1" x 3/8"	
012458	1" x 1/2"	
013424	1" x 3/4"	

Galvanized Malleable Iron Fittings (Continued)

Threaded 150# Galv MI Hex Bushing

Part #	Size	Price
012939	1-1/4" x 1/2"	
012978	1-1/4" x 3/4"	
012897	1-1/4" x 1"	
012666	1-1/2" x 1/2"	
012710	1-1/2" x 3/4"	
012570	1-1/2" x 1"	
012632	1-1/2" x 1-1/4"	
014254	2" x 3/4"	
013966	2" x 1"	
014042	2" x 1-1/4"	
013996	2" x 1-1/2"	
014154	2-1/2" x 2"	
014522	3" x 2"	

Threaded 150# Galv MI Cap



Part #	Size	Price
013674	1/8"	
013513	1/4"	
015033	3/8"	
013134	1/2"	
014703	3/4"	
012237	1"	
012829	1-1/4"	
012459	1-1/2"	
013827	2"	

Threaded 150# Galv MI Floor Flange



Part #	Size	Price
013139	1/2"	
014707	3/4"	
012240	1"	
012832	1-1/4"	
013829	2"	

Pipe Fittings

Galvanized Steel Fittings

Threaded 150# Galv MI Locknut



Part #	Size	Price
013140	1/2"	
014708	3/4"	
012241	1"	
012833	1-1/4"	

Threaded 150# Galv MI Square Headed Plug Cored



Part #	Size	Price
013677	1/8"	
013518	1/4"	
015037	3/8"	
013144	1/2"	
014712	3/4"	
012244	1"	
012834	1-1/4"	
013831	2"	
014096	2-1/2"	

Galvanized Malleable Iron Unions

Threaded 150# Galv MI Ground Joint All Iron Union



Part #	Size	Price
015042	3/8"	
013150	1/2"	
014719	3/4"	
012250	1"	
012841	1-1/4"	
012472	1-1/2"	
013837	2"	

Galvanized Steel Nipples



Standard Galvanized Steel Nipples



1/8" Std Wt Galv Steel Nipple

Part #	Size	Price
013668	1/8" x Close	
013688	1/8" x 1-1/2"	
013691	1/8" x 2"	
013694	1/8" x 2-1/2"	
013701	1/8" x 3"	
013709	1/8" x 3-1/2"	
013711	1/8" x 4"	
013713	1/8" x 4-1/2"	
013715	1/8" x 5"	
013717	1/8" x 5-1/2"	

1/4" Std Wt Galv Steel Nipple

Part #	Size	Price
013484	1/4" x Close	
013545	1/4" x 1-1/2"	
013579	1/4" x 2"	
013583	1/4" x 2-1/2"	
013588	1/4" x 3"	
013591	1/4" x 3-1/2"	
013601	1/4" x 4"	
013603	1/4" x 4-1/2"	
013606	1/4" x 5"	
013610	1/4" x 5-1/2"	
013616	1/4" x 6"	

3/8" Std Wt Galv Steel Nipple

Part #	Size	Price
015000	3/8" x Close	
015067	3/8" x 1-1/2"	
015113	3/8" x 2"	
015117	3/8" x 2-1/2"	
015122	3/8" x 3"	

Standard Galvanized Steel Nipples (Continued)

3/8" Std Wt Galv Steel Nipple

Part #	Size	Price
015126	3/8" x 3-1/2"	
015150	3/8" x 4"	
015155	3/8" x 4-1/2"	
015159	3/8" x 5"	
015164	3/8" x 5-1/2"	
015170	3/8" x 6"	

1/2" Std Wt Galv Steel Nipple

Part #	Size	Price
013083	1/2" x Close	
013231	1/2" x 1-1/2"	
013294	1/2" x 2"	
013299	1/2" x 2-1/2"	
013306	1/2" x 3"	
013313	1/2" x 3-1/2"	
013363	1/2" x 4"	
013369	1/2" x 4-1/2"	
013374	1/2" x 5"	
013380	1/2" x 5-1/2"	
013385	1/2" x 6"	
013388	1/2" x 7"	
013391	1/2" x 8"	
013221	1/2" x 10"	
013227	1/2" x 11"	
013218	1/2" x 12"	

3/4" Std Wt Galv Steel Nipple

Part #	Size	Price
014659	3/4" x Close	
014795	3/4" x 1-1/2"	
014862	3/4" x 2"	
014868	3/4" x 2-1/2"	
014876	3/4" x 3"	
014880	3/4" x 3-1/2"	
014917	3/4" x 4"	
014921	3/4" x 4-1/2"	
014927	3/4" x 5"	
014931	3/4" x 5-1/2"	
014938	3/4" x 6"	
014943	3/4" x 7"	
014945	3/4" x 8"	
014947	3/4" x 9"	



Galvanized Steel Fittings

Standard Galvanized Steel Nipples (Continued)

3/4" Std Wt Galv Steel Nipple

Part #	Size	Price
014789	3/4" x 10"	
014786	3/4" x 12"	

1" Std Wt Galv Steel Nipple

Part #	Size	Price
012211	1" x Close	
013141	1" x 2"	
013245	1" x 2-1/2"	
013399	1" x 3"	
013403	1" x 3-1/2"	
013517	1" x 4"	
013553	1" x 4-1/2"	
013620	1" x 5"	
013626	1" x 5-1/2"	
013636	1" x 6"	
013647	1" x 7"	
013676	1" x 8"	
013724	1" x 9"	
012335	1" x 10"	
012337	1" x 11"	
012463	1" x 12"	
012242	1" x 24"	

1-1/4" Std Wt Galv Steel Nipple

Part #	Size	Price
012801	1-1/4" x Close	
012956	1-1/4" x 2"	
012960	1-1/4" x 2-1/2"	
012964	1-1/4" x 3"	
012967	1-1/4" x 3-1/2"	
012994	1-1/4" x 4"	
012998	1-1/4" x 4-1/2"	
013001	1-1/4" x 5"	
013004	1-1/4" x 5-1/2"	
013007	1-1/4" x 6"	
013012	1-1/4" x 9"	
012905	1-1/4" x 10"	

1-1/2" Std Wt Galv Steel Nipple

Part #	Size	Price
012430	1-1/2" x Close	

Standard Galvanized Steel Nipples (Continued)

1-1/2" Std Wt Galv Steel Nipple

Part #	Size	Price
012682	1-1/2" x 2"	
012690	1-1/2" x 2-1/2"	
012694	1-1/2" x 3"	
012697	1-1/2" x 3-1/2"	
012724	1-1/2" x 4"	
012726	1-1/2" x 4-1/2"	
012729	1-1/2" x 5"	
012731	1-1/2" x 5-1/2"	
012736	1-1/2" x 6"	
012580	1-1/2" x 10"	
012667	1-1/2" x 12"	

2" Std Wt Galv Steel Nipple

Part #	Size	Price
013805	2" x Close	
014234	2" x 2-1/2"	
014242	2" x 3"	
014245	2" x 3-1/2"	
014262	2" x 4"	
014266	2" x 4-1/2"	
014272	2" x 5"	
014275	2" x 5-1/2"	
014284	2" x 6"	
014289	2" x 8"	
013965	2" x 12"	

2-1/2" Std Wt Galv Steel Nipple

Part #	Size	Price
014080	2-1/2" x Close	
014191	2-1/2" x 6"	

3" Std Wt Galv Steel Nipple

Part #	Size	Price
014344	3" x Close	
014572	3" x 3"	
014709	3" x 4"	
014828	3" x 4-1/2"	
014950	3" x 5"	
014956	3" x 6"	

4" Std Wt Galv Steel Nipple

Part #	Size	Price
015498	4" x 6"	
175253	4" x 3-1/2"	

Galvanized Steel Nipple Sets

60 Pack Galv Steel Nipple Assortment

Part #	Size	Price
012243	1" Special-6	
175255	1-1/4"	

66 Pack Galv Steel Nipple Assortment

Part #	Size	Price
013143	1/2" Special-6	
014711	3/4" Special-6	

Pipe Fittings

Geothermal Fittings

Headers & Manifolds

Parallel Header

• Sold individually



Part #	Mfg #	Description	Price
055101	SK644K02	1-1/4" Inlet x (3) 3/4" Outlets	
055102	SK644K03	1-1/4" Inlet x (4) 3/4" Outlets	
054876	SK644K03H	1-1/4" Inlet x (4) 3/4" Outlet Alternated	
055103	SK644K04	1-1/4" Inlet x (5) 3/4" Outlets	
054877	SK644K04H	1-1/4" Inlet x (5) 3/4" Outlet Alternated	
055104	SK644K05	1-1/4" Inlet x (6) 3/4" Outlets	

Socket Fusion Fittings

Socket Fusion Coupling



Part #	Mfg #	Size	Price
026588	SPC44	3/4" X 3/4"	
026584	SPC64	1-1/4" x 3/4"	
026585	SPC65	1-1/4" x 1"	
026590	SPC66	1-1/4" x 1-1/4"	
026587	SPC86	2" x 1-1/4"	
054712	SPC88	2" x 2"	

Socket Fusion 90° Elbow



Part #	Mfg #	Size	Price
054837	SPE44	3/4" x 3/4"	
054838	SPE55	1" x 1"	
054844	SPE64	1-1/4" x 3/4"	
054839	SPE66	1-1/4" x 1-1/4"	
054840	SPE77	1-1/2" x 1-1/2"	
054841	SPE88	2" x 2"	

Socket Fusion 45° Elbow



Part #	Mfg #	Size	Price
054848	SPE66-45	1-1/4" x 1-1/4"	
134037	SPE88-45	2" x 2"	

Socket Fusion End Cap



Part #	Mfg #	Size	Price
026626	SPCP4	3/4"	

Socket Fusion Tee



Part #	Mfg #	Size	Price
026579	SPT444	3/4" x 3/4" x 3/4"	
054728	SPT644	1-1/4" x 3/4" x 3/4"	
054729	SPT664	1-1/4" x 1-1/4" x 3/4"	
054731	SPT665	1-1/4" x 1-1/4" x 1"	
026581	SPT666	1-1/4" x 1-1/4" x 1-1/4"	
054732	SPT884	2" x 2" x 3/4"	
092936	SPT886	2" x 2" x 1-1/4"	
054734	SPT888	2" x 2" x 2"	

PE Fusion Fittings

Fusion Male Adapter



Part #	Mfg #	Description	Price
026592	SPMA44	3/4" Fusion x 3/4" MPT	
092935	SPMA65N	1-1/4" Fusion x 1" MPT Nupi	
026594	SPMA66N	1-1/4" Fusion x 1-1/4" MPT Nupi	
026595	SPMA77	1-1/2" Fusion x 1-1/2" MPT	
092938	SPMA88N	2" Fusion x 2" MPT Nupi	

Fusion Ball Valve

Part #	Mfg #	Description	Price
117033	BPEV66	1-1/4" Valve Assembly with PE Pipe	

Grooved Fittings

Gruvlok® CTS Couplings for Grooved End Pipe

7001 Standard Coupling with E Gasket

- Designed for a wide range of applications
- Housing design allows for optimum strength without excessive casting weight
- Maximum working pressure: 1,000 psi

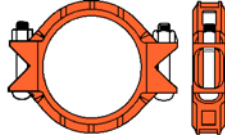

Part #	Mfg #	Size	Price
063039	7001	2"	
047680	7001	2-1/2"	
047681	7001	3"	
047682	7001	4"	
047683	7001	5"	
047684	7001	6"	
047685	7001	8"	

7401 Rigidlok™ Coupling with E Gasket

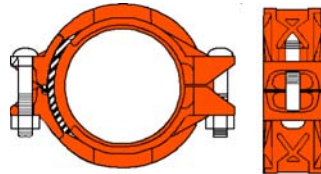

Part #	Mfg #	Size	Price
056293	7401	2"	
047503	7401	2-1/2"	
047506	7401	3"	
047507	7401	4"	
047508	7401	5"	
047509	7401	6"	
047511	7401	8"	
070798	7401	10"	
076146	7401	12"	

7401 Galvanized Rigidlok™ Coupling with E Gasket

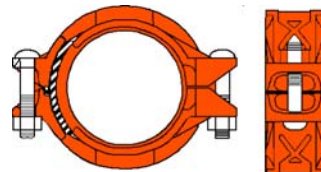

Part #	Mfg #	Size	Price
093229	7401-G	2-1/2"	
093220	7401-G	3"	
076143	7401-G	4"	

7042F Female IPS Outlet Coupling

Part #	Mfg #	Size	Price
093728	7042F	2-1/2" x 3/4"	
093727	7042F	2-1/2" x 1"	

7012 Flange with E Gasket

- Direct connection of Class 125 or 150 components



Part #	Mfg #	Size	Price
062835	7012	2"	
047633	7012	2-1/2"	
047634	7012	3"	
047635	7012	4"	
074507	7012	5"	
047636	7012	6"	
047637	7012	8"	
074504	7012	10"	

7012 Flange Seal Ring

- Recommended for use between wafer/lug type valves and Gruvlok flanges

Part #	Mfg #	Size	Price
047646	7012-FSR	2-1/2"	
047647	7012-FSR	3"	
047648	7012-FSR	4"	
103361	7012-FSR	5"	
047650	7012-FSR	8"	

7010 Reducing Coupling with E Gasket

- Maximum working pressure: 350 psi



Part #	Mfg #	Size	Price
085736	7010	6" x 4"	

7087 Female Threaded Adapter (FPT x Grv)

Part #	Mfg #	Size	Price
087090	7087	2-1/2"	
102694	7087	3"	

Grooved Fittings

Branch Outlet Systems

7045 Female Threaded Branch Clamp-T

- Rated working pressure: 500 psi



Part #	Mfg #	Size	Price
105789	7045	2" x 1/2"	
086646	7045	2" x 3/4"	
078244	7045	2-1/2" x 1/2"	
052051	7045	2-1/2" x 3/4"	
052055	7045	2-1/2" x 1"	
052056	7045	2-1/2" x 1-1/4"	
085342	7045	2-1/2" x 1-1/2"	
074238	7045	3" x 1/2"	
052049	7045	3" x 3/4"	
052054	7045	3" x 1"	
052053	7045	3" x 1-1/4"	
078243	7045	3" x 1-1/2"	
104154	7045	3" x 2"	
080423	7045	4" x 1/2"	
078646	7045	4" x 3/4"	
085741	7045	4" x 1"	
078241	7045	4" x 1-1/4"	
093896	7045	4" x 1-1/2"	
081180	7045	4" x 2"	
085344	7045	5" x 1-1/4"	
082280	7045	6" x 1-1/4"	
078648	7045	6" x 1-1/2"	
071800	7045	6" x 2"	
104129	7045	8" x 2"	

7045 Galvanized Female Threaded Branch Clamp-T

- Rated working pressure: 500 psi

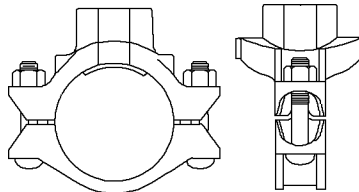

Part #	Mfg #	Size	Price
093226	7045-G	2-1/2" x 3/4"	
093241	7045-G	2-1/2" x 1"	
093940	7045-G	2-1/2" x 1-1/4"	

Grooved End Pipe Fittings

7055 90° Adapter Elbow

- Gr x MPT



Part #	Mfg #	Size	Price
182715	7055	2"	

7050 90° Elbow



Part #	Mfg #	Size	Price
063038	7050	2"	
047617	7050	2-1/2"	
047618	7050	3"	
167698	7050	3-1/2"	
047619	7050	4"	
047643	7050	5"	
047620	7050	6"	
047621	7050	8"	
077186	7050	12"	

7050 Galvanized 90° Elbow

Part #	Mfg #	Size	Price
094094	7050-G	2-1/2"	
076150	7050-G	4"	
093918	7050-G	6"	

7051 45° Elbow



Part #	Mfg #	Size	Price
063036	7051	2"	
047622	7051	2-1/2"	
047623	7051	3"	
047624	7051	4"	
047625	7051	6"	
047626	7051	8"	

Grooved Fittings

Grooved End Pipe Fittings (Continued)

7051 45° Elbow

Part #	Mfg #	Size	Price
070793	7051	10"	
077185	7051	12"	

7051 Galvanized 45° Elbow

Part #	Mfg #	Size	Price
093935	7051-G	3"	
093957	7051-G	4"	

7052 22-1/2° Elbow



Part #	Mfg #	Size	Price
062803	7052	2-1/2"	
104130	7052	3"	
104131	7052	4"	
076257	7052	6"	

7060 Tee



Part #	Mfg #	Size	Price
063040	7060	2"	
047627	7060	2-1/2"	
047628	7060	3"	
047629	7060	4"	
047645	7060	5"	
047630	7060	6"	
047631	7060	8"	

7060 Galvanized Tee

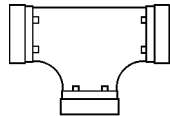

Part #	Mfg #	Size	Price
094093	7060-G	2-1/2"	
076147	7060-G	4"	

7061 Standard Reducing Tee (Grv x Grv x Grv)



Part #	Mfg #	Size	Price
060008	7061	2-1/2" x 2"	
052064	7061	3" x 2"	
060009	7061	3" x 2-1/2"	
082290	7061	4" x 2"	
060179	7061	4" x 2-1/2"	
052067	7061	4" x 3"	
085331	7061	5" x 2-1/2"	
078848	7061	5" x 3"	
076139	7061	5" x 4"	
078664	7061	6" x 2"	
074777	7061	6" x 3"	
070796	7061	6" x 4"	
082289	7061	6" x 5"	
076138	7061	8" x 4"	
093983	7061	8" x 6"	

7064 Branch Reducing Tee (Thrd)

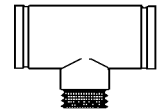

Part #	Mfg #	Size	Price
094960	7064	2-1/2" x 1-1/2"	
078699	7064	2-1/2" x 2"	
076768	7064	3" x 3/4"	
060175	7064	3" x 2"	
111245	7064	4" x 1-1/4"	
060174	7064	4" x 1-1/2"	
104138	7064	4" x 2"	

7260 Tee Strainer

- Strainer basket made of stainless steel type 304 bar and woven wire screen
- Maximum working pressure: 750 psi

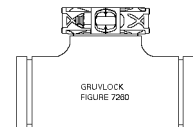

Part #	Mfg #	Size	Price
079056	7260	4"	
082284	7260	6"	

Grooved Fittings

7072 Concentric Reducer (Grv x Grv)



Part #	Mfg #	Size	Price
052959	7072	2-1/2" x 2"	
052955	7072	3" x 2"	
052978	7072	3" x 2-1/2"	
056294	7072	4" x 2"	
052977	7072	4" x 2-1/2"	
047675	7072	4" x 3"	
167421	7072	4" x 3-1/2"	
047676	7072	5" x 4"	
060181	7072	6" x 3"	
047677	7072	6" x 4"	
098606	7072	8" x 4"	
047678	7072	8" x 6"	
070797	7072	10" x 6"	
078645	7072	12" x 8"	
094001	7072	12" x 10"	

7072 Galvanized Concentric Reducer (Grv x Grv)



Part #	Mfg #	Size	Price
076149	7072-G	4" x 3"	

7076 Concentric Reducer (Grv x MIP)



Part #	Mfg #	Size	Price
102695	7076	2" x 1-1/2"	
099291	7076	2-1/2" x 1-1/4"	
080422	7076	2-1/2" x 1-1/2"	
074778	7076	3" x 1"	
076769	7076	3" x 1-1/2"	
076141	7076	3" x 2"	
076140	7076	4" x 2"	

7076 Galvanized Concentric Reducer (Grv x MIP)



Part #	Mfg #	Size	Price
093223	7076-G	2-1/2" x 1-1/2"	

Grooved End Pipe Fittings (Continued)

7076 Galvanized Concentric Reducer (Grv x MIP)

Part #	Mfg #	Size	Price
093939	7076-G	3" x 2"	

7073 Eccentric Reducer (Grv x Grv)

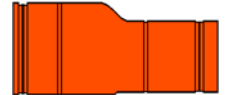

Part #	Mfg #	Size	Price
082293	7073	3" x 2"	
081541	7073	3" x 2-1/2"	
082287	7073	6" x 4"	

7097 Eccentric Reducer (Grv x Thrd)

Part #	Mfg #	Size	Price
085329	7097	2-1/2" x 2"	

7074 Cap



Part #	Mfg #	Size	Price
063041	7074	2"	
047638	7074	2-1/2"	
047639	7074	3"	
047640	7074	4"	
047641	7074	6"	
047642	7074	8"	

6074 CTS Cap



Part #	Mfg #	Size	Price
121634	6074	2"	
121635	6074	2-1/2"	
121636	6074	3"	
121637	6074	4"	

7080 Adapter Nipples (GR x GR)

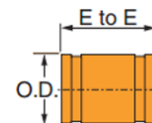

Part #	Mfg #	Size	Price
183256	7080	2" x 4"	

Grooved Fittings

Grooved End Pipe Fittings (Continued)

7080 Adapter Nipples (GR x GR)

Part #	Mfg #	Size	Price
183257	7080	2" x 8"	
183258	7080	2" x 12"	

7081 Adapter Nipples (Gr x MPT)

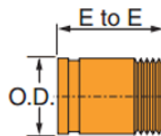

Part #	Mfg #	Size	Price
183259	7081	2" x 4"	
183260	7081	2" x 8"	
183261	7081	2" x 12"	

7081F Adapter Nipple (Grv x MIP)



Part #	Mfg #	Size	Price
047775	7081F	2" x 4"	
047776	7081F	2-1/2" x 4"	
047777	7081F	3" x 4"	

Flange Adapter



Part #	Mfg #	Size	Price
171563	7788	2"	
171564	7788	2-1/2"	
171565	7788	3"	
171566	7788	4"	
171567	7788	5"	
171568	7788	6"	
171569	7788	8"	

Gruvlok® Copper Method

7400 Rigidlite™ Coupling



Part #	Mfg #	Size	Price
069868	7400	2"	
069869	7400	2-1/2"	

Gruvlok® Copper Method (Continued)

7400 Rigidlite™ Coupling

Part #	Mfg #	Size	Price
069870	7400	3"	
069871	7400	4"	
069873	7400	6"	

Gruvlok® Di-Lok® Nipples

7088 Di-Electric Pipe Connection (Grv x MIP)



Part #	Mfg #	Size	Price
078242	7088	2" x 4"	
075544	7088	2-1/2" x 6"	

7090 Di-Electric Pipe Connection (Thrd x Thrd)



Part #	Mfg #	Size	Price
110497	7090	3/4" x 3"	
110498	7090	1" x 4"	

Grooved Fittings for Plain End Pipe

7005 Roughneck™ Coupling

- Gripper action provides positive pipe joint
- Maximum working pressure: 750 psi



Part #	Mfg #	Size	Price
047780	7005	2"	
047781	7005	2-1/2"	
047782	7005	3"	
047783	7005	4"	
104146	7005	8"	

Grooved Fittings

Gruvlok® Valves

7721 Lever/Lock Butterfly Valve

- 10-Position
- EPDM Disc coating



047771	GN7721-3	3"
047772	GN7721-3	4"
069881	GN7721-3	5"
047773	GN7721-3	6"
047774	GN7721-3	8"

7700 Ductile Iron Body Grooved CTS BFV with Gear Operating Mechanism

- Upper and lower shaft are type 416 stainless steel
- Spherical bore of the disc seat area for constant disc-to-seat loading
- Rated to 300 psi dead-end service
- EPDM (Grade E) disc coating
- One-piece casting with integral mounting base
- Nylon body coating



074509	GN-7722-3	8"
--------	-----------	----

7800 Check Valve

- Maximum working pressure: 300 psi



085347	7811	2-1/2"
085349	7811	3"
104143	7811	4"
104144	7811	6"

GBV-G Grooved End Straight Balancing Valve

- Pressure differential ports on both sides of valve
- Positive shut-off for equipment servicing
- Multi-turn adjustment
- Maximum working temperature: 300°F
- Maximum working pressure: 300 psi

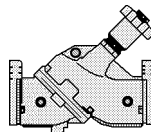

122590	GBV-G	3"
--------	-------	----

SMITH-COOPER
INTERNATIONAL

Cooplok™ Orange Painted Grooved Fittings

Concentric Reducer

- Ductile iron
- Orange painted coating



Part #	Size	Price
164275	2-1/2" x 2"	
164276	3" x 2"	
164277	3" x 2-1/2"	
164278	4" x 2"	
164280	4" x 2-1/2"	
164281	4" x 3"	
164282	6" x 2-1/2"	
164283	6" x 3"	
164284	6" x 4"	

Cap

- Ductile iron
- Orange painted coating



Part #	Size	Price
164251	2"	
164252	2-1/2"	
164253	3"	
164254	4"	
164255	5"	
164256	6"	
164257	8"	

90° Elbow

- Ductile iron
- Orange painted coating



Part #	Size	Price
164223	2"	
164224	2-1/2"	
164225	3"	
164226	4"	
164227	5"	

Grooved Fittings

Cooplok™ Orange Painted Grooved Fittings (Continued)

90° Elbow

Part #	Size	Price
164228	6"	
164229	8"	

Grooved x Flange Adapter

- Ductile iron
- Orange painted coating



Part #	Size	Price
164258	2"	
164259	2-1/2"	
164260	3"	
164261	4"	
164262	6"	
164263	8"	

Hinged Flange Adapter

- Ductile iron
- Orange painted coating



Part #	Size	Price
164214	2"	
164215	2-1/2"	
164216	3"	
164217	4"	
164218	5"	
164219	6"	
164220	8"	

45° Elbow

- Ductile iron
- Orange painted coating



Part #	Size	Price
164230	2"	
164231	2-1/2"	

Cooplok™ Orange Painted Grooved Fittings (Continued)

45° Elbow

Part #	Size	Price
164232	3"	
164233	4"	
164234	5"	
164235	6"	
164236	8"	

22-1/2° Elbow

- Ductile iron -full flow
- Orange painted coating



Part #	Size	Price
164237	2"	
164238	2-1/2"	
164239	3"	
164240	4"	
164241	5"	
164242	6"	
164243	8"	

Tee

- Ductile iron
- Orange painted coating



Part #	Size	Price
164244	2"	
164245	2-1/2"	
164246	3"	
164247	4"	
164248	5"	
164249	6"	
164250	8"	

Reducing Tee

- Ductile iron
- Orange painted coating



Part #	Size	Price
164286	4" x 4" x 2-1/2"	
164287	4" x 4" x 3"	

Rigid Coupling

- Ductile iron
- Orange painted coating
- EPDM "C" gasket



Part #	Size	Price
164201	2"	
164204	2-1/2"	
164205	3"	
164206	4"	
164208	5"	
164209	6"	

Mechanical Tee

- Ductile iron
- Threaded outlet
- Orange painted coating



Part #	Size	Price
167122	2" x 1/2"	
167123	2" x 3/4"	
167124	2" x 1"	
167125	2" x 1-1/4"	
164265	2" x 1-1/2"	
167126	2-1/2" x 1/2"	
167127	2-1/2" x 3/4"	
167128	2-1/2" x 1"	
167129	2-1/2" x 1-1/4"	
164266	2-1/2" x 1-1/2"	
167130	3" x 1"	
167131	3" x 1-1/4"	
167132	3" x 1-1/2"	
164268	3" x 2"	
167133	4" x 1"	
167134	4" x 1-1/4"	
167135	4" x 1-1/2"	
167136	4" x 2"	
167137	4" x 2-1/2"	

Grooved Fittings

Cooplok™ Orange Painted Grooved Fittings (Continued) Mechanical Tee

Part #	Size	Price
164269	4" x 3"	
167138	5" x 1-1/4"	
167139	5" x 1-1/2"	
167140	5" x 2"	
167141	5" x 2-1/2"	
164270	5" x 3"	
167142	6" x 1-1/4"	
167143	6" x 1-1/2"	
167144	6" x 2"	
167145	6" x 2-1/2"	
167146	6" x 3"	
164271	6" x 4"	
167147	8" x 2"	
167148	8" x 2-1/2"	
167149	8" x 3"	
164272	8" x 4"	

Cooplok™ Grooved Valves Lever Handle Butterfly

- Series 67BFV



Part #	Size	Price
164289	2"	
164291	2-1/2"	
164292	3"	
164293	4"	
164294	5"	
164295	6"	
164296	8"	

Insert Fittings

Nylon Barbed Fittings

FIPT Adapter

- 2/Pack



Barb x Male

Part #	Mfg #	Description	Price
139722	701-053	1/2" Barb x 3/4" FIPT	

MIPT Adapter

- 2/Pack



Part #	Mfg #	Description	Price
169848	701-001B	1/2" Barb x 1/2" MIPT	
169849	701-002B	1/2" Barb x 3/4" MIPT	
169850	701-004B	1/4" Barb x 1/4" MIPT	
169852	701-007B	3/4" Barb x 3/4" MIPT	
169853	701-012B	3/8" Barb x 1/2" MIPT	
169854	701-013B	3/8" Barb x 3/8" MIPT	
166855	701-014B	5/8" Barb x 3/4" MIPT	

FPT 90° Elbow

- 2/Pack unless marked bulk

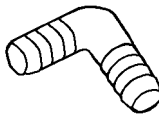

Barb x Barb



Barb x MPT

Part #	Mfg #	Description	Price
141559	701-019	1/2" Barb x 3/4" FPT	

Insert Fittings For PE



Nylon Insert Fittings for Polyethylene Pipe

Nylon Bushing

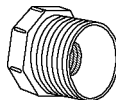

Part #	Size	Price
007791	3/4" x 1/2"	
007789	1" x 3/4"	
007788	1-1/4" x 1"	
007787	1-1/2" x 1-1/4"	
007790	2" x 1-1/2"	

BRAMEC®

Packaged Nylon Fittings

- For vinyl, supertube and other plastic tubing

Packaged Nylon 90° Elbow

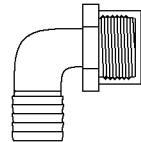

MIP x Barb

Part #	Mfg #	Size	Qty	Price
002275	0623	5/8" Barb x 3/4" FIP	4/Pkg	

MERRILL

Plastic Insert Fittings

- For flexible (polyethylene) plastic pipe

Poly Male Adapter

- Plastic pipe to male iron pipe (MIP)



Part #	Mfg #	Size	Price
013491	PMA50	1/2" x 1/2" MIP	
006648	PMA75	3/4" x 3/4" MIP	
006641	PMA1075	3/4" x 1" MIP	
006639	PMA100	1" x 1" MIP	
006643	PMA12510	1" x 1-1/4" MIP	
006642	PMA125	1-1/4" x 1-1/4" MIP	
006644	PMA150	1-1/2" x 1-1/2" MIP	
006645	PMA200	2" x 2" MIP	

Nylon Male Adapter

- Plastic pipe to male iron pipe (MIP)

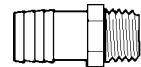

Part #	Mfg #	Size	Price
006607	NMA75	3/4" x 3/4" MIP	
006605	NMA100	1" x 1" MIP	

PVC Male Adapter

- Plastic pipe to male iron pipe (MIP)

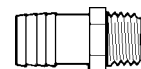

Part #	Mfg #	Size	Price
006638	PVCMA7550	1/2" x 3/4" MIP	
006647	PVCMA5075	3/4" x 1/2" MIP	

Pipe Fittings

Insert Fittings

Plastic Insert Fittings (Continued)

PVC Male Adapter

Part #	Mfg #	Size	Price
006649	PVCMA7510	1" x 3/4" MIP	

PVC Female Adapter

- Plastic pipe to female iron pipe (FIP)

Part #	Mfg #	Size	Price
006632	PVCFA50	1/2" x 1/2" FIP	
006633	PVCFA75	3/4" x 3/4" FIP	
006630	PVCFA100	1" x 1" FIP	
006631	PVCFA125	1-1/4" x 1-1/4" FIP	

Poly Coupling

- Plastic pipe to plastic pipe



Part #	Mfg #	Size	Price
006616	PCP50	1/2" x 1/2"	
006617	PCP75	3/4" x 3/4"	
006608	PCP100	1" x 1"	
006610	PCP125	1-1/4" x 1-1/4"	
006614	PCP150	1-1/2" x 1-1/2"	
006615	PCP200	2" x 2"	

Poly Reducing Coupling

- Plastic pipe to plastic pipe



Part #	Mfg #	Size	Price
006609	PCP1075	1" x 3/4"	

Poly Insert Plugs

- Plastic pipe

Part #	Mfg #	Size	Price
006651	PPL125	1-1/4"	

PVC Insert Plugs

- Plastic pipe

Part #	Mfg #	Size	Price
006653	PVCPL75	3/4"	

Plastic Insert Fittings (Continued)

PVC Insert Plugs

Part #	Mfg #	Size	Price
006650	PVCPL100	1"	

Poly Insert Tee

- Plastic pipe to plastic pipe



Part #	Mfg #	Size	Price
006667	PTP50	1/2" x 1/2" x 1/2"	
006668	PTP75	3/4" x 3/4" x 3/4"	
006661	PTP100	1" x 1" x 1"	

PVC Combination Insert Tee

- Plastic pipe to female iron pipe (FIP)

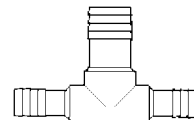

Part #	Mfg #	Size	Price
006659	PVCTF75	3/4" x 3/4" x 3/4" FIP	
006657	PVCTF1075	1" x 1" x 3/4" FIP	

Poly Elbow

- Plastic pipe to plastic pipe



Part #	Mfg #	Size	Price
006628	PEP50	1/2" x 1/2"	
006629	PEP75	3/4" x 3/4"	
006624	PEP100	1" x 1"	
006625	PEP125	1-1/4" x 1-1/4"	

Nylon Elbow

- Plastic pipe to plastic pipe

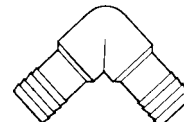

Part #	Mfg #	Size	Price
006603	NEP100	1" x 1"	

Pipe Fittings

Insert Fittings

Poly Combination Elbow

- Plastic pipe to male iron pipe (MIP)



Part #	Mfg #	Size	Price
060414	PHE50	1/2" x 1/2" MIP	
006636	PHE75	3/4" x 3/4" MIP	
006635	PHE100	1" x 1" MIP	

PVC Combination Elbow

- Plastic pipe to female iron pipe (FIP)

Part #	Mfg #	Size	Price
006623	PVCEF75	3/4" x 3/4" FIP	

Yellow Brass Insert Fittings

- For flexible (polyethylene) plastic pipe

Yellow Brass Solder Adapter

- Plastic pipe to copper tube (Swt)



Part #	Mfg #	Size	Price
006595	IBSA100	1" x 1"	
006596	IBSA125	1-1/4" x 1-1/4"	

Red & Yellow Brass Hydrant Elbow

- Plastic pipe to male iron pipe (MIP)

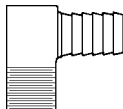

Part #	Mfg #	Size	Price
006689	RBHE75	3/4" x 3/4" MIP	

Red & Yellow Brass Tee

- Plastic pipe to plastic pipe

Part #	Mfg #	Size	Price
018821	BTP1075	1" x 1" x 3/4"	

Red Brass Insert Fittings

- For flexible (polyethylene) plastic pipe

Red Brass Male Adapter

- Plastic pipe to male iron pipe (MIP)



Part #	Mfg #	Size	Price
006697	RBMA50	1/2" x 1/2" MIP	
006698	RBMA75	3/4" x 3/4" MIP	
006693	RBMA1075	1" x 3/4" MIP	
006692	RBMA100	1" x 1" MIP	
057635	RBMA2510	1" x 1-1/4" MIP	
124175	RBMA1025	1-1/4" x 1" MIP	
006694	RBMA125	1-1/4" x 1-1/4" MIP	
006695	RBMA150	1-1/2" x 1-1/2" MIP	
006696	RBMA200	2" x 2" MIP	

Red Brass Female Adapter

- Plastic pipe to female iron pipe (FIP)



Part #	Mfg #	Size	Price
006685	RBFA50	1/2" x 1/2" FIP	
006686	RBFA75	3/4" x 3/4" FIP	
006682	RBFA100	1" x 1" FIP	
006683	RBFA125	1-1/4" x 1-1/4" FIP	
006684	RBFA150	1-1/2" x 1-1/2" FIP	

Red Brass Coupling

- Plastic pipe to plastic pipe with hex



Part #	Mfg #	Size	Price
006675	RBCP75	3/4" x 3/4"	
086542	RBCP7510	3/4" x 1"	
006670	RBCP100	1" x 1"	

Insert Fittings

Red Brass Insert Fittings (Continued)

Red Brass Coupling

Part #	Mfg #	Size	Price
050019	RBCP1025	1" x 1-1/4"	
006671	RBCP125	1-1/4" x 1-1/4"	
006672	RBCP150	1-1/2" x 1-1/2"	
006673	RBCP200	2" x 2"	

Red Brass Elbow

- Plastic pipe to plastic pipe



Part #	Mfg #	Size	Price
006678	RBDE75	3/4" x 3/4"	
006676	RBDE100	1" x 1"	
006677	RBDE125	1-1/4" x 1-1/4"	
114147	RBDE150	1-1/2" x 1-1/2"	

Red Brass Combination Elbow

- Plastic pipe to male iron pipe (MIP)



Part #	Mfg #	Size	Price
006687	RBHE100	1" x 1" MIP	
006688	RBHE1000	1" x 1" MIP	

Red Brass Tee

- Plastic pipe to plastic pipe



Part #	Mfg #	Size	Price
006681	RBDT75	3/4"	
006690	RBHT75	3/4"	
006691	RBHT7510	1" x 3/4" x 1"	
006679	RBDT100	1"	
006680	RBDT125	1-1/4"	

Pipe Fittings

Iron & Carbon Steel Fittings & Nipples

Merchant Steel Fittings

Recessed API5L Coupling

- Threaded
- Merchant Steel



Part #	Size	Price
176314	1/4"	
176315	3/8"	
176316	1/2"	
176317	3/4"	
176318	1"	
176319	1-1/4"	
176320	1-1/2"	
176321	2"	
176322	2-1/2"	
176323	3"	

Malleable Iron Fittings

Black Cap

- 300# Threaded
- Malleable iron



Part #	Size	Price
176210	1/4"	
176211	3/8"	
064805	1/2"	
064806	3/4"	
025149	1"	
176212	1-1/4"	
176213	1-1/2"	
176214	2"	
176215	2-1/2"	
176216	3"	

Black 90° Elbow

- 300# Threaded
- Malleable iron



Part #	Size	Price
013478	1/4"	
076779	3/8"	
013057	1/2"	
014636	3/4"	

Malleable Iron Fittings (Continued)

Black 90° Elbow

Part #	Size	Price
012195	1"	
027550	1-1/4"	
012394	1-1/2"	
013765	2"	
096077	2-1/2"	
176218	3"	

Black 45° Elbow

- 300# Threaded
- Malleable iron



Part #	Size	Price
176219	1/4"	
176220	3/8"	
027551	1/2"	
026082	3/4"	
027552	1"	
012775	1-1/4"	
027553	1-1/2"	
027554	2"	
176221	2-1/2"	
176222	3"	

Black 90° Street Elbow

- 300# Threaded
- Malleable iron



Part #	Size	Price
013471	1/4"	
176286	3/8"	
051781	1/2"	
014634	3/4"	
012187	1"	
034546	1-1/4"	
176287	1-1/2"	
132514	2"	
176288	3"	

Black Reducing Coupling

- 300# Threaded
- Malleable iron



Part #	Size	Price
176258	3/8" x 1/4"	
019102	1/2" x 1/4"	
027176	1/2" x 3/8"	
176259	3/4" x 3/8"	
021421	3/4" x 1/2"	
176260	1" x 1/2"	
064808	1" x 3/4"	
144739	1-1/4" x 1/2"	
132509	1-1/4" x 3/4"	
064809	1-1/4" x 1"	
155112	1-1/2" x 1/2"	
132510	1-1/2" x 3/4"	
076778	1-1/2" x 1"	
021422	1-1/2" x 1-1/4"	
176262	2" x 1/2"	
076775	2" x 3/4"	
132088	2" x 1"	
132087	2" x 1-1/4"	
055659	2" x 1-1/2"	
176263	2-1/2" x 1-1/2"	
132512	2-1/2" x 2"	
176264	3" x 2"	

Black Tee

- 300# Threaded
- Malleable iron



Part #	Size	Price
176289	1/4"	
176290	3/8"	
013055	1/2"	
014635	3/4"	
012193	1"	
027555	1-1/4"	
027556	1-1/2"	
027557	2"	
129478	2-1/2"	
176291	3"	

Pipe Fittings

Iron & Carbon Steel Fittings & Nipples

Black Union with Brass Seat

- 300# Threaded
- Malleable iron



Part #	Size	Price
176292	1/4"	
176293	3/8"	
013056	1/2"	
014631	3/4"	
012194	1"	
012772	1-1/4"	
012393	1-1/2"	
013764	2"	
095254	2-1/2"	
176294	3"	

Black Reducing Tee

- 300# Threaded
- Malleable iron



Part #	Size	Price
075661	3/4" x 3/4" x 1/2"	
154334	1" x 1" x 1/2"	
165081	1" x 1" x 3/4"	
176279	1-1/4" x 1-1/4" x 1/2"	
144681	1-1/4" x 1-1/4" x 3/4"	
104415	1-1/4" x 1-1/4" x 1"	
155125	1-1/2" x 1-1/2" x 1/2"	
094249	1-1/2" x 1-1/2" x 3/4"	
094248	1-1/2" x 1-1/2" x 1"	
094250	1-1/2"x1-1/2"x1-1/4"	
132089	2" x 2" x 1/2"	
094269	2" x 2" x 3/4"	
055656	2" x 2" x 1"	
132511	2" x 2" x 1-1/4"	
155126	2" x 2" x 1-1/2"	
176280	2-1/2" x 2-1/2" x 2"	
176281	3" x 3" x 2"	



John Guest Fittings

Mur-lok® Polypropylene Quick-Connect Fittings & Valves

- All polypropylene construction
- Dual EPDM Chloramine-resistant o-ring technology
- Designed for use with polyethylene, polypropylene, nylon, polyurethane, and soft metal tubing
- The use of hose stems and clamps is required when using braided plastic hose

Mur-lok® Male NPTF Connector

Part #	Mfg #	Thread	Mur-lok	Price
052027	O0420416	1/4" Male NPTF	1/4"	
052028	O0420616	3/8" Male NPTF	1/4"	
052029	O0620616	3/8" Male NPTF	3/8"	
052030	O0620816	1/2" Male NPTF	3/8"	

Mur-lok® Union Connector

Part #	Mfg #	Mur-lok	Mur-lok	Price
052031	R0420426	1/4"	1/4"	
052032	R0620426	3/8"	1/4"	
052033	R0620626	3/8"	3/8"	

Mur-lok® Faucet/Refrigerator Connectors

Part #	Mfg #	Thread	Mur-lok	Price
052034	U0420706	7/16" - 24 UNS	1/4"	
052035	U0620706	7/16" - 24 UNS	3/8"	

Mur-lok® Union Tees

Part #	Mfg #	Mur-lok	Price
052036	V0420426	1/4"	
052038	V0620426	3/8" x 3/8" x 1/4"	
052037	V0620626	3/8"	

Mur-lok® End Stops

Part #	Mfg #	Mur-lok	Price
052040	W0620006	3/8"	



John Guest® Super Speedfit® Fittings Speedfit® 90° Union Elbow

Part #	Mfg #	Size	Price
104607	PI0312S	3/8" JG x 3/8" JG	

Speedfit® 90° Union Tee

Part #	Mfg #	Size	Price
150353	PI0316S	1/2" JG x 1/2" JG	

Speedfit® Union Connectors

Part #	Mfg #	Size	Price
150354	PI201612S	1/2" JG x 3/8" JG	

Speedfit® Female Connectors

Part #	Mfg #	Size	Price
090453	PI451222S	3/8" JG x 1/4" Female NPTF	



John Guest® Polypropylene Shut-Off Valves

Inline Shut-Off Valve

Part #	Mfg #	Size	Price
051651	PPSV040808W	1/4" JG x 1/4" JG	
051654	PPSV041212W	3/8" JG x 3/8" JG	

Self-Piercing Saddle Valves

Part #	Mfg #	Description	Price
094414	SV9	1/4" Brass Compression	



Lav Waste Fittings

LabWaste™ CPVC Corrosive Waste Drainage System Fittings

CPVC Coupling (H x H)



Part #	Mfg #	Size	Price
098138	P100-015C	1-1/2"	
085949	P100-020C	2"	
085951	P100-030C	3"	
089664	P100-040C	4"	

CPVC Female Adapter (FPT x H)

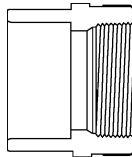

Part #	Mfg #	Size	Price
132478	P101-015C	1-1/2"	

CPVC Pipe Increaser - Reducer (H x H)

Part #	Mfg #	Size	Price
089673	P102-251C	2" x 1-1/2"	
089676	P102-338C	3" x 2"	
089677	P102-422C	4" x 3"	

* Fabricated

CPVC Flush Bushing Cleanout Adapter (S x FPT)

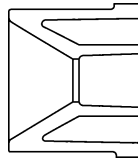

Part #	Mfg #	Size	Price
085952	P107-338C	3" x 2"	
116234	P107-420C	4" x 2"	
089678	P107-422C	4" x 3"	

CPVC Male Adapter (MPT x H)

- Will not accept tail piece

Part #	Mfg #	Size	Price
087918	P109-015C	1-1/2"	
082201	P109-020C	2"	

CPVC 90° Elbow (H x H)



Part #	Mfg #	Size	Price
089859	P300-015C	1-1/2"	
085954	P300-020C	2"	
116658	P300-030C	3"	
095523	P300-040C	4"	

CPVC 90° Street Elbow (S x H)

Part #	Mfg #	Size	Price
116783	P302-015C	1-1/2"	
113828	P302-020C	2"	
089868	P302-040C	4"	

CPVC 90° Long Bend Elbow (H x H)

Part #	Mfg #	Size	Price
120228	P304-015C	1-1/2"	

CPVC 45° Elbow (H x H)

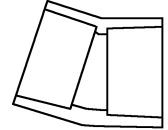

Part #	Mfg #	Size	Price
085955	P321-015C	1-1/2"	
085956	P321-020C	2"	
085957	P321-030C	3"	
089665	P321-040C	4"	

CPVC 45° Street Elbow (H x S)

Part #	Mfg #	Size	Price
085958	P323-015C	1-1/2"	
085960	P323-020C	2"	
085961	P323-030C	3"	
089666	P323-040C	4"	

CPVC 22° Elbow (H x H)

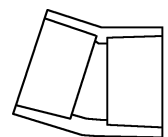

Part #	Mfg #	Size	Price
139086	P324-020C	2"	

Pipe Fittings



Lav Waste Fittings

CPVC Sanitary Tee (H x H x H)



Part #	Mfg #	Size	Price
108601	P400-015C	1-1/2"	
085962	P400-020C	2"	
113833	P400-030C	3"	
090068	P400-040C	4"	

CPVC Reducing Wye (All Hub)



Part #	Mfg #	Size	Price
139224	P601-251C	2" x 2" x 1-1/2"	
085966	P601-338C	3" x 3" x 2"	

CPVC Reducing Sanitary Tee (H x H x H)



Part #	Mfg #	Size	Price
085963	P401-251C	2" x 2" x 1-1/2"	
118876	P401-338C	3" x 3" x 2"	

CPVC P-Trap (H x H)

Part #	Mfg #	Size	Price
085967	P706X-020C	2"	
089671	P706X-030C	3"	
095528	P706X-040C	4"	

CPVC Adjustable P-Trap with Plastic Nut (H x H)

Part #	Mfg #	Size	Price
085969	P708P-015C	1-1/2"	
122907	P708P-020C	2"	

CPVC Reducing Double Sanitary Tee (All Hub)

Part #	Mfg #	Size	Price
121027	P429-251C	2" x 2" x 1-1/2" x 1-1/2"	

CPVC L.A. Pattern P-Trap (Slip x H) with Plastic Nut & Washer

Part #	Mfg #	Size	Price
116785	P711P-015C	1-1/2"	

CPVC Cleanout Tee with Cleanout Plug (H x H)

Part #	Mfg #	Size	Price
095524	P444X-020C	2"	

CPVC Tail Piece with Nut

Part #	Mfg #	Size	Price
120225	LWTPN 015060	1-1/2" x 6"	

CPVC Wye (All Hub)



Part #	Mfg #	Size	Price
085964	P600-020C	2"	
085965	P600-030C	3"	
089668	P600-040C	4"	

Pipe Fittings

Orion Rionfuse Fittings

Rionfuse® Acid Waste Fittings

Rionfuse® 45° Wye

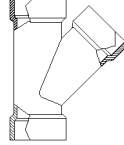

Part #	Mfg #	Size	Price
120783	RF-45Y	3"	

Rionfuse® Sanitary Tee

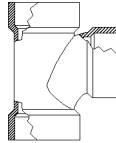

Part #	Mfg #	Size	Price
148615	RF-90T	3"	

Rionfuse® Coupling

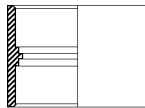

Part #	Mfg #	Size	Price
096876	RF-CLS	1-1/2"	
096424	RF-CLS	2"	

Rionfuse® Clean Out Adapter with Plug

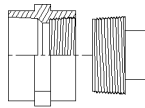

Part #	Mfg #	Size	Price
148609	RF-COA	1-1/2"	
148610	RF-COA	2"	

Rionfuse® Female Adapter

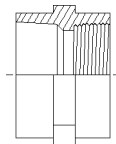

Part #	Mfg #	Size	Price
148611	RF-FA	1-1/2"	
148612	RF-FA	2"	

Rionfuse® Male Adapter

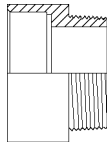

Part #	Mfg #	Size	Price
100196	RF-MA	1-1/2"	

Rionfuse® Reducing Bushing

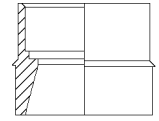

Part #	Mfg #	Size	Price
148614	RF-RB	3" x 2"	

Rionfuse® P-Trap with Unions

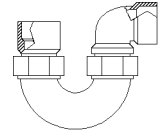

Part #	Mfg #	Size	Price
147924	RF-UTP	1-1/2"	

Rionfuse® P-Trap

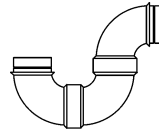

Part #	Mfg #	Size	Price
148725	RF-RBP	2"	

Rionfuse® Sink Tail Piece Extension - 12" Long



Part #	Mfg #	Size	Price
148616	RLNS12	2"	

Pipe Fittings



Polysulfone Push-Fittings

Polysulfone Push-Fit Valves & Fittings

2100A Polysulfone Coupling - Push-Fit

- CTS x CTS



Part #	Mfg #	Size	Price
141730	2100A	1/2"	
141731	2100A	3/4"	
141732	2100A	3/4" x 1/2"	

2103A Polysulfone End Cap - Push-Fit

- CTS x CTS



Part #	Mfg #	Size	Price
141734	2103A	3/4"	

2130A Polysulfone Tee - Push-Fit



Part #	Mfg #	Size	Price
141735	2130A	1/2"	
141736	2130A	3/4"	
141737	2130A	3/4" x 1/2"	

2190A Polysulfone Elbow - Push-Fit

- CTS x CTS



Part #	Mfg #	Size	Price
141738	2190A	1/2"	
141739	2190A	3/4"	

Pipe Fittings

ProPress System

Viega ProPress® Fittings

ProPress® Adapter - Female (P x FPT)

- Bronze
- Smart Connect® feature
- Press connection, female pipe thread



Part #	Mfg #	Size	Price
049054	79300	1/2" x 1/2"	
049055	77897	1/2" x 3/4"	
049058	77907	3/4" x 3/4"	
049060	77912	1" x 3/4"	
049061	77917	1" x 1"	
049063	77927	1-1/4" x 1"	
049064	77932	1-1/4" x 1-1/4"	
049065	77937	1-1/4" x 1-1/2"	
049068	77952	2" x 2"	

ProPress® Adapter - Male (P x MPT)

- Bronze
- Smart Connect® feature
- Press connection, male pipe thread



Part #	Mfg #	Size	Price
160289	79215	1/2" x 1/2"	
049021	79230	3/4" x 3/4"	
160499	79245	1" x 1"	
049026	79260	1-1/4" x 1-1/4"	
049031	79275	1-1/2" x 1-1/2"	
141776	79290	2" x 2"	

ProPress® Elbow - Female - 90° (P x FPT)

- Bronze
- Drop ear
- Smart Connect® feature
- Press connection, female pipe thread



Part #	Mfg #	Size	Price
049163	77697	1/2" x 1/2"	
049164	77702	3/4" x 3/4"	

ProPress® Elbow - Female - 90° (P x FPT)

- Bronze
- Smart Connect® feature
- Press connection, female pipe thread



Part #	Mfg #	Size	Price
153184	79535	3/4" x 1/2"	

ProPress® Elbow - Male - 90° (P x MPT)

- Bronze
- Smart Connect® feature
- Press connection, male pipe thread



Part #	Mfg #	Size	Price
049147	77497	1/2" x 3/4"	
049148	77502	3/4" x 1/2"	

ProPress® Tee (P x P x FNPT)

- Bronze
- Smart Connect® feature
- Press connection, female pipe thread



Part #	Mfg #	Size	Price
049204	79580	1/2" x 1/2" x 1/2"	
159689	79780	1-1/2" x 1-1/2" x 1/2"	

ProPress® Vent Tee (P x FPT x P)

- Bronze
- Smart Connect® feature



Part #	Mfg #	Size	Price
104993	14573	1/2" x 3/8" x 1/2"	

ProPress® Vent Elbow (P x P x FPT)

- Bronze
- Press connection, female pipe thread



Part #	Mfg #	Size	Price
173437	79640	3/4" x 3/4" x 1/8"	

Viega ProPress® Di-Electric Union (P x FPT)

- For use with ASTM B88 tubing
- Bronze
- Press connection, female pipe thread



Part #	Mfg #	Size	Price
167933	79160	3/4"	
167934	79165	1"	
167935	79170	1-1/4"	
167936	79180	2"	

ProPress System

ProPress® Union (P x P)

- Bronze
- Ground joint
- Smart Connect® feature
- Press connection



Part #	Mfg #	Size	Price
049210	79125	1/2"	
049211	79130	3/4"	
049212	79135	1"	
049213	79140	1-1/4"	
049214	79145	1-1/2"	
049215	79150	2"	

ProPress® Union (P x FPT)

- Bronze
- Ground joint
- Smart Connect® feature
- Press connection, female pipe thread



Part #	Mfg #	Size	Price
049217	77757	3/4" x 3/4"	
049218	77762	1" x 1"	

ProPress® Union - Male (P x MPT)

- Bronze
- Ground joint
- Smart Connect® feature
- Press connection, male pipe thread



Part #	Mfg #	Size	Price
149110	79735	3/4" x 3/4"	
158953	79750	1-1/2" x 1-1/2"	
049227	77807	2" x 2"	

ProPress® Adapter - Female (Ftg x FPT)

- Bronze
- Street, female pipe thread



Part #	Mfg #	Size	Price
159750	79430	1/2" x 1/2"	
049087	79445	3/4" x 3/4"	
049088	79450	1" x 1"	
049089	79465	1-1/4" x 1-1/4"	

ProPress® Adapter - Male (Ftg x MPT)

- Bronze
- Street, male pipe thread



Part #	Mfg #	Size	Price
049071	79375	1/2" x 3/8"	
049074	79380	1/2" x 1/2"	
049075	79385	1/2" x 3/4"	
049076	79390	3/4" x 1/2"	
049077	79395	3/4" x 3/4"	
049078	79405	1" x 1"	
049079	79410	1-1/4" x 1-1/4"	
049080	79415	1-1/2" x 1-1/2"	
049081	79420	2" x 2"	

ProPress® Cap (P)

- Copper
- Smart Connect® feature
- Press connection



Part #	Mfg #	Size	Price
049092	77712	1/2"	
049093	77717	3/4"	
049094	77722	1"	
049095	77727	1-1/4"	
049096	77732	1-1/2"	
049097	77737	2"	

ProPress® Coupling - with Stop (P x P)

- Copper
- Smart Connect® feature
- Press connection



Part #	Mfg #	Size	Price
049098	78047	1/2"	
049099	78052	3/4"	
049132	78057	1"	
049133	78062	1-1/4"	
049134	78067	1-1/2"	
049135	78072	2"	

ProPress® Coupling - No Stop (P x P)

- Copper
- Smart Connect® feature
- Press connection



Part #	Mfg #	Size	Price
049136	78172	1/2"	
049137	78177	3/4"	
049138	78182	1"	

Pipe Fittings

ProPress System

Veiga ProPress® Fittings (Continued)

ProPress® Coupling - No Stop (P x P)

Part #	Mfg #	Size	Price
049139	78187	1-1/4"	
049140	78192	1-1/2"	
049141	78197	2"	

ProPress® Crossover (P x P)

- Copper
- Smart Connect® feature
- Press connection



Part #	Mfg #	Size	Price
049142	77742	1/2"	
049143	77747	3/4"	

ProPress® Crossover (Ftg x P)

- Copper
- Smart Connect® feature



Part #	Mfg #	Size	Price
049144	78137	1/2"	
049145	78142	3/4"	

ProPress® Elbow - 90° (P x P)

- Copper
- Smart Connect® feature
- Press connection



Part #	Mfg #	Size	Price
048980	77317	1/2"	
048981	77322	3/4"	
048982	77327	1"	
048983	77332	1-1/4"	
048984	77337	1-1/2"	
048985	77342	2"	

ProPress® Elbow - 90° (Ftg x P)

- Copper
- Smart Connect® feature
- Press connection, street



Part #	Mfg #	Size	Price
048986	77347	1/2"	
048987	77352	3/4"	
048989	77357	1"	
048991	77362	1-1/4"	
048992	77367	1-1/2"	
048993	77372	2"	

ProPress® Elbow - 45° (P x P)

- Copper
- Smart Connect® feature
- Press connection



Part #	Mfg #	Size	Price
048994	77607	1/2"	
048995	77612	3/4"	
048996	77617	1"	
048997	77622	1-1/4"	
048998	77627	1-1/2"	
048999	77632	2"	

ProPress® Elbow - 45° (Ftg x P)

- Copper
- Smart Connect® feature
- Press connection, street



Part #	Mfg #	Size	Price
049000	77637	1/2"	
049001	77642	3/4"	
049002	77647	1"	
049003	77652	1-1/4"	
049004	77657	1-1/2"	
049005	77662	2"	

ProPress® Reducer (P x P)

- Copper
- Smart Connect® feature
- Press connection



Part #	Mfg #	Size	Price
089722	15603	1" x 1/2"	
089724	15593	1-1/4" x 3/4"	
049166	78147	3/4" x 1/2"	
049167	78152	1" x 3/4"	
049168	78157	1-1/4" x 1"	
089725	18473	1-1/2" x 3/4"	
089726	15588	1-1/2" x 1"	
049169	78162	1-1/2" x 1-1/4"	
089727	18468	2" x 3/4"	
089728	15608	2" x 1"	
049170	78167	2" x 1-1/2"	

Pipe Fittings

ProPress System

ProPress® Reducer (Ftg x P)

- Copper
- Smart Connect® feature
- Street, press connection



Part #	Mfg #	Size	Price
049171	78077	3/4" x 1/2"	
049172	78082	1" x 1/2"	
049173	78087	1" x 3/4"	
049174	78092	1-1/4" x 3/4"	
049175	78097	1-1/4" x 1"	
159119	79850	1-1/2" x 1/2"	
089730	14543	1-1/2" x 3/4"	
049176	78102	1-1/2" x 1"	
049177	78107	1-1/2" x 1-1/4"	
089731	15578	2" x 1/2"	
089732	15583	2" x 3/4"	
049178	78112	2" x 1"	
049179	78117	2" x 1-1/4"	
049180	78122	2" x 1-1/2"	

ProPress® Tee (P x P x P)

- Copper
- Smart Connect® feature
- Press connection



Part #	Mfg #	Size	Price
049181	77377	1/2" x 1/2"	
049187	77382	1/2" x 3/4"	
049188	77392	3/4" x 1/2" x 1/2"	
049189	77397	3/4" x 1/2" x 3/4"	
049190	77402	3/4" x 1/2"	
049182	77387	3/4" x 3/4"	
049191	77407	3/4" x 1"	
072291	94767	1" x 1/2" x 1"	
049192	77417	1" x 3/4" x 1/2"	
049193	77422	1" x 3/4" x 3/4"	
049194	77427	1" x 3/4" x 1"	
049195	77432	1" x 1/2"	
049196	77437	1" x 3/4"	
049183	77412	1" x 1"	
123641	22248	1-1/4" x 3/4" x 1-1/4"	
081055	14568	1-1/4" x 1" x 1"	
049198	77452	1-1/4" x 3/4"	
049197	77447	1-1/4" x 1"	
049184	77442	1-1/4" x 1-1/4"	
072289	94757	1-1/4" x 1/2"	
072290	94762	1-1/4" x 1" x 3/4"	
185198	79660	1-1/2" x 1" x 3/4"	

Viega ProPress® Fittings (Continued)

ProPress® Tee (P x P x P)

Part #	Mfg #	Size	Price
084669	15458	1-1/2" x 1" x 1"	
089741	15463	1-1/2" x 1" x 1-1/2"	
089742	15453	1-1/2" x 1-1/4" x 1"	
089706	15483	1-1/2" x 1-1/4" x 1-1/4"	
089743	15448	1-1/2" x 1-1/2" x 1/2"	
049199	77462	1-1/2" x 1-1/2" x 3/4"	
049200	77467	1-1/2" x 1-1/2" x 1"	
049201	77472	1-1/2" x 1-1/2" x 1-1/4"	
049185	77457	1-1/2" x 1-1/2" x 1-1/2"	
089744	15533	2" x 1/2" x 2"	
089746	15528	2" x 1" x 2"	
089747	15518	2" x 1-1/4" x 1-1/4"	
084668	15513	2" x 1-1/2" x 3/4"	
089749	15498	2" x 1-1/2" x 1"	
089750	15508	2" x 1-1/2" x 1-1/4"	
089751	15503	2" x 1-1/2" x 1-1/2"	
085805	15538	2" x 2" x 1/2"	
072293	94777	2" x 2" x 3/4"	
072292	94772	2" x 2" x 1"	
049203	77487	2" x 2" x 1-1/4"	
049202	77482	2" x 2" x 1-1/2"	
049186	77477	2" x 2" x 2"	

ProPress® Test Plug

- Bronze



Part #	Mfg #	Size	Price
116524	78202	1/2"	
116526	78212	1"	

Viega ProPress® XL® Fittings

ProPress® XL® Tee (P x P x P)

- Bronze



Part #	Mfg #	Size	Price
180269	20784	4" x 3" x 3"	

Pipe Fittings

ProPress System

Viega ProPress® XL-C® Fittings

ProPress® XL-C® Adapter - Male (P x MPT)

- Copper
- Smart Connect® feature
- Press connection



Part #	Mfg #	Size	Price
115625	20823	2-1/2" x 2-1/2"	
115626	20828	3" x 3"	

ProPress® XL-C® Adapter Flange (Flange x P)

- Copper
- Smart Connect® feature
- Press connection



Part #	Mfg #	Size	Price
116543	20853	2-1/2"	
113280	20858	3"	
116544	20863	4"	

ProPress® XL-C® Coupling - No Stop (P x P)

- Copper
- Smart Connect® feature
- Press connection

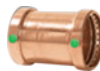

Part #	Mfg #	Size	Price
115634	20743	2-1/2"	
115635	20748	3"	
115636	20753	4"	

ProPress® XL-C® Cap (P x P)

- Copper
- Smart Connect® feature
- Press connection



Part #	Mfg #	Size	Price
115629	20833	2-1/2"	
113281	20843	3"	
115630	20848	4"	

ProPress® XL-C® Coupling - with Stop (P x P)

- Copper
- Smart Connect® feature
- Press connection



Part #	Mfg #	Size	Price
115631	20728	2-1/2"	
115632	20733	3"	

Viega ProPress® XL-C® Fittings (Continued)

ProPress® XL-C® Coupling - with Stop (P x P)

Part #	Mfg #	Size	Price
115633	20738	4"	

ProPress® XL-C® Elbow - 90° (P x P)

- Zero Lead™ copper
- Smart Connect® feature
- Press connection



Part #	Mfg #	Size	Price
115637	20623	2-1/2"	
115638	20628	3"	
115639	20633	4"	

ProPress® XL-C® Elbow - 90° (Ftg x P)

- Copper
- Smart Connect® feature
- Press connection, street



Part #	Mfg #	Size	Price
115640	20638	2-1/2"	
115641	20643	3"	
115642	20648	4"	

ProPress® XL-C® Elbow - 45° (P x P)

- Copper
- Smart Connect® feature
- Press connection



Part #	Mfg #	Size	Price
115643	20653	2-1/2"	
115644	20658	3"	
115645	20663	4"	

ProPress® XL-C® Elbow - 45° (Ftg x P)

- Copper
- Smart Connect® feature
- Press connection, street



Part #	Mfg #	Size	Price
115646	20668	2-1/2"	
115647	20673	3"	
115648	20678	4"	

ProPress System

ProPress® XL-C® Reducer (P x P)

- Copper
- Smart Connect® feature
- Press connection



Part #	Mfg #	Size	Price
127705	20700	2-1/2" x 2"	

ProPress® XL-C® Reducer (Ftg x P)

- Copper
- Smart Connect® feature
- Street, press connection



Part #	Mfg #	Size	Price
124723	20814	2-1/2" x 1"	
115649	20813	2-1/2" x 1-1/2"	
115650	20758	2-1/2" x 2"	
115651	20818	3" x 1-1/2"	
113282	20763	3" x 2"	
115652	20768	3" x 2-1/2"	
115653	20773	4" x 2"	
115654	20778	4" x 2-1/2"	
115656	20783	4" x 3"	

ProPress® XL-C® Tee (P x P x P)

- Copper
- Smart Connect® feature
- Press connection



Part #	Mfg #	Size	Price
158952	20709	2-1/2" x 2" x 1"	
111195	22298	2-1/2" x 2-1/2" x 3/4"	
115667	22293	2-1/2" x 2-1/2" x 1"	
111334	22288	2-1/2" x 2-1/2" x 1-1/4"	
115668	20803	2-1/2" x 2-1/2" x 1-1/2"	
115669	20688	2-1/2" x 2-1/2" x 2"	
115665	20683	2-1/2" x 2-1/2" x 2-1/2"	
124719	22323	3" x 3" x 3/4"	
115671	22313	3" x 3" x 1-1/4"	
115672	20798	3" x 3" x 1-1/2"	
115673	20698	3" x 3" x 2"	
115674	20703	3" x 3" x 2-1/2"	
115670	20693	3" x 3" x 3"	
124721	20794	4" x 4" x 1"	
115676	20713	4" x 4" x 2"	
115677	20718	4" x 4" x 2-1/2"	
115675	20708	4" x 4" x 4"	

ProPress® XL-C® Tee (P x P x FNPT)

- Copper
- Smart Connect® feature
- Press connection, female pipe thread



Part #	Mfg #	Size	Price
115662	20878	2-1/2" x 2-1/2" x 2"	
115663	20888	3" x 3" x 2"	
115664	20868	4" x 4" x 2"	

Veiga MegaPress® Fittings

Veiga MegaPressG 45° Street Elbow (P x Ftg)

- For use with carbon steel piping system
- Carbon steel
- Press connection, street



Part #	Mfg #	Size	Price
180623	26101	1/2"	
180624	26106	3/4"	
180625	26111	1"	
180626	26116	1-1/4"	
180627	26121	1-1/2"	
180628	26126	2"	

Veiga MegaPressG 45° Elbow (P x P)

- For use with carbon steel piping systems
- Carbon steel
- Press connection



Part #	Mfg #	Size	Price
151369	25231	1/2"	
151370	25236	3/4"	
151371	25241	1"	
151372	25246	1-1/4"	
151373	25251	1-1/2"	
151374	25256	2"	

Veiga MegaPressG® 90° Street Elbow (P x Ftg)

- For use with carbon steel piping system
- Carbon steel
- Press connection, street



Part #	Mfg #	Size	Price
180616	26051	1/2"	

Pipe Fittings

ProPress System

Viega MegaPress® Fittings (Continued)

**Viega MegaPressG® 90° Street Elbow
(P x Ftg)**

Part #	Mfg #	Size	Price
180617	26056	3/4"	
180618	26061	1"	
180619	26066	1-1/4"	
180621	26071	1-1/2"	
180622	26076	2"	

**Viega MegaPressG 90° Elbow
(P x P)**

- For use with carbon steel piping system
- Carbon steel
- Press connection, street



Part #	Mfg #	Size	Price
151363	25201	1/2"	
151364	25206	3/4"	
151365	25211	1"	
151366	25216	1-1/4"	
151367	25221	1-1/2"	
151368	25226	2"	

Viega MegaPressG Coupling

- For use with carbon steel piping system
- Carbon steel
- Press connection



Part #	Mfg #	Size	Price
151345	25001	1/2"	
151346	22009	3/4"	
151347	25011	1"	
151348	25016	1-1/4"	
151349	25021	1-1/2"	
151350	25026	2"	

**Viega MegaPressG Coupling (No Stop)
(P x P)**

- For use with carbon steel piping system
- Carbon steel
- Press connection



Part #	Mfg #	Size	Price
151493	25031	1/2"	
151494	25036	3/4"	

Viega MegaPress® Fittings (Continued)

**Viega MegaPressG Coupling (No Stop)
(P x P)**

Part #	Mfg #	Size	Price
151495	25041	1"	
151496	25046	1-1/4"	
151497	25051	1-1/2"	
151498	25056	2"	

**Viega MegaPressG Union
(P x P)**

- For use with carbon steel piping system
- Carbon steel
- Press connection



Part #	Mfg #	Size	Price
151487	25701	1/2"	
151488	25706	3/4"	
151489	25711	1"	
151490	25716	1-1/4"	
151491	25721	1-1/2"	
151492	25726	2"	

**Viega MegaPressG Reducer
(Ftg x P)**

- For use with carbon steel piping system
- Carbon steel
- Street, press connection



Part #	Mfg #	Size	Price
151503	26001	3/4" x 1/2"	
151504	26006	1" x 1/2"	
151505	26011	1" x 3/4"	
151507	26016	1-1/4" x 1"	
151508	26021	1-1/2" x 3/4"	
151510	26031	1-1/2" x 1"	
151509	26026	1-1/2" x 1-1/4"	
151511	26036	2" x 1"	
151512	26041	2" x 1-1/4"	
151514	26046	2" x 1-1/2"	

Pipe Fittings

ProPress System

**Viega MegaPressG Tee
(P x P x P)**

- For use with carbon steel piping system
- Carbon steel
- Press connection



Part #	Mfg #	Size	Price
151375	25301	1/2" x 1/2" x 1/2"	
151376	25306	3/4" x 3/4" x 3/4"	
151377	25311	1" x 1" x 1"	
151378	25316	1-1/4" x 1-1/4" x 1-1/4"	
151379	25321	1-1/2" x 1-1/2" x 1-1/2"	
151380	25326	2" x 2" x 2"	
151381	25331	3/4" x 3/4" x 1/2"	
151382	25336	1-1/2" x 1-1/2" x 3/4"	
151383	25341	1" x 1" x 3/4"	
151384	25361	1-1/2" x 1-1/2" x 1/2"	
151385	25366	1-1/2" x 1-1/2" x 3/4"	
151386	25371	1-1/2" x 1-1/2" x 1"	
151388	25376	1-1/2" x 1-1/2" x 1-1/4"	
151389	25381	2" x 2" x 1/2"	
151390	25386	2" x 2" x 3/4"	
151391	25391	2" x 2" x 1"	
151392	25396	2" x 2" x 1-1/4"	
151393	25401	2" x 2" x 1-1/2"	

**Viega MegaPressG Tee
(P x P x FPT)**

- For use with carbon steel piping system
- Carbon steel
- Press connection, female pipe thread



Part #	Mfg #	Size	Price
151474	25406	3/4" x 3/4" x 1/2"	
151475	25411	1" x 1" x 1/2"	
151476	25416	1" x 1" x 3/4"	
151478	25441	1-1/2" x 1-1/2" x 3/4"	
151480	25456	2" x 2" x 1/2"	
151481	25461	2" x 2" x 3/4"	

**Viega MegaPressG Adapter
(P x FPT)**

- For use with carbon steel piping system
- Carbon steel
- Press connection, female pipe thread



Part #	Mfg #	Size	Price
151482	25576	3/4" x 1/2"	
151483	25586	1" x 3/4"	
151484	25601	1-1/4" x 1"	
151485	25621	1-1/2" x 1-1/4"	
151486	25646	2" x 1-1/2"	
151357	25131	1/2" x 1/2"	
151358	25136	3/4" x 3/4"	
151359	25141	1" x 1"	
151360	25146	1-1/4" x 1-1/4"	
151361	25151	1-1/2" x 1-1/2"	
151362	25156	2" x 2"	

**Viega MegaPressG Adapter
(P x MPT)**

- For use with carbon steel piping systems
- Carbon steel
- Press connection, male pipe thread



Part #	Mfg #	Size	Price
151351	25101	1/2" x 1/2"	
151352	25106	3/4" x 3/4"	
151353	25111	1" x 1"	
151354	25116	1-1/4" x 1-1/4"	
151355	25121	1-1/2" x 1-1/2"	
151356	25126	2" x 2"	

ProPress System

Part #	Mfg #	Description	Price
--------	-------	-------------	-------



Pressing Tools

- Completes a reliable, watertight connection in seconds, cutting installation time in half versus soldering

RP 330-B Model Battery-Operated Press Tool

- 270° Barrel/jaw swivel
- 7,200 lbs Hydraulic ram output
- Operating temperature range 15° to 122°F
- Five second approximate cycle time
- Compatible with all Ridgid® standard jaws
- Standard kit includes:
 - RP 330-B Press tool
 - 18V Lithium-Ion battery
 - Battery charger
 - Carrying case



Part #	Mfg #	Model	Description	Price
109656	27923	RP 330-B	Kit with 1/2" - 2" Jaw Sets for ProPress (Copper & Stainless Steel)	

RP 330-C Model Corded Press Tool

- 270° Barrel/jaw swivel
- 7,200 lbs Hydraulic ram output
- Operating temperature range 15° to 122°F
- Five second approximate cycle time
- Compatible with all Ridgid® standard jaws
- Standard kit includes:
 - RP 330-C Press tool and jaws
 - Carrying case



Part #	Mfg #	Model	Description	Price
117042	27938	RP 330-C	Kit without Jaw Sets	
049268	27948	RP 330-C	Kit with 1/2" - 2" Jaw Sets for ProPress (Copper & Stainless Steel)	

Pipe Fittings

ProPress System

RP 340 Model Corded Press Tool

- 180° Barrel/jaw swivel
- 7,200 lbs
- 4-5 Seconds cycle time
- More than 400 presses per charge using Advanced Lithium 4 Battery
- Ultimate flexibility with the ability to switch between battery and AC power on the same tool
- LED-light for continued operations in no or low-light environments
- Standard kit includes:
 - RP 340 Press Tool
 - AC Power adapter
 - Carrying case



Part #	Mfg #	Model	Description	Price
162369	43373	RP 340	½" to 4" for Copper and Stainless Steel, ½" to 2" for PEX	

MegaPress® Jaws And Rings

- Joins 1/2" to 2" commercially available Sch 5-40 black iron pipe when used with RIGID® Standard Press Tools and Viega® MegaPress fittings
- Press connections can be made on a "wet" system
- Flameless system eliminates the need for hot work permits



Part #	Mfg #	Model	Description	Price
178616	48558	Kit, 1/2" to 2"	commercially available sch 5-40 black iron pipe	

MegaPress Jaws

Part #	Mfg #	Model	Description	Price
151585	37963	3/4"	MegaPress Jaw for Standard RIGID Press Tools	
151586	37968	1"	MegaPress Jaw for Standard RIGID Press Tools	

MegaPress Rings

Part #	Mfg #	Model	Description	Price
151587	37973	1-1/4"	MegaPress Ring for Standard RIGID Press Tools	
151588	37978	1-1/2"	MegaPress Ring for Standard RIGID Press Tools	
151589	37983	2"	MegaPress Ring for Standard RIGID Press Tools	

Accessories

Part #	Mfg #	Model	Description	Price
151590	37993	1/2" to 1"	MegaPress End Prep Tool	
151591	37988	1-1/4" to 2"	MegaPress End Prep Tool	
151594	37998		Steel Carrying Case	
151592	38008		Abrasive Strips, 1/2" to 1"	
151593	38003		Abrasive Strips, 1-1/4" to 2"	

Pipe Fittings

ProPress System

ProPress® Rings

- *Designed in conjunction with the ProPress system fittings, ensuring total system compatibility*
- *V1 and V2 Kits are designed for use with RIDGID Standard Press Tools (CT-400, 320-E, RP 330-B, RP 330-C, or RP 340)*
- *C1 Compact Kits are designed for RIDGID Compact press tools (100-B, RP 200-B, RP 210-B)*
- *Standard Kit includes: Press rings, actuator and carrying case*



Part #	Mfg #	Model	Description	Price
151600	21878		1/2" to 2" copper and stainless steel tubing	

Pipe Fittings

PVC - DWV Fittings

PVC DWV Fittings PVC Coupling (Hub)



Part #	Size	Price
012496	1-1/2"	
013871	2"	
014390	3"	
015264	4"	
015641	6"	
015794	8"	

PVC Reducer Coupling (Hub)



Part #	Size	Price
014005	2" x 1-1/2"	
014488	3" x 1-1/2"	
014533	3" x 2"	
015399	4" x 2"	
015441	4" x 3"	

PVC Repair Coupling (Hub)



Part #	Size	Price
012511	1-1/2"	
013883	2"	
014401	3"	
015277	4"	
038526	6"	

PVC Fitting Adapter Bushing (Spgt x H)

Part #	Size	Price
019748	3"	

PVC Fitting Flush Bushing (Spgt x H)

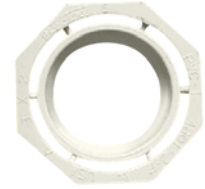

Part #	Size	Price
014004	2" x 1-1/2"	
014487	3" x 1-1/2"	
014532	3" x 2"	
015398	4" x 2"	
015440	4" x 3"	
015729	6" x 4"	
015859	8" x 6"	

PVC Ftg Slip Joint Trap Adapter with Plastic Nut (Spgt x SJ)



Part #	Size	Price
012854	1-1/4"	
012505	1-1/2"	
012637	1-1/2" x 1-1/4"	

PVC Slip Joint Trap Adapter with Plastic Nut (H x SJ)

Part #	Size	Price
012853	1-1/4"	
012501	1-1/2"	
012635	1-1/2" x 1-1/4"	

PVC Female Adapter (H x FIP)



Part #	Size	Price
012499	1-1/2"	
013874	2"	
014393	3"	
015267	4"	
015642	6"	

PVC - DWV Fittings

PVC Female Fitting Adapter (Spgt x FIP)



Part #	Size	Price
026570	1-1/2"	

PVC Male Adapter (H x MIP)



Part #	Size	Price
012503	1-1/2"	
012636	1-1/2" x 1-1/4"	
013879	2"	
014398	3"	
015273	4"	

PVC Male Fitting Adapter (Spgt x MIP)



Part #	Size	Price
012504	1-1/2"	
013880	2"	

PVC Soil Pipe (Caulk) Adapter (H x Spgt)

Part #	Size	Price
012683	1-1/2" x 2"	
013877	2"	
014396	3"	
014739	3" x 4"	

PVC No-Hub Soil Adapter (H x No Hub)

Part #	Size	Price
060347	2"	
065821	3"	
065822	4"	

PVC 90° Elbow (Hub)



Part #	Size	Price
012522	1-1/2"	
013895	2"	

PVC DWV Fittings (Continued)

PVC 90° Elbow (Hub)

Part #	Size	Price
014411	3"	
045719	4" x 3"	
015287	4"	
015651	6"	
015798	8"	

PVC 90° Vent Elbow (Hub)



Part #	Size	Price
012517	1-1/2"	
013890	2"	
014406	3"	

PVC 90° Long Turn Elbow (Hub)



Part #	Size	Price
012502	1-1/2"	
013878	2"	
014397	3"	
020113	4"	

PVC 90° Street Vent Elbow (Spgt x H)



Part #	Size	Price
072935	2"	

PVC 90° Street Elbow (Spgt x H)



Part #	Size	Price
012514	1-1/2"	
013886	2"	
014404	3"	
015281	4"	
015646	6"	

Pipe Fittings

PVC - DWV Fittings

PVC 90° Reducing Street Elbow (Spgt x H)

Part #	Size	Price
102562	4" x 3" less Cap	

PVC 90° Side Inlet Elbow (Hub)



Part #	Size	Price
014581	3" x 1-1/2"	
014595	3" x 2"	

PVC 90° Long Turn Street Elbow (Spgt x H)



Part #	Size	Price
054652	1-1/2"	
054654	2"	
054656	3"	

PVC 60° Elbow (Hub)



Part #	Size	Price
012521	1-1/2"	
013894	2"	
014410	3"	
015286	4"	

PVC 60° Street Elbow (Spgt x H)



Part #	Size	Price
077784	2"	
039441	3"	

PVC 45° Elbow (Hub)



Part #	Size	Price
012520	1-1/2"	
013893	2"	
014409	3"	
015285	4"	
015650	6"	
015797	8"	

PVC 45° Street Elbow (Spgt x H)



Part #	Size	Price
012513	1-1/2"	
013885	2"	
014403	3"	
015280	4"	
015645	6"	
043038	8"	

PVC 22-1/2° Elbow (Hub)



Part #	Size	Price
012519	1-1/2"	
013892	2"	
014408	3"	
015284	4"	
015649	6"	

PVC 22-1/2° Street Elbow (Spgt x H)



Part #	Size	Price
012512	1-1/2"	
013884	2"	
014402	3"	
015279	4"	

PVC - DWV Fittings

PVC 45° Wye (Hub)



Part #	Size	Price
012518	1-1/2"	
013891	2"	
014023	2" x 1-1/2" x 1-1/2"	
014224	2" x 1-1/2"	
014407	3"	
014583	3" x 1-1/2"	
014597	3" x 2"	
015283	4"	
088647	4" x 1-1/2"	
015482	4" x 2"	
015487	4" x 3"	
015648	6"	
015750	6" x 4"	
040871	8"	
015868	8" x 6"	

PVC 45° Street Wye (Spgt x H x H)



Part #	Size	Price
060952	3" x 2"	
113113	4" x 2"	
113112	4" x 3"	

PVC 45° Double Wye (Hub)



Part #	Size	Price
012498	1-1/2"	
013873	2"	
014007	2" x 2" x 1-1/2" x 1-1/2"	
014392	3"	
014490	3" x 3" x 1-1/2" x 1-1/2"	
014536	3" x 3" x 2" x 2"	

PVC DWV Fittings (Continued)

PVC 45° Double Wye (Hub)

Part #	Size	Price
015266	4"	
015401	4" x 4" x 2" x 2"	
015443	4" x 4" x 3" x 3"	
037291	6" x 6" x 4" x 4"	

PVC Double Combo Wye 1/8 Bend (Hub)



Part #	Size	Price
040637	4"	

PVC Straight Tee (Hub)



Part #	Size	Price
073444	12"	

PVC Sanitary Tee (Hub)



Part #	Size	Price
012515	1-1/2"	
013888	2"	
014405	3"	
015282	4"	
015647	6"	
015796	8"	

Pipe Fittings

PVC - DWV Fittings

PVC Reducing Sanitary Tee (Hub)



Part #	Size	Price
014022	2" x 1-1/2" x 1-1/2"	
014032	2" x 1-1/2" x 2"	
014223	2" x 1-1/2"	
014582	3" x 1-1/2"	
014596	3" x 2"	
088648	4" x 1-1/2"	
015481	4" x 2"	
015486	4" x 3"	
015749	6" x 4"	

PVC Flush Cleanout Tee with Plug (H x H x FIP)

Part #	Size	Price
012494	1-1/2"	
013869	2"	
014389	3"	
015263	4"	

PVC Street Tee (Spgt x H x H)



Part #	Size	Price
025639	1-1/2"	
021326	2" x 1-1/2" x 1-1/2"	
025013	2" x 2" x 1-1/2"	
023480	2"	
056475	3" x 3" x 2"	

PVC Long Radius TY (Hub)



Part #	Size	Price
040638	2"	
061909	3" x 3" x 2"	
057470	3"	
024821	4"	
024820	4" x 4" x 2"	
024819	4" x 4" x 3"	

PVC Cleanout Tee with Plug (Hub)

Part #	Size	Price
073450	10" x 10" x 8"	

PVC Horizontal Twin Tee (Hub)

Part #	Size	Price
014491	3" x 3" x 1-1/2" x 1-1/2"	

PVC 2-Way Cleanout Tee (Hub)



Part #	Size	Price
024174	4"	

PVC Double Fixture Tee (Hub)



Part #	Size	Price
045720	2"	
014024	2" x 1-1/2" x 1-1/2" x 1-1/2"	
014225	2" x 2" x 1-1/2" x 1-1/2"	

PVC - DWV Fittings

PVC Double Sanitary Tee (Hub)



Part #	Size	Price
012497	1-1/2"	
013872	2"	
014006	2" x 2" x 1-1/2" x 1-1/2"	
014391	3"	
014489	3" x 3" x 1-1/2" x 1-1/2"	
014534	3" x 3" x 2" x 2"	
015265	4"	
015400	4" x 4" x 2" x 2"	
015442	4" x 4" x 3" x 3"	

PVC 90° Low Heel Inlet Elbow (Hub)



Part #	Size	Price
014580	3" x 3" x 1-1/2"	
014594	3" x 3" x 2"	

PVC Double Tee with Right & Left Inlets (Hub)



Part #	Size	Price
014535	3" x 3" x 3" x 3" x 2" x 2"	

PVC Sanitary Tee with 90° Right/Left Inlet (Hub)



Part #	Size	Price
014494	3" x 3" x 3" x 1-1/2" x 1-1/2"	

PVC DWV Fittings (Continued)

PVC Sanitary Tee with 90° Right/Left Inlet (Hub)

Part #	Size	Price
014540	3" x 3" x 3" x 2" x 2"	

PVC Sanitary Tee with 90° Left Inlet (Hub)



Part #	Size	Price
014492	3" x 3" x 3" x 1-1/2"	
014537	3" x 3" x 3" x 2"	

PVC Sanitary Tee with 90° Right Inlet (Hub)



Part #	Size	Price
014493	3" x 3" x 3" x 1-1/2"	
014539	3" x 3" x 3" x 2"	

PVC Cleanout with Plug (Spgt x CO)



Part #	Size	Price
012500	1-1/2"	
013876	2"	
014395	3"	
015269	4"	
015644	6"	

PVC Plug (MIP)



Part #	Size	Price
012493	1-1/2"	
013868	2"	
014388	3"	
015262	4"	
015638	6"	

Pipe Fittings

PVC - DWV Fittings

PVC Return Bend (Hub)



Part #	Size	Price
012509	1-1/2"	
013882	2"	
014400	3"	
015276	4"	

PVC P-Trap (Hub)



Part #	Size	Price
012506	1-1/2"	
015795	2"	
014399	3"	
015275	4"	

PVC P-Trap with Plug (H x H x CO)



Part #	Size	Price
012507	1-1/2"	
013881	2"	

PVC P-Trap with Union Joint (Hub)

Part #	Size	Price
012516	1-1/2"	
013889	2"	



PVC DWV Fittings PVC DWV Coupling (H x H)

Part #	Mfg #	Size	Price
020159	P100-100	10"	
057116	P100-120	12"	

PVC DWV Female Adapter (FPT x H)

Part #	Mfg #	Size	Price
144468	P101-080	8"	

PVC DWV Pipe Increaser - Reducer (H x H)

Part #	Mfg #	Size	Price
038995	P102-532	6" x 4"	
064620	P102-582	8" x 4"	
073255	P102-585	8" x 6"	

PVC DWV Male Trap Adapter (S x Slip) with Plastic Nut & Washer

- Includes 1-1/2" plastic nut and washer and 1-1/2" x 1-1/4" washer

Part #	Mfg #	Size	Price
093429	P103R-015	1-1/2"	

PVC DWV Female Trap Adapter (H x Slip) with Plastic Nut & Washer

- Includes 1-1/2" plastic nut and washer and 1-1/2" x 1-1/4" washer

Part #	Mfg #	Size	Price
093430	P104R-015	1-1/2"	

PVC DWV Flush Bushing Cleanout Adapter (S x FPT)

Part #	Mfg #	Size	Price
058525	P107-582	8" x 4"	
055955	P107-670	12" x 10"	

PVC DWV No-Hub Adapter (S x H)

Part #	Mfg #	Size	Price
095916	P119-015	1-1/2"	

PVC DWV 90° Elbow (H x H)

Part #	Mfg #	Size	Price
024746	P300-100	10"	
058097	P300-120	12"	

PVC DWV 90° Street Elbow (S x H)

Part #	Mfg #	Size	Price
073568	P302-080	8"	



PVC - DWV Fittings

PVC DWV 90° Long Bend Elbow (H x H)

Part #	Mfg #	Size	Price
064614	P304-060	6"	

PVC DWV 90° Long Bend Street Elbow (H x S)

Part #	Mfg #	Size	Price
114901	P309-040	4"	

PVC DWV 45° Elbow (H x H)

Part #	Mfg #	Size	Price
020114	P321-100	10"	
057237	P321-120	12"	

PVC DWV 22° Street Elbow (H x S)

Part #	Mfg #	Size	Price
049505	P326-060	6"	

PVC DWV Vent Elbow (H x H)

Part #	Mfg #	Size	Price
109810	P331-040	4"	

PVC DWV Vent Street Elbow (H x S)

Part #	Mfg #	Size	Price
109812	P333-015	1-1/2"	
109811	P333-030	3"	
109746	P333-040	4"	

PVC DWV Sanitary Street Tee (S x H x H)

Part #	Mfg #	Size	Price
084035	P403-030	3"	
084036	P403-040	4"	

PVC DWV Reducing Vent Tee (All Hub)

Part #	Mfg #	Size	Price
096943	P442-624	10" x 10" x 4"	

PVC DWV Cleanout Tee with Cleanout Plug (H x H)

Part #	Mfg #	Size	Price
015640	P444X-060	6"	

PVC DWV Reducing Combination Wye and 45° Bend - Two Piece (All Hub)

Part #	Mfg #	Size	Price
096932	P504-626	10" x 10" x 6"	

PVC DWV Reducing Wye (All Hub)

Part #	Mfg #	Size	Price
050454	P601-530	6" x 6" x 3"	
050370	P601-582	8" x 8" x 4"	
024784	P601-628	10" x 10" x 8"	
064616	P601-664	12" x 12" x 4"	
055954	P601-666	12" x 12" x 6"	
064617	P601-668	12" x 12" x 8"	

PVC DWV Street Wye (S x H x H)

Part #	Mfg #	Size	Price
109809	P602-015	1-1/2"	
109808	P602-020	2"	
109807	P602-030	3"	

PVC DWV P-Trap (H x H)

Part #	Mfg #	Size	Price
064613	P706X-060	6"	

PVC DWV Flush Closet Flange with Knockout

- Fits over 3" pipe or inside 4" pipe

Part #	Mfg #	Size	Price
104204	P815KO-040	4" x 3"/4"x3"	

Sch 40 PVC DWV Fittings

Sch 40 PVC DWV 45° Street Elbow (Spgt x Soc)

Part #	Mfg #	Size	Price
073429	3727-100	10"	
073442	3727-120	12"	

Sch 40 PVC DWV Reducer Coupling (Soc x Soc)

Part #	Mfg #	Size	Price
041465	3729-628	10" x 8"	

Sch 40 PVC DWV Sanitary Tee (Soc x Soc x Soc)

Part #	Mfg #	Size	Price
035771	3790-585	8" x 6"	

Pipe Fittings

PVC - DWV Fittings

Sch 40 PVC DWV Fittings

**Female Adapter
(Hub x FIP)**



Part #	Mfg #	Size	Price
114693	70311	1-1/2" x 1-1/4"	



Saddle Tee Kits

- For tapping into a 3" or 4" Sch 40 DWV line
- Saddle is solvent welded to the existing line and secured with metal V-bolts, washers and nuts provided in kit
- The tee accepts the incoming line inside the socket or joins with a Sch 40 DWV fitting



Part #	Mfg #	Description	Price
041350	43789	3" x 2" PVC	
041351	43791	4" x 2" PVC	
041358	43793	4" x 3" PVC	



Saddle Tee Kits

Saddle Tee Kit - Less Gasket

- Solvent branch
- Use bushing to reduce 2" unit to 1-1/2"
- Includes:
 - V-Bolts
 - Nuts
 - Washers



Part #	Mfg #	Size	Price
041988	S26-004	3" x 2"	
041989	S26-005	4" x 2"	
041990	S26-006	4" x 3"	
041991	S26-007	4" x 4"	

Repair Plugs

T-Cone Cleanout Repair Plug

- Easily repairs damaged or corroded metal or plastic cleanout threads



Part #	Mfg #	Pipe Size	Price
061035	T34-150	1-1/2"	
061036	T34-200	2"	
045478	T34-300	3"	
045479	T34-350	3-1/2"	
045480	T34-400	4"	



Cleanout Plugs

Slotted Polypropylene Flush Plug

- With or without threaded brass insert
- Combine with FIP adapters to make a cleanout
- Glass-filled polypropylene plugs:
 - Will not sieze up on ABS or PVC
 - Acid resisant and chemmically inert
 - More durable than traditional plugs

Without Threaded Brass Insert



Part #	Mfg #	Size	Price
139754	878-015	1-1/2"	
044644	878-020	2"	
045442	878-030	3"	

With Threaded Brass Insert



Part #	Mfg #	Size	Price
184063	878-20	2"	
184064	878-30	3"	
184065	878-35	3-1/2"	
184066	878-40	4"	

Pipe Fittings

PVC - DWV Fittings

Commercial PVC Spanner Flush plug

- Schedule 40 thread
—Machined from solid PVC
—Load limit 6,000+ lbs.

Part #	Mfg #	Size	Price
184067	878-980	8"	

Closest Flanges

FullFlush™ Offset Closet Flange with Knockout

- Full-flow, 3" I.D. throat — no restriction
- Allows for 1½ offset in any direction for closet bowl setting
- Corrosion-resistant 430 stainless steel swivel ring is engineered for maximum strength



Part #	Mfg #	Hub/Inside	Flush to Floor	Price
151863	889-POTM	3"	4"	

Tees

SmartSaddle™ Residential DWV Saddle Tee Fitting

- Compact design is perfect when DWV stacks are close to walls or other obstructions
- Corrosion resistant
- Information about bands
—Stainless steel
—Provide even torque
—Eliminate stress points
—Take up less room than v-bolts or u-bolts

Part #	Mfg #	Trunk	Inlet Branch	Price
184073	891-0412P	4" Sch. 40	1-1/2"Hub x 2"Spigot	

PVC Schedule 40 Fittings

PVC Sch 40 Fittings

PVC Tee (Soc)



Part #	Mfg #	Size	Price
013185	401005	1/2"	
014753	401007	3/4"	
012274	401010	1"	
012862	401012	1-1/4"	
012535	401015	1-1/2"	
013907	401020	2"	
014111	401025	2-1/2"	
014419	401030	3"	
015292	401040	4"	

PVC Reducing Tee (Soc)



Part #	Mfg #	Size	Price
014897	401101	3/4" x 1/2"	
030374	401130	1" x 1/2"	
012747	401131	1" x 3/4"	
088599	401167	1-1/4" x 3/4"	
068828	401211	1-1/2" x 1"	
066124	401241	2" x 1-1/2" x 1-1/2"	
034592	401248	2" x 3/4"	
036756	401249	2" x 1"	
073453	401251	2" x 1-1/2"	
088606	401420	4" x 2"	

PVC Tee (Soc x FIP)

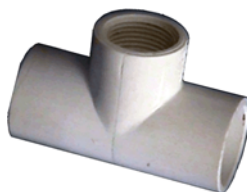

Part #	Mfg #	Size	Price
013179	402005	1/2"	
014746	402007	3/4"	

PVC Reducing Tee (Soc x FIP)



Part #	Mfg #	Size	Price
021099	402101	3/4" x 1/2"	

PVC Tee (FIP)



Part #	Mfg #	Size	Price
060411	405005	1/2"	

PVC Sanitary Tee (Soc x FIP)



Part #	Mfg #	Size	Price
131254	402166SR	1-1/4" x 1/2"	

PVC 90° Elbow (Soc)



Part #	Mfg #	Size	Price
013187	406005	1/2"	
014755	406007	3/4"	
012276	406010	1"	
012864	406012	1-1/4"	
012538	406015	1-1/2"	
013909	406020	2"	
014113	406025	2-1/2"	
014421	406030	3"	
015294	406040	4"	
015662	406060	6"	
015805	406080	8"	

Pipe Fittings

PVC Schedule 40 Fittings

PVC Reducing 90° Elbow (Soc)



Part #	Mfg #	Size	Price
132414	406251	2" x 1-1/2"	

PVC 90° Elbow (Soc x FIP)



Part #	Mfg #	Size	Price
013180	407005	1/2"	
014747	407007	3/4"	

PVC 90° Elbow (FIP)



Part #	Mfg #	Size	Price
032758	408007	3/4"	

PVC 90° Street Elbow (Spgt x Soc)



Part #	Mfg #	Size	Price
013188	409005	1/2"	
014752	409007	3/4"	
012273	409010	1"	
012861	409012	1-1/4"	
012534	409015	1-1/2"	
013906	409020	2"	

PVC 90° Street Elbow (MIP x Soc)



Part #	Mfg #	Size	Price
013182	410005	1/2"	
014749	410007	3/4"	

PVC 45° Elbow (Soc)



Part #	Mfg #	Size	Price
013186	417005	1/2"	
014754	417007	3/4"	
012275	417010	1"	
012863	417012	1-1/4"	
012537	417015	1-1/2"	
013908	417020	2"	
014112	417025	2-1/2"	
014420	417030	3"	
015293	417040	4"	
015661	417060	6"	
035963	417080	8"	

PVC 45° Street Elbow (Spgt x Soc)

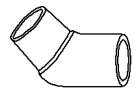

Part #	Mfg #	Size	Price
069584	427005	1/2"	
055971	427007	3/4"	
116550	427010	1"	
061658	427012	1-1/4"	
134669	427020	2"	

PVC 11-1/4° Elbow (Soc)

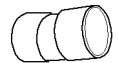

Part #	Mfg #	Size	Price
043021	411040	4"	

PVC Cross (Soc)



Part #	Mfg #	Size	Price
040769	420007	3/4"	
071416	420012	1-1/4"	
012529	420015	1-1/2"	
013903	420020	2"	

Pipe Fittings

PVC Schedule 40 Fittings

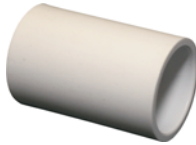
PVC Coupling (Soc)

Part #	Mfg #	Size	Price
013177	429005	1/2"	
014744	429007	3/4"	
012266	429010	1"	
012858	429012	1-1/4"	
012528	429015	1-1/2"	
013902	429020	2"	
014109	429025	2-1/2"	
014415	429030	3"	
015290	429040	4"	
015659	429060	6"	
015806	429080	8"	

PVC Reducer Coupling (Soc)

Part #	Mfg #	Size	Price
074996	429131	1" x 3/4"	
143136	429249	2" x 1"	
047441	429251	2" x 1-1/2"	
047440	429292	2-1/2" x 2"	
051140	429582	8" x 4"	

PVC Coupling (FIP)

Part #	Mfg #	Size	Price
042835	430005	1/2"	

PVC Deep Socket Coupling (Soc)



Part #	Mfg #	Size	Price
064558	479015	1-1/2"	

PVC Adapter (Soc x FIP)

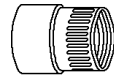

Part #	Mfg #	Size	Price
013178	435005	1/2"	
014745	435007	3/4"	
012268	435010	1"	

PVC Sch 40 Fittings (Continued)
PVC Adapter (Soc x FIP)

Part #	Mfg #	Size	Price
012859	435012	1-1/4"	
012530	435015	1-1/2"	
013904	435020	2"	

PVC Reducing Adapter (Soc x FIP)

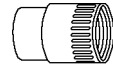
Part #	Mfg #	Size	Price
013324	435074	1/2" x 3/4"	
013430	435131	1" x 3/4"	

PVC Adapter (Spgt x FIP)

Part #	Mfg #	Size	Price
112490	478005	1/2"	
112489	478007	3/4"	

PVC Adapter (MIP x Soc)

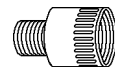

Part #	Mfg #	Size	Price
013181	436005	1/2"	
014748	436007	3/4"	
012271	436010	1"	
012860	436012	1-1/4"	
012532	436015	1-1/2"	
013905	436020	2"	
014110	436025	2-1/2"	
014417	436030	3"	
015660	436060	6"	

PVC Reducing Adapter (MIP x Soc)

Part #	Mfg #	Size	Price
028975	436074	1/2" x 3/4"	
057799	436101	3/4" x 1/2"	
062208	436102	3/4" x 1"	
112378	436132	1" x 1-1/4"	

PVC Schedule 40 Fittings

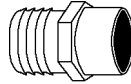
PVC Insert Adapter (Ins x IPS Spgt)
ASTM D 2609



Part #	Mfg #	Size	Price
100348	460010	1"	
100349	460012	1-1/4"	

PVC Insert Adapter (Ins x Soc)
ASTM D 2609

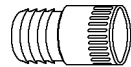

Part #	Mfg #	Size	Price
100350	474012	1-1/4"	

PVC Flush Style Reducer Bushing (Spgt x Soc)



Part #	Mfg #	Size	Price
014833	437101	3/4" x 1/2"	
012525	437130	1" x 1/2"	
013427	437131	1" x 3/4"	
019973	437166	1-1/4" x 1/2"	
012981	437167	1-1/4" x 3/4"	
012900	437168	1-1/4" x 1"	
012670	437209	1-1/2" x 1/2"	
012713	437210	1-1/2" x 3/4"	
012574	437211	1-1/2" x 1"	
012638	437212	1-1/2" x 1-1/4"	
014107	437247	2" x 1/2"	
014256	437248	2" x 3/4"	
013970	437249	2" x 1"	
014046	437250	2" x 1-1/4"	
014008	437251	2" x 1-1/2"	
014136	437291	2-1/2" x 1-1/2"	
014157	437292	2-1/2" x 2"	
014495	437337	3" x 1-1/2"	
014541	437338	3" x 2"	
014560	437339	3" x 2-1/2"	
015402	437420	4" x 2"	
015450	437422	4" x 3"	
142948	437490	5" x 4"	
035956	437585	8" x 6"	

PVC Flush Style Reducer Bushing (Spgt x FIP)



Part #	Mfg #	Size	Price
013279	438072	1/2" x 1/4"	
039068	438098	3/4" x 1/4"	
014832	438101	3/4" x 1/2"	
012531	438130	1" x 1/2"	
013428	438131	1" x 3/4"	
012943	438166	1-1/4" x 1/2"	
012982	438167	1-1/4" x 3/4"	
012901	438168	1-1/4" x 1"	
024445	438209	1-1/2" x 1/2"	
012714	438210	1-1/2" x 3/4"	
012575	438211	1-1/2" x 1"	
012639	438212	1-1/2" x 1-1/4"	
013969	438247	2" x 1/2"	
014257	438248	2" x 3/4"	
013968	438249	2" x 1"	
054604	438250	2" x 1-1/4"	

PVC Reducer Bushing (MIP x FIP)



Part #	Mfg #	Size	Price
014831	439101	3/4" x 1/2"	
077972	439130	1" x 1/2"	
013429	439131	1" x 3/4"	
012851	439168	1-1/4" x 1"	
012640	439212	1-1/2" x 1-1/4"	

PVC Cap (Soc)



Part #	Mfg #	Size	Price
013176	447005	1/2"	
014743	447007	3/4"	
012265	447010	1"	
012857	447012	1-1/4"	
012527	447015	1-1/2"	
013901	447020	2"	
014108	447025	2-1/2"	
014414	447030	3"	
015289	447040	4"	

PVC Schedule 40 Fittings

PVC Sch 40 Fittings (Continued)

PVC Cap (Soc)

Part #	Mfg #	Size	Price
015658	447060	6"	
015804	447080	8"	

PVC Cap (FIP)

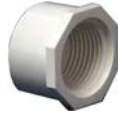

Part #	Mfg #	Size	Price
051069	448007	3/4"	
051070	448010	1"	
051071	448012	1-1/4"	
036229	448015	1-1/2"	
036138	448020	2"	

PVC Plug (Spgt)



Part #	Mfg #	Size	Price
012272	449010	1"	
019858	449020	2"	

PVC Plug (MIP)



Part #	Mfg #	Size	Price
064560	450005	1/2"	
019070	450007	3/4"	
019071	450010	1"	
019072	450012	1-1/4"	
047442	450020	2"	

PVC Schedule 40 Fittings

PVC Sch 40

PVC Union with Buna-N O-Ring Seal (Soc)

- 150 psi @ 73°F



Part #	Size	Price
033396	3/4"	
050025	1-1/4"	
046205	1-1/2"	
053023	2"	
080210	3"	

PVC Union with EDPM O-Ring Seal (Soc)

- 150 psi @ 73°F

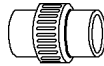

Part #	Size	Price
039750	1"	

Transition Tees

Part #	Size	Price
034942	3/4"	

Stainless Steel Reinforced Fittings

PVC Adapter (Soc x SR FIP)

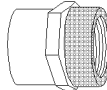

Part #	Size	Price
055694	1/2"	
055696	3/4"	
055698	1"	
055699	1-1/4"	
055700	1-1/2"	
055701	2"	
108099	2-1/2"	
055702	3"	
055703	4"	

PVC Schedule 40 Fittings

PVC Sch 40 Fittings

PowerPEX® Copper PVC Straight Adapter

- Perfect for water service transitions
- Lead-Free solder joint
- Made from Type L copper tub



Part #	Mfg #	Connection	Price
183755	645X3P	(3/4") PEX x PVC	
183756	645X4P	(1") PVC x PEX	

PVC MetalHead™ Straight Adapter

- Perfect fitting to transition from a PVC service line to a threaded adapter for CPVC, copper or PEX piping system
- Great transition for irrigation systems
- Lead-Free solder joint

Part #	Mfg #	Connection	Price
183761	646-P5	(1-1/4") PVC x MIP	
183762	646-P7	(2") PVC x MIP	

Condensate Trap

- One piece 3/4" Sch. 40 PVC trap saves fittings and job costs when trapping condensate lines



Part #	Mfg #	Type	Size	Price
184039	867-35	Running	10-3/4" x 2"	

PVC Schedule 80 Fittings

PVC Sch 80 Fittings

PVC Tee (Soc)



Part #	Mfg #	Size	Price
013192	801-005	1/2"	
014759	801-007	3/4"	
012283	801-010	1"	
037392	801-012	1-1/4"	
012542	801-015	1-1/2"	
013913	801-020	2"	
065707	801-025	2-1/2"	
014425	801-030	3"	
028874	801-040	4"	
078209	801-060	6"	
085579	801-080	8"	

PVC Reducing Tee (Soc)

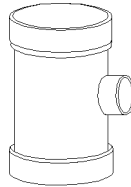

Part #	Mfg #	Size	Price
124455	801-101	3/4" x 1/2"	
153571	801-248	2" x 3/4"	
111874	801-251	2" x 1-1/2"	
126901	801-291	2-1/2" x 1-1/2"	
135663	801-337	3" x 1-1/2"	
053482	801-338	3" x 2"	
089964	801-419	4" x 1-1/2"	
089963	801-420	4" x 2"	
108429	801-527	6" x 1-1/2"	
105476	801-532	6" x 4"	
108428	801-582	8" x 4"	

PVC 90° Elbow (Soc)



Part #	Mfg #	Size	Price
013194	806-005	1/2"	
014762	806-007	3/4"	

PVC Sch 80 Fittings (Continued)

PVC 90° Elbow (Soc)

Part #	Mfg #	Size	Price
012286	806-010	1"	
012870	806-012	1-1/4"	
012545	806-015	1-1/2"	
013915	806-020	2"	
042583	806-025	2-1/2"	
014427	806-030	3"	
015299	806-040	4"	
053483	806-060	6"	
077835	806-080	8"	
101911	806-100	10"	

PVC 90° Elbow (Soc x FIP)



Part #	Mfg #	Size	Price
126890	807-007	3/4"	

PVC 90° Elbow (FIP)



Part #	Mfg #	Size	Price
121026	808-005	1/2"	

PVC 90° Street Elbow (Spgt x Soc)

Part #	Mfg #	Size	Price
116654	809-005	1/2"	
093292	809-007	3/4"	
112060	809-010	1"	
112151	809-020	2"	
116656	809-030	3"	

PVC Schedule 80 Fittings

PVC 45° Elbow (Soc)



Part #	Mfg #	Size	Price
032236	817-005	1/2"	
014761	817-007	3/4"	
012285	817-010	1"	
057125	817-012	1-1/4"	
012544	817-015	1-1/2"	
013914	817-020	2"	
042584	817-025	2-1/2"	
033514	817-030	3"	
045225	817-040	4"	
060072	817-060	6"	
085576	817-080	8"	
101910	817-100	10"	

PVC 45° Street Elbow (Spgt x Soc)

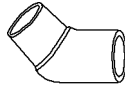

Part #	Mfg #	Size	Price
117632	827-015	1-1/2"	

PVC 22-1/2° Elbow (Soc)

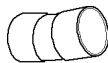

Part #	Mfg #	Size	Price
104683	816-015	1-1/2"	
101916	816-040	4"	
101915	816-060	6"	
101912	816-100	10"	

PVC Coupling (Soc)



Part #	Mfg #	Size	Price
013190	829-005	1/2"	
014756	829-007	3/4"	
012278	829-010	1"	
053250	829-012	1-1/4"	
012540	829-015	1-1/2"	
013910	829-020	2"	
065710	829-025	2-1/2"	
025989	829-030	3"	

PVC Sch 80 Fittings (Continued)

PVC Coupling (Soc)

Part #	Mfg #	Size	Price
015295	829-040	4"	
053485	829-060	6"	
077836	829-080	8"	
101907	829-100	10"	

PVC Reducer Coupling (Soc)



Part #	Mfg #	Size	Price
064772	829-168	1-1/4" x 1"	
126808		4" x 2"	
058967	829-532	6" x 4"	
085578	829-585	8" x 6"	

PVC Female Adapter (Soc x FIP)



Part #	Mfg #	Size	Price
053074	835-005	1/2"	
065712	835-007	3/4"	
012281	835-010	1"	
029225	835-012	1-1/4"	
055074	835-015	1-1/2"	
024103	835-020	2"	
022715	835-030	3"	

PVC Male Adapter (Soc x MIP)



Part #	Mfg #	Size	Price
032237	836-005	1/2"	
014757	836-007	3/4"	
012282	836-010	1"	
012867	836-012	1-1/4"	
012541	836-015	1-1/2"	
013911	836-020	2"	
014422	836-030	3"	

PVC Schedule 80 Fittings

PVC Flush Style Reducer Bushing (Spgt x Soc)



Part #	Mfg #	Size	Price
014834	837-101	3/4" x 1/2"	
019409	837-130	1" x 1/2"	
013431	837-131	1" x 3/4"	
012902	837-168	1-1/4" x 1"	
012715	837-210	1-1/2" x 3/4"	
062555	837-211	1-1/2" x 1"	
064774	837-212	1-1/2" x 1-1/4"	
090250	837-247	2" x 1/2"	
053477	837-248	2" x 3/4"	
019410	837-249	2" x 1"	
065705	837-251	2" x 1-1/2"	
065702	837-291	2-1/2" x 1-1/2"	
014158	837-292	2-1/2" x 2"	
065706	837-338	3" x 2"	
065703	837-339	3" x 2-1/2"	
057151	837-420	4" x 2"	
065704	837-422	4" x 3"	
053487	837-532	6" x 4"	

PVC Cap (Soc)



Part #	Mfg #	Size	Price
032508	847-005	1/2"	
064767	847-007	3/4"	
065388	847-010	1"	
064768	847-015	1-1/2"	
063200	847-020	2"	
053481	847-030	3"	

PVC Flush Style Reducer Bushing (Spgt x FIP)



Part #	Mfg #	Size	Price
119439	838-072	1/2" x 1/4"	
033400	838-101	3/4" x 1/2"	
052491	838-130	1" x 1/2"	
115802	838-131	1" x 3/4"	
042760	838-167	1-1/4" x 3/4"	
012641	838-212	1-1/2" x 1-1/4"	
053542	838-249	2" x 1"	
014009	838-251	2" x 1-1/2"	

Pipe Fittings

PVC Schedule 80 Fittings

PVC Sch 80 Unions
PVC 2000 Union (Soc)
with Viton® O-Ring Seal

• Maximum internal pressure: 235 psi @ 73°F



Part #	Size	Price
013193	1/2"	
014760	3/4"	
012284	1"	
012869	1-1/4"	
012543	1-1/2"	
018203	2"	
014426	3"	

PVC One-Piece Flange (Soc)

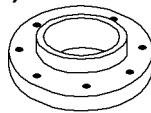

Part #	Size	Price
053478	2"	
015664	6"	

**PVC Flange - Van Stone Style (Soc)
with Plastic Ring**

• Max internal pressure: 150 psi @ 73°F

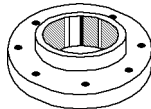

Part #	Size	Price
065708	2-1/2"	
019418	3"	
015298	4"	
037949	6"	
015807	8"	
101905	10"	

**PVC Flange - Van Stone Style (Spgt)
with Plastic Ring**

• Maximum internal pressure: 150 psi @ 73°F

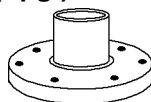

Part #	Size	Price
101904	3"	
101902	4"	
101901	6"	

PVC Sch 80 Unions (Continued)
PVC Flange - Van Stone Style (Spgt)
with Plastic Ring

Part #	Size	Price
101900	8"	
101898	10"	

Stainless Steel Reinforced Fittings

**PVC Female Adapter
(Soc x SR FIP)**

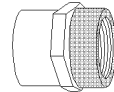

Part #	Size	Price
065711	1/2"	
065713	1"	
065714	1-1/2"	
065715	2"	

**PVC Reducing Female Adapter
(Soc x SR FIP)**

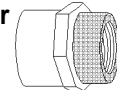

Part #	Size	Price
140959	1" x 1/2"	



PVC Schedule 80 Fittings

PVC Sch 80 Nipples



1/2" Sch 80 PVC Nipple

Part#	Mfg#	Size	Price
105871	882-360	1/2" x 36"	
034778	882-420	1/2" x 42"	

PVC Sewer Fittings

PVC Solvent Weld SDR 35 (ASTM D-3034)

**PVC SDR 35 Straight Tee SW
(H x H x H)**

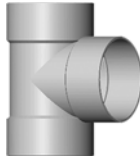

Part #	Mfg #	Size	Type	Price
024581	P104	4"	Molded Fitting	

**PVC SDR 35 Sanitary Tee (TY) SW
(H x H x H)**

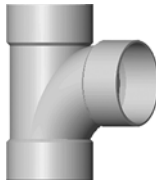

Part #	Mfg #	Size	Type	Price
015310	P156	4"	Molded Fitting	
015671	P157	6"	Molded Fitting	
015814	P158	8"	Molded Fitting	

**PVC SDR 35 Tee Cross SW
(H x H x H)**

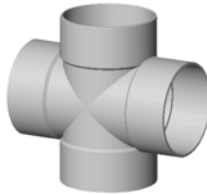

Part #	Mfg #	Size	Type	Price
015304	P179	4"	Molded Fitting	

**PVC SDR 35 1/4 Bend (90°) SW
(H x H)**

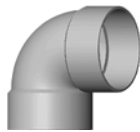

Part #	Mfg #	Size	Type	Price
024582	P204	4"	Molded Fitting	
015674	P206	6"	Molded Fitting	
015818	P208	8"	Molded Fitting	

**PVC SDR 35 Long Turn 1/4 (90°) Bend SW
(H x H)**

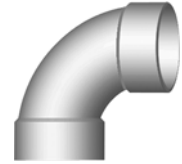

Part #	Mfg #	Size	Type	Price
015314	P256	4"	Molded Fitting	

**PVC SDR 35 Long Turn 1/4 (90°) Bend SW
(H x S)**

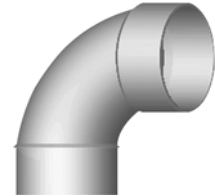

Part #	Mfg #	Size	Type	Price
015309	P274	4"	Molded Fitting	

**PVC SDR 35 45° Wye SW
(H x H x H)**

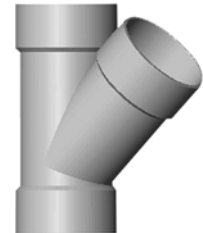

Part #	Mfg #	Size	Type	Price
015313	P304	4"	Molded Fitting	
015731	P316	6" x 4"	Molded Fitting	
015672	P306	6"	Molded Fitting	

**PVC SDR 35 1/8 Bend (45°) SW
(H x H)**



Part #	Mfg #	Size	Type	Price
015312	P504	4"	Molded Fitting	
015673	P506	6"	Molded Fitting	

Pipe Fittings

PVC Sewer Fittings

**PVC SDR 35 1/8 Bend (45°) SW
(H x S)**



Part #	Mfg #	Size	Type	Price
015308	P404	4"	Molded Fitting	

**PVC SDR 35 1/16 Bend (22-1/2°) SW
(H x S)**



Part #	Mfg #	Size	Type	Price
015311	P1704	4"	Molded Fitting	
046503	P1706	6"	Molded Fitting	
015816	P1708	8"	Molded Fitting	

**PVC SDR 35 Coupling SW
(H x H)**

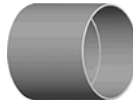

Part #	Mfg #	Size	Type	Price
015303	P604	4"	Molded Fitting	
015668	P606	6"	Molded Fitting	
015810	P608	8"	Molded Fitting	

**PVC SDR 35 Reducer Coupling SW
(H x H)**

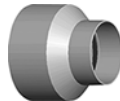

Part #	Mfg #	Size	Type	Price
059488	P654	4" x 3"	Molded Fitting	
015730	P661	6" x 4"	Molded Fitting	

**PVC SDR 35 DWV Coupling SW
(Sewer H x DWV H)**



Part #	Mfg #	Size	Type	Price
015439	P655	4" x 3"	Molded Fitting	
015260	P657	4"	Molded Fitting	
015747	P659	6"	Molded Fitting	

PVC SDR 35 Drain Grate SW



Part #	Mfg #	Size	Type	Price
015305	P911	4"	Molded Fitting	

PVC SDR 35 Threaded Plug SW

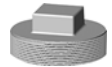

Part #	Mfg #	Size	Type	Price
015307	P1154	4"	Molded Fitting	
015670	P1156	6"	Molded Fitting	
015813	P1158	8"	Molded Fitting	

**PVC SDR 35 DWV Bushing SW
(Sewer Spgt x DWV H)**

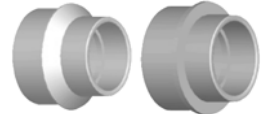

Part #	Mfg #	Size	Type	Price
077448	P1213	4"	Molded Fitting	

**PVC SDR 35 Reducer Bushing SW
(S x H)**

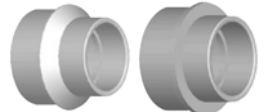

Part #	Mfg #	Size	Type	Price
015861	P1218	8" x 6"	Molded Fitting	

**PVC SDR 35 Adapter SW
(DWV Spgt x Sewer H)**



Part #	Mfg #	Size	Type	Price
027831	P1208	4"	Molded Fitting	

**PVC SDR 35 Female Adapter SW
(H x FIP)**



Part #	Mfg #	Size	Type	Price
063151	P1404	4"	Molded Fitting	
015669	P1406	6"	Molded Fitting	

Pipe Fittings

PVC Sewer Fittings

PVC SDR 35 Fitting Cleanout SW (Spgt x FIP)

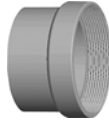

Part #	Mfg #	Size	Type	Price
015306	P1504	4"	Molded Fitting	
015667	P1506	6"	Molded Fitting	

PVC SDR 35 Cap SW



Part #	Mfg #	Size	Type	Price
015301	P1604	4"	Molded Fitting	
015666	P1606	6"	Molded Fitting	
015809	P1608	8"	Molded Fitting	
013196	P16012	12"	Molded Fitting	

PVC Heavy Wall Gasketed SDR 26 (ASTM D-3034)

PVC SDR 26 Stop Coupling (G x G)



Part #	Mfg #	Size	Type	Price
029317	H604	4"	Molded Fitting	

PVC SDR 26 45° Wye Gasketed (G x G x G)



Part #	Mfg #	Size	Type	Price
029310	H304	4"	Molded Fitting	
029311	H306	6"	Molded Fitting	
029312	H3064	6" x 4"	Molded Fitting	

PVC SDR 26 1/4 Bend (90°) Long Sweep Gasketed (G x G)

Part #	Mfg #	Size	Type	Price
029308	H256	4"	Molded Fitting	

PVC SDR 26 1/8 Bend (45°) Gasketed (G x G)



Part #	Mfg #	Size	Type	Price
029315	H504	4"	Molded Fitting	

PVC SDR 26 1/8 Bend (45°) Gasketed (S x G)



Part #	Mfg #	Size	Type	Price
029313	H404	4"	Molded Fitting	
029314	H406	6"	Molded Fitting	

PVC SDR 26 1/16 Bend (22-1/2°) Gasketed (H x H)



Part #	Mfg #	Size	Type	Price
029323	H1704	4"	Molded Fitting	

PVC SDR 26 1/16 Bend (22-1/2°) Gasketed (S x G)



Part #	Mfg #	Size	Type	Price
077445	H1714	4"	Molded Fitting	

PVC SDR 26 Concentric Increaser Coupling Gasketed (G x G)



Part #	Mfg #	Size	Type	Price
029319	H6064	6" x 4"	Molded Fitting	

Pipe Fittings

Rigid Couplings & Repair Clamps

Galv Malleable Iron Compression Fittings

- EPDM Gaskets
- Metal friction ring
- Maximum 125 psi at 180°F
- Fits both IPS and Sch 40 pipe
- Pipe ends must be restrained

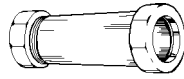

Short/Long

Compression Coupling - Short Pattern Malleable Iron

Part #	Mfg #	Connection	Length	Price
002981	C10-075	3/4" IPS	2-1/2"	

Compression Coupling - Long Pattern Malleable Iron

Part #	Mfg #	Connection	Length	Price
002993	C11-050	1/2" IPS	3-3/8"	
002994	C11-075	3/4" IPS	3-5/8"	
002995	C11-100	1" IPS	3-7/8"	
002996	C11-125	1-1/4" IPS	4-1/8"	
002997	C11-150	1-1/2" IPS	4-5/16"	
002998	C11-200	2" IPS	4-1/2"	
175941	C11-300	3" IPS	7"	
175942	C11-400	4" IPS	8-1/8"	

PVC Compression Fittings

IPS PVC Compression Coupling

- 3-3/4" Body length
- For use with cold water lines only
- Fits IPS and Schedule 40 pipe
- EPDM gaskets
- 150 PSI at 73°F



Part #	Mfg #	Connection	Length	Price
161852	C12-050	1/2"	3-3/4"	
139675	C12-075	3/4"	3-5/16"	
104320	C12-100	1"	4-3/4"	
161853	C12-125	1-1/4"	5-3/16"	
058342	C12-150	1-1/2"	5-3/8"	
161854	C12-200	2"	6"	
223784	C12-400	4"	12"	

Repair Clamps

Stainless Steel Repair Clamp

- Plated Lug, Arriage bolt & nuts
- 301 Stainless Steel Clamp
- Neoprene gaskets for up to 180°
- Long neck carriage bolts for easy installation



Part #	Mfg #	Description	Price
176223	R60300	3"IPS 6" 2 Bolt	
176224	R60400	4"IPS 6" 2 Bolt	

Oetiker PEX Stainless Steel Clamp



Part #	Mfg #	Description	Price
189218	C76074	3/8"	

Rigid Couplings & Repair Clamps

Galvanized Pipe Repair Clamps

Clampette No Lead Pipe Patch Clamp - IPS

- #304 Stainless steel band
- Temperature rating: -40° - 212°F
- Pressure rating: 150 psi



Part #	Mfg #	Size	Bolts	Price
002990	330-033	1/2" x 3"	1	
003000	330-043	3/4" x 3"	1	
002991	330-053	1" x 3"	1	
002986	330-063	1-1/4" x 3"	1	
002983	330-073	1-1/2" x 3"	1	
002999	330-083	2" x 3"	1	
003001	330-046	3/4" x 6"	2	
002992	330-056	1" x 6"	2	



Sharkbite Fittings

Push-To-Connect (PTC) Fittings

- Instant push-fit connection for increased ease-of-use: No soldering, clamps, unions, or glue required
- Fittings certified to 200 PSI and 200°F (93°C): Proven durability and quality
- Fits copper tubing, and CTS CPVC and PEX: Connects all three types in any combination

Push-To-Connect Ball Valves

- Lead free



Part #	Mfg #	Size	Price
161196	22222-0000LF	1/2"	
196592	22185-0000LF	3/4"	
161198	22223-0000LF	1"	

Male Adapters

- Push-To-Connect design combined with standard MNPT adapter on opposite end



Part #	Mfg #	Size	Price
161155	U120LF	1/2" PTC x 1/2" MNPT	
161156	U134LF	3/4" PTC x 3/4" MNPT	
161159	U140LF	1" PTC x 1" MNPT	

Female Adapters

- Push-To-Connect design combined with standard MNPT adapter on opposite end



Part #	Mfg #	Size	Price
161149	U072LF	1/2" PTC x 1/2" FNPT	
161150	U088LF	3/4" PTC x 3/4" FNPT	
161152	U094LF	1" PTC x 1" FNPT	

Push-To-Connect Couplings

- Lead free DZR brass body



Part #	Mfg #	Size	Price
161138	U008LF	1/2"	
161139	U016LF	3/4"	
161140	U020LF	1"	

Push-To-Connect End Caps

- Lead free DZR brass body



Part #	Mfg #	Size	Price
161189	U514LF	1/2"	
161190	U518LF	3/4"	
161191	U520LF	1"	

Push-To-Connect 90° Elbows

- Lead free DZR brass body



Part #	Mfg #	Size	Price
161163	U248LF	1/2"	
161164	U256LF	3/4"	
161165	U260LF	1"	

Push-To-Connect Reducing 90° Elbows

- Lead free DZR brass body



Part #	Mfg #	Size	Price
161170	U274LF	3/4" x 1/2"	

Push-To-Connect Tees

- Lead free DZR brass body



Part #	Mfg #	Size	Price
161179	U362LF	1/2"	
161180	U370LF	3/4"	
161181	U374LF	1"	

Push-To-Connect Reducing Tees

- Lead free DZR brass body



Part #	Mfg #	Size	Price
161187	U454LF	3/4" x 1/2" x 1/2"	
161185	U412LF	3/4" x 3/4" x 1/2"	
161186	U444LF	3/4" x 1/2" x 3/4"	
161188	U416LF	1" x 1" x 3/4"	

Pipe Fittings

Soil No-Hub Fittings

Cast Iron No-Hub Soil Fittings

Cast Iron No-Hub Soil 1/16 Bend

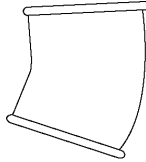

Part #	Size	Price
012489	1-1/2"	
013861	2"	
014383	3"	
015254	4"	
015635	6"	
059068	8"	

Cast Iron No-Hub Soil 1/8 Bend

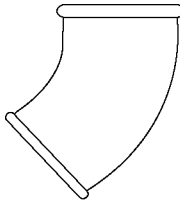

Part #	Size	Price
012491	1-1/2"	
013864	2"	
014386	3"	
015257	4"	
015518	5"	
015637	6"	
015793	8"	
041695	10"	
055789	12"	
078347	15"	

Cast Iron No-Hub Soil 1/6 Bend

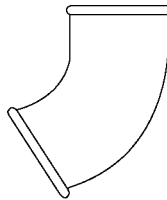

Part #	Size	Price
013863	2"	
014385	3"	
015256	4"	

Cast Iron No-Hub Soil 1/4 Bend

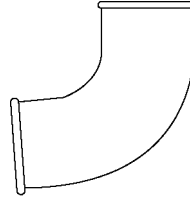

Part #	Size	Price
012490	1-1/2"	
013862	2"	
014384	3"	
015255	4"	
015517	5"	
015636	6"	
015792	8"	

Cast Iron No-Hub Soil Short Sweep 1/4 Bend

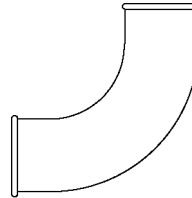

Part #	Size	Price
077149	2"	
077150	3"	
077151	4"	
105252	6"	
082045	8"	
041696	10"	
073167	12"	
078468	15"	

Cast Iron No-Hub Soil Long Sweep 1/4 Bend

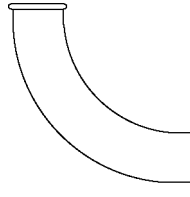

Part #	Size	Price
012483	1-1/2"	
013855	2"	
014377	3"	
015435	4" x 3"	
015248	4"	

Cast Iron No-Hub Soil Fittings (Continued)

Cast Iron No-Hub Soil Long Sweep 1/4 Bend

Part #	Size	Price
019253	5"	
015629	6"	

Cast Iron No-Hub Soil Double 1/4 Bend

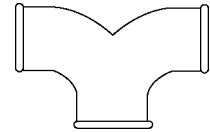

Part #	Size	Price
122211	2"	

Cast Iron No-Hub Soil Sanitary Tee

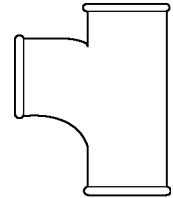

Part #	Size	Price
012486	1-1/2"	
014001	2" x 1-1/2"	
013858	2"	
014485	3" x 1-1/2"	
014529	3" x 2"	
014380	3"	
015395	4" x 2"	
015437	4" x 3"	
015251	4"	
015514	5"	
059066	6" x 3"	
015727	6" x 4"	
015632	6"	
105251	8" x 4"	
089630	8"	

Pipe Fittings

Soil No-Hub Fittings

Cast Iron No-Hub Soil Sanitary Tapped Tee

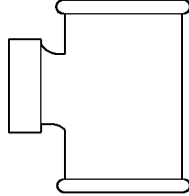

Part #	Size	Price
024764	1-1/2" x 1-1/4"	
012487	1-1/2" x 1-1/2"	
014045	2" x 1-1/4"	
014003	2" x 1-1/2"	
014208	2" x 2"	
014486	3" x 1-1/2"	
014530	3" x 2"	
015367	4" x 1-1/2"	

Cast Iron No-Hub Soil Wye

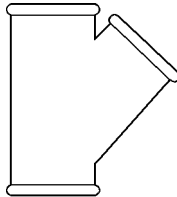

Part #	Size	Price
012488	1-1/2"	
013860	2"	
014531	3" x 2"	
014382	3"	
015397	4" x 2"	
015438	4" x 3"	
015253	4"	
015547	5" x 4"	
015516	5"	
015717	6" x 3"	
015728	6" x 4"	
043550	6" x 5"	
015634	6"	
082087	8" x 3"	
015849	8" x 4"	
036189	8" x 5"	
015858	8" x 6"	
015791	8"	
057640	10" x 4"	
041599	10" x 6"	
046771	10" x 8"	

Cast Iron No-Hub Soil Fittings (Continued)

Cast Iron No-Hub Soil Wye

Part #	Size	Price
012301	10"	
060519	12"	
080847	15"	

Cast Iron No-Hub Soil Double Wye

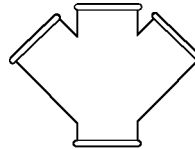

Part #	Size	Price
013853	2"	
014375	3"	
015393	4" x 2"	
069698	4" x 3"	
015246	4"	

Cast Iron No-Hub Soil Combination Wye & 45° Elbow

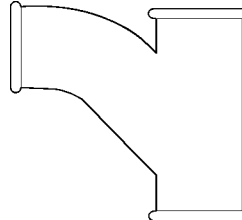

Part #	Size	Price
046775	2" x 1-1/2"	
013852	2"	
014526	3" x 2"	
014374	3"	
015391	4" x 2"	
015433	4" x 3"	
015245	4"	
015716	6" x 3"	
046777	6" x 4"	

Cast Iron No-Hub Soil Double Combination Wye & 45° Elbow

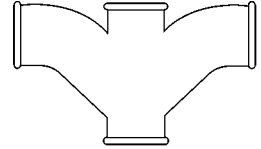

Part #	Size	Price
051139	2"	
110029	3"	
015392	4" x 2"	
057639	4"	

Cast Iron No-Hub Tapped Double Wye

Part #	Size	Price
102027	2" x 1-1/2"	

Cast Iron No-Hub Soil Sanitary Cross

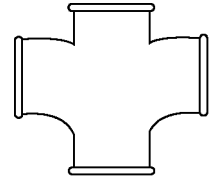

Part #	Size	Price
090971	1-1/2"	
013851	2"	
014525	3" x 2"	
075602	3"	
015390	4" x 2"	
082088	4" x 3"	
030652	4"	
082044	6" x 4"	
082042	8" x 4"	

Cast Iron No-Hub Soil Sanitary Tap Cross

Part #	Size	Price
069699	2" x 1-1/4"	
014002	2" x 1-1/2"	

Pipe Fittings

Soil No-Hub Fittings

Cast Iron No-Hub Soil Test Tee with Type A Brass Plug

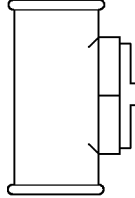

Part #	Size	Price
013859	2" - 2"	
014381	3" - 3"	
015252	4" - 4"	
015515	5" - 5"	
015633	6" - 6"	
031673	8" - 8"	

Cast Iron No-Hub Soil Test Tee Less Plug

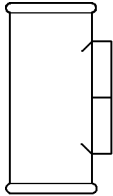

Part #	Size	Price
052546	10" - 10"	

Cast Iron No-Hub Soil Short Reducer

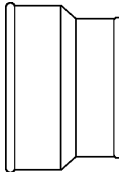

Part #	Size	Price
014000	2" x 1-1/2"	
071374	3" x 1-1/2"	
014528	3" x 2"	
015394	4" x 2"	
015436	4" x 3"	
015546	5" x 4"	
041601	6" x 2"	
040267	6" x 3"	
015726	6" x 4"	
015741	6" x 5"	
015848	8" x 4"	
033726	8" x 5"	
015857	8" x 6"	
041603	10" x 6"	

Cast Iron No-Hub Soil Fittings (Continued)

Cast Iron No-Hub Soil Short Reducer

Part #	Size	Price
036568	10" x 8"	
060521	12" x 6"	
068555	12" x 10"	
105522	15" x 8"	
078471	15" x 10"	
080846	15" x 12"	

Cast Iron No-Hub Soil Cleanout Ferrule with Type A Brass Plug

Part #	Size	Price
013854	2" - 1-1/2"	
014376	3" - 2-1/2"	
015247	4" - 3-1/2"	
052548	5" - 4"	
015628	6" - 5"	
068545	8" - 6"	

Cast Iron No-Hub Soil Blind Plug



Part #	Size	Price
012481	1-1/2"	
013849	2"	
014372	3"	
015242	4"	
027135	6"	
102463	12"	

Cast Iron No-Hub Soil P-Trap

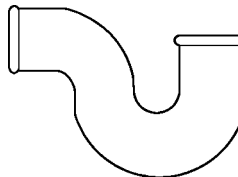

Part #	Size	Price
012484	1-1/2"	
013856	2"	
014378	3"	
015249	4"	

Cast Iron No-Hub Soil Closet Flange (Slot & Notch)

Part #	Size	Price
015468	4" x 3" x 3-1/2"	
015488	4" x 4" x 4"	

Pipe Fittings



Soil No-Hub Fittings

No-Hub Pipe Couplings

- *Lightweight*
- *Cast iron soil pipe*
- *Easy to install with standard 60"/lbs torque wrenches*
- *Longer slots on clamping band provide greater adaptability to varying cast iron pipe diameters*
- *Conforms to ASTM C 564-91 and ASTM A 167-91*



Part #	Mfg #	Size	Price
012482	C-150-C	1-1/2"	
013850	C-200-C	2"	
013999	C-215-C	2" - 1-1/2"	
014373	C-300-C	3"	
014524	C-320-C	3" - 2"	
015244	C-400-C	4"	
015389	C-420-C	4" - 2"	
015432	C-430-C	4" - 3"	
015512	C-500-C	5"	
015627	C-600-C	6"	
015789	C-800-C	8"	
012300	C-1000-C	10"	
054923	C-1200-C	12"	

Heavyweight No-Hub Coupling

- *Multiple bands attached to a heavy duty corrugated stainless steel shield over a molded 1-piece elastomer sealing sleeve*
- *12.5% Thicker stainless steel strap bands*
- *Extra-positive seal*
- *Greater surface load bearing contact of 304 stainless steel shields accommodates additional sealing clamp and provides for greater load bearing contact between coupling and pipe surface*
- *(4) Additional protection sealing rings are incorporated as an integral circumferential continuous sealing register gasket - restraining joint movement*



Part #	Mfg #	Size	Price
054924	C-1500-HW	15"	

Pipe Fittings

Soil No-Hub Fittings

Super Duty No-Hub Pipe Couplings

Husky SD 4000 Super Duty No-Hub Couplings

- *Stainless steel coupling*
- *Extra width*
- *Shield color coated orange*

HUSKY



Part #	Mfg #	Size	Price
112671	4002	1-1/2"	
112672	4006	2"	
112673	4008	3"	
112682	4009	4" x 3"	
112674	4010	4"	
112675	4012	5"	
112676	4014	6"	
112677	4016	8"	

Soil SV Fittings

**Cast Iron Service-Weight
Soil Fittings**

**Cast Iron Single-Hub
Service-Weight Soil 1/16 Bend**

Part #	Size	Price
013937	2"	
014448	3"	
015335	4"	
015688	6"	
015827	8"	

**Cast Iron Single-Hub
Service-Weight Soil 1/8 Bend**

Part #	Size	Price
013940	2"	
014451	3"	
015338	4"	
015527	5"	
015690	6"	
015829	8"	
012318	10"	
013207	12"	
023108	15"	

**Cast Iron Single-Hub
Service-Weight Soil 1/6 Bend**

Part #	Size	Price
013939	2"	
014450	3"	
015337	4"	

**Cast Iron Single-Hub
Service-Weight Soil 1/4 Bend**

Part #	Size	Price
013938	2"	
014449	3"	
015336	4"	
043549	5"	
015689	6"	
015828	8"	
012317	10"	
059067	12"	

**Cast Iron Single-Hub
Service-Weight Soil Long 1/4
Bend**

Part #	Size	Price
120468	4" - 12"	
120476	4" - 18"	

**Cast Iron Single-Hub
Service-Weight Soil Short Sweep
Bend**

Part #	Size	Price
089347	3"	
089348	4"	
110025	12"	

**Cast Iron Single-Hub
Service-Weight Soil Long Sweep
Bend**

Part #	Size	Price
013931	2"	
014543	3" x 2"	
014442	3"	
015455	4" x 3"	
015328	4"	
015525	5"	
015684	6"	
015825	8"	
032842	12"	

**Cast Iron Service-Weight
Single-Hub Soil Wye**

Part #	Size	Price
013936	2"	
014547	3" x 2"	
014447	3"	
015409	4" x 2"	
015460	4" x 3"	
015334	4"	
015540	5" x 2"	
015526	5"	
015710	6" x 2"	
015721	6" x 3"	
015736	6" x 4"	
015687	6"	
015853	8" x 4"	
015855	8" x 5"	

**Cast Iron Service-Weight
Soil Fittings (Continued)**

**Cast Iron Service-Weight
Single-Hub Soil Wye**

Part #	Size	Price
015864	8" x 6"	
015826	8"	
032688	10" x 4"	
012330	10" x 6"	
031677	10" x 8"	
031678	10"	
013364	12" x 4"	
032845	12" x 6"	
032167	12" x 8"	
013206	12"	
032844	15"	

**Cast Iron Service-Weight Soil
Double Wye**

Part #	Size	Price
019500	3" x 2"	
014440	3"	
027136	4" x 2"	
015454	4" x 3"	
015326	4"	

**Cast Iron Service-Weight Soil
Combination Wye & 45° Elbow
(Long Turn Pattern)**

Part #	Size	Price
013929	2"	
014542	3" x 2"	
014438	3"	
015403	4" x 2"	
015452	4" x 3"	
015323	4"	
015719	6" x 3"	
015732	6" x 4"	
024902	6"	
033320	8"	

**Cast Iron Service-Weight Soil
Double Combination Wye & 45°
Elbow (Long Turn Pattern)**

Part #	Size	Price
014439	3"	

Pipe Fittings

Soil SV Fittings

Cast Iron Service-Weight Soil Fittings (Continued)

Cast Iron Service-Weight Soil Double Combination Wye & 45° Elbow (Long Turn Pattern)

Part #	Size	Price
015404	4" x 2"	
015453	4" x 3"	
015324	4"	

Cast Iron Service-Weight Soil Sanitary Tee

Part #	Size	Price
013934	2"	
014546	3" x 2"	
014445	3"	
015408	4" x 2"	
015459	4" x 3"	
015332	4"	
043551	6" x 2"	
015735	6" x 4"	
023086	8"	
018847	10" x 6"	

Cast Iron Service-Weight Soil Sanitary Cross

Part #	Size	Price
043553	4" x 3"	

Cast Iron Service-Weight Closet Bend Plain - Less Collar

Part #	Size	Price
015466	3" x 4" x 16" x 16"	
015477	4" x 4" x 16"	
015499	4" x 6" x 16"	
015377	4" x 16" x 16"	

Cast Iron Service-Weight Soil P-Trap

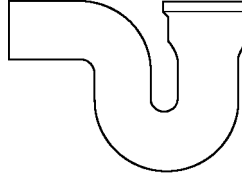

Part #	Size	Price
013932	2"	
014443	3"	
015329	4"	
015685	6"	
032765	8"	

Cast Iron Service-Weight Washington Test Tee with Southern Raised Head Brass Plug Installed

Part #	Size	Price
035296	8" - 8"	

Cast Iron Service-Weight Miami Test Tee with Southern Raised Head Brass Plug Installed

Part #	Size	Price
013935	2" - 2"	
014446	3" - 3"	
015333	4" - 4"	
015686	6" - 6"	

Cast Iron Service-Weight Double Two-Way Cleanout

Part #	Size	Price
025202	4"	

Cast Iron Service-Weight Cleanout Ferrules with Southern Raised Head Brass Plug Installed

Part #	Size	Price
013928	2" - 1-1/2"	
014437	3" - 2-1/2"	
015682	6" - 5"	
023087	8" - 6"	
015371	4" x 12" - 3-1/2"	

Cast Iron Service-Weight Bar Grate with Legs

Part #	Size	Price
013925	2"	

Cast Iron Service-Weight Reducer

Part #	Size	Price
014544	3" x 2"	
015405	4" x 2"	
015456	4" x 3"	
021259	5" x 4"	
015720	6" x 3"	
015734	6" x 4"	
015743	6" x 5"	
031676	8" x 4"	
015863	8" x 6"	
018846	10" x 4"	
033319	10" x 6"	
012332	10" x 8"	
089350	12" x 4"	
013393	12" x 8"	
013225	12" x 10"	
032843	15" x 8"	
013627	15" x 12"	

Cast Iron Service-Weight Double-Hub Fitting

Part #	Size	Price
015325	4"	

Cast Iron Service-Weight Pipe Plug

Part #	Size	Price
013926	2"	
014435	3"	
015320	4"	
015681	6"	
023088	8"	

Pipe Fittings

Soil SV Fittings

Specialty Cast Iron Soil Fittings

Specialty Cast Iron Notched and Slotted Closet Flange

- Fits over 4" pipe for caulk joints

Part #	Size	Price
015365	4" x 1-1/2"	
015386	4" x 2"	
015429	4" x 3"	
015212	4" x 4"	
015497	4" x 6"	

Cast Iron Hub End Closet Bend, Low Hub

Part #	Size	Price
015476	4" x 16"	

Soil SV Fittings

**Cast Iron Service-Weight Soil
Fittings**

**Cast Iron Service-Weight Short
Sweep Bend**

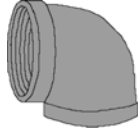

Part #	Mfg #	Size	Price
089346	001102	2"	



Soil SV Fittings

Mission Tite® Gaskets

Mission Tite® Service-Weight Gasket

- For connecting bell and spigot cast iron pipe
- Meets ASTM C 564



Part #	Mfg #	Size	Price
069464	SW-2	2"	
069465	SW-3	3"	
069466	SW-4	4"	
069467	SW-5	5"	
069468	SW-6	6"	
069469	SW-8	8"	
069470	SW-10	10"	
069471	SW-12	12"	
069472	SW-15	15"	

Mission Tite® Extra Heavy Weight Gasket

- For connecting bell and spigot cast iron pipe
- Meets ASTM C 564



Part #	Mfg #	Size	Price
124425	SW-2XH	2"	
124426	SW-3XH	3"	
124427	SW-4XH	4"	

Pipe Fittings

Soil SV Fittings

Pipe Gaskets

Dual Tite Buna N "Nitrile" Gasket



Part #	Mfg #	Size	Price
137342	V98-002	2"	
137343	V98-003	3"	
137344	V98-004	4"	
137347	V98-006	6"	

Soil SV Fittings

Anaco® Service-Weight Gaskets

EZ Tight SV Gasket



Part #	Mfg #	Size	Price
013930	3102	2"	
014441	3103	3"	
015327	3104	4"	
015524	3105	5"	
015683	3106	6"	

Pipe Fittings

Soil SV Fittings

Cleanout Plugs

Commercial Brass Flush Plug

- Combine with FIP adapters to make cleanouts or flush plug assemblies
- Square head models are Southern code
- Brass construction for heavy duty applications

Part #	Mfg #	Style	Size	Price
184061	877-935	Slotted	3-1/2"	

Residential Cast Iron Closet Flange

- Fits over 4" cast iron DWV pipe
- Perfect for retrofit or remodel applications
- Easy compression installation with neoprene gasket
- Integral neoprene cover/cap removes with utility knife after test



Part #	Mfg #	Connection	Price
184072	890-142	4" Compression	



TecTite Fittings

TecTite™ Fittings

200 TecTite™ Coupling with Stop (C x C)



Part #	Mfg #	Size	Price
098073	88005	1/2"	
098075	88010	3/4"	
110136	88014	1"	
114714	88011	1-1/4"	
113216	88016	1-1/2"	
114715	88029*	2"	

* Low lead

201 TecTite™ Slip Coupling (C x C)



Part #	Mfg #	Size	Price
110147	88111	1/2"	
110148	88113	3/4"	
110149	88115	1"	

201-R TecTite™ Reducer Coupling (C x C)



Part #	Mfg #	Size	Price
142374	88420	1/2" x 3/8"	
098076	88075	3/4" x 1/2"	
110137	88078	1" x 3/4"	

203 TecTite™ Female Adapter (C x F)



Part #	Mfg #	Size	Price
098077	88035	1/2"	
098079	88040	3/4"	
110138	88044	1"	
114716	88043	1-1/4"	
142378	88043	1-1/4"	
114718	88041	2"	

203-R TecTite™ Low Lead Reducing Female Adapter (C x F)



Part #	Mfg #	Size	Price
142372	77358	1/2" x 3/4"	

204 TecTite™ Male Adapter (C x M)



Part #	Mfg #	Size	Price
098080	88025	1/2"	
098081	88030	3/4"	
110139	88034	1"	
114719	88026	1-1/4"	
114720	88027	1-1/2"	
114721	88028	2"	

204-R TecTite™ Reducing Male Adapter (C x M)



Part #	Mfg #	Size	Price
142370	77380*	1/2" x 3/4"	
110140	88094	1" x 3/4"	

* Low lead

207 TecTite™ 90° Elbow (C x C)



Part #	Mfg #	Size	Price
144181	88012	3/8"	
098082	88015	1/2"	
098083	88020	3/4"	
110141	88024	1"	
114728	88021	2"	

Pipe Fittings



TecTite Fittings

2707-3-5 TecTite™ 90° Drop Ear Elbow (C x F)



Part #	Mfg #	Size	Price
098084	88055	1/2"	

207-4 Low Lead 90° Male Elbow (C x M)



Part #	Mfg #	Size	Price
142377	10177351	1/2"	

208 Water Heater Hose - Low Lead

- C x 20" Hose x FMPT



Part #	Mfg #	Nom Size	Price
126932	10155506	1/2" x 3/4"	

210 TecTite™ Ball Valve



Part #	Mfg #	Size	Price
110150	88101	1/2"	
110151	88103	3/4"	
110152	88105	1"	

211 TecTite™ Tee (C x C x C)



Part #	Mfg #	Size	Price
144178	88059	3/8"	
144179	88063	3/8" x 3/8" x 1/2"	
144180	88061	1/2" x 1/2" x 3/8"	
098085	88060	1/2"	

TecTite™ Fittings (Continued)

211 TecTite™ Tee (C x C x C)

Part #	Mfg #	Size	Price
098087	88070	3/4" x 1/2"	
098086	88065	3/4"	
110145	88074	1" x 3/4"	
110144	88068	1"	

211-R Reducer Tee (C x C x C)



Part #	Mfg #	Size	Price
110143	88076	3/4" x 1/2" x 3/4"	
110142	88082	3/4" x 1/2" x 1/2"	

217 TecTite™ Tube Cap



Part #	Mfg #	Size	Price
097652	88045	1/2"	
097653	88050	3/4"	
110154	88054	1"	

Demounting Clip - Removal Key



Part #	Mfg #	Size	Price
098088	65630	1/2"	
098089	65625	3/4"	
110146	65627	1"	

Viega-PEX Fittings

Viega ProPress® Manifold Valves

ProPress® Copper Manifold Valve (P x Copper)

- Zero Lead™ brass
- 1/2" ProPress tool required
- Sleeve not included



Part #	Mfg #	Size	Price
110376	95002	1/2" x 1/2"	

Viega PureFlow® PEX Press Fittings

Viega PEX Press Coupling (Press x Press)

- Radel R
- Smart Connect® feature
- Zero Lead™



Part #	Mfg #	Size	Price
147121	49343	1/2" x 3/4"	
147118	49403	1/2" x 1/2"	
147119	49404	3/4" x 3/4"	
147123	49405	1" x 1"	

Viega PEX Press Elbow (Press)

- Radel R
- Smart Connect® feature
- Zero Lead™



Part #	Mfg #	Size	Price
147124	49220	1/2"	
147125	49240	3/4"	
147126	49260	1"	

Viega PEX Press Elbow - Drop Ear (Press x FNPT)

- Bronze



Part #	Mfg #	Size	Price
126478	94520	1/2" x 1/2"	
140025	94540	3/4" x 3/4"	

Viega PEX Press Tee (Press x Press x Press)

- Radel R
- Smart Connect® feature
- Zero Lead™



Part #	Mfg #	Size	Price
147127	49520	1/2"	
147128	49334	1/2" x 1/2" x 3/4"	
147129	49540	3/4"	
147131	49433	3/4" x 1/2" x 1/2"	
147132	49434	3/4" x 1/2" x 3/4"	
147133	49443	3/4" x 3/4" x 1/2"	
147134	49560	1"	
147135	49533	1" x 1/2" x 1/2"	
147136	49535	1" x 1/2" x 1"	
147137	49543	1" x 3/4" x 1/2"	
147138	49544	1" x 3/4" x 3/4"	
147140	49545	1" x 3/4" x 1"	
147141	49553	1" x 1" x 1/2"	
147142	49554	1" x 1" x 3/4"	

Viega PEX Press Test Plug (Press)

- Radel R
- Smart Connect® feature
- Zero Lead™



Part #	Mfg #	Size	Price
147143	49723	1/2"	
147144	49744	3/4"	
147145	49765	1"	

Viega PEX Press Lav Adapter (Press x Lav)

- Bronze
- Metal nut
- Sleeve not included



Part #	Mfg #	Size	Price
108376	97003	1/2" x 1/2"	

Viega PEX Press Copper Stub-Out - Straight (Press x Copper x Length)

- Copper
- Sleeve not included



Part #	Mfg #	Size	Price
099872	92609	1/2" x 1/2" x 8"	
099873	92616	1/2" x 1/2" x 15"	

Pipe Fittings

Viega-PEX Fittings

**Viega PEX Press Stub-Out - Elbow
(Press x Copper x Length)**

- Copper
- Sleeve not included



Part #	Mfg #	Size	Price
099871	92421	1/2" x 1/2" (3-1/2" x 8")	

**Viega PEX Press Tub Els
(Press x Copper x Length)**

- Copper
- Sleeve not included



Part #	Mfg #	Size	Price
099870	92221	1/2" x 1/2" (3" x 6")	

Viega PEX Press 90° Stub-Out

- Copper
- Press connection, street
- Wall plate



Part #	Mfg #	Size	Price
163985	92321	1/2" x 1/2" (3-1/2" x 8")	

**Viega PEX Press Ball Valve
(Press x Press)**

- Zero Lead™ brass
- Sleeve not included



Part #	Mfg #	Size	Price
099874	94521	1/2" x 1/2"	
099875	94541	3/4" x 3/4"	

**Viega PEX Straight Stop Valve
(Press x CTS)**

- Chrome-plated Zero Lead™ brass
- 1/4-Turn
- Sleeve not included



Part #	Mfg #	Size	Price
099876	93031	1/2" x 1/4"	

PureFlow® PEX Crimp Fittings

Viega PEX Crimp Ring

- Copper
- For use with Viega PEX crimp fittings and tools only



Part #	Mfg #	Size	Price
099796	43620	1/2"	
099797	43640	3/4"	
099798	43660	1"	

**Viega PEX Crimp Copper Adapter - Tubing
(Crimp x Copper Female)**

- Zero Lead™ brass



Part #	Mfg #	Size	Price
105078	46635	1/2" x 1/2"	

**Viega PEX Crimp Copper Adapter - Fitting
(Crimp x Copper Male)**

- Zero Lead™ brass



Part #	Mfg #	Size	Price
105079	46633	1/2" x 1/2"	

**Viega PEX Crimp Brass Adapter - Fitting
(PEX x MNPT)**

- Zero Lead™ brass



Part #	Mfg #	Size	Price
105089	48366	1" x 1"	

**Viega PEX Crimp Test Plug
(Crimp)**

- Zero Lead™ poly



Part #	Mfg #	Size	Price
105124	43723	1/2"	
105125	43744	3/4"	
105126	43765	1"	

Pipe Fittings

Veiga-PEX Fittings

PureFlow® PEX Press Outlet Boxes

PEX Press Washing Machine Outlet Box

- Wall-mount
- 1/4-Turn valves with color coded handles
- Sleeves not included
- Zero Lead™



Part #	Mfg #	Size (Press Vlv)	Price
106744	57011	1/2"	

PEX Press Ice Maker Outlet Box

- Wall-mount
- Zero Lead™ brass valve



Part #	Mfg #	Size (Press Vlv)	Price
166334	98000	1/2"	

PureFlow® Plumbing Accessories

Economy PEX Tubing Clamp



Part #	Mfg #	Size	Price
115196	52120	1/2"	

Snap-In Bend Support

- Bend supports snap in on 2" centers
- Not for use with FostaPEX®



Part #	Mfg #	Size	Price
110768	51021	1/2"	

Veiga PEX Press Adapter - Copper Tubing (Press x Copper Female)

- Bronze



Part #	Mfg #	Size	Price
125874	92021	1/2" x 1/2"	
125875	92026	1/2" x 3/4"	
125876	92036	3/4" x 1/2"	
125878	92041	3/4" x 3/4"	
125879	92060	1" x 1"	

Veiga PEX Press Adapter - Copper Fitting (Press x Copper Male)

- Bronze



Part #	Mfg #	Size	Price
125844	97520	1/2" x 1/2"	
125845	97525	1/2" x 3/4"	
125846	97540	3/4" x 3/4"	
125848	97560	1" x 1"	

Veiga PEX Press Adapter (P x P)

- Bronze
- Press connection



Part #	Mfg #	Size	Price
159712	99620	1/2" x 1/2"	
105047	99640	3/4" x 3/4"	

Veiga PEX Press Adapter - Male (Press x MPT)

- Bronze



Part #	Mfg #	Size	Price
160420	90521	1/2" x 1/2"	
160115	90526	1/2" x 3/4"	
160320	90541	3/4" x 3/4"	
125790	90561	1" x 1"	
187733	90571	1-1/4" x 1-1/4"	
187734	90581	1-1/2" x 1-1/2"	
187735	90591	2" x 2"	

Veiga PEX Press Adapter - Female (Press x FNPT)

- Bronze



Part #	Mfg #	Size	Price
160321	91520	1/2" x 1/2"	
125786	91525	1/2" x 3/4"	
125166	91540	3/4" x 3/4"	
125787	91560	1" x 1"	

Veiga PEX Press Coupling (Press x Press)

- Bronze



Part #	Mfg #	Size	Price
125832	93020	1/2"	

Pipe Fittings



Viega-PEX Fittings

PureFlow® Plumbing Accessories (Continued)

Viega PEX Press Coupling (Press x Press)

Part #	Mfg #	Size	Price
125834	93050	1/2" x 3/4"	
125833	93040	3/4"	
125835	93055	3/4" x 1"	
125836	93060	1"	

Viega PEX Press Elbow (Press x Press)

- Bronze



Part #	Mfg #	Size	Price
124857	93520	1/2"	
124858	93540	3/4"	
124859	93560	1"	

Viega PEX Press Elbow (Press x Copper)

- Bronze

Part #	Mfg #	Size	Price
109711	99308	1/2" x 3/4"F	
109712	99309	3/4" x 3/4"F	
109713	99310	1/2" x 1/2"M	

Viega PEX Press Elbow - Male (Press x MNPT)

- Bronze

Part #	Mfg #	Size	Price
125880	92520	1/2" x 1/2"	

Viega PEX Press Tee (Press x Press x Press)

- Bronze



Part #	Mfg #	Size	Price
124860	94020	1/2"	
124861	94022	1/2" x 3/4"	
124862	94040	3/4"	
124863	94032	3/4" x 1/2" x 1/2"	
124864	94034	3/4" x 1/2" x 3/4"	
124865	94036	3/4" x 1/2"	
124866	94060	1"	

PureFlow® Plumbing Accessories (Continued)

Viega PEX Press Tee (Press x Press x Press)

Part #	Mfg #	Size	Price
124867	94037	1" x 1/2" x 1/2"	
124869	94052	1" x 3/4" x 3/4"	
124871	94050	1" x 1/2"	
124872	94056	1" x 3/4"	

Viega PEX Press Adapter (Press x C)

- Bronze
- Press connection, female copper tube size



Part #	Mfg #	Size	Price
187704	92080	1-1/2" x 1-1/2"	
187705	92090	2" x 2"	

Polymer PEX Press Fittings

Viega PEX Press 90° Elbow

- Polymer
- Press connection



Part #	Mfg #	Size	Price
187651	49270	1-1/4"	
187652	49280	1-1/2"	
187653	49290	2"	

Viega PEX Press Coupling

- Polymer
- Press connection



Part #	Mfg #	Size	Price
187802	49358	1-1/2" x 1"	
187800	49398	2" x 1-1/2"	
187661	49407	1-1/4" x 1-1/4"	
187662	49408	1-1/2" x 1-1/2"	
187663	49409	2" x 2"	

Pipe Fittings

Viega-PEX Fittings

Viega PEX Press Tee

- Polymer
- Press connection



Part #	Mfg #	Size	Price
187736	49570	1-1/4" x 1-1/4" x 1-1/4"	
187737	49580	1-1/2" x 1-1/2" x 1-1/2"	
187738	49590	2" x 2" x 2"	
187665	49755	1-1/4" x 1" x 1"	
187664	49774	1-1/4" x 1-1/4" x 3/4"	
187656	49855	1-1/2" x 1" x 1"	
187657	49874	1-1/2" x 1-1/4" x 3/4"	
187658	49875	1-1/2" x 1-1/4" x 1"	
187654	49884	1-1/2" x 1-1/2" x 3/4"	
187655	49885	1-1/2" x 1-1/2" x 1"	
187660	49985	2" x 1-1/2" x 1"	
187797	49994	2" x 2" x 3/4"	
187804	49995	2" x 2" x 1"	
187799	49998	2" x 2" x 1-1/2"	

ProRadiant™ Fasteners

Snap Clip

- Not for use with FostaPEX®



Part #	Mfg #	Size	Price
120867	58016	3/8" Double	

Veiga Manifolds

Veiga PureFlow® Manifolds

PureFlow® PEX Press Brazed Manifold - Female (Inlet x Press - # of Outlets)

- Copper
- Sleeves not included



Part #	Mfg #	Size	Outlet(s)
099827	65604	1" x 1/2"	4
099829	65608	1" x 1/2"	8
102917	65610	1" x 1/2"	10
102918	65612	1" x 1/2"	12

Veiga PEX Press Manifolds

Veiga PEX Press Manifold

- Smart connect feature
- For use with VeigaPEX™ Ultra, Veiga FostaPEX™, or VeigaPEX™
- Only use with lock clip #58075
- Press connection
- Flow through
- Does not include mounting hardware



Part #	Mfg #	Size	Outlet(s)
160497	49054	3/4" x 3/4" x 1/2"	4
160488	49152	3/4" x 3/4" x 1/2"	2
160496	49153	3/4" x 3/4" x 1/2"	3
160498	49254	1" x 3/4" x 1/2"	4
160501	49256	1" x 1" x 1/2"	6
160502	49258	1" x 1" x 1/2"	8

Veiga MANABLOC® Manifolds

MANABLOC® - Compression

- Compression port adapters
- Home run distribution manifold
- Factory assembled with valves
- Color coded ports for hot and cold water
- Zero Lead™
- Supply connections sold separately

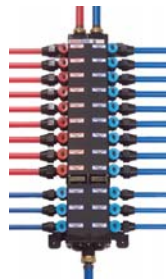

Part #	Mfg #	Size	Hot/Cold	Price
086010	36144	14 Ports: 1/2"	6/8	
086011	36183	18 Ports: 1/2"	8/10	
086012	36243	24 Ports: 1/2"	9/15	
086013	36303	30 Ports: 1/2"	12/18	
086014	36363	36 Ports: 1/2"	14/22	

MANABLOC® PEX Crimp

- Zero Lead® brass port adapters
- Home run distribution manifold
- Factory assembled with valves
- Color coded ports for hot and cold water
- Supply connections sold separately

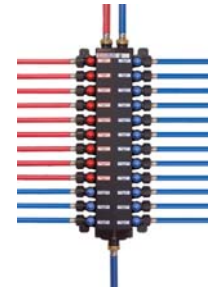

Part#	Mfg#	Size	Hot/Cold	Price
126790	41303	30 Ports: 1/2"	12/18	
126792	41363	36 Ports: 1/2"	14/22	

MANABLOC®/MiniBloc™ Accessories

MANABLOC® Wrench

- Use with compression MANABLOC® or MiniBloc™ only



Part #	Mfg #	Size	Price
094674	50631	3/8" & 1/2"	

Veiga PEX Press Port Adapter (Press x MANABLOC Port)

- Zero Lead™ bronze
- Connects distribution lines to MANABLOC® and MiniBloc™



Part #	Mfg #	Size	Price
110815	96120	1/2" x 1/2"	

PEX Crimp Supply Adapter (Crimp x MANABLOC Supply)

- Zero Lead™ brass
- Connects PEX supply lines to MANABLOC® and MiniBloc™



Part #	Mfg #	Size	Price
117862	46414	3/4" x 1"	
121064	46416	1" x 1"	

Pipe Fittings

Viega Manifolds

ViegaPEX™ Press Supply Adapter (Press x MANABLOC Supply)

- Bronze
- Connects PEX supply lines to MANABLOC® and MiniBloc™



Part #	Mfg #	Size	Price
132173	86141	3/4" x 1"	

ProPress® MANABLOC® Supply Adapter (P x MANABLOC Supply)

- Bronze
- Connects copper supply lines to MANABLOC® and MiniBloc™



Part #	Mfg #	Size	Price
110816	33304	3/4" x 1"	

MANABLOC® Supply Adapter - Male (MNPT x MANABLOC Supply)

- Zero Lead™ brass
- Connects FNPT supply lines to MANABLOC® and MiniBloc™



Part #	Mfg #	Size	Price
121704	46646	3/4" x 1"	
117863	46656	1" x 1"	

MiniBloc™ Supply Coupling (MiniBloc x MiniBloc)

- Poly Alloy
- Connects two MINIBLOC™'s together

Part #	Mfg #	Size	Price
103617	50355	1" x 1"	

MANABLOC® Cap

- Zero Lead™



Port Cap

Part #	Mfg #	Size	Price
100136	36203	1/2" Port	
086005	53601	1" Supply	

MANABLOC®/MiniBloc™ - Compression Accessory

- For use with MANABLOC® compression fittings
- Zero Lead™

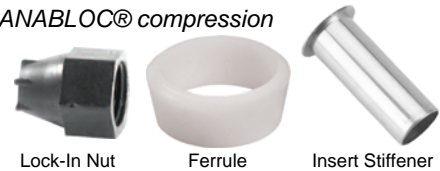

Lock-In Nut

Ferrule

Insert Stiffener

Part #	Mfg #	Size	Price
147224	36003	1/2" Lock-in Nut	
112781	36403	1/2" Lock-in Insert	
112780	53020	1/2" Ferrule	
112779	56120	1/2" SS Insert Stiffener	

ProRadiant™ Manifold Accessories

Viega PEX Press Sleeve (Press)



- Stainless steel
- For use with Viega PEX Press fittings and tools only

Part #	Mfg #	Size	Price
099866	61020	1/2"	
099867	61040	3/4"	
099868	61060	1"	

Viega PEX Tools

Tools

PEX Press Tool

- Ratcheting design
- Color coded handles



Part#	Mfg#	Size	Color	Price
099878	50020	1/2"	Yellow	
099879	50040	3/4"	Blue	
099880	50060	1"	Orange	

PEX Press Tool Set

- Starter set includes:
 - 1/2" and 3/4" PEX Press tools
 - and basic tubing cutter
 - with three additional slots



Part#	Mfg#	Description	Price
099881	56000	Starter PEX Tool Set	

PEX Press Jaw

- For Rigid standard tools, PEX tubing
- Steel



Part #	Mfg #	Size	Price
187789	56073	1/2"	
187790	56075	3/4"	
187791	56076	1"	
187792	56080	1-1/4"	
187793	56081	1-1/2"	
187794	56082	2"	

Pipe Fittings

Watts-PEX Fittings

Copper Manifolds

Closed End x 1" Swaged End Manifold

- 1" Diameter manifold trunks are closed at one end and swaged to accept 1" copper at the other
- 3/8" x 1/2" Brass CrimpRing™ fittings, with or without 1/4-turn brass mini ball valves (MBV)
- Branches are 2" O.C.
- Manifolds are sold individually
- Order one for hot and one for cold

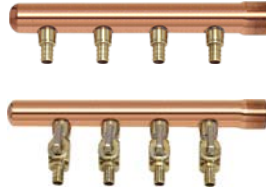

Part #	Mfg#	Description	Price
161078	0121098	4 Port x 1/2" CF	
159387	0121104	4 Port x 1/2" CF/MBV	
160795	0121099	6 Port x 1/2" CF	
159388	0121105	6 Port x 1/2" CF/MBV	
161028	0121100	8 Port x 1/2" CF	
159389	0121106	8 Port x 1/2" CF/MBV	
160794	0121101	10 Port x 1/2" CF	
159390	0121107	10 Port x 1/2" CF/MBV	
160945	0121102	12 Port x 1/2" CF	
159391	0121108	012110812 Port x 1/2" CF/MBV	

Closed End x 3/4" CrimpRing™ End Manifold

- 1" Diameter manifold trunks are closed at one end and have a 3/4" brass CrimpRing™ fitting at the supply end
- 1/2" Brass CrimpRing™ fittings, with or without 1/4-turn brass mini ball valves (MBV)
- Branches are 2" O.C.
- Manifolds are sold individually
- Order one for hot and one for cold

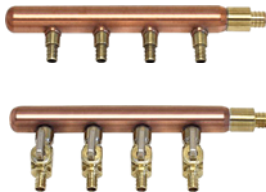

Part #	Mfg#	Description	Price
076690	0650437	4 Port - 3/4" CF	
076691	0650438	6 Port - 3/4" CF	
076692	0650439	8 Port - 3/4" CF	
076694	0650441	12 Port - 1/2" CF	

PEX Manifold Bracket



Part #	Mfg#	Description	Price
075788	0650911	2-Pack	

PEX Lead Free Straight/Angle Stops

1/4-Turn Chrome Stop Valve



WPSS-1PB

WPAS-2PB

Part #	Mfg#	Description	Price
158178	0121142	1/2" CF x 3/8" OD Straight	
158642	0121141	1/2" CF x 3/8" OD Angle	

Ball Valves

Full Port Ball Valves

- 600# PSI In-Line Crimp x Crimp
- Lead Free



Part #	Mfg#	Description	Price
158445	0653000	1/2" PEX	
158433	0653001	3/4" PEX	
158446	0653002	1" PEX	

Brass PEX Fittings

CrimpRing™ x Threaded Adapter



WP12B

WP13B

Part #	Mfg#	Size	Price
075755	0653023	3/8" CF x 1/2" MPT	
075608	0653024	1/2" CF x 1/2" MPT	
075609	0653025	1/2" CF x 3/4" MPT	
075610	0653026	3/4" CF x 1/2" MPT	
085989	0653027	3/4" CF x 3/4" MPT	
081708	0653028	3/4" CF x 1" MPT	
084978	0653029	1" CF x 3/4" MPT	
084980	0653030	1" CF x 1" MPT	
169767	0653031	1-1/4" CF x 1" MPT	
075611	0653032	1/2" CF x 1/2" FIP	
110680	0653155	1/2" CF x 3/4" FIP	
075612	0653033	3/4" CF x 3/4" FIP	
169771	0653161	1-1/4" CF x 1-1/4"C	
101029	0653162	1" CF x 1" FIP	

Pipe Fittings

Watts-PEX Fittings

CrimpRing™ Sweat Adapter



Part #	Mfg#	Size	Price
075754	0653005	1/2" M SWT x 3/8" CF	
075587	0653006	1/2" M SWT x 1/2" CF	
075605	0653007	3/4" M SWT x 3/4" CF	
079969	0653008	1" M SWT x 1" CF	
169758	0653009	1" M SWT x 1-1/4" CR	
169759	0653151	1-1/4" M SWTx1-1/4" CF	
075606	0653010	1/2" F SWT x 1/2" CF	
075607	0653011	3/4" F SWT x 3/4" CF	
077558	0653012	1" F SWT x 1" CF	
169754	0653013	1" FSWT x 1-1/4" CF	
169755	0653159	1-1/4" F SWT x 1-1/4"CF	

Close Ear CinchClamp



Part#	Mfg#	Size	Price
152384	0651815	1/2"	
152387	0651816	3/4"	
152388	0651818	3/4"	

Stainless Steel CinchClamps™

- Perfect for connecting PEX to crimp-style fittings in hard-to-reach spaces
- Pinch tab closed with CinchTool™
- Do not use with wrought copper PEX fittings



Part#	Mfg#	Size	Price
128288	0650542	1/2"	
079229	0650538	1/2"	
128287	0650543	3/4"	
079230	0650539	3/4"	
079231	0650540	1"	

Copper PEX CrimpRing™



Part#	Mfg#	Size	Price
075756	0650545	3/8"	

Brass PEX Fittings (Continued)

Copper PEX CrimpRing™

Part#	Mfg#	Size	Price
075613	0650546	1/2"	
075614	0650547	3/4"	
077557	0650548	1"	
169777	0650549	1-1/4"	
169778	0650798	1-1/2"	

CrimpRing™ Coupling



Part#	Mfg#	Size	Price
075615	0653047	1/2" CF x 1/2" CF	
161107	0653046	1/2" CF x 3/8" CF	
081709	0653048	3/4" CF x 1/2" CF	
075616	0653049	3/4" CF x 3/4" CF	
084977	0653050	1" CF x 3/4" CF	
077556	0653051	1" CF x 1" CF	
169747	0653052	1-1/4"CF x 1-1/4"CF	

CrimpRing™ Tee



Part #	Mfg#	Size	Price
075617	0653072	1/2" x 1/2" x 1/2"	
075618	0653073	1/2" x 1/2" x 3/4"	
075622	0653078	3/4" x 3/4" x 3/4"	
075619	0653074	3/4" x 1/2" x 1/2"	
075620	0653075	3/4" x 1/2" x 3/4"	
075621	0653077	3/4" x 3/4" x 1/2"	
084979	0653080	1" x 3/4" x 3/4"	
077553	0653081	1" x 1" x 1/2"	
077554	0653082	1" x 1" x 3/4"	
077555	0653083	1" x 1" x 1"	
169735	0653156	1-1/4" x 1-1/4" x 1"	
169737	0653157	1-1/4" x 1-1/4" x 1-1/4"	

Pipe Fittings

Watts-PEX Fittings

CrimpRing™ Elbow - Crimp x Crimp



Part#	Mfg#	Size	Price
075759	0653100	3/8" x 3/8"	
075623	0653101	1/2" x 1/2"	
100581	0653102	3/4" x 1/2"	
075624	0653103	3/4" x 3/4"	
081151	0653104	1" x 1"	
169743	0653158	1-1/4"	

CrimpRing™ Elbow - Crimp x MIP



Part#	Mfg#	Size	Price
100585	0653111	1/2" CF x 1/2" MIP	

Drop Ear Elbow



Part#	Mfg#	Size	Price
075789	0653122	3/8" CF x 1/2" FIP	
104527	0653126	3/4" CF x 3/4" FIP	
075790	0653124	1/2" CF x 1/2" FIP	

CrimpRing™ Test Plug



Part#	Mfg#	Size	Price
075625	0653133	1/2" CF	
075626	0653134	3/4" CF	
084981	0653135	1" CF	

Poly-Alloy Fittings

Poly-Alloy CrimpRing™ x MIP Adapter



Part #	Mfg#	Size	Price
137432	0650673	1/2" CF x 1/2" MIP	
137433	0650675	3/4" CF x 3/4" MIP	

Poly-Alloy CrimpRing™ Coupling



Part #	Mfg#	Size	Price
128207	0650655	1/2" CF x 1/2" CF	
122547	0650661	3/4" CF x 1/2" CF	
128209	0650657	3/4" CF x 3/4" CF	
137430	0650663	1" CF x 3/4" CF	
137429	81004319	1" CF x 1" CF	

Poly-Alloy CrimpRing™ Elbow



Part #	Mfg#	Size	Price
128212	0650665	1/2" CF x 1/2" CF	
128213	0650667	3/4" CF x 3/4" CF	
137428	0650668	1" CF x 1" CF	

Poly-Alloy CrimpRing™ Tee



Part #	Mfg#	Size	Price
128214	0650685	1/2" x 1/2" x 1/2"	
137435	0650686	1/2" x 1/2" x 3/4"	
122682	0650690	3/4" x 1/2" x 1/2"	
128218	0650690	3/4" x 1/2" x 1/2"	Bag of 10
122681	0650689	3/4" x 1/2" x 3/4"	
128217	0650689	3/4" x 1/2" x 3/4"	Bag of 10
122683	0650688	3/4" x 3/4" x 1/2"	

Watts-PEX Fittings

Poly-Alloy Fittings (Continued)

Poly-Alloy CrimpRing™ Tee

Part #	Mfg#	Size	Price
128216	0650688	3/4" x 3/4" x 1/2" Bag of 10	
128215	0650687	3/4" x 3/4" x 3/4"	
137436	0650691	3/4" x 3/4" x 1"	
137438	0650693	1" x 3/4" x 3/4"	
137437	0650692	1" x 1" x 1/2"	
137439	0650694	1" x 1" x 3/4"	
137434	0650695	1" x 1" x 1"	

Poly Alloy Angle Swivel Coupling



Part #	Mfg#	Size	Price
130466	0650810	1/2" CF x 1/2" FIP	

Poly Alloy Test Plug



Part #	Mfg#	Size	Price
128586	650818	1/2" CF	
128587	0650819	3/4" CF	
085994	0650820	1" CF	

Fasteners

Stub-Out Elbow - Copper



Part #	Mfg#	Size	Price
075628	0650833	1/2" x 8"	
082944	0650837	1/2"CF x 1/2"Nom 8" Eared Strap	

SnapClip™ for WaterPEX® Tubing

- Can be used with or without ClipRails™
- Can be interlocked for a very tight arrangement
- Anchor them with a single screw through base (screws not included)



Part #	Mfg#	Description	Price
101851	0650913	1/2" 100	
101853	0650914	3/4" 100	

Supply Lines & Fittings

Washing Machine Valve & Box

- Comes complete with two individual 1/4-turn brass valves and white protective enclosure with faceplate
- Valves are fitted for standard washing machine hose and 1/2" WaterPEX® CrimpRing™ fittings
- Design allows for left, center or right valve and waste mounting
- 6-1/2" x 7-5/8" x 3" Enclosure
- Comes complete with brackets for nailing to house framing
- Hoses sold separately



Part #	Mfg#	Description	Price
075634	0650923	Valve And Enclosure	

Ice Maker Valve & Box

- Comes complete with one 1/4-turn brass valve and white protective enclosure with faceplate
- Valves are fitted for standard 1/4" compression ice maker and 1/2" WaterPEX® CrimpRing™ fitting
- The 5-3/16" x 5-3/16" x 2-1/2" enclosure nails directly to house framing



Part #	Mfg#	Description	Price
157731	0653144	Valve and Enclosure	
156549	0653145	Valve Only	

Watts-PEX Fittings

A2C IntelliFlow Automatic Washing Machine Water Shutoff Valve

- Easy installation
- Silent reliable operation
- Replaceable internal strainer screen



Part #	Mfg#	Description	Price
020946	0004646	Valve and Enclosure	
020945	0004640	Valve Only	

Tools

CinchClamp™ Tool



Part #	Mfg#	Description	Price
079232	0651060	Tool w/Holster & Gauge	
109528	0651059	Ratcheting, 1/2" - 1"	

CrimpMaster™ Crimp Tool

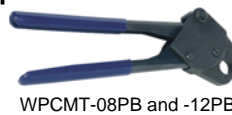

Part #	Mfg#	Size	Price
075631	0650888	1/2"	
075632	0650889	3/4"	

CrimpRing™ Removal Tool



Part #	Mfg#	Description	Price
101723	0651016	Crimp Ring Remover	

Pipe Fittings

Watts-PEX Fittings

PEX Fittings Copper Coupling

- Tube stops formed into each fitting
- 1-Piece solid copper



Part #	Mfg #	PEX x PEX	Price
099284	645X12PK2	3/8" x 1/2"	

PowerPEX®— ASTM F1807

PowerPEX® F1807 Brass Straight Adapter

Part #	Mfg #	PEX x MSwt	Price
141348	643XB2	1/2" x 1/2"	

PowerPEX® F1807 No Lead Copper Elbow Adapter

- Tube stops formed into each fitting
- Longer radius bend for increased flow characteristics

Part #	Mfg #	PEX x PEX	Price
089534	642X2	1/2" x 1/2"	

PowerPEX® F1807 No Lead Faucet Straight Adapter

- Easily connects PEX to faucet thread
- Copper component is available individually **637X10**
- High impact FIP swivel nut includes nose cone gasket



Part #	Mfg #	PEX x FIP Swivel	Price
183733	637X10	3/8" x 1/2"	
183734	637X20	1/2" x 1/2"	

PowerPEX® F1807 Ballcock Straight Adapter

- No lead
- Easily connects PEX to ballcock thread
- Ballcock swivel nut includes nose cone gasket

Part #	Mfg #	PEX x Swivel Ballcock	Price
183735	637X420	1/2"	

PowerPEX® F1807 Ballcock Elbow Adapter

- No lead
- Easily connects PEX to ballcock thread
- Swivel ballcock nut includes nose cone gasket
- Long radius elbow fitting for smoother flow

Part #	Mfg #	PEX x Swivel Ballcock	Price
183738	637X423PK	1/2"	

PowerPEX® F1807 Tub/Shower Elbow Adapter (Drop-Ear Model)

- Lead-free solder joint
- Internal 1/2" FIP thread for shower arm or tub nipple
- For use on shower risers, tub spouts and non-pressure fitting applications

Part #	Mfg #	F1807 PEX x FIP	Price
183764	647X23E	3/4" x 1/2"	
165006	642XG23	3/4" x 1/2", No Lead	

PowerPEX® F1807 Brass Elbow



Part #	Mfg #	PEX x PEX	Price
146099	642XB2	1/2" x 1/2"	
145167	642XB3	3/4" x 1/2"	

PowerPEX® BranchMaster™ F1807 Valved Manifold

- 1/2" F1807 PEX ball valve branches
- 1" Female sweat x spin closed trunk
- 1" Type L copper trunk
- Branches are 2" on-center
- Valved branches are perfect for centrally located water supply manifolds

Part #	Mfg #	Branches	Inlet	Price
183790	672XV0810	8	Right Inlet	
183791	672XV0810L	8	Left Inlet	
183792	672XV1010L	10	Left Inlet	
183793	672XV1810L	18	Left Inlet	

PowerPEX® BranchMaster™ F1807 Male Manifold

- 1/2" F1807 PEX branches
- 1" Male sweat x spin closed trunk
- 1" Type L copper trunk can be easily converted to most any connection
- Branches are 2" on-center
- 1" Male sweat inlet is press-fitting compatible
- No lead



Part #	Mfg #	Branches	Price
183782	672X0640	6	
183789	672X1240	12	

Watts-PEX Fittings

PowerPEX®—ASTM F1960

PowerPEX® F1960 Male Swt Brass Straight Adapter

- Male sweat x PEX
- Full flow—no restriction
- One-piece no lead brass

Part #	Mfg #	F1960 PEX x MSwt	Price
227461	643WG32	1/2" x 3/4"	

F2159 AccuCrimp™ Fittings

PowerPEX® AccuCrimp™ F2159 Tee—Lead Free (Branch x Branch x Tee)

- Wide selection of tee configurations
- Tabs perfectly position crimp ring or sleeve over sealing barbs every time



641xP222

Part #	Mfg #	Branch x Branch x Tee	Price
226722	641xP222	1/2" x 1/2" x 1/2"	
226724	641xP333	3/4" x 3/4" x 3/4"	
226726	641xP442	1" x 1" x 1/2"	
226728	641xP443	1" x 1" x 3/4"	
226725	641XP444	1" x 1" x 1"	

PowerPEX® F2159 AccuCrimp™ Elbow Directional

- No lead
- Tabs perfectly position crimping or sleeve over sealing barbs every time
- Use elbows when a tight radius 90° turn is needed

642XP2



Part #	Mfg #	PEX x PEX	Price
226718	642XP2	1/2" x 1/2"	
183742	642XP4	1" x 1"	

PowerPEX® AccuCrimp™ F2159 Coupling

- Tabs perfectly position crimp ring or sleeve over-sealing barbs every time
- No lead

Part #	Mfg #	AccuCrimp	Price
226721	645XP32	3/4" x 1/2"	
183760	645XP43	1" x 3/4"	

Pipe Fittings

Watts Quick Connect Fittings

KwikStop Stop Valves

KwikStop Angle 1/4-Turn Water Supply Stop

- Quick-connect technology
- For use on copper, CPVC or PEX
- NSF, UPC and CSA Approved



Part #	Mfg #	Model	Size	Price
123687	0145728	QC894A	1/2" x 3/8"	

KwikStop Straight 1/4-Turn Water Supply Stop

- Quick-connect technology
- For use on copper, CPVC or PEX
- NSF, UPC and CSA Approved



Part #	Mfg #	Model	Size	Price
123688	0145729	QC894S	1/2" x 3/8"	

Quick - Connect Polysulfone Fittings

Valve Tee

- Poly sulfone



Part #	Mfg #	Model	Size	Price
172087	0651188	LF3550B	1/2" CTS x 1/4" OD	

End Stop

- Polysulfone
- Lead-free



Part #	Mfg #	Model	Size	Price
052039	0666109	1045B04	1/4" OD	

Pipe Fittings

Weld Fittings

Standard Weight Weld Fittings

90° Long Radius Elbow

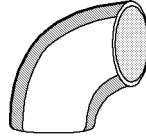

Part #	Size	Price
013214	1/2"	
014779	3/4"	
012293	1"	
012877	1-1/4"	
012554	1-1/2"	
013944	2"	
014120	2-1/2"	
014456	3"	
015344	4"	
015695	6"	
015832	8"	

45° Long Radius Elbow

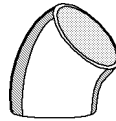

Part #	Size	Price
012556	1-1/2"	
013943	2"	
014119	2-1/2"	
014455	3"	
015343	4"	
015529	5"	
015694	6"	
015831	8"	

Tee

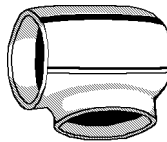

Part #	Size	Price
014780	3/4"	
012294	1"	
012878	1-1/4"	
012555	1-1/2"	
013948	2"	
014123	2-1/2"	
014460	3"	
015348	4"	
015698	6"	
015835	8"	

Standard Weight Weld Fittings (Continued)

Tee

Part #	Size	Price
029629	10"	

Reducing Tee

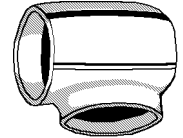

Part #	Size	Price
024273	2-1/2" x 2-1/2" x 1"	
020177	2-1/2" x 2-1/2" x 2"	
014550	3" x 3" x 2"	
032915	4" x 4" x 2-1/2"	
015463	4" x 4" x 3"	
029624	5" x 5" x 3"	
029625	6" x 6" x 3"	
015739	6" x 6" x 4"	
029626	6" x 6" x 5"	
029628	8" x 8" x 6"	

Concentric Reducer

Part #	Size	Price
020178	1-1/2" x 3/4"	
012576	1-1/2" x 1"	
013971	2" x 1"	
014047	2" x 1-1/4"	
014011	2" x 1-1/2"	
029612	2-1/2" x 1-1/4"	
014137	2-1/2" x 1-1/2"	
014159	2-1/2" x 2"	
014496	3" x 1-1/2"	
014548	3" x 2"	
014561	3" x 2-1/2"	
015368	4" x 1-1/2"	
015410	4" x 2"	
015417	4" x 2-1/2"	
015461	4" x 3"	
015549	5" x 4"	
015737	6" x 4"	
015744	6" x 5"	
029621	8" x 4"	

Eccentric Reducer

Part #	Size	Price
012642	1-1/2" x 1-1/4"	

Weld Fittings

Standard Weight Weld Fittings (Continued)

Eccentric Reducer

Part #	Size	Price
014012	2" x 1-1/2"	
014143	2-1/2" x 1-1/4"	
014138	2-1/2" x 1-1/2"	
014160	2-1/2" x 2"	
014497	3" x 1-1/2"	
014549	3" x 2"	
014562	3" x 2-1/2"	
015411	4" x 2"	
015418	4" x 2-1/2"	
015462	4" x 3"	

Cap

Part #	Size	Price
012876	1-1/4"	
012553	1-1/2"	
013942	2"	
014118	2-1/2"	
014454	3"	
015342	4"	
015830	8"	

#150 Raised Face Flanges

Slip-On

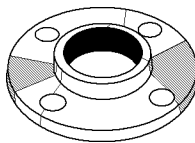

Part #	Size	Price
013946	2"	
014122	2-1/2"	
014459	3"	
015346	4"	
015531	5"	
015697	6"	
015833	8"	
018778	10"	

Blind

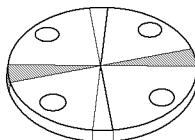

Part #	Size	Price
028206	2-1/2"	
014453	3"	

#150 Raised Face Flanges (Continued)

Blind

Part #	Size	Price
015341	4"	
020187	5"	
015692	6"	
029622	8"	

Weldneck

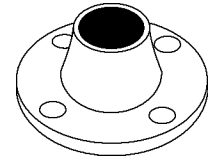

Part #	Size	Price
013945	2"	
014121	2-1/2"	
014457	3"	
015345	4"	
015696	6"	
012319	10"	

Weld Fittings

Forged Steel O-Lets

Class 3000 Forged Steel Thread-O-Let

Part #	Outlet Size	Nom Run Pipe Size	Price
070470	1/2"	1/2"	
055925	3/4"	3/4"	
055927	1"	1"	
055940	1-1/4"	1-1/4"	
055945	1-1/2"	1-1/2"	
055944	1-1/2"	4 - 3-1/2"	
055951	2"	2"	

304SS/316SS 150# Fittings

304 Stainless Steel Fittings

Hex Bushing

- 150# Cast
- 304 Stainless Steel



Part #	Size	Price
175802	1/4" x 1/8"	
167977	3/8" x 1/8"	
175803	3/8" x 1/4"	
159639	3/4" x 1/4"	
167976	3/4" x 3/8"	
063710	3/4" x 1/2"	
175804	1/2" x 1/8"	
065093	1/2" x 1/4"	
069936	1/2" x 3/8"	
131104	1" x 1/2"	
175805	1" x 3/4"	
175806	1-1/4" x 3/4"	
175807	1-1/4" x 1/2"	
065094	1-1/4" x 1"	
175810	1-1/2" x 1/2"	
175809	1-1/2" x 3/4"	
175808	1-1/2" x 1"	
065097	1-1/2" x 1-1/4"	
175814	2" x 1/2"	
175813	2" x 3/4"	
175812	2" x 1"	
175811	2" x 1-1/4"	
065098	2" x 1-1/2"	

Cap

- 150# Cast
- 304 Stainless Steel



Part #	Size	Price
175818	1/8"	
065054	1/4"	
069934	3/8"	
065055	1/2"	
065056	3/4"	
065057	1"	
065058	1-1/4"	
065059	1-1/2"	
065060	2"	

Coupling

- 150# Cast
- 304 Stainless Steel



Part #	Size	Price
175753	1/8"	
065009	1/4"	
069928	3/8"	
065010	1/2"	
065012	3/4"	
065013	1"	
065014	1-1/4"	
065015	1-1/2"	
065016	2"	

Half Coupling

- 150# Cast
- 304 Stainless Steel



Part #	Size	Price
175755	1/8"	
175756	1/4"	
175757	3/8"	
175758	1/2"	
175759	3/4"	
175760	1"	
175761	1-1/4"	
175762	1-1/2"	
175763	2"	

Reducing Coupling

- 150# Cast
- 304 Stainless Steel



Part #	Size	Price
175770	1/4" x 1/8"	
175771	3/8" x 1/8"	
175772	3/8" x 1/4"	
175773	1/2" x 1/8"	
065087	1/2" x 1/4"	
069935	1/2" x 3/8"	
175774	3/4" x 1/8"	
175775	3/4" x 1/4"	

304 Stainless Steel Fittings (Continued)

Reducing Coupling

Part #	Size	Price
131106	3/4" x 3/8"	
065088	3/4" x 1/2"	
175779	1" x 1/4"	
175776	1" x 1/2"	
175778	1" x 3/8"	
065089	1" x 3/4"	
175781	1-1/4" x 1/2"	
175780	1-1/4" x 3/4"	
158281	1-1/4" x 1"	
175785	1-1/2" x 1/2"	
175784	1-1/2" x 3/4"	
175783	1-1/2" x 1"	
175782	1-1/2" x 1-1/4"	
175789	2" x 1/2"	
175788	2" x 3/4"	
175787	2" x 1"	
175786	2" x 1-1/4"	
065092	2" x 1-1/2"	

90° Elbow

- 150# Cast
- 304 Stainless Steel



Part #	Size	Price
175670	1/8"	
065032	1/4"	
167978	3/8"	
175671	1/2"	
065034	3/4"	
065035	1"	
065036	1-1/4"	
065037	1-1/2"	
076086	2"	

45° Elbow

- 150# Cast
- 304 Stainless Steel



Part #	Size	Price
175714	1/8"	

Pipe Fittings

304SS/316SS 150# Fittings

304 Stainless Steel Fittings (Continued)

45° Elbow

Part #	Size	Price
065048	1/4"	
069933	3/8"	
131535	1/2"	
065050	3/4"	
065051	1"	
065052	1-1/4"	
065053	1-1/2"	
175715	2"	

90° Street Elbow

- 150# Cast
- 304 Stainless Steel



Part #	Size	Price
175672	1/8"	
175685	1/4"	
175686	3/8"	
065042	1/2"	
065043	3/4"	
175687	1"	
175688	1-1/4"	
065046	1-1/2"	
065047	2"	

Square Head Plug

- 150# Cast
- 304 Stainless Steel



Part #	Size	Price
175815	1/8"	
175816	1/4"	
150708	3/8"	
066403	1/2"	
066404	3/4"	
066405	1"	
175817	1-1/4"	
066407	1-1/2"	
066408	2"	

Tee

- 150# Cast
- 304 Stainless steel



Part #	Size	Price
175722	1/8"	
065025	1/4"	
069930	3/8"	
065026	1/2"	
065027	3/4"	
065029	1"	
175723	1-1/4"	
175724	1-1/2"	
175725	2"	

Union

- 150# Cast
- 304 Stainless Steel



Part #	Size	Price
175735	1/8"	
065018	1/4"	
069929	3/8"	
065019	1/2"	
065020	3/4"	
065021	1"	
175736	1-1/4"	
065023	1-1/2"	
065024	2"	

Cross

- 150# Cast
- 304 Stainless Steel



Part #	Size	Price
175727	1/4"	
175728	3/8"	
175729	1/2"	
175730	3/4"	
175731	1"	
175732	1-1/4"	
175733	1-1/2"	
175734	2"	

316 Stainless Steel Fittings

Hex Bushing

- 150# Cast
- 316 Stainless Steel



Part #	Size	Price
162859	3/8" x 1/4"	
162860	1/2" x 1/4"	
162861	1/2" x 3/8"	
162862	3/4" x 1/4"	
162863	3/4" x 3/8"	
162864	3/4" x 1/2"	
162865	1" x 1/4"	
162866	1" x 3/8"	
162867	1" x 1/2"	
162868	1" x 3/4"	
162869	1-1/4" x 1/4"	
162870	1-1/4" x 3/8"	
162871	1-1/4" x 1/2"	
162872	1-1/4" x 3/4"	
162873	1-1/4" x 1"	
162874	1-1/2" x 1/4"	
162875	1-1/2" x 3/8"	
162876	1-1/2" x 1/2"	
162877	1-1/2" x 3/4"	
162878	1-1/2" x 1"	
162879	1-1/2" x 1-1/4"	
162880	2" x 1/4"	
162881	2" x 3/8"	
162882	2" x 1/2"	
162883	2" x 3/4"	
162884	2" x 1"	
162885	2" x 1-1/4"	
162886	2" x 1-1/2"	

Coupling

- 150# Cast
- 316 Stainless Steel



Part #	Size	Price
167585	1/8"	
097937	1/4"	
162790	3/8"	
097938	1/2"	
162791	3/4"	

304SS/316SS 150# Fittings

316 Stainless Steel Fittings (Continued)

Coupling

Part #	Size	Price
162792	1"	
162793	1-1/4"	
162794	1-1/2"	
162795	2"	

Half Coupling

- 150# Cast
- 316 Stainless Steel



Part #	Size	Price
167590	1/8"	
162888	1/4"	
162889	3/8"	
162890	1/2"	
162891	3/4"	
076079	1"	
162892	1-1/4"	
162893	1-1/2"	
162894	2"	

Reducing Coupling

- 150# Cast
- 316 Stainless Steel



Part #	Size	Price
164695	3/4" x 1/2"	
164696	1" x 3/4"	
164697	1-1/4" x 1"	
165609	1" x 1/2"	
173405	2" x 1-1/2"	
173406	1-1/2" x 1"	
173408	1-1/2" x 1-1/4"	
173409	2" x 1-1/4"	
173410	2" x 1"	

Cap

- 150# Cast
- 316 Stainless Steel



Part #	Size	Price
162805	1/4"	
162806	3/8"	
162807	1/2"	
162808	3/4"	
162809	1"	
162810	1-1/4"	
162811	1-1/2"	
162812	2"	

90° Elbow

- 150# Cast
- 316 Stainless Steel



Part #	Size	Price
167584	1/8"	
097929	1/4"	
162797	3/8"	
027174	1/2"	
162798	3/4"	
162799	1"	
162800	1-1/4"	
162801	1-1/2"	
162802	2"	

45° Elbow

- 150# Cast
- 316 Stainless Steel



Part #	Size	Price
097930	1/4"	
162853	3/8"	
097932	1/2"	
162854	3/4"	
162855	1"	
162856	1-1/4"	
162857	1-1/2"	
162858	2"	

90° Street Elbow

- 150# Cast
- 316 Stainless Steel



Part #	Size	Price
167586	1/8"	
167591	1/4"	
069932	3/8"	
164698	1/2"	
164699	3/4"	
166559	1"	
167857	1-1/4"	
167876	1-1/2"	
167877	2"	

Square Head Plug

- 150# Cast
- 316 Stainless Steel



Part #	Size	Price
167588	1/8"	
162895	1/4"	
162896	3/8"	
162897	1/2"	
162898	3/4"	
162899	1"	
162900	1-1/4"	
162901	1-1/2"	
162902	2"	

Tee

- 150# Cast
- 316 Stainless Steel



Part #	Size	Price
167587	1/8"	
162903	1/4"	
162904	3/8"	
162905	1/2"	
162906	3/4"	
162907	1"	
162908	1-1/4"	
162909	1-1/2"	
162910	2"	

304SS/316SS 150# Fittings

Union

- 150# Cast
- 316 Stainless Steel



Part #	Size	Price
162912	1/4"	
162913	3/8"	
162914	1/2"	
162915	3/4"	
162916	1"	
162917	1-1/4"	
162918	1-1/2"	
162919	2"	

304/316 Stainless Steel 150# Nipples

304 Stainless Steel Nipples

Schedule 40 Welded Nipple

- 304/304L SS



1/8" Diameter

Part #	Size	Price
175637	1/8" x CL	
175638	1/8" x 1-1/2"	
175639	1/8" x 2"	
175640	1/8" x 2-1/2"	
175641	1/8" x 3"	
175642	1/8" x 3-1/2"	
175643	1/8" x 4"	
175644	1/8" x 4-1/2"	
175645	1/8" x 5"	
175646	1/8" x 5-1/2"	
175647	1/8" x 6"	

1/4" Diameter

Part #	Size	Price
164567	1/4" x CL	
164568	1/4" x 1-1/2"	
065108	1/4" x 2"	
164570	1/4" x 2-1/2"	
164571	1/4" x 3"	
164573	1/4" x 3-1/2"	
164574	1/4" x 4"	
164575	1/4" x 4-1/2"	
164576	1/4" x 5"	
164577	1/4" x 5-1/2"	
065112	1/4" x 6"	

3/8" Diameter

Part #	Size	Price
069938	3/8" x CL	
164580	3/8" X 1-1/2"	
069939	3/8" x 2"	
164581	3/8" X 2-1/2"	
069940	3/8" x 3"	
164582	3/8" X 3-1/2"	
069941	3/8" x 4"	
164583	3/8" X 4-1/2"	
069942	3/8" x 5"	
164584	3/8" X 5-1/2"	
069943	3/8" x 6"	

1/2" Diameter

Part #	Size	Price
065114	1/2" x CL	
065115	1/2" x 2"	
144748	1/2" x 2-1/2"	
065116	1/2" x 3"	
144749	1/2" x 3-1/2"	
065117	1/2" x 4"	
164585	1/2" x 4-1/2"	
065118	1/2" x 5"	
164586	1/2" x 5-1/2"	
131533	1/2" x 6"	

3/4" Diameter

Part #	Size	Price
065126	3/4" x CL	
164587	3/4" x 1-1/2"	
065127	3/4" x 2"	
163616	3/4" x 2-1/2"	
065128	3/4" x 3"	
164588	3/4" x 3-1/2"	
065129	3/4" x 4"	
164589	3/4" x 4-1/2"	
164590	3/4" x 5"	
164591	3/4" x 5-1/2"	
065131	3/4" x 6"	

1" Diameter

Part #	Size	Price
065133	1" x CL	
065134	1" x 2"	
175648	1" x 2-1/2"	
065135	1" x 3"	
175649	1" x 3-1/2"	
065136	1" x 4"	
175650	1" x 4-1/2"	
065137	1" x 5"	
175651	1" x 5-1/2"	
065138	1" x 6"	

1-1/4" Diameter

Part #	Size	Price
065140	1-1/4" x CL	
065141	1-1/4" x 2"	
175652	1-1/4" x 2-1/2"	
065142	1-1/4" x 3"	

304 Stainless Steel Nipples (Continued)

Schedule 40 Welded Nipple

1-1/4" Diameter

Part #	Size	Price
175653	1-1/4" x 3-1/2"	
065143	1-1/4" x 4"	
175654	1-1/4" x 4-1/2"	
065145	1-1/4" x 5"	
175655	1-1/4" x 5-1/2"	
065146	1-1/4" x 6"	

1-1/2" Diameter

Part #	Size	Price
065148	1-1/2" x CL	
065149	1-1/2" x 2"	
175656	1-1/2" x 2-1/2"	
065150	1-1/2" x 3"	
175658	1-1/2" x 3-1/2"	
065151	1-1/2" x 4"	
175659	1-1/2" x 4-1/2"	
065152	1-1/2" x 5"	
175660	1-1/2" x 5-1/2"	
065153	1-1/2" x 6"	

2" Diameter

Part #	Size	Price
065155	2" x CL	
065157	2" x 2-1/2"	
065158	2" x 3"	
175662	2" x 3-1/2"	
065159	2" x 4"	
175663	2" x 4-1/2"	
065160	2" x 5"	
175664	2" x 5-1/2"	
065194	2" x 6"	

316 Stainless Steel Nipples

Schedule 40 Welded Nipple

- 316\316L SS



1/8" Diameter

Part #	Size	Price
167592	1/8" x CL	

Pipe Fittings

304/316 Stainless Steel 150# Nipples

316 Stainless Steel Nipples (Continued)

Schedule 40 Welded Nipple 1/8" Diameter

Part #	Size	Price
167593	1/8" x 1-1/2"	
167594	1/8" x 2"	
167595	1/8" x 2-1/2"	
167596	1/8" x 3"	
167597	1/8" x 3-1/2"	
167598	1/8" x 4"	
167599	1/8" x 4-1/2"	
167600	1/8" x 5"	
167601	1/8" x 5-1/2"	
167602	1/8" x 6"	

1/4" Diameter

Part #	Size	Price
164593	1/4" x CL	
164594	1/4" x 1-1/2"	
164595	1/4" x 2"	
164596	1/4" x 2-1/2"	
164597	1/4" x 3"	
164598	1/4" x 3-1/2"	
164599	1/4" x 4"	
164600	1/4" x 4-1/2"	
164601	1/4" x 5"	
164602	1/4" x 5-1/2"	
164603	1/4" x 6"	

3/8" Diameter

Part #	Size	Price
164604	3/8" x CL	
164605	3/8" x 1-1/2"	
164606	3/8" x 2"	
164607	3/8" x 2-1/2"	
164608	3/8" x 3"	
164609	3/8" x 3-1/2"	
164611	3/8" x 4"	
164612	3/8" x 4-1/2"	
164613	3/8" x 5"	
164615	3/8" x 5-1/2"	
164616	3/8" x 6"	

1/2" Diameter

Part #	Size	Price
164618	1/2" x CL	
164619	1/2" x 1-1/2"	
164620	1/2" x 2"	
164621	1/2" x 2-1/2"	
164622	1/2" x 3"	
164623	1/2" x 3-1/2"	
164624	1/2" x 4"	
164625	1/2" x 4-1/2"	
164626	1/2" x 5"	
164627	1/2" x 5-1/2"	
163478	1/2" x 6"	

3/4" Diameter

Part #	Size	Price
164629	3/4" x CL	
164630	3/4" x 1-1/2"	
164631	3/4" x 2"	
164632	3/4" x 2-1/2"	
163936	3/4" x 3"	
164633	3/4" x 3-1/2"	
164634	3/4" x 4"	
164635	3/4" x 4-1/2"	
164636	3/4" x 5"	
164637	3/4" x 5-1/2"	
164638	3/4" x 6"	

1" Diameter

Part #	Size	Price
164644	1" x CL	
164645	1" x 2"	
164647	1" x 2-1/2"	
164648	1" x 3"	
164649	1" x 3-1/2"	
164650	1" x 4"	
164651	1" x 4-1/2"	
164652	1" x 5"	
164653	1" x 5-1/2"	
164654	1" x 6"	

1-1/4" Diameter

Part #	Size	Price
164655	1-1/4" x CL	
164656	1-1/4" x 2"	
164657	1-1/4" x 2-1/2"	

316 Stainless Steel Nipples (Continued)

Schedule 40 Welded Nipple 1-1/4" Diameter

Part #	Size	Price
164658	1-1/4" x 3"	
164659	1-1/4" x 3-1/2"	
164660	1-1/4" x 4"	
164661	1-1/4" x 4-1/2"	
164662	1-1/4" x 5"	
164663	1-1/4" x 5-1/2"	
164664	1-1/4" x 6"	

1-1/2" Diameter

Part #	Size	Price
163935	1-1/2" x CL	
163934	1-1/2" x 2"	
163933	1-1/2" x 2-1/2"	
163932	1-1/2" x 3"	
163931	1-1/2" x 3-1/2"	
163929	1-1/2" x 4"	
163928	1-1/2" x 4-1/2"	
163926	1-1/2" x 5"	
163925	1-1/2" x 5-1/2"	
163924	1-1/2" x 6"	

2" Diameter

Part #	Size	Price
164665	2" x CL	
164666	2" x 2-1/2"	
164667	2" x 3"	
164668	2" x 3-1/2"	
164669	2" x 4"	
164670	2" x 4-1/2"	
164671	2" x 5"	
164672	2" x 5-1/2"	
163037	2" x 6"	

Hex Nipple



Part #	Size	Price
165479	1/4"	
165480	3/8"	

Pipe Fittings

304/316 Stainless Steel 150# Nipples

316 Stainless Steel Nipples (Continued)

Hex Nipple

Part #	Size	Price
165481	1/2"	
165482	3/4"	
165483	1"	

King Nipples



Part #	Size	Price
167546	1/2"	
164547	3/4"	
167548	1"	
164549	1-1/4"	
164550	1-1/2"	
167551	2"	

Socket Weld 304SS/316SS/L 3000# FTGS

3000# 304 Stainless Steel

Full Coupling

- 3000# Forged socket weld
- 304 Stainless steel



Part #	Size	Price
181779	1/2"	
181780	3/4"	
181781	1"	
181782	1-1/4"	
181783	1-1/2"	
181784	2"	

90° Elbow

- 3000# Forged socket weld
- 304 Stainless steel



Part #	Size	Price
181761	1/2"	
181762	3/4"	
181763	1"	
181764	1-1/4"	
181765	1-1/2"	
181766	2"	

45° Elbow

- 3000# Forged socket weld
- 304 Stainless steel



Part #	Size	Price
181767	1/2"	
181768	3/4"	
181769	1"	
181770	1-1/4"	
181771	1-1/2"	
181772	2"	

Cap

- 3000# Forged socket weld
- 304 Stainless steel



Part #	Size	Price
181785	1/2"	
181786	3/4"	
181787	1"	
181788	1-1/4"	
181789	1-1/2"	
181790	2"	

Tee

- 3000# Forged socket weld
- 304 Stainless steel



Part #	Size	Price
181773	1/2"	
181774	3/4"	
181775	1"	
181776	1-1/4"	
181777	1-1/2"	
181778	2"	

Union

- 3000# Forged socket weld
- 304 Stainless steel



Part #	Size	Price
181791	1/2"	
181792	3/4"	
181793	1"	
181794	1-1/4"	
181795	1-1/2"	
181796	2"	

3000# 316/L Stainless Steel

Insert

- 3000# Forged socket weld
- 316/L Stainless steel



Part #	Size	Price
162990	3/4" x 1/2"	
162991	1" x 1/2"	
162992	1" x 3/4"	

3000# 316/L Stainless Steel (Continued)

Insert

Part #	Size	Price
162993	1-1/2" x 1/2"	
162994	1-1/2" x 3/4"	
162995	1-1/2" x 1"	
162996	2" x 1/2"	
162997	2" x 3/4"	
162998	2" x 1"	
162999	2" x 1-1/2"	

Full Coupling

- 3000# Forged socket weld
- 316/L Stainless steel



Part #	Size	Price
162961	1/2"	
162962	3/4"	
162963	1"	
162964	1-1/4"	
162965	1-1/2"	
162966	2"	

Half Coupling

- 3000# Forged socket weld
- 316/L Stainless steel



Part #	Size	Price
162980	1/2"	
162981	3/4"	
162982	1"	
162983	1-1/4"	
162984	1-1/2"	
162985	2"	

Reducing Coupling

- 3000# Forged socket weld
- 316/L Stainless steel



Part #	Size	Price
163000	3/4" x 1/2"	
163001	1" x 1/2"	
163002	1" x 3/4"	
163003	1-1/2" x 1/2"	

Socket Weld 304SS/316SS/L 3000# FTGS

3000# 316/L Stainless Steel (Continued) Reducing Coupling

Part #	Size	Price
163004	1-1/2" x 3/4"	
163005	2" x 1-1/4"	
163006	2" x 1-1/2"	

90° Elbow

- 3000# Forged socket weld
- 316/L Stainless steel



Part #	Size	Price
162967	1/2"	
162968	3/4"	
162970	1"	
162971	1-1/4"	
162972	1-1/2"	
162973	2"	

45° Elbow

- 3000# Forged socket weld
- 316/L Stainless steel



Part #	Size	Price
162974	1/2"	
162975	3/4"	
162976	1"	
162977	1-1/4"	
162978	1-1/2"	
162979	2"	

Cap

- 3000# Forged socket weld
- 316/L Stainless steel



Part #	Size	Price
162953	1/2"	
162954	3/4"	
162956	1"	
162957	1-1/4"	
162959	1-1/2"	
162960	2"	

Tee

- 3000# Forged socket weld
- 316/L Stainless steel



Part #	Size	Price
163007	1/2"	
163008	3/4"	
163009	1"	
163010	1-1/4"	
163011	1-1/2"	
163012	2"	

Union

- 3000# Forged socket weld
- 316/L Stainless steel



Part #	Size	Price
163015	1/2"	
163016	3/4"	
163017	1"	
163018	1-1/4"	
163019	1-1/2"	
163020	2"	

Forged Carbon Steel Fittings

2000# Carbon Steel Fittings

90° Elbow

- 2000# Forged carbon steel
- Threaded



Part #	Size	Price
046813	1/2"	
047472	3/4"	
163363	1"	
175479	1-1/4"	
175480	1-1/2"	
175481	2"	

45° Elbow

- 2000# Forged carbon steel
- Threaded



Part #	Size	Price
048848	1/2"	
014695	3/4"	
175482	1"	
175483	1-1/4"	
175484	1-1/2"	
175485	2"	

Tee

- 2000# Forged carbon steel
- Threaded



Part #	Size	Price
046815	1/2"	
047473	3/4"	
099077	1"	
175486	1-1/4"	
175487	1-1/2"	
175488	2"	

Cross

- 2000# Forged carbon steel
- Threaded



Part #	Size	Price
175489	1/2"	
175490	3/4"	
175491	1"	
175492	1-1/4"	
175493	1-1/2"	
175494	2"	

3000# Carbon Steel Fittings

Cap

- 3000# Forged carbon steel
- Threaded



Part #	Size	Price
176845	1/8"	
172314	1/4"	
172315	3/8"	
053499	1/2"	
156470	3/4"	
156471	1"	
149560	1-1/4"	
132774	1-1/2"	
018788	2"	
172316	2-1/2"	
172317	3"	
172318	4"	

Half Coupling

- 3000# Forged carbon steel
- Threaded



Part #	Size	Price
172296	1/8"	
172297	1/4"	
168977	3/8"	
146216	1/2"	
146217	3/4"	

3000# Carbon Steel Fittings (Continued)

Half Coupling

Part #	Size	Price
158810	1"	
158811	1-1/4"	
158812	1-1/2"	
158813	2"	
169842	2-1/2"	
169843	3"	
169844	4"	

Coupling

- 3000# Forged carbon steel
- Threaded



Part #	Size	Price
176843	1/8"	
172294	1/4"	
172295	3/8"	
013127	1/2"	
014696	3/4"	
012230	1"	
012823	1-1/4"	
012453	1-1/2"	
013823	2"	
020655	2-1/2"	
020799	3"	
158328	4"	

90° Street Elbow

- 3000# Forged carbon steel
- Threaded



Part #	Size	Price
176836	1/8"	
168766	1/4"	
172289	3/8"	
172290	1/2"	
158908	3/4"	
158907	1"	
172291	1-1/4"	
172292	1-1/2"	
172293	2"	

Pipe Fittings

Forged Carbon Steel Fittings

90° Elbow

- 3000# Forged carbon steel
- Threaded



Part #	Size	Price
176834	1/8"	
161950	1/4"	
172270	3/8"	
047174	1/2"	
117942	3/4"	
132749	1"	
149557	1-1/4"	
012454	1-1/2"	
018276	2"	
108751	2-1/2"	
172271	3"	
172272	4"	

45° Elbow

- 3000# Forged carbon steel
- Threaded



Part #	Size	Price
176838	1/8"	
172273	1/4"	
172274	3/8"	
163540	1/2"	
158910	3/4"	
157576	1"	
157577	1-1/4"	
161951	1-1/2"	
156375	2"	
172275	3"	
172276	4"	

Hex Bushing

- 3000# Forged carbon steel
- Threaded



Part #	Size	Price
172319	1/4" x 1/8"	
176861	3/8" x 1/8"	
172320	3/8" x 1/4"	

3000# Carbon Steel Fittings (Continued)

Hex Bushing

Part #	Size	Price
163542	1/2" x 1/8"	
161811	1/2" x 1/4"	
176862	1/2" x 3/8"	
176863	3/4" x 1/8"	
107881	3/4" x 1/4"	
163545	3/4" x 3/8"	
155053	3/4" x 1/2"	
163546	1" x 1/8"	
163547	1" x 1/4"	
163548	1" x 3/8"	
155055	1" x 1/2"	
027180	1" x 3/4"	
163549	1-1/4" x 1/4"	
163550	1-1/4" x 3/8"	
176864	1-1/4" x 1/2"	
163552	1-1/4" x 3/4"	
160935	1-1/4" x 1"	
155056	1-1/2" x 1/2"	
155050	1-1/2" x 3/4"	
171782	1-1/2" x 1"	
023948	1-1/2" x 1-1/4"	
163553	2" x 1/4"	
163554	2" x 3/8"	
163555	2" x 1/2"	
155051	2" x 3/4"	
160928	2" x 1"	
156184	2" x 1-1/4"	
155048	2" x 1-1/2"	
172321	2-1/2" x 1"	
172322	2-1/2" x 1-1/2"	
172323	2-1/2" x 2"	
172324	3" x 1"	
172325	3" x 2"	
172326	3" x 2-1/2"	
172327	4" x 1"	
172328	4" x 2"	
172329	4" x 3"	

Reducing Coupling

- 3000# Forged carbon steel
- Threaded



Part #	Size	Price
172298	1/4" x 1/8"	
172299	3/8" x 1/8"	
172300	3/8" x 1/4"	
172301	1/2" x 1/8"	
172302	1/2" x 1/4"	
117945	1/2" x 3/8"	
172303	3/4" x 1/8"	
172304	3/4" x 1/4"	
172305	3/4" x 3/8"	
047474	3/4" x 1/2"	
172306	1" x 1/8"	
172307	1" x 1/4"	
172308	1" x 3/8"	
163407	1" x 1/2"	
149567	1" x 3/4"	
172309	1-1/4" x 1/4"	
172310	1-1/4" x 3/8"	
172311	1-1/4" x 1/2"	
149568	1-1/4" x 3/4"	
149570	1-1/4" x 1"	
172312	1-1/2" x 3/8"	
170934	1-1/2" x 1/2"	
156472	1-1/2" x 3/4"	
012569	1-1/2" x 1"	
149572	1-1/2" x 1-1/4"	
016377	2" x 1/2"	
156473	2" x 3/4"	
156474	2" x 1"	
172313	2" x 1-1/4"	
149573	2" x 1-1/2"	
107982	2-1/2" x 2"	

Reducing Tee

- 3000# Forged carbon steel
- Threaded



Part #	Size	Price
055582	3/4" x 3/4" x 1/2"	
160656	1" x 1" x 1/2"	
160657	1" x 1" x 3/4"	

Pipe Fittings

Forged Carbon Steel Fittings

3000# Carbon Steel Fittings (Continued)

Reducing Tee

Part #	Size	Price
157777	1-1/4" x 1-1/4" x 1"	
159536	1-1/2" x 1-1/2" x 3/4"	
159405	2" x 2" x 3/4"	
157800	2" x 2" x 1"	
160727	2" x 2" x 1-1/4"	
168607	2" x 2" x 1-1/2"	

Square Head Plug

- 3000# Forged carbon steel
- Threaded



Part #	Size	Price
172330	1/8"	
168376	1/4"	
168377	3/8"	
168378	1/2"	
168379	3/4"	
168380	1"	
168381	1-1/4"	
168382	1-1/2"	
159406	2"	
168383	2-1/2"	
168384	3"	
172331	4"	

Tee

- 3000# Forged carbon steel
- Threaded



Part #	Size	Price
176839	1/8"	
172277	1/4"	
172278	3/8"	
013128	1/2"	
150078	3/4"	
150079	1"	
150080	1-1/4"	
132735	1-1/2"	
132734	2"	
107981	2-1/2"	

3000# Carbon Steel Fittings (Continued)

Tee

Part #	Size	Price
172279	3"	
172280	4"	

Union

- 3000# Forged carbon steel
- Threaded



Part #	Size	Price
176842	1/8"	
172332	1/4"	
172333	3/8"	
013129	1/2"	
044156	3/4"	
044157	1"	
012824	1-1/4"	
132736	1-1/2"	
013825	2"	
172334	2-1/2"	
172335	3"	

Cross

- 3000# Forged carbon steel
- Threaded



Part #	Size	Price
176840	1/4"	
176841	3/8"	
058311	1/2"	
172281	3/4"	
172282	1"	
172283	1-1/4"	
172284	1-1/2"	
172285	2"	
172286	2-1/2"	
172287	3"	
172288	4"	

Outlet

- 3000# Forged carbon steel
- Threaded



Part #	Size	Price
176876	1-1/4" x 2"-3-1/2"	
176877	1-1/2" x 3"-5"	
176878	2"x4"-6"	

3000# Carbon Steel Fittings

Socket Weld

Cap

- 3000# Forged carbon steel
- Socket Weld



Part #	Size	Price
172422	1/4"	
172423	3/8"	
168498	1/2"	
168501	3/4"	
120202	1"	
172424	1-1/4"	
151861	1-1/2"	
072547	2"	
172425	2-1/2"	
172426	3"	
172427	4"	

Coupling

- 3000# Forged carbon steel
- Socket Weld



Part #	Size	Price
172385	1/4"	
149211	3/8"	
161471	1/2"	
074559	3/4"	
012231	1"	
149214	1-1/4"	
106712	1-1/2"	
013824	2"	
112542	2-1/2"	
172386	3"	
172387	4"	

Forged Carbon Steel Fittings

Half Coupling

- 3000# Forged carbon steel
- Socket Weld



Part #	Size	Price
172388	1/4"	
172389	3/8"	
172390	1/2"	
172391	3/4"	
153224	1"	
172392	1-1/4"	
172393	1-1/2"	
172394	2"	
172395	2-1/2"	
172396	3"	
172397	4"	

Reducing Coupling

- 3000# Forged carbon steel
- Socket Weld



Part #	Size	Price
172398	1/4" x 1/8"	
172399	3/8" x 1/8"	
172400	3/8" x 1/4"	
172401	1/2" x 1/8"	
172402	1/2" x 1/4"	
172403	1/2" x 3/8"	
172404	3/4" x 1/8"	
172405	3/4" x 1/4"	
172406	3/4" x 3/8"	
112537	3/4" x 1/2"	
172407	1" x 1/8"	
172408	1" x 1/4"	
172409	1" x 3/8"	
164417	1" x 1/2"	
112538	1" x 3/4"	
172410	1-1/4" x 1/4"	
172411	1-1/4" x 3/8"	
172412	1-1/4" x 1/2"	
172413	1-1/4" x 3/4"	
172414	1-1/4" x 1"	
172415	1-1/2" x 3/8"	
172416	1-1/2" x 1/2"	
172417	1-1/2" x 3/4"	

3000# Carbon Steel Fittings (Continued)

Reducing Coupling

Part #	Size	Price
172418	1-1/2" x 1"	
172462	1-1/2" x 1-1/4"	
172419	2" x 1/2"	
172420	2" x 3/4"	
167815	2" x 1"	
172421	2" x 1-1/4"	
112540	2" x 1-1/2"	

90° Elbow

- 3000# Forged carbon steel
- Socket Weld



Part #	Size	Price
172365	1/4"	
172366	3/8"	
161463	1/2"	
112536	3/4"	
057184	1"	
022226	1-1/4"	
079881	1-1/2"	
019750	2"	
022225	2-1/2"	
167683	3"	
172367	4"	

45° Elbow

- 3000# Forged carbon steel
- Socket weld



Part #	Size	Price
172368	1/4"	
172369	3/8"	
161468	1/2"	
161469	3/4"	
120203	1"	
161470	1-1/4"	
106711	1-1/2"	
156560	2"	
172370	2-1/2"	

3000# Carbon Steel Fittings (Continued)

45° Elbow

Part #	Size	Price
168545	3"	
172371	4"	

Insert

- 3000# Forged carbon steel
- Socket weld



Part #	Size	Price
172428	1/2" x 1/8"	
172429	1/2" x 1/4"	
166722	1/2" x 3/8"	
172430	3/4" x 1/8"	
172431	3/4" x 1/4"	
172432	3/4" x 3/8"	
168833	3/4" x 1/2"	
172434	1" x 1/8"	
172435	1" x 1/4"	
172436	1" x 3/8"	
168832	1" x 1/2"	
160766	1" x 3/4"	
172437	1-1/4" x 1/4"	
172438	1-1/4" x 3/8"	
168831	1-1/4" x 1/2"	
160767	1-1/4" x 3/4"	
160769	1-1/4" x 1"	
172439	1-1/2" x 3/8"	
168830	1-1/2" x 1/2"	
160771	1-1/2" x 3/4"	
160772	1-1/2" x 1"	
160773	1-1/2" x 1-1/4"	
168828	2" x 1/2"	
163511	2" x 3/4"	
168836	2" x 1"	
162942	2" x 1-1/4"	
162941	2" x 1-1/2"	
172440	2-1/2" x 3/4"	
172441	2-1/2" x 1"	
172442	2-1/2" x 1-1/4"	
114238	2-1/2" x 1-1/2"	
112541	2-1/2" x 2"	
172443	3" x 1"	
172444	3" x 1-1/4"	

Forged Carbon Steel Fittings

3000# Carbon Steel Fittings (Continued)

Insert

Part #	Size	Price
167681	3" x 1-1/2"	
167680	3" x 2"	
172445	3" x 2-1/2"	

Tee

- 3000# Forged carbon steel
- Socket Weld



Part #	Size	Price
172372	1/4"	
172373	3/8"	
161465	1/2"	
074556	3/4"	
057185	1"	
072544	1-1/4"	
074563	1-1/2"	
019751	2"	
114237	2-1/2"	
168547	3"	
172374	4"	

Union

- 3000# Forged carbon steel
- Socket Weld



Part #	Size	Price
172446	1/4"	
172447	3/8"	
161446	1/2"	
014697	3/4"	
012232	1"	
133075	1-1/4"	
161467	1-1/2"	
056880	2"	
172448	2-1/2"	
168548	3"	

Cross

- 3000# Forged carbon steel
- Socket Weld



Part #	Size	Price
172375	1/4"	
172376	3/8"	
172377	1/2"	
172378	3/4"	
172379	1"	
172380	1-1/4"	
172381	1-1/2"	
172382	2"	
172383	2-1/2"	
172384	3"	

Outlet

- 3000# Forged carbon steel
- Socket weld



Part #	Size	Price
176879	1/2" x 3/4" - 36"	
176880	3/4" x 1-1/2" - 36"	
176881	1" x 3" - 36"	
176882	1-1/4" x 4" - 36"	
176883	1-1/2" x 6" - 36"	
176884	2" x 4" - 6"	
176885	2" x 8" - 36"	

316SS Compression Fittings

316SS Compression Fittings

Female Adapter

- Tube OD x NPT



Part #	Size	Price
176063	1/4" x 1/4"	
176064	1/4" x 3/8"	
176066	1/4" x 1/2"	
176067	3/8" x 1/4"	
176068	3/8" x 3/8"	
176069	3/8" x 1/2"	
176070	1/2" x 1/4"	
176071	1/2" x 3/8"	
176072	1/2" x 1/2"	

Male Adapter

- Tube OD x NPT



Part #	Size	Price
176073	1/4" x 1/4"	
176074	1/4" x 3/8"	
176075	1/4" x 1/2"	
176076	3/8" x 1/4"	
176077	3/8" x 3/8"	
176078	3/8" x 1/2"	
176079	1/2" x 1/4"	
176080	1/2" x 3/8"	
176081	1/2" x 1/2"	

Male 90° Elbow

- Tube OD x NPT



Part #	Size	Price
176082	1/4" x 1/4"	
176083	1/4" x 3/8"	
176084	1/4" x 1/2"	
176085	3/8" x 1/4"	
176086	3/8" x 3/8"	
176087	3/8" x 1/2"	
176088	1/2" x 1/4"	
176089	1/2" x 3/8"	

316SS Compression Fittings (Continued)

Male 90° Elbow

Part #	Size	Price
176090	1/2" x 1/2"	

Straight Union



Part #	Size	Price
176091	1/4"	
176092	3/8"	
176093	1/2"	

Union 90° Elbow



Part #	Size	Price
176094	1/4"	
176095	3/8"	
176096	1/2"	

Union Tee



Part #	Size	Price
176097	1/4"	
176098	3/8"	
176099	1/2"	

Zurn-PEX Fittings

Poly PEX Fittings

Qick Sert CR® Polymer Swivel Adapter

- Molded from highly engineered polymers
- Used in hot and cold potable water applications
- Low-Lead Compliant



Part #	Mfg #	Size	Price
197272	QQPSFC33X	1/2" Barb x 1/2" FPT	
197273	QQPSFC44X	3/4" Barb x 3/4" FPT	

Qick Sert CR® Polymer Swivel Elbow

- Molded from highly engineered polymers
- Used in hot and cold potable water applications
- Low-Lead Compliant



Part #	Mfg #	Size	Price
197274	QQPE33BSX	1/2" Barb x 1/2" FPT	
197275	QQPE44BSX	3/4" Barb x 3/4" FPT	

QickTite® Assembled Elbow

- For use with PEX, copper, CPVC, and polybutylene
- Used in potable water systems only.



Part #	Mfg #	Size	Price
193030	QAE33	1/2" CTS	
193031	QAE44	3/4" CTS	

Qick Sert CR® Polymer Male Adapter

- Molded from highly engineered polymers
- Used in hot and cold potable water applications
- Low-Lead Compliant



Part #	Mfg #	Size	Price
197253	QQPMC33X	1/2" Barb x 1/2" MPT	
197254	QQPMC34X	1/2" Barb x 3/4" MPT	
197255	QQPMC44X	3/4" Barb x 3/4" MPT	

Qick Sert CR® Polymer Coupling

- Molded from highly engineered polymers
- Low-lead compliant



Part #	Mfg #	Size	Price
197248	QQPC33X	1/2" Barb	
197250	QQPC44X	3/4" Barb	
197249	QQPC43X	3/4" Barb x 1/2" Barb	
197251	QQPC54X	1" Barb x 3/4" Barb	
197252	QQPC55X	1" Barb	

Qick Sert CR® Polymer 90° Elbow

- Molded from highly engineered polymers
- Low-lead compliant



Part #	Mfg #	Size	Price
197258	QQPE33X	1/2" Barb	
197260	QQPE44X	3/4" Barb	
197259	QQPE43X	3/4" Barb x 1/2" Barb	
197261	QQPE55X	1" Barb	

Qick Sert CR® Polymer Adapter 90° Elbow

- Molded from highly engineered polymers
- Used in hot and cold potable water applications
- Low-Lead Compliant



Part #	Mfg #	Size	Price
197256	QQPE33BTX	1/2" Barb x 1/2" MPT	
197257	QQPE44BTX	3/4" Barb x 3/4" MPT	

Qick Sert CR® Polymer Tee

- Molded from highly engineered polymers
- Low-lead compliant



Part #	Mfg #	Size	Price
197262	QQPT333X	1/2" Barb x 1/2" Barb x 1/2" Barb	
197263	QQPT334X	1/2" Barb x 1/2" Barb x 3/4" Barb	
197264	QQPT433X	3/4" Barb x 1/2" Barb x 1/2" Barb	

Zurn-PEX Fittings

Poly PEX Fittings (Continued)

Qick Sert CR® Polymer Tee

Part #	Mfg #	Size	Price
197265	QQPT434X	3/4" Barb x 1/2" Barb x 3/4" Barb	
197266	QQPT443X	3/4" Barb x 3/4" Barb x 1/2" Barb	
197267	QQPT444X	3/4" Barb x 3/4" Barb x 3/4" Barb	
197268	QQPT553X	1" Barb x 1" Barb x 1/2" Barb	
197270	QQPT554X	1" Barb x 1" Barb x 3/4" Barb	
197271	QQPT555X	1" Barb x 1" Barb x 1" Barb	
197269	QQPT544X	1" Barb x 3/4" Barb x 3/4" Barb	

QickTite® Assembled Coupling

- For use with PEX, copper, CPVC, and polybutylene
- Use in potable water systems only.



Part #	Mfg #	Size	Price
193037	QAC21	3/8" CTS x 1/4" CTS	
193038	QAC22	3/8" CTS	
193035	QAC32	1/2" CTS x 3/8" CTS	
193039	QAC33	1/2" CTS	
193040	QAC43	3/4" CTS x 1/2" CTS	
193041	QAC44	3/4" CTS	

QickTite® Assembled Tee

- For use with PEX, copper, CPVC, and polybutylene
- Used in potable water systems only.



Part #	Mfg #	Size	Price
193021	QAT222	3/8" CTS	
193026	QAT333	1/2" CTS x 1/2" CTS x 3/8" CTS	
193027	QAT433	3/4" CTS x 1/2" CTS x 1/2" CTS	
193028	QAT443	3/4" CTS x 3/4" CTS x 1/2" CTS	
193029	QAT444	3/4" CTS	

Pipe Fittings

Copper PEX Fittings

Copper Female Sweat Adapter

- For use with PEX hot and cold water plumbing applications
- Low-lead compliant



Part #	Mfg #	Size	Price
201345	QQ750CX	1/2" Swt x 1/2" Barb	
201401	QQ775CX	3/4" Swt x 3/4" Barb	
201346	QQ800CX	1" Swt x 1" Barb	

Copper Male Sweat Adapter

- Low-lead compliant



Part #	Mfg #	Size	Price
201344	QQ700CX	1" Swt x 1" Barb	

Brass PEX Fittings

XL Brass 90° Elbow

- Low-lead compliant



Part #	Mfg #	Size	Price
201264	QQE33GX	1/2" Barb	
201266	QQE44GX	3/4" Barb	
201265	QQE43GX	3/4" Barb x 1/2" Barb	
201267	QQE55GX	1" Barb	

XL Brass Male 90° Elbow

- Used in PEX hot and cold water plumbing applications
- Easy installation
- Low-lead compliant



Part #	Mfg #	Size	Price
201263	QQE33BTGX	1/2" Barb x 1/2" MPT	

Zurn-PEX Fittings

XL Brass Tee

- Low-lead compliant



Part #	Mfg #	Size	Price
201278	QQT333GX	1/2" Barb x 1/2" Barb x 1/2" Barb	
201273	QQT433GX	3/4" Barb x 1/2" Barb x 1/2" Barb	
201279	QQT443GX	3/4" Barb x 3/4" Barb x 1/2" Barb	
201282	QQT444GX	3/4" Barb x 3/4" Barb x 3/4" Barb	
201365	QQT555GX	1" Barb x 1" Barb x 1" Barb	

XL Brass Test Plug



Part #	Mfg #	Size	Price
201276	QQP3GX	1/2" Barb	
201277	QQP4GX	3/4" Barb	
201355	QQP5GX	1" Barb	

Copper Sweat Adapter

- Low-lead compliant



Part #	Mfg #	Size	Price
201399	QQ650CX	1/2" Male Swt x 1/2" Barb	
201400	QQ675CX	3/4" Male Swt x 3/4" Barb	

XL Brass Male Adapter

- Used in PEX hot and cold water plumbing applications
- Easy to install
- Low-lead compliant



Part #	Mfg #	Size	Price
201268	QQMC33GX	1/2" Barb x 1/2" MPT	
201271	QQMC44GX	3/4" Barb x 3/4" MPT	
201370	QQMC55GX	1" Barb x 1" MPT	

XL Brass Female Adapter



Part #	Mfg #	Size	Price
201274	QQUFC33GX	1/2" Barb x 1/2" FPT	
201275	QQUFC44GX	3/4" Barb x 3/4" FPT	
201374	QQUFC55GX	1" Barb x 1" FPT	

XL Brass Small Diameter Coupling

- Used in PEX hot and cold water plumbing applications
- Easy installation
- Low-lead compliant



Part #	Mfg #	Size	Price
201262	QQC33GX	1/2" Barb	
201359	QQC43GX	3/4" Barb x 1/2" Barb	
201356	QQC44GX	3/4" Barb	
201363	QQC54GX	1" Barb x 3/4" Barb	
201362	QQC55GX	1" Barb	

XL Brass Non-Swivel Large Diameter Female Adapter

- Used in PEX hot and cold water plumbing applications
- Easy to Install
- Low-Lead Compliant
- Dezincification resistant



Part #	Mfg #	Size	Price
212602	QQUFC77GX	1-1/2" Barb x 1-1/2" FPT	

QuickTite Male Assembled Adapter Coupling

- For use with PEX, copper, CPVC, and polybutylene
- Use in potable water systems only.



Part #	Mfg #	Size	Price
201353	QACA33MG	1/2" CTS x 1/2" MIP	
201354	QACA34MG	1/2" CTS x 3/4" MIP	
193042	QACA44MG	3/4" CTS x 3/4" MIP	

Zurn-PEX Fittings

XL Brass Swivel Cone

- Used in PEX hot and cold water plumbing applications
- Easy to Install
- Low-Lead Compliant



Part #	Mfg #	Size	Price
192998	QQSFC33GX P	1/2" Barb x 1/2" FPT	

Transition Coupling

- Brass PEX to PB
- Used in PEX hot and cold water plumbing applications
- Easy to install
- Dezincification resistant



Part #	Mfg #	Size	Price
201342	QQC33CCXN PK1	1/2" Barb	
201343	QQC44CCXN PK1	3/4" Barb	

XL Brass Stop Valve

- Used in PEX hot and cold water plumbing applications
- Quarter turn
- Quarter turn valve
- Low-Lead Compliant



Part #	Mfg #	Size	Price
205650	QQTV40GX	1/2" Barb x 1/4" OD	
201272	QQTV60GX	1/2" Barb x 3/8" OD	

Manifolds PEX Manifold

- Complete with supply and return isolation ball valves and automatic air vents
- Includes fill/drain valves and supply and return thermometers
- Rated for 150psi at a maximum temperature of 230°F
- Mounting brackets included



Part #	Mfg #	Size	Price
200489	QHPM10	10 Port	

QickPort Manifold Cap

- Add-A-Port manifold component
- Manufactured using highly engineered polymer
- Low-lead compliant



Part #	Mfg #	Size	Price
197692	QTC3FQP	1/2"	

QickPort® Female Assembled Adapter

- Add-A-Port manifold component
- Manufactured using highly engineered polymer
- Low-lead compliant



Part #	Mfg #	Size	Price
193036	QAFA33F	1/2" CTS x 1/2" FPT	
193034	QAFA44F	3/4" CTS x 3/4" FPT	

Tools & Misc.

QickCap® Crimp Ring

- Accurately positions crimp ring on tubing to ensure proper installation
- Quick and easy installation



Part #	Mfg #	Size	Price
228191	QCR3XPC	1/2"	
228194	QCR4XPC	3/4"	
228195	QCR5XPC	1"	

Qickclamp® Crimp Ring

- Patent-pending stainless steel technology
- One-tool system
- Indicator positioning site hole
- Used in PEX hot and cold water plumbing applications
- Easy installation



Part #	Mfg #	Size	Price
196361	CLP3X	1/2"	
196362	CLP4X	3/4"	

Zurn-PEX Fittings

Stainless Steel Crimp Ring

- *Stainless Steel Crimp Ring*
- *Utilizes one tool*
- *Used in hot and cold water plumbing applications*



Part #	Mfg #	Size	Price
211083	QSOET3X	1/2"	
211084	QSOET4X	3/4"	
216018	QSOET5X	1"	

Copper Crimp Ring

- *Annealed copper crimp ring*
- *For use with SDR9 tubing*



Part #	Mfg #	Size	Price
193003	QCR2X	3/8"	
193004	QCR3X	1/2"	
193005	QCR4X	3/4"	
193006	QCR5X	1"	
212601	QCR8X	2"	

QuickTite® Nut/Ring/Cone Set

- *For use with PEX, Copper, CPVC, and Polybutylene*
- *Use in potable water systems only.*



Part #	Mfg #	Size	Price
193043	QBFNCR3	3/4" Thread - 1/2" Nominal CTS	
193044	QBFNCR4	1" Thread - 3/4" Nominal CTS	

Lavatory Supply Tube

- *Flexible*
- *Easy to install*
- *Low-lead compliant*



Part #	Mfg #	Size	Price
191973	QBA12X	3/8" OD x 12"	
191974	QBA20X	3/8" OD x 20"	
191975	QBA30X	3/8" OD x 30"	
191976	QBA36X	3/8" OD x 36"	

Closet Supply Tube

- *Flexible*
- *Easy to install*
- *Low-lead compliant*



Part #	Mfg #	Size	Price
191980	QCL12X	3/8" OD x 12"	
191981	QCL20X	3/8" OD x 20"	

Crimp Ring Remover

- *Durable Crimp Ring Remover Tool*
- *Allows easy removal of crimp ring*



Part #	Mfg #	Size	Price
194717	QCRRT		

Compression Plastic Ferrule

- *Ferrules Compression Ring for Supply tube*



Part #	Mfg #	Size	Price
191978	QBF1	3/8" OD	
193193	QBF2	1/2" OD	

Large Crimp Tool

- *Large Crimp Tool for 1" copper crimp ring*
- *Includes Go/No-Go gauge*



Part #	Mfg #	Size	Price
195069	QCRT5T	1"	

Medium Crimp Tool

- *Medium crimp tool for 1/2" copper crimp ring*
- *Includes Go/No-Go gauge*



Part #	Mfg #	Size	Price
193122	QCRT3CM	1/2"	
193128	QCRT4CM	3/4"	

Zurn-PEX Fittings

QuickClamp Crimp Tool

- Easy to use with one hand
- Crimps multiple size QuickClamp rings



Part #	Mfg #	Size	Price
196694	QCRTQCM		

Crimp Gauge

- For Checking 3/8", 1/2", 3/4" Crimps



Part #	Mfg #	Size	Price
193124	QGA234P	3/8", 1/2", 3/4"	
212915	QGA5N	1"	

QuickClamp Crimp Gauge

- For Checking 3/8", 1/2", 3/4" and 1" QuickClamp Crimps



Part #	Mfg #	Size	Price
207185	QGNQC	3/8", 1/2", 3/4", 1"	

Ratchet Tube Cutter

- Durable PEX tubing cutter



Part #	Mfg #	Size	Price
193025	QPC752		

Bend Support

- Bend Support for 1/2" PEX tubing
- Comes with integral mounting bracket
- Used in hot and cold water plumbing applications
- Used in radiant heating applications



Part #	Mfg #	Size	Price
194612	QHPBS3	1/2"	

QuickClamp Ratcheting Tool

- QuickClamp ratcheting tool
- Indicator lights illuminate when crimp is complete
- Comes with canvas holder



Part #	Mfg #	Size	Price
201554	QCRTQCRM		

Stainless Steel Crimp Ring Tool

- Crimps multiple stainless crimp sizes
- Easy to use



Part #	Mfg #	Size	Price
216019	QSECR		

Test Plug

- Plastic Test Plug 1/2"
- Temporary use only



Part #	Mfg #	Size	Price
195961	QXP3XP	1/2" Barb	
197485	QXP4XP	3/4" Barb	
197486	QXP5XP	1" Barb	



DECOLAV®



DECOLAV®

Sink Accessories

Parts & Accessories

Glass Vessel Mounting Ring



Part #	Mfg #	Size	Finish	Price
090808	9020-CP	3/4"	Pol Chrome	
098254	9020-DB	3/4"	Deco Bronze	
081465	9020-SN	3/4"	Satin Nickel	

Lavatories

Pedestal Lavatories

Fireclay Pedestal Lavatories

Kathryn® Pedestal Lavatory

- Overflow drain
- Fireclay
- Rectangular Basin



K-2322 Combination: K-2323 Basin and K-2324 Pedestal

Part #	Mfg #	Description	Dimensions	Color	Price
104526	K-2322-1-0	1-Hole Complete	27" x 20" x 35"	White	
134044	K-2322-4-0	4"cc Complete	27" x 20" x 35"	White	
072574	K-2322-8-0	8"cc Complete	27" x 20" x 35"	White	
074593	K-2322-8-96	8"cc Complete	27" x 20" x 35"	Biscuit	
182822	K-2322-8-K4	8"cc Complete	27" x 20" x 35"	Cashmere	

Memoirs® Classic Pedestal Lavatory

- Overflow drain
- Fireclay
- Available in 24" or 27" widths



K-2258



K-2238

24"

K-2238 Combination: K-2239 Basin, K-2267 Pedestal

24" x 19-3/4" x 34-3/8"

Part #	Mfg #	Description	Dimensions	Color	Price
071261	K-2238-1-0	1-Hole Complete	24" x 19-3/4" x 34-3/8"	White	
110556	K-2238-1-47	1-Hole Complete	24" x 19-3/4" x 34-3/8"	Almond	
100405	K-2238-1-7	1-Hole Complete	24" x 19-3/4" x 34-3/8"	Black	
083939	K-2238-1-96	1-Hole Complete	24" x 19-3/4" x 34-3/8"	Biscuit	
118373	K-2238-1-G9	1-Hole Complete	24" x 19-3/4" x 34-3/8"	Sandbar	
053435	K-2238-4-0	4"cc Complete	24" x 19-3/4" x 34-3/8"	White	
055044	K-2238-4-47	4"cc Complete	24" x 19-3/4" x 34-3/8"	Almond	
053439	K-2238-4-96	4"cc Complete	24" x 19-3/4" x 34-3/8"	Biscuit	
103890	K-2238-4-G9	4"cc Complete	24" x 19-3/4" x 34-3/8"	Sandbar	
100111	K-2238-4-K4	4"cc Complete	24" x 19-3/4" x 34-3/8"	Cashmere	
053440	K-2238-8-0	8"cc Complete	24" x 19-3/4" x 34-3/8"	White	
086799	K-2238-8-47	8"cc Complete	24" x 19-3/4" x 34-3/8"	Almond	
053441	K-2238-8-96	8"cc Complete	24" x 19-3/4" x 34-3/8"	Biscuit	
078333	K-2238-8-G9	8"cc Complete	24" x 19-3/4" x 34-3/8"	Sandbar	
227061	K-2238-8-K4	8"cc Complete	24" x 19-3/4" x 34-3/8"	Cashmere	

Pedestal Lavatories

27"

K-2258 Combination: K-2259 Basin, K-2267 Pedestal

27" x 22" x 35"

Part #	Mfg #	Description	Dimensions	Color	Price
076811	K-2258-1-0	1-Hole Complete	27" x 22" x 35"	White	
069459	K-2258-1-96	1-Hole Complete	27" x 22" x 35"	Biscuit	
060135	K-2258-8-0	8"cc Complete	27" x 22" x 35"	White	
056306	K-2258-8-47	8"cc Complete	27" x 22" x 35"	Almond	
066655	K-2258-8-7	8"cc Complete	27" x 22" x 35"	Black	
064305	K-2258-8-96	8"cc Complete	27" x 22" x 35"	Biscuit	
083795	K-2258-8-K4	8"cc Complete	27" x 22" x 35"	Cashmere	
086461	K-2258-8-G9	8"cc Complete	27" x 22" x 35"	Sandbar	

Memoirs® Stately Pedestal Lavatory

- Overflow drain



24"

K-2344 Combination: K-2345 Basin, K-2267 Pedestal

24-1/2" x 20-1/2" x 34-3/4"

Part #	Mfg #	Description	Dimensions	Color	Price
100157	K-2344-1-0	1-Hole Complete	24-1/2" x 20-1/2" x 34-3/4"	White	
126250	K-2344-1-96	1-Hole Complete	24-1/2" x 20-1/2" x 34-3/4"	Biscuit	
091723	K-2344-4-0	4"cc Complete	24-1/2" x 20-1/2" x 34-3/4"	White	
146189	K-2344-4-47	4"cc Complete	24-1/2" x 20-1/2" x 34-3/4"	Almond	
110379	K-2344-4-96	4"cc Complete	24-1/2" x 20-1/2" x 34-3/4"	Biscuit	
123356	K-2344-4-K4	4"cc Complete	24-1/2" x 20-1/2" x 34-3/4"	Cashmere	
092085	K-2344-8-0	8"cc Complete	24-1/2" x 20-1/2" x 34-3/4"	White	
143698	K-2344-8-47	8"cc Complete	24-1/2" x 20-1/2" x 34-3/4"	Almond	
086651	K-2344-8-96	8"cc Complete	24-1/2" x 20-1/2" x 34-3/4"	Biscuit	
108530	K-2344-8-G9	8"cc Complete	24-1/2" x 20-1/2" x 34-3/4"	Sandbar	
103601	K-2344-8-K4	8"cc Complete	24-1/2" x 20-1/2" x 34-3/4"	Cashmere	

30"

K-2268 Combination: K-2269 Stately Lavatory, K-2267 Pedestal

30" x 21-3/4" x 34-3/4"

Part #	Mfg #	Description	Dimensions	Color	Price
073963	K-2268-1-0	1-Hole Complete	30" x 21-3/4" x 34-3/4"	White	
157237	K-2268-1-33	1-Hole Complete	30" x 21-3/4" x 34-3/4"	Mexican Sand	
121108	K-2268-1-47	1-Hole Complete	30" x 21-3/4" x 34-3/4"	Almond	
155626	K-2268-1-7	1-Hole Complete	30" x 21-3/4" x 34-3/4"	Black	
087380	K-2268-1-95	1-Hole Complete	30" x 21-3/4" x 34-3/4"	Ice Grey	
101377	K-2268-1-96	1-Hole Complete	30" x 21-3/4" x 34-3/4"	Biscuit	

Pedestal Lavatories

Lavatories

Fireclay Pedestal Lavatories (Continued)

Memoirs® Stately Pedestal Lavatory

30"

Part #	Mfg #	Description	Dimensions	Color	Price
053525	K-2268-8-0	8"cc Complete	30" x 21-3/4" x 34-3/4"	White	
087176	K-2268-8-33	8"cc Complete	30" x 21-3/4" x 34-3/4"	Mexican Sand	
096305	K-2268-8-47	8"cc Complete	30" x 21-3/4" x 34-3/4"	Almond	
116575	K-2268-8-7	8"cc Complete	30" x 21-3/4" x 34-3/4"	Black	
058173	K-2268-8-95	8"cc Complete	30" x 21-3/4" x 34-3/4"	Ice Grey	
055824	K-2268-8-96	8"cc Complete	30" x 21-3/4" x 34-3/4"	Biscuit	
094953	K-2268-8-G9	8"cc Complete	30" x 21-3/4" x 34-3/4"	Sandbar	
084567	K-2268-8-K4	8"cc Complete	30" x 21-3/4" x 34-3/4"	Cashmere	

Tresham® Pedestal Lavatory

- Overflow drain



K-2844



K-2845

24"

K-2844 Combination: K-2757 Lavatory Basin, K-2767 Pedestal Leg

24" x 19-1/2" x 34-5/8"

Part #	Mfg #	Description	Dimensions	Color	Price
146263	K-2844-1-0	1-Hole Complete	24" x 19-1/2" x 34-5/8"	White	
149926	K-2844-1-96	1-Hole Complete	24" x 19-1/2" x 34-5/8"	Biscuit	
224495	K-2844-1-NY	1-Hole Complete	24" x 19-1/2" x 34-5/8"	Dune	
143740	K-2844-4-0	4"cc Complete	24" x 19-1/2" x 34-5/8"	White	
153446	K-2844-4-7	4"cc Complete	24" x 19-1/2" x 34-5/8"	Black	
146033	K-2844-8-0	8"cc Complete	24" x 19-1/2" x 34-5/8"	White	
170164	K-2844-8-47	8"cc Complete	24" x 19-1/2" x 34-5/8"	Almond	
149006	K-2844-8-96	8"cc Complete	24" x 19-1/2" x 34-5/8"	Biscuit	
159945	K-2844-8-K4	8"cc Complete	24" x 19-1/2" x 34-5/8"	Cashmere	

30"

K-2845 Combination: K-2758 Lavatory Basin, K-2767 Pedestal Leg

30" x 19-1/2" x 34-5/8"

Part #	Mfg #	Description	Dimensions	Color	Price
150536	K-2845-1-0	1-Hole Complete	30" x 19-1/2" x 34-5/8"	White	
162721	K-2845-1-96	1-Hole Complete	30" x 19-1/2" x 34-5/8"	Biscuit	
147921	K-2845-8-0	8"cc Complete	30" x 19-1/2" x 34-5/8"	White	
164686	K-2845-8-33	8"cc Complete	30" x 19-1/2" x 34-5/8"	Mexican Sand	
155380	K-2845-8-96	8"cc Complete	30" x 19-1/2" x 34-5/8"	Biscuit	

Pedestal Lavatories

Fireclay Pedestal Lavatories (Continued)

Tresham® Pedestal Lavatory

30"

Part #	Mfg #	Description	Dimensions	Color	Price
154952	K-2845-8-K4	8"cc Complete	30" x 19-1/2" x 34-5/8"	Cashmere	

Reve® Pedestal Lavatory — 23-5/8" x 18-5/16" x 35-1/2"

- Deep, V-shaped basin
- Overflow drain included with K-4061 chrome cap



K-5152 Combination: K-5027 Basin, K-5032 Pedestal Leg

Part #	Mfg #	Description	Dimensions	Color	Price
155429	K-5152-1-0	1-Hole Complete	23-5/8" x 18-5/16" x 35-1/2"	White	

Vitreous China Pedestal Lavatories

Archer™ Pedestal Lavatory — 24" x 20-7/16" x 35-1/4"

- Overflow drain
- Faucet sold separately



K-2359

Part #	Mfg #	Description	Dimensions	Color	Price
108319	K-2359-1-0	1-Hole Complete	24" x 20-7/16" x 35-1/4"	White	
130107	K-2359-1-96	1-Hole Complete	24" x 20-7/16" x 35-1/4"	Biscuit	
114406	K-2359-1-G9	1-Hole Complete	24" x 20-7/16" x 35-1/4"	Sandbar	
172853	K-2359-1-NY	1-Hole Complete	24" x 20-7/16" x 35-1/4"	Dune	
107989	K-2359-4-0	4"cc Complete	24" x 20-7/16" x 35-1/4"	White	
109344	K-2359-4-33	4"cc Complete	24" x 20-7/16" x 35-1/4"	Mexican Sand	
168117	K-2359-4-7	4"cc Complete	24" x 20-7/16" x 35-1/4"	Black	
174338	K-2359-4-95	4"cc Complete	24" x 20-7/16" x 35-1/4"	Ice Grey	
109539	K-2359-4-96	4"cc Complete	24" x 20-7/16" x 35-1/4"	Biscuit	
131492	K-2359-4-G9	4"cc Complete	24" x 20-7/16" x 35-1/4"	Sandbar	
128732	K-2359-4-K4	4"cc Complete	24" x 20-7/16" x 35-1/4"	Cashmere	
103963	K-2359-8-0	8"cc Complete	24" x 20-7/16" x 35-1/4"	White	
109351	K-2359-8-33	8"cc Complete	24" x 20-7/16" x 35-1/4"	Mexican Sand	
126085	K-2359-8-47	8"cc Complete	24" x 20-7/16" x 35-1/4"	Almond	
121249	K-2359-8-95	8"cc Complete	24" x 20-7/16" x 35-1/4"	Ice Grey	
110177	K-2359-8-96	8"cc Complete	24" x 20-7/16" x 35-1/4"	Biscuit	
111882	K-2359-8-G9	8"cc Complete	24" x 20-7/16" x 35-1/4"	Sandbar	
188485	K-2359-8-NY	8"cc Complete	24" x 20-7/16" x 35-1/4"	Dune	

Pedestal Lavatories

Bancroft™ Pedestal Lavatory

- Overflow drain
- Faucet sold separately
- Available in 24" and 30" widths



24"

K-2338 Combination: K-2340 Lavatory, K-2346 Pedestal

24" x 21" x 35-1/4"

Part #	Mfg #	Description	Dimensions	Color	Price
090404	K-2338-1-0	1-Hole Complete	24" x 21" x 35-1/4"	White	
093338	K-2338-1-47	1-Hole Complete	24" x 21" x 35-1/4"	Almond	
102336	K-2338-1-96	1-Hole Complete	24" x 21" x 35-1/4"	Biscuit	
090402	K-2338-4-0	4"cc Complete	24" x 21" x 35-1/4"	White	
104025	K-2338-4-47	4"cc Complete	24" x 21" x 35-1/4"	Almond	
122319	K-2338-4-95	4"cc Complete	24" x 21" x 35-1/4"	Ice Grey	
095486	K-2338-4-96	4"cc Complete	24" x 21" x 35-1/4"	Biscuit	
096035	K-2338-4-G9	4"cc Complete	24" x 21" x 35-1/4"	Sandbar	
164678	K-2338-4-NY	4"cc Complete	24" x 21" x 35-1/4"	Dune	
087318	K-2338-8-0	8"cc Complete	24" x 21" x 35-1/4"	White	
091968	K-2338-8-33	8"cc Complete	24" x 21" x 35-1/4"	Mexican Sand	
098033	K-2338-8-47	8"cc Complete	24" x 21" x 35-1/4"	Almond	
105208	K-2338-8-7	8"cc Complete	24" x 21" x 35-1/4"	Black	
093501	K-2338-8-96	8"cc Complete	24" x 21" x 35-1/4"	Biscuit	
101855	K-2338-8-G9	8"cc Complete	24" x 21" x 35-1/4"	Sandbar	
142121	K-2338-8-K4	8"cc Complete	24" x 21" x 35-1/4"	Cashmere	

30"

K-2347 Combination: K-2348 Lavatory, K-2346 Pedestal

30-3/8" x 22-1/4" x 35-1/4"

Part #	Mfg #	Description	Dimensions	Color	Price
107510	K-2347-1-0	1-Hole Complete	30-3/8" x 22-1/4" x 35-1/4"	White	
129953	K-2347-1-47	1-Hole Complete	30-3/8" x 22-1/4" x 35-1/4"	Almond	
095064	K-2347-1-96	1-Hole Complete	30-3/8" x 22-1/4" x 35-1/4"	Biscuit	
092829	K-2347-8-0	8"cc Complete	30-3/8" x 22-1/4" x 35-1/4"	White	
093524	K-2347-8-33	8"cc Complete	30-3/8" x 22-1/4" x 35-1/4"	Mexican Sand	
156857	K-2347-8-47	8"cc Complete	30-3/8" x 22-1/4" x 35-1/4"	Almond	
093137	K-2347-8-96	8"cc Complete	30-3/8" x 22-1/4" x 35-1/4"	Biscuit	
098956	K-2347-8-G9	8"cc Complete	30-3/8" x 22-1/4" x 35-1/4"	Sandbar	

Pedestal Lavatories

Cimarron™ Pedestal Lavatory — 22-3/4" x 18-7/8" x 34-1/2"

- Stately design
- Generous interior basin and deck size
- Pedestal designed to conceal water supplies and drain
- Faucet sold separately

K-2362 Combination: K-2363 Lavatory, K-2364 Pedestal

Part #	Mfg #	Description	Dimensions	Color	Price
100175	K-2362-1-0	1-Hole Complete	22-3/4" x 18-7/8" x 34-1/2"	White	
126152	K-2362-1-47	1-Hole Complete	22-3/4" x 18-7/8" x 34-1/2"	Almond	
157185	K-2362-1-7	1-Hole Complete	22-3/4" x 18-7/8" x 34-1/2"	Black	
145243	K-2362-1-95	1-Hole Complete	22-3/4" x 18-7/8" x 34-1/2"	Ice Grey	
106738	K-2362-1-96	1-Hole Complete	22-3/4" x 18-7/8" x 34-1/2"	Biscuit	
138518	K-2362-1-G9	1-Hole Complete	22-3/4" x 18-7/8" x 34-1/2"	Sandbar	
093834	K-2362-4-0	4"cc Complete	22-3/4" x 18-7/8" x 34-1/2"	White	
140238	K-2362-4-47	4"cc Complete	22-3/4" x 18-7/8" x 34-1/2"	Almond	
118180	K-2362-4-7	4"cc Complete	22-3/4" x 18-7/8" x 34-1/2"	Black	
103615	K-2362-4-96	4"cc Complete	22-3/4" x 18-7/8" x 34-1/2"	Biscuit	
093836	K-2362-8-0	8"cc Complete	22-3/4" x 18-7/8" x 34-1/2"	White	
111839	K-2362-8-47	8"cc Complete	22-3/4" x 18-7/8" x 34-1/2"	Almond	
103453	K-2362-8-7	8"cc Complete	22-3/4" x 18-7/8" x 34-1/2"	Black	
173291	K-2362-8-95	8"cc Complete	22-3/4" x 18-7/8" x 34-1/2"	Ice Grey	
094415	K-2362-8-96	8"cc Complete	22-3/4" x 18-7/8" x 34-1/2"	Biscuit	
135741	K-2362-8-G9	8"cc Complete	22-3/4" x 18-7/8" x 34-1/2"	Sandbar	

Devonshire® Pedestal Lavatory

- Faucet sold separately



2286-4-0

24"

K-2286 Combination: K-2287 Lavatory, K-2288 Pedestal

24-1/8" x 19-3/4" x 33-1/2"

Part #	Mfg #	Description	Dimensions	Color	Price
053460	K-2286-1-0	1-Hole Compete	24-1/8" x 19-3/4" x 33-1/2"	White	
102851	K-2286-1-33	1-Hole Compete	24-1/8" x 19-3/4" x 33-1/2"	Mexican Sand	
082605	K-2286-1-7	1-Hole Compete	24-1/8" x 19-3/4" x 33-1/2"	Black	
058957	K-2286-1-95	1-Hole Compete	24-1/8" x 19-3/4" x 33-1/2"	Ice Grey	
064249	K-2286-1-96	1-Hole Compete	24-1/8" x 19-3/4" x 33-1/2"	Biscuit	
053448	K-2286-4-0	4"cc Compete	24-1/8" x 19-3/4" x 33-1/2"	White	
063282	K-2286-4-33	4"cc Compete	24-1/8" x 19-3/4" x 33-1/2"	Mexican Sand	
063363	K-2286-4-47	4"cc Compete	24-1/8" x 19-3/4" x 33-1/2"	Almond	
071491	K-2286-4-95	4"cc Compete	24-1/8" x 19-3/4" x 33-1/2"	Ice Grey	
053449	K-2286-4-96	4"cc Compete	24-1/8" x 19-3/4" x 33-1/2"	Biscuit	
057605	K-2286-4-G9	4"cc Compete	24-1/8" x 19-3/4" x 33-1/2"	Sandbar	

Pedestal Lavatories

Vitreous China Pedestal Lavatories (Continued)

Devonshire® Pedestal Lavatory

24"

Part #	Mfg #	Description	Dimensions	Color	Price
053450	K-2286-8-0	8"cc Complete	24-1/8" x 19-3/4" x 33-1/2"	White	
071109	K-2286-8-33	8"cc Complete	24-1/8" x 19-3/4" x 33-1/2"	Mexican Sand	
096303	K-2286-8-47	8"cc Complete	24-1/8" x 19-3/4" x 33-1/2"	Almond	
067102	K-2286-8-7	8"cc Complete	24-1/8" x 19-3/4" x 33-1/2"	Black	
054739	K-2286-8-95	8"cc Complete	24-1/8" x 19-3/4" x 33-1/2"	Ice Grey	
053456	K-2286-8-96	8"cc Complete	24-1/8" x 19-3/4" x 33-1/2"	Biscuit	
056763	K-2286-8-G9	8"cc Complete	24-1/8" x 19-3/4" x 33-1/2"	Sandbar	
106000	K-2286-8-K4	8"cc Complete	24-1/8" x 19-3/4" x 33-1/2"	Cashmere	

27"

K-2294 Combination: K-2295 Lavatory, K-2288 Pedestal

27-1/2" x 19-7/8" x 33-1/2"

Part #	Mfg #	Description	Dimensions	Color	Price
059570	K-2294-1-0	1-Hole Complete	27-1/2" x 19-7/8" x 33-1/2"	White	
076675	K-2294-1-95	1-Hole Complete	27-1/2" x 19-7/8" x 33-1/2"	Ice Grey	
056651	K-2294-1-96	1-Hole Complete	27-1/2" x 19-7/8" x 33-1/2"	Biscuit	
142857	K-2294-1-K4	1-Hole Complete	27-1/2" x 19-7/8" x 33-1/2"	Cashmere	
056199	K-2294-8-0	8"cc Complete	27-1/2" x 19-7/8" x 33-1/2"	White	
077583	K-2294-8-33	8"cc Complete	27-1/2" x 19-7/8" x 33-1/2"	Mexican Sand	
071931	K-2294-8-47	8"cc Complete	27-1/2" x 19-7/8" x 33-1/2"	Almond	
066453	K-2294-8-7	8"cc Complete	27-1/2" x 19-7/8" x 33-1/2"	Black	
107495	K-2294-8-95	8"cc Complete	27-1/2" x 19-7/8" x 33-1/2"	Ice Grey	
061724	K-2294-8-96	8"cc Complete	27-1/2" x 19-7/8" x 33-1/2"	Biscuit	
072243	K-2294-8-G9	8"cc Complete	27-1/2" x 19-7/8" x 33-1/2"	Sandbar	
092213	K-2294-8-K4	8"cc Complete	27-1/2" x 19-7/8" x 33-1/2"	Cashmere	

Parigi® Pedestal Sink — 19-3/4" x 14" x 32-7/8"

- D-Shaped basin
- Beveled basin ledge



K-2175 Combination: K-2176 Sink Basin, K-2177 Pedestal

Part #	Mfg #	Description	Dimensions	Color	Price
067025	K-2175-1-0	1-Hole Complete	19-3/4" x 14" x 32-7/8"	White	
182419	K-2175-1-96	1-Hole Complete	19-3/4" x 14" x 32-7/8"	Biscuit	
056320	K-2175-4-0	4"cc Complete	19-3/4" x 14" x 32-7/8"	White	
100557	K-2175-4-47	4"cc Complete	19-3/4" x 14" x 32-7/8"	Almond	
108868	K-2175-4-96	4"cc Complete	19-3/4" x 14" x 32-7/8"	Biscuit	

Pedestal Lavatories

Portrait® Pedestal Sink — 27" x 19-3/8" x 36-1/2"

- Overflow drain
- Oval basin



K-2221 Combination: K-2222-8 Lavatory, K-2223 Pedestal

Part #	Mfg #	Description	Dimensions	Color	Price
126604	K-2221-1-0	1-Hole Complete	27" x 19-3/8" x 36-1/2"	White	
062669	K-2221-1-96	1-Hole Complete	27" x 19-3/8" x 36-1/2"	Biscuit	
053442	K-2221-4-0	4"cc Complete	27" x 19-3/8" x 36-1/2"	White	
053443	K-2221-4-47	4"cc Complete	27" x 19-3/8" x 36-1/2"	Almond	
053444	K-2221-4-96	4"cc Complete	27" x 19-3/8" x 36-1/2"	Biscuit	
071780	K-2221-4-G9	4"cc Complete	27" x 19-3/8" x 36-1/2"	Sandbar	
053445	K-2221-8-0	8"cc Complete	27" x 19-3/8" x 36-1/2"	White	
072310	K-2221-8-33	8"cc Complete	27" x 19-3/8" x 36-1/2"	Mexican Sand	
053446	K-2221-8-47	8"cc Complete	27" x 19-3/8" x 36-1/2"	Almond	
066474	K-2221-8-7	8"cc Complete	27" x 19-3/8" x 36-1/2"	Black	
053447	K-2221-8-96	8"cc Complete	27" x 19-3/8" x 36-1/2"	Biscuit	
061535	K-2221-8-G9	8"cc Complete	27" x 19-3/8" x 36-1/2"	Sandbar	
080974	K-2221-8-K4	8"cc Complete	27" x 19-3/8" x 36-1/2"	Cashmere	

Veer™ Pedestal Lavatory

- Ample side deck space for toiletries



21"

K-5265 Combination: K-5247 Lavatory, K-5246 Pedestal
21" x 18-1/4" x 35-1/2"

Part #	Mfg #	Description	Dimensions	Color	Price
171164	K-5265-1-0	1-Hole Complete	21" x 18-1/4" x 35-1/2"	White	
182796	K-5265-1-96	1-Hole Complete	21" x 18-1/4" x 35-1/2"	Biscuit	
171853	K-5265-4-0	4" cc Compete	21" x 18-1/4" x 35-1/2"	White	
162671	K-5265-8-0	8"cc Complete	21" x 18-1/4" x 35-1/2"	White	

24"

K-5266 Combination: K-5248 Lavatory, K-5246 Pedestal
24" x 18-1/4" x 35-1/2"

Part #	Mfg #	Description	Dimensions	Color	Price
170076	K-5266-1-0	1-Hole Complete	24" x 18-1/4" x 35-1/2"	White	
190005	K-5266-1-96	1-Hole Complete	24" x 18-1/4" x 35-1/2"	Biscuit	

Pedestal Lavatories

Vitreous China Pedestal Lavatories (Continued)

Veer™ Pedestal Lavatory

24"

Part #	Mfg #	Description	Dimensions	Color	Price
165843	K-5266-1-NY	1-Hole Complete	24" x 18-1/4" x 35-1/2"	Dune	
172951	K-5266-4-0	4"cc Complete	24" x 18-1/4" x 35-1/2"	White	
186491	K-5266-4-96	4"cc Complete	24" x 18-1/4" x 35-1/2"	Biscuit	

Wellworth™ Pedestal Lavatory — 22-1/4" x 18-1/4" x 34-7/8"

- Faucet sold separately



K-2293-4-0

K-2293 Combination: K-2296 Lavatory, K-2019 Pedestal

Part #	Mfg #	Description	Dimensions	Color	Price
054157	K-2293-1-0	1-Hole Complete	22-1/4" x 18-1/4" x 34-7/8"	White	
142950	K-2293-1-47	1-Hole Complete	22-1/4" x 18-1/4" x 34-7/8"	Almond	
087456	K-2293-1-96	1-Hole Complete	22-1/4" x 18-1/4" x 34-7/8"	Biscuit	
053458	K-2293-4-0	4"cc Complete	22-1/4" x 18-1/4" x 34-7/8"	White	
059695	K-2293-4-47	4"cc Complete	22-1/4" x 18-1/4" x 34-7/8"	Almond	
062693	K-2293-4-96	4"cc Complete	22-1/4" x 18-1/4" x 34-7/8"	Biscuit	
053459	K-2293-8-0	8"cc Complete	22-1/4" x 18-1/4" x 34-7/8"	White	
073773	K-2293-8-47	8"cc Complete	22-1/4" x 18-1/4" x 34-7/8"	Almond	
055800	K-2293-8-96	8"cc Complete	22-1/4" x 18-1/4" x 34-7/8"	Biscuit	

Console Table Legs

Kathryn® Table Legs

- Square tapered fireclay table legs
- Set of (2) legs
- Combines with Kathryn® console tabletops
- Includes leg-leveling hardware



Part #	Mfg #	Description	Dimensions	Color	Price
084795	K-2318-0	Console Legs Only	3-1/4" x 3-1/4" x 31-7/8"	White	
176951	K-2318-7	Console Legs Only	3-1/4" x 3-1/4" x 31-7/8"	Black	
074474	K-2318-96	Console Legs Only	3-1/4" x 3-1/4" x 31-7/8"	Biscuit	



Pedestal Lavatories

Pedestal Lavatories

Allerton™ Vitreous China Pedestal Lavatory

- Concealed front overflow
- Faucet sold separately



22-565 Combination: 12-565 Petite Basin, 29-843 Pedestal Base

22-569 Combination: 12-569 Petite Basin, 29-843 Pedestal Base

22-575 Combination: 12-575 Basin, 29-843 Pedestal Base

22-579 Combination: 12-579 Basin, 29-843 Pedestal Base

Part #	Mfg #	Description	Dimensions	Color	Price
151172	22-579	8"cc Complete	25-1/2" x 21" x 35"	Bone/Wheat	

Blaze Vitreous China Pedestal Lavatory

- Concealed front overflow
- Faucet sold separately



22-512 Combination: 12-512 Lavatory, 29-848 Pedestal Base

22-515 Combination: 12-515 Lavatory, 29-848 Pedestal Base

22-519 Combination: 12-519 Lavatory, 29-848 Pedestal Base

Part #	Mfg #	Description	Dimensions	Color	Price
173723	22-512	Single Hole Complete	23-7/8" x 20-1/4" x 35-1/8"	White	
189167	22-519	8"cc Complete	23-7/8" x 20-1/4" x 35-1/8"	White	

Brianne Vitreous China Pedestal Lavatory

- Concealed front overflow
- Faucet sold separately



22-535 Combination: 12-535 Lavatory, 29-846 Pedestal

Part #	Mfg #	Description	Dimensions	Color	Price
104938	22-535	4"cc Complete	23-7/8" x 19-3/4" x 35-3/4"	White	
172792	22-535-09	4"cc Complete	23-7/8" x 19-3/4" x 35-3/4"	Biscuit	



Pedestal Lavatories

Lavatories

La Mer™ Vitreous China Pedestal Lavatory

- Back overflow
- 1-Piece wall hanger
- Combined height with standard pedestal: 32"
- Combined height with extended pedestal: 36"
- Faucet sold separately



22-554 Combination: 12-544 Basin, 29-840 Pedestal Base

22-554

Part #	Mfg #	Description	Dimensions	Color	Price
004623	22-554	4"cc Complete	32" x 24" x 20"	White	

La Mer™ Petite Vitreous China Pedestal Lavatory

- Back overflow
- 1-Piece wall hanger
- Combined height with standard pedestal: 32"
- Combined height with extended pedestal: 36"
- Faucet sold separately



22-534 Combination: 12-524 Basin, 29-840 Pedestal

22-534

Part #	Mfg #	Description	Dimensions	Color	Price
004619	22-534	4"cc Complete	31-3/4" x 20" x 17-1/4"	White	

La Rive™ Vitreous China Pedestal Lavatory

- Back overflow
- 1-Piece wall hanger
- Combined height with standard pedestal: 32"
- Combined height with extended pedestal: 36"
- Faucet sold separately



22-574 Combination: 12-564 Basin, 29-840 Pedestal

22-574

22-578 Combination: 12-568 Basin, 29-840 Pedestal

Part #	Mfg #	Description	Dimensions	Color	Price
107189	22-571	Single-Hole Complete	32" x 25-1/2" x 21-1/2"	White	
004631	22-574	4"cc Complete	32" x 25-1/2" x 21-1/2"	White	
004636	22-578	8"cc Complete	32" x 25-1/2" x 21-1/2"	White	

Logan Square™ Vitreous China Lavatory

- Square pedestal leg
- Wash basin with large deck space



22-555 Combination: 12-555 Petite Basin, 29-847 Pedestal

22-559 Combination: 12-559 Petite Basin, 29-847 Pedestal

22-585 Combination: 12-585 Basin, 29-847 Pedestal

Part #	Mfg #	Description	Dimensions	Color	Price
125088	22-555	4"cc Petite Complete	34-1/2" x 24-1/4" x 20-1/8"	White	



Pedestal Lavatories

Pedestal Lavatories (Continued) Logan Square™ Vitreous China Lavatory

Part #	Mfg #	Description	Dimensions	Color	Price
129816	22-559	8"cc Petite Complete	34-1/2" x 24-1/4" x 20-1/8"	White	
145105	22-585	4"cc Complete	35" x 27-3/8" x 21-1/4"	White	
154768	22-585-09	4"cc Complete	35" x 27-3/8" x 21-1/4"	Biscuit	

Maxwell™ Vitreous China Pedestal Lavatory

- *Concealed front overflow*
- *Discrete backslash*
- *Faucet sold separately*



22-504 Combination: 12-504 Basin, 29-842 Pedestal Base

22-514 Combination: 12-514 Basin, 29-842 Pedestal Base

Part #	Mfg #	Description	Dimensions	Color	Price
080412	12-504	4"cc Lavatory Basin	20-7/16" x 17-3/4"	White	
080413	12-514	4"cc Lavatory Basin	25-1/2" x 20-1/2"	White	

Lavatories

Pedestal Lavatories

Lavatories

Vitreous China Pedestal Lavatories

Sacramento™ Pedestal Lavatory

- 34" Height installed
- Faucet sold separately
- Limited 5-year warranty

442124 Complete: 448120 Pedestal Leg, 446124 Lavatory Basin



Part #	Mfg #	Description	Dimensions	Color	Price
081841	446124-0	4"cc Lavatory Basin	21-1/4" x 18-1/4"	White	
098213	446124-96	4"cc Lavatory Basin	21-1/4" x 18-1/4"	Biscuit	
081842	448120-0	Pedestal Leg	-	White	
098214	448120-96	Pedestal Leg	-	Biscuit	

Southampton® Pedestal Lavatory

- Oval basin
- With overflow
- Vitreous China

442421 Complete: 448420 Pedestal Leg, 446421 Lavatory Basin



Part #	Mfg #	Description	Dimensions	Color	Price
190056	442421-0	1-Hole Lavatory Basin	23-3/8" x 18-1/4"	White	

Pedestal Lavatories

Pedestal Lavatories Alto IV Pedestal Lavatory

- *Concealed front overflow*
- *34-1/4" High*
- *Available in single hole, 4" or 8" faucet centers*

290 Combination: 292 Lav Basin, 293 Pedestal



Lavatories

Part #	Mfg #	Description	Dimensions	Color	Price
192330	290-4-WH	4"cc Complete	25" x 19"	White	
192343	240-4-BI	4"cc Complete	25" x 19"	Biscuit	
192331	290-4-BN	4"cc Complete	25" x 19"	Bone	
192332	290-8-WH	8"cc Complete	25" x 19"	White	
193220	290-8-BI	8"cc Complete	25" x 19"	Biscuit	
192333	290-8-BN	8"cc Complete	25" x 19"	Bone	

Top-Mount Lavatories

Vitreous China Drop-In Lavatories

Archer® Drop-In Lavatory — 22-5/8" x 19-7/16"

- Basin depth: 7-7/8"
- Overflow drain



Lavatories

Part #	Mfg #	Description	Dimensions	Color	Price
108558	K-2356-1-0	1-Hole Basin	22-5/8" x 19-7/16"	White	
120714	K-2356-1-7	1-Hole Basin	22-5/8" x 19-7/16"	Black	
222345	K-2356-1-95	1-Hole Basin	22-5/8" x 19-7/16"	Ice Grey	
120952	K-2356-1-96	1-Hole Basin	22-5/8" x 19-7/16"	Biscuit	
129535	K-2356-1-G9	1-Hole Basin	22-5/8" x 19-7/16"	Sandbar	
113055	K-2356-4-0	4"cc Basin	22-5/8" x 19-7/16"	White	
126193	K-2356-4-47	4"cc Basin	22-5/8" x 19-7/16"	Almond	
120951	K-2356-4-96	4"cc Basin	22-5/8" x 19-7/16"	Biscuit	
168556	K-2356-4-G9	4"cc Basin	22-5/8" x 19-7/16"	Sandbar	
106901	K-2356-8-0	8"cc Basin	22-5/8" x 19-7/16"	White	
183028	K-2356-8-33	8"cc Basin	22-5/8" x 19-7/16"	Mexican Sand	
115709	K-2356-8-47	8"cc Basin	22-5/8" x 19-7/16"	Almond	
173462	K-2356-8-7	8"cc Basin	22-5/8" x 19-7/16"	Black	
110694	K-2356-8-96	8"cc Basin	22-5/8" x 19-7/16"	Biscuit	
153621	K-2356-8-K4	8"cc Basin	22-5/8" x 19-7/16"	Cashmere	
162843	K-2356-8-NY	8"cc Basin	22-5/8" x 19-7/16"	Dune	

Brookline™ Drop-In Lavatory — 19" Diameter

- Includes sealant
- Basin depth: 8-3/8"



Part #	Mfg #	Description	Dimensions	Color	Price
068028	K-2202-1-0	1-Hole ADA Basin	19" Diameter	White	
126768	K-2202-1-47	1-Hole ADA Basin	19" Diameter	Almond	
058332	K-2202-1-96	1-Hole ADA Basin	19" Diameter	Biscuit	
055055	K-2202-4-0	4"cc ADA Basin	19" Diameter	White	
054045	K-2202-4-47	4"cc ADA Basin	19" Diameter	Almond	
063996	K-2202-4-7	4"cc ADA Basin	19" Diameter	Black	
125579	K-2202-4-95	4"cc ADA Basin	19" Diameter	Ice Grey	
055056	K-2202-4-96	4"cc ADA Basin	19" Diameter	Biscuit	
167310	K-2202-4-NY	4"cc ADA Basin	19" Diameter	Dune	
055057	K-2202-8-0	8"cc ADA Basin	19" Diameter	White	
055058	K-2202-8-96	8"cc ADA Basin	19" Diameter	Biscuit	

Top-Mount Lavatories

Bryant® Oval Drop-In Lavatory — 20-1/8" x 16-1/2"

- With overflow
- Basin depth: 7-5/8"



Part #	Mfg #	Description	Dimensions	Color	Price
144885	K-2699-1-0	1-Hole ADA Basin	20-1/8" x 16-1/2"	White	
148761	K-2699-1-96	1-Hole ADA Basin	20-1/8" x 16-1/2"	Biscuit	
138046	K-2699-4-0	4"cc ADA Basin	20-1/8" x 16-1/2"	White	
149239	K-2699-4-47	4"cc ADA Basin	20-1/8" x 16-1/2"	Almond	
158644	K-2699-4-96	4"cc ADA Basin	20-1/8" x 16-1/2"	Biscuit	
144886	K-2699-8-0	8"cc ADA Basin	20-1/8" x 16-1/2"	White	
152703	K-2699-8-47	8"cc ADA Basin	20-1/8" x 16-1/2"	Almond	
175100	K-2699-8-K4	8"cc ADA Basin	20-1/8" x 16-1/2"	Cashmere	

Bryant® Drop-In Lavatory — 18-7/8" x 18-7/8" x 7-5/8"

- With overflow
- Basin depth: 7-5/8"



Part #	Mfg #	Description	Dimensions	Color	Price
156185	K-2714-1-0	1-Hole ADA Basin	18-7/8" x 18-7/8" x 7-5/8"	White	
145729	K-2714-4-0	4"cc ADA Basin	18-7/8" x 18-7/8" x 7-5/8"	White	
144033	K-2714-4-96	4"cc ADA Basin	18-7/8" x 18-7/8" x 7-5/8"	Biscuit	
149508	K-2714-8-0	8"cc ADA Basin	18-7/8" x 18-7/8" x 7-5/8"	White	
167172	K-2714-8-58	8"cc ADA Basin	18-7/8" x 18-7/8" x 7-5/8"	Thunder Grey	

Centerpiece® Drop-In Bathroom Sink with Tale of Briar Rose Design — 25" x 17"

- Decorated with climbing roses and fairy tale verses on biscuit background
- No faucet holes
- Without overflow
- Basin depth: 7"



Part #	Mfg #	Description	Dimensions	Color	Price
182408	K-14274-BR-96	Less Faucet Holes, ADA Basin	25" x 17"	Biscuit	

Cimarron® Drop-In Lavatory — 23" x 18-3/16"

- Basin depth: 7-7/8"
- Faucet sold separately



Part #	Mfg #	Description	Dimensions	Color	Price
137765	K-2351-1-0	1-Hole ADA Basin	23" x 18-3/16"	White	
183026	K-2351-1-7	1-Hole ADA Basin	23" x 18-3/16"	Black	
134801	K-2351-1-96	1-Hole ADA Basin	23" x 18-3/16"	Biscuit	
105732	K-2351-1-G9	1-Hole ADA Basin	23" x 18-3/16"	Sandbar	
093837	K-2351-4-0	4"cc ADA Basin	23" x 18-3/16"	White	
106200	K-2351-4-95	4"cc ADA Basin	23" x 18-3/16"	Ice Grey	
112659	K-2351-4-96	4"cc ADA Basin	23" x 18-3/16"	Biscuit	

Top-Mount Lavatories

Vitreous China Drop-In Lavatories (Continued)

Cimarron® Drop-In Lavatory — 23" x 18-3/16"

Part #	Mfg #	Description	Dimensions	Color	Price
093838	K-2351-8-0	8"cc ADA Basin	23" x 18-3/16"	White	
107929	K-2351-8-47	8"cc ADA Basin	23" x 18-3/16"	Almond	
141462	K-2351-8-95	8"cc ADA Basin	23" x 18-3/16"	Ice Grey	
111716	K-2351-8-96	8"cc ADA Basin	23" x 18-3/16"	Biscuit	
123483	K-2351-8-G9	8"cc ADA Basin	23" x 18-3/16"	Sandbar	

Compass® Drop-In/Under-Mount Lavatory

- 13-1/4" Diameter
- No faucet holes
- Basin depth: 7"



Part #	Mfg #	Description	Dimensions	Color	Price
060819	K-2298-0	Less Faucet Holes, ADA Basin	13-1/4" x 13-1/4"	White	

Devonshire® Drop-In Lavatory

- With overflow
- 19-3/4" x 16-7/8"
- Water depth: 4-1/2"



Part #	Mfg #	Description	Dimensions	Color	Price
123003	K-2779-1-96	1-Hole ADA Basin	19-3/4" x 16-7/8"	Biscuit	
054173	K-2779-4-0	4"cc ADA Basin	19-3/4" x 16-7/8"	White	
059953	K-2779-8-0	8"cc ADA Basin	19-3/4" x 16-7/8"	White	

Ellington® Drop-In Lavatory

- With overflow
- Basin Depth: 8-7/16"



Part #	Mfg #	Description	Dimensions	Color	Price
057767	K-2906-1-0	1-Hole ADA Basin	19-1/4" x 16/1/4"	White	
152957	K-2906-1-47	1-Hole ADA Basin	19-1/4" x 16/1/4"	Almond	
175950	K-2906-1-58	1-Hole ADA Basin	19-1/4" x 16/1/4"	Thunder Grey	
222810	K-2906-1-95	1-Hole ADA Basin	19-1/4" x 16/1/4"	Ice Grey	
101756	K-2906-1-96	1-Hole ADA Basin	19-1/4" x 16/1/4"	Biscuit	
120280	K-2906-1-G9	1-Hole ADA Basin	19-1/4" x 16/1/4"	Sandbar	
068536	K-2906-4-0	4"cc ADA Basin	19-1/4" x 16/1/4"	White	
064991	K-2906-4-47	4"cc ADA Basin	19-1/4" x 16/1/4"	Almond	
081146	K-2906-4-95	4"cc ADA Basin	19-1/4" x 16/1/4"	Ice Grey	
064874	K-2906-4-96	4"cc ADA Basin	19-1/4" x 16/1/4"	Biscuit	
082936	K-2906-4-G9	4"cc ADA Basin	19-1/4" x 16/1/4"	Sandbar	
067824	K-2906-8-0	8"cc ADA Basin	19-1/4" x 16/1/4"	White	
182434	K-2906-8-33	8"cc ADA Basin	19-1/4" x 16/1/4"	Mexican Sand	
163310	K-2906-8-47	8"cc ADA Basin	19-1/4" x 16/1/4"	Almond	

Top-Mount Lavatories

Vitreous China Drop-In Lavatories (Continued) Ellington® Drop-In Lavatory

Part #	Mfg #	Description	Dimensions	Color	Price
076616	K-2906-8-58	8"cc ADA Basin	19-1/4" x 16/1/4"	Thunder Grey	
056181	K-2906-8-96	8"cc ADA Basin	19-1/4" x 16/1/4"	Biscuit	

Escale® Drop-In Lavatory — 23-5/8" x 17-1/2"

- Round-in-square shape
- Overflow drain
- Fireclay



Part #	Mfg #	Description	Dimensions	Color	Price
109645	K-19029-1-0	1-Hole Basin	23-5/8" x 17-1/2"	White	
154375	K-19029-1-96	1-Hole Basin	23-5/8" x 17-1/2"	Biscuit	
103109	K-19029-8-0	8"cc Basin	23-5/8" x 17-1/2"	White	
103110	K-19029-8-96	8"cc Basin	23-5/8" x 17-1/2"	Biscuit	

Intaglio® Drop-In Lavatory — 17" x 14" x 8-1/4"

- Centered drain
- No faucet holes; requires wall- or counter-mount faucet



Part #	Mfg #	Description	Dimensions	Color	Price
060596	K-2292-0	No Faucet Deck	17" x 14" x 8-1/4"	White	
056884	K-2292-96	No Faucet Deck	17" x 14" x 8-1/4"	Biscuit	

Kathryn® Drop-In Lavatory — 24" x 19"

- Overflow drain
- Rectangular basin



Part #	Mfg #	Description	Dimensions	Color	Price
185584	K-2325-1-0	1-Hole Basin	24" x 19"	White	
085171	K-2325-8-0	8"cc	24" x 19"	White	

Kelston® Drop-in Lavatory — 23-7/16" x 20-11/16" x 5-5/16"

- Uniquely-shaped shallow basin
- Overflow drain



Part #	Mfg #	Description	Dimensions	Color	Price
116589	K-2381-1-0	1-Hole ADA Shallow Basin	23-7/16" x 20-11/16" x 5-5/16"	White	
183030	K-2381-1-96	1-Hole ADA Shallow Basin	23-7/16" x 20-11/16" x 5-5/16"	Biscuit	
123867	K-2381-4-0	4"cc ADA Shallow Basin	23-7/16" x 20-11/16" x 5-5/16"	White	
183031	K-2381-4-7	4"cc ADA Shallow Basin	23-7/16" x 20-11/16" x 5-5/16"	Black	
168214	K-2381-4-G9	4"cc ADA Shallow Basin	23-7/16" x 20-11/16" x 5-5/16"	Sandbar	
118000	K-2381-4-96	4"cc ADA Shallow Basin	23-7/16" x 20-11/16" x 5-5/16"	Biscuit	

Top-Mount Lavatories

Vitreous China Drop-In Lavatories (Continued)

Kelston® Drop-in Lavatory — 23-7/16" x 20-11/16" x 5-5/16"

Part #	Mfg #	Description	Dimensions	Color	Price
111713	K-2381-8-0	8"cc ADA Shallow Basin	23-7/16" x 20-11/16" x 5-5/16"	White	
129226	K-2381-8-47	8"cc ADA Shallow Basin	23-7/16" x 20-11/16" x 5-5/16"	Almond	
183032	K-2381-8-7	8"cc ADA Shallow Basin	23-7/16" x 20-11/16" x 5-5/16"	Black	
180965	K-2381-8-95	8"cc ADA Shallow Basin	23-7/16" x 20-11/16" x 5-5/16"	Ice Grey	

Memoirs® Classic Drop-In Lavatory — 22-3/4" x 18"

- Overflow drain
- Faucet sold separately



Part #	Mfg #	Description	Dimensions	Color	Price
071265	K-2241-1-0	1-Hole Classic Basin	22-3/4" x 18"	White	
059006	K-2241-1-96	1-Hole Classic Basin	22-3/4" x 18"	Biscuit	
117169	K-2241-1-G9	1-Hole Classic Basin	22-3/4" x 18"	Sandbar	
057383	K-2241-4-0	4"cc Classic Basin	22-3/4" x 18"	White	
073661	K-2241-4-47	4"cc Classic Basin	22-3/4" x 18"	Almond	
230599	K-2241-4-7	4"cc Classic Basin	22-3/4" x 18"	Black	
057286	K-2241-4-95	4"cc Classic Basin	22-3/4" x 18"	Ice Grey	
065803	K-2241-4-96	4"cc Classic Basin	22-3/4" x 18"	Biscuit	
080539	K-2241-4-G9	4"cc Classic Basin	22-3/4" x 18"	Sandbar	
054529	K-2241-8-0	8"cc Classic Basin	22-3/4" x 18"	White	
085023	K-2241-8-33	8"cc Classic Basin	22-3/4" x 18"	Mexican Sand	
105463	K-2241-8-47	8"cc Classic Basin	22-3/4" x 18"	Almond	
074564	K-2241-8-7	8"cc Classic Basin	22-3/4" x 18"	Black	
075333	K-2241-8-95	8"cc Classic Basin	22-3/4" x 18"	Ice Grey	
056477	K-2241-8-96	8"cc Classic Basin	22-3/4" x 18"	Biscuit	
074958	K-2241-8-G9	8"cc Classic Basin	22-3/4" x 18"	Sandbar	
231997	K-2241-8-NY	8"cc Classic Basin	22-3/4" x 18"	Dune	

Memoirs® Stately Drop-In Lavatory — 22-3/4" x 18"

- Basin depth: 8-7/8"
- Faucet sold separately



Part #	Mfg #	Description	Dimensions	Color	Price
097048	K-2337-1-0	Single Hole Basin	22-3/4" x 18"	White	
126404	K-2337-1-47	Single Hole Basin	22-3/4" x 18"	Almond	
119528	K-2337-1-96	Single Hole Basin	22-3/4" x 18"	Biscuit	
092002	K-2337-4-0	4"cc Stately Basin	22-3/4" x 18"	White	
131030	K-2337-4-47	4"cc Stately Basin	22-3/4" x 18"	Almond	
171844	K-2337-4-58	4"cc Stately Basin	22-3/4" x 18"	Thunder Grey	
100605	K-2337-4-95	4"cc Stately Basin	22-3/4" x 18"	Ice Grey	

Top-Mount Lavatories

Vitreous China Drop-In Lavatories (Continued)

Memoirs® Stately Drop-In Lavatory — 22-3/4" x 18"

Part #	Mfg #	Description	Dimensions	Color	Price
093771	K-2337-4-96	4"cc Stately Basin	22-3/4" x 18"	Biscuit	
093018	K-2337-8-0	8"cc Stately Basin	22-3/4" x 18"	White	
128945	K-2337-8-47	8"cc Stately Basin	22-3/4" x 18"	Almond	
153587	K-2337-8-95	8"cc Stately Basin	22-3/4" x 18"	Ice Grey	
093518	K-2337-8-96	8"cc Stately Basin	22-3/4" x 18"	Biscuit	

Pennington™ Drop-In Lavatory Basin — 20-1/4" x 17-1/2"

- Includes sealant
- Basin depth: 8-1/2"
- Faucet sold separately



Part #	Mfg #	Description	Dimensions	Color	Price
055265	K-2196-1-0	1-Hole ADA Basin	20-1/4" x 17-1/2"	White	
055266	K-2196-1-47	1-Hole ADA Basin	20-1/4" x 17-1/2"	Almond	
060407	K-2196-1-7	1-Hole ADA Basin	20-1/4" x 17-1/2"	Black	
145417	K-2196-1-95	1-Hole ADA Basin	20-1/4" x 17-1/2"	Ice Grey	
059748	K-2196-1-96	1-Hole ADA Basin	20-1/4" x 17-1/2"	Biscuit	
167308	K-2196-1-NY	1-Hole ADA Basin	20-1/4" x 17-1/2"	Dune	
053189	K-2196-4-0	4"cc ADA Basin	20-1/4" x 17-1/2"	White	
055714	K-2196-4-47	4"cc ADA Basin	20-1/4" x 17-1/2"	Almond	
056391	K-2196-4-7	4"cc ADA Basin	20-1/4" x 17-1/2"	Black	
060550	K-2196-4-95	4"cc ADA Basin	20-1/4" x 17-1/2"	Ice Grey	
053308	K-2196-4-96	4"cc ADA Basin	20-1/4" x 17-1/2"	Biscuit	
174325	K-2196-4-G9	4"cc ADA Basin	20-1/4" x 17-1/2"	Sandbar	
053190	K-2196-8-0	8"cc ADA Basin	20-1/4" x 17-1/2"	White	
057960	K-2196-8-47	8"cc ADA Basin	20-1/4" x 17-1/2"	Almond	
086833	K-2196-8-7	8"cc ADA Basin	20-1/4" x 17-1/2"	Black	
069228	K-2196-8-95	8"cc ADA Basin	20-1/4" x 17-1/2"	Ice Grey	
053309	K-2196-8-96	8"cc ADA Basin	20-1/4" x 17-1/2"	Biscuit	

Portrait® Drop-In Lavatory Basin — 22-5/8" x 18-7/8"

- Includes sealant
- Basin depth: 8-7/8"
- Faucet sold separately



Part #	Mfg #	Description	Dimensions	Color	Price
067661	K-2189-1-0	Single Hole Basin	22-5/8" x 18-7/8"	White	
053289	K-2189-8-96	8"cc ADA Basin	22-5/8" x 18-7/8"	Biscuit	

Top-Mount Lavatories

Serif® Drop-In Lavatory Basin — 22-1/8" x 16-1/4"

- Oval basin
- Overflow drain



Part #	Mfg #	Description	Dimensions	Color	Price
073654	K-2075-1-0	Single Hole Basin	22-1/8" x 16-1/4"	White	
094721	K-2075-1-47	Single Hole Basin	22-1/8" x 16-1/4"	Almond	
103900	K-2075-1-7	Single Hole Basin	22-1/8" x 16-1/4"	Black	
071837	K-2075-1-96	Single Hole Basin	22-1/8" x 16-1/4"	Biscuit	
078604	K-2075-4-0	4"cc Basin	22-1/8" x 16-1/4"	White	
090338	K-2075-4-47	4"cc Basin	22-1/8" x 16-1/4"	Almond	
080582	K-2075-4-96	4"cc Basin	22-1/8" x 16-1/4"	Biscuit	
076847	K-2075-8-0	8"cc Basin	22-1/8" x 16-1/4"	White	
080055	K-2075-8-47	8"cc Basin	22-1/8" x 16-1/4"	Almond	
084548	K-2075-8-7	8"cc Basin	22-1/8" x 16-1/4"	Black	
126410	K-2075-8-95	8"cc Basin	22-1/8" x 16-1/4"	Ice Grey	
074100	K-2075-8-96	8"cc Basin	22-1/8" x 16-1/4"	Biscuit	
227479	K-2075-8-NY	8"cc Basin	22-1/8" x 16-1/4"	Dune	

Tresham® Drop-In Lavatory Basin — 21-13/16" x 16-9/16"

- Basin depth: 8"
- Rectangular basin with raised rim
- Overflow drain



Part #	Mfg #	Description	Dimensions	Color	Price
150616	K-2991-1-0	Single Hole Basin	21-13/16" x 16-9/16"	White	
173996	K-2991-1-7	Single Hole Basin	21-13/16" x 16-9/16"	Black	
154591	K-2991-1-95	Single Hole Basin	21-13/16" x 16-9/16"	Ice Grey	
175376	K-2991-4-0	4"cc Basin	21-13/16" x 16-9/16"	White	
156201	K-2991-4-96	4"cc Basin	21-13/16" x 16-9/16"	Biscuit	
146103	K-2991-8-0	8"cc Basin	21-13/16" x 16-9/16"	White	
183561	K-2991-8-47	8"cc Basin	21-13/16" x 16-9/16"	Almond	
144318	K-2991-8-96	8"cc Basin	21-13/16" x 16-9/16"	Biscuit	

Tresham® Drop-In Lavatory Basin — 22-13/16" x 19-1/4"

- Basin depth: 8-3/4"
- Oval basin with raised rim
- Overflow drain



Part #	Mfg #	Description	Dimensions	Color	Price
228008	K-2992-1-96	Single Hole Basin	22-13/16" x 19-1/4"	Biscuit	
172665	K-2992-4-47	4"cc Basin	22-13/16" x 19-1/4"	Almond	
160351	K-2992-4-96	4"cc Basin	22-13/16" x 19-1/4"	Biscuit	
156862	K-2992-8-0	8"cc Basin	22-13/16" x 19-1/4"	White	

Top-Mount Lavatories

Vintage® Drop-In Lavatory with Mille Fleurs™ Design — 24" x 15"

- Decorated with a blossom and bird pattern with gold and platinum accents on almond background
- Oval basin
- No faucet holes; requires wall- or counter-mount faucet
- Overflow drain



Part #	Mfg #	Description	Dimensions	Color	Price
177864	K-14272-T9-47	ADA Basin, Less Faucet Holes	24" x 15"	Almond	

Yin Yang® Wading Pool® Drop-In Lavatory Basin — 21-5/16" x 18-1/16"

- Shallow basin
- Overflow drain



Part #	Mfg #	Description	Dimensions	Color	Price
112666	K-2354-1-0	Single Hole Basin	21-5/16" x 18-1/16"	White	
183027	K-2354-1-7	Single Hole Basin	21-5/16" x 18-1/16"	Black	
108912	K-2354-8-0	8"cc Basin	21-5/16" x 18-1/16"	White	
128285	K-2354-8-33	8"cc Basin	21-5/16" x 18-1/16"	Mexican Sand	

Cast Iron Drop-In Lavatories

ADA - Compliant when installed according to the Accessibility Guidelines, Section 606 Lavatories and Mirrors, of the Act

Dolce Vita® Drop-In Lavatory — 17-1/2" x 17-1/2"

- Cast iron
- Basin depth: 7-7/8"
- No faucet holes



Part #	Mfg #	Description	Dimensions	Color	Price
074293	K-2815-0	No Faucet Holes	17-1/2" x 17-1/2"	White	
103638	K-2815-96	No Faucet Holes	17-1/2" x 17-1/2"	Biscuit	
098368	K-2815-KC	No Faucet Holes	17-1/2" x 17-1/2"	Vapour Blue	
153091	K-2815-KG	No Faucet Holes	17-1/2" x 17-1/2"	Vapour Green	

Farmington™ Drop-In Lavatory Basin — 19-1/4" x 16-1/4"

- Cast iron
- With overflow
- Basin depth: 8-3/4"
- Faucet sold separately



Part #	Mfg #	Description	Dimensions	Color	Price
070879	K-2905-1-0	1-Hole ADA Basin	19-1/4" x 16-1/4"	White	
185225	K-2905-1-7	1-Hole ADA Basin	19-1/4" x 16-1/4"	Black Black	
181571	K-2905-1-95	1-Hole ADA Basin	19-1/4" x 16-1/4"	Ice Grey	
175393	K-2905-1-FD	1-Hole ADA Basin	19-1/4" x 16-1/4"	Cane Sugar	
053226	K-2905-4-0	4"cc ADA Basin	19-1/4" x 16-1/4"	White	
061510	K-2905-4-95	4"cc ADA Basin	19-1/4" x 16-1/4"	Ice Grey	

Top-Mount Lavatories

Cast Iron Drop-In Lavatories (Continued)

Farmington™ Drop-In Lavatory Basin — 19-1/4" x 16-1/4"

Part #	Mfg #	Description	Dimensions	Color	Price
061188	K-2905-4-96	4"cc ADA Basin	19-1/4" x 16-1/4"	Biscuit	
053227	K-2905-8-0	8"cc ADA Basin	19-1/4" x 16-1/4"	White	
183560	K-2905-8-20	8"cc ADA Basin	19-1/4" x 16-1/4"	Suede	
085239	K-2905-8-47	8"cc ADA Basin	19-1/4" x 16-1/4"	Almond	
054907	K-2905-8-96	8"cc ADA Basin	19-1/4" x 16-1/4"	Biscuit	

Iron/Tones™ Drop-In/Under-Mount Lavatory Basin

- Cast iron
- Without overflow
- Top-mount or under-mount
- No faucet holes



16"
16-3/8" X 15-5/8" X 5-3/4"

Part #	Mfg #	Description	Dimensions	Color	Price
108554	K-2827-0	No Faucet Holes	16-3/8" x 15-5/8" x 5-3/4"	White	
103512	K-2827-47	No Faucet Holes	16-3/8" x 15-5/8" x 5-3/4"	Almond	
109651	K-2827-96	No Faucet Holes	16-3/8" x 15-5/8" x 5-3/4"	Biscuit	
152348	K-2827-FD	No Faucet Holes	16-3/8" x 15-5/8" x 5-3/4"	Cane Sugar	
119872	K-2827-FF	No Faucet Holes	16-3/8" x 15-5/8" x 5-3/4"	Sea Salt	
118085	K-2827-FT	No Faucet Holes	16-3/8" x 15-5/8" x 5-3/4"	Basalt	
183036	K-2827-KA	No Faucet Holes	16-3/8" x 15-5/8" x 5-3/4"	Black n' Tan	

24"
24-3/4" x 15-5/8" x 5-7/8"

Part #	Mfg #	Description	Dimensions	Color	Price
111048	K-2826-0	No Faucet Holes	24-3/4" x 15-5/8" x 5-7/8"	White	
116918	K-2826-96	No Faucet Holes	24-3/4" x 15-5/8" x 5-7/8"	Biscuit	
136195	K-2826-FF	No Faucet Holes	24-3/4" x 15-5/8" x 5-7/8"	Sea Salt	

Man's Lav™ Drop-In Lavatory Basin

- Cast iron
- Overflow drain
- Sloped rectangular basin



Part #	Mfg #	Description	Dimensions	Color	Price
069098	K-2885-1-0	1-Hole	28" x 19"	White	
182425	K-2885-1-47	1-Hole	28" x 19"	Almond	
071977	K-2885-1-96	1-Hole	28" x 19"	Biscuit	
072713	K-2885-8-0	8"cc	28" x 19"	White	
069309	K-2885-8-47	8"cc	28" x 19"	Almond	
075667	K-2885-8-96	8"cc	28" x 19"	Biscuit	

Top-Mount Lavatories

Maratea® Drop-In Lavatory Basin — 22-1/2" x 17-1/16"

- Basin depth: 6-1/2"
- Enameled cast iron



Part #	Mfg #	Description	Dimensions	Color	Price
098416	K-2831-1-0	Single Hole Basin	22-1/2" x 17-1/16"	White	
092620	K-2831-1-96	Single Hole Basin	22-1/2" x 17-1/16"	Biscuit	
113054	K-2831-1-FD	Single Hole Basin	22-1/2" x 17-1/16"	Cane Sugar	
128359	K-2831-1-FF	Single Hole Basin	22-1/2" x 17-1/16"	Sea Salt	
119106	K-2831-1-FT	Single Hole Basin	22-1/2" x 17-1/16"	Basalt	
103230	K-2831-4-0	4"cc Basin	22-1/2" x 17-1/16"	White	
126769	K-2831-4-47	4"cc Basin	22-1/2" x 17-1/16"	Almond	
092770	K-2831-4-96	4"cc Basin	22-1/2" x 17-1/16"	Biscuit	
153825	K-2831-4-FT	4"cc Basin	22-1/2" x 17-1/16"	Basalt	
116541	K-2831-8-0	8"cc Basin	22-1/2" x 17-1/16"	White	
160516	K-2831-8-47	8"cc Basin	22-1/2" x 17-1/16"	Almond	
119146	K-2831-8-96	8"cc Basin	22-1/2" x 17-1/16"	Biscuit	

Radiant® Drop-In Lavatory Basin — 19" x 19" x 8-5/8"

- Cast iron
- Overflow drain



Part #	Mfg #	Description	Dimensions	Color	Price
059941	K-2917-1-0	1-Hole	19" x 19" x 8-5/8"	White	
054981	K-2917-4-0	4"cc	19" x 19" x 8-5/8"	White	
072091	K-2917-4-96	4"cc	19" x 19" x 8-5/8"	Biscuit	
104148	K-2917-4-G9	4"cc	19" x 19" x 8-5/8"	Sandbar	
062401	K-2917-8-0	8"cc	19" x 19" x 8-5/8"	White	

Tahoe® Drop-In Lavatory Basin

- Cast iron
- Overflow drain



Part #	Mfg #	Description	Dimensions	Color	Price
082817	K-2895-1-0	Single Hole Basin	21" x 19"	White	
079131	K-2895-1-96	Single Hole Basin	21" x 19"	Biscuit	
053224	K-2895-4-0	4"cc Basin	21" x 19"	White	
060570	K-2895-4-47	4"cc Basin	21" x 19"	Almond	
054160	K-2895-4-96	4"cc Basin	21" x 19"	Biscuit	
053225	K-2895-8-0	8"cc Basin	21" x 19"	White	
182430	K-2895-8-47	8"cc Basin	21" x 19"	Almond	
053655	K-2895-8-96	8"cc Basin	21" x 19"	Biscuit	

Top-Mount Lavatories

Tahoe® Drop-In Lavatory Basin For Use with Metal Frame

- Cast iron
- Overflow drain
- Metal frame installation



Part #	Mfg #	Description	Dimensions	Color	Price
056418	K-2890-4-0	4"cc Basin	20" x 18"	White	

Thoreau® Drop-In Lavatory Basin

- Cast iron
- Basin depth: 8-5/8"



Part #	Mfg #	Description	Dimensions	Color	Price
071237	K-2907-1-0	Single Hole Basin	24" x 18"	White	
066998	K-2907-1-96	Single Hole Basin	24" x 18"	Biscuit	
055598	K-2907-4-0	4"cc Basin	24" x 18"	White	
115615	K-2907-4-96	4"cc Basin	24" x 18"	Biscuit	
070319	K-2907-8-0	8"cc Basin	24" x 18"	White	
075011	K-2907-8-96	8"cc Basin	24" x 18"	Biscuit	

Tides® Drop-In Lavatory Basin

- Cast iron
- Undulating oval basin
- Basin depth: 9-5/16"



Part #	Mfg #	Description	Dimensions	Color	Price
139738	K-2839-1-0	1-Hole ADA Basin	20" x 17"	White	
140894	K-2839-1-96	1-Hole ADA Basin	20" x 17"	Biscuit	
168444	K-2839-1-FD	1-Hole ADA Basin	20" x 17"	Cane Sugar	
163954	K-2839-1-FF	1-Hole ADA Basin	20" x 17"	Sea Salt	
190405	K-2839-1-FT	1-Hole ADA Basin	20" x 17"	Basalt	
154304	K-2839-4-0	4"cc ADA Basin	20" x 17"	White	
185283	K-2839-4-7	4" cc ADA Basin	20" x 17"	Black Black	
155743	K-2839-4-96	4"cc ADA Basin	20" x 17"	Biscuit	
153428	K-2839-4-FF	4"cc ADA Basin	20" x 17"	Sea Salt	
147944	K-2839-8-0	8"cc ADA Basin	20" x 17"	White	
147713	K-2839-8-96	8"cc ADA Basin	20" x 17"	Biscuit	
145744	K-2839-8-FF	8"cc ADA Basin	20" x 17"	Sea Salt	

Top-Mount Lavatories

Vanity/Pedestal Tops

Archer® Pedestal Lavatory Top — 23-15/16" x 20-7/16"

- Overflow drain



Combines with K-2357 Pedestal to create the K-2359 Complete Pedestal Sink

Combines with K-2449 Petite Vanity to create Complete Console Vanity

Part #	Mfg #	Description	Dimensions	Color	Price
108318	K-2358-1-0	1-Hole Basin Only	23-15/16" x 20-7/16"	White	
148245	K-2358-1-33	1-Hole Basin Only	23-15/16" x 20-7/16"	Mexican Sand	
111191	K-2358-1-47	1-Hole Basin Only	23-15/16" x 20-7/16"	Almond	
119297	K-2358-1-96	1-Hole Basin Only	23-15/16" x 20-7/16"	Biscuit	
109457	K-2358-1-G9	1-Hole Basin Only	23-15/16" x 20-7/16"	Sandbar	
131153	K-2358-1-K4	1-Hole Basin Only	23-15/16" x 20-7/16"	Cashmere	
172850	K-2358-1-NY	1-Hole Basin Only	23-15/16" x 20-7/16"	Dune	
107988	K-2358-4-0	4"cc Basin Only	23-15/16" x 20-7/16"	White	
109348	K-2358-4-33	4"cc Basin Only	23-15/16" x 20-7/16"	Mexican Sand	
126510	K-2358-4-47	4"cc Basin Only	23-15/16" x 20-7/16"	Almond	
168115	K-2358-4-7	4"cc Basin Only	23-15/16" x 20-7/16"	Black	
174334	K-2358-4-95	4"cc Basin Only	23-15/16" x 20-7/16"	Ice Grey	
109538	K-2358-4-96	4"cc Basin Only	23-15/16" x 20-7/16"	Biscuit	
131490	K-2358-4-G9	4"cc Basin Only	23-15/16" x 20-7/16"	Sandbar	
120237	K-2358-4-K4	4"cc Basin Only	23-15/16" x 20-7/16"	Cashmere	
103425	K-2358-8-0	8"cc Basin Only	23-15/16" x 20-7/16"	White	
109350	K-2358-8-33	8"cc Basin Only	23-15/16" x 20-7/16"	Mexican Sand	
112763	K-2358-8-47	8"cc Basin Only	23-15/16" x 20-7/16"	Almond	
121247	K-2358-8-95	8"cc Basin Only	23-15/16" x 20-7/16"	Ice Grey	
110176	K-2358-8-96	8"cc Basin Only	23-15/16" x 20-7/16"	Biscuit	
111880	K-2358-8-G9	8"cc Basin Only	23-15/16" x 20-7/16"	Sandbar	
103537	K-2358-8-K4	8"cc Basin Only	23-15/16" x 20-7/16"	Cashmere	

Ceramic/Impressions™

- Vitreous china
- Integrated top and bowl
- Raised outer edge helps contain water and prevents items from rolling off the vanity top
- Overflow drain



25" x 22-3/8"

Part #	Mfg #	Description	Dimensions	Color	Price
185929	K-2777-1-G81	1-Hole, Rectangular Basin	25" x 22-3/8"	White	
183676	K-2777-8-G81	8"cc, Rectangular Basin	25" x 22-3/8"	White	

31" x 22-3/8"

Part #	Mfg #	Description	Dimensions	Color	Price
169471	K-2779-1-G81	1-Hole, Square Basin	31" x 22-3/8"	White	
166457	K-2779-1-G85	1-Hole, Square Basin	31" x 22-3/8"	Sandbar	
183556	K-2779-1-G88	1-Hole, Rectangular Basin	31" x 22-3/8"	Thunder Grey	

Top-Mount Lavatories

Lavatories

Vanity/Pedestal Tops (Continued)

Ceramic/Impressions™

31" x 22-3/8"

Part #	Mfg #	Description	Dimensions	Color	Price
173318	K-2779-8-G81	8"cc, Square Basin	31" x 22-3/8"	White	
175862	K-2779-8-G83	8"cc, Square Basin	31" x 22-3/8"	Biscuit	
183557	K-2779-8-G88	8"cc Rectangular Basin	31" x 22-3/8"	Thunder Grey	
176730	K-2796-1-G81	1-Hole, Oval Basin	31" x 22-3/8"	White	

37" x 22-3/8"

Part #	Mfg #	Description	Dimensions	Color	Price
168991	K-2781-1-G81	1-Hole, Square Basin	37" x 22-3/8"	White	
172777	K-2781-8-G81	8"cc, Square Basin	37" x 22-3/8"	White	
190351	K-2781-8-G83	8"cc Rectangular Basin	37" x 22-3/8"	Biscuit	
183558	K-2781-8-G88	8"cc Rectangular Basin	37" x 22-3/8"	Thunder Grey	
181473	K-2798-8-G81	8"cc, Oval Basin	37" x 22-3/8"	White	

49" x 22-3/8"

Part #	Mfg #	Description	Dimensions	Color	Price
180837	K-2783-1-G81	1-Hole, Square Basin	49" x 22-3/8"	White	
176807	K-2783-8-G81	8"cc, Square Basin	49" x 22-3/8"	White	
220820	K-2783-8-G86	8"cc, Square Basin	49" x 22-3/8"	Cashmere	
171288	K-2783-8-G88	8"cc, Square Basin	49" x 22-3/8"	Thunder Grey	
175679	K-2891-1-G81	1-Hole, Oval Basin	49" x 22-3/8"	White	

Iron/Impressions® Rectangular Basin Vanity-Top

- Cast iron
- Integrated top and bowl
- Sloped-wall rectangular basin
- Without overflow



31" x 22-1/4"

Part #	Mfg #	Description	Dimensions	Color	Price
156973	K-3049-1-47	1-Hole	31-5/8" x 22-1/4"	Almond	
137028	K-3049-1-FD	1-Hole	31-5/8" x 22-1/4"	Cane Sugar	
159483	K-3049-1-KA	1-Hole	31-5/8" x 22-1/4"	Black 'n Tan	
120079	K-3049-8-0	8"cc	31-5/8" x 22-1/4"	White	
108688	K-3049-8-96	8"cc	31-5/8" x 22-1/4"	Biscuit	
188540	K-3049-8-FD	8"cc	31-5/8" x 22-1/4"	Cane Sugar	
108656	K-3049-8-FF	8"cc	31-5/8" x 22-1/4"	Sea Salt	
107101	K-3049-8-KA	8"cc	31-5/8" x 22-1/4"	Black 'n Tan	

Top-Mount Lavatories

Iron/Impressions® Oval Basin Vanity-Top

- Cast iron
- Integrated top and bowl
- Sloped-wall oval basin
- Without overflow



25" x 22-1/4"

Part #	Mfg #	Description	Dimensions	Color	Price
181990	K-3048-1-FF	1-Hole	25-5/8" x 22-1/4"	Sea Salt	
183047	K-3048-8-0	8"cc	25-5/8" x 22-1/4"	White	

37" x 22-1/4"

Part #	Mfg #	Description	Dimensions	Color	Price
177356	K-3051-1-96	1-Hole	37-5/8" x 22-1/4"	Biscuit	
117938	K-3051-1-FD	1-Hole	37-5/8" x 22-1/4"	Cane Sugar	
107145	K-3051-1-KA	1-Hole	37-5/8" x 22-1/4"	Black 'n Tan	
145664	K-3051-1-7	1-Hole	37-5/8" x 22-1/4"	Black	
112576	K-3051-8-FD	8"cc	37-5/8" x 22-1/4"	Cane Sugar	
100975	K-3051-8-FF	8"cc	37-5/8" x 22-1/4"	Sea Salt	
103423	K-3051-8-G9	8"cc	37-5/8" x 22-1/4"	Sandbar	
099449	K-3051-8-KA	8"cc	37-5/8" x 22-1/4"	Black 'n Tan	
101594	K-3051-8-0	8"cc	37-5/8" x 22-1/4"	White	
097355	K-3051-8-95	8"cc	37-5/8" x 22-1/4"	Ice Grey	
150621	K-3051-8-96	8"cc	37-5/8" x 22-1/4"	Biscuit	

43" x 22-1/4"

Part #	Mfg #	Description	Dimensions	Color	Price
183048	K-3052-1-FD	1-Hole	43-5/8" x 22-1/4"	Cane Sugar	
121504	K-3052-8-0	8"cc	43-5/8" x 22-1/4"	White	
121321	K-3052-8-FD	8"cc	43-5/8" x 22-1/4"	Cane Sugar	
125199	K-3052-8-KA	8"cc	43-5/8" x 22-1/4"	Black 'n Tan	

49" x 22-1/4"

Part #	Mfg #	Description	Dimensions	Color	Price
144929	K-3053-1-0	1-Hole	49-5/8" x 22-1/4"	White	
109455	K-3053-1-7	1-Hole	49-5/8" x 22-1/4"	Black	
183049	K-3053-1-96	1-Hole	49-5/8" x 22-1/4"	Biscuit	
139845	K-3053-1-KA	1-Hole	49-5/8" x 22-1/4"	Black 'n Tan	
120034	K-3053-4-G9	4"cc	49-5/8" x 22-1/4"	Sandbar	
136113	K-3053-8-0	8"cc	49-5/8" x 22-1/4"	White	
176243	K-3053-8-96	8"cc	49-5/8" x 22-1/4"	Biscuit	
115363	K-3053-8-FF	8"cc	49-5/8" x 22-1/4"	Sea Salt	
168232	K-3053-8-G9	8"cc	49-5/8" x 22-1/4"	Sandbar	
125966	K-3053-8-KA	8"cc	49-5/8" x 22-1/4"	Black 'n Tan	

Top-Mount Lavatories

Lavatories

Solid/Expressions™ Vanity Top with Double Verticyl® Oval Cutout

- Solid surface
- Sculpted edge
- Field trimmable for alcove corner installations
- Pilot holes for 8" widespread, 4" centerset or single faucet
- Pairs with Verticyl® oval under-mount lavatory sinks or other Kohler® 17" x 14" oval under-mount lavatory sinks



Part #	Mfg #	Description	Dimensions	Color	Price
172833	K-5433-S33	Pilot holes for 4"cc and 8"cc	61" x 22-13/16"	White	

Solid/Expressions™ Universal Side splash

- Includes one panel
- Solid surface
- For use with Kohler® Solid/Expressions™ solid-surface vanity tops



Part #	Mfg #	Description	Dimensions	Color	Price
172835	K-5451-S33	21-1/4" Sidesplash Kit	21-1/4" x 3-1/2"	White	

Solid/Expressions™ Back Splash

- Solid surface



Part #	Mfg #	Description	Dimensions	Color	Price
172834	K-5448-S33	61" Backsplash Kit	61" x 3-1/2"	White	
173943	K-5446-S33	37" Backsplash Kit	37" x 3-1/2"	White	

Solid/Expressions™ Vanity Top

- Solid surface
- Pilot holes for 8" widespread, 4" centerset or single faucet
- Single Verticyl® cutouts



Part #	Mfg #	Description	Dimensions	Color	Price
171791	K-5422-S33	1 Hole, Oval Basin	31" x 22-13/16"	White	
185569	K-5456-S33	1 Hole Rectangular Basin	31" x 22-13/16"	White	

Solid/Expressions™ Vanity Top without Cutout

- Solid surface
- Vessel or drop-in lavatory sink required



Part #	Mfg #	Description	Dimensions	Color	Price
173940	K-5438-S33	Less Holes	37" x 22-13/16"	White	

Top-Mount Lavatories

Kathryn® Console Tabletop — 24" x 22"

- Precut for a KOHLER® 17- by 14-inch under-mount sink K-2205-G or K-2210-G
- Coordinates with Kathryn® console legs and other products in the Kathryn® collection



Requires: K-9699 frame kit with hardware

Part #	Mfg #	Description	Dimensions	Color	Price
182855	K-3023-NM	8"cc	24" x 22"	Nero Marquina Marble	

Kathryn® Lavastone Tabletop

- Enameled lavastone
- 10-Inch center faucet holes
- Precut for the K-2297-G Kathryn® under-mount sink



Part #	Mfg #	Description	Dimensions	Color	Price
182857	K-3028-K2	10"cc	42" x 22"	Grey Flannel	

Memoirs® Stately Vanity-Top — 30" x 21-3/4"

- Rectangular basin
- Overflow drain



Combines with K-2267 pedestal to create the K-2268 pedestal sink

Combines with K-6880 console table legs to create a console table

Part #	Mfg #	Description	Dimensions	Color	Price
073965	K-2269-1-0	Single Hole Basin	30" x 21-3/4"	White	
157236	K-2269-1-33	Single Hole Basin	30" x 21-3/4"	Mexican Sand	
121107	K-2269-1-47	Single Hole Basin	30" x 21-3/4"	Almond	
155625	K-2269-1-7	Single Hole Basin	30" x 21-3/4"	Black	
087379	K-2269-1-95	Single Hole Basin	30" x 21-3/4"	Ice Grey	
101376	K-2269-1-96	Single Hole Basin	30" x 21-3/4"	Biscuit	
053523	K-2269-8-0	8"cc Basin	30" x 21-3/4"	White	
083633	K-2269-8-33	8"cc Basin	30" x 21-3/4"	Mexican Sand	
096304	K-2269-8-47	8"cc Basin	30" x 21-3/4"	Almond	
083632	K-2269-8-7	8"cc Basin	30" x 21-3/4"	Black	
058175	K-2269-8-95	8"cc Basin	30" x 21-3/4"	Ice Grey	
055823	K-2269-8-96	8"cc Basin	30" x 21-3/4"	Biscuit	
094952	K-2269-8-G9	8"cc Basin	30" x 21-3/4"	Sandbar	
084566	K-2269-8-K4	8"cc Basin	30" x 21-3/4"	Cashmere	
167791	K-2269-8-NY	8"cc Basin	30" x 21-3/4"	Dune	

Top-Mount Lavatories

Lavatories

Persuade® Vanity-Top Bathroom Sink — 25-1/4" x 22"

- Basin with square back and curved front
- Basin depth: 6"
- Overflow drain



Part #	Mfg #	Description	Dimensions	Color	Price
139284	K-2956-1-0	Single Hole Basin	25-1/4" x 22"	White	
130294	K-2956-8-0	8"cc Basin	25-1/4" x 22"	White	
151120	K-2956-8-7	8"cc Basin	25-1/4" x 22"	Black	

Traverse® Vanity-Top — 30-1/2" x 21-5/8"

- Fireclay
- Spacious, wide-rimmed rectangular basin
- Overflow drain



Part #	Mfg #	Description	Dimensions	Color	Price
158965	K-2955-1-0	1-Hole	30-1/2" x 21-5/8"	White	
141693	K-2955-8-0	8"cc	30-1/2" x 21-5/8"	White	

Tresham® Vanity-Top — 25-7/16" x 19-1/16"

- Vitreous china
- Overflow drain



Combines with K-2604 Tresham Vanity and other industry-standard 24" by 18" vanities

Part #	Mfg #	Description	Dimensions	Color	Price
149141	K-2979-1-0	1-Hole	25-7/16" x 19-1/16"	White	
144152	K-2979-4-0	4"cc	25-7/16" x 19-1/16"	White	
144484	K-2979-4-96	4"cc	25-7/16" x 19-1/16"	Biscuit	
146479	K-2979-8-0	8"cc	25-7/16" x 19-1/16"	White	
144494	K-2979-8-96	8"cc	25-7/16" x 19-1/16"	Biscuit	
146068	K-2979-8-K4	8"cc	25-7/16" x 19-1/16"	Cashmere	



Top-Mount Lavatories

Drop-In Lavatories

Logan Square Self-Rimming Lavatory

- Concealed front overflow
- Generous wash basin with large deck space
- Faucet sold separately



Part #	Mfg #	Description	Dimensions	Color	Price
130570	12-875	4"cc Square Lavatory Basin	23-5/8" x 18-1/8" x 7-3/8"	White	

Luxoval™ Self-Rimming Lavatory

- Concealed front overflow
- Faucet sold separately



12-844

Part #	Mfg #	Description	Dimensions	Color	Price
024550	12-841	4"cc Oval Lavatory Basin	9-1/2" x 20" x 17-3/8"	White	
004511	12-844	4"cc Oval Lavatory Basin	8-3/4" x 20" x 17"	White	
004514	12-844-09	4"cc Oval Lavatory Basin	8-3/4" x 20" x 17"	Biscuit	
004518	12-848	8"cc Oval Lavatory Basin	8-3/4" x 20" x 17"	White	
004520	12-848-25	8"cc Oval Lavatory Basin	8-3/4" x 20" x 17"	Bone	
023982	12-848-09	8"cc Oval Lavatory Basin	8-3/4" x 20" x 17"	Biscuit	

Maxwell Self-Rimming Lavatory

- Concealed front overflow
- Faucet sold separately



Part #	Mfg #	Description	Dimensions	Color	Price
077454	12-884	4"cc Lavatory Basin	19-1/4" Round	White	
077452	12-834	4"cc Lavatory Basin	21" x 17-7/8" Oval	White	
105217	12-834-09	4"cc Lavatory Basin	21" x 17-7/8" Oval	Biscuit	
175068	12-834-25	4"cc Lavatory Basin	21" x 17-7/8" Oval	Bone/Wheat	
086324	12-888	8"cc Lavatory Basin	19" Round	White	



Top-Mount Lavatories

Rotunda Self-Rimming Lavatory

- Concealed front overflow
- Faucet sold separately



Lavatories

Part #	Mfg #	Description	Dimensions	Color	Price
004525	12-894	4"cc Lavatory Basin	9-1/2" x 19" x 19"	White	
004527	12-894-25	4"cc Lavatory Basin	9-1/2" x 19" x 19"	Bone	
024850	12-894-09	4"cc Lavatory Basin	9-1/2" x 19" x 19"	Biscuit	

Top-Mount Lavatories

Drop-In Lavatories

Alto II Drop-In Lavatory

- Self-rimming lavatory
- Available in 4" or 8" faucet centers
- Concealed front overflow
- Faucet sold separately



Part #	Mfg #	Description	Dimensions	Color	Price
192324	251-4-WH	4"cc, 15-1/2" x 10-1/8" Basin	19" x 16"	White	

Maverick™ I Drop-In Lavatory

- Self-rimming lavatory
- Available in single hole, 4" or 8" faucet centers
- Concealed front overflow
- Complies with ADA requirements for accessibility

Part #	Mfg #	Description	Dimensions	Color	Price
192323	249-4-WH	4"cc, 14-3/4" x 12-1/8" Basin	19"	White	

Maverick™ II Drop-In Lavatory

- Self-rimming lavatory
- Available in single hole, 4" or 8" faucet centers
- Concealed front overflow
- Complies with ADA requirements for accessibility



Part #	Mfg #	Description	Dimensions	Color	Price
220999	267-1-WH	1-Hole, 15-1/2"x10-1/2" Basin	20" x 17"	White	
192299	267-4-WH	4"cc, 15-1/2" x 10-1/2" Basin	20" x 17"	White	
198460	267-4-BI	4"cc, 15-1/2" x 10-1/2" Basin	20" x 17"	Biscuit	

Barrett™ Drop-In Lavatory

- Traditional Style
- Part of the Barrett Bathroom Collection
- Self-rimming lavatory
- Available in single hole, 4" or 8" faucet centers
- Concealed front overflow
- Complies with ADA requirements for accessibility



Part #	Mfg #	Description	Dimensions	Color	Price
225295	268-4-WH	4"cc, 16-1/4" x 10-1/2" Basin	23-1/6" x 18-5/8"	White	

Under-Mount Lavatories

Vitreous China Under-Mount Lavatories

ADA - Compliant when installed according to the Accessibility Guidelines, Section 606 Lavatories and Mirrors, of the Act

Archer™ Under-Mount Lavatory

- Overflow drain
- Includes 52047 clamp assembly
- Exterior dimensions: 19-5/8" x 15-5/16"
- Basin depth: 7-1/2"



Part #	Mfg #	Description	Interior Dimensions	Color	Price
102866	K-2355-0	ADA Basin	17-5/16" x 13"	White	
106846	K-2355-33	ADA Basin	17-5/16" x 13"	Mexican Sand	
112534	K-2355-47	ADA Basin	17-5/16" x 13"	Almond	
111215	K-2355-58	ADA Basin	17-5/16" x 13"	Thunder Grey	
112591	K-2355-7	ADA Basin	17-5/16" x 13"	Black	
158430	K-2355-95	ADA Basin	17-5/16" x 13"	Ice Grey	
107494	K-2355-96	ADA Basin	17-5/16" x 13"	Biscuit	
116214	K-2355-G9	ADA Basin	17-5/16" x 13"	Sandbar	
179978	K-2355-NY	ADA Basin	17-5/16" x 13"	Dune	

Bancroft™ Under-Mount Lavatory

- Overflow drain
- Exterior dimensions: 19-3/8" x 16-3/16"
- Basin depth: 8-1/2"



Part #	Mfg #	Description	Interior Dimensions	Color	Price
090315	K-2319-0	ADA Basin	17" x 14"	White	
140523	K-2319-47	ADA Basin	17" x 14"	Almond	
123812	K-2319-95	ADA Basin	17" x 14"	Ice Grey	
099100	K-2319-96	ADA Basin	17" x 14"	Biscuit	
150118	K-2319-G9	ADA Basin	17" x 14"	Sandbar	
144580	K-2319-K4	ADA Basin	17" x 14"	Cashmere	

Camber® Under-Mount Lavatory

- Round basin
- Without overflow



Part #	Mfg #	Description	Dimensions	Color	Price
083350	K-2349-0	ADA Basin Less Overflow	14" Diameter	White	
183025	K-2349-47	ADA Basin Less Overflow	14" Diameter	Almond	
101747	K-2349-96	ADA Basin Less Overflow	14" Diameter	Biscuit	
094624	K-2349-HV	ADA Basin Less Overflow	14" Diameter	Boucle Tweed	
094362	K-2349-HW	ADA Basin Less Overflow	14" Diameter	Boucle Muslin	

Under-Mount Lavatories

Camber® Under-Mount Lavatory with Mille Fleurs™ Design

- Decorated with a blossom and bird pattern with gold and platinum accents on almond background.
- Round basin.
- No faucet holes; requires wall- or counter-mount faucet.



Part #	Mfg #	Description	Dimensions	Color	Price
183010	K-14036-T9-47	ADA Basin Less Overflow, Milles Fleurs Design	16-1/8" Diameter	Almond	

Caxton® Under-Mount Lavatory with Caravan® Collection Persia

- Decorated with a Moorish design on White background.
- Deep oval basin.
- No faucet holes; requires wall- or counter-mount faucet.
- Persia design.
- Fits standard 14- x 17-inch countertop cutout.



Part #	Mfg #	Description	Dimensions	Color	Price
175256	K-14218-SR2-0	ADA Basin, Caravan Collection Persia	19-1/4" x 16-1/8"	White	

Caxton® Under Mount Lavatory with Caravan® Collection Nepal

- Decorated with a Henna pattern on translucent blue background
- Deep oval basin
- No faucet holes; requires wall-or-counter-mount faucet
- Nepal design
- Fits standard 14- x 17-inch countertop cutout



Part #	Mfg #	Description	Dimensions	Color	Price
183673	K-14218-SR1-K7	ADA Basin, Caravan Collection Nepal	19-1/4" x 16-1/8"	Nepal	

Caxton® Under-Mount Lavatory Basin

- Overflow drain
- Clamp assembly
- Basin depth: 7-1/2"
- Exterior dimensions: (2205) 19-1/4" x 16-1/8", (2209) 15" x 12" (2210) 19-1/4" x 16-1/4", (2211) 21-1/4" x 17-1/4"
- (K-2205) includes center drain with overflow



K-2209 Shown Installed

Part #	Mfg #	Description	Interior Dimensions	Color	Price
066609	K-2205-0	ADA Basin with Overflow, Center Drain	17" x 14" x 8-1/4"	White	
093535	K-2205-47	ADA Basin with Overflow, Center Drain	17" x 14" x 8-1/4"	Almond	
064358	K-2205-96	ADA Basin with Overflow, Center Drain	17" x 14" x 8-1/4"	Biscuit	
057876	K-2209-0	ADA Basin with Overflow	15" x 12" x 7-1/2"	White	
083330	K-2209-47	ADA Basin with Overflow	15" x 12" x 7-1/2"	Almond	
179520	K-2209-58	ADA Basin with Overflow	15" x 12" x 7-1/2"	Thunder Grey	
081075	K-2209-95	ADA Basin with Overflow	15" x 12" x 7-1/2"	Ice Grey	

Under-Mount Lavatories

Vitreous China Under-Mount Lavatories (Continued)

Caxton® Under-Mount Lavatory Basin

Lavatories

Part #	Mfg #	Description	Interior Dimensions	Color	Price
059880	K-2209-96	ADA Basin with Overflow	15" x 12" x 7-1/2"	Biscuit	
175696	K-2209-NY	ADA Basin with Overflow	15" x 12" x 7-1/2"	Dune	
053183	K-2210-0	ADA Basin with Overflow	17" x 14" x 7-1/2"	White	
065474	K-2210-33	ADA Basin with Overflow	17" x 14" x 7-1/2"	Mexican Sand	
069336	K-2210-47	ADA Basin with Overflow	17" x 14" x 7-1/2"	Almond	
085333	K-2210-58	ADA Basin with Overflow	17" x 14" x 7-1/2"	Thunder Grey	
059653	K-2210-7	ADA Basin with Overflow	17" x 14" x 7-1/2"	Black	
073066	K-2210-95	ADA Basin with Overflow	17" x 14" x 7-1/2"	Ice Grey	
059062	K-2210-96	ADA Basin with Overflow	17" x 14" x 7-1/2"	Biscuit	
062319	K-2210-G9	ADA Basin with Overflow	17" x 14" x 7-1/2"	Sandbar	
081511	K-2210-K4	ADA Basin with Overflow	17" x 14" x 7-1/2"	Cashmere	
147692	K-2210-NY	ADA Basin with Overflow	17" x 14" x 7-1/2"	Dune	
059574	K-2211-0	ADA Basin with Overflow	19" x 15" x 7-1/2"	White	
062145	K-2211-47	ADA Basin with Overflow	19" x 15" x 7-1/2"	Almond	
061060	K-2211-7	ADA Basin with Overflow	19" x 15" x 7-1/2"	Black	
057480	K-2211-96	ADA Basin with Overflow	19" x 15" x 7-1/2"	Biscuit	
171107	K-2211-58	ADA Basin with Overflow	19" x 15" x 7-1/2"	Thunder Grey	
189533	K-2211-NY	ADA Basin with Overflow	19" x 15" x 7-1/2"	Dune	
091044	K-2211-G-0	ADA Basin with Overflow, Glazed Underside	19" x 15" x 7-1/2"	White	
182421	K-2211-G-96	ADA Basin with Overflow, Glazed Underside	19" x 15" x 7-1/2"	Biscuit	

Caxton® Rectangle Under-Mount Lavatory — 17-3/8" x 13"

- Overflow drain
- Vitreous china
- 7-5/16" Depth



Part #	Mfg #	Description	Dimensions	Color	Price
226842	K-20000-0	ADA Basin with Overflow	17-3/8" x 13" x 7-5/16"	White	
229507	K-20000-96	ADA Basin with Overflow	17-3/8" x 13" x 7-5/16"	Biscuit	
229506	K-20000-G9	ADA Basin with Overflow	17-3/8" x 13" x 7-5/16"	Sandbar	

Devonshire® Under-Mount Lavatory Basin — 18-1/8" x 14"

- Overflow drain
- Vitreous china
- 8-5/8" Depth



Part #	Mfg #	Description	Interior Dimensions	Color	Price
076321	K-2336-0	ADA Basin	18-1/8" x 14"	White	
108405	K-2336-33	ADA Basin	18-1/8" x 14"	Mexican Sand	
079195	K-2336-47	ADA Basin	18-1/8" x 14"	Almond	
149624	K-2336-58	ADA Basin	18-1/8" x 14"	Thunder Grey	

Under-Mount Lavatories

Vitreous China Under-Mount Lavatories (Continued)

Devonshire® Under-Mount Lavatory Basin — 18-1/8" x 14"

Part #	Mfg #	Description	Interior Dimensions	Color	Price
100993	K-2336-7	ADA Basin	18-1/8" x 14"	Black	
105168	K-2336-95	ADA Basin	18-1/8" x 14"	Ice Grey	
080618	K-2336-96	ADA Basin	18-1/8" x 14"	Biscuit	
094835	K-2336-G9	ADA Basin	18-1/8" x 14"	Sandbar	
094799	K-2336-K4	ADA Basin	18-1/8" x 14"	Cashmere	

Devonshire® Under-Mount Lavatory — 16-7/8" x 13-11/16"

- Vitreous china
- 8-5/8" Depth



Part #	Mfg #	Description	Interior Dimensions	Color	Price
083489	K-2350-0	ADA Basin	16-7/8" x 13-11/16"	White	
089028	K-2350-33	ADA Basin	16-7/8" x 13-11/16"	Mexican Sand	
086017	K-2350-47	ADA Basin	16-7/8" x 13-11/16"	Almond	
105971	K-2350-7	ADA Basin	16-7/8" x 13-11/16"	Black	
189541	K-2350-95	ADA Basin	16-7/8" x 13-11/16"	Ice Grey	
085876	K-2350-96	ADA Basin	16-7/8" x 13-11/16"	Biscuit	
090983	K-2350-G9	ADA Basin	16-7/8" x 13-11/16"	Sandbar	
181552	K-2350-K4	ADA Basin	16-7/8" x 13-11/16"	Cashmere	

Kathryn® Under-Mount Lavatory

- Overflow drain
- Basin Depth: 6-3/4"



Part #	Mfg #	Description	Dimensions	Color	Price
083988	K-2330-0	ADA Basin with Overflow	19-3/4" x 15-5/8"	White	
090986	K-2330-7	ADA Basin with Overflow	19-3/4" x 15-5/8"	Black	
090271	K-2330-96	ADA Basin with Overflow	19-3/4" x 15-5/8"	Biscuit	
085008	K-2297-0	ADA Basin with Overflow	23-7/8" x 15-5/8"	White	
185956	K-2297-95	ADA Basin with Overflow	23-7/8" x 15-5/8"	Ice Grey	
089029	K-2297-96	ADA Basin with Overflow	23-7/8" x 15-5/8"	Biscuit	
082432	K-2297-G-0	ADA Basin w/ Overflow and Glazed Underside	23-7/8" x 15-5/8"	White	
128503	K-2297-G-7	ADA Basin w/ Overflow and Glazed Underside	23-7/8" x 15-5/8"	Black	

Kelston® Under-Mount Lavatory — 20-3/8" x 15-1/4"

- Overflow drain
- Basin depth: 5"



Part #	Mfg #	Description	Dimensions	Color	Price
117394	K-2382-0	ADA Basin with Overflow	20-3/8" x 15-1/4"	White	
141583	K-2382-47	ADA Basin with Overflow	20-3/8" x 15-1/4"	Almond	
173084	K-2382-7	ADA Basin with Overflow	20-3/8" x 15-1/4"	Black	
127879	K-2382-95	ADA Basin with Overflow	20-3/8" x 15-1/4"	Ice Grey	
122615	K-2382-96	ADA Basin with Overflow	20-3/8" x 15-1/4"	Biscuit	

Under-Mount Lavatories

Vitreous China Under-Mount Lavatories (Continued)

Kelston® Under-Mount Lavatory — 20-3/8" x 15-1/4"

Part #	Mfg #	Description	Dimensions	Color	Price
178526	K-2382-NY	ADA Basin with Overflow	20-3/8" x 15-1/4"	Dune	

Ladena™ Under-Mount Lavatory — 20-7/8" x 14-3/8"

- Vitreous china
- Basin depth: 8-1/8"



Part #	Mfg #	Description	Interior Dimensions	Color	Price
073188	K-2214-0	ADA Basin with Overflow	20-7/8" x 14-3/8" x 8-1/8"	White	
065065	K-2214-33	ADA Basin with Overflow	20-7/8" x 14-3/8" x 8-1/8"	Mexican Sand	
101463	K-2214-47	ADA Basin with Overflow	20-7/8" x 14-3/8" x 8-1/8"	Almond	
159003	K-2214-58	ADA Basin with Overflow	20-7/8" x 14-3/8" x 8-1/8"	Thunder Grey	
089865	K-2214-7	ADA Basin with Overflow	20-7/8" x 14-3/8" x 8-1/8"	Black	
164687	K-2214-95	ADA Basin with Overflow	20-7/8" x 14-3/8" x 8-1/8"	Ice Grey	
070312	K-2214-96	ADA Basin with Overflow	20-7/8" x 14-3/8" x 8-1/8"	Biscuit	
099126	K-2214-G9	ADA Basin with Overflow	20-7/8" x 14-3/8" x 8-1/8"	Sandbar	
143062	K-2214-K4	ADA Basin with Overflow	20-7/8" x 14-3/8" x 8-1/8"	Cashmere	
175695	K-2214-NY	ADA Basin with Overflow	20-7/8" x 14-3/8" x 8-1/8"	Dune	

Ladena™ Under-Mount Lavatory Sink with Glazed Underside — 20-7/8" x 14-3/8"

- Vitreous china
- 8-1/8" Depth



Part #	Mfg #	Description	Interior Dimensions	Color	Price
070679	K-2214-G-0	ADA Basin	20-7/8" x 14-3/8" x 8-1/8"	White	
158283	K-2214-G-47	ADA Basin	20-7/8" x 14-3/8" x 8-1/8"	Almond	
157775	K-2214-G-7	ADA Basin	20-7/8" x 14-3/8" x 8-1/8"	Black	
156076	K-2214-G-96	ADA Basin	20-7/8" x 14-3/8" x 8-1/8"	Biscuit	

Ladena™ Under-Mount Lavatory Sink with Overflow Drain — 23-1/4" x 16-1/4"

- Vitreous china
- Basin depth: 8-1/8"
- ADA-compliant when installed in a 21" minimum depth countertop



Part #	Mfg #	Description	Interior Dimensions	Color	Price
058988	K-2215-0	ADA Basin with Overflow	23-1/4" x 16-1/4"	White	
152956	K-2215-33	ADA Basin with Overflow	23-1/4" x 16-1/4"	Mexican Sand	
080728	K-2215-47	ADA Basin with Overflow	23-1/4" x 16-1/4"	Almond	
160232	K-2215-58	ADA Basin with Overflow	23-1/4" x 16-1/4"	Thunder Grey	
169972	K-2215-7	ADA Basin with Overflow	23-1/4" x 16-1/4"	Black	
103063	K-2215-95	ADA Basin with Overflow	23-1/4" x 16-1/4"	Ice Grey	
075914	K-2215-96	ADA Basin with Overflow	23-1/4" x 16-1/4"	Biscuit	
078633	K-2215-G9	ADA Basin with Overflow	23-1/4" x 16-1/4"	Sandbar	
117225	K-2215-K4	ADA Basin with Overflow	23-1/4" x 16-1/4"	Cashmere	

Under-Mount Lavatories

Vitreous China Under-Mount Lavatories (Continued)

Ladena™ Under-Mount Lavatory Sink with Overflow Drain — 23-1/4" x 16-1/4"

Part #	Mfg #	Description	Interior Dimensions	Color	Price
189534	K-2215-NY	ADA Basin with Overflow	23-1/4" x 16-1/4"	Dune	

Memoirs® Under-Mount Lavatory Sink — 18-1/4" x 14-1/2"

- Vitreous china
- 8-5/8" Depth



Part #	Mfg #	Description	Interior Dimensions	Color	Price
078909	K-2339-0	ADA Basin	18-1/4" x 14-1/2"	White	
099559	K-2339-33	ADA Basin	18-1/4" x 14-1/2"	Mexican Sand	
083715	K-2339-47	ADA Basin	18-1/4" x 14-1/2"	Almond	
077085	K-2339-7	ADA Basin	18-1/4" x 14-1/2"	Black	
079155	K-2339-96	ADA Basin	18-1/4" x 14-1/2"	Biscuit	
086203	K-2339-G9	ADA Basin	18-1/4" x 14-1/2"	Sandbar	
108484	K-2339-K4	ADA Basin	18-1/4" x 14-1/2"	Cashmere	

Verticyl™ Oval Under-Mount Lavatory Sink with Overflow Drain

- Vitreous china



Part #	Mfg #	Description	Interior Dimensions	Color	Price
124338	K-2881-0	Oval ADA Basin	17" x 14"	White	
143613	K-2881-33	Oval ADA Basin	17" x 14"	Mexican Sand	
124340	K-2881-47	Oval ADA Basin	17" x 14"	Almond	
166402	K-2881-58	Oval ADA Basin	17" x 14"	Thunder Grey	
132631	K-2881-7	Oval ADA Basin	17" x 14"	Black	
183044	K-2881-95	Oval ADA Basin	17" x 14"	Ice Grey	
124339	K-2881-96	Oval ADA Basin	17" x 14"	Biscuit	
136652	K-2881-G9	Oval ADA Basin	17" x 14"	Sandbar	
129261	K-2881-K4	Oval ADA Basin	17" x 14"	Cashmere	

Verticyl™ Under-Mount Lavatory Sink with Overflow

- Vitreous china.
- Exterior dimensions: 19-13/16" x 15-5/8"
- Interior dimensions: 17-1/4" x 13"



Part #	Mfg #	Description	Interior Dimensions	Color	Price
124345	K28820	ADA Basin	17-1/4" x 13"	White	
183046	K-2882-33	ADA Basin	17-1/4" x 13"	Mexican Sand	
124347	K-2882-47	ADA Basin	17-1/4" x 13"	Almond	
146683	K-2882-58	ADA Basin	17-1/4" x 13"	Thunder Grey	
129813	K-2882-7	ADA Basin	17-1/4" x 13"	Black	
170067	K-2882-95	ADA Basin	17-1/4" x 13"	Ice Grey	
124346	K-2882-96	ADA Basin	17-1/4" x 13"	Biscuit	
183045	K-2882-G9	ADA Basin	17-1/4" x 13"	Sandbar	

Under-Mount Lavatories

Vitreous China Under-Mount Lavatories (Continued)

Verticyl™ Under-Mount Lavatory Sink with Overflow

Part #	Mfg #	Description	Interior Dimensions	Color	Price
133998	K-2882-K4	ADA Basin	17-1/4" x 13"	Cashmere	
181967	K-2882-NY	ADA Basin	17-1/4" x 13"	Dune	

Verticyl™ Under-Mount Lavatory Sink with Overflow

- Vitreous china
- Exterior dimensions: 15-3/4" diameter
- Interior dimensions: 13-3/4" diameter
- 6-3/4" Depth



Part #	Mfg #	Description	Dimensions	Color	Price
124348	K-2883-0	Round ADA Basin	13-3/4" Dia	White	
182298	K-2883-33	Round ADA Basin	13-3/4" Dia	Mexican Sand	
124350	K-2883-47	Round ADA Basin	13-3/4" Dia	Almond	
178160	K-2883-95	Round ADA Basin	13-3/4" Dia	Ice Grey	
124349	K-2883-96	Round ADA Basin	13-3/4" Dia	Biscuit	
156547	K-2883-G9	Round ADA Basin	13-3/4" Dia	Sandbar	

Vintage® Under-Mount Classic Elliptical Lavatory Sink with Overflow Drain — 21-1/4" x 12-1/4"

- Vitreous china
- Exterior dimensions: 23-7/8" x 14-3/8"
- Water depth: 4-7/8"



Part #	Mfg #	Description	Dimensions	Color	Price
059087	K-2240-0	ADA Elliptical Basin	21" x 12"	White	
182422	K-2240-47	ADA Elliptical Basin	21" x 12"	Almond	
062987	K-2240-96	ADA Elliptical Basin	21" x 12"	Biscuit	

Cast Iron Under-Mount Lavatories

ADA - Compliant when installed according to the Accessibility Guidelines, Section 606 Lavatories and Mirrors, of the Act

Canvas® Under-Mount Lavatory Sink with Overflow Drain — 19-7/16" x 16-1/16"

- Cast iron
- Basin depth: 3-15/16"



Part #	Mfg #	Description	Interior Dimensions	Color	Price
136735	K-2874-0	ADA Basin	19-7/16" x 16-1/16"	White	
147500	K-2874-47	ADA Basin	19-7/16" x 16-1/16"	Almond	
162016	K-2874-95	ADA Basin	19-7/16" x 16-1/16"	Ice Grey	
142825	K-2874-96	ADA Basin	19-7/16" x 16-1/16"	Biscuit	
132942	K-2874-FD	ADA Basin	19-7/16" x 16-1/16"	Cane Sugar	
138669	K-2874-FF	ADA Basin	19-7/16" x 16-1/16"	Sea Salt	
154813	K-2874-G9	ADA Basin	19-7/16" x 16-1/16"	Sandbar	
182803	K-2874-FT	ADA Basin	19-7/16" x 16-1/16"	Basalt	

Under-Mount Lavatories

Cast Iron Under-Mount Lavatories (Continued)

Canvas® Under-Mount Lavatory Sink with Overflow Drain — 19-7/16" x 16-1/16"

Part #	Mfg #	Description	Interior Dimensions	Color	Price
135230	K-2874-KA	ADA Basin	19-7/16" x 16-1/16"	Black n' Tan	

Garamond® Under-Mount Lavatory Sink — 21-1/16" x 16-1/4"

- Enameled cast iron
- 5-1/2" Water depth



Part #	Mfg #	Description	Dimensions	Color	Price
095184	K-2832-0	ADA Basin	21-1/16" x 16-1/4"	White	
117130	K-2832-47	ADA Basin	21-1/16" x 16-1/4"	Almond	
093172	K-2832-96	ADA Basin	21-1/16" x 16-1/4"	Biscuit	
122579	K-2832-FD	ADA Basin	21-1/16" x 16-1/4"	Cane Sugar	
097422	K-2832-FF	ADA Basin	21-1/16" x 16-1/4"	Sea Salt	
117835	K-2832-FT	ADA Basin	21-1/16" x 16-1/4"	Basalt	

Iron Plains® Wading Pool® Dual-Mount Lavatory Sink with Overflow Drain — 18-9/16" x 15-3/4"

- Drop-in or undermount
- Models K-5400-P5-KA & 5400-W-0 have black painted underside



Part #	Mfg #	Description	Dimensions	Color	Price
175174	K-5400-FF	ADA Basin	18-9/16" x 15-3/4"	Sea Salt	
167217	K-5400-FT	ADA Basin	18-9/16" x 15-3/4"	Basalt	
183578	K-5400-P5-KA	ADA Basin, w/ Black Painted Underside	18-9/16" x 15-3/4"	Black 'n tan	
184189	K-5400-W-0	ADA Basin, w/ Black Painted Underside	18-9/16" x 15-3/4"	White	
167216	K-5400-0	ADA Basin	18-9/16" x 15-3/4"	White	
173288	K-5400-20	ADA Basin	18-9/16" x 15-3/4"	Suede	
166509	K-5400-96	ADA Basin	18-9/16" x 15-3/4"	Biscuit	

Ledges® Under-Mount Lavatory Sink with Overflow Drain — 21-1/2" x 16-1/8"

- 6" Deep basin
- Two side ledges



Part #	Mfg #	Description	Dimensions	Color	Price
111186	K-2838-0	Rectangular Basin	21-1/2" x 16-1/8"	White	
113707	K-2838-47	Rectangular Basin	21-1/2" x 16-1/8"	Almond	
113049	K-2838-96	Rectangular Basin	21-1/2" x 16-1/8"	Biscuit	
143186	K-2838-FD	Rectangular Basin	21-1/2" x 16-1/8"	Cane Sugar	
146882	K-2838-FF	Rectangular Basin	21-1/2" x 16-1/8"	Sea Salt	
137264	K-2838-KA	Rectangular Basin	21-1/2" x 16-1/8"	Black 'n Tan	
157862	K-2838-KG	Rectangular Basin	21-1/2" x 16-1/8"	Vapour Green	

Under-Mount Lavatories

Man's Lav Under-Mount Lavatory Sink with Overflow Drain — 28" x 19"

- Cast iron
- Drilled for 8"cc deck-mount faucet



Part #	Mfg #	Description	Dimensions	Color	Price
071736	K-2885-8U-0	ADA Rectangular Basin	28" x 19" x 7-7/8"	White	
229069	K-2885-8U-47	ADA Rectangular Basin	28" x 19" x 7-7/8"	Almond	
075016	K-2885-8U-96	ADA Rectangular Basin	28" x 19" x 7-7/8"	Biscuit	

Serif® Under-Mount Lavatory Sink — 17-3/4" x 12-3/4"

- Without overflow or faucet holes
- Exterior dimensions: 20-5/8" x 15-1/4"
- Basin depth: 8-7/16"



Part #	Mfg #	Description	Interior Dimensions	Color	Price
087771	K-2824-0	ADA Basin	17-3/4" x 12-3/4"	White	
083816	K-2824-47	ADA Basin	17-3/4" x 12-3/4"	Almond	
120112	K-2824-7	ADA Basin	17-3/4" x 12-3/4"	Black	
164472	K-2824-95	ADA Basin	17-3/4" x 12-3/4"	Ice Grey	
085289	K-2824-96	ADA Basin	17-3/4" x 12-3/4"	Biscuit	
099931	K-2824-FD	ADA Basin	17-3/4" x 12-3/4"	Cane Sugar	
102203	K-2824-FF	ADA Basin	17-3/4" x 12-3/4"	Sea Salt	
090984	K-2824-G9	ADA Basin	17-3/4" x 12-3/4"	Sandbar	
087448	K-2824-KA	ADA Basin	17-3/4" x 12-3/4"	Black n' Tan	
134504	K-2824-KG	ADA Basin	17-3/4" x 12-3/4"	Vapour Green	
184222	K-2824-NY	ADA Basin	17-3/4" x 12-3/4"	Dune	

Glass Under-Mount Lavatories

Whist® Glass Under-Mount Lavatory Sink — 19" x 16-1/8"

- Basin depth: 5-3/8"
- Concentric ring styling
- No faucet or overflow holes
- (-G3) Opaque lavatory in doe



Part #	Mfg #	Description	Dimensions	Color	Price
153881	K-2741-B11	ADA Basin	19" x 16-1/8"	Ice	
143392	K-2741-G3-B11	ADA Basin	19" x 16-1/8"	Opaque Doe	
183513	K-2741-TG1	ADA Basin	19" x 16-1/8"	Translucent Dusk	

Kallos® Under-Mount Glass Lavatory Sink

- Basin depth: 4-1/4"
- Distinctive round spun-glass basin
- No faucet holes; requires wall- or counter-mount faucet



Part #	Mfg #	Description	Dimensions	Color	Price
231781	K-2361-TG8	ADA Basin	16" Diameter	Translucent Stone	

Under-Mount Lavatories

Stainless Steel Under-Mount Lavatories

Bachata® Dual-Mount Lavatory Sink without Overflow Drain — 19-7/8" x 16-11/16"

- 20 Gauge stainless steel
- Fits standard 14- x 17-inch countertop cutout



Part #	Mfg #	Description	Dimensions	Color	Price
171186	K-2608-MU-NA	ADA Basin, 5-3/4" Depth	19-7/8" x 16-11/16"	Mirror Finish	
168004	K-2608-SU-NA	ADA Basin, 5-3/4" Depth	19-7/8" x 16-11/16"	Luster Finish	

Bachata® Dual-Mount Lavatory Sink with Overflow Drain — 19-7/8" x 16-11/16"

- 20 Gauge stainless steel
- Fits standard 14- x 17-inch countertop cutout



Part #	Mfg #	Description	Dimensions	Color	Price
171029	K-2609-MU-NA	ADA Basin, 7-3/8" Depth	19-7/8" x 16-11/16"	Polished	
163138	K-2609-SU-NA	ADA Basin, 7-3/8" Depth	19-7/8" x 16-11/16"	Brushed	

Bolero® Under-Mount/Drop-In Lavatory

- 11-1/2" Diameter
- 20 Gauge stainless steel



Part #	Mfg #	Description	Dimensions	Color	Price
065755	K-2610-SU-NA	ADA Basin, 5-1/4" Depth	11-1/2" Diameter	Satin Finish	

Bolero® Under-Mount/Drop-In Lavatory

- Satin finish
- Water depth: 5-1/2"
- 20 Gauge stainless steel



Part #	Mfg #	Description	Dimensions	Color	Price
067278	K-2611-SU-NA	ADA Basin, 5-1/2" Depth	16-3/4" x 11-3/4"	Satin Finish	

Rhythm® Elliptical Under-Mount Lavatory with Satin Finish

- Basin depth: 6-1/4"
- Without overflow
- 20-gauge stainless steel
- No faucet holes; requires wall- or counter-mount faucet



Part #	Mfg #	Description	Dimensions	Color	Price
063582	K-2602-SU-NA	ADA Basin	18" x 13"	Satin Finish	

Lavatories

Under-Mount Lavatories

Lavatories

Lilies Lore® Cast Bronze Under-Mount Lavatory

- 17" x 14"
- Without overflow
- Integrally cast drain
- Drain is integrated into the sink
- Intricate Art Nouveau-inspired textured floral pattern
- No faucet holes; requires wall- or counter-mount faucet
- Not recommended for commercial applications
- Fits standard 14" x 17" countertop cutout



Part #	Mfg #	Description	Dimensions	Color	Price
131710	K-14297-MP1	ADA Basin	17" x 14"	Medium Patina	



DECOLAV®



DECOLAV®

Under-Mount Lavatories

Vitreous China Undermount Lavatories

Classically Redefined™ Lavatory

- With overflow



Oval

Part #	Mfg #	Description	Dimensions (H x W x D)	Color	Price
107838	1401-CWH	ADA Oval Basin	7.13" x 19.25" x 16.25"	Ceramic White	
107839	1401-CBN	ADA Oval Basin	7.13" x 19.25" x 16.25"	Ceramic Biscuit	
107840	1402-CWH	ADA Rectangular Basin	8.25" x 21.63" x 15.75"	Ceramic White	
107841	1402-CBN	ADA Rectangular Basin	8.25" x 21.63" x 15.75"	Ceramic Biscuit	

Lavatories



Under-Mount Lavatories

Undermount Lavatories

Logan Square™ Undercounter Lavatory

- Concealed front overflow



Part #	Mfg #	Description	Dimensions	Color	Price
128363	12-760	Lavatory Basin	20-3/4" x 17-3/8" x 7-7/8"	White	
130171	12-760-09	Lavatory Basin	20-3/4" x 17-3/8" x 7-7/8"	Biscuit	
150876	12-765	Petite Lavatory Basin	19-1/4" x 16-1/2" x 7"	White	

Luxoval™ Undercounter Lavatory

- Installs with #99-190 anchoring kit (not included)



Part #	Mfg #	Description	Dimensions	Color	Price
019082	12-780	Lavatory Basin	8-5/16" x 19-1/4" x 15-3/4"	White	
046531	12-780-09	Lavatory Basin	8-5/16" x 19-1/4" x 15-3/4"	Biscuit	

Mounting Hardware

Anchoring Kit

Part #	Mfg #	Description	Price
019081	99-190	Anchoring Kit for Undermount Lavatories	

Lavatories

Under-Mount Lavatories

Vitreous China Undercounter Lavatories

Wescott™ Undercounter Lavatory

- Center drain and overflow



Lavatories

Part #	Mfg #	Description	Dimensions	Color	Price
096764	442040-96	Oval Basin	17" x 13"	Biscuit	

Under-Mount Lavatories

Lavatories

Stainless Steel Lavatory Sinks

Asana Lustertone® Undermount SS Single Bowl Lavatory Sink

- 18" Gauge
- Lustrous highlighted satin finish
- Sound gaurd undercoating
- Includes overflow assembly



Part #	Mfg #	Overall Size	Holes	Depth	Drain Opening	Min Sink Base	Price
177137	ELUH1811	19-1/2" x 13-13/16"	N/A	6"	1-1/2"	27"	

Asana® Dual-Mount SS Single Bowl Lavatory Sink

- 18" Gauge
- Hammered mirror finish
- Fully undercoated
- Includes overflow assembly



Part #	Mfg #	Overall Size	Holes	Depth	Drain Opening	Min Sink Base	Price
157863	SCF16SH	16-1/4" Dia	N/A	7"	1-1/2"	21"	

Asana® Lustertone Undermount SS Round Single Bowl Sink

- 18" Gauge
- Lustrous highlighted satin finish
- Fully undercoated with pad(s)
- Includes overflow assembly



Part #	Mfg #	Overall Size	Holes	Depth	Drain Opening	Min Sink Base	Price
074995	ELUH16LV	18-3/8" Dia	N/A	8"	1-1/2"	24"	

The Mystic® Lustertone® Undermount SS Single Bowl Lavatory Sink

- 18" Gauge
- Lustrous highlighted finish
- Fully undercoated with pad(s)



Part #	Mfg #	Overall Size	Holes	Depth	Drain Opening	Min Sink Base	Price
122716	ELUH12	14-3/8" x 14-3/8"	N/A	6"	2"	18"	
159294	ELUH16	18-3/8" Dia	N/A	8"	2"	24"	

Under-Mount Lavatories

Under-Mount Lavatories

Brentwood Under-Mount Lavatory

- *Traditional Style*
- *Part of the Brentwood Bathroom Collection*
- *Undercounter lavatory*
- *Concealed front overflow*



Part #	Mfg #	Description	Dimensions	Color	Price
220856	234-WH	ADA Basin: 18-15/16" x 13	20-5/16" x 14-3/16"	White	
215018	234-BI	ADA Basin: 18-15/16" x 13	20-5/16" x 14-3/16"	Biscuit	

Maple Under-Mount Lavatory

- *Undercounter lavatory*
- *Concealed front overflow*
- *Complies with ADA requirements for accessibility*



Part #	Mfg #	Description	Dimensions	Color	Price
195313	217-WH	ADA Basin: 17-5/16" x 14-1/8"	19-3/4" x 16"	White	

Petite Covington Under-Mount Lavatory

- *Undercounter lavatory*
- *Concealed front overflow*
- *Complies with ADA requirements for accessibility*



Part #	Mfg #	Description	Dimensions	Color	Price
213194	218NS-WH	ADA Basin 19" x 11-3/8	21-3/8" x 13-1/2"	White	

Vessel Bowl Lavatories

Above-Counter Lavatories

Briolette™ Glass Vessel — 17-1/2" Diameter

- No faucet holes
- Drain sold separately



Part #	Mfg #	Description	Dimensions	Color	Price
139568	K-2373-B11	No Faucet Holes	17-1/2" x 17-1/2"	Ice	
181690	K-2373-TG3	No Faucet Holes	17-1/2" x 17-1/2"	Translucent Doe	
225246	K-2373-TG8	No Faucet Holes	17-1/2" x 17-1/2"	Translucent Stone	

Carillon™ Wading Pool® Above Counter Lavatory

- Without overflow
- No faucet holes; requires wall or counter mount faucet
- Wading pool design accommodates a wide variety of faucets



Part #	Mfg #	Description	Dimensions	Color	Price
183687	K-7799-0	Rectangle Basin, No Faucet Holes	21-1/8" x 14-9/16"	White	
188093	K-7799-96	Rectangle Basin, No Faucet Holes	21-1/8" x 14-9/16"	Biscuit	
186521	K-7799-NY	Rectangle Basin, No Faucet Holes	21-1/8" x 14-9/16"	Dune	
183688	K-7806-0	Round Basin, No Faucet Holes	17-11/16" x 17-11/16"	White	
228783	K-7608-NY	Round Basin, No Faucet Holes	17-11/16" x 17-11/16"	Dune	

Conical Bell® Vessel Above-Counter Lavatory

- No faucet holes
- 16-1/4" Outside diameter
- Glazed underside (-G models only)



Part #	Mfg #	Description	Dimensions	Color	Price
060286	K-2200-0	Less Faucet Deck	16-1/4" x 6-3/8"	White	
078715	K-2200-47	Less Faucet Deck	16-1/4" x 6-3/8"	Almond	
059861	K-2200-96	Less Faucet Deck	16-1/4" x 6-3/8"	Biscuit	
090738	K-2200-G9	Less Faucet Deck	16-1/4" x 6-3/8"	Sandbar	
056793	K-2200-G-0	Less Faucet Deck, Glazed Underside	16-1/4" x 6-3/8"	White	
077004	K-2200-G-7	Less Faucet Deck, Glazed Underside	16-1/4" x 6-3/8"	Black	
089322	K-2200-G-G9	Less Faucet Deck, Glazed Underside	16-1/4" x 6-3/8"	Sandbar	
162283	K-2200-G-K4	Less Faucet Deck, Glazed Underside	16-1/4" x 6-3/8"	Cashmere	
085223	K-2200-K4	Less Faucet Deck	16-1/4" x 6-3/8"	Cashmere	

Vessel Bowl Lavatories

DemiLav® Wading Pool® Lavatory — 18-1/4" x 15-5/8"

- Shaped rectangular basin
- No faucet or overflow holes
- Enameled cast iron



Part #	Mfg #	Description	Dimensions	Color	Price
093425	K-2833-0	No Faucet Holes	18-1/4" x 15-5/8"	White	
096704	K-2833-33	No Faucet Holes	18-1/4" x 15-5/8"	Mexican Sand	
107455	K-2833-47	No Faucet Holes	18-1/4" x 15-5/8"	Almond	
157023	K-2833-58	No Faucet Holes	18-1/4" x 15-5/8"	Thunder Grey	
107471	K-2833-7	No Faucet Holes	18-1/4" x 15-5/8"	Black	
111056	K-2833-95	No Faucet Holes	18-1/4" x 15-5/8"	Ice Grey	
091948	K-2833-96	No Faucet Holes	18-1/4" x 15-5/8"	Biscuit	
098268	K-2833-FD	No Faucet Holes	18-1/4" x 15-5/8"	Cane Sugar	
093462	K-2833-FF	No Faucet Holes	18-1/4" x 15-5/8"	Sea Salt	
154399	K-2833-FT	No Faucet Holes	18-1/4" x 15-5/8"	Basalt	
096321	K-2833-G9	No Faucet Holes	18-1/4" x 15-5/8"	Sandbar	
097448	K-2833-KA	No Faucet Holes	18-1/4" x 15-5/8"	Black n' Tan	
102601	K-2833-KC	No Faucet Holes	18-1/4" x 15-5/8"	Vapour Blue	
102886	K-2833-K4	No Faucet Holes	18-1/4" x 15-5/8"	Cashmere	
183559	K-2833-NY	No Faucet Holes	18-1/4" x 15-5/8"	Dune	

Derring™ Wading Pool® Above-Counter Lavatory

- No overflow
- Basin with carved textural pattern
- Wading pool® design
- No faucet holes; requires wall or counter mount faucet



Part #	Mfg #	Description	Dimensions	Color	Price
183674	K-17890-RL-K8	Round Basin, No Faucet Holes	17-11/16" x 17-11/16"	Translucent White	
228253	K-17890-RL-RB2	Round Basin, No Faucet Holes	17-11/16" x 17-11/16"	Bourbon Rutile	
183675	K-17916-RL-RB2	Rectangle Basin, No Faucet Holes	21-1/8" x 14-9/16"	Bourbon Rutile	

Iron Plains® Wading Pool® Above-Counter Lavatory

- Overflow drain
- Cast iron
- No faucet holes; requires wall-or counter-mount faucet



Part #	Mfg #	Description	Dimensions	Color	Price
186965	K-5400-W-FF	Rectangle Basin, w/ White Painted Underside	19" x 16"	Sea Salt	

Vessel Bowl Lavatories

Lavatories

Iron Plains® Wading Pool® Vessel Bathroom Sink — 20-3/4" x 14-1/4"

- Oval basin
- No faucet holes
- Overflow drain
- (P5-Black painted underside, W-White painted underside, B-Biscuit painted underside)



Part #	Mfg #	Description	Dimensions	Color	Price
225510	K-5403-P5-0	No Faucet Holes, Iron Black Underside	20-3/4" x 14-1/4"	White	
223789	K-5403-P5-20	No Faucet Holes, Iron Black Underside	20-3/4" x 14-1/4"	Suede	
228782	K-5403-P5-FD	No Faucet Holes, Iron Black Underside	20-3/4" x 14-1/4"	Cane Sugar	
169868	K-5403-P5-KA	No Faucet Holes, Iron Black Underside	20-3/4" x 14-1/4"	Black n' Tan	
227062	K-5403-P5-K4	No Faucet Holes, Iron Black Underside	20-3/4" x 14-1/4"	Cashmere	
176493	K-5403-W-0	No Faucet Holes, White Underside	20-3/4" x 14-1/4"	White	
222201	K-5403-B-96	No Faucet Holes, Biscuit Underside	20-3/4" x 14-1/4"	Biscuit	

Inscribe® Wading Pool Drop-In Bathroom Sink

- Circular basin with sloping walls
- Centered drain
- No faucet holes, requires wall- or counter-mount faucet
- Cast iron



Part #	Mfg #	Description	Dimensions	Color	Price
116583	K-2388-0	ADA Basin	16-1/2" x 16-1/2"	White	
183033	K-2388-7	ADA Basin	16-1/2" x 16-1/2"	Black	
122955	K-2388-96	ADA Basin	16-1/2" x 16-1/2"	Biscuit	
123530	K-2388-FF	ADA Basin	16-1/2" x 16-1/2"	Sea Salt	
130395	K-2388-G9	ADA Basin	16-1/2" x 16-1/2"	Sandbar	

Escale® Above-Counter Lavatory

- Overflow drain
- No faucet holes; requires wall- or counter-mount faucet
- Fireclay



Part #	Mfg #	Description	Dimensions	Color	Price
102418	K-19047-0	Less Faucet Deck	16-1/8" x 16-18"	White	
121261	K-19047-47	Less Faucet Deck	16-1/8" x 16-18"	Almond	
111175	K-19047-96	Less Faucet Deck	16-1/8" x 16-18"	Biscuit	

Leaf™ Vessel Above-Counter Lavatory

- Overflow drain with K-4061 polished chrome cap
- No faucet holes
- Fireclay



Part #	Mfg #	Description	Dimensions	Color	Price
121902	K-2530-0	Less Faucet Deck	23-5/8" x 15"	White	
183034	K-2530-47	Less Faucet Deck	23-5/8" x 15"	Almond	
170406	K-2530-96	Less Faucet Deck	23-5/8" x 15"	Biscuit	

Vessel Bowl Lavatories

Purist® Wading Pool® Above-Counter Lavatory — 24" x 23-1/2" x 4-1/16"

- Square, shallow basin with 1-3/4" depth



Part #	Mfg #	Description	Dimensions	Color	Price
123241	K-2314-0	Less Faucet Deck	24" x 23-1/2" x 4-1/16"	White	
085047	K-2314-96	Less Faucet Deck	24" x 23-1/2" x 4-1/16"	Biscuit	
101254	K-2314-1-0	1-Hole	24" x 23-1/2" x 4-1/16"	White	
221808	K-2314-1-47	1-Hole	24" x 23-1/2" x 4-1/16"	Almond	
067238	K-2314-8-0	8"cc	24" x 23-1/2" x 4-1/16"	White	
109874	K-2314-8-47	8"cc	24" x 23-1/2" x 4-1/16"	Almond	
097764	K-2314-8-96	8"cc	24" x 23-1/2" x 4-1/16"	Biscuit	

Reve® Vessel Above-Counter Lavatory

- Deep, V-shaped basin
- Overflow drain with included K-4061 Polished Chrome cap
- No faucet holes; requires wall- or counter-mount faucet
- Coordinates with other products in the Rêve collection



Part #	Mfg #	Description	Dimensions	Color	Price
135820	K-4819-0	Less Faucet Deck	21-5/8" x 14-3/4"	White	
183075	K-4819-47	Less Faucet Deck	21-5/8" x 14-3/4"	Almond	
151838	K-4819-96	Less Faucet Deck	21-5/8" x 14-3/4"	Biscuit	

Sartorial™ Wading Pool® Vessel Lavatory

- Without overflow
- Subtle lift at edges
- Herringbone white on Carillon™
- No faucet holes; requires wall- or counter-mount faucet



Part #	Mfg #	Description	Dimensions	Color	Price
232138	K-75748-HD1-0	Less Faucet Deck	17-11/16" x 17-11/16"	Herringbone	

Spun Glass® Vessel Above-Counter Lavatory

- Translucent glass round vessel
- No faucet holes



Part #	Mfg #	Description	Dimensions	Color	Price
121260	K-2276-B11	Less Faucet Deck	17-1/2" x 17-1/2"	Ice	
181476	K-2276-TG2	Less Faucet Deck	17-1/2" x 17-1/2"	Translucent Dew	

Vessel Bowl Lavatories

Turnings® Vessel Above-Counter Lavatory

- Deep, circular basin detailed with a raised swirl pattern
- No faucet holes; requires wall- or counter-mount faucet
- (-G) Glazed underside



Part #	Mfg #	Description	Dimensions	Color	Price
223426	K-2191-K4	Less Faucet Deck	16-1/4" x 16-1/4"	Cashmere	
108272	K-2191-G-K4	Less Faucet Deck	16-1/4" x 16-1/4"	Cashmere	

WaterCove® Wading Pool® Bathroom Sink

- Unique shallow basin
- No faucet holes; requires wall- or counter-mount faucet



Part #	Mfg #	Description	Dimensions	Color	Price
084860	K-2332-0	Less Faucet Deck	18-5/8" x 16-3/16"	White	

Water's Grove™ Above-Counter or Wall-Mount Vessel Bathroom Sink on Conical Bell®

- No faucet holes
- Round bowl-like basin without overflow
- Decorated with a subtly textured floral pattern
- Requires K-9655 Vessel bracket for wall-mount installation



Part #	Mfg #	Description	Dimensions	Color	Price
053925	K-14222-WG-0	Less Faucet Deck	16-1/4" x 16-1/4"	White	

Vox® Lavatory Vessel Sinks

- Basin depth: 6-7/8"
- Faucet sold separately
- With overflow



K-2660-1-0



K-2661-0



K-14800-0

Part #	Mfg #	Description	Dimensions	Color	Price
145676	K-14800-0	Round Basin, Less Faucet Deck	16-1/2" Diameter	White	
160746	K-14800-95	Round Basin, Less Faucet Deck	16-1/2" Diameter	Ice Grey	
183465	K-14800-96	Round Basin, Less Faucet Deck	16-1/2" Diameter	Biscuit	
138528	K-2661-0	Square Basin, Less Faucet Deck	16-1/4" x 16-1/4"	White	
183152	K-2661-96	Square Basin, Less Faucet Deck	16-1/4" x 16-1/4"	Biscuit	
139503	K-2660-1-0	Rectangle Basin, Single Hole Faucet Deck	23" x 18-1/8"	White	
183509	K-2660-1-96	Rectangle Basin, Single Hole Faucet Deck	23" x 18-1/8"	Biscuit	
139117	K-2660-8-0	Rectangle Basin, 8"cc Faucet Deck	23" x 18-1/8"	White	
183511	K-2660-8-47	Rectangle Basin, 8" cc Faucet Deck	23" x 18-1/8"	Almond	
227478	K-2660-8-96	Rectangle Basin, 8" cc Faucet Deck	23" x 18-1/8"	Biscuit	

Vessel Bowl Lavatories

Above-Counter Lavatories (Continued)

Vox® Lavatory Vessel Sinks

Part #	Mfg #	Description	Dimensions	Color	Price
181186	K-5373-0	Rectangle Basin, Less Faucet Deck	21-5/8" x 14-3/4"	White	
187286	K-99183-0	Oval Basin, Less Faucet Deck	20" x 14-7/8"	White	

Vessel Bowl Lavatories

Above-Counter Lavatories

Enso Above-Counter Lavatory

- Contemporary style
- Available in single hole faucet center
-Faucet sold separately
- Integral rear overflow with chrome-finished cover



Part #	Mfg #	Description	Dimensions	Color	Price
205263	311-WH	Round 18"x11" Basin Size, Single-Hole	21-1/2" x 19-1/2"	White	
205264	884	JAVA Wood Lav Vanity Enso	15-1/2" x 10-1/2"	Dark Brown	

Lavatories



Wall Hung Lavatories

Wall-Mount Lavatories

Hayes Wall-Mount Lavatory

- Ledge type
- Front overflow
- (2) Self-draining soap dishes
- 1-Piece wall hanger
- Holes provided for legs and towel bars
- Faucet sold separately



Part #	Mfg #	Description	Dimensions	Color	Price
004482	12-384	4"cc Wall-Mount	10-1/2" x 20" x 18"	White	

Monticello II Wall-Mount Lavatory

- Ledge type
- Back overflow
- (2) Self-draining soap dishes
- 1-Piece wall hanger
- Faucet sold separately



Part #	Mfg #	Description	Dimensions	Color	Price
046541	12-654	4"cc Wall-Mount	20" x 18"	White	

Plymouth Wall-Mount Lavatory

- Ledge type
- Back overflow
- (2) Self-draining soap dishes
- 1-Piece wall hanger
- Holes provided for legs and towel bars
- Faucet sold separately



Part #	Mfg #	Description	Dimensions	Color	Price
004479	12-314	4"cc Wall-Mount	12-3/4" x 19" x 17"	White	

North Point Wall-Mount Lavatory

- Recessed self draining deck
- Back overflow
- Optional wall hung shroud (29-832)
- ADA Compliant



Part #	Mfg #	Description	Dimensions	Color	Price
163811	12-478	8"cc Wall-Mount	22" x 21-1/2"	White	
163812	22-478	8"cc Wall-Mount w/ Shroud	22" x 21"	White	

Lavatories



Wall Hung Lavatories

Lavatories

West Point Wall-Mount Lavatory

- Ledge type
- Space saver
- Front overflow
- (2) Self-draining soap dishes
- 1-Piece wall hanger
- Faucet sold separately



Part #	Mfg #	Description	Dimensions	Color	Price
004481	12-354	4"cc Wall-Mount	8-1/8" x 14" x 12"	White	

Cast Iron Wall-Mount Lavatory

- Ledge type
- 3-3/4" Backsplash
- Includes wall hanger and mounting hardware



Part #	Mfg #	Description	Dimensions	Color	Price
166430	12-904	4"cc Wall-Mount	20" x 18"	White	

Wall Hung Lavatories

Vitreous China Wall-Mount Lavatories

Brenham™ Commercial Wall-Mount Lavatory — 21-15/16" x 19-3/4"

- Basin depth: 6-9/16"
- Includes wall hanger and overflow
—Model (K-1997-1N-0) has sealed overflow drain
- Drilled for concealed arm carrier
- Optional soap dispenser hole on left or right
—Right hole dispenser included with (K-1997-1R-0) model
- Model (K-199910) includes shroud
- TAS compliant



Part #	Mfg #	Description	Dimensions	Color	Price
140094	K-1997-1-0	1-Hole ADA Basin	21-15/16" x 19-3/4"	White	
186390	K-1997-1N-0	1-Hole ADA Basin, No Overflow	21-15/16" x 19-3/4"	White	
173635	K-1997-1R-0	2-Hole ADA Basin w/ RH Soap Dispenser Hole	21-15/16" x 19-3/4"	White	
140095	K-1997-4-0	4"cc ADA Basin	21-15/16" x 19-3/4"	White	
183024	K-1997-8-7	8"cc ADA Basin	21-15/16" x 19-3/4"	Black	
171114	K-1999-1-0	1-Hole ADA Basin with Shroud	21-15/16" x 19-3/4"	White	
140982	K-1999-4-0	4"cc ADA Basin with Shroud	21-15/16" x 19-3/4"	White	

Chesapeake™ Commercial Wall-Mount Lavatory with Overflow Drain— 20" x 18-1/4"

- 10-1/2" Basin depth
- Ledge-back with hanger
- Drilled for concealed arm carrier
- Model (K-1728-0) — 19-1/4" x 17-1/4"



Part #	Mfg #	Description	Dimensions	Color	Price
076540	K-1722-0	1-Hole ADA Basin	19-1/4" x 17-1/4"	White	
096722	K-1724-0	8"cc ADA Basin	19-1/4" x 17-1/4"	White	
053182	K-1728-0	4"cc ADA Basin	19-1/4" x 17-1/4"	White	
110604	K-1728-96	4"cc ADA Basin	19-1/4" x 17-1/4"	Biscuit	
056627	K-1729-0	4"cc ADA Basin	20" x 18-1/4"	White	
182410	K-1729-96	4"cc ADA Basin	20" x 18-1/4"	Biscuit	

Greenwich™ Wall-Mount Lavatory — 20-3/4" x 18-1/4"

- Ledge-back with hanger
- Drilled for concealed arm carrier
- Overflow drain
- Basin depth: 12-7/8"
- Faucet sold separately

Part #	Mfg #	Description	Dimensions	Color	Price
053160	K-2030-0	8"cc ADA Basin	20-3/4" x 18-1/4"	White	
189170	K-2030-R-0	8"cc ADA Basin w/ RH Soap Dispenser Hole	20-3/4" x 18-1/4"	White	
053164	K-2031-0	1-Hole ADA Basin	20-3/4" x 18-1/4"	White	
177282	K-2031-R-0	2-Hole ADA Basin w/ RH Soap Dispenser Hole	20-3/4" x 18-1/4"	White	
053161	K-2032-0	4"cc ADA Basin	20-3/4" x 18-1/4"	White	

Wall Hung Lavatories

Lavatories

Hampton™ Wall-Mount Lavatory Less Triton® Faucet

- Cast Iron
- Shelf-back



Part #	Mfg #	Description	Dimensions	Color	Price
182521	K-2703-EH-0	3-Hole ADA Basin	22" x 19"	White	
182423	K-2705-EH-0	3-Hole ADA Basin	19" x 17"	White	

Hudson™ Commercial Wall-Mount/Concealed Arm Carrier Lavatory

- With overflow
- Basin Depth: 13-1/2"
- Lugs for chair carrier
- Faucet not included



Part #	Mfg #	Description	Dimensions	Color	Price
168955	K-2812-0	1-Hole	20" x 18"	White	
058147	K-2867-0	4"cc	20" x 18"	White	

Hudson™ Commercial Wall-Mount Lavatory

- Basin Depth: 13-1/2"
- Faucet not included
- Made from premium materials that withstand high-volume usage



Part #	Mfg #	Description	Dimensions	Color	Price
062770	K-2805-0	1-Hole	19" x 17"	White	
057996	K-2861-0	4"cc ADA Basin	19" x 17"	White	

Kingston™ Wall-Mount Lavatory — 21-1/4" x 18-1/8"

- With back, wall hanger
- Drilled for concealed arm carrier
- Faucet sold separately
- (-R) Right-hand soap dispenser hole
- (-L) Left-hand soap dispenser hole



K-2005



K-2006



K-2007

Part #	Mfg #	Description	Dimensions	Color	Price
053157	K-2005-0	4"cc ADA Basin	21-1/4" x 18-1/8"	White	
053157	K-2005-R-0	4"cc ADA Basin	21-1/4" x 18-1/8"	White	
120125	K-2005-47	4"cc ADA Basin	21-1/4" x 18-1/8"	Almond	
079393	K-2005-7	4"cc ADA Basin	21-1/4" x 18-1/8"	Black	
059463	K-2005-96	4"cc ADA Basin	21-1/4" x 18-1/8"	Biscuit	
053159	K-2006-0	8"cc ADA Basin	21-1/4" x 18-1/8"	White	
059834	K-2007-0	1-Hole ADA Basin	21-1/4" x 18-1/8"	White	
149216	K-2007-L-0	1-Hole ADA Basin	21-1/4" x 18-1/8"	White	

Wall Hung Lavatories

Marston™ Corner Wall-Mount Lavatory Less Triton™ Faucet

- 16" x 16"
- Cast iron
- Shelf-back



Part #	Mfg #	Description	Dimensions	Color	Price
159141	K-2766-EH-0	4"cc Basin	16" x 16"	White	

Marston™ Corner Wall-Mount Lavatory with Triton™ Faucet

- 16" x 16"
- Cast iron
- Shelf-back
- Faucet includes grid drain and aerator



Part #	Mfg #	Description	Dimensions	Color	Price
068786	K-2766-0	4"cc Basin	16" x 16"	White	

Morningside™ Wall-Mount Concealed Wheelchair Bathroom Sink — 20" x 27"

- 11-1/2" Centers (K-12634-0) or 4"cc centers (K-12636-0)
- Drilled for concealed arm carrier
- ADA-compliant when installed with K-13885 offset drain



Part #	Mfg #	Description	Dimensions	Color	Price
053812	K-12634-0	3-Hole, 11-1/2"cc	20" x 27"	White	
053814	K-12636-0	3-Hole, 4"cc	20" x 27"	White	
053815	K-12638-0	1-Hole, 11-1/2"	20" x 27"	White	

Pinior® Wall-Mount Lavatory Sink — 22" x 18"

- Oval basin
- Overflow drain
- Vitreous china



K-2028 Combination: K-2028 Sink and K-2057 Shroud

Part #	Mfg #	Description	Dimensions	Color	Price
101153	K-2035-1-0	1-Hole ADA Basin	22" x 18"	White	
060872	K-2035-1-96	1-Hole ADA Basin	22" x 18"	Biscuit	
081981	K-2035-4-0	4"cc ADA Basin	22" x 18"	White	
081978	K-2035-4-96	4"cc ADA Basin	22" x 18"	Biscuit	
109305	K-2035-8-0	8"cc ADA Basin	22" x 18"	White	
139307	K-2035-8-47	8"cc ADA Basin	22" x 18"	Almond	
079197	K-2035-8-96	8"cc ADA Basin	22" x 18"	Biscuit	

Wall Hung Lavatories

Reve® Semi-Pedestal Wall-Mount Lavatory

- Fireclay
- Deep, v-shaped basin
- Overflow drain with included K-4061-CP cap



K-5148 Combination: K-5026-1 Basin, K-5031 Shroud

K-5150 Combination: K-5027-1 Basin, K-5031 Shroud

Part #	Mfg #	Description	Dimensions	Color	Price
154960	K-5148-1-0	1-Hole Basin	39-3/8" x 18-5/16"	White	
127111	K-5150-1-0	1-Hole Basin	23-5/8" x 18-5/16"	White	
174302	K-5150-1-47	1-Hole Basin	23-5/8" x 18-5/16"	Almond	

Soho® Wall-Mount Concealed Carrier Bathroom Sink

- Drilled for right or left concealed arm carrier
—Included with sink if (L) or (R) appears in model number



Part #	Mfg #	Description	Dimensions	Color	Price
059526	K-2054-0	4"cc Basin	20" x 18"	White	
169879	K-2054-47	4"cc Basin	20" x 18"	Almond	
068118	K-2084-0	1-Hole Basin	20" x 18"	White	
182415	K-2084-L-0	2-Hole Basin w/ LH Soap Dispenser Hole	20" x 18"	White	
182416	K-2084-R-0	2-Hole Basin w/ RH Soap Dispenser Hole	20" x 18"	White	

Lavatories

Wall Hung Lavatories

Wall Hung Lavatories Spruce Cove Wall Mount Lavatory

- Wall-mount lavatory
- Compact size is a perfect fit when space is limited
- Concealed front overflow
- Includes hanger
- 4" faucet center



Part #	Mfg #	Description	Dimensions	Color	Price
192325	1613NS-WH	Wall Hung Basin	16-1/8" x 13-1/4"	White	

Grande Isle Wall Hung Lavatory

- Wall-mount lavatory
- Full 4" high backsplash
- Drilled for concealed arm carrier
- Concealed front overflow
- Available in single hole, 4" and 8" faucet centers



Part #	Mfg #	Description	Dimensions	Color	Price
211914	2018HB-NS-1-WH	Wall Hung ADA Basin	22" x 18-1/8"	White	
193469	2018HB-NS-4-WH	Wall Hung ADA Basin	22" x 18-1/8"	White	

Cleaners

Hand Cleaners

Klein Kleeners® Hand Cleaning Towels

- Pre-moistened towels
- Powerful, gentle, pumice like cleansing action
- No rinsing, no drying, no residue
- 10-1/2" x 12-1/4"



Part #	Mfg #	Description	Price
125643	51425	(72) Count Tub	



Cleaners

(Hand Cleaners)



38156

Part #	Mfg #	Description	Price
041715	38050	Towels-In-A-Tub, Resealable	
017668	38156	Plumb Label Power Scrub	

Cit-Grit Hand Cleaner

- Natural citrus formula, biodegradable
- Contains aloe, lanolin and jojoba oil
- Flip-top spout plastic bottle



Part #	Mfg #	Description	Price
005539	038125	15 fl oz	

Cleaners & Lubricants

Cleaners

Ice Machine Maintenance

Nickel-Safe Ice Machine Cleaner

- For removing scale deposits on nickel-plated or tin-plated evaporators
- USDA Approved



Part #	Mfg #	Description	Price
133631	4287-34	16 fl oz	



Cleaners

Cleaners

Gel-Gloss® Cleaner

- *Contains non-harmful abrasive cleaning agents that remove surface oxidation and light scratches while leaving behind a protective carnauba wax coating*
- *Cleans, protects and restores luster while providing a long lasting protective finish*

Part #	Mfg #	Description	Price
120346	GA-12	12 oz, Aerosol	

Gel-Gloss® No-Streak Glass & Silver Polish Cleaner

- *Contains silicone and protects like a wax*
- *Wipe it on, allow it to dry to a haze and polish it off*
- *Cleaner works aggressively on hard water spots and tough residue*
- *Beads water and leaves behind a protective coating*

Part #	Mfg #	Description	Price
141442	NS-8	1/2 pt	



Lubricants

Pipe Joint Lubricant

Plumber's Faucet & Valve Grease

- *Waterproof*
- *Resists high temperature*
- *Frees sticky faucets, prevents rust*
- *Use on hot water or steam up to 350°F*



Part #	Mfg #	Description	Price
029140	05005012	1 oz Tube	

Cleaners & Lubricants

Lubricants

ProTool Lube®

- Extends tool life
- Synthetic blend for cutting, milling, reaming, tapping and drilling metal, wood and plastics
- Water-soluble
- Biodegradable and non-toxic
- Flip-top bottle



Part #	Mfg #	Description	Price
024971	68040	6 oz Bottle Countertop Merchandiser, 12-Pack	

Cleaners & Lubricants

Lubricants

Lubricants

Pull-A-Spout Oiler

- All purpose oiler
- 14" Telescoping spout



Part #	Mfg #	Size	Price
002300	CO-1	4 oz	

Rust Breaker

- Loosens rusted bolts, screws, shafts, piping etc
- Telescoping spout applicator



Part #	Mfg #	Size	Price
002299	CR-1	4 oz	

Cleaners & Lubricants



Lubricants

Lubricants

Dow 111 Silicone Lubricant

- For o-rings and valve stems



Part #	Mfg #	Tub Size	Price
060945	963-01	1/4 Ounce	

Cleaners & Lubricants

Lubricants

WD-40® Lubricants

- Cleans, lubricates, displaces moisture
- Penetrates stuck metal parts
- Protects against rust and corrosion



Part #	Mfg #	Size	Price
045103	S95-700	8 oz	

Acid Waste Pipe

Acid Waste Pipe

Blueline Sch 40 Prox Pipe - 10' Length

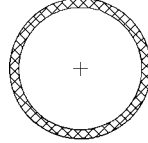

Part #	Mfg #	Size	Price
148517	S40	1-1/2"	

Pipe

Aluminum Tubing

Aluminum Tubing

- 1100 Alloy
- "O" Temper
- Dead soft
- 50' Coils



Part #	Mfg #	OD	Wall Thickness	Price
014965	61020-06	3/8"	.035	

Aluminum Tubing

Service Products & Parts
(Aluminum Tubing)

- Wall thickness: 0.035"
- Meets ASTM standards



Part #	Mfg #	OD Size	Length	Price
074787	11-291	1/8"	5' w/Fittings	
044424	11-293	1/4"	5' w/Fittings	

Pipe

Aluminum Tubing

Soft Aluminum Tubing



Part #	Mfg #	Size	Price
013454	T27250	1/4" OD x 50' Coil	
098414	T27188	3/16" OD x 50' Coil	

Black Steel Pipe

Black Steel Pipe

Black Steel Std Wt TBE Pipe



Part #	Model	Size	Price
042650	1210TBE	1/2" x 10'	
042651	3410TBE	3/4" x 10'	
042654	110TBE	1" x 10'	

Black Steel Cut Pipe - TBE

• Import



Part #	Model	Size	Price
145907	1210TBEI	1/2" x 10'	
145908	3410TBEI	3/4" x 10'	
145909	110TBEI	1" x 10'	

Black Steel A53 Threaded & Coupled Pipe



Part #	Model	Size	Price
013660	18BTC	1/8"	
013473	14BTC	1/4"	
014985	38BTC	3/8"	
013051	12BTC	1/2"	
014629	34BTC	3/4"	
012189	1BTC	1"	
012770	114BTC	1-1/4"	
012388	112BTC	1-1/2"	
013760	2BTC	2"	
014062	212BTC	2-1/2"	
014313	3BTC	3"	

Black Steel Std Wt Pipe - T&C

• Import



Part #	Model	Size	Price
145897	12BTCI	1/2"	
145901	34BTCI	3/4"	
145902	1BTCI	1"	
145903	114BTCI	1-1/4"	
145904	112BTCI	1-1/2"	

Black Steel Pipe (Continued)

Black Steel Std Wt Pipe - T&C

Part #	Model	Size	Price
145905	2BTCI	2"	

Black Steel A53 PE Pipe



Part #	Model	Size	Price
013037	12BPE	1/2"	
014614	34BPE	3/4"	
012175	1BPE	1"	
012758	114BPE	1-1/4"	
012375	112BPE	1-1/2"	
013750	2BPE	2"	

Black Steel A53 PE ERW Pipe



Part #	Model	Size	Price
014058	212BPE	2-1/2"	
014309	3BPE	3"	
015195	4BPE	4"	

Black Steel Extra-Heavy A53 PE Pipe



Part #	Model	Size	Price
013215	12XHPE	1/2"	
014781	34XHPE	3/4"	
012295	1XHPE	1"	
012879	114XHPE	1-1/4"	
012557	112XHPE	1-1/2"	
014461	3XHPE	3"	

Black Steel Extra-Heavy A53 Threaded & Coupled Pipe



Part #	Model	Size	Price
034190	12XHTEC	1/2"	
040292	34XHTEC	3/4"	

Pipe



Black Steel Pipe

Black Steel Sch 40 ERW Grooved Pipe

Part #	Model	Size	Price
051979	212S40BLKGROOV	2-1/2"	
030523	3S40BLKGROOV BEN	3"	
030522	4S40BLKGROOV BEN	4"	
030521	6S40BLKGROOV BEN	6"	

Pipe



Cast Iron Pipe & Fittings

Cast Iron No-Hub Soil Pipe



Cast Iron No-Hub Soil Pipe 10' Lengths

Part #	Mfg #	Size	Price
012485	00128	1-1/2" x 10'	
013857	00129	2" x 10'	
014379	00130	3" x 10'	
015250	00131	4" x 10'	
015513	00132	5" x 10'	
015631	00133	6" x 10'	
015790	00134	8" x 10'	
040265	00135	10" x 10'	
052840	09606	12" x 10'	
052841	09607	15" x 10'	

Cast Iron Service-Weight Single-Hub Soil Pipe

Cast Iron Service-Weight Single-Hub Soil Pipe 5' Lengths

Part #	Mfg #	Size	Price
014273	00851	2" x 5'	
014951	00852	3" x 5'	
015493	00853	4" x 5'	
015552	00854	5" x 5'	
015742	00855	6" x 5'	
015854	00856	8" x 5'	
012328	00857	10" x 5'	
013375	00858	12" x 5'	

Cast Iron Service-Weight Single-Hub Soil Pipe 10' Lengths

Part #	Mfg #	Size	Price
013976	00869	2" x 10'	
014475	00870	3" x 10'	
015360	00871	4" x 10'	
015534	00872	5" x 10'	
015706	00873	6" x 10'	
015838	00874	8" x 10'	
012321	00875	10" x 10'	
013224	00876	12" x 10'	
013623	00877	15" x 10'	

Cast Iron Service-Weight Double-Hub Soil Pipe

Cast Iron Service-Weight Double-Hub Soil Pipe 5' Lengths

Part #	Mfg #	Size	Price
014271	00864	2" x 5'	
014949	00865	3" x 5'	
015491	00866	4" x 5'	
015551	00867	5" x 5'	
015740	00868	6" x 5'	

Pipe

Copper Pipe

Line Sets



Mini-Split Line Set - 3/8" Insulation Both Lines Insulated

Part #	Mfg #	Liq Line	Suct Line	Length	Price
096828	40680250B6	1/4"	3/8"	25'	
146400	40680350B6	1/4"	3/8"	35'	
096832	40680500B6	1/4"	3/8"	50'	
096834	40880250B6	1/4"	1/2"	25'	
096836	40880500B6	1/4"	1/2"	50'	
096840	41080250B6	1/4"	5/8"	25'	
096838	41080500B6	1/4"	5/8"	50'	
149515	60880250B6	3/8"	1/2"	25'	
149517	60880500B6	3/8"	1/2"	50'	
096843	61080250B6	3/8"	5/8"	25'	
096845	61080500B6	3/8"	5/8"	50'	

Series 410 - 3/8" Insulation Line Set

Part #	Mfg #	Liq Line	Suct Line	Length	Price
013612	41080250	1/4"	5/8"	25'	
013613	41080500	1/4"	5/8"	50'	

Series 412 - 3/8" Insulation Line Set

Part #	Mfg #	Liq Line	Suct Line	Length	Price
013593	41280250	1/4"	3/4"	25'	
082476	41280350	1/4"	3/4"	35'	
013594	41280500	1/4"	3/4"	50'	

Series 512 - 3/8" Insulated Line Set

Part #	Mfg #	Liq Line	Suct Line	Length	Price
034271	51280250	5/16"	3/4"	25'	

Series 610 - 3/8" Insulation Line Set

Part #	Mfg #	Liq Line	Suct Line	Length	Price
015165	61080250	3/8"	5/8"	25'	
015166	61080500	3/8"	5/8"	50'	

Series 612 - 3/8" Insulation Line Set

Part #	Mfg #	Liq Line	Suct Line	Length	Price
015131	61280250	3/8"	3/4"	25'	
082477	61280350	3/8"	3/4"	35'	
015132	61280500	3/8"	3/4"	50'	

Series 614 - 3/8" Insulation Line Set

Part #	Mfg #	Liq Line	Suct Line	Length	Price
015172	61480250	3/8"	7/8"	25'	
082478	61480350	3/8"	7/8"	35'	
015173	61480500	3/8"	7/8"	50'	

Series 618 - 3/8" Insulation Line Set

Part #	Mfg #	Liq Line	Suct Line	Length	Price
053832	61880250	3/8"	1-1/8"	25'	
017303	61880500	3/8"	1-1/8"	50'	

Pipe

Copper Pipe

Type DWV Copper Drainage Tube

- Used for drainage, waste and vents
- For drainage waste, vents, soil and other non-pressure applications
- ASTM B306

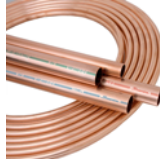

Type DWV Hard Copper Water Tube - Straight Lengths

Part #	Mfg #	Size	Length	Price
012452		1-1/2"	20'	
013822		2"	20'	

Type K (Heavy Wall) Copper Water Tube

- ASTM B88



Type K Soft Copper Water Tube - Coils

Part #	Mfg #	Size	Length	Price
013529		1/4"	60'	
013528		1/4"	100'	
015048		3/8"	60'	
015047		3/8"	100'	
013158		1/2"	60'	
013157		1/2"	100'	
014729		3/4"	60'	
014728		3/4"	100'	
012257		1"	60'	
012256		1"	100'	
012848		1-1/4"	60'	
012478		1-1/2"	60'	
013844		2"	40'	
166166		2"	60'	

Type K Soft Copper Water Tube - Straight

Part #	Mfg #	Size	Length	Price
051141		1-1/2"	20'	
013843		2"	20'	

Type K Hard Copper Water Tube - Straight Lengths

Part #	Mfg #	Size	Length	Price
014727		3/4"	20'	
012255		1"	20'	
012846		1-1/4"	20'	
013842		2"	20'	

Type K OXY/MED Copper Tube

- Use for medical gas systems
- Special care and handling to prevent contamination of the system
- Specially cleaned for use in medical gas systems and meets the same allowable residue limit of 0.0035 g/sq ft of interior tube surface area
- ASTM B819



Green Capped Copper Tube - Straight Lengths

- After cleaning, fitted with plastic caps to maintain the clean interior surface

Part #	Mfg #	Size	Length	Price
013526		1/4"	20'	
013155		1/2"	20'	
014726		3/4"	20'	
012254		1"	20'	
020311		1-1/2"	20'	
071190		2"	20'	

Type L (Medium Wall) Copper Water Tube

- For residential and commercial use
- For domestic water service and distribution, fire protection, solar, fuel/fuel oil, HVAC, snow melting, compressed air, natural gas, liquefied petroleum (LP) gas, vacuum uses
- ASTM B88



Type L Soft Copper Water Tube - Coils

Part #	Mfg #	Size	Length	Price
013532		1/4"	60'	
026713		1/4"	100'	
015051		3/8"	60'	
015050		3/8"	100'	
013162		1/2"	60'	
013161		1/2"	100'	
185847		1"	100'	
185849		1-1/4"	60'	
185850		1-1/4"	100'	
185851		2"	60'	

Type L Hard Copper Water Tube - Straight Lengths

Part #	Mfg #	Size	Length	Price
013530		1/4"	20'	
015049		3/8"	20'	
082682		1/2"	10'	
013159		1/2"	20'	

Copper Pipe

Type L (Medium Wall) Copper Water Tube (Continued)

Type L Hard Copper Water Tube - Straight Lengths

Part #	Mfg #	Size	Length	Price
082683		3/4"	10'	
014730		3/4"	20'	
082684		1"	10'	
012258		1"	20'	
012849		1-1/4"	20'	
012479		1-1/2"	20'	
013846		2"	20'	
014104		2-1/2"	20'	
014369		3"	20'	
015239		4"	20'	

Type M (Light Wall) Copper Water Tube

- For above ground residential and light commercial use
- For general plumbing and heating purposes; drainage waste, vent and other light pressure uses
- ASTM B88



Type M hard Copper Water Tube - Straight Lengths

Part #	Mfg #	Size	Length	Price
013164		1/2"	10'	
013163		1/2"	20'	
014734		3/4"	10'	
014733		3/4"	20'	
040503		1"	10'	
012260		1"	20'	
012850		1-1/4"	20'	
185848		1-1/2"	10'	
012480		1-1/2"	20'	
013848		2"	20'	

(ACR/OXY/MED) Copper Tube

- Use for air conditioning and refrigeration and medical gas systems
- Meets the highest industry standards and provides superior cleanliness for the contaminant-free transportation of refrigerants, oxygen and other gases
- Specially cleaned for use in medical gas systems and meets the same allowable residue limit of 0.0035 g/sq ft of interior tube surface area
- ASTM B280/ASTM B819



Blue Nitrogen Charged Copper Tube - Straight Lengths

- Nitrogen pressurized ACR tube
- Purged with dry nitrogen and ends sealed with rubber plugs to maintain a positive pressure of nitrogen inside the tube
- Ink marked "N2 Gas" to clearly identify to user

Part #	Mfg #	Size	Length	Price
014963		3/8"	20'	
013023		1/2"	20'	
015558		5/8"	20'	
014601		3/4"	20'	
015766		7/8"	20'	
013013		1-1/8"	20'	
013446		1-3/8"	20'	
013630		1-5/8"	20'	
014202		2-1/8"	20'	
018617		2-5/8"	20'	
021189		3-1/8"	20'	

Soft Copper Refrigeration Tube - Coils

- For manufacture, installation and maintenance of refrigeration equipment
- ASTM B280



Part #	Mfg #	Size	Length	Price
013686		1/8"	50'	
013538		1/4"	50'	
015055		3/8"	50'	
015537		5/16"	50'	
013198		1/2"	50'	
015583		5/8"	50'	
014764		3/4"	50'	
015777		7/8"	50'	
013019		1-1/8"	50'	



CPVC Schedule 80 Pipe

CPVC Schedule 80 Pipe

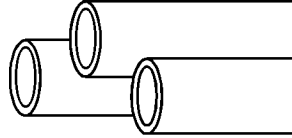

CPVC Sch 80 Pipe - 20' Lengths

Part #	Mfg #	Size	Price
020016	PD-800-005C	1/2" x 20'	
018017	PD-800-007C	3/4" x 20'	
018026	PD-800-010C	1" x 20'	
018027	PD-800-012C	1-1/4" x 20'	
018028	PD-800-015C	1-1/2" x 20'	
018021	PD-800-020C	2" x 20'	
087749	PD-800-025C	2-1/2" x 20'	
018022	PD-800-030C	3" x 20'	
018023	PD-800-040C	4" x 20'	
031711	PD-800-060C	6" x 20'	
136946	PD-800-080C	8" x 20'	



CPVC Pipe

CPVC Hot/Cold Pipe (NSF-pw)

- 100 psi @ 180°F
- ASTM D-2846

Part #	Mfg #	Nom Pipe Size	Price
013220	44905	1/2" x 10'	
014788	44910	3/4" x 10'	

CPVC Pipe

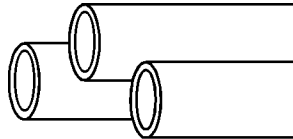

CPVC Sch 40 Pipe - 20' Lengths

Part #	Mfg #	Size	Price
147042	PD-400-025C	2-1/2" x 20'	



CPVC Schedule 80 Pipe

LabWaste™ CPVC Corrosive Waste Drainage System Pipe

Part #	Mfg #	Size	Price
085948	LW-015	1-1/2"	
085947	LW-020	2"	
085946	LW-030	3"	
089663	LW-040	4"	

Flexible Gas Pipe



TracPipe® PS-II Flexible Underground Gas Piping

- Pre-sleeved with flexible black jacket and yellow lay line for underground applications
- Vented containment system for added safety
- Extremely resistant to damage
- Quick attachment fittings
- Supports/contains NPT connections
- Installs in long lengths without joints



Part #	Mfg #	Size	Length	Price
119633	FGP-UGP-500-100	1/2"	100'	

TracPipe® CounterStrike® Flexible Gas Piping

- CSA Approved semi-rigid 300 Series stainless steel jacketed with proprietary polymer
- Bends and conforms by hand
- Cuts with a standard tube cutter
- Rated for indoor and outdoor use
- Up to 75% fewer joints than black iron pipe per installation
- Weighs a fraction of black iron pipe



Part #	Mfg #	Size	Length	Price
134930	FGP-CS-500-50	1/2"	50'	
115274	FGP-CS-500-100	1/2"	100'	
119604	FGP-CS-500-250	1/2"	250'	
140664	FGP-CS-750-50	3/4"	50'	
119606	FGP-CS-750-100	3/4"	100'	
119605	FGP-CS-750-250	3/4"	250'	
142279	FGP-CS-100-50	1"	50'	
117807	FGP-CS-100-100	1"	100'	
119607	FGP-CS-100-180	1"	180'	
144080	FGP-CS-150-150	1-1/2"	150'	

Pipe

Flexible Gas Pipe

Wardflex Tubing

304 Wardflex CSST Tubing Stainless Steel

- Quick and easy installation
- Lightweight and flexible
- Fewer fittings
- Polyethylene jacket-
UV Inhibitors - ASTM E84
compliant
- Coating marked every 2 feet
- 100% leak tested



Part #	Mfg #	Size	Length	Price
193682	WF118	1/2"	50'	
193681	WF116	1/2"	100'	
190544	WF114	1/2"	250'	
193684	WF128	3/4"	50'	
193683	WF126	3/4"	100'	
190545	WF125	3/4"	180'	
194732	WF138	1"	50'	
194712	WF136	1"	100'	
196154	WF148	1-1/4"	50'	

Wardflex Max CSST Corrugated Stainless Steel Tubing

- Quick and easy installation
- Lightweight and flexible
- Fewer fittings
- Conductive Polyethylene jacket
Conductive Coating - UV Inhibitors
- Coating marked every 2 feet
- 100% leak tested"



Part #	Mfg #	Size	Length	Price
221642	WFC18	1/2"	50'	
219063	WFC16	1/2"	100'	
221644	WFC28	3/4"	50'	
221643	WFC26	3/4"	100'	
221646	WFC38	1"	50'	
219064	WFC36	1"	100'	

Pipe

Flexible Gas Pipe

Safety System™ Flexible Gas Connectors

- Design certified for 0.5 psig maximum operating pressure
- Minimum required BTUH capacities for B & BP model gas connectors are defined by ANSI Z21.69/CSA 6.16
- Flow rating BTUH 0.64 SP.GR @ 0.5"wc pressure drop

Safety System™ Moveable Gas Connector



Part #	Mfg #	Inside Dia	BTUH	Lgth	Price
138011	1675 BP 48	3/4"	225,000	48"	
138013	16100 BP 36	1"	512,000	36"	

Supr-Safe® Quick Disconnect Gas Appliance Connector Assemblies

- Stainless steel corrugated hose, encased in stainless steel braid, covered by thick Supr-Flex™ coating
- Fitted with an A type "push-to-connect" quick disconnect coupling



Part #	Mfg #	Size	Price
138012	1675-BPQR-48	3/4" x 48", with Restraining Device	

Gas Flex Connectors

Corrugated Gas Appliance Connectors - ProCoat® Coated Stainless Steel

- Superior corrosion resistance
- CSA Design-certified for indoor and outdoor use
- 100% Leak tested

Large Diameter ProCoat® Gas Connector - 3/4" ID (7/8" OD) Tube with Fittings

Part #	Mfg #	Size	Length	Price
112020	CSSB22-24	3/4" FIP x 3/4" FIP	24"	
091108	CSSB22-36	3/4" FIP x 3/4" FIP	36"	

ProCoat® SS Gas Connector - 1/2" ID (5/8" OD) Tube with Fittings



Part #	Mfg #	Size	Length	Price
070254	CSSC22-12	3/4" FIP x 3/4" FIP	12"	
070255	CSSC22-18	3/4" FIP x 3/4" FIP	18"	
070256	CSSC22-24	3/4" FIP x 3/4" FIP	24"	
070258	CSSC22-36	3/4" FIP x 3/4" FIP	36"	
070259	CSSC22-48	3/4" FIP x 3/4" FIP	48"	
070260	CSSC22-60	3/4" FIP x 3/4" FIP	60"	
098505	CSSC54-60	1/2" FIP x 1/2" MIP	60"	

ProCoat® SS Gas Connector - 3/8" ID (1/2" OD) Tube with Fittings

Part #	Mfg #	Size	Length	Price
070261	CSSD55-12	1/2" FIP x 1/2" FIP	12"	
070262	CSSD55-18	1/2" FIP x 1/2" FIP	18"	
070265	CSSD55-24	1/2" FIP x 1/2" FIP	24"	
070266	CSSD55-36	1/2" FIP x 1/2" FIP	36"	
070267	CSSD55-48	1/2" FIP x 1/2" FIP	48"	
073871	CSSD55-60	1/2" FIP x 1/2" FIP	60"	

Pipe

Galvanized Steel Pipe

Galvanized Steel A53 Standard Pipe

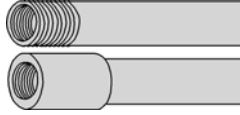

Part #	Size	Type	Price
013522	1/4"	T&C	
015041	3/8"	T&C	
013149	1/2"	T&C	
014718	3/4"	T&C	
012249	1"	T&C	
012840	1-1/4"	T&C	
012471	1-1/2"	T&C	
013836	2"	T&C	
014362	3"	T&C	

Galvanized Steel A53 Extra Heavy Pipe

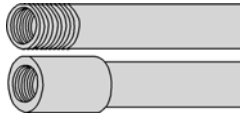

Part #	Size	Type	Price
056924	3/4"	T&C	

PEX Tubing

Uponor AquaPEX® Non-Barrier Tubing

- Can be used in hot and cold potable water distribution systems and hydronic heating applications where the system contains no ferrous corrodible components or where ferrous components are isolated from the tubing
- Colored coded tubing for installation purposes

AquaPEX® White Tubing



Part #	Mfg #	Size	Length	Price
030788	F1040250	1/4"	100'	
121223	F1040500	1/2"	100'	
022597	F1060500	1/2"	300'	
027954	F1120500	1/2"	1,000'	
114360	F1040750	3/4"	100'	
022038	F1060750	3/4"	300'	
069777	F1041000	1"	100'	
027060	F1061000	1"	300'	
040647	F1061250	1-1/4"	100'	
039657	F1061500	1-1/2"	100'	
070885	F1021500	1-1/2"	300'	
107684	F1062000	2"	100'	
142637	F1052000	2"	200'	

AquaPEX® White Straight Length



Part #	Mfg #	Size	Length	Price
024694	F1930500	1/2"	20'	
024695	F1930750	3/4"	20'	
031578	F1921000	1"	20'	
087229	F1921250	1-1/4"	20'	
099651	F1921500	1-1/2"	20'	
104100	F1922000	2"	20'	
185086	F1922500	2-1/2"	20'	
135531	F1923000	3"	20'	

AquaPEX® Plus Red Tubing



Part #	Mfg #	Size	Length	Price
106201	F2040500	1/2"	100'	
082248	F2060500	1/2"	300'	
082250	F2120500	1/2"	1,000'	
109383	F2040750	3/4"	100'	
082246	F2060750	3/4"	300'	

AquaPEX® Plus Red Straight Length



Part #	Mfg #	Size	Length	Price
086380	F2930500	1/2"	20'	
086382	F2930750	3/4"	20'	
108508	F2921000	1"	20'	

AquaPEX® Plus Blue Tubing



Part #	Mfg #	Size	Length	Price
086810	F3040500	1/2"	100'	
082249	F3060500	1/2"	300'	
082251	F3120500	1/2"	1,000'	
109382	F3040750	3/4"	100'	
082247	F3060750	3/4"	300'	
105063	F3041000	1"	100'	
104483	F3061000	1"	300'	

AquaPEX® Plus Blue Straight Length



Part #	Mfg #	Size	Length	Price
086379	F3930500	1/2"	20'	
086381	F3930750	3/4"	20'	
086383	F3921000	1"	20'	

Pipe

PEX Tubing

Uponor Pre-Insulated AquaPEX® Tubing

- *Complies with energy-code requirements*
- *Easily installed in tight, confined spaces*
- *Insulation runs entire length of tubing*
- *Reduces water waste and hot-water delivery wait times*

AquaPEX® Pre-Insulated Tubing - 1/2" Insulation



Part #	Mfg #	Size	Length	Price
136760	F6040500	1/2"	100'	
136763	F6040750	3/4"	100'	

Tubing Supports

PEX-a Pipe Support

- *Available in 1/2" to 3-1/2" sizes for suspended piping applications in commercial plumbing and hydronic distribution systems*
- *Each package includes 15 support straps*



Part #	Mfg #	Description	Price
164952	F7040500	1/2", 9-ft Length 5/Pkg	
160457	F7040750	3/4", 9-ft Length 5/Pkg	
153171	F7041000	1", 9-ft Length 5/Pkg	
153172	F7041250	1-1/4", 9-ft Length 5/Pkg	
153173	F7041500	1-1/2", 9-ft Length 5/Pkg	
153174	F7042000	2", 9-ft Length 5/Pkg	
185293	F7043000	3", 9-ft Length 5/Pkg	

Pipe

PEX Tubing

Reel Tubing

Red Stud Reel with Tubing

Part #	Mfg#	Order #	Size	Price
100558	WPSR06-500R	0651018	3/8" x 500'	
100560	WPSR08-300R	0651020	1/2" x 300'	

Blue Stud Reel with Tubing

Part #	Mfg#	Order #	Size	Price
100559	WPSR06-500B	0651017	3/8" x 500'	
100561	WPSR08-300B	0651019	1/2" x 300'	

WaterPEX® Potable PEX Plumbing



Red Coil

Part #	Mfg#	Order #	Size	Price
075750	WPTC06-100R	0650375	3/8" x 100'	
106897	WPTC08-100R	0650377	1/2" x 100'	
129429	WPTC08-300R	0650996	1/2" x 300'	
075548	WPTC08-500R	0650378	1/2" x 500'	
075556	WPTC12-100R	0650380	3/4" x 100'	

Red 20' Sticks

Part #	Mfg#	Order #	Size	Price
075565	WPTS08-50R	0650404	1/2" x 20'	
075569	WPTS12-25R	0650405	3/4" x 20'	

Blue Coil

Part #	Mfg#	Order #	Size	Price
106896	WPTC08-100B	0650385	1/2" x 100'	
129430	WPTC08-300B	0650997	1/2" x 300'	
075560	WPTC08-500B	0650386	1/2" x 500'	
075562	WPTC12-100B	0650388	3/4" x 100'	

Blue 20' Sticks

Part #	Mfg#	Order #	Size	Price
075567	WPTS08-50B	0650406	1/2" x 20'	
075570	WPTS12-25B	0650407	3/4" x 20'	

White Coil

Part #	Mfg#	Order #	Size	Price
130416	WPTC08-100 W	0650394	1/2" x 100'	
130418	WPTC08-300 W	0650998	1/2" x 300'	
130420	WPTC12-100 W	0650397	3/4" x 100'	
077564	WPTC16-100 W	0650400	1" x 100'	

White 20' Sticks



Part #	Mfg#	Order #	Size	Price
130419	WPTS08-50W	0650408	1/2" x 20'	
130421	WPTS12-25W	0650409	3/4" x 20'	
077565	WPTS16-5W	0650410	1" x 20'	

Pipe



PEX Tubing

Viega PureFlow® Tubing

ViegaPEX™ - Coil

- Red
- ASTM F876/F877
- PEX 5006 (CL5)
- Zero Lead™



Part #	Mfg #	Size	Price
099594	32121	1/2" x 100'	
099792	32123	1/2" x 300'	
087148	32125	1/2" x 500'	
088823	32141	3/4" x 100'	
099794	32143	3/4" x 300'	
099793	32145	3/4" x 500'	

ViegaPEX™ - Straight Length

- Red
- ASTM F876/F877
- PEX 5006 (CL5)
- Zero Lead™



Part #	Mfg #	Size	Price
092778	33120	1/2" x 20'	
092775	33145	3/4" x 20'	

ViegaPEX™ - Coil

- Blue
- ASTM F876/F877
- PEX 5006 (CL5)
- Zero Lead™



Part #	Mfg #	Size	Price
099593	32221	1/2" x 100'	
099789	32223	1/2" x 300'	
087149	32225	1/2" x 500'	
088824	32241	3/4" x 100'	
099790	32243	3/4" x 300'	
099791	32245	3/4" x 500'	

ViegaPEX™ - Straight Length

- Blue
- ASTM F876/F877
- PEX 5006 (CL5)
- Zero Lead™



Part #	Mfg #	Size	Price
092777	33240	1/2" x 20'	
092774	33265	3/4" x 20'	

ViegaPEX™ - Coil

- White
- ASTM F876/F877
- PEX 5006 (CL5)
- Zero Lead™



Part #	Mfg #	Size	Price
099782	32021	1/2" x 100'	
102117	32023	1/2" x 300'	
099783	32020	1/2" x 1,000'	
099786	32041	3/4" x 100'	
099787	32043	3/4" x 300'	

ViegaPEX™ Ultra - Straight Length

- Red
- ASTM F876/F877
- PEX 5006 (CL5)
- Up to 6 months UV resistance
- Zero Lead™



Part #	Mfg #	Size	Price
108436	33551	1" x 20'	

ViegaPEX™ Ultra - Straight Length

- Blue
- ASTM F876/F877
- PEX 5006 (CL5)
- Up to 6 months UV resistance
- Zero Lead™



Part #	Mfg #	Size	Price
105396	33651	1" x 20'	

Pipe



PEX Tubing

ViegaPEX™ Ultra - Coil

- Black
- ASTM F876/F877
- PEX 5006 (CL5)
- Up to 6 months UV resistance
- Zero Lead™



Part #	Mfg #	Size	Price
130538	32721	1/2" x 100'	
105170	32723	1/2" x 300'	
110755	32741	3/4" x 100'	
106535	32743	3/4" x 300'	

ViegapeX™ Ultra - Straight Length

- Black
- ASTM F876/F877
- PEX 5006 (CL5)
- Up to 6 months UV resistance
- Zero Lead™



Part #	Mfg #	Size	Price
099823	33720	1/2" x 20'	
099824	35745	3/4" x 20'	
099825	35761	1" x 20'	
187699	35771	1-1/4" x 20'	
187700	35781	1-1/2" x 20'	
187701	33791	2" x 20'	

ViegapeX™ FrostaPEX™ - Straight Length

- Silver
- PEX/AL/PE
- ASTM F876, ASTM F877
- Up to 6 months UV resistance
- PEX 5306



Part #	Mfg #	Size	Price
152664	35520	1/2" x 20'	
152665	35540	3/4" x 20'	

Pipe

PEX Tubing

PowerPEX

PEX Tubing—20' Stick Bundles

- Complete offering
- Quality
- Made in America



Part #	Mfg #	Color	Size	Price
226729	664X2B20	Blue	1/2"	
226751	664X3B20	Blue	3/4"	
226732	664X4B20	Blue	1"	
226734	664X2R20	Red	1/2"	
226735	664X3R20	Red	3/4"	
226736	664X4R20	Red	1"	
226760	664X2W20	White	1/2"	
226761	664X3W20	White	3/4"	
230192	664X4W20	White	1"	

PEX Tubing

Zurn PEX Non-Barrier Tubing

PEX Clear Coiled Tubing

- Flexible, easy to install, low-lead compliant tubing
- Requires fewer fittings
- Resistant to mineral build-up and freeze damage



Part #	Mfg #	Size	Price
193020	Q0PC100	1/8" x 100'	

PEX Blue Coiled Tubing

- Flexible, low-lead compliant tubing, used in potable plumbing applications
- Easy to install and requires fewer fittings
- Resistant to mineral build-up and freeze damage



Part #	Mfg #	Size	Price
218332	Q2PC500XBL UE	3/8" x 500'	
194178	Q3PC100XBL UE	1/2" x 100'	
203758	Q3PC300XBL UE	1/2" x 300'	
194179	Q3PC500XBL UE	1/2" x 500'	
194180	Q4PC100XBL UE	3/4" x 100'	
194181	Q4PC500XBL UE	3/4" x 500'	
199674	Q5PC100XBL UE	1" x 100'	
203761	Q5PC300XBL UE	1" x 300'	

PEX Red Coiled Tubing

- Flexible, low-lead compliant tubing, used in potable plumbing applications
- Easy to install and requires fewer fittings
- Resistant to mineral build-up and freeze damage



Part #	Mfg #	Size	Price
218321	Q2PC500XRE D	3/8" x 500'	
194173	Q3PC100XRE D	1/2" x 100'	
203759	Q3PC300XRE D	1/2" x 300'	

Zurn PEX Non-Barrier Tubing (Continued)

PEX Red Coiled Tubing

Part #	Mfg #	Size	Price
194174	Q3PC500XRE D	1/2" x 500'	
194175	Q4PC100XRE D	3/4" x 100'	
194176	Q4PC500XRE D	3/4" x 500'	
216381	Q5PC100XRE D	1" x 100'	
203762	Q5PC300XRE D	1" x 300'	

PEX White Coiled Tubing

- Flexible, easy to install, low-lead compliant tubing
- Requires fewer fittings
- Resistant to mineral build-up and freeze damage



Part #	Mfg #	Size	Price
193009	Q1PC100X	1/4" x 100'	
193010	Q2PC100X	3/8" x 100'	
193011	Q3PC100X	1/2" x 100'	
203760	Q3PC300X	1/2" x 300'	
193012	Q3PC500X	1/2" x 500'	
193013	Q4PC100X	3/4" x 100'	
203763	Q4PC300X	3/4" x 300'	
193014	Q4PC500X	3/4" x 500'	
193015	Q5PC100X	1" x 100'	
193016	Q5PC300X	1" x 300'	
211126	Q5PC500X	1" x 500'	

PEX Blue Strait Tubing

- Flexible, low-lead compliant tubing, used in potable plumbing applications
- Easy to install and requires fewer fittings
- Resistant to mineral build-up and freeze damage



Part #	Mfg #	Size	Price
194205	Q3PS20XBLU E	1/2" x 20'	
194206	Q4PS20XBLU E	3/4" x 20'	
194207	Q5PS20XBLU E	1" x 20'	

Pipe



PEX Tubing

PEX Red Strait Tubing

- Flexible, low-lead compliant tubing, used in potable plumbing applications
- Easy to install and requires fewer fittings
- Resistant to mineral build-up and freeze damage



Part #	Mfg #	Size	Price
194203	Q3PS20XRED	1/2" x 20'	
194204	Q4PS20XRED	3/4" x 20'	
196492	Q5PS20XRED	1" x 20'	

PEX White Straight Tubing

- Flexible, low-lead compliant tubing, used in potable plumbing applications
- Easy to install and requires fewer fittings
- Resistant to mineral build-up and freeze damage



Part #	Mfg #	Size	Price
193017	Q3PS20X	1/2" x 20'	
193018	Q4PS20X	3/4" x 20'	
193019	Q5PS20X	1" x 20'	
212555	Q8PS20X	2" x 20'	

Radiant - PEX Tubing

Uponor hePEX™ plus Barrier Tubing

- EVOH Oxygen diffusion barrier
- Compatible with ProPEX® fitting connectors and QS-style fittings



NOTE: 5/16" hePEX plus tubing is used for the Uponor QuikTrak® system

Part#	Prod	Size	Length	Price
040683	A1180313	5/16"	250'	
040684	A1220313	5/16"	1,000'	
027977	A1250500	1/2"	300'	
032213	A1220500	1/2"	1,000'	
033670	A1220375	3/8"	1000'	
011783	A1250625	5/8"	300'	
152064	A1210625	5/8"	400'	
011782	A1220625	5/8"	1,000'	
143505	A1140750	3/4"	100'	
029223	A1250750	3/4"	300'	
061611	A1240750	3/4"	500'	
158245	A1220750	3/4"	1000'	
142507	A1141000	1"	100'	
045199	A1251000	1"	300'	
114130	A1141250	1-1/4"	100'	
030575	A1251250	1-1/4"	300'	
114131	A1141500	1-1/2"	100'	
057608	A1251500	1-1/2"	300'	
114132	A1142000	2"	100'	
030573	A1252000	2"	300'	

hePEX™ Straight Length

- In 20' lengths



Part#	Prod	Size	Length	Price
148441	A1930750	3/4"	300'	
152501	A1921000	1"	100'	
152500	A1921250	1-1/4"	100'	
148486	A1921500	1-1/2"	100'	
119354	A1922000	2"	100'	

Multi-Layer Composite (MLC) Tubing

- Consists of interior aluminum tubing line with inner and outer layers of PEX
- 100% oxygen diffusion



Part #	Mfg #	Description	Price
069711	D1250500	1/2"	300'

Pipe

Radiant - PEX Tubing

RadiantPEX® Tubing

- For radiant heating and snow melting applications
- Durable, flexible, cross-linked polyethylene
- Meets ASTM standards, ICC listed, & NSF listed
- 25-Year limited warranty for hydronic heating, floor heating, and snow melting applications

RadiantPEX® Barrier Coil

- Barrier PEX tubing for radiant heating and snow melting
- 4-Layer PEX



Part #	Mfg #	Order #	Size	Price
113981	PB032081-300	81003406	1/2" x 300'	
114089	PB032081-1000	81001681	1/2" x 1,000'	
117481	PB032101-300	81009852	5/8" x 300'	
117483	PB032101-500	81009711	5/8" x 500'	
127082	PB032101-1000	81010815	5/8" x 1000'	
120150	PB032121-300	81005303	3/4" x 300'	
132555	PB032121-1000	81009868	3/4" x 1000'	

RadiantPEX® Stick

Part #	Mfg #	Order #	Size	Price
129222	PB032161-300	81009361	1" x 300'	

RadiantPERT Tubing

- Polyethylene raised temperature tubing with oxygen barrier
- Recyclable



Part #	Mfg #	Order #	Size	Price
158856	P12300	81016323	1/2" x 300'	
170100	P581200	81016326	5/8" x 1200'	
170099	P121000	81016324	1/2" x 1000'	
170102	P58500	81016325	5/8" x 500'	

Polyethylene Pipe

Geo-Tubing Polyethylene Pipe

Geothermal Pipe Coil

- Polyethylene
- HDPE



Part #	Mfg #	Size	Price
054671	6-750020	3/4" x 20'	
054660	6-750600	3/4" x 600'	
054669	6-750700	3/4" x 700'	
099614	6-750800	3/4" x 800'	
054673	6-125020	1-1/4" x 20'	
054663	6-125100	1-1/4" x 100'	
054664	6-125200	1-1/4" x 200'	
116471	6-125300	1-1/4" x 300'	
054665	6-150100	1-1/2" x 100'	
054675	6-200020	2" x 20'	
054667	6-200100	2" x 100'	
054668	6-200200	2" x 200'	

U-Bend Pipe Coil

- SDR11
- 160 psi



Part #	Mfg #	Description	Price
116060	6-075U410-R	3/4" x (2) 205' Reverse Rolls	
098437	6-075U410	3/4" x (2) 205' Rolls	

Pipe

Polyethylene Pipe

Polyethylene Flexible Pipe

PE 3408 Flexible Potable Water Pipe (SIDR-7 NSF-pw)

- Conforms to PE3408, ASTM 2239

Part #	Mfg #	Size	Price
018081	18020	1" x 300'	

PE 3408 Flexible Potable Water Pipe (SIDR-9 NSF-pw)

- Conforms to PE3408, ASTM 2239

Part #	Mfg #	Size	Price
005352	18105	3/4" x 100'	
005353	18110	3/4" x 400'	
005346	18115	1" x 100'	
005351	18120	1" x 300'	
005349	18125	1-1/4" x 100'	
027156	18127	1-1/4" x 200'	
005350	18130	1-1/4" x 300'	
005347	18135	1-1/2" x 100'	

PE 3408 Flexible Potable Water Pipe (SIDR-19 NSF-pw)

- Conforms to PE3408, ASTM 2239

Part #	Mfg #	Size	Price
147889	18425	1" x 300'	

HD Flexible Pipe

Part #	Mfg #	Size	Price
005332	18335	1" x 100'	100#
005345	18205	3/4" x 100'	125#

Pipe

Polyethylene Pipe

CE Blue® Flexible Polyethylene Tubing SIDR-9 160 PSI CE Blue® Flexible Polyethylene Tubing

- 160 psi - IPS SIDR-9
- For potable water
- ASTM D-2239

Part #	Mfg #	Size	Price
047301	19415	3/4" x 100'	
047302	19420	3/4" x 400'	
047303	19430	1" x 100'	
047304	19435	1" x 300'	

SIDR-7 200 PSI CE Blue® Flexible Polyethylene Tubing

- 200 psi - IPS SIDR-7
- For potable water
- AWWA C-901
- ASTM D-2239

Part #	Mfg #	Size	Price
047311	19315	3/4" x 100'	
047312	19320	3/4" x 400'	
047313	19330	1" x 100'	
047314	19335	1" x 300'	
047321	19355	1-1/4" x 300'	

SDR-9 200 PSI Flexible Polyethylene Tubing

- 200 psi - CTS SDR-9
- For potable water
- AWWA C-901
- ASTM D-2737

Part #	Mfg #	Size	Price
104835	19715	3/4" x 100' CTS	
104836	19718	3/4" x 300' CTS	
224640	19720	3/4" x 500' CTS	
104837	19730	1" x 100' CTS	
104838	19735	1" x 300' CTS	
224672	19738	1" x 500' CTS	
121056	19750	1-1/4" x 100' CTS	
121055	19755	1-1/4" x 300' CTS	
172051	19770	1-1/2" x 100' CTS	
224678	19775	1-1/2" x 300' CTS	
113050	19785	2" x 100' CTS	
149129	19790	2" x 200' CTS	
127076	19792	2" x 300' CTS	

Pipe



Polyethylene Pipe

Mur-lok® Linear Low Density Polyethylene (LLDPE) Tube

- For use with Mur-lok Polypropylene quick-connect and standard fittings on point-of-use drinking water systems
- BPA-Free, FDA approved

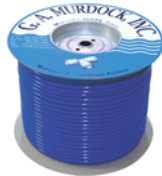

Part #	Mfg #	OD	ID	Lgth	Color	Price
052016	L0402505	1/4"	0.170"	250'	Blue	
052022	L0602505	3/8"	1/4"	250'	Blue	

PVC Pipe

DWV Sch 40 PVC Pipe
PVC DWV Sch 40 Pipe Plain End



Part #	Nom Pipe Size	Price
012581	1-1/2" x 10'	
012686	1-1/2" x 20'	
013975	2" x 10'	
014210	2" x 20'	
014473	3" x 10'	
014552	3" x 20'	
015354	4" x 10'	
015413	4" x 20'	
015700	6" x 10'	
015712	6" x 20'	
015842	8" x 20'	
018961	10" x 20'	
026816	12" x 20'	
030460	14" x 20'	
078110	16" x 20'	

PVC DWV Sch 40 Foam Core Bell End Pipe

Part #	Nom Pipe Size	Price
105062	4" x 10'	

PVC DWV Sch 40 Foam Core Plain End Pipe



Part #	Nom Pipe Size	Price
012579	1-1/2" x 10'	
012685	1-1/2" x 20'	
013974	2" x 10'	
014209	2" x 20'	
014472	3" x 10'	
014551	3" x 20'	
015353	4" x 10'	

DWV Sch 40 PVC Pipe (Continued)

PVC DWV Sch 40 Foam Core Plain End Pipe

Part #	Nom Pipe Size	Price
015412	4" x 20'	
015711	6" x 20'	

PVC Schedule 40 Pipe
PVC Sch 40 Plain End

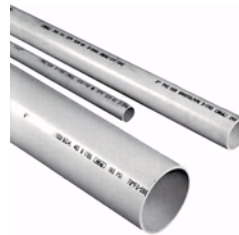

Part #	Nom Pipe Size	Price
030322	1" x 10'	

PVC Sch 40 Bell End



Part #	Nom Pipe Size	Price
087299	1-1/2" x 10'	
013174	1/2" x 20'	
014741	3/4" x 20'	
012263	1" x 20'	
012856	1-1/4" x 20'	
012524	1-1/2" x 20'	
013899	2" x 20'	
014106	2-1/2" x 20'	
014413	3" x 20'	
226460	4" x 20'	
023115	6" x 20'	
022823	8" x 20'	

PVC Type 1120 Pressure Pipe

PVC SDR-21 200 PSI Bell End

Part #	Nom Pipe Size	Price
014740	3/4" x 20'	
012262	1" x 20'	

PVC Type 1120 Pressure Pipe (Continued)

PVC SDR-21 200 PSI Bell End

Part #	Nom Pipe Size	Price
012855	1-1/4" x 20'	
013897	2" x 20'	

PVC SDR-13.5 315 PSI Bell End

Part #	Nom Pipe Size	Price
035005	1/2" x 20'	

PVC Schedule 80 Pipe
PVC Sch 80 Plain End



Part #	Nom Pipe Size	Price
013189	1/2" x 20'	
014758	3/4" x 20'	
012277	1" x 20'	
012868	1-1/4" x 20'	
012539	1-1/2" x 20'	
013912	2" x 20'	
019716	2-1/2" x 20'	
014423	3" x 20'	
015296	4" x 20'	
015663	6" x 20'	
019345	8" x 20'	
053509	10" x 20'	
063360	12" x 20'	
065236	14" x 20'	

Pipe

PVC Pipe & Fittings

PVC Type 1120 Pressure Pipe

PVC DWV Cellular Core Pipe (NSF- DWV)

- ASTM F-891, NSF- DWV

PVC 1120 SDR-21 Plain End

Part #	Mfg #	Nom Pipe Size	Price
021862	46810	3/4" x 10'	
021863	46820	1" x 10'	

PVC 1120 SDR-21 Gasket End

Part #	Mfg #	Nom Pipe Size	Price
025066	48451	1-1/2	

PVC SDR-26 160 PSI Gasket End

Part #	Mfg #	Nom Pipe Size	Price
099528	48130	4" x 14'	

PVC 1120 Sch 40 Pressure Pipe (NSF-pw)

- ASTM D1785
- Potable water

PVC Sch 40 Plain End

Part #	Mfg #	Nom Pipe Size	Price
101363	42800	1/2" x 10'	
062668	42820	1" x 10'	

PVC Sch 40 Bell End

Part #	Mfg #	Nom Pipe Size	Price
077796		1/2" x 10'	
077795		3/4" x 10'	
077794		1" x 10'	
150667		1-1/4" x 10'	
103472		2" x 10'	
184978		3" x 10'	

PVC Drain Waste & Vent Pipe

PVC DWV Sch 40 Pipe (NSF- DWV)

- ASTM D2665, NSF- DWV
- ASTM D1785, NSF-pw

Part #	Mfg #	Nom Pipe Size	Ends	Price
019971	50205	1-1/4" x 20'	PE	
041045	50252	4" x 10'	BOE	
078807	51153	4" x 10'	Bell End	
040883	50249	4" x 20'	Bell End	

PVC Sewer and Drain Pipe

PVC-DS ASTM D-2729 Sewer & Drain Pipe

Part #	Mfg #	Nom Pipe Size	Type	Price
014474	52805	3" x 10'	Solid BE	
015356	52815	4" x 10'	Solid BE	
192161	52114	4" x 10'	Solid BE	
015357	52910	4" x 10'	Perf BE	
015702	52155	6" x 10'	Solid BE	
192162	52209	4" x 10'	Perf Green	

PVC SDR-23.5 D-2751 Sewer & Drain Pipe

Part #	Mfg #	Nom Pipe Size	Type	Price
099542		4" x 14'	Gasketed	
099544		6" x 14'	Gasketed	

PVC SDR35 Solvent Weld Pipe

Part #	Mfg #	Nom Pipe Size	Type	Price
099533	53726	4" x 14'	Gasketed	
099535	53806	8" x 14'	Gasketed	
015704	53180	6" x 10'	Solid	
015837	53250	8" x 10'	Solid	

PVC D-3034 Type PSM ASTM

Part #	Mfg #	Nom Pipe Size	Type	Price
015358	53865	4" x 10'	Solid	
015359	53896	4" x 10'	Perforated	

PVC Drop Pipe

PVC Sch 80 Drop Pipe Threaded Well Pipe

Part #	Mfg #	Nom Pipe Size	Price
012279	43056	1" x 20'	
012865	43078	1-1/4" x 20'	

Pipe

Stainless Steel Pipe

Sch 10 Welded Pipe

316 Stainless Steel



Part #	Size	Price
174257	1/2" x 20'	
174258	3/4" x 20'	
174244	1" x 20'	
174245	1-1/4 x 20'	
174246	1-1/2" x 20'	
174247	2-1/2" x 20'	
174249	6" x 20'	
174250	8" x 20'	

Seamless Tubing

304/L SS Tubing



• Tube OD x wall thickness

Part #	Size	Price
164999	1/2" x .035	
164996	1/4" x .049	
164997	3/8" x .049	
164995	1/2" x .049	
164998	3/4" x .049	

Sch 40 Welded Pipe

304 Stainless Steel



Part #	Size	Price
065197	1/2" x 20'	
065198	3/4" x 20'	
076078	1" x 20'	
065201	1-1/4 x 20'	
160424	1-1/2" x 20'	
076080	2" x 20'	
177139	3" x 20'	
153486	4" x 20'	
177140	6" x 20'	

316 Stainless Steel



Part #	Size	Price
097943	1/2" x 20'	
160886	3/4" x 20'	
131052	1" x 20'	
160887	1-1/4" x 20'	
160888	1-1/2" x 20'	
160797	2" x 20'	
174251	2-1/2" x 20'	
174252	3" x 20'	
174253	4" x 20'	
174254	6" x 20'	
174255	8" x 20'	

Underground Gas Pipe & Ftg

Poly Gas Pipe

MDPE 3810 PE2406 Yellow Polyethylene Pipe

- *Manufactured in accordance with ASTM D2513*
- *Other dimensional standards or custom requirements are acceptable as agreed upon between the buyer & manufacturer*

MDPE 3810 PE2406 Yellow Pipe - IPS

Part #	Mfg #	Size	SDR	Price
126619	27120	3/4" x 150'	11	
126621	27140	1-1/4" x 150'	11	

MDPE 3810 PE2406 Yellow Pipe - CTS

Part #	Mfg #	Size	SDR	Price
160536	27705	1/2" x 150'	7	
131976	27710	1/2" x 500'	7	
126620	27740	1" x 150'	11	

Underground Gas Pipe & Ftgs

Connectors

Riser

Part #	Mfg #	Description	Price
061548	75313	1" NPT x 1" CTS x 30	

Tracer Wire

Part #	Mfg #	Description	Price
056988	TW-12G500	12ga Tracer Wire (500')	

Underground Gas Pipe & Ftg

Underground Gas Products

Con-Stab® Anodeless Meter Riser

- Fusion-bonded epoxy coating
- Anodeless and corrosion resistant
- Patented "ID-Seal" fitting



Part #	Mfg #	Size	SDR	Price
136701	2886040	1" CTS	SDR-11.5	

Con-Stab® Coupling



Part #	Mfg #	Size	SDR	Price
131975	2881000	1/2" CTS	SDR-7	
136702	2881002	3/4" IPS	SDR-11	

Con-Stab® Chamfer Tool



Part #	Mfg #	Size	SDR	Price
136710	2888014	3/4" IPS	SDR-11	

Underground Gas Pipe & Ftg

Chamfering Tools

- Consistent bevel to polyethylene pipe required to install Permasert mechanical couplings
- 2-Sided to accommodate multiple tubing sizes and minimize number of tools



Part #	Mfg #	Size	Price
125799	51009	3/4" IPS x 1" IPS Kit	
125800	51004	1/2" CTS x 1" CTS	
125801	51028	1-1/4" CTS x 1-1/4" IPS	

Servi-Sert® Top-Connected Flex Risers

- 1-Piece construction
- No special tools or installation equipment
- Zinc-plated service head adapter
- Independent gripping and sealing components
- Available in all-flex, stubflex, or prebent steel casing configurations
- Includes moisture seal shear protection fitting
- Outlets/inlets/metric
- Servi-Sert service heads available separately



Commonly Used All-Flex Risers for Natural Gas

Part #	Mfg #	Threaded Outlet	PE Tubing	Flex Length	Price
133072	71410	3/4" NPT	1/2" CTS	36"	

Single Seal Anodeless Risers

- No cathodic protection required
- Available with Permasert coupling outlets
- Unique pressure seal locks PE tubing in place
- Optional below-grade secondary seal
- Pressure tested to 150 psi
- Prebent, straight or flexible designs available
- Variety of coatings available

Part #	Mfg #	Thrd Steel Outlet	PE Tubing	Inlet Type	Price
056982	79208	3/4" NPT	3/4" IPS	Permasert	
062823	75900	1-1/4"IPS	1-1/4"IPS	30" Vertical	

Pipe

Underground Gas Pipe & Ftgs

Permasert® Natural Gas Fittings

- *Fast & easy installation*
- *No special tools/costly installation equipment*
- *Molded from industry proven polyethylene (PE)*
- *Non-corrosive components eliminate need for cathodic protection or protective coatings*
- *Minimal stress on PE piping*
- *Metric sizes available*

Permasert® Mechanical Coupling

- *PE Material - PE4710/Bimodal
PE3408 Resin*



Part #	Mfg #	Size	SDR/Wall	Price
056985	50030	3/4" IPS	SDR 11	
056984	50103	1" CTS	.090/.099/.102"	
062824	50035	1-1/4" IPS	SDR 10	



Underground Gas Pipe & Ftgs

Flexible Meter Risers

- *Integrated swivel service head adapter*
- *Sealastic leak resistant design with molded rubber seal*
- *Seal ferrule and built-in barbed tube stiffener*
- *Hex construction nut and body*



Part #	Size	SDR	Price
146273	3/4" IPS	SDR-11	
153318	1" IPS	SDR-11	
146276	1-1/4" IPS	SDR-11	
148233	1-1/2" IPS	SDR-11	
154037	1/2" CTS	SDR-11	
146274	1" CTS	SDR-11	

Vinyl Tubing

Tubing

Clear Vinyl Tubing

- Clear, tough, flexible tubing
- Nominal wall thickness: 1/16"
- Good for A/C condensate drains



Part #	Mfg #	Size	Price
120679	5125	1/4" ID x 100' Roll	
118548	5137	3/8" ID x 100' Roll	
118549	5150	1/2" ID x 100' Roll	
118551	5162	5/8" ID x 100' Roll	
120680	5175	3/4" ID x 100' Roll	
128615	5187	7/8" ID x 50' Roll	

Polyethylene Tubing

- Designed for pneumatic control tubing
- Also for water supply tubing, ice makers and humidifiers



Part #	Mfg #	Size	Price
013534	5225	1/4" OD x 100' Roll	



Vinyl Tubing

Low Density Polyethylene (LDPE) Pipe LDPE Pipe

Part #	Size	Price/Ft
044037	1/4" OD x 100'	
044036	3/8" OD x 100'	
068934	5/8" OD x 100'	

Vinyl Tubing

Clear Vinyl Tubing

- For air conditioning and refrigeration condensate drains, condensate pump discharge lines and humidifier overflows



Part #	Mfg #	ID	Size	Price
015060	7-38	3/8" ID	100'/Roll	
013212	7-12	1/2" ID	100'/Roll	
015586	7-58	5/8" ID	100'/Roll	
075861	7-78	7/8" ID	50'/Roll	

Anchors

Anchors

Tapcon® Anchor - Hex Head

- Works in all masonry base materials
- Fast and easy
- No hole spotting or inserts required
- Removable and reusable
- Climaseal™ coated



Part #	Mfg #	Anchor Size	Price
081633	HW4-114	1/4" x 1-1/4"	
081634	HW4-134	1/4" x 1-3/4"	
081635	HW4-214	1/4" x 2-1/4"	
081636	HW4-234	1/4" x 2-3/4"	
081637	HW4-314	1/4" x 3-1/4"	
081639	HW4-400	1/4" x 4"	

Tapcon® Anchor - Flat Head

- Works in all masonry base materials
- Fast and easy
- No hole spotting or inserts required
- Removable and reusable
- Climaseal™ coated



Part #	Mfg #	Anchor Size	Price
081646	PF4-114	1/4" x 1-1/4"	
081647	PF4-134	1/4" x 1-3/4"	
081648	PF4-214	1/4" x 2-1/4"	
081649	PF4-234	1/4" x 2-3/4"	
081650	PF4-314	1/4" x 3-1/4"	
081651	PF4-334	1/4" x 3-3/4"	
081652	PF4-400	1/4" x 4"	

Trubolt® Carbon Steel Wedge Anchor

- Versatile fully threaded design
- One piece stainless steel expander clip resists corrosion
- Non bottom-bearing
- Complete with nut and washer
- Heavy-duty pull-out and shear capacities



Part #	Mfg #	Thread Length	Anchor/ Drill Bit	Overall Length	Price
081553	WS-3830	1-3/4"	3/8" - 16	3"	
081554	WS-3850	2-1/2"	3/8" - 16	5"	
081557	WS-1236	2-1/4"	1/2" - 13	3-3/4"	
081560	WS-1254	4"	1/2" - 13	5-1/2"	

Hammer-Set Nail Drive Anchor

- Single-piece zinc plated steel
- Works in concrete, block and brick
- Install through material to be fastened
- Low profile mushroom head style
- For use in electric boxes, conduit clips, drywall track and roof flashing
- Not for use in overhead applications

Part #	Mfg #	Drill Size	Anchor Size	Qty	Price
081657	HS-1406	1/4"	1/4" x 3/4"	100	
081658	HS-1410	1/4"	1/4" x 1"	100	
081659	HS-1412	1/4"	1/4" x 1-1/4"	100	
081661	HS-1420	1/4"	1/4" x 2"	100	

E-Z Anchor™ Self Drilling Drywall Anchor

- Self-drilling
- Includes:
 - (25) Anchors
 - (25) #8-1-1/4" Sheet metal screws

Part #	Mfg #	Description	Price
081654	EZ25	Zinc Anchors	
081655	EZP25	Plastic Anchors	

RM Drop-In Anchor

- Flanged top
- Internally threaded
- Keeps anchor flush
- Keeps all rods same length



Part #	Mfg #	Size	Box Qty	Price
081593	RM-14	1/4"	100	
081594	RM-38	3/8"	50	
081595	RM-12	1/2"	50	
081597	RM-34	3/4"	25	
081596	RM-58	5/8"	25	

RX Drop-In Anchor

- Internally threaded
- Optimized (only 3/4" long) for use in hollow-core, pre-cast plank and post-tension slabs
- Lip keeps anchor flush during installation
- Shallow drilling — fast installation



Part #	Mfg #	Size	Box Qty	Price
110770	RX-38	3/8"	100	
143748	RX-12	1/2"	50	

Anchors

Anchor Setting Tool

Part #	Mfg #	Description	Price
081599	RT-114	1/4" Concrete Setting Tool	
081600	RT-138	3/8" Concrete Setting Tool	
081601	RT-112	1/2" Concrete Setting Tool	
081602	RT-158	5/8" Concrete Setting Tool	
110771	RTX-138	3/8" Size 1/2" Shallow Drop-In Anchor Tool for Use with RX-38 Only	

Condribe 1000 Installation Tools

- *Fast change from drilling to driving*
- *Eliminates need for two tools*
- *Includes bits for all sizes hex & Phillips head*



Part #	Mfg #	Description	Price
081653	C1000	Tapcon® Condribe Tool Kit	

Piping Supplies & Accessories

Anchors

Anchor Kits

Plastic Anchor Kit

- Kit made of shatter proof plastic
- Has slot for hanging on peg-board
- (100) Anchors per kit



Part #	Mfg #	Description	Price
002306	6607	3/16" x 7/8" Phillips/Slot Pan Head	
187040	14083	1/4" x 1" Slotted Hex Washer Head	

Anchors

Anchors

Red Lip Plastic Anchor Kit with Hex Washer Head Screws

• Includes:

- (100) Screws and (100) anchors
- (1) Matching carbide tip drill bit
- Reusable hinged clear vinyl box



Part #	Mfg #	Anchor Size	Screw Size	Price
006470	PA1012KW	1/4" x 1"	HW10x1Z	

Anchors

Drop-In Anchors

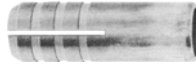

Part #	Mfg #	Size	Price
035429	R204905	3/8"	

Anchor Kits

Part #	Mfg #	Description	Price
008873	R199600	PK-80-S Anchor Kit	
074817	R199720	PK-80-H Anchor Kit	
008874	R199800	K-6-R Anchor Kit	

Piping Supplies & Accessories

Anchors

Anchor Screw Kits

- Includes:
 - (100) #10 x 1" Zinc-plated screws
 - (100) Flanged plastic anchors
 - (1) 1/4" Carbide masonry drill bit



Part #	Mfg #	Description	Price
127001	590-10	Anchor Screw Kit	

Deck Anchors

Cast-In Place Deck Anchors for All-Thread Rod

- Install on wood or metal corrugated decks prior to the concrete pour
- Allows insert locations to be pre-planned eliminating overhead masonry anchors
- Color-coded by rod size, plastic sleeve keeps threads clean
- Easy to locate after the pour
- Installs quickly and easily to reduce labor costs



Part #	Mfg #	Deck Insert	Size	Price
183482	544-3MD	Metal	1/2"	
183480	544-2WD	Wood	3/8"	
183484	544-3WD	Wood	1/2"	
183485	544-4WD	Wood	5/8"	



Anchors

Anchors Drywall Anchor - Steel

Part #	Description	Price
138597	1-1/4" Kit 25/Bag Includes 2" #7 Screws	

Piping Supplies & Accessories

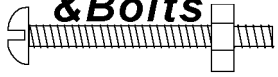

Anchors

Anchors
Toggle Bolt

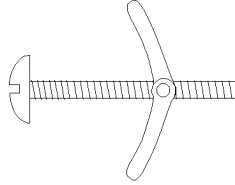

Part #	Size	Price
099223	1/4" x 2"	

Anchors

Bolts

Toggle Bolt

- Zinc-plated
- Spring loaded wing

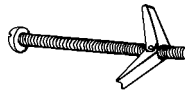

Part #	Mfg #	Size	Price
114989	F33-062	1/4" x 4"	
114990	F33-064	3/8" x 4"	

Wing Only

- Zinc-plated and spring loaded



Part #	Mfg #	Description	Price
056656	F33-067	1/4"	
056657	F33-068	3/8"	

Anchor Bolt Kit

- Includes anchors, hex head screws and drill bit



Part #	Mfg #	Description	Price
224783	A33002	#10 x 1-1/4"	

Cable Ties

Cable Ties

- Available in black or natural
- 1/16" Minimum bundle diameter
- Point of purchase packaging



Part #	Mfg #	Description	Price
110179	15034	7", Black, 2", 1000/Pk	

Straps

Rubber Tie-Down Straps

- Engineered to perform
- Sunlight and temperature resistant
- Features heavy-duty galvanized "S" hooks



Part #	Mfg #	Description	Price
002269	0173	15", 100/Pk	

Cable Ties

Heavy-Duty Cable Ties

- 6.6 Nylon, smooth insertion, locking mechanism
- Tensile: 175 lb



Part #	Mfg #	Description	Price
002297	7-P24	24" for up to 6" Duct	
002298	7-P36	36" for 10" Duct	
002301	7-P48	48" for 14" Duct	

Piping Supplies & Accessories



Cable Ties

Nylon Cable Ties

Standard Black Cable Tie



Part #	Mfg #	Max Length x Width	Bundle	Price
036417	554-08	8" x 3/16"	2"	
036416	554-14	14-1/2" x 3/16"	4"	

Mounting Black Cable Tie



Part #	Mfg #	Max Length x Width	Bundle	Price
147930	554-608	8" x 3/16"	2-3/8"	

Piping Supplies & Accessories

Cable Ties

Cable Ties

- Standard size
- Natural color
- Nylon

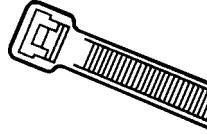

Part #	Mfg #	Description	Price
041967	J40-107	7" Long - 1/16" - 1-3/4" Diameter	
041968	J40-111	11" Regular - 1/16" - 3" Diameter	

DWV Pipe Hangers

Piping Supplies & Accessories

J-Hooks

Hangs Tuff™ DWV Pipe Hanger

- Strong and rigid I-beam design
- (2) Ring-shank nails included
- 100% Corrosion proof, impact resistant ABS
- Can be glued to ABS or PVC pipe with all purpose glue



553-9W

Part #	Mfg #	Connection	Color	Price
010011	553-6W	1-1/2"	White	
010012	553-7W	2"	White	
010013	553-8W	3"	White	
010014	553-9W	4"	White	

ZipStick™ Universal Pipe Hanger

- Perfect for hanging wrapped or insulated pipe, bundles of PEX, cable, wiring, or supporting vent pipe in attics
- Universal cradle hangs any pipe from 1" CTS to 6" IPS
- Releasable locking mechanism
- Graduated numerals at nail ways for easy measuring



Part #	Mfg #	Length	Material	Price
106691	553-010W	10"	White Nylon	
030424	553-014W	14"	White Nylon	
056393	553-026W	26"	White Nylon	

ZipStrap™ Ratchet-Locking Strap

- Extends total strap length on ZipStick™ for large O.D. applications
- Compatible with copper, PEX or CPVC

Part #	Mfg #	Finish/Color	Price
164881	553-0LW	White	

Swivel J-Hanger

- Cradle swivels 360° allowing installers to hang pipe at any angle
- Allows for expansion and contraction
- Ideal when running vent pipes across the attic



Part #	Mfg #	Size	Material	Price
150577	553-6WZ	1-1/2" DWV	White ABS	
150576	553-8WZ	3" DWV	White ABS	

Pipe Clamps

Stick-Em Up™ DWV Pipe Support

- 100% Corrosion proof, impact resistant, ABS
- Strong I-beam design
- Can be glued to ABS or PVC pipe with all-purpose glue
- Each model supports (2) pipe sizes



549-712

Part #	Mfg #	Size	Price
074860	549-712	1-1/2" - 2"	
183487	549-712PK	1-1/2" - 2"-IBC	
074861	549-734	3" - 4"	

Tomahawk™ DWV Ground Stake

- Prevents pipe from floating or moving during concrete pours
- Secures 1-1/2" - 6" Sch 40 DWV Pipe



535-14

Part #	Mfg #	Length	Head	Price
077331	535-14	14"	All Carbon Steel	
035028	535-914	14"	Polyethylene	
039232	535-926	26"	Polyethylene	



Duct Hangers

Slider™ Multi-Purpose Flat Bracket

- Two-piece design adjusts to a range of openings
- 20-gauge galvanized steel or copper-plated steel for spot soldering (heat the tube, not the bracket)
- Pre-drilled models have 1/8" pilot holes on 13/64" centers
- Adjustable bracket with flat tabs length—12"-19"

Adjustable Bracket with Flat Tabs

Part #	Mfg #	Material	Pilot Holes	Price
183442	520-419TC	Copper-Plated	Yes	

Flashings

Piping Supplies & Accessories

No-Calk® Roof Flashing

Aluminum Base No-Calk® Roof Flashing

- Slides over pipe - for pitch to 40°
- Rustproof .032 stamped aluminum standard base
- Non-fading, sealing collar
- Rated 180°F continuous heat
- Approved for Type B installations
- Not for hot-mopped or built-up roofs
- Soft aluminum base (18" x 18") allows for easy molding to tile roofing
- Do not use petroleum based products on collars



Aluminum Base No-Calk® Roof Flashing - Standard Base

Part #	Mfg #	Size	Qty	Price
007939	12920	1-1/4" - 1-1/2"	12	
007958	12933	2"	12	
007961	12946	3"	12	
007991	12959	4"	12	

Thermoplastic Base No-Calk® Roof Flashing

- Slides over pipe - for pitch to 45°
- Non-fading and non-cracking, rigid black thermoplastic base
- Non-fading, sealing collar
- Do not use petroleum based products on plastic bases or rubber collars
- Rated 180°F continuous heat
- Approved for Type B installations
- Not for hot-mopped or built-up roofs

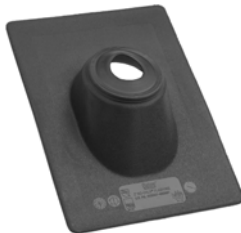

Thermoplastic Base No-Calk® Roof Flashing - Standard Base

Part #	Mfg #	Size	Price
038898	11908	1-1/4" - 1-1/2"	
038897	11909	2"	
038899	11910	3"	
038900	11911	4"	

Flex-Flash® Roof Flashing

- Slides over pipe - for pitch to 45°
- 100% Completely flexible/foldable
- Do not use petroleum based products on rubber bases or rubber collars
- Non-fading TPR base and collar
- No caulking needed
- Rated 180°F continuous heat
- Not for hot-mopped or built-up roofs



Part #	Mfg #	Size	Price
007940	14009	1-1/4" - 1-1/2"	
007959	14012	2"	
007962	14038	3"	
007998	14041	4"	

All-Flash® No-Calk® Highrise® Roof Flashing

- Slides over pipe for pitch 10° to 60°
- Do not use petroleum based products on plastic bases or rubber collars
- Ring on collar tears off, allowing flashings to seal different pipe diameters
- Rated 180°F continuous heat
- Not for hot-mopped or built-up roofs
- Non-fading, non-cracking and non-rusting rigid black TPE base and sealing collars
- Approved for Type B installations



Part #	Mfg #	Size	Price
035272	11930	1-1/2" - 3"	
035273	11931	3" - 4"	

Master Flash® Roof and Wall Flashing

- Slides over pipe - for pitch to 45°
- Use silicone sealant between base and surface and secure with sheet metal screws
- Multi-size pipe sealing range
- Molds to metal, plastic, etc.
- Non-fading EPDM collar
- Rated 212°F continuous heat
- Approved for Type B installations



Part #	Mfg #	Size	Price
023206	14052	1/4" - 4"	
007942	14053	3" - 6"	
007943	14055	5" - 9"	
031273	14057	7" - 13"	
077873	14059	10" - 18", Bulk	

Flashings

Rain Collar for No-Calk® Roof Flashing

- Use as a protective water shield (slides down over pipe)
- No caulking needed
- Do not use petroleum based products on rubber collars
- Non-fading EPDM collar
- Rated 212°F continuous heat
- Approved for Type B installations



Part #	Mfg #	Size	Price
118156	14135	2"	
118157	14193	3"	

Flashings

Roof Flashings

"Snap-Fit®" Thermoplastic Roof Flashing

- *Weatherproof*
- *Feature a replacement boot*
- *Provide a permanent seal around plumbing vent pipes*
- *Corrosion proof*
- *Can be used on all types of plumbing pipe and electrical conduit*
- *Base dimensions: 12" x 16"*



Part #	Mfg #	Size	Price
099225	14563	3"	
099224	14564	4"	

Flashings

Adjustable Pitch Lead Roof Flashing

Part #	Mfg #	Size	Price
015237	052412LRF	4"	

Piping Supplies & Accessories

Flow Meters

Piping Supplies & Accessories

Trap Primer Valves

Prime Perfect™ Trap Primer Valve

- Automatically activates to replenish evaporated water in floor drain traps
- Large port openings in debris screen prevent clogging from sediment and debris
- Activates with a 10 psig pressure drop at operating pressure of 30 - 150 psig
- Water release is factory set 0.25 oz per activation
- Single trap primer can service up to eight traps using splitter and distributors



Part #	Mfg #	Cap & Body Material	Price
054065	695-01	Brass Plated	

Trap Primer Wye Splitter

- 1/2" FIP Swivel connection
- Use with trap primer distributors to service up to (8) traps from a single trap primer



Part #	Mfg #	Branches	Price
138573	695-Y52	(2) 1/2" MIP	

Commercial Trap Primer Adapter Sch. 40 Hub (with 1/2" FIP Port)

- Faster and more professional installation of trap primer supply
- Allows trap primer inlet to be positioned anywhere on the vertical waste line above the trap
- Universal 1/2" FIP thread trap primer supply connection
- Accommodates supply lines from any direction

Part #	Mfg #	Connection	PVC/ABS	Price
223074	695-2P	2" Hub	PVC	
183797	695-4P	4" Hub	PVC	

Splitters Trap Priming Distributor

- 1/2" FIP swivel connection
- Available with 2, 3, or 4 flexible copper branches
- Evenly distributes water to each branch every time



Part #	Mfg #	Branches	Size	#	Price
101135	695-D20	MSwt	1/4"	2	
183798	695-D30	MSwt	1/4"	3	
183799	695-D432	MSwt & Spin-Closed	1/4"	2	
183800	695-D4325	FSwt & Spin-Closed	1/2"	2	
141596	695-D4325F	FIP w/ 2 Plugs	1/2"	4	

Flow Meters

Trap Seal Primers

Trap Seal Primer with Integral Vacuum Breaker

- *Flow activated*



Part #	Mfg #	Description	Price
080441	A-200	1/2" Sweat, Bronze	

Hanger Straps

Piping Supplies & Accessories

DWV Hangers

Galvanized Steel Metal Hanger Strap

- Alternating 1/4" and 3/16" holes



Part #	Mfg #	Size	Gauge	Price
010002	524-10	3/4" x 10' Coil	24	
183449	528-10	3/4" x 10' Coil	28	
010004	528-100	3/4" x 100' Coil	28	

Copper-Plated Steel Metal Hanger Strap

- Alternating 1/4" and 3/16" holes



Part #	Mfg #	Size	Gauge	Price
010003	524-10C	3/4" x 10'	24	

Ape Tape™ Woven Polypropylene Hanger Strap

- No sharp edges to cut installer's hand or pipe
- Strong, durable material yet lightweight
- Does not fracture in extremely cold temperatures
- Cut to desired length
- Allows installer to position screw or nail at any location

Part #	Mfg #	Size	Price
116992	554-100W	5/8" x 100'	

Polypropylene Hanger Strap with 1/8" Holes

- Not recommended in extremely cold climates (below 32°F)
- Max load: 20 lbs.

Part #	Mfg #	Size	Price
183502	554-100	3/4" x 100' Coil	

Hanger Straps

2-Hole Tube Strap

- Copper & copper plated steel for CTS tube
- Galvanized steel for IPS pipe
- Galvanized straps comply with MSS SP58 Type 26



Copper-Plated

Part #	Mfg #	Size	Gauge	Nails	Price
021293	501-1	3/8" CTS	24	Zinc-Coated	
009975	501-2	1/2" CTS	24	Zinc-Coated	
009976	501-3	3/4" CTS	24	Zinc-Coated	
009977	501-4	1" CTS	22	Zinc-Coated	
009978	501-5	1-1/4" CTS	22	Ring-Shank	
009979	501-6	1-1/2" CTS	22	Ring-Shank	

Hanger Straps (Continued)

2-Hole Tube Strap

Copper-Plated

Part #	Mfg #	Size	Gauge	Nails	Price
009980	501-7	2" CTS	22	Ring-Shank	

Galvanized Steel

Part #	Mfg #	Size	Gauge	Nails	Price
009981	502-2	1/2" IPS	22	—	
009982	502-3	3/4" IPS	22	—	
009983	502-4	1" IPS	20	—	
009984	502-5	1-1/4" IPS	20	—	
009985	502-6	1-1/2" IPS	20	—	
009986	502-7	2" IPS	18	—	
009987	502-75	2-1/2" IPS	16	—	
009988	502-8	3" IPS	16	—	
009989	502-9	4" IPS	16	—	

Tube Hangers

Bell Type Hanger

- Self-tapping mounting screw for penetrating metal studs
- Includes (2) clamp screws and (1) 2-1/2" mounting screw



508-2

Part #	Mfg #	Size	Price
047091	508-2	1/2" CTS	
047092	508-3	3/4" CTS	
047093	508-4	1" CTS	

Solder Straps—Copper-Eared Tube Hanger

- 1/8" mounting holes align with most conventional brackets
- Spot solder to copper tube (heat the tube, not the strap)



505-24

Square O Strap™

Part #	Mfg #	Size	Gauge	Price
153419	505-24	1/2" CTS	17	
183439	505-34	3/4" CTS	17	
225551	505-44	1" CTS	17	

Solder O Strap™

Part #	Mfg #	Size	Gauge	Price
030423	505-29	1/2" CTS	17	

Hanger Straps

Hanger Strap
Plastic Hanger Strap

- *Nail holes are 2-1/2" apart*
- *Non-corrosive, non-conductive, with nail holes*
- *Quick and inexpensive way to hang pipe from joists and rafters*
- *1/8" Nominal hole size*
- *Polyethylene*



Part #	Mfg #	Size	Price
041348	33925	3/4" x 25'	
007975	33926	3/4" x 50'	

Hanger Straps

Perforated Pipe Strap

- Alternating holes (bolts and nail)

Plastic Hanger Tape

- Flexible, non-conductive polypropylene
- 3/4" Wide, .050 thick
- 1/8" Diameter holes every 3/4"
- Can be cut with scissors or utility knife



Part #	Mfg #	Description	Price
042001	H21-010	10' Roll Poly Bagged	
068953	H21-025	25' Roll Poly Bagged	
042000	H21-050	50' Roll Poly Bagged	
068952	H21-100	100' Roll Poly Bagged	

Hanger Straps

Hanging Wire

- 18 Gauge galvanized or soft black annealed



Part #	Mfg #	Description	Price
002305	6502	5# Reel (830') Galvanized	

Hanger Straps

Plastic Hanger Strap

- Flexible, non-conductive
- Can be cut to length with scissors or utility knife
- Use for pipe hanger, duct hanger, tubing strap, strap, etc.

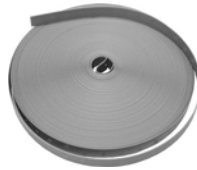

Part #	Mfg #	Description	Price
002289	13038	3/4" x 100' Roll (Box)	

Polypropylene Webbing Strap

- 3" Tensile strength: 640 lbs average
- For hanging flex-duct, etc.
- 300' Rolls



Part #	Mfg #	Description	Price
096479	16105	3" Black	

Piping Supplies & Accessories



Hanger Straps

Stub-Out Bars

Multi-size Stub-Out Bar

- Fits 1/2", 3/4", and 1" tubing
- 1/2" Hole with 3/4" and 1" knockout holes on 2" centers
- Reinforcing ribs for additional strength

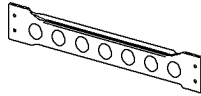

Part #	Mfg #	Gauge	Length	Ctn Qty	Price
019744	MS-20	18	20"	50	

Two Hole Hanger Strap

- Heavy-duty galvanized steel
- Allows for a clean, professional installation



Part #	Mfg #	Size	Ctn Qty	Price
191938	1THS-GNN	1"	100	

Heating Cables

Freeze Free® Pipe Freeze Prevention Cable

- Self-regulating pipe heating cable
- Keeps plastic and metal water pipes from freezing to -60°F
- Braided metal jacket
- Rated 3W per foot
- 120VAC at 50°F
- UL Listed & CSA Certified



Part #	Mfg #	Description	Price
004406	2102	100' Reel	

Connection Kit

Part #	Mfg #	Description	Price
021899	10803	(25) Packs of Plug & End Seal	

SR Trace® Freeze Protection Cable

- The cut-to-length design allows for easy field sizing and installation
- All power densities are available from the factory in cut-to-order lengths or in easy to use 250 self-dispensing reel boxes
- Normally installed in commercial applications
- Suffix: J = jacketed cable (can be followed by reel length)

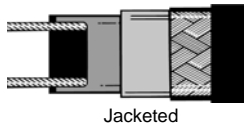

Part #	Mfg #	Description	Price
004398	SR51J	5W/ft 120VAC Cut-to Order	

Innerlynx Modular Seal

Piping Supplies & Accessories

Pipe Penetration Seals

- Forms a mechanical seal between pipes going through walls, floors, vaults, tanks & pipeline casings going through walls, floors, vaults
- Helps absorb vibrations, shocks & sound waves
- Non-conductive
- Installed quickly & easily by one worker with no special tools required

Standard Pipe Penetration Seal

- Plated steel
- EPDM black
- Temperature range: -40° to 250°F
- Composite pressure plates
- Plated steel fasteners and nuts
- Suitable for most standard applications including: above ground, direct underground burial, wet conditions and where cathodic protection - electrical insulation is desired



Part #	Mfg #	Actual Thickness	Width	Chord Length	Price
108030	IL-200C	0.50"	1.80"	1.15"	
108032	IL-275C	0.63"	1.80"	0.89"	
108033	IL-300C	0.70"	2.57"	1.50"	
108034	IL-315C	0.83"	2.48"	1.47"	
108035	IL-325C	0.95"	3.04"	3.15"	
108036	IL-340C	1.00"	2.76"	1.52"	
108037	IL-360C	1.23"	2.80"	2.08"	
108038	IL-400C	1.41"	3.56"	3.63"	
108040	IL-425C	1.13"	3.54"	3.60"	
108041	IL-475C	1.61"	3.16"	2.68"	
108044	IL-575C	1.81"	3.78"	3.16"	

Pipe Pier

Caddy® Cable/Conduit Supports

Caddy® Pyramid 50 Pipe and Equipment Support

- *Recommended load: 50 lbs*
- *Polyethylene closed-cell foam and steel construction*
- *Metal top designed to shed water and minimize water collection on foam base*



Part #	Mfg #	Size	Price
048247	RPS50H4EG	4"H x 4"W x 10-3/8"D	

Plastic Hangers

Piping Supplies & Accessories

J-Hooks

Hangs Tuff Jr.™ CTS Tube Hanger

- Hangs any 1/2" – 1 1/4" CTS copper, PEX or CPVC tube
- 100% corrosion proof, impact resistant ABS
- Two ring-shank nails conveniently supplied



553-3W

Part #	Mfg #	Size	Price
010009	553-2W	1/2" CTS	
010010	553-3W	3/4" CTS	
079196	553-4W	1" CTS	
183500	553-5W	1-1/4" CTS	

Pipe Clamps

TouchDown II™ Large Universal Pipe Clamp

- Clamps 1/2" - 2" CTS tube (copper, PEX or CPVC) and 3/8" - 2" Sch 40 pipe (steel or plastic)
- Releasable locking mechanism allows for variable clamping tension for expansion & contraction
- Provides 5/8" stand-off from mounting surface
- PlenumSafe™ model meets ASTM E84 25/50 Flame/Smoke Spread and UL-94 V0 flame ratings
- Acoustical options available—not plenum-rated



550-20

Part #	Mfg #	Bridge	Base	Screws	Price
041567	550-20	1	1	2	

With Two Pipe Down™ Noise Absorbing Inserts

- Thermoplastic elastomer reduces noise
- Not for use with Plenum Safe™ clamps

Part #	Mfg #	Bridge	Base	Screws	Price
183488	550-20Q	1	1	2	

TouchDown™ Universal Pipe Clamp

- Clamps 1/4" - 1" CTS tube (copper or plastic) and 1/8" - 1" Sch 40 pipe (steel or plastic)
- Releasable locking mechanism
- Perfect when various pipe and tube sizes are used
- Variable clamping tension allows for expansion and contraction of tube
- Provides 1/4" stand-off
- For use with any CTS pipe (copper, PEX, CPVC, PB)



Part #	Mfg #	Bridge	Base	Screws	Price
036418	550-11	1	1	1	

Pipe Eye™ Metal Stud Insulator



558-M2

- Compatible with copper, PEX and CPVC
- Fits 1-11/32" holes in metal studs or brackets
- Split design, offset hole for adjustable tube position
- Reduces noise caused by expansion and contraction
- Flame retardant models meet UL94 V 2 flame rating
- PlenumSafe™ models meet ASTM E84 25/50 Flame/Smoke Spread and UL94 V-0 flame rating

Standard

Part #	Mfg #	Size	Color	Price
078839	558-M2	1/2" CTS	Black	
078841	558-M3	3/4" CTS	Black	
183507	558-M3C	3/4" CTS	Blue	
183508	558-M3H	3/4" CTS	Red	
078840	558-M4	1" CTS	Black	

Flame Retardant

Part #	Mfg #	Size	Price
020776	558-M2R	1/2" CTS	
020777	558-M3R	3/4" CTS	

PlenumSafe™

Part #	Mfg #	Size	Price
117292	558FM2	E84 1/2" CTS	
117293	558FM3	E84 3/4" CTS	
117294	558FM4	E84 1" CTS	

Suspensulator™ Tube Clamp & Insulator

- Designed to work in both 1 3/8" and 1 11/32" holes in wood or metal studs
- Side fins lock perfectly into I-joist knockout
- Split design allows for use after piping is run
- Durable, UV resistant, high-density polyethylene is 100% corrosion proof and reduces noise due to expansion and contraction in hot water lines
- Compatible with copper, PEX or CPVC



Part #	Mfg #	Size	Color	Price
077500	558-E2	1/2" CTS	Black	

Plastic Hangers

Tube Talon™ Drive Hook Tube Hanger with Nail

- Absorbs vibration
- Compatible with copper, PEX and CPVC
- For IPS piping (PVC and iron pipe) use next larger size Tube Talon
- Preloaded ring-shank nails ensure a permanent hold
- Install in alternating directions to ensure secure piping
- Tube is not damaged if nail is overdriven



Part #	Mfg #	Size	Color	Price
100959	555-1	3/8" CTS	Black	
010015	555-2	1/2" CTS	Black	
183503	555-2BK	1/2" CTS, 1,800/Bucket	Black	
010016	555-3	3/4" CTS	Black	
183504	555-3BK	3/4" CTS, 1,000/Bucket	Black	
043092	555-4	1" CTS	Black	
183505	555-4BK	1" CTS, 500/Bucket	Black	

Pick-Up Talon™ Isolating Drive Hook with Nail

- The most affordable solution to keeping tube off the mounting surface for a quiet system
- Installation is fast and easy; snaps onto tube with preloaded nails/screws
- Install in alternating directions to secure piping
- All models with screws feature self-drilling tips
- Compatible with copper, PEX and CPVC



Part #	Mfg #	Size	Color	Price
183506	556-1	3/8" CTS	Black	
108286	556-2	1/2" CTS	Black	
108287	556-3	3/4" CTS	Black	
108288	556-4	1" CTS	Black	
223089	556-5	1-1/4" CTS	Black	

Twin Talon™ Double-Duty Drive Hook with Nail

- 555-23 series affixes 1/2", 5/8" and 3/4" nominal tube (copper or plastic) and 1/2" Sch. 40 IPS pipe (steel or plastic)
- Available with shorter nail for radiant heat, nail-up applications. 1-5/8" nail won't penetrate 3/4" floors
- Compatible with copper, PEX and CPVC



Part #	Mfg #	Size	Price
028473	555-23	1/2"-3/4" CTS	
089111	555-23BK	1/2"-3/4" CTS, 850/Bucket	

Padlock™ Tube Hanger

- Nail or screw locks tube into hanger so there is no way for tube to escape
- Allows tube to expand and contract
- Will not damage tube if nail or screw is over-driven
- Fits and fastens to the GridIron™ bracket
- Compatible with copper, PEX and CPVC
- Isolates tube from surface to reduce heat loss and noise transfer



Part #	Mfg #	Size	Nail or Screw	Price
039374	551-P2	1/2" CTS	Nail	
078585	551-P2S	1/2" CTS	Screw	
078586	551-P3S	3/4" CTS	Screw	

Sioux Strap™ Tube Hanger with Nail

- Provides 1/4" stand-off
- Compatible with copper, PEX and CPVC
- Preloaded ring-shank nail ensures a permanent hold
- Isolates tube from surface to reduce heat loss and noise transfer
- Snaps onto tube for "hands-free" installation
- Allows tube to expand and contract



Part #	Mfg #	Size	Color	Price
032464	551-2	1/2" CTS	Black	
074850	551-2BK	1/2" CTS, 1000/Bucket	Black	
038630	551-3	3/4" CTS	Black	
138265	551-3BK	3/4" CTS, 600/Bucket	Black	
042878	551-4	1" CTS	Black	

Totem™ Offset CTS Hanger

- Single, twin, or stacked offset hanger
- Provides 1" offset from mounting surface to bottom of tube
- Secures to surface in any position
- Unique V-shaped base easily adapts to engineered wood I-beam joists
- Locking finger holds pipe securely in place
- 100% corrosion proof, impact resistant
- Bulk ring-shank nails included (but not pre-loaded)
- Compatible with copper, PEX and CPVC



Part #	Mfg #	Size	Offset	Price
157295	552-A2	1/2" CTS	Single	
157300	552-A3	3/4" CTS	Single	
157301	552-B33	3/4" x 3/4" CTS	Twin	
183491	552-C33	3/4" x 3/4" CTS	Stacked	

Plastic Hangers

Piping Supplies & Accessories

EZGlide™ Tube Insulator

- Ribs allow pipe to glide easier and more quietly when the pipe expands and contracts
- Split design allows for use after piping run
- Fits both 1-11/32" and 1-3/8" holes in metal or wood studs
- Compatible with copper, PEX or CPVC



558-2

Part #	Mfg #	Size	Price
030697	558-2	1/2" CTS	
030801	558-3	3/4" CTS	
043198	558-4	1" CTS	

EZGlide™ Suspension Clamp

- Ribs allow pipe to glide easier and more silently when the pipe expands and contracts
- Split design allows for use after piping run
- For use with any CTS pipe (copper, PEX, CPVC, PB)
- Available in standard or plenum-safe models



557-2

Part #	Mfg #	Size	Price
027599	557-2	1/2" CTS	
027600	557-3	3/4" CTS	
042403	557-4	1" CTS	

EZGlide™ Standard Tube Clamp

- Ribs allow pipe to glide easier & more quietly when the pipe expands & contracts
- V-shaped split design for easy installations
- Compatible with copper, PEX or CPVC
- Plenum Safe™ models meet ASTM E84 25/50 flame/smoke spread and UL94 V-0 flame rating



559-2

Part #	Mfg #	Size	Price
010017	559-2	1/2" CTS	
010018	559-3	3/4" CTS	
030988	559-4	1" CTS	
030987	559-5	1-1/4" CTS	
042879	559-6	1-1/2" CTS	
130138	559-7	2" CTS	

Grid-Iron™ Universal Bracketing System

- Fits inside 2x4 wall when strapped to 2" pipe
- 25% Stronger than Pipe Titan™
- 1" On-center grooves in bracket
- Ideal for island sinks
- Use cable ties as alternate fasteners
- Great pipe organizer for slab jobs
- Compatible with copper, PEX and CPVC



Part #	Mfg #	Bracket	Clamps	SS Band	Price
038733	571-20	1	(2) Touchdown	(1) 5"	

Power Bar™ Universal Slider Bracket for 9" - 16"

- Galvanized steel bracket and tough plastic clamp support pipe in numerous applications
- For use with any CTS pipe (copper, PEX, CPVC, PB)



523-1624

Part #	Mfg #	Bracket	Clamps	Screws	Price
122569	523-1624	1	(2) Touchdown	(4) Drill-Tip	

PipeTitan™ Universal Bracketing System (Plus Five Kit)

- Non-metallic – no electrolysis worries
- Isolates pipe and reduces noise
- Compatible with copper, PEX and CPVC



572-20

Standard Green

Part #	Mfg #	Bracket	Straps	Clamp	Band	Price
183510	570-20	1	2	1	5" SS	

Flame Retardant Red

Part #	Mfg #	Bracket	Straps	Clamp	Band	Price
183512	572-20	1	2	1	5" SS	

Plastic Hangers

PVC Sch 40 Fittings
PVC Sch 40 2-Hole Pipe Clamp



Part #	Size	Price
034520	1/2"	
034521	3/4"	
034522	1"	
072121	1-1/4"	
036755	1-1/2"	
034523	2"	

Piping Supplies & Accessories

Plastic Hangers

Piping Supplies & Accessories

Pipe Clamps

Full Clamp with Barbed Nail



Part #	Mfg #	Size	Pkg Qty	Price
007941	33905	1/2"	100	
007973	33906	3/4"	50	
007935	33907	1"	25	

Versa-Link™ Modular CTS Clamp

- *Designed for quick connection*
- *Use on: PEX, CPVC or copper pipe*



Part #	Mfg #	Size	Pipes	Price
116224	33682	1/2"	1	

Plastic Hangers

Pipe Strap
1-Hole Galvanized Pipe Strap



Part #	Mfg #	Size	Price
143655	H18-075	3/4" IPS	

Potable Water Expansion

Potable Thermal Expansion Tanks

Therm-X-Trol® Thermal Expansion Tank

- For use with potable water heaters only
- Non-ASME
- Pre-pressurized, diaphragm type
- Drawn steel domes, welded steel construction
- Rigid polypropylene liner
- Butyl diaphragm, diaphragm hoop ring mechanically grooved for permanent air-tight seal
- Stainless steel system connection
- Maximum operating system: 200°F
- Maximum working pressure: 150 psig
- Factory pre-charge: 40 psig
- 5-Year limited warranty



Therm-X-Trol® In-Line Thermal Expansion Tank

Part #	Mfg #	Dia	Height	Volume	Price
001998	ST-5	8"	13"	2.0 gal	
111686	ST-8	9"	15"	3.2 gal	
001996	ST-12	11"	15"	4.4 gal	

Therm-X-Trol® Vertical Stand Thermal Expansion Tank

Part #	Mfg #	Dia	Height	Volume	Price
001997	ST-25V	15"	19"	10.3 gal	
021624	ST-42V	15"	32"	20.0 gal	

Therm-X-Span® Inline Thermal Expansion Tanks T-Series

- For use in closed, potable water systems to control pressure build-up
- Heavy Duty steel shell with polypropylene liner
- 1-Year Warranty

Part #	Mfg #	Dia	Height	Volume	Price
170431	T-5	8"	13"	2.0 gal	
193096	T-12	11"	15"	4.4 gal	

Potable Water Expansion

Hydronic Expansion Tanks

PLT - Potable Water Expansion Tank (MNPT)

- Lead-free, polypropylene liner; rugged flexible butyl diaphragm
- Field adjustable pre-charge
- Use with most standard direct fired water heaters and storage tanks
- Maximum pressure: 150 psi
- Maximum temperature: 200°F
- 3/4" MNPT Connections



Part #	Mfg #	Model	Volume	Price
098950	0067370	PLT5	2.1 gal	
128649	0067371	PLT12	4.5 gal	



Pipe Cutting Oil

Thread Cutting Oil

- Can be used on most metals
- For heavy-duty cutting, threading, tapping and broaching of steel



16267



16337

Part #	Mfg #	Description	Price
005511	016150	1 gal, Clear	
017673	16267	Plumb Label, Dark, qt	
017674	16337	Plumb Label, Dark, gal	

Piping Supplies & Accessories

Pipe Cutting Oil

Lubricants Dark Cutting Oil



Part #	Mfg #	Model #	Size	Price
145665	80421	R1625	1 gal	

Piping Supplies & Accessories

Pipe Sleeving

Pipe Sleeving

- Underground sleeving protects against lime reaction in concrete
- Individually boxed and color-coded (red for hot, blue for cold)
- UPC Approved & IAPMO listed



Part #	Mfg #	Thickness	Color	Price
053944	S22-002	6 mil	Blue	
184464	S22-003	10 mil	Red	
184465	S22-004	10 mil	Blue	

Pressure Gauges

Pressure Gauges - Thermometers

Lazy Hand Water Test Gauge

- Regular pressure hand pushes Lazy Hand to peak operating or surge pressure point where it remains until manually reset
- Excellent to determine if P/T valve is leaking from failure or if leaking is caused by surge or excessive pressures (gauge attached to boiler drain overnight)
- Lazy Hand operates over entire gauge range
- Plastic face
- Supplied with protective filter washer
- 3/4" FHT Brass swivel connection



Part #	Mfg #	PSI	Price
029882	1428	0-300#	

Air Test Gauge Assembly

- Plastic face
- All parts precision made and assembled with sealant
- 3/4" FPT
- 2" Gauge



Part #	Mfg #	Description	Price
022357	1427	0 - 30 psi, 1/3# Increments	
068334	1421	0 - 100 psi, 2# Increments	

Bell Reducer Air Test Gauge Assembly

- Bell reducer type
- All parts precision made and assembled with sealant
- 3/4" or 1" FPT
- 2" Gauge
- Snifter valve



Part #	Mfg #	PSI	Connection	Price
142941	1413	0-100#	3/4" FPT	
029299	1414	0-30#	1" FPT	

Piping Supplies & Accessories

Pressure Gauges

Piping Supplies & Accessories

Pressure Test Equipment

Test Gauge Assembly - Bell Type



Part #	Mfg #	Description	Price
115335	G67-030	30 lb x 1" FIP	

Gauge Assembly

- Bell Type
- 3/4" FIP



Part #	Mfg #	Description	Price
188152	G66030	0-30# Bell Test Gauge	
151566	G66100	0-100# Bell Test Gauge	

Test Gauges

Test Gauge w/2" Face

- For use with Air, Water, Oil, Gas
- Shatter Proof Face
- 1/4 MIP Brass Connection
- Not for use on Oxygen
- 0-15



Part #	Mfg #	Description	Price
171490	G60015	0-15 PSI Gauge w/ 2" Face	

Test Gauge w/ 2" Face

- For use with Air, Water, Oil, Gas
- Shatter Proof Face
- 1/4 MIP Brass Connection
- Not for use with Oxygen
- 0-30



Part #	Mfg #	Description	Price
171491	G60030	0-30 PSI Gauge w/ 2"Face	

Test Gauge w/ 2" Face

- For use with Air, Water Oil , Gas
- Shatter Proof Face
- 1/4 MIP Brass Connection
- Not for use with oxygen
- 0-100PSI



Part #	Mfg #	Description	Price
171492	G60100	0-100 PSI Gauge w/ 2" Face	

Test Gauge w/ 2" Face

- For use with Air, Water, Oil, Gas
- Shatter Proof Face
- 1/4 MIP Brass Connection
- Not for use with Oxygen
- 0-200



Part #	Mfg #	Description	Price
171493	G60200	0-200 PSI Gauge w/ 2" Face	

Gas Test Gauge

- Adapts to 3/4" MPT
- Steel Case w/ 2" Face
- Plated with 3/4L FIP inlet
- Brass Air Valve



Part #	Mfg #	Description	Price
169925	G64030	0-30 Gas Test gauge	

Gas Test Gauge

- Adapts to 3/4" MPT
- Stee Case w/ 2" Face
- Plated with 3/4" FIP inlet
- Brass Air Valve



Part #	Mfg #	Description	Price
169924	G64100	0-100 Gas Test Gauge	

Pressure Gauges

Gas Test Gauge

- 2" Steel case gauge on 15 lb
- Marked in 1/10# increments
- Adapts to 3/4" MPT
- Brass air valve
- Plated body with 3/4" FIP inlet
- Individually boxed



Part #	Mfg #	Description	Price
147967	G64-015	15 lbs	

Piping Supplies & Accessories

Sealants, Cements & Lubricants

Piping Supplies & Accessories

Toilet Repair Aids

LiquiLock™ Gel

- Solidifies water for easy toilet removal
- Prevents water spills
- Gel formed in 4 minutes
- Non-toxic, Lo-VOC



Part #	Mfg #	Size	Pkg Qty	Price
133661	31417	0.6 oz	50	

Plastic Pipe Cement

All Purpose Cement

- Medium-bodied milky clear cement for ABS, PVC and CPVC pipe and fittings up to 6" diameter with interference fit
- Recommended for potable water, conduit and DWV
- Recommended application temperature: 40° to 110°F
- Meets performance requirements of ASTM D2564, D2235 and F493



30847

Part #	Mfg #	Size	Price
007992	30818	4 oz	
008006	30821	8 oz	
007945	30834	16 oz	
007965	30847	32 oz	
146051	30848	1 gal	

PVC Heavy-Duty Clear Cement

- Heavy-bodied clear cement for PVC pipe and fittings up to 12" diameter with interference fit, up to 18" for non-pressure
- Thick formula fills gaps in large diameter pipe and loose fitting joints
- Recommended for potable water, pressure pipe, conduit and DWV
- Recommended application temperature: 40° to 110°F
- Meets ASTM D2564



31008

Part #	Mfg #	Size	Price
007997	30850	4 oz	
008009	30863	8 oz	
007951	30876	16 oz	
007968	31008	32 oz	

PVC Medium Clear Cement

- Medium-bodied clear cement for use on PVC pipe and fittings up to 6" diameter for Sch 40 and Sch 80
- Recommended application temperature: 40° to 110°F
- Recommended for potable water, pressure pipe, conduit and DWV
- Meets ASTM D2564



31020

Part #	Mfg #	Size	Price
008010	31018	8 oz	
007953	31019	16 oz	
007969	31020	32 oz	

PVC Regular Clear Cement

- Regular-bodied clear cement for use on PVC pipe and fittings up to 4" for DWV Sch 40 and up to 2" for Sch 80
- Recommended for all grades and types of PVC pipe and fittings, potable water, pressure pipe, gas, conduit and DWV



Part #	Mfg #	Size	Price
136357	31014	16 oz	

PVC Heavy-Duty Gray Cement

- Heavy-bodied gray cement for use on PVC pipe and fittings up to 12" diameter with interference fit, up to 18" for non-pressure
- Thick formula fills gaps in large diameter pipe and loose fitting joints
- Recommended for potable water, pressure pipe, conduit and DWV
- Recommended application temperature: 40° to 110°F
- Meets ASTM D2564



Part #	Mfg #	Size	Price
007952	31095	16 oz	

Sealants, Cements & Lubricants

PVC Rain-R-Shine® Blue Cement

- Medium bodied blue colored cement for use on PVC pipe and fittings up to 6" dia
- Very fast setting cement formulated for wet conditions &/or quick pressurization and fast installation
- Use with Sch 40 and 80
- Pool/irrigation
- Recommended application temperature: 40° to 100°F
- No primer needed on non-pressure DWV, where local codes permit
- Meets ASTM D-2564

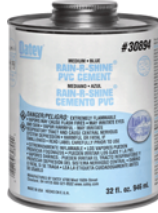

30894

Part #	Mfg #	Size	Price
007956	30893	16 oz	
007971	30894	32 oz	

PVC All Weather Clear Cement

- Medium-bodied clear cement for use on PVC pipe and fittings up to 6" diameter with interference fit
- Recommended application temperature: -15° to 110°F
- Recommended for use on potable water, drain, waste and vent systems
- No primer needed on non-pressure DWV, where local codes permit
- Meets ASTM D2564



31133

Part #	Mfg #	Size	Price
007946	31132	16 oz	
007966	31133	32 oz	

PVC Polar-Weld™ All Weather Clear Cement

- Medium-bodied cold weather cement for PVC pipe and fittings up to 6" diameter for Sch 40 and 80
- Formulated for fast-setting at temperatures down to -5° to 110°F
- PVC Cement is Low-VOC Compliant
- Meets ASTM-D2564



Part #	Mfg #	Size	Price
139844	2624	1 gal	
083935	2646S	16 oz	

ABS To PVC Transition Green Cement

- Medium-bodied green cement for use in joining ABS to PVC in non-pressure transition joints up to 6" diameter
- Recommended application temperature: 40° to 110°F
- Meets ASTM D3138



Part #	Mfg #	Size	Price
037607	30900	4 oz	

CPVC Medium Orange Cement

- Medium-bodied orange cement for use on CPVC pipe and fittings up to 6" diameter
- For residential and commercial hot and cold water systems up to 200°F
- Recommended application temperature 40° to 110°F
- Meets ASTM F-493 and ASTM D-2846



31128



31129

Part #	Mfg #	Size	Price
007994	31128	4 oz	
008008	31129	8 oz	

Plastic Pipe Primers/Cleaners

Clear Primer - NSF Listed

- Clear aggressive primer for use on PVC and CPVC pipe and fittings
- Removes surface dirt, grease and grime as well as softens the pipe surface to allow a fast, secure solvent weld
- NSF Listed
- Meets ASTM F656



30753

Part #	Mfg #	Size	Price
007948	30752	16 oz	
043557	30753	32 oz	

Sealants, Cements & Lubricants

Piping Supplies & Accessories

Purple Primer/Cleaner

- Purple tinted all purpose primer/cleaner for PVC and CPVC pipe and fittings
- Removes surface dirt, grease and grime as well as softens pipe in preparation for solvent cement
- Purple tint for verification for code
- Less aggressive than clear and purple primer



30806

Part #	Mfg #	Size	Price
007999	30780	4 oz	
008012	30783	8 oz	
007954	30796	16 oz	
007970	30806	32 oz	

Clear Cleaner

- Clear cleaner for ABS, PVC and CPVC pipe and fittings
- All schedules and all diameters
- Flows freely and evaporates quickly
- Fast removal of surface dirt, grease and grime



30805

Part #	Mfg #	Size	Price
007993	30779	4 oz	
008007	30782	8 oz	
007947	30795	16 oz	
007967	30805	32 oz	
007964	30766	1 gal	

Applicators

- Fits wide and standard mouth sizes



Part #	Mfg #	Description	Price
051994	31275	12" Gallon Can Roller Applicator	

Sealants, Cements & Lubricants

Cement

PVC 702™ Clear Regular Bodied Low VOC Cement

Part #	Mfg #	Model #	Size	Price
142555	10976	107020031	1 pt	

PVC 717™ Clear Heavy Bodied Low VOC Cement

- Quality formulation for plumbing, industrial, pool, irrigation and electrical piping systems
- Good gap filling properties
- Maximum recommended pipe size: 12" PVC
- Medium set time allows for more working time in warm weather



Part #	Mfg #	Model #	Size	Price
142416	10861	107170051	1/4 pt	
142415	10150	107170041	1/2 pt	
142412	10147	107170031	1 pt	
123475	10144	107170021	1 qt	
068855	10141	107170011	1 gal	

PVC 717™ Gray Heavy Bodied Low VOC Cement

- Quality formulation for plumbing, industrial, pool, irrigation and electrical piping systems
- Good gap filling properties
- Maximum recommended pipe size: 12" PVC
- Medium set time allows for more working time in warm weather



Part #	Mfg #	Model #	Size	Price
108711	10145	107170121	1 qt	
107542	10142	107170111	1 gal	

PVC 727™ Clear Medium Bodied Hot 'R Cold Cement



Part #	Mfg #	Model #	Size	Price
142425	10842	107270031	1 pt	
142424	10841	107270021	1 qt	
074086	10840	107270011	1 gal	

PVC 735™ Wet 'N Fast™ Blue Medium Bodied Cement

- Plumbing quality cement for wet conditions and/or quick pressurization
- Can be used without primer or non-pressure systems if local codes permit
- Maximum recommended pipe size:
 - 6" PVC
 - 4" Sch 80 PVC - PN 10 and 16
- Extremely fast set time



Part #	Mfg #	Model #	Size	Price
142427	12496	107350931	1 pt	
142426	12495	107350921	1 qt	

PVC/CPVC/ABS/Styrene 790™ Clear Medium Bodied Multi-Purpose Cement



Part #	Mfg #	Model #	Size	Price
131652	10258	107900031	1 pt	

Primers & Cleaners

PVC/CPVC P-68™ Low VOC Purple Primer

- Quality primer essential for proper softening and preparation of PVC and CPVC pipe and fitting surfaces



Part #	Mfg #	Model #	Size	Price
142423	10212	107680431	1 pt	
142421	10210	107680421	1 qt	

PVC/CPVC P-68™ Low VOC Clear Primer

- Quality primer essential for proper softening and preparation of PVC and CPVC pipe and fitting surfaces



Part #	Mfg #	Model #	Size	Price
142422	10211	107680031	1 pt	
110766	10209	107680021	1 qt	
068858	10207	107680011	1 gal	

Sealants, Cements & Lubricants

Piping Supplies & Accessories

PVC/CPVC P-70™ Industrial Grade Low VOC Purple Primer

- Premium industrial strength primer essential for proper softening and preparation of PVC and CPVC pipe and fitting surfaces
- Specially recommended for use on Sch 80 (PN 10 and higher) and larger pipe
- Excellent for cold weather applications



Part #	Mfg #	Model #	Size	Price
007938	10221	107700411	1 gal	

PVC/CPVC P-70™ Industrial Grade Low VOC Clear Primer

- For Sch 80 and large size pipe



Part #	Mfg #	Model #	Size	Price
118388	10222		1 qt	
082781	10220	107700011	1 gal	

PVC/CPVC/ABS/Styrene C-65™ Low VOC Clear Cleaner

- For removal of oil and grease from the surfaces of PVC, CPVC, ABS and Styrene pipe and fittings for bonding
- Recommended for use before priming of pipe and fittings



Part #	Mfg #	Model #	Size	Price
142419	10203	107650041	1/2 pt	
142418	10202	107650031	1 pt	
142417	10201	107650021	1 qt	
068857	10200	107650011	1 gal	

Solvent Welding Applicators Roller & Swab



Part #	Mfg #	Description	Price
034500	10008	006310000 7020 Jumbo Roll-A-Weld 7" Roller for MT-648 Gallon Can	
034499	10009	006320000 4020 4" Swab for MT-648 Gal Can	

Can-Tote Cement and Primer Carrier



Part #	Mfg #	Description	Price
127106	12891	For Quart & Pint Cans	

Storage Cans

Empty Solvent Welding Container



Part #	Mfg #	Description	Price
068861	10010	006480000 MT-648 Gallon Can with 2-7/8" Neck	

Sealants, Cements & Lubricants

Lead Supplies Lead Pouring Ladle



Part #	Mfg #	Size	Price
126943	L42-103	3-1/2"	

Oakum

- Original Oakum with benonite - expands over 10 times when wet
- Baled in coils or cut length
- No tar in brown oakum



Part #	Mfg #	Description	Price
007796	O15-001	Brown Random Cut 10 - 5 lb Bags Pack	
094215	O15-006	Brown Random Cut - 1 lb Bags Pack	

Cements

Wet-R-Dri Roofing Cement

- All-weather plastic
- Chemically fortified to bond to water-covered, damp or dry surfaces
- Great for emergency repairs under wet conditions



Part #	Mfg #	Description	Price
224697	C09002	10.5oz	

Sealants, Cements & Lubricants

Lead Ingot

Part #	Mfg #	Description	Price
005984	02INGOTLEAD	Lead Ingot, 25 lb Brick or (5) 5 lb blocks	

Lead Wool

Part #	Mfg #	Description	Price
005985	02LEADWOOL	5 lb Bag	

Sealants, Cements & Lubricants

Thread Sealants

Gasoil® Soft-Set Pipe Seal with PTFE

- General purpose, use on all metals and most plastics
- Non-toxic
- Remains pliable in cold temperatures
- Non-separating
- Not for use with oxygen systems



Part #	Mfg #	Description	Price
034248	SS04	1/4 pt Can w/Brush Top	
034249	SS08	1/2 pt Can w/Brush Top	
034250	SS16	1 pt Can w/Brush Top	



Sealants, Cements & Lubricants

Specialty Sealants

PTFE Tape

- White virgin Teflon, 0.4 density, 0.003" thick
- Over 50% elongation, chemically inert
- Tolerates -400° to +500°F
- For use on oxygen systems
- Non-toxic and non-flammable



Part #	Mfg #	Description	Price
005521	017209-144	3/4" x 260" Spool	
005522	017400-144	1" x 520" Spool, 144/Case	

Plumb Label Teflon Tape



017082-500



017125-500

Part #	Mfg #	Description	Price
017669	017082-500	1/2" x 260"	
017670	017125-500	1/2" x 520"	

Yellow Gas Line PTFE Tape

- Extra heavy, full density
- Especially for gas lines
- Pressure rating: 10,000 psi
- 0.0035 mil Thick
- Tolerates -450° to 500°F
- UL Listed, meets Federal Specification T-27730A



Part #	Mfg #	Description	Price
046505	017065-144	1/2" x 260" Spool, 144/Case	

TFE String

- Teflon string form for gaskets and packing valves
- Tolerates -400° to +500°F
- Will withstand vibration and high pressure



Part #	Mfg #	Description	Price
005524	20080	3/32" x 600' Cup	

TFE Paste

- Teflon pure white thread lubricant and sealant
- Non-hardening
- Withstands up to 10,000 psi
- Tolerates -100° to +500°F
- Not for use on fluorine or oxygen systems



Part #	Mfg #	Description	Price
005527	023015	1 oz Tube	
005529	023030	4 oz Brush Top Bottle	
111294	023045	8 oz Brush Top Bottle	
018484	23257	Plumb Label, 8 oz	

Harveyseal Thread Sealant

- For all types of gas lines
- Tolerates -50° to +400°F
- Gas to 3,000 psi, liquid to 6,000 psi
- Soft, slow drying



Part #	Mfg #	Description	Price
048148	25050	8 oz Brush-Top Bottle	

Pipe Thread Compound

- Gray, thixotropic non-drip paste for lines carrying water, steam, air or natural gas
- Never hardens
- Contains no lead, non-toxic



Part #	Mfg #	Description	Price
005534	028005-12	2 oz Pipe	

Pipe Thread Stick

- Maximum pressure: 2,000 psi
- Maximum temperature: 350°F
- Not for use on oxygen systems



Part #	Mfg #	Description	Price
005537	030005-48	1.25 oz Stick, 48/Case	

Sealants, Cements & Lubricants

Thread Sealants

Slic-tite[®] Paste with PTFE - Premium Thread Sealant

- Contains more PTFE particles for sealing power
- Brushes easily on wet or oily threads
- Sticks to hot, oily threads
- Non-toxic, non-drying
- Washes off hands and clothing easily
- Seals to high pressures:
 - 10,000 psi for Liquids
 - 3,000 psi for Gases
- Sealing temperature range: -50° to 500°F
- For sealing water, air, steam, natural gas, LP gas, refrigerants, ammonia, gasoline and oil
- Use on metal, PVC, CPVC and ABS plastic pipe threads



42009

Part #	Mfg #	Description	Qty/Case	Price
005978	42009	1/4 pt Brush-in-Cap	24	
005979	42019	1/2 pt Brush-in-Cap	24	
005980	42029	1 pt Brush-in-Cap	24	

Slic-Tite[®] Stik with PTFE

- PTFE Particles for greater sealing power
- Non-toxic, non-staining, non-drying
- Washes off easily
- For sealing water, air, natural gas, steam, gasoline, oil, refrigerants and ammonia
- Sealing temperature: -50° to 350°F



Part #	Mfg #	Size	Price
005977	41600	1-1/4 oz	

Pipe Dope

- No-drip siliconized for fast application on metal threads
- For sealing water, steam, air and natural gas
- Lead-free, non-toxic
- Seal temperature up to 350°F



Part #	Mfg #	Description	Price
005968	12219	1/2 pt T-o-t	

PIPETITE[™] Paste - Soft Set Thread Compound

- For sealing water, steam, air, natural gas, LP gas, refrigerants, gasoline, oil and butane
- Seal temperature up to 400°F



Part #	Mfg #	Description	Price
005967	12112	1 pt Brush-in-Cap	

Pipetite-Stik[®]



- For sealing water, steam, air, natural gas and LP gas

Part #	Mfg #	Description	Price
005964	11175	Thread Sealant in a Stick	

Piping Supplies & Accessories

Sealants, Cements & Lubricants

Teflon® Tape

Blue Monster™ PTFE Thread Seal Tape

- Seals fittings at pressures up to 10,000 psi
- Temperature range: -450° to 500°F
- Seals threads effectively in more applications
- Acts as a thread lubricant and anti-seize



Part #	Mfg #	Description	Price
110975	70885	1/2" x 1,429" Roll	
110978	70886	3/4" x 1,429" Roll	
110979	70887	1" x 1,429" Roll	

Plumber's Full-Density Thread Seal Tape 3-Wrap Water Line (Red) Teflon® Tape TF5-15

- For plumbers and pipe fitters
- May be used on most thread seal connections (metal or plastic) involving air, water, sewage, chemicals, hydraulic systems and overhead sprinkler systems



Part #	Mfg #	Description	Price
023758	70796	1/2" x 260" Roll, 10/Pk	

Green Full Density Oxygen PTFE Thread Seal Tape

- Applications:
 - Oxygen lines, systems and other flammable environments
 - Liquid, oil and chemical installations
- 99.6% PTFE
- Pressure rating: up to 2,173.9 psi
- Temperature range: -450° to 500°F



Part #	Mfg #	Description	Price
043337	70850	1/2" x 260" Roll, 10/Pk	
107060	70852	3/4" x 260" Roll, 6/Pk	

Thread Sealing Compounds

Blue Monster™ PTFE Heavy-Duty Industrial Grade Thread Sealant

- Slow-drying, soft-setting, non-hardening pipe thread compound
- Recommended for on-site or assembly line work
- Lead-free, non-toxic and will not harden or separate in the can
- Pressure ratings:
 - Gases up to 3,000 psi
 - Liquids up to 10,000 psi



Part #	Mfg #	Size	Price
126236	76003	1/2 pt	
126237	76005	1 pt	



Sealants, Cements & Lubricants

Thread Sealants

Pro Dope® Pipe Joint Compound Thread Sealant

- Lead-free, no-drip, no-spill and non-toxic
- No mixing - will not harden - uniform throughout can
- Lubricates while forming tight pressure seal
- Inhibits rust and corrosion
- Wipes clean from hands



Part #	Mfg #	Size	Price
145618	15420	1/2 pt	

Megaloc® Thread Sealant

- Made with DuPont™ KEVLAR®
- Lead-free, blue, grit-free high performance thread sealant
- Leak-proof hydraulic resistance up to 12,000 psi
- Withstands gas pressure up to 2,600 psi
- Performs over temperatures of -50° to 400°F
- Odorless, non-separating and non-hazardous
- Never hardens, cracks or becomes brittle
- Wipes clean from hands with a dry rag



15806

Part #	Mfg #	Size	Price
063183	15806	1/2 pt	
083769	15808	1 pt	

Real-Tuff™ Thread Sealant

- Lead-free, multi-purpose, heavy-duty PTFE paste thread sealant
- Non-toxic and non-separating
- Positive, leak-proof seal on all piping material and for all liquids and gases except oxygen



15625

Part #	Mfg #	Size	Price
118663	15615	1/4 pt Brush-in-Cap	
101959	15620	1/2 pt Brush-in-Cap	

Block™ Thread Sealant

- Lead-free, brushable, blue, all-purpose, leak-proof non-hardening, pipe joint and gasket sealing compound
- Semi-liquid forms tough, pliable film on joints, valves, flanges and gaskets



Part #	Mfg #	Size	Price
098040	15707	1/2 pt	
181253	15711	1 pt	

Plastic Pipe Primers and Cleaners

PVC and CPVC UnPurple Primer® (Green Label)

- Softens and prepares surfaces of PVC pipe and fittings before applying solvent cements
- Special purple dye appears clear - purple color revealed only under UV light



Part #	Mfg #	Size	Price
136419	60445	1 pt	

PVC Primer - Clear

- Professional grade primer for use on all schedules and classes of PVC pipe and fittings
- Lo-V.O.C. Solvent Cement meets California South Coast Air Quality Management District (SCAQMD) 1168/316A
- Removes surface dirt, grease and grime as well as softens the pipe surface to allow a fast, secure solvent weld
- Meets ASTM F656



Part #	Mfg #	Size	Price
168280	60465	32 oz, Jumbo Dauber	

R-D™ Root Destroyer

- Non-acid
- Safe to use in lines leading to septic tanks, cesspools, and drywells
- Dissolves slowly
- Not for use in CT



Part #	Mfg #	Size	Price
163209	20602	2 lbs	

Piping Supplies & Accessories



Sealants, Cements & Lubricants

Cements

High Heat Furnace Cement

- Unique environmentally clean and friendly formula
- Will not shrink, crack or crumble
- Meets OSHA requirements
- Contains no asbestos



Part #	Mfg #	Size	Price
182835	35526	1 Gal	

Lubricants

300 Degree Plumber's Grease

- Petroleum oil-based valve and faucet stem grease
- Waterproof; prevents corrosion
- Non-melting, non-hazardous
- Withstands temperatures from -20°F to 300°F.



Part #	Mfg #	Size	Price
160776	40601	2 oz	



Sealants, Cements & Lubricants

Hand Cleaners

Hercules for Hands™ Anti-Bacterial Hand Cleaning Towel

- Ready-to-use, pre-saturated towels remove plastic pipe cement, grease and grime, tar and ink from users' hands
- Contains aloe, lanolin, and vitamin E
- Towels will not shred and leaves no residue



Part #	Mfg #	Description	Price
063184	45333	Dispenser Tub of (70) Towels	

PTFE Tape

Megatape Professional PTFE Tape

- High density - 3.5 mils thick
- Extra large 1000" spool



Part #	Mfg #	Size	Price
155540	15100	1/2" X 1000"	
155541	15110	3/4" X 1000"	
155542	15120	1" X 1000"	

Sealants, Cements & Lubricants

Piping Supplies & Accessories

Pipe Compounds

Great White™ Pipe Joint Compound with Teflon®

- Lubricates and seals all threaded joints
- White, non-hardening, non-separating, non-toxic paste
- Withstands up to 3,000 psi on gases from -50° to +400°F and 10,000 psi on liquids from -50° to +500°F
- For use with water, steam, natural and LP gas, oil, caustics or dilute acid lines of PVC, CPVC, ABS, cycolac, polypropylene, iron, steel or copper



Part #	Mfg #	Size	Price
008011	31231	8 oz with Dauber	

Great Blue® Pipe Joint Compound

- Flexible blue, non-hardening, non-separating, non-toxic paste, no odor, easy clean-up
- Use on PVC, CPVC, ABS, polyethylene, polypropylene, iron, steel, copper or brass threads up to and including 2"
- Withstands up to 3,000 PSI on gases from -50° to +400°F and 10,000 PSI on liquids from -50° to +500°F
- For use with water, steam, caustics or dilute acid lines of PVC, CPVC, ABS, cycolac, polypropylene, iron, steel or copper
- Lubricates and seals thread on water, natural gas, steam, air lines, caustics and dilute acids



Part #	Mfg #	Size	Price
175512	31262	8 oz	
187715	31263	16 oz	

Pipe/Gasket Lube

- Non-toxic, soft, paste like material for lubricating bell joint pipe gaskets
- Will not deteriorate natural or synthetic rubber
- Will not support bacteria
- Dissolves in hot water



Part #	Mfg #	Size	Price
006176	30600	1 qt	
006175	30601	1 gal	

Solvent Cement and Primer Accessories

Adjustable Daubers

- Ideal for apply solvent cement to pipe and fittings
- The adjustable handle extends to 6" length
- To fit 8 oz to quart size containers



Part #	Mfg #	Size	Price
167736	31301	100 Pack, For 8oz to Quart	
162264	31312	48 Pack, For 32 oz	



Sealants, Cements & Lubricants

Pipe Thread Sealants

RectorSeal® T Plus 2® Pipe Thread Sealant

- White color
- Non-setting, multipurpose compound
- Contains PTFE, plus synthetic fibers to create a stronger seal



Part #	Mfg #	Size	Price
008858	23551	1/2 pt Brush Top	

RectorSeal® No. 5® Pipe Thread Sealant

- Yellow color
- Multipurpose, soft-set



Part #	Mfg #	Size	Price
008862	25631	1/4 pt Brush Top	
008861	25551	1/2 pt Brush Top	
008860	25431	1 pt Brush Top	

RectorSeal® No. 21 Black Jack™ Pipe Thread Sealant

- Black color
- Slow dry, soft set



Part #	Mfg #	Size	Price
022732	28541	1 pt Brush Top	

RectorSeal® Tru-Blu™ Pipe Thread Sealant

- Blue color
- Contains PTFE for high vibration environments



Part #	Mfg #	Size	Price
093177	31780	1-3/4 oz Tube	
078593	31431	1 pt Brush Top	

Piping Supplies & Accessories

Sealants, Cements & Lubricants

Adhesives & Sealants

Leak Lock Sealant

- Pipe joint sealant
- Seals threaded joints, flanged joints, gasket surfaces & mating surfaces
- Effective in temperatures from -200° to 400°F, full vacuums & pressures to 10,000 psi
- Never hardens



Part #	Mfg #	Description	Price
140418	85-10001	1.33 oz Tube	
149946	85-10004	4 oz Can	

Piping Supplies & Accessories



Sealants, Cements & Lubricants

Sealants

Blue 75™ Thread Sealant

- *Special non-hardening, soft setting formulation*
- *Remains crushable to -50°F*
- *Anti-seize properties allow easy assembly and positive seal without over tightening*
- *Non-corrosive, non-conductive*
- *NSF Potable water approval*
- *Meets and exceeds TT-5-1732*



Part #	Mfg #	Size	Price
111697	SB75-020	1 Pint	



Sealants, Cements & Lubricants

Gruvlok® Chemicals Standard Lubricant

Part #	Mfg #	Description	Price
048524	Standard	4.5 oz Tube	
048523	Standard	1 Quart	

Extreme Temperature Silicone Lubricant

Part #	Mfg #	Description	Price
108540	Xtreme Temp	2.2 lb Can	

Piping Supplies & Accessories



Sealants, Cements & Lubricants

**LabWaste™ CPVC Corrosive Waste
Drainage System Accessories
LabWaste™ One-Step CPVC Cement**

Part #	Mfg #	Size	Price
085971	LW5-030	Quart	

Piping Supplies & Accessories

Soldering & Brazing

Piping Supplies & Accessories

MAPP Gas & Tanks



Part #	Mfg #	Description	Price
112728	MT-1 MAPP	14.1 oz MAPP, Throwaway Gas Cylinder	

Solder

Premium Lead-Free Sterling Solder

- NSF 61 Certified for safe use in potable water applications
- Melting temperature 410°F
- Tensile strength 7,130 psi



Part #	Mfg #	Description	Price
010355	331755	1 lb Spool	

Lead-Free Solder

- Patented formula advantages
- Low melting temperature: 419°F
- Increased flow properties
- High tensile strength: 6,950 psi



Part #	Mfg #	Description	Price
004142	331754	1 lb Spool	
010264	WS15018	Lenox Lead Free-Solder 95/5 11 716447911259	

50/50 Leaded Solder

- 50% Tin, 50% lead solder
- For use in non-potable water applications



Part #	Mfg #	Description	Price
010263	327882	1 lb Spool	

Soldering & Brazing

Nitrogen Tanks & Contents



Part #	Mfg #	Description	Price
105666	80-N-TANK	80 cu ft Nitrogen Tank	

Piping Supplies & Accessories

Soldering & Brazing

Piping Supplies & Accessories

Regulators

RPH Series High Pressure Delivery Regulator for Purging and Pressure Testing

- 2" Gauges
- Piston actuated seat
- Protective rubber gauge boots
- "T" Handle for easy pressure adjustment
- Delivery/contents: 600/4000 psi
- Outlet Connection: 1/4" Flare (M)
- Replacement gauges: G8S & G7S



Part #	Mfg #	CGA Inlet	psig	Price
103342	87-RHP400	580 Nitrogen	20-400	

Soldering & Brazing

Gas Cylinders



Nitrogen



Oxygen

Part #	Description	Price
006537	Acetylene, MC 10 cu ft Gas Only	
006536	Acetylene, MC 10 cu ft Tank Only	
006535	Acetylene, MC 10 cu ft Gas & Tank Combo	
002678	Acetylene, B 40 cu ft Gas Only	
002677	Acetylene, B 40 cu ft Tank Only	
002676	Acetylene, B 40 cu ft Gas & Tank Combo	
055895	Nitrogen, 40 cu ft Gas Only	
055894	Nitrogen, 40 cu ft Tank Only	
101954	Nitrogen, 40 cu ft Gas & Tank Combo	
063836	Nitrogen, 80 cu ft	
104873	Oxygen, 20 cu ft Gas Only	
042487	Oxygen, 20 cu ft Tank Only	
042488	Oxygen, 20 cu ft Gas & Tank Combo	



Soldering & Brazing

Flux

All Hercules Flux Can be Used with Soft Solder Alloys on Commonly Soldered Metals, but NOT Recommended for Use on Aluminum or Some Grades of Stainless Steel

Climate Smooth™ Soldering Paste

- Self-cleaning lead-free formula
- Made to withstand extreme climate temperatures
- Smooth, easily applied paste flux for easy flow in hot or cold weather
- For sweat soldering on most common metals



Part #	Mfg #	Size	Price
128565	10621	1 lb	



Soldering & Brazing

Brazing Alloys

Stay-Silv® 15 Brazing Alloy

- Used for air conditioning and refrigeration



RoHS COMPLIANT
USA MADE IN

Part #	Mfg #	Description	Price
010298	15620F1	1#, .050 x 1/8" x 28 Stick	

Blockade™ Silicon Brazing Alloy

- Color changes in the finished braze alloys
- For copper and brass
- Easily brazes brass and brass alloys without the addition of silver



Part #	Mfg #	Description	Price
064470	BK220R1	2mm x 20 Stick, Bare Rod	

Solder

Bridgit® Lead-Free Solder

- Contains nickel for strong joints
- Excellent for large diameter fittings and ill-fitting or non-concentric pipes

USA MADE IN
RoHS COMPLIANT



Part #	Mfg #	Description	Price
005079	BRGT61	1/8" x 1 lb Spool	

NICK™ Lead-Free Solder

- For joining copper pipe in potable water systems
- Excellent wetting and capping characteristics
- Produces extremely strong joint

Part #	Mfg #	Description	Price
027102	NICK61	1/8" x 1 lb Spool	

Stay-Brite® Silver Solder

- Bonds with all of the ferrous and non-ferrous alloys

USA MADE IN
RoHS COMPLIANT



Part #	Mfg #	Description	Price
009822	SB61	1/8" x 1 lb, 4%	
045432	SB861	#8, 1/8" x 1 lb, 6%	

Quicksilver

Part #	Mfg #	Description	Price
034505	QS620F1	1#, .050 x 1/8" x 28 Stick	

Flux

Bridgit® HT Paste Flux

- Stays active to 800°F
- Meets all the requirements of the Safe Drinking Water Act
- Designed for copper tube applications

USA MADE IN



Part #	Mfg #	Description	Price
002564	BRPF4	4 oz Hi Temp Flux	
002600	BRPF1	1 lb Hi Temp Flux	

Stay-Clean® Liquid Soldering Flux

- General purpose zinc chloride flux
- For soldering with all soft solders
- Use with tin/lead, tin/antimony, and Stay-Brite solders
- For virtually all metals except aluminum, magnesium, or titanium
- Not recommended for use in electrical or electronic applications

USA MADE IN



SCLF4 SCLF16

Part #	Mfg #	Description	Price
009966	SCLF4	4 oz Flip Top	
009965	SCLF16	16 oz Bottle	

Stay-Clean® Paste Soldering Flux

- Active soldering flux for use with tin/lead, tin/antimony, and tin/silver solders
- For most metals, copper, brass, bronze, steel, stainless steel, galvanized, monel
- Not recommended for aluminum, magnesium, or titanium
- Not recommended for use in electrical or electronic applications

USA MADE IN



Part #	Mfg #	Description	Price
009967	SCPF4	4 oz Brush Cap	



Soldering & Brazing

Stay-Silv® Brazing Flux

- For use with silver brazing alloys on all metals except aluminum, magnesium or titanium
- Effective to 1600°F
- Meets AMS 3411, AWS 5.31, Class FB3C; Fed Spec. 0-F-499D, Type B

**USA
MADE IN**



Part #	Mfg #	Description	Price
010299	SSWF7	7 oz Brush Cap	

Piping Supplies & Accessories

Soldering & Brazing

Solder

Silver Lead Free Plumbing Solder



Part #	Mfg #	Description	Price
007932	23001	1 lb Lead-Free Solder	

Flux

No. 5 Paste Flux

- Cleans and fluxes at the same time
- Effective on all metals except aluminum, magnesium and stainless steel
- 100% Lead-free
- Blended to clean surface oxidation



30041

Part #	Mfg #	Size	Price
101958	30014	8 oz	
020767	30041	16 oz	

No. 95 Tinning Flux

- Formulated with the same high quality as No. 5 however, patented Oatey® silver solder powder is added to pre-tin the copper pipe
- Flux can never burn out
- 100% Lead-free
- Excellent for large diameter copper
- Does not turn copper green



30372

Part #	Mfg #	Size	Price
008013	30372	8 oz	
007957	30374	1.7 oz	
162987	30375	16 oz	

H-20®95 Tinning Flux

- Effective on all metals, except aluminum and stainless steel
- Compatible with all common plumbing solder alloys
- Will not turn copper piping green



Part #	Mfg #	Size	Price
133660	30142	8 oz	
163844	30143	16 oz	



Soldering & Brazing

Soldering and Abrasive Supplies

E-Z Clean Abrasive Sandcloth

- Aluminum oxide
- 120 Grit
- 2 Layers of special adhesive and water-resistant resin



95109



95207

Part #	Mfg #	Description	Price
017657	95109	Plumb Label, 10 yds	
017658	95207	Plumb Label, 25 yds	

Open Mesh Abrasive Sandcloth

- Premium grade, 180 grit
- Fully waterproof
- Open nylon fabric with phenolic resin adhesive and aluminum oxide
- Can be used on both surfaces



Part #	Mfg #	Description	Price
017656	95807	Plumb Label, 10 yds	

Soldering Paste

- Lead-free, NSF approved
- Safe for potable water supplies when used with lead-free solders



Part #	Mfg #	Description	Price
033935	097210-12	Plumb Label, 1.7 oz	

Piping Supplies & Accessories

Soldering & Brazing

Brazing/Soldering Flux and Pastes

Regular Flux Paste

- Super detergent action cleans as it solders
- Water soluble for faster flushing from pipe lines
- Non-acid, non-toxic, lead-free
- Contains no zinc chloride
- For use on most metal types
- Use with all lead-free and common soft solders
- Meets MIL Spec MIL-F-4995 type II



22107

Part #	Mfg #	Size	Price
005970	22104	4 oz	
005971	22107	1 lb	

Soldering & Brazing

Piping Supplies & Accessories

Soldering Flux

NOKORODE® Aqua Flux™

- Cream color
- Water washable flux
- Conforms to ASTM B-813



74046

Part #	Mfg #	Size	Price
149852	74044	2 oz	
149853	74046	16 oz	

NOKORODE® Hot Weather Paste Flux

- Stays firm and stable in hot weather
- Recommended for use on all solder alloys including 95/5 and all lead-free solders



Part #	Mfg #	Size	Price
007743	14830	1 lb	

NOKORODE® Regular Paste Flux

- Will not freeze or decompose
- Odorless and lead-free
- Recommended for use on all solder alloys including 95/5 and all lead-free solders



14030

Part #	Mfg #	Size	Price
007744	14000	1.7 oz	
007741	14030	1 lb	

NOKORODE® Cold Weather Paste Flux

- Lead-free, soft soldering paste
- Ideal for use with 95/5
- Flux and cleans and at one time
- Remains soft and sticky in colder temperatures
- Low corrosivity, scorching and spattering



Part #	Mfg #	Size	Price
007742	14730	1 lb	



Soldering & Brazing

Soldering Flux Soldering Paste

- For copper sweat joints and brass fittings

Part #	Mfg #	Description	Price
075792	05-04	3 oz Bottle, 24/Case	
075793	05-09	1 lb Jar	

Soldering & Brazing

Piping Supplies & Accessories

Fitting Brushes

#6100 Standard Fitting Brush - Good Quality A

- Heavy gauge galvanized stem wire
- Single stem, single spiral construction
- Crimped high-carbon fill material



Part #	Mfg #	Nominal ID	Price
026528	61000	1/8"	
007446	61070	1/4"	
007447	61150	3/8"	
007448	61210	1/2"	
007449	61330	3/4"	
007450	61450	1"	
007451	61500	1-1/4"	
007452	61560	1-1/2"	
007453	61620	2"	

#6800 All Stainless Steel, Rust-Resistant "Quick Twist" Brush Superior Quality AA

- Only "all" stainless steel fitting brush
- Spark proof, will not rust



Part #	Mfg #	ID	OD	Price
036060	68120	2-1/2"	2-5/8"	

#6600 Hex Shank Power Fitting Brushes - Superior Quality AA

Carbon Steel 1/4" Hex Shank Power Fitting Brush

- Bulk (plumbing)
- For quick cleaning of fittings, tubing, drill holes, as well as deburring soft steel, stainless steel, brass, copper, aluminum, plastic and other materials



Part #	Mfg #	ID	OD	Price
062503	66430	1/2"	5/8"	
062504	66450	3/4"	7/8"	
062505	66470	1"	1-1/8"	

Cleaning Brushes

Power-Deuce Brushing Tool

- Fitting brush and OD tube cleaning brush designed for use with a cordless drill or power driver
- Self cleaning
- Power or manual use
- Rust-proof stainless steel bristles for plumbing and HVAC projects
- Durable ABS housing



Part #	Mfg #	Description	Price
068844	62821	1/2" ID (5/8" OD) Brush	
068845	62831	3/4" ID (7/8" OD) Brush	
097366	62841	1" ID (1-1/4" OD) Brush	
097367	62850	3 Size Power Pack, Quik-Change Chuck Adapter	

Multi-Function Brushes

Blue Monster Six-in-One Brush

- Clean the inside diameter of tubing
- Deburring plate to ream and debur the I.D. of tubing
- B-Tank gas key
- Can also serve as a bottle opener



Part #	Mfg #	Description	Price
134842	70255	1/2" x 3/4" ID Blue Monster (Plumbing)	

Abrasive Products

Blue Monster™ Aluminum Oxide Open Mesh

- 21 x 21 Mesh - resists clogging
- Premium blended 165 grit white aluminum oxide
- Waterproof
- Bright blue color



Part #	Mfg #	Size	Qty	Price
135950	70154	2" x 10 yd Roll	24/Pk	

Soldering & Brazing

Cleaning Towels

Blue Monster™ Heavy-Duty Citrus Scrubbing Towel Floor Display

- Pre-moistened, heavy-duty cleaning towel
- Flip-top container
- Free of harsh solvents and chemicals
- Lint free, quick drying



Part #	Mfg #	Description	Price
130861	77095	10" x 12" Towels, 75 Count	

Maintenance & Applicator Brushes

Acid, Solder Paste & Flux, Adhesive Applicator Brush

- Made with durable, coated in tin paste metal handles
- Handles are stamped firmly to the bristles to eliminate bristle fall-out
- Offered in three sizes with pure, stiff black-graded natural horsehair
- #70240 Brush has a hardwood handle with seamless aluminum ferrule

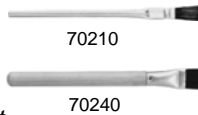

Part #	Mfg #	Size	Wire	Price
007458	70210	#1	1/4"	
007459	70220	#2	3/8"	

Piping Supplies & Accessories

Soldering & Brazing

Brushes

Acid Brush with Metal Handle

- 100% horse hair bristles
- Available in 3/8" or 1/2" wide



Part #	Mfg #	Wide	Long	Price
183832	771	3/8"	6"	

Fitting Brushes

- **Deluxe wood handle:**
—Solid wood, screwdriver type handle is easy to hold and turn
—stainless steel bristles
- **Plastic handle & open-loop handle**
—Carbon or stainless steel bristles
- **Drill Attachment:**
—Stem fits all power drill chucks
—Carbon or stainless steel bristles



Plastic Handle

Part #	Mfg #	Material	Size	Price
183817	700-4	Carbon Steel	1" CTS	
183818	700-5	Carbon Steel	1-1/4" CTS	
183819	700-6	Carbon Steel	1-1/2" CTS	
183820	700-7	Carbon Steel	2" CTS	

Drill Attachment

Part #	Mfg #	Material	Size	Price
083787	706-2	Carbon Steel	1/2" CTS	
083788	706-3	Carbon Steel	3/4" CTS	
083789	706-4	Carbon Steel	1" CTS	
183821	707-2	Stainless Steel	1/2" CTS	
183824	707-3	Stainless Steel	3/4" CTS	

Sand Cloths

Abrasive Mesh

- 180 grit open mesh is waterproof
- Rinse when mesh gets loaded with debris



Part #	Mfg #	Dispenser Box	Grit	Price
183825	730-10	10 Yard Roll	180	

General Purpose Cleaning Nylon Pad

- Use wet or dry
- Cleans copper tube and fittings for soldering

Part #	Mfg #	Size	Grit	Weave	Pad	Price
183826	750-69	6"x9"x1/4"	Fine	Tight	Red	

Soldering & Brazing

Pipe Brushes

Inner-Outer Copper Cleaning Brush

- High carbon steel brushes quickly cleans 1/2" or 3/4" nominal tube and fittings in preparation for soldering or brazing
- Durable plastic construction designed for easy brush replacement



Part #	Mfg #	Model	Description	Price
008730	34142	4100	I-O Copper Cleaning Brush	
019034	34147		Replacement Brush Set	

Soldering & Brazing

Piping Supplies & Accessories

Torches

Self-Igniting Hand Torch



330544 &
330545

330546

Part #	Mfg #	Description	Price
080597	330544	Self-Igniting w/Adj Swirl Flame	
080624	330545	Self-Igniting Adj Swirl Flame Replacement Assembly	
080598	330546	Self-Igniting Adj Ultra Swirl Flame	
084220	330554	Replacement Tip for LT92	
086360	330555	Replacement Tip for LT90 & LT91	

Mobile Torch System



Part #	Mfg #	Description	Price
107079	10883	LX300PS Mobile Torch System with LP300 3/8" Tip Included	
132787	330533	LX400FB Mobile Torch System Kit	

Self-Igniting Swirl Flame



Part #	Mfg #	Size	Price
113302	330590	1/2"	

"B" Air Acetylene Kit

- Includes:
 - Air acetylene piston regulator with TANKTOTE handle, GAUGE GUARD and 2" gauge
 - AA Torch handle
 - AA Hose
 - TANKTOTE sleeve
 - "B" Tank key
- Tank sold separately



Part #	Mfg #	Description	Price
089164	21839LX800B	LX800B Kit with AA800 5/16" Self-Igniting Swirl Flame Tip	

"MC" Air Acetylene Kit

- Includes:
 - Air acetylene piston regulator with TANKTOTE handle, GAUGE GUARD and 2" gauge
 - AA Torch handle
 - AA Hose
 - TANKTOTE sleeve
 - "MC" Tank key
- Tank sold separately



Part #	Mfg #	Description	Price
089165	21843LX800MC	LX800MC Kit with AA800 3/8" Self-Igniting Swirl Flame Tip	

Soldering & Brazing

Soldering and Welding

CutSkill® - CST Series Kit

- *CST-P & CST-PT:
Braze/weld 1/4" to 1-1/2"
for HVAC, refrigeration
and plumbing*
- *Includes:*
 - *Handle (SKH-7A)*
 - *Brazing nozzles
(0-W-J & 2-W-J)*
 - *Safety goggles
(1423-0017)*
 - *Striker (1423-0023)*
 - *Check Valves*
 - *Hose (252-03P)*
 - *Tote case (1421-0084)*



Part #	Mfg #	Oxy Reg	Fuel Reg	Price
112435	0386-1320	SKR-540R	SKR-200R	

* 20 cu ft

Piping Supplies & Accessories

Soldering & Brazing

Heat Barriers

Cool Gel[®] Heat Barrier Spray

- Unique gelled formula sticks to surfaces without dripping or running off
- Clear, non-staining gel leaves no residue eliminating clean-up
- Safe, non-toxic, harmless to skin and odorless
- Convenient trigger spray
- Helps protect rubber, plastic, distortion, painted, and finished surfaces during soldering, brazing or welding
- Reduces danger of fire to surrounding surfaces



Part #	Mfg #	Size	Price
041661	11509	1 qt	

Soldering & Brazing

Thermal Shield Spray
Cold Shield Thermal Shield

- Functions as a heat sink and a heat shielding material
- Non-toxic, environmentally safe, non-corrosive and non-flammable
- Stops heat from traveling through most metals
- Provides a heat barrier from direct, open flame contact



Part #	Mfg #	Description	Price
140751	86-1274-7	32 oz Tub Paste	

Piping Supplies & Accessories

Soldering & Brazing

Heat Pastes

Thermo-Trap®

- Heat absorbing paste to isolate heat encountered in soldering, welding, and brazing
- USDA Approved



Part #	Mfg #	Description	Price
140750	4371-36	11 oz Tube	

Piping Supplies & Accessories

Soldering & Brazing

Heat Shields

Torch Guard® Flame Blanket

- Asbestos-free and features high-strength needle-punched carbon fiber
- Ideal for confined working areas
- Flexible and provides heat resistance up to 2500°F
- Shield studs, wall, floors and surfaces from flames, sparks and molten splash during soldering and brazing operations
- Includes (2) brass grommets for hanging

Part #	Mfg #	Size	Price
007461	71034	12" x 12"	

Water-Gate Water Shut-Off Tools

- Solder without draining the entire water system
- Change out a valve, solder or glue on fittings, make line repairs and test lines while under pressure
- Ideal for refrigeration and boiler applications
- Seals withstands temperatures from -20° to 225°F
- Works on copper, steel or PVC lines
- Pressure rated to 65 psi



Part #	Mfg #	Size	Price
085299	77000	1/2"	
085300	77005	3/4"	
085301	77010	1"	
085302	77015	1-1/4"	
085303	77020	1-1/2"	
085304	77025	2"	

Water-Gate Replacement Seal



Part #	Mfg #	Size	Price
085308	77001	1/2"	
085309	77006	3/4"	
085310	77011	1"	
085311	77016	1-1/4"	
085312	77021	1-1/2"	
085313	77026	2"	

Tools

Deburring Tool

- Remove rough or irregular I.D. edges on plastic, ferrous and non-ferrous metals
- A fast and easy way to smooth edges of pipe and tubing
- Fixed blade "pencil" deburring tool clips on shirt pockets and fits anywhere
- Features hand-contoured handle and snap-on cap for convenient storage of replacement toolblades

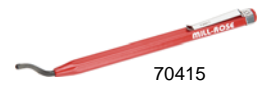

Part #	Mfg #	Description	Price
057936	70415	Deburring Tool, Carded with (3) Blades	
066641	70417	(5) Replacement Blades	

Soldering & Brazing

Deburring Tools

Pocket Size Deburring Tool

- Deburrs nominal 1/4" or larger tubing and fittings
- Freely rotating, hardened steel blade holds its edge in copper and ABS/PVC plastic
- Under 6" overall length



Part #	Mfg #	Description	Price
006481	R308	Swivel Reamer, 1 oz	

Soldering & Brazing

Gratfix Deburring Tools

- Easily removes burrs inside and outside of copper and plastic
- Handle stores spare blades



Part #	Mfg #	Description	Price
078013	J40-221	Deburring Tool with Blade	
078014	J40-222	Replacement Blade Only	

Solder Supplies

PlumBest MAPP & Propane Cylinder



Part #	Mfg #	Description	Price
023120	J40-601	14.1 oz Propane Tank	

Solder Shield Protective Blanket

- For use when combustible material is present during soldering
- Smoke and odor free non-asbestos material
- Protects up to 2300°F for 5 minutes
- Durable woven ceramic holds up well in multiple uses

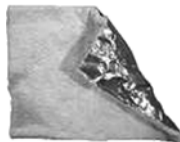

Part #	Mfg #	Description	Price
041970	J40-812	9" x 12" Solder Shield	

Soapstones and Holders

Round Soapstone & Holder

- Pen size
- Lightweight aluminum with built-in chuck



J40062

Part #	Mfg #	Description	Price
051484	J40-060	Round Soap Stone Holder	
051485	J40-062	Round Soap Stone	

Flat Soapstone & Holder

- Stainless steel spring tension with locknut



Part #	Mfg #	Description	Price
122546	J40-063	Flat Soap Stone	

Cleaners

Copper Cleaning Pads

- Reusable
- Use wet or dry - will not clog
- Nylon impregnated fine maroon
- Good general cleaner for removing rust, corrosion, etc
- Deoxidizes and cleans copper tube and fittings for soldering



Part #	Mfg #	Size	Price
009963	B29-400	4" x 6-1/4" x 1/4"	

Soldering & Brazing

Brushes Acid Brush

- Tin handle

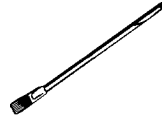

Part #	Mfg #	Size	Price
041964	B29-701	1/2" x 6"	

Paint and Dope Brush

- Natural bristles
- Ideal for use with pipe cleaners, thread cutting oil, paint and pipe dope

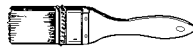

Part #	Mfg #	Size	Price
021058	B29-802	2"	

4-N-1 Copper Tube Fitting Brush

- Includes (4) long lasting high carbon steel brushes for 1/2" and 3/4" copper tube and fittings



Part #	Mfg #	Description	Price
041963	B10-004	Copper Tube & Fitting Brush	

Soldering & Brazing

Jet Swet™

- Jet Swet™s are made from the highest quality steel and aircraft aluminum
- Jet Swet™ gasket is a unique EPDM/silicone composite, made to withstand the intense heat of soldering and brazing
- Jet-Swet™s have a 1-year warranty from manufacturers defect on the entire tool except for the disposable, replaceable gaskets



Jet Swet™ Single Tool



R498400



R498405

Part #	Mfg #	Description	Price
051876	R498400	1/2" Jet Swet™	
051877	R498405	3/4" Jet Swet™	

Jet Swet™ Replacement Gasket



R498605



R498610

Part #	Mfg #	Description	Price
077644	R498605	3/4" Jet Swet™ Gasket	
091470	R498610	1" Jet Swet™ Gasket	

Torch Safes

Part #	Mfg #	Description	Price
123302	R445450	Torch Safe	

Piping Supplies & Accessories

Soldering & Brazing

Piping Supplies & Accessories

Freeze-Pak

Quick Freeze Pipe Freezing Spray

- Aerosol can
- For plumbing repairs without system draining or interruption of water supply

Part #	Mfg #	Description	Price
117411	64001	17.5 oz Quick Freeze Spray	

Instant Pipe Freezing Kit

- Make quick repairs without draining or interruption of water supply
- Produces a temporary ice plug in plumbing and heating systems that will last up to 30 minutes
- Kit includes:
 - (1) Can Quick Freeze spray
 - (2) Foam pipe jackets
 - (4) Plastic ties



Part #	Mfg #	Description	Price
117409	64004	Instant Pipe Freezing Kit	

Soldering & Brazing

Acetylene Torches

Extreme™ Air Acetylene Torch Kit

- Extreme™ swirl technology
- All tips feature quick disconnect couplings
- Color-coded o-rings for gas identification
- Rear valve position
- Includes:
 - Traditional manual lighting torch
 - Hose (AH-12)
 - Handle (G4)



Piping Supplies & Accessories

Part #	Mfg #	Soft Solders To:	Silver Brazes To:	Regulator	Tips	Tank Connection	Price
010464	0386-0335	3"	1-5/8"	AR-B	A-3, A-11	B	

Extreme™ Air Acetylene Standard Tip

- Quick disconnect couplings
- Color-coded o-rings for gas identification
- Can be used with any Acetylene torch handle (PLF-A5 or G-4)



Part #	Mfg #	Tip Size	Soft Solder To:	Silver Brazes To:	Price
026296	0386-0100	1/8"	1/8" - 1/2"	1/8" - 1/4"	
010435	0386-0101	3/16"	1/4" - 1"	1/8" - 1/2"	
010437	0386-0102	1/4"	3/4" - 1-1/2"	1/4" - 3/4"	
010439	0386-0103	5/16"	1" - 2"	1/2" - 1"	
010433	0386-0104	7/16"	1-1/2" - 3"	7/8"-1-5/8"	
010434	0386-0105	1/2"	2" - 3-1/2"	1" - 2"	
021269	0386-0106	3/4"	4" - 6"	1-1/2" - 4"	

Extreme™ Self-Lighting Air Acetylene Torch Kit

- Extreme™ swirl technology
- Quick disconnect handle and tip
- Replaceable tip
- Color-coded o-rings for gas identification
- Includes:
 - Gauge guards
 - Cylinder wrench
 - Hose (AH-12)
 - Instruction manual



Part #	Mfg #	Soft Solders To:	Silver Brazes To:	Regulator	Handle	Tip	Tank Connection	Valve Position	Price
010440	0386-0833	1-1/2"	3/4"	AR-B	G4	PL-5A	B	Rear	

Soldering & Brazing

Piping Supplies & Accessories

Extreme™ Self-Lighting Air Acetylene Replacement Tip

- Removable orifice screw
- Color-coded o-rings for gas identification



Part #	Mfg #	Tip Size	Soft Solders To:	Silver Brazes To:	Price
010450	0386-0818	1/4"	3/4"- 1-1/2"	1/4" - 3/4"	

Extreme™ Air Acetylene Pro-Line™ Replacement Tip End



5A-TE



8A-TE

Part #	Mfg #	Description	Price
028216	0386-1064	For PL-5A Tip	
033482	0386-1065	For PL-8A Tip	

Air Acetylene Components

Acetylene Regulator



Part #	Mfg #	Description	Price
010432	0386-0725	Acetylene Regulator Fits "B" Tank	
042545	0386-0726	Acetylene Regulator Fits "MC" Tank	

Acetylene Gauge



Part #	Mfg #	Description	Price
022532	0386-1200	Fuel Gauge for Acetylene Regulator	

Soldering & Brazing

Propane & MAP-Pro™
Standard Propane and MAP-Pro™ Tip



T-2



T-3



T-4

Part #	Mfg #	Tip Size	LP Soft Solder To:	MAPP Solder To:	Price
010459	0386-0150	5/16"	1/8" - 1/4"	1/8" - 1/2"	
010460	0386-0151	7/16"	1/4" - 1"	1/4" - 1-1/2"	
010461	0386-0152	1/2"	1/4" - 1-1/2"	1/4" - 2-1/2"	

ProLine™ Self-Lighting Propane and MAP-Pro™ Tip



Part #	Mfg #	Tip Size	LP Soft Solder To:	MAPP Solder To:	Price
010449	0386-0822	7/16"	1/4" - 1-1/2"	1/4" - 2-1/2"	

"Total LP" Hose

- 3/16" ID T Grade with 9/16" 18 Left-hand thread
- Fits H-4 handle, T-8 torch, R-LP adjustable LP regulator



Part #	Mfg #	Description	Price
010445	1412-0080	12' Propane Hose	

Piping Supplies & Accessories

Soldering & Brazing

Piping Supplies & Accessories

Extreme Self-Lighting Propane & MAP-Pro™ Hand Torch

- Extreme™ swirl technology
- High capacity applications
- Self-lighting triggers
- Quick disconnect couplings between handle and tips



TX-504

Part #	Mfg #	LP Soft Solder To:	MAPP Solder To:	Price
072954	0386-1297	1/8" - 2"	1/8" - 3"	
072952	0386-1293	3/4" - 3"	3/4" - 4"	

Extreme™ Self-Lighting Torch Replacement Tip

Part #	Mfg #	Description	Price
072955	0386-1298	Replacement Tip Assembly for TX503, Packaged	

Extreme™ STK Propane and MAP-Pro™ Torch

- Extreme™ swirl technology
- 360° Swivel tips and easy to clean orifice screws
- Includes:
 - Pressure regulator (STK-R)
 - Connection (CGA-600)
 - Instruction manual



ST-3



ST-33

Part #	Mfg #	Tip	LP Soft Solder To:	MAPP Solder To:	Price
010454	0386-0403	ST-3	1/4" - 3"	1/4" - 3-1/2"	
022969	0386-0851	ST-33	1/4" - 3"	1/4" - 3-1/2"	

Extreme™ STK Self-Lighting Hand Torch Tip Assembly Only

- Fits existing STK-9 and STK-99 torches



Part #	Mfg #	LP Soft Solder To:	MAPP Soft Solder To:	Price
022968	0386-0850	1/4" - 3"	1/4" - 3-1/2"	

Soldering & Brazing

Nitrogen Purge Kits

NPK-TT Nitrogen Purge and Blow Gun Kit

- Includes:
 - Nitrogen regulator
 - Turbo Tornado™
 - (2) Cone plugs (1/2" and 3/4")
 - Needle tip
 - CO2 Adapter
 - Standard charge hose (36" x 1/4")
 - Standard charge hose (72" x 1/4")
 - Blow gun



Part #	Mfg #	Description	Price
126453	0386-1370	Nitrogen Purge & Blow Gun Kit	

Turbototes® Carriers

Turbototes® Tank and Cylinder Carrier

- Heavy-duty steel construction



Part #	Mfg #	Description	Price
020400	1421-0034	For "B" Tanks	

TurboTorch® Parts & Accessories

Flints & Flint Striker

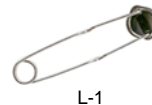

L-1



F-1

Part #	Mfg #	Description	Price
010447	1423-0023	Cup Type Single Flint Striker, Round File	
010441	1423-0024	Box of (5) Flints for L-1 Striker	

Hose



Part #	Mfg #	Description	Price
010431	0386-1090	12' Acetylene Hose with "A" Fittings	

TurboTorch Part



Part #	Mfg #	Description	Price
010455	0386-1226	Tank Key for "B" & "MC" Tank Valves	

Piping Supplies & Accessories



Spacer Caps

Plumbing Construction Materials

Big Red Closet Bend Spacer

- Keeps poured concrete away from waste lines and closet bends
- Fits 3" and 4" waste lines



Part #	Mfg #	Description	Price
002541	012005	Plastic 6" OD x 4"H	

Piping Supplies & Accessories



Spacer Caps

Closet Flange Spacers

Part #	Mfg #	Description	Price
005486	R383300	3" Kollar Kap	
008871	R383400	4" Kollar Kap	

Piping Supplies & Accessories

Stainless Steel Clamps

Ideal Clamps

Series 68 - Hy-Gear

- 9/16" Wide band
- One-piece housing
- 5/16" Hex-head screw
- Stainless steel band, housing and screw
- Double-locking security and high band tension for high sealing pressures



Part #	Mfg #	Min Dia	Max Dia	Price
115004	6808	7/16"	1"	
115005	6810	1/2"	1-1/16"	
115006	6812	1/2"	1-1/4"	
115007	6816	11/16"	1-1/2"	
115008	6820	3/4"	1-3/4"	
115009	6824	1"	2"	

Stainless Steel Clamps

Series M62

- 5/16" Wide band
- 300 Series stainless steel band and housing
- 400 Series 1/4" hex head stainless steel screw



Part #	Mfg #	Min Dia	Max Dia	Price
013611	M62602	1/4"	5/8"	
015539	M62606	7/16"	7/8"	

Series M677

- 1/2" Wide band
- 300 Series stainless steel band and housing
- 300 Series 5/16" hex head stainless steel screw
- Marine grade quality clamp
- UPC Approved



Part #	Mfg #	Min Dia	Max Dia	Price
015171	M67067	3/8"	7/8"	
013233	M67107	9/16"	1-1/8"	
014794	M67167	3/4"	1-1/2"	
014843	M67207	3/4"	1-3/4"	
013078	M67247	1"	2"	
013725	M67327	1-5/8"	2-1/2"	
013022	M67407	2"	3"	
068921	M67487	2-1/2"	3-1/2"	
014206	M67567	3"	4"	
014512	M67727	2"	5"	
051627	M67967	3-1/2"	6-1/2"	

Steel Hangers

Caddy® Beam Clamps

Reversible Beam Clamp

- Reversible for attachment to top or bottom flange
- Locknut and hardened cup point set screw to provide secure grip on tapered sections
- Malleable iron clamp with electrogalvanized finish for good corrosion protection
- #310 Series large mouth opening (1-1/4" [32 mm]) to fit large thick flange steel beams or angles and large lip purlins



Part #	Mfg #	Description	Price
013031	300D0050PL	1/2" Wedge Beam Clamp	
079264	310D0037PL	3/8" Wide Mouth Beam Clamp	

Caddy® Hangers & Hanging Systems

Caddy® Big Beam Clamp

- Zinc electrogalvanized



Part #	Mfg #	Size	Price
122882	BC400	3/4"	

Caddy® Speed Link SD with Hook

- All steel construction
- Small, lightweight design
- Includes:
 - Wire
 - Locking device
 - Pre-assembled hook end fitting
- Static load:
 - SLD2: 100 lbs
 - SLD3: 200 lbs



Part #	Mfg #	Rope Dimensions	Price
076797	SLD2L1	0.079" Dia x 3.3'	
076799	SLD2L3	0.079" Dia x 9.9'	
076800	SLD2L5	0.079" Dia x 16.4'	
076803	SLD3L2	0.118" Dia x 6.6'	
076804	SLD3L3	0.118" Dia x 9.9'	
076805	SLD3L5	0.118" Dia x 16.4'	
076806	SLD3L10	0.118" Dia x 32.8'	

Riser Clamps

Caddy® EZ Riser for Vertical Pipe Support

- Electro-galvanized



Part #	Mfg #	Nom Size	Price
063714	5100125EG	1-1/4"	

Ceiling/Wall Plates

Ceiling or Wall Plate 365M

- EG: Electro-zinc plated finish
- CP: Copper-colored coating for identification purposes only



Part #	Mfg #	Size	Finish	Price
121939	365M0050EG	1/2"	EG	
087799	365M0050CP	1/2"	CP	

Caddy® Swivel Loop Hangers

Caddy® Adjustable Band Loop Hanger for Copper Tubing

- Meets MSS requirements
- Copper-colored coating for identification purposes only



Part #	Mfg #	Pipe Size	Height	Price
032347	1010050CP	1/2"	3-3/16"	
068565	1010075CP	3/4"	3-1/8"	

Caddy® Split Ring Hangers

Caddy® Split Ring Stand-Off Hanger - Malleable Iron

- PL: Plain without coating
- EG: Electro-galvanized



Part #	Mfg #	Size	Finish	Price
013918	4550200PL	2"	PL	
145257	4550250EG	2-1/2"	EG	
082051	4550300EG	3"	EG	
050638	4550300PL	3"	PL	
125189	4550400EG	4"	EG	
064486	4550400PL	4"	PL	

Piping Supplies & Accessories

Steel Hangers

Caddy® Split Ring Stand-Off Hanger - Malleable Iron for Copper Tubing



Part #	Mfg #	Size	Price
072403	4560250CP	2-1/2"	
040951	4560300CP	3"	

Nuts, Washers & Hardware

#51 Hardware Threaded Stud

- Plain finish
- Attaches hangers to structural attachments without threading or cutting the rod

Part #	Mfg #	Rod Size	Length	Max Load	Price
077828	0513702PL	3/8"	2"	610 lbs	

Piping Supplies & Accessories

Steel Hangers

Caddy® Beam Clamps

Caddy® Reversible Beam Clamp

- Malleable iron clamp with electro-galvanized finish for enhanced corrosion protection
- Hardened cup point setscrew to provide secure grip on tapered sections
- Structural attachment to top or bottom of metal beams, purlins, channel, or angle iron
- Plain black finish



Part #	Mfg #	Rod Size	Flange Size	Finish	Price
015560	300D0062PL	5/8"	3/4"	PL	
014609	300D0075PL	3/4"	3/4"	PL	

Piping Supplies & Accessories

Steel Hangers

Pipe Rings

Galvanized Adjustable Swivel Hanger

- Plated carbon steel
- For suspension of non-insulated stationary pipe line
- Maximum temperature: 650°F



Part #	Size	Price
013209	1/2"	
014775	3/4"	
012292	1"	
012875	1-1/4"	
012552	1-1/2"	
013941	2"	
014117	2-1/2"	
014452	3"	
015340	4"	
015691	6"	

Galvanized Pipe Clamps

Galvanized Riser Clamp

- Galvanized carbon steel
- For support and steadying of steel pipe risers either insulated or bare, cast iron or conduit; not intended for use with hanger rods
- Maximum temperature: 650°F

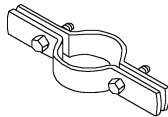

Part #	Size	Price
014771	3/4"	
012289	1"	
012549	1-1/2"	
013922	2"	
014433	3"	
015317	4"	
015520	5"	
015679	6"	
015823	8"	
012315	10"	
040554	12"	

Split Ring Hangers

Copper Coated Split Ring Hanger

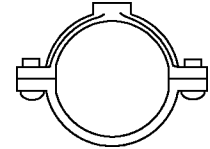

Part #	Size	Price
013110	1/2"	
014683	3/4"	
012220	1"	
012811	1-1/4"	
012442	1-1/2"	
013812	2"	

Galvanized Split Ring Hanger

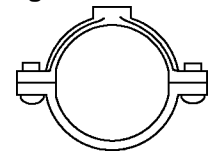

Part #	Size	Price
019413	1/2"	
014713	3/4"	
012245	1"	
012836	1-1/4"	
012467	1-1/2"	
013832	2"	

Black Split Ring Hanger

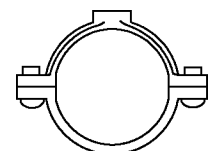

Part #	Size	Price
015056	3/8"	
013197	1/2"	
014767	3/4"	
012288	1"	
012872	1-1/4"	
012547	1-1/2"	

Steel Hangers

Clevis Hangers

Black Adjustable Clevis Hanger

- Black carbon steel
- For suspension of stationary pipe lines
- Maximum temperature: 650°F

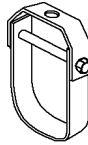

Part #	Size	Price
021826	1/2"	
021827	3/4"	
021828	1"	
021829	1-1/4"	
021830	1-1/2"	
021831	2"	
021832	2-1/2"	
021833	3"	
021834	4"	
015509	5"	
015622	6"	
015786	8"	
012297	10"	
013084	12"	
070755	14"	
070754	16"	
078319	18"	

Beam Clamps

Standard Throat Universal C-Clamp

- Ductile iron clamp, hardened steel cup point set screw and locknut
- For use under roof installations with bar joist type construction, or for attachment to top or bottom flange of structural shapes where vertical hanger rod is required to be offset from edge of flange and where thickness of joist or flange does not exceed 3/4"

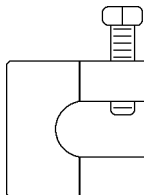

Part #	Size	Price
014970	3/8"	

Wide Throat C-Clamp

- 3/8" Ductile iron, 1/2" malleable iron clamp, hardened steel cup point set screw and locknut
- For use under roof installations with bar joist type construction, or for attachment to top or bottom flange of structural shapes where vertical hanger rod is required to be offset from edge of flange and where thickness of joist or flange does not exceed 1-1/4"

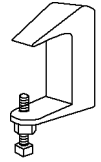

Part #	Size	Price
049604	3/8"	

Wide Throat Top Beam C-Clamp

- 5/8" Malleable iron, 3/4" ductile iron clamp, hardened steel cup point set screw and locknut
- For use under roof installations with bar joist type construction, or for attachment to top flange of structural shapes where vertical hanger rod is required to be offset from the edge of flange and where thickness of joist or flange does not exceed 1-5/16"

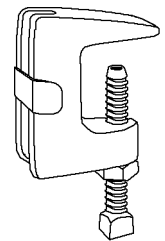

Part #	Size	Price
114005	3/4"	

Ceiling Flanges

Black Ceiling Flange

- Black malleable iron
- For attachment to wood beams or ceiling

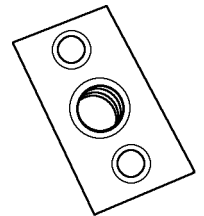

Part #	Size	Price
014967	3/8" NPT	
039428	1/2" NPT	

Galvanized Ceiling Flange

- Galvanized malleable iron
- For attachment to wood beams or ceiling

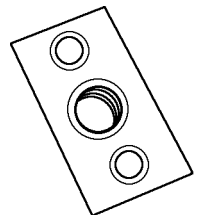

Part #	Size	Price
015063	3/8" Rod	

Steel Hangers

Copper Tubing Hangers Countersunk Riser Clamp

- Carbon steel with copper finish
- For support and steadying of copper tubing risers

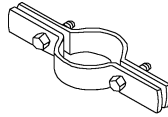

Part #	Size	Price
013111	1/2"	
014684	3/4"	
012221	1"	
012812	1-1/4"	
012443	1-1/2"	
013813	2"	
014085	2-1/2"	
056082	3"	
027166	4"	

CTS Adjustable Swivel Hanger

- Steel with copper finish



Part #	Size	Price
083891	1/2" - 1"	
082241	1/2" - 1-1/4"	
012222	1"	
012816	1-1/4"	
012446	1-1/2"	
013814	2"	
014086	2-1/2"	
014348	3"	
015224	4"	

Copper Adjustable Light-Duty Clevis Hanger

- Carbon steel with copper finish

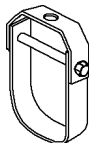

Part #	Size	Price
013061	1/2"	
014640	3/4"	
012199	1"	
012779	1-1/4"	
012399	1-1/2"	
013769	2"	
014068	2-1/2"	
014318	3"	

Copper Tubing Hangers (Continued) Copper Adjustable Light-Duty Clevis Hanger

Part #	Size	Price
015203	4"	

Copper Ceiling Flange

- Malleable iron with copper finish

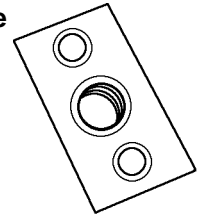

Part #	Size	Price
014991	3/8" Rod	

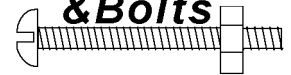
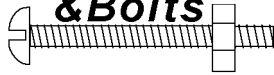

Steel Hangers

Spacers & Standoffs

Round Standoff

Part #	Size	Price
078486	3/8" x 3"	

Steel Hangers

Wire Pipe Hooks

Wire Pipe Hook

- 10-gauge
- Vinyl-coated steel
- Do not use vinyl-coated wire pipe hooks with CPVC pipe or fittings



506-24C

Plain Steel

Part #	Mfg #	Size	Price
009993	506-26	1/2" IPS x 6"	
009995	506-34	3/4" IPS x 4"	
009997	506-36	3/4" IPS x 6"	
009999	506-46	1" IPS x 6"	

Copper-Plated Steel

Part #	Mfg #	Size	Price
183440	506-22C	1/2" IPS x 2-1/2"	
009992	506-24C	1/2" IPS x 4"	
009994	506-26C	1/2" IPS x 6"	
183441	506-32C	3/4" IPS x 2-1/2"	
009996	506-34C	3/4" IPS x 4"	
009998	506-36C	3/4" IPS x 6"	

Copper-Plated Steel Drive Hook

- Do not use vinyl-coated hooks with CPVC pipe or fittings



503-2

J-Hook

Part #	Mfg #	Size	Price
183438	503-2	1/2" CTS	
030805	503-3	3/4" CTS	

Tube Nailer

Part #	Mfg #	Size	Price
159628	504-3	1/2"-3/4" CTS	

Steel Hangers

Clamps
Sheetrock Toggle



Part #	Prod	Description	Price
024918	SST30	1/4" x 3" for 1/4" Rod	

Struts

Piping Supplies & Accessories

Caddy® Strut Systems

Caddy® Strut Post Base

- For "A" channel
- Electro-zinc plated

Part #	Mfg #	Size	Price
130266	P090000EG	6" x 3-1/2" x 3-1/2"	

Caddy® Square Post Base

- For channel
- Electro-zinc plated

Part #	Mfg #	Description	Price
076402	P11SQ000EG	Square Post Base	

Caddy® Beam Clamps

Strut Beam Clamp

- Channel to beam clamp
- Electro-zinc plated finish
- Fits 'A' and 'D' channels



Part #	Mfg #	Size	Price
106899	BC17A000EG	3-3/8" x 3"	

Caddy® Channel

Caddy® Eristrut Channel A14

- 1-5/8" x 1-5/8"
- 14 Gauge
- For light and medium applications
- Half slot configuration
- GN: Painted green finish



Part #	Mfg #	Length	Finish	Hole Slot	Price
121545	C14H1000GN	10'	GN	Half Slot	

Caddy® Eristrut Channel C12

- 1-5/8" x 3/16"
- 12 Gauge
- For individual fastening or for efficiently constructing pipe or tube routes
- GN: Painted green finish

Part #	Mfg #	Length	Finish	Hole/Slot	Price
013405	C12H2000GN	20'	GN	Half Slot	

Caddy® Eristrut Channel E12

- 1-5/8" x 3-1/4"
- 12 Gauge
- For heavy applications
- For individual fastening or for efficiently constructing pipe or tube routes
- GN: Painted green finish

Part #	Mfg #	Length	Finish	Hole/Slot	Price
121385	E12H2000GN	20'	GN	Half Slot	

Two-Hole Corner Angle Washer

- EG: Electro-zinc plated finish

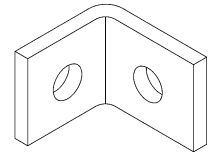

Part #	Mfg #	Size	Finish	Price
116112	L100000EG	2-1/4" x 1-5/8"	EG	

Four-Hole Strut Corner Angle

- Width: 1-5/8"
- Hole size: 9/16"
- Spacing:
 - 13/16" From edge
 - 1-7/8" On center
- EG: Electro-zinc plated finish

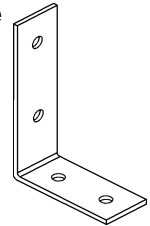

Part #	Mfg #	Size	Finish	Price
035437	L220000EG	4-1/8" x 3-1/2"	EG	

Strut Angle - Two-Hole Open Angle

- Electro-zinc plated



Part #	Mfg #	Description	Price
116113	L460450EG	45° Angle	

Strut Angle - Two-Hole Closed Angle

- Electro-zinc plated

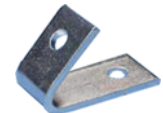

Part #	Mfg #	Description	Price
116114	L470450EG	45° Angle	

Struts

Four-Hole Splice Plate

- *Electro-zinc plated*

Part #	Mfg #	Size	Price
116110	F230000EG	7-1/4" x 1-5/8"	

Strut Four-Hole Half-Tee Plate

- *Electro-zinc plated*

Part #	Mfg #	Size	Price
116111	F370000EG	3-1/2" x 5-3/8"	

Struts

Piping Supplies & Accessories

CADDY® Eristrut Channels

A12 Slotted Steel Channel

- PG = Pre-galvanized
- GN = Painted green



Part #	Size	Finish	Gauge	Price
040173	1-5/8" x 1-5/8" x 20'	PG	12ga	
012312	1-5/8" x 1-5/8" x 10'	GN	12ga	
044274	1-5/8" x 1-5/8" x 10'	PG	12ga	
013953	1-5/8" x 1-5/8" x 20'	GN	12ga	

A14 Slotted Steel Channel

- PG = Pre-galvanized



Part #	Size	Finish	Gauge	Price
044275	1-5/8" x 13/16" x 20'	PG	14ga	

C14 Slotted Steel Channel

- PG = Pre-galvanized



Part #	Size	Finish	Gauge	Price
133688	1-5/8" x 13/16" x 10'	PG	14ga	

Brackets

Strut Splice Plate

Part #	Description	Price
065325	2-Hole, Green	

Strut Hangers

Universal Pipe Strut Clamps

TouchDown II™ Strut Clamp

- Large universal pipe clamp for strut
- No tools required for fast and easy installation
- One clamp fits 1/2" CTS tube (copper, PEX or CPVC) – 2" IPS (steel or plastic)
- Use two bridges for tandem pipe runs
- Great for retro-fit applications



550-2T

Part #	Mfg #	Bridge	Stut Clamp Base	Price
094745	550-2T	1	1	
232205	550-2121	1	1	
176282	550-22T	50	50	

TouchDown II™ Large Universal Pipe Clamp with PipeDown™ Noise Asorbing Inserts

- Clamps 1/2" – 2" CTS tube (copper, PEX or CPVC) and 3/8" – 2" Sch. 40 pipe (steel or plastic)
- Releasable locking mechanism allows for variable clamping tension for expansion and contraction
- Provides 5/8" stand-off from mounting surface
- PlenumSafe™ model meets ASTM E84 25/50 Flame/Smoke Spread and UL-94 V0 flame ratings
- Acoustical options available
- *Acoustical options are not plenum-rated

Standard

Part #	Mfg #	Bridges	Bases	Screws	Price
177775	550-22	50	50	100	

Piping Supplies & Accessories



Strut Hangers

Clamping Nuts

Part #	Description	Price
015057	3/8" w/Regular Spring	
020035	3/8" Top Grip™ Nut w/Spring on Top	
020036	1/2" Top Grip™ Nut w/Spring on Top	

Piping Supplies & Accessories

Strut Hangers

Caddy® Strut Nuts

Caddy® SLICK Threaded Strut Nut

- Eliminates the need for a washer
- Replaces spring nuts



Part #	Mfg #	Thread Size	Recommended Torque	Price
055268	SLICK375	3/8"-16	15 ft-lbs	
055269	SLICK500	1/2"-13	20 ft-lbs	

Caddy® Strut Clamps

Caddy® Cushion Clamp - Tube Series

- Fits any standard 1-5/8" wide strut channel
- Ideal for multiple pipe runs while absorbing shock and vibration, reducing unwanted noise and preventing galvan corrosion
- Interlock design helps to ensure that the cushion remains in place



Part #	Mfg #	Copper & Steel	Copper Water	Price
033422	TCC0162CP	1-5/8"	1-1/2"	

Eritech® Welded Electrical Connections Products



Eritech® Grounding Clamp

- For connecting copper conductors to metallic water pipe (including copper tubing) or ground rods
- Bond corrugated stainless steel tubing (CSST) or flexible gas pipe systems to the electrical system in accordance with the National Fuel Gas Code (NFGC) and the National Electrical Code® (NEC)
- Applications include lightning protection, fault current ground, signal reference grid and static ground
- Fits hex fittings, copper grounding conductors, galvanized water pipes, copper water tubing or copper ground rods ranging from 1/2" to 4"
- High-strength silicone bronze clamps connect brass hex fittings
- UL Listed (ANSI/UL 467 - Category KDER)



Part #	Mfg #	For Pipe Size	For Hex Nut Size	Price
105482	CWP1J	1/2" - 1"	1" - 1-1/4"	

Caddy® Strut Channel

Strut Channel Nut less Spring

- EG: Electro-zinc plated finish
- Fits A, B, D, and E channels



Part #	Mfg #	Thread Size	Price
021030	NUT0050EG	1/2"	
123849	NUT0075EG	3/4"	

Strut Channel Washer

- EG: Electro-zinc plated finish

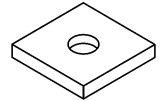

Part #	Mfg #	Hole Size	Bolt Size	Finish	Price
020781	F140000EG	3/8"	7/16"	EG	
013203	F150000EG	1/2"	9/16"	EG	

Strut Hangers

Pipe Clamps

Standard Steel Pipe Clamp (GRC & IMC)

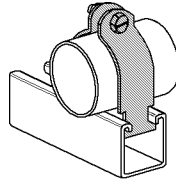

Part #	Size	Price
013202	1/2"	
014773	3/4"	
012291	1"	
012874	1-1/4"	
012551	1-1/2"	
013923	2"	
014116	2-1/2"	
014434	3"	
015318	4"	
015680	6"	

Strut Clamps

Copper-Plated Strut Clamp (CTS Size)

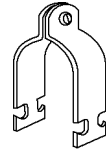

Part #	Size	Price
015058	3/8" OD	
015584	5/8" OD	
015778	7/8" OD	
013020	1-1/8" OD	
013451	1-3/8" OD	
013632	1-5/8" OD	
014205	2-1/8" OD	
014279	2-5/8" OD	
038475	3-1/8" OD	
015378	4-1/8" OD	

Cushion Clamp

- Electro-galvanized standard finish
- Pre-assembled

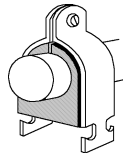

Part #	OD Size	Price
052645	3/8"	
058284	1/2"	
033418	5/8"	
033413	3/4"	
033419	7/8"	
033420	1-1/8"	
033421	1-3/8"	
033423	2-1/8"	
046559	2-5/8"	
059578	3-1/8"	

Conduit Clamps

Plated Conduit Clamp

Part #	Size	Price
020360	1/2"	
020361	3/4"	
020362	1"	
020363	1-1/4"	
020364	1-1/2"	
020365	2"	

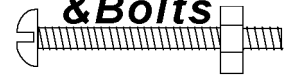
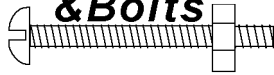

Threaded Rods, Bolts, Nuts, & Gaskets

Nuts

Zinc-Plated Hex Nut



Part #	Size	Price
028485	3/8"	
028486	1/2"	
078474	3/4"	
072043	5/8"	
072046	7/8"	

Bolts

Hex Head Bolt

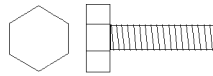

Part #	Size	Price
114092	3/4"-10 x 3"	

Zinc-Plated Hex Head Bolt

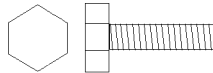

Part #	Size	Price
122398	3/8" x 3/4"	
040538	3/8" x 1"	
122400	3/8" x 1-1/4"	
122401	3/8" x 1-1/2"	

Screws

Hex Cap Screw

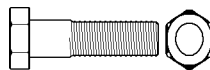

Part #	Size	Price
095900	3/8" x 1"	
095901	3/8" x 1-1/4"	
095902	3/8" x 1-1/2"	

Washers

Steel Cut Flat Washer



Part #	Size	Price
015587	5/8"	

Zinc-Plated Steel Cut Flat Washer

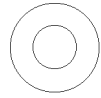

Part #	Size	Price
028487	3/8"	
028488	1/2"	
072045	5/8"	
078482	3/4"	
026021	7/8"	

Zinc-Plated Steel Lock Washer



Part #	Size	Price
122402	3/8"	

Zinc-Plated Fender Washer

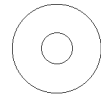

Part #	Size	Price
095276	1/4" x 1-1/4"	
035135	3/8" x 1-1/2"	
066354	1/2" x 2"	



Threaded Rods, Bolts, Nuts, & Gaskets

Hanger Rods

Electro-Galvanized All Thread Rod

- EG Carbon steel 
- Continuous right-hand threads
- Maximum temperature: 750°F

Part #	Size	Price
013533	1/4" x 10'	
015054	3/8" x 10'	
013166	1/2" x 10'	
015582	5/8" x 10'	
014736	3/4" x 10'	

Piping Supplies & Accessories

Threaded Rods, Bolts, Nuts, & Gaskets

Fasteners and Inserts
Standard Steel Rod Coupling

- EG: Electro-zinc plated finish

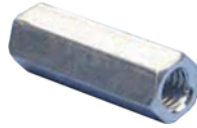

Part #	Mfg #	Size	Finish	Price
016078	0250037EG	3/8"	EG	
064708	0250050EG	1/2"	EG	
075031	0250062EG	5/8"	EG	
075032	0250075EG	3/4"	EG	

Threaded Rod

- EG: Electro-Galvanized finish
- Tensile strength: 58,000 psi
- Yield Strength: 36,000 psi
- Rod size: 3/8" x 12" Length
- Static load: 600 lb



Part #	Mfg #	Size	Price
190986	0503712EG	3/8"	

Ground Clamps
Ground Rod Clamp



Part #	Mfg #	Description	Price
105024	CP38	Std 10 Sol/4 Str, 3/8" Dia	

Piping Supplies & Accessories

Threaded Rods, Bolts, Nuts, & Gaskets

Piping Supplies & Accessories

Vertical Mounting Rod Fasteners

- For hanging pipe, conduit, fluorescent fixtures, unit heaters and more

Sammys® for Concrete - Vertical Application

- Self-tapping
- 1/4" Pre-drilled hole required



Part #	Prod	Size	Rod	Price
035774	CST 20	1-1/2"	3/8"-16	

Sammys® for Steel - Vertical Application

- Made with Tekes® self-drilling fasteners
- No pre-drilling required
- Install with Sammys Nut Driver and an 18V cordless drill/driver
- A standard screw gun with a depth sensitive nosepiece should be used to install TEKS
- "R" Suffix denotes retaining nut



Part #	Prod	Size	Rod	Price
020584	DSTR 1	1/4-20 x 1"	3/8"-16	
020587	DST 10	1/4-14 x 1"	3/8"-16	
108139	DST 100	1/4-14 x 1"	1/4"	
020589	DST 20	1/4-14 x 2"	3/8"-16	
020592	TEK 50	12-24 x 1-1/2"	3/8"-16	

Sammy® X-Press® - Vertical Application

- Installs into metal deck, purlin or tubular steel
- Expands to provide direct vertical attachment
- Use in applications where access to back of installed fastener is prohibited
- Installs in seconds with Sammy X-Press It® tool
- No retaining nut required



Part #	Prod	Rod	Pullout	Price
091332	XP 35	3/8"-16	1783 lbs (16ga)	

Sammys® for Wood - Vertical Application

- No pre-drilling required
- Install with Sammys Nut Driver and an 18V cordless drill/driver



Part #	Prod	Size	Rod	Price
021728	GST 10	1/4 x 1"	3/8"-16	
020590	GST 20	1/4 x 2"	3/8"-16	
020591	GST 30	1/4 x 3"	3/8"-16	

Horizontal Mounting Rod Fasteners

Sidewinder® for Steel - Horizontal Application

- Made with Tekes® self-drilling fasteners
- No pre-drilling required
- Install with Sammys Nut Driver and an 18V cordless drill/driver
- A standard screw gun with a depth sensitive nosepiece should be used to install TEKS
- "R" Suffix denotes retaining nut



Part #	Prod	Size	Rod	Price
020594	SWD 20	1/4-14 x 1"	3/8"	
048590	SWDR516	5/16-18 x 1-1/4"	3/8"-16	

Sidewinder® for Wood - Horizontal Application

- No pre-drilling required
- Install with Sammys Nut Driver and an 18V cordless drill/driver



Part #	Prod	Size	Rod	Price
020593	SWG 20	1/4 x 2"	3/8"-16	

Installation Tools

Nut Driver



Part #	Prod	Rod Size	Color	Price
020596	14	1/4" & 3/8"	Black	

Threaded Rods, Bolts, Nuts, & Gaskets

Screws

Wood Screw - Phillips Head

- Zinc-plated



Part #	Mfg #	Size	Pkg Qty	Price
116661	F33-034	#12 x 2"	100	



Threaded Rods, Bolts, Nuts, & Gaskets

Piping Supplies & Accessories

Riex Gaskets

1/8" Full Face Red Rubber Gasket - 150#

Part #	Mfg #	Size	Price
113499	101F2-020	2"	
113497	101F2-025	2-1/2"	
113498	101F2-030	3"	
080314	101F2-040	4"	
080315	101F2-060	6"	
080316	101F2-080	8"	
128777	101F2-120	12"	

1/16 Ring Flange Gasket

Part #	Mfg #	Size	Price
013916	108R6-020	2"	
014114	108R6-025	2-1/2"	
014428	108R6-030	3"	
015300	108R6-040	4"	
015519	108R6-050	5"	
015665	108R6-060	6"	
015808	108R6-080	8"	

1/8 Ring Flange Gasket - 150#

Part #	Mfg #	Size	Price
034783	101R6-020	2"	
034784	101R6-025	2-1/2"	
034785	101R6-030	3"	
034786	101R6-040	4"	
034787	101R6-050	5"	
034788	101R6-060	6"	
034789	101R6-080	8"	

BP Pizza Box Flange Gasket - 150#

Part #	Mfg #	Size	Description	Price
029426	208R-015	1-1/2"		
002566	208R-020	2"		
002567	208R-025	2-1/2"		
029027	206F-025	2-1/2"	Full Faced	
002568	208R-030	3"		
028766	206F-030	3"	Full Faced	
002569	208R-040	4"		
029026	206F-040	4"	Full Faced	
002570	208R-050	5"		
002571	208R-060	6"		
002572	208R-080	8"		
002565	208R-100	10"		

#1 Full Face Gasket

Part #	Mfg #	Size	Price
030598	212Gasket	2-1/2"	
030599	3Gasket	3"	

LBV Zinc Butterfly Gasket - 150#

Part #	Mfg #	Size	Price
053676	LBVAZ202.00	2"	
053677	LBVAZ203.00	3"	
053678	LBVAZ204.00	4"	
067638	LBVAZ206.00	6"	



Threaded Rods, Bolts, Nuts, & Gaskets

Red Rubber Sheet Packing

36" Wide Roll



Part #	Mfg #	Description	Price
006182	1003	1/8" Thick, 100 lb Roll	

Piping Supplies & Accessories

Tubing Brackets

Piping Supplies & Accessories

Copper Tubing Hangers & Fasteners

Vinyl-Coated Steel Clamp with 1" Screw

- Perfect for hydronic heating
- Use with power bar universal slider bracket
- Complies with 2009 National Fuel Gas Code for supporting CSST
- Do not use with CPVC pipe or fittings
- Model (523-31) also for 3/8" nom. tube # 3 rebar



523-32

Part #	Mfg #	Size	For:	Price
164878	523-31	5/16"	3/8" Threaded Rod	
142241	523-32	5/8"	1/2" CTS	
164879	523-33	7/8"	3/4" CTS	
164880	523-34	1-1/8"	1" CTS	

Tube Brackets & Hangers

ChaseBracket™ Copper-Plated Support Bracket

- Heavy duty 16 gauge
- Spot solder to copper water header —heat the pipe, not the bracket
- Cradles copper water headers up to 3" diameter
- Available with or without 5" stainless steel band
- Wide cradle gives maximum soldering surface
- Made in the USA



521-723

Part #	Mfg #	Includes:
112589	521-723	5" Stainless Steel Band
183443	521-723BB	Chase Bracket

Copper-Plated Stub-Out Bracket

- A-Frame design
- Self-nailing, 16 gauge
- Heat the tube, not the bracket
- Positions 1/2" CTS at 2", 3" or 5-3/4" from floor
- Positions 3/4" CTS at 3-1/2" from floor



Part #	Mfg #	1/2" CTS	3/4" CTS	Price
052124	521-6415	3"	1"	

Edge Support System™ Bracket with Angle Design



- Provides a rigid cross brace between studs
- One clamp supports vertical and horizontal applications
- Perforated angle designed for undersized stud bays

Part #	Mfg #	Material	Includes:	Price
029292	520-E16C	Copper-Plated	Flat Tabs	

Secure-All™ Copper-Plated Flat Bracket

- Reduce inventory with one bracket that features multiple hole sizes and notches
- Stiffening ribs on top and bottom provide ultimate rigidity
- Heavy 18 gauge copper-plated steel
- All holes and notches are extruded for maximum soldering surface
- Bracketing area on 521-851 is 14" and on 521-852 is 22"
- Heat the tube, not the bracket



521-851

Part #	Mfg #	Description	Price
151154	521-851	2" x 20" (H): 1/2"=7 3/4"=3 1"=3, (N):1/2"=7 3/4"=6	

Secure-All™ Copper-Plated Bracket

- Heavy gauge copper-plated steel
- Holes: (11) 1/2" CTS, (5) 3/4" CTS, (5) 1" CTS; Notches: (11) 1/2" CTS, (10) 3/4" CTS



Part #	Mfg #	Size	Gauge	Price
081848	521-852	2-3/8" x 26"	18	

Copper-Plated Stub-Out Bracket

- Extruded models provide four times the soldering surface for extra strength
- Heat the tube, not the bracket

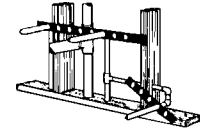

521-810

Flat Holes

Part #	Mfg #	Description	Price
005361	521-188	1-1/4" x 22" (8) Holes 1/2" CTS	
005362	521-126	1-1/4" x 26" (11) Holes 1/2" CTS	
005363	521-126	1-3/4" x 20", (7) Holes 1/2" CTS, (4) Holes 3/4" CTS, (4) Holes 1" CTS	

Extruded Holes

Part #	Mfg #	Description	Price
033296	521-820	1-3/4" x 20" (7) Holes 1/2" CTS, (4) Holes 3/4" CTS, (3) Holes 1" CTS	
005360	521-118R	1-1/4" x 20" (7) Holes 1/2" CTS	

Tubing Brackets

Copper-Plated Carrier Bracket with Washers

- Channel design and extruded 1" CTS hole offer maximum strength and rigidity
- Supports water pipe for flush valve 26-1/2" above floor and offsets flush valve from carrier center



521-727

Part #	Mfg #	Holes	Price
052267	521-725	Standard	
127314	521-727	Double	

Copper-Plated Commercial Alignment Bracket

- Aligns vertical or horizontal pipes in straight runs, especially between floors
- Attaches to vent or waste pipe
- 18-gauge copper-plated steel
- Includes snap-lock stainless steel band and self-adhesive felt



Part #	Mfg #	Stub Outs	Centers	Price
123468	521-110	1/2"	4" or 8"	

L-Bracket

- Can be used for:
 - Hangs Tuff™ DWV pipe hanger
 - ZipStick™ universal pipe hanger
 - ZipStrap™ ratchet-locking strap



Part #	Mfg #	For:	Price
180438	521-210	3/8" All Thread Rod	

Pipe Eye™ Overhead Suspension Bracket

- Commercial product
- Supports copper, PEX or CPVC tubing
- Includes one, two or four 1 11/32" holes
- Use with Pipe Eye™ insulators
- Suspend bracket with 3/8" all-thread rod
- Multiple nail holes and slots for installation flexibility
- Can be mounted to a concrete pan before the pour



521-558

Part #	Mfg #	Holes	Price
155230	521-558	Double	

WiderSlider™ Adjustable Stub-Out Bracket

- Available in two lengths for 16" or 24" stud bays
- 1-3/8" wide x 22-ga. high quality G90 galvanized steel
- Pilot holes for standard DE 90s and wide enough for securing 3-ear DE 90s
- Eliminates cutting and fabricating metal studs or wood blocks
- Pre-dimensioned hash marks for quicker, more precise installations
- Pre-assembled and fully adjustable with interlocking tab to secure safe overlap and prevent disassembly
- Mount to face of studs or bend tabs to recess at 3/4", 1-1/2" or 2-1/2" depths within stud cavity



520-626

Part #	Mfg #	Adjusting Size	Price
187711	520-626	17-26"	

Full-Slip Male Adapter

- Eliminates tedious measuring
- 3/4" and 1" sizes are ideal for closet or urinal stub out adapters
- Replaces male adapters when hex is not necessary

Part #	Mfg #	Brass F Swt x MIP Thread	Price
183529	614-3	3/4" x 1/2"	
183532	614-4	1" x 1"	

PowerBar™ Universal Brackets

PowerBar® Universal Slider Bracket TouchDown™ Universal Pipe Clamp

- Clamps 1/4" – 1" CTS (copper, CPVC or PEX) tube and 1/8" - 1" Sch. 40 pipe
- Optional PipeDown™ noise absorption blocks available

PowerBar™ for 14"—26"



Part #	Mfg #	Brackets	Clamps	Screws	Price
178130	523-2404	1	—	6	
150890	523-2424	1	2	4	

PowerBar™ for 9"—16"



Part #	Mfg #	Brackets	Clamps	Screws	Price
181335	523-1610	1	1	—	

TouchDown™ Clamp with PowerBar™ Foot

Part #	Mfg #	Bases	Bridges	Inserts	Price
151611	522-101	—	100	—	

Tubing Brackets

Piping Supplies & Accessories

PowerBar™ Light Duty Mini Strut—20 Gauge Steel

- Single Bracket with two pre-drilled holes accepts 3/8" threaded rod
- Available with or without pre-loaded TouchDown™ clamps
- Ideal for a variety of overhead piping needs



523-2MS3

Part #	Mfg #	Bracket	Clamps	Price
156294	523-2MS3	1	3	

Strong Arm™ Bracketing System

Strong Arm™ Bracketing System with Lock Block™ CTS Tube Clamp

- Rigidly secures any CTS stub-out and prevents movement
- Lock Blocks™ are pre-assembled on each pair of brackets
- Twisted brackets mount to the face of the stud
- Lock Blocks™ compress on tube and brackets once screws are tightened down
- For use with any 1/2" - 1" CTS pipe (copper, PEX, CPVC, PB)



525-161PB

Strong Arm™ with Standard Lock Blocks™ (For 16" Stud Bays)

Part #	Mfg #	Bracket	Lock Block	Price
183444	525-161PB	Twisted	1 PEX Bend	
123159	525-161PBL	L-Bent	1 PEX Bend	
129806	525-162PB	Twisted	2 PEX Bend	

Strong Arm™ with PEX Bend Lock Block™ (For 24" Stud Bays)

Part #	Mfg #	Bracket	Lock Block	Price
159440	525-242PB	Twisted	2 PEX Bend	

StrongArm™ Bracketing System with Lock Block™ CTS Tube Clamp For 16" Stud Bays

- Rigidly secures any 1/2" – 1" CTS stub out and prevents all movement
- LockBlocks™ are pre-assembled on a pair of brackets or available with 2-1/2" screws to mount directly to structure
- LockBlocks™ compress on tube and brackets after screws are tightened
- Twisted brackets easily mount to the face of the stud and L-bent brackets mount inside the stud cavity
- Brackets-16 gauge galvanized steel
- Standard (black) blocks-ABS



525-1622

Strong Arm with Standard Lock Blocks (For 16" Stud Bays)

Part #	Mfg #	Bracket	Lock Block	#	Price
222428	525-1612	Twisted	1/2"	1	
118450	525-1622	Twisted	1/2"	2	
183445	525-1622PK1	Twisted	1/2"	2	

Strong Arm with Standard Lock Blocks (For 24" Stud Bays)

Part #	Mfg #	Bracket	Lock Block	#	Price
159439	525-2422	Twisted	1/2"	2	

StrongArm™ Vent Support

- Secure directly to vent pipe when studs are not available (ideal for pedestal lav and island sinks)
- Completely pre-assembled to reduce labor
- Snap-lock band secures to 1-1/2" – 2" DWV



525-162PBV

Strong Arm with PEX Bend Lock Blocks & Bands (Vent Pipe Application)

Part #	Mfg #	SS Band	Block	Clamp	Price
183447	525-162PBV	Snap	(2)1/2"	Saddle	

Tubing Brackets

Pipe Brackets

Flat Copper-Plated Pipe Bracket

- For 1/2", 3/4" or 1" copper pipe



Part #	Mfg #	Description	Price
141215	B00-005	1/2" - 1" x 20", 50/Pk	

Tubing Brackets

PexRite® for PEX

**708 PexRite® Pop-Up™ In-Slab
Flexible Tube Support**

PEXRITE®

- *Manifold capability with interlocking feet*
- *Compatible with PEX, soft copper, flexible conduit*
- *Unique design allows for side-entry of tubing*



Part #	Mfg #	Description	Price
121159	708	Holds Up To Two Tubes, Up to 1-1/8" OD	

Piping Supplies & Accessories

Vacuum Breakers

Watts Vacuum Breakers

LF288A Series Anti-Siphon Irrigation Vacuum Breaker (FNPT)

- To prevent back siphonage of contaminated water into potable water supply
- Health hazard cross-connections not subject to continuous pressure
- Maximum temperature: 180°F
- Maximum working pressure: 125 psi



Part #	Mfg #	Model	Size	Finish	Price
157297	0792037	LF288A	3/8"	Plain Brass	
157298	0792038	LF288A	1/2"	Plain Brass	
157299	0792039	LF288A	3/4"	Plain Brass	
157303	0792052	LF288AC	1/2"	Pol Chrome	
157304	0792053	LF288AC	3/8"	Pol Chrome	

LF800 Anti-Siphon Vacuum Breaker

- Anti-Siphon Pressure
- Replaceable plastic seat
- Easy maintenance of internal parts
- Acetal bonnet acts as "freeze plug" to prevent body damage
- O-ring bonnet seal
- Silicone seat disc for durability
- Test cocks positioned for easy testing and winterization
- Compact space saving design
- Standardly equipped with tee handle quarter turn ball valve shut offs
- 1/2" – 1" (15 – 25mm). The 1 1/4" - 2" (32 - 50mm) feature lever handles.



Part #	Mfg #	Model	Size	Price
157198	0792010	LF800M4-QT	1/2"	
157211	0792011	LF800M4-QT	3/4"	
157212	0792012	LF800M4-QT	1"	

LF008PCQT Anti-Siphon Spill-Resistant Vacuum Breaker

- Standardly supplied with internal polymer coating
- Standardly supplied with Tee handles
- Available less Tee handle with stem wrench flats
- Available in left-handed or right-handed outlet
- Spill-resistant design for indoor use
- Modular cartridge for ease of service
- Vent uses an O-ring for reliable operation
- Lead Free* cast copper silicon alloy body for durability
- Compact space saving design



Part #	Mfg #	Model	Size	Price
157167	0792024	LF008PCQT	1/2"	

LFN36 Water Service Vacuum Relief Valve

- Low profile
- All Lead Free* brass body
- Protective cap
- Suitable for low pressure steam and water service
- Tested and rated to ANSI Z21.22
- CSA certified



Part #	Mfg #	Model	Size	Price
156646	0556030	LFN36-M1	1/2"	
157272	0556031	LFN36-M1	3/4"	

Vacuum Breakers

Vacuum Breakers

Nidel® Single Check Anti-Siphon Vacuum Breaker

- ASSE 1011
- H Models: for non-freezing areas only
- HD Models: for freezing areas
- HA Models: Std on models 25 and 65
- HF Models: Std on models 24, 43, 44, 45, +46, 74, 75 and 84



Part #	Mfg #	Description	Price
011713	34H-CH	Chrome	
023046	34HA-CH	Chrome	
011728	34HA-BR	Brass	
011714	34HD-CH	Chrome	
047118	34HF-CH	Chrome	

Backflow Preventers

Nidel® Double Check Anti-Siphon Backflow Preventer

- ASSE 1052
- HA Models: Std on models 67
- 37HA converts model 65 to model 67
- HF Models: Std on models 76, 79, 86



Part #	Mfg #	Description	Price
065086	37HA-CH	Chrome	



Access Panels

Access Panels

- For spa pumps and security systems
- Works on ceilings and walls
- No visible clamps or screws



Part #	Mfg #	Size	Price
017283	AP-0808	8" x 8"	
017284	AP-1414	14" x 14"	

Access Panels

Access Panels

Snap-Ease Access Panel

- Easily installed to eliminate unsightly sheetrock repairs
- Provides for future access to plumbing or wiring behind wall
- Constructed of high-impact ABS
- Can be painted or wallpapered

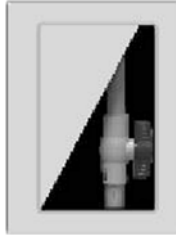

Part #	Mfg #	Size	Price
038910	A04-006	6" x 9"	
038911	A05-008	8" x 8"	
056645	A05-014	14" x 14"	

Plastic Access Panel

- Beveled edges
- Indented screw holes in corners



Part #	Mfg #	Size	Price
123071	A04-012	12" x 12"	

Access Panels

Oatey Access Panels

- For plumbing, electrical security systems, telephone, TV, computer cables and sprinkler system applications
- Manufactured from high-impact ABS
- Textured surface
- Reversible - can be flushed-mounted and surface mounted, no framing required
- Can be painted, wallpapered or tiled to match any decor
- 4" x 6", 8" x 8" and 6" x 9" Panels have knockouts to accommodate 1/4" waterlines



Part #	Mfg #	Size	Price
124715	34055	6" x 9"	
027894	34056	14" x 14"	

Plumbing Miscellaneous



Access Panels

Part #	Mfg #	Description	Price
--------	-------	-------------	-------

Plumbing Miscellaneous

RTV Sealants

Silicone RTV Sealants

RD PRO® 100% Silicone Sealant, Heat Resistant RTV

- Withstands temperatures up to 600°F
- Solvent cleanup
- 50-Year warranty



Part #	Mfg #	Size	Color	Price
024216	0809OI	10.1 oz	Red	

RD PRO® 100% Silicone Sealant, Industrial Grade RTV

- 100% Silicone
- Remains flexible and resists vibration
- Interior/exterior use
- Solvent clean up, not paintable
- 50-Year durability



Part #	Mfg #	Size	Color	Price
008383	0816OI	10.1 oz	White	
118017	0816/5I	10.1 oz	Gray	

Plumbing Miscellaneous



CONSUMER PRODUCTS



CONSUMER PRODUCTS

Adhesives & Sealants

Waterproofing Products

Waterplug® Hydraulic Cement Mortar

- *Waterproof cement-based coating for concrete, block, brick or stucco*
- *Can be used above or below grade, interior or exterior*
- *Resists water under pressure or wind-driven rain*



Part #	Mfg #	Description	Price
115728	T5002	10 lb Can	

Plumbing Miscellaneous

Adhesives & Sealants

Instant Foam Sealants

- *Flame resistant*
- *Fills holes and cracks*
- *Deadens sound*
- *Insulates against air conditioning and heat loss*
- *Can spray in any position*



Part #	Mfg #	Size	Price
055962	S30012	12 oz	

Boxes

Fire Rated Boxes

Fire Rated Box

- 1/4 Turn brass ball valve with water hammer arrestor
- 1/2" ASTM F1960 PEX
- Standard Pack



Part #	Mfg #	Size	Price
186036	38481	Hammer Standard	

Fire Rated Box - Low Lead

- 1/4 Turn brass ball valve
- F1960
- Standard Pack



Part #	Mfg #	Size	Price
222725	39120	No Hammer Standard	
186035	39124	Hammer Standard	

Tub Boxes

- Provides a quick, economical and clean method of installing tub waste and drain
- Manufactured from semi-flexible, very durable plastic polymer
- Built in cut-out for up to 2" Sch 40 drain
- Enables installer to form a clean cavity in a concrete slab so a trap can be easily connected to the drain system
- Bottom ID: 11-1/2" x 11-1/2"
- Top ID: 13" x 13", 6-1/2" Depth



Part #	Mfg #	Description	Price
046615	34080	Standard Tub Box	

Washing Machine Outlet Boxes

Offset Drain Washing Machine Outlet Box - Right Hand Drain

- 2" Drain opening fits PVC or ABS Sch 40 DWV pipe
- Box made of high impact polystyrene
- (4) Support brackets
- Easy drain knockout
- Top mount knockouts
- Dimensions:
 - Box: 7-1/2"H x 8-3/4"W x 3-5/8"D
 - Faceplate: 10-1/8"H x 11-3/4"W



Single Lever Valves

Part #	Mfg #	Connection	Pack	Price
007990	38894	Copper Swt	Standard	

1/4-Turn Brass Ball Valves

Part #	Mfg #	Connection	Pack	Price
048704	38962	Copper Swt	Standard	

Center Drain Washing Machine Outlet Box

- 2" Drain opening fits PVC or ABS Sch 40 DWV pipe
- Box made of high impact polystyrene
- (4) Support brackets
- Easy drain knockout
- 1/2" Top mount knockouts
- Dimensions:
 - Box: 7-1/2"H x 8-3/4"W x 3-5/8"D
 - Faceplate: 10-1/8"H x 11-3/4"W



1/4-Turn Brass Ball Valves (Center Drain)

Part #	Mfg #	Description	Pack	Price
035125	38934	Copper Swt	Standard	

Plumbing Miscellaneous

Boxes

2 X 4 Washing Machine Outlet Box

- Ability to attach water lines from bottom or top
- Mount for condensate line
- Knockout drain caps
- Direct stud mount capability
- Snap-on faceplate frame accommodates up to 1" dry wall
- Two support brackets and direct stud mount for easy mounting
- Box, faceplate, and brackets made from PVC



Part #	Mfg #	Description	Pack	Price
171012	38201	Copper Sweat	Standard	

2 X 4 Washing Machine Outlet Box

- Hammer Assembled

Part #	Mfg #	Size	Price
227681	38219	Hammer	Standard

Washing Machine Outlet Box with 1/4-Turn Brass Single Lever Ball Valve



Part #	Mfg #	Description	Pack	Price
047525	38673	Copper Swt	Standard	

Quadro™ Washing Machine Outlet Boxes

- 2" Drain opening fits PVC or ABS Sch 40 DWV pipe
- Box made of high impact polystyrene
- (4) Support brackets
- Easy to remove knockout
- Snap-on faceplate frame accommodates up to 1" dry wall
- 'Lock and Load' valve mounting system
- Dimensions:
 - Box: 7-1/2"H x 8-3/4"W x 3-5/8"D
 - Faceplate: 10-1/8"H x 11-3/4"W



QUADRO™ 1/4-Turn Brass Ball Valve

Part #	Mfg #	Connection	Pack	Price
071807	38530	Copper Swt	Standard	
090793	38532	PEX	Standard	
071806	38533	WIRSBO	Standard	
125083	38577	Quadro Hub/O-Ring	-	

Quadro™ Washing Machine Outlet Boxes (Continued)

QUADRO™ 1/4-Turn Brass Ball Valve

Part #	Mfg #	Connection	Pack	Price
187029	38562	PEX	Contractor	

QUADRO™ Single Lever Ball Valve

Part #	Mfg #	Connection	Pack	Price
137698	38535	Copper Swt	Standard	

Replacement Valve for Washing Machine Outlet Box

Part #	Mfg #	Description	Price
072033	38870	1/4 Turn Red Valve (Hot) w/Long Shank	
069188	38871	1/4 Turn Blue Valve (Cold) w/Long Shank	

Ice Maker Outlet Boxes

- Valves comply with requirements of NSF 61, Section 9
- High impact polystyrene boxes

Center Drain with 1/4-Turn Brass Ball Valves

- (2) Support brackets
- Dimensions
 - Box: 6"H x 6"W x 3-3/8"D
 - Faceplate: 8-1/4"H x 8-1/4"W



Part #	Mfg #	Connection	Pack	Price
047524	38681	Copper Swt	Standard	
048586	38810	Box Only	Standard	

12K™ Ice Maker Box with Nails with 1/4-Turn Brass Ball Valve

- Nails preloaded - no support bracket needed
- Right or left hand installation
- Provides quick, safe water supply and shutoff for refrigerator ice maker and water dispenser
- Dimensions:
 - Box: 3-1/4"W x 4"H x 2-1/2"D
 - Faceplate: 5"W x 6"H



Part #	Mfg #	Connection	Pack	Price
048698	38611	Copper Swt	Standard	
145998	38619	Box Only	Standard	

Plumbing Miscellaneous

Boxes

12K Icemaker Outlet Box

- Preloaded nails
- Right or left hand installation
- Provides quick, safe water supply and shutoff for refrigerator ice maker and water dispenser
- Dimensions:
-Box: 3-1/4"W x 4"H x 2-1/2"D
-Faceplate: 5"W x 6"H



Part #	Mfg #	Size	Price
223965	39125	Copper, Hammer Contractor	
155615	39128	F1960 Contractor	
155614	39132	F1960 Contractor	
155611	39134	Copper Swt Standard	
155612	39134	F1807 Standard	

WMOB and IMOB Faceplate

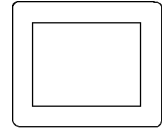

Part #	Mfg #	Description	Price
028026	38940	WMOB White Faceplate - Double Offset	
020797	38941	WMOB White Faceplate - Center Drain & Offset	

Metal Ice Maker Outlet Box

- Made of 20 gauge steel
- Nail plate support brackets
- Dimensions:
-Box: 5-1/2"W x 5"H x 2-1/2"D
-Faceplate Interior: 5"W x 5"H
-Faceplate Exterior: 6-3/4"W x 6-3/4"H



Part #	Mfg #	Size	Price
225777	39140	Copper Hammer Standard	
155619	39141	Copper Swt Standard	

Square Ice Maker Outlet Box

- 2 Support brackets
- Provides quick, safe water supply and shut off for refrigerator ice maker and water dispenser
- High impact polystyrene
- Dimensions:
-Box: 6"W x 6"H x 3-3/8"D
-Faceplate: 8-1/4"W x 8-1/4"H



Part #	Mfg #	Size	Price
155618	39152	Copper Swt Standard	
155616	39155	CPVC Standard	
155123	39158	F1807 Standard	
155617	39161	F1960 Standard	

Plumbing Miscellaneous

Boxes

Ox Box™ Outlet Boxes

Ox Box™ Ice Maker Outlet Box with Mini-Rester Water Hammer Arresters (No Lead)

- Standard Pack
- Boxes mount securely to stud or over studs
- Durable ABS stands up to job site abuse
- Debris covers included to protect boxes from dry wall mud and paint
- High-quality 1/4 turn ball valve
- 1/4" O.D. Compression outlet connection
- The debris cover protects valves from drywall mud and paint during construction.



Part #	Mfg #	Connection	Price
144576	696-G1010MF	1/2" FSwt	
183807	696-G1010XF	1/2" PEX F1807	

Ox-Box™ Washing Machine Outlet Box —No Lead (Standard Pack)

- Boxes mount securely to stud
- Separates supply and drainage systems into (2) stud bays
- Separate boxes offer flexible layout
- Durable ABS stands up to job site abuse
- Drain knockout is easy to remove with pliers
- Debris covers included to protect boxes from dry wall mud and paint
- High-quality 1/4-turn ball valve
- 3/4" Male hose-thread outlet connection

Part #	Mfg #	Connection	Price
183810	696-G2303MF	1/2" FSwt	
174844	696-G2303WF	1/2" PEX 1960	
097546	696-G2303XF	1/2" PEX F1807	

Fire-Rated Ox-Box™ Washing Machine Outlet Box (Standard Pack—No Lead)

- Boxes mount securely to stud
- Separates supply and drainage systems into (2) stud bays
- Drain knockout is easy to remove with pliers
- Supply lines can be mounted from above or below
- High-quality 1/4-turn ball valve
- 3/4" Male hose-thread outlet connection

Part #	Mfg #	Connection	Price
187523	696RG2303W F	1/2" PEX 1960	
169781	696RG2303XF	1/2" PEX F1807	

Fire-Rated Ox-Box™ Washing Machine Outlet Box with MiniRester™ Water Hammer Arresters

- Standard pack—no lead
- Boxes mount securely to stud
- Separates supply and drainage systems into (2) stud bays
- Supply lines can be mounted from above or below
- High-quality 1/4-turn ball valves with 3/4" male hose-thread outlet connections



Part #	Mfg #	Connection	Price
183816	696RG2303MF	1/2" FSwt	

Fire-Rated Ox-Box™ Ice Maker Outlet Box—No lead (Standard Pack)

- Boxes mount securely to stud
- Separates supply and drainage systems into (2) stud bays
- High-quality 1/4-turn ball valves with 3/4" male hose-thread outlet connections
- Supply lines can be mounted from above or below



Part #	Mfg #	Connection	Price
159258	696RG1000W F	1/2" PEX 1960	
165313	696RG1000XF	1/2" PEX F1807	

Fire-Rated Ox-Box™ Ice Maker Outlet Box with MiniRester™ Water Hammer Arresters—No Lead

- Standard pack
- Boxes mount securely to stud or over studs
- Box mounts easily to stud for top or bottom supply
- High-quality quarter-turn ball valves with 1/4" O.D. compression outlet connection



Part #	Mfg #	Connection	Price
183814	696RG1010MF	1/2" FSwt	

Plumbing Miscellaneous

Boxes

Ox-Box™ Washing Machine Outlet Box with Two Mini-Rester Water Hammer Arresters

- Standard pack
- Boxes mount securely to stud
- Separates supply and drainage systems into (2) stud bays
- Separate boxes offer flexible layout
- Durable ABS stands up to job site abuse
- Drain knockout is easy to remove with pliers
- Debris covers included to protect boxes from dry wall mud and paint
- High-quality 1/4-turn ball valves
- 3/4" Male hose thread outlet connection



696-2313MF

Part #	Mfg #	Connection	Price
183811	696-2313MF	1/2" FSwt	
183813	696-2313XF	1/2" PEX F1807	
175891	696-G2313WF	1/2" PEX 1960, No Lead	

Ox Box™ Outlet Box

- Made from tough ABS
- Installs directly to stud or by bracket
- May be installed with supply from above or below
- One-hole box for ice maker, two-hole box for washing machine
- Washing machine supply box can be placed above, to the left, and to the right of drain box
- Includes debris cover



Part #	Mfg #	Box Type	Includes	Price
122975	696-R3	Drain	Fire Pad&Frame	

Ox Box™ Frame

- Textured and paintable ABS
- Single frame for ice maker
- Double frame for washing machine application easily splits for separated box installations



Part #	Mfg #	Type	Price
122898	696-2F	Double	

Ox Box™ Secondary Drainage Funnel

- Ideal for adding condensate lines to drain box
- Can be used in conjunction with washing machine drain hose
- Drains 7 gpm
- Securely sets into drain box through integral bottom ridges of the drain box
- Two-piece design snaps together for fast installation and easy cleaning
- Fingers in top housing hold 1/2" CTS - 1" DWV piping firmly in place
- UPC Listed to IAPMO PS 65-2002



Part #	Mfg #	Material	Price
125300	696-CF	White ABS	

OxBox™ Toilet/Dishwasher Outlet Box (No Lead) (Standard Pack)

- ABS boxes mount securely to stud or over studs
- Allows for straight and secure supply stops recessed into the wall
- Eliminates backbreaking labor of cleaning stub outs and installing supply stops
- Debris covers included to protect boxes from drywall mud and paint
- High-quality quarter-turn ball valves with 3/8" O.D. compression outlet connection



696-G1001MF

Part #	Mfg #	Connection	Price
183805	696-G1001MF	1/2" FSwt	
180997	696-G1001WF	1/2" PEX 1960	
183806	696-G1001XF	1/2" PEX F1807	

OxBox™ Toilet/Dishwasher Outlet Box with MiniRester™ Water Hammer Arresters (No Lead)

- Standard pack
- ABS boxes mount securely to stud or over studs
- Allows for straight and secure supply stops recessed into the wall
- Eliminates backbreaking labor of cleaning stub outs and installing supply stops
- Debris covers included to protect boxes from drywall mud and paint
- High-quality quarter-turn ball valves with 3/8" O.D. compression outlet connection



Part #	Mfg #	Connection	Price
151275	696-1011MF	1/2" FSwt	

Boxes

OxBox™ Lavatory Outlet Box —No Lead (Standard Pack)

- ABS boxes mount securely to stud or over :
- Allows for straight and secure supply stops recessed into the wall
- Eliminates backbreaking labor of cleaning stub outs and installing supply stops
- Debris covers included to protect boxes from drywall mud and paint
- High-quality quarter-turn ball valves with 3/8" O.D. compression outlet connections



696-G2001MF

Part #	Mfg #	Connection	Price
183808	696-G2001MF	1/2" FSwt	
180998	696-G2001WF	1/2" PEX 1960	
183809	696-G2001XF	1/2" PEX F1807	

OxBox™ Gas Valve Outlet Box

- 1/4"-turn ball valve for easy, secure, accessible operation
- Box is available for 1/2" or 3/4" iron-pipe applications or 1/2" CSST applications in both standard and fire-rated products
- Recessed box is made of high-impact ABS providing the strongest finished installation for all gas appliance needs
- Valve has CSA certification to ANSI Z21.15-1997 / CGA 9.1-M97



Part #	Mfg #	Valve & Adapter	Price
153746	696-1021GF	1/2" NPTfor Iron Pipe	

OxBox™ No Lead Ice Maker Outlet Box (Standard Pack)

- Boxes mount securely to stud or over studs
- Durable ABS stands up to job site abuse
- Debris covers included to protect boxes from drywall mud and paint
- High-quality quarter-turn ball valve
- 1/4" O.D. compression outlet connection
- Box mounts easily to stud for top or bottom supply
- The debris cover protects valves from drywall mud and paint during construction.



Part #	Mfg #	Connection	Price
162651	696-G1000MF	1/2" FSwt	
168331	696-G1000XF	1/2" PEX F1807	

OxBox™ ONE Small Profile Laundry Supply & Drain Box with Water Hammer Arresters

- Least obtrusive of any laundry box
- Economical alternative
- Perfect for top mounted supply run from overhead
- Debris cover included

Part #	Mfg #	Connection	Hose Outlet	Price
183804	696-2413MF	1/2" FSwt /MIP	3/4"	

Over/Under™ Two-Piece Plastic Access Panel

- Easily installs before or after wallboard installation
- No need for glue or adhesives
- Can be painted or wallpapered
- Pre-wallboard installation works with 1/2" – 3/4" wallboard thickness
- Provides instant access to plumbing, electrical, telephone and other electronic cables
- Seamless finish panel is beveled and textured
- Durable HIPS material



Part #	Mfg #	Outside	Inside	Price
223845	970-214S	8-1/2"x11-1/2"	6"x9"	

Hinged Two-Piece Metal Access Panel

- Made in the USA
- Easy installation and can be painted
- Provides instant access to plumbing, electrical, telephone and various other electronic cables



Part #	Mfg #	Outside	Inside	Price
167431	971-1414	15-1/4"x15-1/4"	14"x14"	

Boxes

Water Meter Accessories

15" Jumbo Water Meter Box

Part #	Mfg #	Description	Price
056770	M15-001	15" Box & Green Solid Lid	

Residential Valve Box

- Snap-in green lid; 6 oz.
- Overlapping cover keeps dirt or grass from between body and lid
- Can be extended with any 6" plastic or iron pipe



Part #	Mfg #	Description	Price
162068	M06-006	6" Valve Box, 9" Tall	

Boxes

Washing Machine Outlet Boxes

Center Drain Galvanized Washing Machine Outlet Box

- 20 Gauge box and faceplate
- G90 Hot dipped galvanized steel (unpainted)
- Includes male threaded drain fitting and locknut
- Rough opening: 8-3/4"H x 10"W x 3-1/2"D
- Faceplate dimension: 9-1/2"H x 11-5/8"W
- Domestic valves
- Unassembled



Part #	Mfg #	Description	Price
004881	82032	B200 1/2" MIP/Swt, 2" Threaded Drain Fitting	
004876	82036	BB200TS Top-Mt 1/2" MIP/Swt, 2" Threaded Drain Fitting	

"T" Series Center Drain Washing Machine Outlet Box

- White powder coated cold rolled steel
- 20 Gauge box and faceplate
- Knockouts in top, bottom and sides
- Watertight construction with sloped bottom
- 2" PVC, ABS or slipnut drain kit
- Rough opening: 8-1/4"H x 12-3/4"W x 3"D
- Faceplate dimension: 9-1/4"H x 14"W
- Slipnut to be used with 2" male adapter or 2" pipe nipple (not included)
- Unassembled



Part #	Mfg #	Description	Price
004885	82135	T200TP PVC Domestic MIP, 1/2" Swt, 2" PVC Drain Fitting	

Plumbing Miscellaneous



Sheet Metal Duct & Fittings

Galvanized Dryer Vents & Accessories

Galv Dryer Box

Part #	Description	Price
064143	Upflow for 2" x 4" Walls	
064144	Upflow for 2" x 6" Walls	
086205	Downflow for 2" x 4" Walls	
087158	Downflow for 2" x 6" Walls	

Caulk

Caulk**Bramec® Silicone Sealant**

- Permanently flexible -60° to 450°F
- 100% RTV Silicone
- Insulates thermally and electrically
- Waterproof and weatherproof seal



Part #	Mfg #	Description	Price
094478	20082	10.1 oz Tube, Aluminum	



Caulk

Sealants & Caulk

100% RTV Silicone Rubber Sealant

- 100% Silicone rubber cures and bonds in 24 hours
- Withstands temperatures from -60° to +450°F
- Creates seal between dissimilar materials
- Waterproof, can be used indoors or outdoors
- Dries to the touch in 1 hour
- Meets Federal Specification TT-S-001543A



Part #	Mfg #	Description	Price
044630	031350	10.3 oz Cartridge, White	
017661	31312	Plumb Label, Clear	

Latex Tub Seal

- Water based acrylic caulk w/silicone for added adhesion and low temperature flexibility
- Easy application, soap and water cleanup
- Fills joints up to 3/8" wide x 3/8" deep
- Tack-free in 30 minutes, paintable in 2 hours with latex or oil based paints



Part #	Mfg #	Description	Price
043425	032005	Clear, 5.5 oz	
017662	PLTUB	Plumb Label, White, 5.5 oz	
005561	032106	Bone, 5.5 oz	
068208	32150	Biscuit, 5.5 oz	

Plumbing Miscellaneous



Caulk

Sealants

Plastic Seal™ Sealant

- Excellent lead substitute for caulking cast iron soil pipe joints
- Single component polyurethane sealant that cures rapidly to a durable, flexible, waterproof seal
- Does not contain any volatile organic compounds



Part #	Mfg #	Size	Price
122847	25215	10.3 oz	

Caulk

Plumbers Caulk

- Siliconized acrylic makes flexible, durable, mildew-resistant, waterproof seal
- Interior or exterior applications
- Flows easily, does not harden in tube or cartridge, does not crumble, and resists shrinkage
- Easy clean-up with soap water



Part #	Mfg #	Size	Color	Price
084092	25641	6 oz	Biscuit/Linen	

100% Professional Grade Plumber's Caulk

- Adheres to most porous and non-porous substrates
- Flexible, durable and UV-resistant
- Seal is waterproof and water tight
- Flows easily



Part #	Mfg #	Size	Color	Price
084121	25671	3 oz	White	

Plumbing Miscellaneous

Caulk

Caulk

DuraGuard™ Kitchen & Bath Siliconized Acrylic Caulk

- Provides a durable, watertight seal
- Offers adhesion, flexibility and durability
- Paintable
- Water clean up
- Low VOC
- Mold and mildew resistant



Part #	Mfg #	Size	Color	Price
008382	0406	10.1 oz	White	

DuraGuard™ Kitchen & Bath Siliconized Acrylic Caulk Squeeze Tube

- Provides a durable, watertight seal
- Offers adhesion, flexibility and durability
- Paintable
- Water clean up
- Low VOC
- Mold and mildew resistant



Part #	Mfg #	Size	Color	Price
044074	040520	10.1 oz	Almond	

Plumbing Miscellaneous

Caulk

Vulkem® 116 Weatherproofing Sealants

- One-part moisture-curing
- Gun-grade polyurethane sealant
- Flexible
- Does not require primer on most construction materials
- For use in precast, masonry, window frame perimeters, and similar types of construction joints
- Do not apply over damp or contaminated surfaces
- Suitable for continual immersion in water
- Designed for exterior and interior use



Part #	Mfg #	Description	Price
051545	VULKEM116AL	Vulkem #116 Aluminum	
051543	VULKEM116BL	Vulkem #116 Black	
051542	VULKEM116GY	Vulkem #116 Gray	
051546	VULKEM116IVY	Vulkem #116 Ivory	
051544	VULKEM116LS	Vulkem #116 Limestone	
051540	VULKEM116WHT	Vulkem #116 White	

Plumbing Miscellaneous



Chemicals

Drain and Waste System Cleaners

Clobber® Drain & Waste System Cleaner

- For professional use only, not for retail sale
- Fastest method for clearing emergency waste line stoppages
- No mechanical equipment needed
- Rapidly disintegrates paper, rags, sanitary napkins, food scraps and all organic matter, melts ice and liquefies grease
- Special inhibitors prevent corrosion of cast iron, copper, and steel piping
- Jugs with child-resistant caps packed in plastic bags

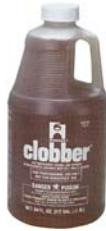

Part #	Mfg #	Size	Price
044672	20205	1 qt	

Sizzle® Cleaner

- For professional use only, not for retail sale
- Removes lime, rust, scale, concrete, hard mineral deposits and insoluble salts from water systems, waste lines, humidifiers, heating, processing and air conditioning equipment
- Dissolves urinary salts
- Special inhibitors make it safe for iron, steel, copper, brass, bronze, lead and plastic



Part #	Mfg #	Size	Price
044671	20305	1 qt	

GLUG® Crystals Drain Opener

- Non-acid crystals clear sluggish drains and prevent clogging
- Harmless to metal and plastic pipe, valves and fittings
- Leaves no offensive after-odor



Part #	Mfg #	Size	Price
137613	20412	16 oz	

Plumbing Miscellaneous



Chemicals

Drain Systems

Root Remover

Part #	Mfg #	Description	Price
004205	RK-20	Root Killer	

Septic Tank Accelerator

Part #	Mfg #	Description	Price
004206	SA-13	13 oz	

Chemicals

Flush N' Sparkle™ Toilet Cleaning System

- Repels stains
- Leaves no residue
- 8100 Is surfactant-based cleaning agent
- Easily installed
- 5-Year warranty on dispenser



Part #	Mfg #	Description	Price
064607	8100	Flush N Sparkle™ Toilet Bowl Cleaner	
064609	8102	Flush N Sparkle™ Refill Cartridge for 8100	
071473	8300	Flush N Sparkle™ Toilet Bowl Cleaner	
071475	8302	Flush N Sparkle™ Refill Cartridge for 8300	

Bio Balance™ Septic Tank Care System

- Instant septic bio-action with every flush
- No residue or harsh chemicals
- Repels stains and mineral build-up
- Easy to install
- 5-Year warranty on dispenser



Part #	Mfg #	Description	Price
064608	8200	Bio Balance™ Septic Tank Care System	
064610	8202P8	Bio Balance™ Septic Tank Care Refill cartridge	

Plumbing Miscellaneous

Chemicals

Drain Openers

Safe on Pipes, Traps and Septic Systems

- Santeen S-T Drain Opener is a unique formulation of concentrated sulfuric acid that will quickly dissolve all rags, paper and organic blockages such as: grease, hair, bone scraps, coffee grounds, rinds and soap
- Professional strength



Part #	Mfg #	Size	Price
009806	S-T	1 qt	

De-Limer/Cleaners

Chrome & Tile Cleaner

- A unique formulation of phosphoric acid in an industrial strength formula that is effective for cleaning brick, chrome, stainless steel, enamel, tile, brass, copper, porcelain and shower doors
- Dissolves rust, lime and scale



Part #	Mfg #	Size	Price
009799	Chrome-R-Tile	22 oz	
009808	Chrome-R-Tile	1 qt	

Parts & Accessories



Part #	Mfg #	Description	Price
009804		Nylon Acid Proof Applicator	

Chemicals

Drain Cleaners

Non-Acid Drain Cleaner

- For use on small drains, grease traps, septic systems, root control
- Dry, odorless crystals activated by water and within 60 seconds clears blockage



Part #	Mfg #	Size	Price
010369	T-100	1 lb	
033389	T-600	6 lbs	

Super-Pro Heavy-Duty Acid Drain Cleaner

- Environmentally safe
- Safe odor
- No need to evacuate water from facilities
- For use on small drains, waste lines, traps, tubs & toilet bowls, shower stalls



Part #	Mfg #	Size	Price
025629	SP-32	32 oz	

Calci-Buster

- Removes scale and clogs
- Dissolves calcium, magnesium, sodium, lime and rust without harming pipes



Part #	Mfg #	Size	Price
133879	CB-32	1 Qt	

Plumbing Miscellaneous

Chemicals

Drain Cleaner Chemicals

Floweazy Drain Cleaner

- Organic digester; biodegradable
- Dissolves grease, hair, sanitary napkins, sludge, soap and paper
- Removes lime scale and rust deposits
- Safe for septic tanks and pipes
- Ground transport only



S95701 S95703

Part #	Mfg #	Size	Price
068376	S95-701	16 oz	
068375	S95-703	1 qt	

Chemicals

Industrial Acid Cleaners

Calci-Solve® Drain Cleaner

- For cleaning boilers, heaters, water pumps, evaporators, heat exchangers, and other air conditioning equipment
- Rids drains of clogs and odors
- Removes scales from lines



Part #	Mfg #	Description	Price
007784	4134-24	1 qt Bottle	
007783	4134-08	1 gal Bottle	

Chemicals

Cleaners

Floweazy™ Drain Opener

- Made in USA
- Sold only in full case quantities
- Will not harm metal, PVC pipe or septic tanks, and is safe to use for all common drains, cleanouts, sinks and toilets.
- Powerful – proprietary formulation of 94% virgin sulfuric acid with 12 buffers/inhibitors that dissolves any organic material including coffee grounds, grease, hair, paper, sanitary napkins, rags, sludge and/or soap.
- Professional strength unclogs drains fast -- the clog is typically free-flowing within 15-minutes of treatment.
- Little to no odor with safety-focused packaging including a child-proof cap on the quart bottles and a metal heat-welded seal on all bottles.

963-HTL-FE20



Part #	Mfg #	Bottle Size	Price
177651	963-HTL-FE20	20 Ounces	
177652	963-HTL-FE32	1 Quart	

Cleanouts & Covers

Cleanouts

PVC Internal Pipe Cleanout

- Solvent welds into Sch 40 DWV pipe
- Allows pipe to be cut flush with floor or wall
- Countersunk plug included



Part #	Mfg #	Pipe Size	Plug Size	Price
042011	C60-008	4"	3-1/2" IPS	

2"x3" Fit-Flush cleanout- PVC

- 2" Countersunk Plug
- Built in stop



Part #	Mfg #	Description	Price
155613	C61-023	2"x3"	

Plain End Cleanout Long Pattern - Raised Head

- Includes Southern code plug
- For use with service-weight (caulk into hub) or no-hub (use coupling)



Part #	Mfg #	Pipe Size	Plug	Height	Price
015322	C38-014	4"	3-1/2"	4"	

PVC Over The Pipe Cleanout

- Supplied with 3"IPS Counter sunk plug
- Covers available in PB & NB
- Covers are 3/16" thick



Part #	Mfg #	Description	Price
169255	C60-020	4" Over pipe fit base	

Cleanout Plugs

PVC Cleanout Plug - Raised Head

- White plastic



Part #	Mfg #	Size	Price
122806	P49-350	3-1/2"	

PVC Cleanout Plug - Countersunk

- White plastic



Part #	Mfg #	Size	Note:	Price
068954	P49-002	2"		
048758	P49-003	3"		
068955	P49-035	3-1/2"		
068944	P49-004	4"		
054767	P49920	2"	w/Insert	
058671	P49-925	2-1/2"	w/Insert	
054771	P49930	3"	w/Insert	
058674	P49935	3-1/2"	w/Insert	
054769	P49940	4"	w/Insert	

Southern Code Brass Plug - Raised Head



Part #	Mfg #	Size	Price
013919	P50-200	2"	
014115	P50-250	2-1/2"	
014429	P50-300	3"	
014504	P50-350	3-1/2"	
015315	P50-400	4"	
015521	P50-500	5"	
070322	P50-999	10"	

Southern Code Brass Plug - Countersunk



Part #	Mfg #	Size	Price
012440	P51150	1-1/2"	
013811	P51200	2"	
014083	P51250	2-1/2"	
014346	P51300	3"	
014503	P51350	3-1/2"	
015223	P51400	4"	
023218	P51600	6"	
179456	P51800	8"	

Cleanouts & Covers

White Plastic Cleanout Plug - Countersunk



Part #	Mfg #	Size	Price
072523	P49015	1-1/2"	

White Plastic Cleanout Plug with Insert - Countersunk

- Threaded brass insert for cleanout covers



Part #	Mfg #	Size	Price
058669	P49915	1-1/2"	

Cleanout Cover Plates

Wall-Mount Stainless Steel Cover Plate

- 24 Gauge



Part #	Mfg #	Size	Price
005897	C90-300	3"	
005898	C90-400	4"	
005899	C90-500	5"	
005900	C90-600	6"	
005901	C90-800	8"	

High Impact Plastic Cleanout Cover Plate - Flat Design



Part #	Mfg #	Size	Finish	Price
055767	C95-004	4-1/4"	White	
081780	C95-005	5-1/4"	White	
055765	C95-007	7-1/4"	White	

Cleanouts & Covers

Cast Iron Specialties

Cleanout Cover Plate with Bolts

- Polished stainless steel
- Countersunk hole will accept both 1/4" and 5/16" bolts
- Covers unsightly waste cleanouts
- Polished face covered with protective paper
- 22 Gauge metal
- Includes 1/4" x 20" x 4" bolts

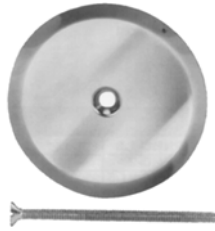

Part #	Mfg #	Plate Size	Price
008062	1840	3"	
008063	1841	4"	
008064	1842	5"	
008065	1843	6"	
008066	1845	8"	

Cleanout Cover Plate Bolt



Part #	Mfg #	Size	Price
008052	1649	1/4" x 20" x 4"	

Plumbing Miscellaneous

Cleanouts & Covers

Round Covers

Commercial Flat Cleanout Cover

- Includes head adapter, ring and cover
- Flat ABS models in chrome plated, white and ivory finishes
- Stainless steel models in standard 20 gauge or thicker, stronger 16 gauge

Part #	Mfg #	Finish	Dia.	Price
036901	871-4	White ABS	4-1/2"	
045440	871-6	White ABS	6-1/2"	
133035	871-8	White ABS	8-1/2"	

Commercial Raised Cleanout Cover

- Includes head adapter, ring and cover
- 1-1/4" High
- Flat ABS models in chrome plated, white and ivory finishes
- Stainless steel models in standard 20 gauge or thicker, stronger 16 gauge



871-16

Part #	Mfg #	Finish	Dia.	Price
143195	871-16	White ABS	7-1/4"	
057828	872-16	Chrome ABS	7-1/4"	

Commercial Finish Line™ Halo™ Cover

- Includes head adapter, ring and cover

Part #	Mfg #	Finish	Dia.	Price
227609	834-3HNR	Nickel Bronze	5-1/2"	

Square Covers

Commercial Finish Line™ Cover

- Includes head adapter, ring and cover
- Nickel-bronze covers for use in pedestrian areas.
- Ductile iron covers for use in heavy duty applications



834-4DHNQ

Part #	Mfg #	Finish	Size	Price
145763	834-4DHNQ	Nickel Bronze	6-5/8"	

Cleanout Plugs

Commercial Cleanout Bushing—ABS

- Bushing fits inside Sch 40 pipe
- Plug has threaded brass insert



875-4P

Part #	Mfg #	Plug Size	Color	Conn.	Price
141447	875-3P	2-1/2"	White	3"	

Cleanout Plugs (Continued)

Commercial Cleanout Bushing—ABS

Part #	Mfg #	Plug Size	Color	Conn.	Price
079414	875-4P	3-1/2"	White	4"	

Commercial Rough-In Cleanout—Push-Joint Connection

- Includes: base adapter, coring sleeve & coring plug
- Coring plug material: high-impact polymer
- Pre-pour height:
—(834-63DF) 5-5/8" - 6-7/8"
—(834-64DF) 5-7/8" - 7-1/8"

Part #	Mfg #	After Pour Height	Conn.	Price
183923	834-63DF	4-3/4"	3"	
183924	834-64DF	5"	4"	

Square Cleanouts

183872	822-C3DNR	Nickel Bronze	5-1/2"	
--------	-----------	---------------	--------	--

Commercial FinishLine™ Round Cleanout (Ductile Iron—No-Hub Connection)

- Adjustable AFTER the pour
- Poly coring plug
- Ductile iron base adapter with polypro cleanout plug.
- Ductile iron coring sleeve and head adapter.
- Nickel-bronze covers for use in pedestrian areas.
- Ductile iron covers for use in heavy duty applications



834-4DNR

• Connection		• Pre-Pour Height	
• 3" No-Hub		• 5-1/4" - 6-1/2"	
• 4" No-Hub		• 5-1/2" - 6-3/4"	

- After-pour height: 0-1-1/4"

Part #	Mfg #	Finish	Conn.	Dia.	Price
183920	834-4DIR	Ductile	3"	6-1/2"	
183921	834-4DNR	Nkl Bronze	4"	6-1/2"	

Plumbing Miscellaneous

Cleanouts & Covers

Commercial FinishLine™ Round Cleanout (Ductile Iron—Push-Joint Connection)

- Adjustable *AFTER* the pour
- Ductile iron base adapter with polypro cleanout plug.
- Ductile iron coring Sleeve and head Adapter.
- Poly Coring Plug
- Nickel-bronze covers for use in pedestrian areas.
- Ductile iron covers for use in heavy duty applications

• Connection	• Pre-Pour Height
• 3" No-Hub	• 5-5/8" - 6-7/8"
• 4" No-Hub	• 5-7/8" - 7-1/8"

- After-pour height: 0-1-1/4"

Part #	Mfg #	Finish	Conn.	Dia.	Price
183925	834-64DIR	Ductile	4"	6-1/2"	
183926	834-64DNR	Nkl Bronze	4"	6-1/2"	

Commercial FinishLine™ Adjustable Cleanout (Ductile Iron—No-Hub Connection)

- Adjustable *AFTER* the pour
- Includes rough-in cleanout, boxed in finish fixture, and ring & cover
- Ductile iron base adapter with 6" polypro cleanout plug
- Medium-duty nickel-bronze and stainless steel covers
- Ductile iron cover for use in heavy-duty applications

Part #	Mfg #	Finish	No-Hub	Price
183928	834-6DNR	Nickel Bronze	6"	

Commercial Adjustable Cleanout—Cast Iron (Push-Joint Connection)

- Neoprene gasket, polypro plug with threaded brass insert included
- Over 1-1/2" of vertical adjustment available
- Nickel-bronze and tenzalloys covers for use in pedestrian traffic areas
- Cast iron covers for use in heavy duty applications
- **Push-joint connection is the same size as plug**



851-64N

Nickel Bronze Cover

Part #	Mfg #	Height	Conn.	Dia.	Price
183993	851-64N	4"-5-1/4"	4"	6"	
183994	851-66N	4-3/4"-6"	6"	8-3/8"	

Cast Iron Cover

Part #	Mfg #	Height	Conn.	Dia.	Price
183391	851-64I	5-1/4"-6-1/2"	4"	6"	

Accessories

Commercial Cleanout Cover Accessories

- 1/4" x 20 threaded wall bar carpet marker for cleanouts
- 1/4" x 20 cleanout cover screw

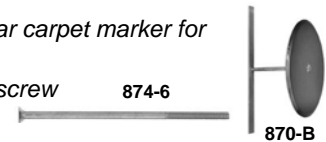

Threaded Wall Bar

Part #	Mfg #	Length	Price
152568	870-B	9"	

Cleanout Cover Screw

Part #	Mfg #	Finish	Length	Price
036902	874-3W	Epoxy White	3"	
184059	874-6	Stnlss Steel	6"	
154091	874-6W	Epoxy White	6"	

Commercial Wall Cleanout Cover Kit

- 20 Gauge stainless steel
- Available with 9" wall bar or countersunk brass plug

Cover, Screw and Countersunk Brass Plug (2-1/2" Screw Length)

Part #	Mfg #	Cover Dia.	Plug Size	Price
168952	873-460	6"	4" IPS	

Cover, Screw, and 9" Bar

Part #	Mfg #	Cover Dia.	Screw Size	Price
177008	870-B6	6"	6"	

Commercial Replacement Covers for Cleanouts

- Fits: 851 series
- Options: (B)
—Beveled edge for floor plate
—(not available on cast iron covers)

Part #	Mfg #	Finish	Dia.	Price
227379	851-CT8-B	Tenzalloy	8-3/8"	

Commercial Replacement Covers for Cleanouts

- Fits: 834 series, 852 series
- 3/16" Thickness

Nickel Bronze Cover with Screws

Part #	Mfg #	Dia.	Screws	Price
183999	852-CN3	5-1/8"	3-7/8"	
184000	852-CN4	6-1/8"	4-7/8"	

Concrete Mix & Gravel

QUIKRETE® All Purpose Gravel

- High quality clean gravel with an approximate top size of 3/8"
- Suitable for landscaping, concrete manufacture and a variety of other purposes
- Meets ASTM C33, standard specification for concrete aggregates



Part #	Mfg #	Size	Pack Qty	Price
116235	105521	50 lb Bag	56/Pallet	

QUIKRETE® Concrete Mix

- Pre-blended mixture of cement and aggregates for general structural uses, requiring only the addition of water
- Designed for pouring concrete 2" thick or more and building or repairing anything out of concrete



Part #	Mfg #	Size	Pack Qty	Price
004904	101356	60 lb Bag	56/Pallet	

QUIKRETE® Mortar Mix - Type N

- Construction grade mortar mix designed for laying brick, concrete masonry units and stone
- Pre-blended, sand product
- Just add water
- Standard formulation meets ASTM C 270 and C 1714 for type N mortar



Part #	Mfg #	Size	Pack Qty	Price
006485	100533	60 lb Bag	56/Pallet	

QUIKRETE® Sand Mix

- Consists of a uniformly blended mixture of Portland cement and commercial grade sands
- Used for repairing and topping damaged concrete surfaces less than 2" thick
- Just add water
- 5,000 psi



Part #	Mfg #	Size	Pack Qty	Price
009803	101231	60 lb Bag	56/Pallet	

Plumbing Miscellaneous



Concrete Mix & Gravel

Concrete Mix Cement Stop Leak

- Perfect for patching sewer outlet, water service and around drains
- Sets up in just five minutes
- Mixing cup included in each jar
- 5 lb. plastic jar



Part #	Mfg #	Description	Price
184082	963-05	5 lb. Plastic Jar	

Plumbing Miscellaneous



Fire Caulk & Fire Rated Boxes

Fire Rated Sealants

Roof and Flashing Sealant

- *Special bituminous composition with superior adhesion under the most severe weather conditions*
- *Heavy, paste-like consistency, easily applied with trowel or putty knife*
- *Adheres to wet/moist surfaces - can be applied in rain*
- *Forms durable, flexible, weatherproof coating*



Part #	Mfg #	Size	Price
135939	25403	10.3 oz	



Fire Caulk & Fire Rated Boxes

Firestopping Products

Metacaulk® 1000

- Water-based, highly intumescent, single-component, fire-rated general purpose sealant for through-penetrations
- For use on construction joints, both vertical and horizontal surfaces and interior use



Part #	Mfg #	Description	Price
022960	66640	10.3 oz Cartridge (12-Pk)	
141952	66312	20.2 oz Sausage Pack	

Fire Caulk & Fire Rated Boxes

Fire Caulk

Firestop 814+ Intumescent Firestopping Sealant

- Colored red for ease of inspection
- Fulfills residential and commercial Firestopping code requirements
- Resumes integrity for 1 and 2 hours fire rated assemblies
- Meets ASTM-E814/UL 1479 test standards



Part #	Mfg #	Description	Price
130726	J40-286	10.3 oz Tube	

DAP® Polyurethane Fireblock Foam Sealant

- For use in Type V residential construction
- Bright orange foam for easy code identification
- Expands 2-1/2 to 3 times its dispensed size
- 1 can of this expanding foam yields up to 15 large caulk tubes



Part #	Mfg #	Description	Price
177197	DAP44242	12 oz., Orange	

Fire Caulk & Fire Rated Boxes

Firestops

Type SSC Intumescent Firestop Collar

- *Pre-fabricated collar designed to seal combustible pipe penetrations in fire-rated walls and floors*
- *Galvanized metal collar houses a molded silicone rubber intumescent ring*
- *When the silicone material is heated to temperatures above 300°F, it will quickly expand to fill in the void caused by the collapse of softened pipes under fire conditions*
- *100% Intumescent silicone*
- *Patented char composite containing expanded graphite*
- *Tested at positive pressure to simulate the pressure differential that can occur in a fire situation*



Part #	Mfg #	Size	Color	Price
068779	360 12373	3"	Limestone	

Fire Caulk & Fire Rated Boxes

Fire Rated Enclosures

- Rating: 1-Hour ASTM E-119 F (non-load bearing)

Shallow Multi-Use Enclosure

- Ideal for:
 - Side-wall applications
 - Plumbing feeds
 - Dryer exhausts
 - Speakers
 - Low voltage controls/panels

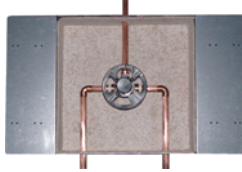

Part #	Mfg #	Dimensions	Price
143490	FN-Z-14-14-3	14" x 14" x 3"	

Ice Maker Kits

Ice Maker Installation Kit

- For ice makers, humidifiers, evaporate coolers
- Contains self-tapping valve, 25' of 1/4" tubing and all necessary fittings



Part #	Mfg #	Description	Price
002267	0130	Kit with Polyethylene Tubing (Poly Bag)	

Ice Maker Kits

Self-Piercing Tap Valve Kit

• For 3/8" - 1" OD tube

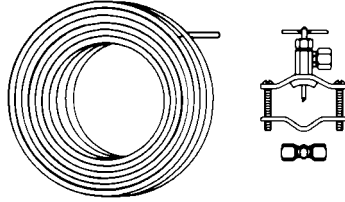

Part #	Mfg #	Comp x Outlet	Material	Price
002576	BC96X	1/4" OD x 25' L	Poly	

Plumbing Miscellaneous

Ice Maker Kits

EZ Quick™ Water Line Installation Kits

EZ Quick™ Ice Maker Kit

- Patented "tool-less" quick-connect
- Will not corrode
- 1/4-Turn shut-off
- Leak resistant
- Kink resistant PEX



Part #	Mfg #	Description	Price
144133	IMIK-01-25-P5	1/2" Valve w/25' Tube	

Plumbing Miscellaneous

Ice Maker Kits

Brass Ice Maker Needle Valves

Ice Maker or Humidifier Kit

- Self-piercing valve
- Brass fittings



Part #	Mfg #	Size	Description	Price
059628	S92-025	1/4" x 25'	Poly Tubing	

Knock Out Test Caps

Test Caps

Knockout Test Cap

- For use in plastic waste and drain pipe
- Disposable



Part #	Mfg #	Pipe Size	Price
070173	T33-001	1-1/2"	
068957	T33-002	2"	
068958	T33-003	3"	
068959	T33-004	4"	

Lavatory Insulation Kits

Lavatory Piping Covers

TRUEBRO® Lav Guard® 2 Fast-Fit Undersink Piping Covers

- For tubular and cast brass P-traps
- ADA Compliant
- Built-in E-Z grip and E-Z Tear-to-Fit trimming feature for installation without tools
- Valve cover completely encloses angle valve and supply tube for both handled and keyed water stops



Part #	Mfg #	Includes:	Price
010356	102EZ	(1) P-Trap Cover & (2) Angle Valve Covers	

Drain Kit

- For white offset tailpiece drain

Part #	Mfg #	Description	Price
010359	105W	1 Drain Kit	

Plumbing Miscellaneous

Lavatory Insulation Kits

Lav Shield® Lavatory Protective Enclosure

- ADA Compliant
- Heavy-duty, vandal-resistant, durable, single-piece construction
- Impact/stain/chemical-resistant, rigid vinyl



Part #	Mfg #	Color	Price
058688	2018	White	

Lavatory Insulation Kits

Pro-Extreme™ Protector Kits

- Molded PVC covers containing anti-microbial/anti-fungal & UV inhibitors
- Fastening system is tamper-resistant, smooth, non-abrasive snap-locks
- Dual drainage holes
- Internal flexible self-adjusting structures

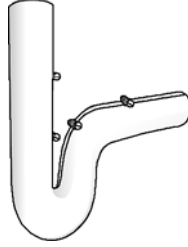

P-Trap Cover

Part #	Mfg #	Description	Price
103834	X4114	Wheelchair Offset Strainer Cover	
097293	X4333	(1) P-Trap Cover, (2) Valve & Supply Covers, Hardware	
101063	X4444	(1) P-Trap Cover, (1) Wheelchair Offset Strainer Cover, (2) Valve & Supply Covers, Hardware	

Plumbing Miscellaneous

Log Lighters

Log Lighters

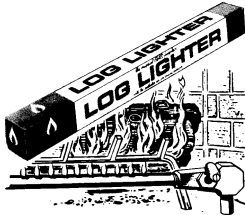

R321000

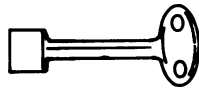

R322730

Part #	Mfg #	Description	Price
121683	R321000	Combo Pack "S" NG Chrome	
124212	R322730	12" Key with 1/4" + 5/16" Socket, Chrome	

Plumbing Miscellaneous

Log Lighters

Log Lighter Specialties

Hearthmaster™ Log Lighter Kit

- Angle and straight ball valve kits
- Quarter-turn style ball valves
- Log lighter bar, valve, flange and key installation in one convenient box
- Chrome-plated flange and 3-3/4" cast zinc key
- Each chrome-plated component is individually bagged
- Our kits can be customized to fit the specific needs of most any job
- Log lighter bar is for NATURAL GAS ONLY



Price	Mfg #	FIP Inlets	Flame Outlets	Valve	Price
071742	953	3	16	Angle	
184077	955	3	16	Straight	
184079	955-12	3	16	Straight	

Hearthmaster™ Straight Ball Valve



Part #	Mfg #	Flange	Key	Price
068706	954	Chrome-Plated	#949	

Plumbing Miscellaneous

Log Lighters

Log Lighter Parts & Accessories

Heater Furnace Log Lighter Key

- Die cast



Part #	Mfg #	Size	Stem Length	Price
008059	1707	5/16"	10"	

Spark Lighter

- Large hood
- Flints good for 1,500 ignitions

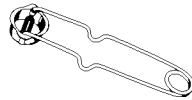

Part #	Mfg #	Description	Price
008103	4430	Lighter, 12/Pkg	

Plumbing Miscellaneous

Pans

Durapan™ Washer Pans

- Choice of center or side drain outlet
- Removable aluminum threshold for ease of washer placement
- Reinforced surface for "filled" washer
- Remains stationary - can be secured to floor
- Code approved material - per ASTM standards D635, E84, E162



Part #	Mfg #	Size	Drain	Price
023706	99	32"W x 30"L x 2-1/2"D	Center	

Plumbing Miscellaneous

Pans

Washing Machine Pans

- Provides lasting protection from washing machine overflow or hose failure
- Made from high impact plastic
- Will not rust or corrode
- Pans have formed hole to punch out for the furnished, 1" PVC plastic fitting



Part #	Mfg #	Description	Price
041357	34067	28" x 30" Plastic	

Water Heater Stands

- Allows the placement of water heater tanks 18" above the ground as required by the National Fuel Gas Code
- Constructed of 18 gauge spangled galvanized sheet metal, holds up to 50 gallon water heaters



Part #	Mfg #	Description	Price
027895	34057	21" Square x 18" High	

Water Heater Pans

Aluminum Water Heater Pan

- Manufactured from prime aluminum and are expertly worked to exact specifications under strict quality control
- Recommended for gas or electric water heaters
- Meets requirements of Southern Building Code
- Exposed edges have been rolled to protect the installer from injury



Part #	Mfg #	Size	Fitting	Price
042135	34079	18"	1" PVC	
121253	34152	22"	1" PVC	
166347	34154	26"	1" PVC	
023853	34083	24"	1-1/2" PVC	
023852	34085	30"	1" PVC	

Plastic Polymer Water Heater Pan

- Manufactured from semi-flexible, tough and durable .0625" plastic polymer
- Will not rust or corrode
- Meets requirements of Southern Building Code
- Pans pre-drilled to accommodate fittings
- Recommended for electric water heaters



Part #	Mfg #	Size	Fitting	Price
041353	34062	22"	1" PVC	
129896	34063	24"	1" PVC	
007960	34064	26"	1" PVC	

Water Heater Pan Adapter



Part #	Mfg #	Size	Price
089144	34088	1" PVC	

Plumbing Miscellaneous

Pans

Washing Machine Pans

- Heavy gauge plastic pan
- 2-1/2" Depth
- Southern Building Code approved



Part #	Mfg #	Description	Price
068960	J04-250	29" x 31" w/Side Mount Drain	

Water Heater Pans

Plastic Water Heater Safety Pan

- High impact plastic
- Supplied with 1" hookup adapter
- 2-1/2" Depth
- Easy hook up to any type drain
- Southern Building Code approved

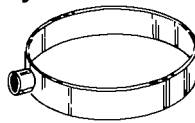

Part #	Mfg #	Bottom ID	Top ID	Price
068956	J36-022	22"	22-1/2"	
088854	J36-024	24"	25-1/2"	
088855	J36-026	26"	27-1/2"	

Water Heater Pan Adapter

- Washer and locknut
- Fits all Jones Stephens® pans



Part #	Mfg #	Size	Price
089255	J34-800	1" PVC	

Water Heater Run-Off Tube

- Electroplated fittings
- Temperature rating: 230°F
- UL Listed



Part #	Mfg #	Size	Description	Price
063537	J34-980	3/4" NPT	Top Mount	

Plumbing Miscellaneous



Putty

Putty

Plumber's Putty

- *Stainless, long lasting, easy to use*
- *Will not support bacteria*
- *Will not harden, shrink, crack or crumble*
- *Meets Federal Specification TT-P-1536A*



43031



043050



43107

Part #	Mfg #	Description	Price
017659	43031	Plumb Label, 14 oz	
008296	043050	Plastic Can, 3 lb	
017660	43107	Plumb Label, 5 lb	

Plumber's Epoxy Putty

- *Plugs, seals, mends, patches*
- *Excellent to rebuild or fabricate parts*
- *Use as an all-purpose adhesive*
- *Can be drilled, tapped, filed, sanded and painted*
- *Hardens like steel in 20 minutes*
- *Ideal for use underwater*
- *Non-toxic*



Part #	Mfg #	Description	Price
017671	44216	Plumb Label, 4 oz	

Plumbing Miscellaneous

Putty

Pipe Joint Compounds
SOFT SEAL™ Plumber's Putty

- For setting and sealing plumbing fixtures and drains
- Will not harden, crack or crumble
- Lead-free, non-corrosive and stainless
- 100% Waterproof



Part #	Mfg #	Model #	Size	Price
144693	80100	R5101	14 oz	
144695	80105	R5105	5 lbs	

Plumbing Miscellaneous



Putty

Putty

Sta Put® Plumbers Putty

- Flexible, stretchable, plastic putty that will not harden, crumble, crack or shrink
- Will not stick to fingers or hands



25105

Part #	Mfg #	Size	Price
095774	25103	3 lbs	
124148	25105	5 lbs	
124149	25110	7 lbs	

Sta Put® Ultra™ Stainless Plumbers Putty

- Oil-free and can be used without pre-treatment for natural, porous surfaces such as stone, marble, granite, plastics, rubber, fiberglass, grout on manufactured sinks, shower bases, countertops, etc
- Safe for most types of plumbing fixtures and surfaces
- Molds easily, remains permanently soft, malleable and flexible
- Will not melt, rot, crumble, dry out or shrink
- No greasy residue on hands or surfaces



Part #	Mfg #	Size	Price
136038	25171	14 oz	

Plumbing Miscellaneous

Putty

Sealants

THUM-GUM™ Sealing Compounds

- *Non-hardening putty for larger sealing jobs*
- *For plugging openings through foundations and refrigeration tube entry*
- *Does not contain asbestos*



Part #	Mfg #	Description	Price
002284	1003	1 lb Bag	
016079	1004	2 lb Box	

Plumbing Miscellaneous

Putty

Caulk Sealants

Tub and Tile Caulk

- *White, flexible, latex sealant*
- *Fills and seals cracks and joints*
- *For caulking around showers, tubs, lavatories and sinks*
- *Can be used to reset loose tiles*
- *Can be painted when dry with either oil base or latex paint*
- *Cleans up with soap and water*



Part #	Mfg #	Size	Price
008003	30240	6 oz, 24/Pk	

Plumbing Miscellaneous

Shock Arrestors

Water Hammer Arrestors

Hydra-Rester® Engineered Water Hammer Arrestor

- Certified by the American Society of Sanitary Engineering to the ANSI/ASSE 1010-2004 Standard
- Lifetime cycle tested at U.S. Testing Laboratories to withstand 10,000 shock cycles. Factory tested to withstand 500,000 cycles without failure (654-C tested)
- HydraRester™ male sweat fittings are compatible with press-fitting systems, such as Viega ProPress™ and all push-fitting systems
- Allows for installation in 2 x 4 wall cavity
- Installs at any angle
- ASSE 1010 certified as a water hammer arrester that is "designed to provide continuous protection, without maintenance" allowing the HydraRester to be installed without access panels

MIP Connection



Part #	Mfg #	L x W	Conn.	Price
010019	652-A	6-1/2"x1-3/8"	1/2"	
019089	653-B	8-3/4"x1-3/8"	3/4"	
025203	654-C	11"x1-3/8"	1"	
025204	655-D	10-1/8"x2-1/8"	1"	
041561	656-E	12-5/8"x2-1/8"	1"	
032465	657-F	15-1/8"x2-1/8"	1"	

Male Swt/Press Fitting



Part #	Mfg #	L x W	Conn.	Price
036311	652-AS	8-1/4"x1-3/8"	1/2"	
066491	653-BS	10"x1-3/8"	3/4"	
183768	654-CS	12-1/2"x1-3/8"	1"	
183770	655-DS	11"x2-1/8"	1"	
039380	656-ES	13-1/2"x2-1/8"	1"	

PEX Crimp ASTM F1807

Part #	Mfg #	L x W	Conn.	Price
183765	652-AX	6-1/2"x1-3/8"	1/2"	
183767	652-BX	8-3/4"x1-3/8"	3/4"	

Bullet™ No Lead Reducing Air Chamber

- Extra-large volume air chamber is spin reduced for 1/2" male sweat connection 629-12
- M copper type or L copper type (629-L15 & 629WCL)

Part #	Mfg #	Length	CTS	Price
183722	629-06	1"	6"	
183723	629-12	1"	12"	

MegaRester™ Industrial Water Hammer Arrester

- Dual o-ring piston lubricated with Dow 111 FDA approved silicone compound
- Cast brass flange, or wrought copper male thread fitting with lead-free solder joints
- 4" nominal Type L copper tube barrel
- 600 lb. (40 bar) liquid filled gauge
- Factory air charge
- Measurement information:
 - Volume (V) Inches³
 - Height (H) Inches

Part #	Mfg #	V x H	MIP	Price
174511	658-1503	150x23.25	3"	
174512	658-2002	200"x29.25"	2"	
126344	658-4004	400"x40.50"	4"	

Plumbing Miscellaneous

Shock Arrestors

MiniRester™ Residential Water Hammer Arrestor (Straight—No Lead)

- Straight sweat arresters are compatible with press-fitting systems, such as Viega ProPress™ and all push-fitting systems **660-X2B**
- Straight compression arresters install on any 1/2" nom. copper leg or riser and are especially popular in retrofitting 1/2" nom. air chambers
- MIP thread arresters install on any new rough-in or retrofit installation with 1/2" FIP fittings
- CPVC solvent weld arresters install on 1/2" CPVC tube or fittings in rough-in or retrofit applications
- PEX MiniResters™ are available with F1807, F1960 and Viega® PexPress® connections
- Products marked with the "No Lead" icon comply with national, no lead product material requirements and also comply with NSF 61, which allows the product to contain no more than 0.25% lead
- All MiniResters are AA size



With Clamshell

Part #	Mfg #	Connection	Price
010023	660-G2	1/2" MIP Thread	
183772	660-C	5/8" OD Comp	

Without Clamshell

Part #	Mfg #	Connection	Price
183778	660-X2B	1/2" F1807 PEX	

MiniRester™ Residential Water Hammer Arrestor (Female Compression Tee)

- No lead
- Installs either between stub out and supply stop, or between supply stop and supply tube for faucets, dishwashers, toilets or ice makers

With Clamshell

Part #	Mfg #	OD Comp X OD Fml Comp	Price
223384	660-GTR	5/8" x 5/8"	
183775	660-GTR1	3/8" x 3/8"	

MiniRester™ Residential Water Hammer Arrestor (PEX Tee)

- Great for in-line PEX installation for quick closing faucets
- ASTM F1960
- No lead

Part #	Mfg #	Description	Price
183776	660-GTW2B	1/2" PEX Cold Expansion	

MiniRester™ Residential Water Hammer Arrestor (Compression Tee)

- Install in-line on ice maker lines, lavatory or dishwasher supply tubes

With Clamshell

Part #	Mfg #	For:	O.D.	Price
183773	660-T	1/2" Nom. Copper Tube	5/8"	
161222	660-TCO	Ice Maker Tube	1/4"	

MiniRester™ Residential Water Hammer Arrestor (Tee)

- Full slip tee sweats in-line on 1/2" CTS near problem valve or fixture
- Hose tee arresters install on washing machine supply valves or directly to washing machine

With Clamshell

Part #	Mfg #	Size	Price
010021	600-H	3/4" (Female Swivel Hose Thread X Male Hose Thread)	
090564	600-TK	Female Swivel Ballcock Nut x Male Ballcock Thread Tee	

Plumbing Miscellaneous

Shock Arrestors

MiniRester™ Residential Water Hammer Arrester (Tub/Shower Valve)

- Sweat branch arresters install easily on sweat tub/shower valves
- FIP swivel thread arresters install on MIP tub/shower valves. No more heat damaged cartridges from soldering valve



Part #	Mfg #	Open End Branch X Tee	Price
183777	660-TS	1/2" Male Swt x 1/2" FSwt	

StubAir™ Air Chamber Tee Fitting—Spin Closed

- 1/2" CTS No lead
- Turns variable job-to-job costs like measuring, cutting, cleaning, fluxing and soldering of up to four joints into fixed costs
- Sturdy, fracture-resistant brazed saddle joint will not be damaged during field soldering
- Optional branch length, branch end and trunk size for many different job site applications
- Guaranteed leakproof spin closures and brazed joints
- (L) L copper type or (M) M copper type



Part #	Mfg #	Air Chamber	Branch	Price
183795	682-L5140	8"	12"	
183796	682-M5140	8"	12"	

Shock Arrestors

Shock Arrestors

Series SG Shok-Gards Copper Shock Arrestor

- PDI Certified
- Pre-charged with brass piston, EPDM o-ring and male IPS threaded connection
- Operating pressure: Domestic and commercial lines up to 150 psi
- Temperature range: 33° - 180°F



Part #	Mfg #	PDI Rating	Fixture Unit Capacity	Pipe Size	Price
046336	SG-050	A	1 - 11	1/2"	
046340	SG-075	B	12 - 32	3/4"	

Stainless Steel Shock Arrestor

- Pre-charged stainless steel arrestor
- Male IPS threaded connection
- Temperature range: -100° to 300°F
- Operating pressure: Domestic and commercial lines up to 15 psi
- Stainless steel elbows



Part #	Mfg #	PDI Rating	Fixture Unit Capacity	Pipe Size	Price
046341	SG-C	C	33 - 60	1"	
052624	SG-D	D	61 - 113	1"	

Water Hammer Arrestor

- Pre-charged air chamber
- Sealed in diaphragm
- Complete stainless steel chamber construction
- Rechargeable



For residential/domestic water systems only

Part #	Mfg #	Description	Price
225413	LF150A	1/2"	

Plumbing Miscellaneous

Stud Guards

Stud Guards

- Provide protection for pipes and wiring installations
- Special self-nailing feature
- Made of 18 gauge steel

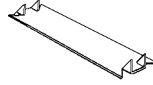

Part #	Mfg #	Description	Price
010005	33930	1-1/2" x 3", 2-1/2" Between Points	
010006	33931	1-1/2" x 5", 4-1/2" Between Points	

Stud Guards

Stud Guards & Plates

Stud Shoe Bracket

- 16 Gauge steel
- Formed rib provides added strength
- Installs over pipe up to 2-3/8" O.D.
- Meets IRC 602.6



533-1

Part #	Mfg #	Studs	Size	Price
091708	533-1	Single	1.58"	
183450	533-2	Double	3.125"	
183451	533-3	Triple	4.7"	

BOCA Shield Plate with Nail Holes

- Available in 16- or 18-gauge material
- Model (536-616) is galvanized



536-09

Part #	Mfg #	Size	Holes	Gauge	Price
183469	536-09	1-1/2"x9"	8	16	
183470	536-12	1-1/2"x12"	8	16	
010007	536-18	1-1/2"x18"	16	16	
165086	536-616	6"x16"	2	16	
047221	538-09	1-1/2"x9"	8	18	
010008	538-12	1-1/2"x12"	8	18	
083337	538-18	1-1/2"x18"	8	18	
078419	SC53918	3-1/2"x18"	16	16	

Stud Guard

- Available in 16-gauge or 18-gauge material
- 530-6M is ideal for metal stud projects



530-1635

Part #	Mfg #	Size	Nails	Gauge	Price
033537	530-6	1-1/2" x 6"	Self-Nailing	18	
117970	530-6M	1-1/2" x 6"	Nail Holes	16	
080518	530-1635	3" x 5"	Self-Nailing, Double	16	
179567	536-36	3-1/2" x 6"	Self-Nailing	16	
080814	536-58	5" x 8"	Self-Nailing w/Holes	16	
183472	536-68E	6" x 8"	Offset Self-Nailing	16	

Plumbing Miscellaneous

Stud Guards

Stud Protectors

Stud Shoe

- 18 Gauge galvanized
- Pipe opening accommodates 2" IPS or smaller pipe
- (4) Nail holes on each side

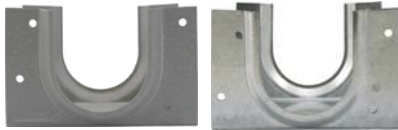

S33-022

S33-023

Part #	Mfg #	Description	Price
073637	S33-021	Single Stud Shoe	
073638	S33-022	Double Stud Shoe	
073639	S33-023	Triple Stud Shoe	

Test Plugs & Balls

Test Caps

Techno Test Plug Cap

- Heavy-duty PVC, high pressure tested over six stories
- Easily solvent cemented over end of DWV pipe
- Will not clog or go down pipe



Part #	Mfg #	Size	Price
059946	T35-001	1-1/2" DWV	
059947	T35-002	2" DWV	
195927	T35-003	3" DWV	
114391	T35-004	4" DWV	

Test Plugs

Economy Test Plug

- Fits cast iron and plastic pipe
- Molded rubber gasket
- Galvanized steel flanges



Part #	Mfg #	Pipe Size	Price
103921	T31-004	4"	

Combination Test Plug *Test up to 3 floors at once*

- Combo test plug & Cleanout
- No metal parts to rust



Part #	Mfg #	Size	Price
155015	T34002	2"	
155016	T34003	3"	
155017	T34004	4"	

Test Plugs & Balls

Pneumatic Test Plugs

Standard Pressure Relief Pneumatic Test Plug

- Automatically resets for each inflation
- Pressure relief has no moving parts
- One-piece rubber portion is molded with no seams or bonded parts
- Works in place of other "standard" pneumatic plugs
- Maximum back pressure water head: 30', Air 13 psig
- 3-Year limited warranty



Part #	Mfg #	Size	Price
132243	83764	1-1/2"	
132244	83765	2"	
132245	83766	3"	
132246	83767	4"	

Mechanical Test Plugs

Mechanical Cleanout Test Plug

- Used in cleanout to test up to 40 vertical feet of pipe
- Clear cap for visual monitoring
- Expandable rubber gasket for air and water tight seal



Part #	Mfg #	Size	Price
131978	83656	2"	
131979	83657	3"	
131980	83658	4"	

Flush Mechanical Cleanout Repair Plug

- Holds up to 50' of back pressure
- Seals air tight (does not rely on threads to seal)
- Back pressure actually increases sealing ability
- Completely flush inside and out
- Stainless steel flat head screw
- Cannot fall into the pipe
- Includes wrench

Part #	Mfg #	Size	Price
106904	83687	2"	

Plumbing Miscellaneous

Test Plugs & Balls

Parts & Accessories

Studor® Flush Cleanout Repair Plug



Part #	Mfg #	Size	Price
106906	83688	3"	
106907	83689	3-1/2"	
106908	83690	4"	



Test Plugs & Balls

Pneumatic Pipe Plugs

Test-Ball® Plug with Removable Chain

- Durable, rugged and effective in any type of pipe
- 1/4" Schrader tire valve standard on all plugs
- All Test-Balls® are bendable to 90°



Part #	Mfg #	Nominal Size	Plug Length	Price
002967	270016	1-1/4" - 1-1/2"	5.50"	
002969	270024	2"	3.50"	
002972	270032	3"	5.25"	
002975	270040	4"	6.50"	
024619	270067	6"	9.00"	
160947	276128	1-1/4"-2"		
154317	041408	12"		
225991	276238	2" - 3"		

Muni-Ball® Plugs (Underground)

- Works in all types of pipe.
- Easily converts to an air test plug with use of a conversion kit
- Durable natural rubber construction seals the roughest of surfaces
- 8", 10", 12" and 15" plugs include two-port plug for easy use in sewer air tests
- Threaded aluminum bypass



Part #	Mfg#	Size	ByPass	Price
226286	262010	2"	1/8"	

Long TEST-BALL®

- Maximum pressure: 13 psi



Part #	Mfg #	Size (Nom)	Price
020961	271047	4"	

Clean Seal Plugs



Part #	Mfg #	Size	Price
090297	271508	1-1/2"	
002968	271705	2"	
002971	271713	3"	
034376	271721	4"	

Clean-Seal 2® Plugs

- Patent pending design
- Plug, fill and drain from same cleanout tee.
- Multi-lobe gasket allows sealing of all tees including cast iron
- Hand-tighten in place, no tools required
- Rubber cap protects hose connection when not in use.
- Check-valve allows removal of hose after filling system and keeps DWV water from back-filling into potable lines



Part #	Mfg #	Size	Price
187666	271828	2"	
187667	271838	3"	
187668	271848	4"	

Mechanical Pipe Plugs

Hub-Fit Gripper™ Plug

- Natural rubber o-ring
- Yellow glass-reinforced ABS plastic
- Pressure rated to conducting DWV tests
- For use in hub fittings and bell-end pipe
- Galvanized carriage bolt



Part #	Mfg #	Size	Price
035625	270528	2"	
090565	270538	3"	

Plumbing Miscellaneous



Test Plugs & Balls

Kwik'N Sure® Plug

- Works on all types of pipe
- Wint nut on 3/8" - 1-1/4" sizes
- Hex nut on 1.5" through 5" sizes
- Natural rubber o-ring



Part #	Mfg #	Size	Price
172874	269840	1/2"	
092561	269883	1-1/4"	

End of Pipe Gripper® Plug



Part #	Mfg #	Size	Price
002965	270210	1-1/2"	
002970	270229	2"	
002973	270237	3"	
002976	270245	4"	
002977	270261	6"	

T-Handle Aluminum Gripper® Plug (Underground)

- Can be used in long-term applications
- Chemical-resistant neoprene O-ring
- Made of heavy-duty aluminum



Part #	Mfg #	Size	Price
225370	272922	12"	

Clean - Out Gripper® Plug

- Seals any damaged threads
- Made with glass-reinforced ABS plastic
- Black color blends with cast-iron pipe
- Stainless steel hardware
- NPT Sizes
- Natural rubber threaded o-ring for positive seal
- Maximum back pressure: 17 psi @ 40'



Part #	Mfg #	Nom Size	Price
063070	270178	3"	
078393	270138	3-1/2"	
063071	270188	4"	

Test Pumps

Air Max® Test Pump

- Gauge raised from base for protection
- Durable steel barrel
- Textured steel base prevents pump from slipping
- Durable, no-kink hose
- Weight: 3.6 lbs



Part #	Mfg #	Description	Price
052322	273958	Air-Max Test Pump	

Accessories

Inflation Fitting



Part #	Mfg #	Description	Price
138040	277037	Valve, Snifter & Cap	

Extension Hose

- Suited for plugs up to 15"
- 3/16" ID Hose



Part #	Mfg #	Size	Price
002974	274038	3'	
226449	274208	20'	

Replacement Hose Assembly

- With thumb lock



Part #	Mfg #	Description	Price
054562	034588	For Air-Max™	

Test Plugs & Balls

Test Caps

MS End-Cap™ Test Cap

- Seal pipe ends economically
- For use on schedule 40 ABS and PVC DWV pipe



Part #	Mfg #	Size	Back Pressure PSI	Feet of Head	Ctn Qty	Price
132445	33478	1-1/2" - 2"	15	40'	50	

Knock-Out™ Plug, ABS

- Solvent weld cap designed for use on Sch40 ABS or PVC DWV piping for testing up to 17PSI or 40' head pressure
- Knock-Out center of test cap can be removed with "tab" to prevent possible blockage in piping

Part #	Mfg #	Size	Ctn Qty
190303	33461	2"	100

Test Gauges

Cherne Test Gauge with Hexagonal Test Body

- 2" Plastic face
- Chrome plated body
- 1/8" Schrader valve
- 3/4" NPT Pipe connection



Part #	Mfg #	Pressure Range	Price
098893	19698	0-30 psi	

Plumbing Miscellaneous

Test Plugs & Balls

"Sure Test" Inflatable Econo Test Plugs

- "Grip-Rib" Design acts as a suction cup
- Hard rubber ends are molded inside the plug with o seams, to prevent stem and end blow-off
- All brass tire stem valves are uniquely molded in plug end - prevents stem from being pulled off
- Durable chain eye is molded as part of plug
- Pull chain is strong, steel sash
- Inflation and back pressure information permanently molded in plug
- Maximum back pressure: Air 10 PSIG, Water 30' Hd.
- 30 psi Maximum plug inflation
- With rubber flange that grips end of pipe
- 3" & 4" Test plugs supplied with Superfly wing nut
- For plastic, cast iron DWV
- Made in USA

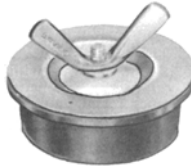

Part #	Mfg #	Description	Price
094178	4801	1" Test Plug	
051054	4802	1-1/4" Test Plug	
094179	4803	1-1/2" Test Plug	
094180	4804	2" Test Plug	
094181	4806	3" Test Plug	
094182	4808	4" Test Plug	

Plumbing Miscellaneous

Test Plugs & Balls

Test Plugs & Caps

Quick Plug™ Trap Adapter Test Plug

- Eliminates traditional test plugs
- Allows fitting the trap adapter tightly against the wall
- Requires use of 1-1/2" slip joint washer-sold separately



Part #	Mfg #	Size	Price
100451	234-QP	1-1/2"	

Test Titan™ Cleanout Test Plug

- Seals 1-1/2" - 4" female cleanout threads
- Ideal for use on damaged cleanout openings and damaged or deteriorated threads



Part #	Mfg #	Size	Price
031656	882-35	3-1/2"	

Test Titan™ Mechanical Test Plug

- Back to front wedge design prevents blowouts at high and low temperatures
- Provides leak-free seal
- Non-slip shoulder



Part #	Mfg #	Size	Price
089876	882-1	1-1/2"	
048035	882-2	2"	
048036	882-3	3"	

Grip Tip™ Test Cap and Test Plug

- Test nipple is 1/2" CTS (5/8" OD)
- Durable, virgin ABS may be glued to pipe with all-purpose glue
- Tip acts as a handle while applying glue and can be snipped to allow filling and bleeding with water or air for testing
- Deeper glue surface ensures a good seal especially on unevenly cut pipe



880-82

Part #	Mfg #	Size	Type	Color	Price
111243	880-81	1-1/2"	Cap	White	
086044	880-82	2"	Cap	White	
086045	880-83	3"	Cap	White	
073910	881-10	1-1/2"	Plug	White	

Plumbing Miscellaneous

Test Plugs & Balls

Test Assemblies

Combination Air and Water Test Assembly

- 3/4" Female hose swivel
- Schrader valve and 1/4-turn valve



Part #	Mfg #	PSI	Price
139409	360-300PK1	300	

Double Duty™ Test Plug

- Double Duty™ seals drain for DWV pressure test and shower pan water test
- Plug is easy to install and remove, eliminates reaching through the collar to remove test caps
- No blow-up balls, no glue-in wafers, no mechanical plugs



Part #	Mfg #	For:	Price
224912	821-TP	821 Series Drains	

Dual Fit Knockout Test Plug & Cap

- Standard knockout test plugs solvent weld into PVC or ABS Sch. 40 pipe 880-012
- Dual fit knockout test caps solvent weld over 1-1/2" and 2", or 3" and 4" PVC or ABS Sch. 40 pipe



Part #	Mfg #	Sch. 40 Cap Connection	Price
184068	880-012	1-1/2" and 2"	
153147	880-034	3" and 4"	

HandTite™ Mechanical Test plug

- For 4" – 6" models, use 3/4" male garden hose thread adapter and drill-out wall on stem for water or air by-pass tests
- For 8" model, tap stem 1/2" NPT and drill through bulk head to allow for water or air by-pass tests
- Nylon body and ASTM 361 rubber gasket

Part #	Mfg #	Diameter	Price
184071	882-98	8" Large	

TeePee™ Mechanical Cleanout Tee Test Tool

- Designed to work on cast iron as well as plastic pipe waste systems
- No couplings to install and remove
- Perfect for high rise construction —will hold 14 floors of pressure
- Completely mechanical device —no air compressor/pump required
- Replacement seals available
- Not recommended for installations where temperatures are below 32°F
- 6" and 8" tools must be retrofitted with legs (included) for Charlotte pipe tees



881-53

Part #	Mfg #	Size	Price
184069	881-52	2"	
184070	881-53	3"	
123470	881-54	4"	



Test Plugs & Balls

Flood-Guard™



Part #	Mfg #	Description	Price
023693	2F	2" Float Model	
023904	3F	3" Float Model	
023905	4F	4" Float Model	

Test Plugs & Balls

Floor Drain Stoppers



Part #	Mfg #	Description	Price
135215	R153905	1-1/4" TwisTite	
135216	R153910	1-1/2" TwisTite	
135217	R153920	2" TwisTite	
135218	R153930	2-1/2" TwisTite	
135220	R153950	3-1/2" TwisTite	
135221	R153960	4" TwisTite	

Plumbing Miscellaneous

Vents

Vents

Maxi Vent®

- Vents up to 500 DFUs



Part #	Mfg #	Description	Price
034397	20342	Fits 3" to 4" stack vent	

Plumbing Miscellaneous

Vents

Air Admittance Valve Vents

- Eliminates extensive piping to the exterior for the individual, common, wet, loop, circuit island and stack vents
- Compatible with all DWV piping materials

Mini-Vent® Valve Vent

- Can be used as an individual branch, circuit or stack vent
- Will vent up to 24 DFUs on a stack and up to 160 DFUs on a branch
- Fits 1-1/2" and 2" pipe sizes
- Reduces the number of fire-stopping applications
- Exclusive vermin protection system
- Limited lifetime warranty for replacement of defective valves



Part #	Mfg #	Description	Price
034396	20341	Mini-Vent® for PVC 24/Pk	

Plumbing Miscellaneous



Vents

Chrome Plated Brass Air Cocks

Brass Polished Air Cock (FIP x FIP)

- Tee handle, round shoulder

Part #	Mfg #	Size	Price
013504	09338-04	1/4"	

Vents

Valves

Sure-Vent® Air Admittance Valve - 160DFU

- For use as a secondary vent



Part #	Mfg #	Description	Price
095161	39220	2" x 3", PVC 40 Adapter	

Sure-Vent® Air Admittance Valve - 500DFU

- For use as a secondary vent



Part #	Mfg #	Description	Price
143619	39223	3" x 4", PVC 40 Adapter	

Sure Vent® II Air Admittance Valve



Part #	Mfg #	Description	Price
063037	39016	1-1/2" with 1-1/2" to 2" PVC Adapter	

In-Line Vent

- Mechanical vent installs on the drain line and vents the line without allowing sewer gas to enter the home
- For venting sinks, tubs, showers, washing machines, etc.
- Eliminates the need for secondary stacks



Part #	Mfg #	Description	Price
010710	39012	ABS	

Plumbing Miscellaneous

Vents

Provent

- For manufactured housing and RV's only
- Automatic anti-siphon trap vent used as secondary venting
- Must be located at least 60" above trap arm
- Three or more fixtures must be drained by 2" line
- Hand tighten, no thread seal needed
- Do not install in sealed wall cavity
- 1-1/2" MPT Threads



Part #	Mfg #	Description	Price
042008	P21-150	1-1/2" Provent	

Vents

Air Gaps

Polypro Air Gap

- Prevents sewage backflow by breaking siphoning action in drain line
- White polypro body with chrome-plated ABS top
- UPC Approved



Part #	Mfg #	Description	Price
005870	A10-001	ABS Cap, CP	

Vents

Vents

Anti-Siphon Auto Vent

- For secondary venting only. Each drainage system must have a main vent stack
- Sealing disc of auto vent must be located at least 6" above the top of the trap arm
- To be installed in a readily accessible location with free flow of air, never in a sealed wall cavity
- Two fixtures may be drained by a common 1-1/2" drain pipe. Three or more fixtures will require a 2" drain pipe



Part #	Mfg #	Connection	Material	Price
183381	239	1-1/2" MIP	ABS	

Air Admittance Valves

TurboVent™ Residential Air Admittance Valve (PVC Sch. 40 Hub Connection)

- Actuating device within the unit spins with each activation, keeping the seal free of dust and debris
- Each unit is available with DWV adapter
- Quick opening air valve at 0.01" negative pressure. Positive seal with 13 PSIG of back-pressure
- Protective debris cover ships with each unit
- New contractor packs available



250-11P

With Adapter

Part #	Mfg #	Conn.	Stack	Branch	Price
156566	250-11P	1-1/2" PVC	8	20	
166318	250-12P	2" PVC	24	160	

Plumbing Miscellaneous

Pan Lining, Solvent, & Sheet Lead

Shower Pan Liners

PVC Shower Pan Liner

- Economical, time-tested flexible pan liner
- Available in 30 and 40 mil thickness
- Liner marked in 6" increments for ease of measuring
- Dam corners available
- Meets ASTM Spec D4551
- Superior cold weather characteristics



Part #	Mfg #	Size	mil	Color	Price/Ft
008001	41596	4' x 50'	40	Gray	
008002	41597	5' x 40'	40	Gray	
008004	41601	6' x 50'	40	Gray	

CPE Shower Pan Liner

- Original flexible pan liner
- Available in 40 mil thickness
- Liner marked in 6" increments for ease of measuring
- Meets ASTM Spec. D4068



Part #	Mfg #	Size	mil	Color	Price/Ft
177674	41587	6' x 33'	40	Black Roll	

Shower Pan Dam Corner

- For use at junction of curb and door jamb
- Universal right/left design



Part #	Mfg #	Description	Price
062140	41602	PVC 40 mil Each	

X-15 PVC Solvent

- Specially formulated for extended working times
- Provides exceptional sheet to sheet bonding



Part #	Mfg #	Description	Price
007955	30812	16 oz with Dauber	

Showers

Fiberglass Showers

Fiberglass Shower Modules

- Sanitary grade polyester gel coat surface
- 3-3/8" Diameter drain
- Textured floor pattern
- Balsa wood core floor structure

SH-4836 Vursa Series 1-Pc Fiberglass Shower Module

- Rough-in dimensions: 76-3/4" x 48" x 37-1/4"
- Low profile dam standard
- Twin, elevated corner accessory towers
- Generous back wall shelving
- Flat wall design to accommodate grab bar applications
- Center, lower accessory shelf with wash cloth rod



Part #	Mfg #	Description	Drain	Finish	Price
118012	SH-4836-WHT	75-1/2" x 48" x 36"	Center	White	

SH-4836 Vursa Series 1-Pc Fiberglass Shower Module with Seat

- Rough-in dimensions: 76-3/4" x 48" x 37-1/4"
- Low profile dam standard
- Elevated corner accessory tower
- Multi-level back wall shelving
- Single, ergonomic seat
- Ergonomic corner foot rest for shaving
- Flat wall design to accommodate grab bar applications
- Center, lower accessory shelf with wash cloth rod



Part #	Mfg #	Description	Seat	Drain	Finish	Price
137867	SH-4836LS-WHT	75-1/2" x 48" x 36"	LH	Center	White	
137863	SH-4836RS-WHT	75-1/2" x 48" x 36"	RH	Center	White	
137869	SH-4836LS-BSC	75-1/2" x 48" x 36"	LH	Center	Biscuit	
137866	SH-4836RS-BSC	75-1/2" x 48" x 36"	RH	Center	Biscuit	

SH-4836 ABF Vursa Series 1-Pc Fiberglass Shower Module with Seat

- Rough-in dimensions: 76-3/4" x 48" x 37-1/4"
- Low profile dam standard
- Elevated corner accessory tower
- Multi-level back wall shelving
- Single, ergonomic seat
- Ergonomic corner foot rest for shaving
- Flat wall design to accommodate grab bar applications
- Center, lower accessory shelf w/wash cloth rod
- ABF = Above floor rough-in provides 3" drain clearance

Part #	Mfg #	Description	Seat	Drain	Finish	Price
114536	SH-4836LS ABF-WHT	75-1/2" x 48" x 36"	LH	Center	White	
114535	SH-4836RS ABF-WHT	75-1/2" x 48" x 36"	RH	Center	White	

Fiberglass Showers

Fiberglass Shower Modules (Continued)

SH-4836 ABF Vursa Series 1-Pc Fiberglass Shower Module with Seat

Part #	Mfg #	Description	Seat	Drain	Finish	Price
116317	SH-4836LS ABF-BSC	75-1/2" x 48" x 36"	LH	Center	Biscuit	
116316	SH-4836RS ABF-BSC	75-1/2" x 48" x 36"	RH	Center	Biscuit	

SH-6036 Vursa Series 1-Pc Fiberglass Shower Module with Seat

- Rough-in dimensions: 76-3/4" x 60" x 37-1/4"
- Low profile dam standard
- Elevated corner accessory tower
- Multi-level back wall shelving
- Single, ergonomic seat
- Ergonomic corner foot rest for shaving
- Flat wall design to accommodate grab bar applications
- Center, lower accessory shelf with wash cloth rod



Part #	Mfg #	Description	Seat	Drain	Finish	Price
118141	SH-6036LS-WHT	75-1/2" x 60" x 36"	LH	Center	White	
118140	SH-6036RS-WHT	75-1/2" x 60" x 36"	RH	Center	White	
118138	SH-6036LS-BSC	75-1/2" x 60" x 36"	LH	Center	Biscuit	
118139	SH-6036RS-BSC	75-1/2" x 60" x 36"	RH	Center	Biscuit	

SH3P-4834 Vursa Series 3-Pc Fiberglass Shower Module with Seat

- Rough-in dimensions: 76-3/4" x 48" x 35-1/4"
- Anti-drip front dam ledge
- Corner accessory ledge
- Multi-level back wall shelving
- Single, ergonomic seat
- Ergonomic corner foot rest for shaving
- Wall design accommodates grab bar applications
- Textured floor pattern

Part #	Mfg #	Description	Seat	Drain	Finish	Price
149155	SH3P-4834LS-WHT	75-1/2" x 48" x 34"	LH	Center	White	
149156	SH3P-4834RS-WHT	75-1/2" x 48" x 34"	RH	Center	White	

SH3P-4834 ABF Vursa Series 3-Pc Fiberglass Shower Module with Seat

- Rough-in dimensions: 76-3/4" x 48" x 35-1/4"
- Anti-drip front dam ledge
- Multi-level back wall shelving
- Single, ergonomic seat
- Ergonomic corner foot rest for shaving
- Wall design accommodates grab bar applications
- Textured floor pattern
- ABF = Above floor rough-in provides 3" drain clearance

Part #	Mfg #	Description	Seat	Drain	Finish	Price
133743	SH3P-4834LS ABF-WHT	75-1/2" x 48" x 34"	LH	Center	White	

Fiberglass Showers

Fiberglass Shower Modules (Continued)

SH3P-4834 ABF Vursa Series 3-Pc Fiberglass Shower Module with Seat

Part #	Mfg #	Description	Seat	Drain	Finish	Price
133744	SH3P-4834RS ABF-WHT	75-1/2" x 48" x 34"	RH	Center	White	

SH3P-6030 Vursa Series 3-Pc Fiberglass Shower Module with Seat

- Rough-in dimensions: 76-3/4" x 60" x 31-1/4" with 4" dam
- Elevated corner accessory tower
- Multi-level back wall shelving
- Single, ergonomic seat
- Ergonomic corner foot rest for shaving
- Flat wall design to accommodate grab bar applications
- Center, lower accessory shelf with wash cloth rod



Part #	Mfg #	Description	Seat	Drain	Finish	Price
142474	SH3P-6030L-RS-WHT	75-1/2" x 60" x 30" with 4" Dam	LH	RH	White	
142783	SH3P-6030R-LS-WHT	75-1/2" x 60" x 30" with 4" Dam	RH	LH	White	

SH3P-6032 Vursa Series 3-Pc Fiberglass Shower Module with Seat

- Rough-in dimensions: 76-3/4" x 60" x 33-1/4" with 4" dam
- Elevated corner accessory tower
- Multi-level back wall shelving
- Single, ergonomic seat
- Ergonomic corner foot rest for shaving
- Flat wall design to accommodate grab bar applications
- Center, lower accessory shelf with wash cloth rod



Part #	Mfg #	Description	Seat	Drain	Finish	Price
136661	SH3P-6032L-RS-WHT	75-1/2" x 60" x 32" with 4" Dam	LH	RH	White	
136659	SH3P-6032R-LS-WHT	75-1/2" x 60" x 32" with 4" Dam	RH	LH	White	
136662	SH3P-6032L-RS-BSC	75-1/2" x 60" x 32" with 4" Dam	LH	RH	Biscuit	
136660	SH3P-6032R-LS-BSC	75-1/2" x 60" x 32" with 4" Dam	RH	LH	Biscuit	

SH3P-6032-ABF Vursa Series 3-Pc Fiberglass Shower Module with Seat - Above Floor Rough

- Rough-in dimensions: 76-3/4" x 60" x 33-1/4" with 4" dam
- Elevated corner accessory tower
- Multi-level back wall shelving
- Single, ergonomic seat
- Ergonomic corner foot rest for shaving
- Flat wall design to accommodate grab bar applications
- Center, lower accessory shelf with wash cloth rod
- ABF = Above floor rough-in provides 3" drain clearance



Part #	Mfg #	Description	Seat	Drain	Finish	Price
150330	SH3P-6032R-LS-ABF-WHT	75-1/2" x 60" x 32" with 4" Dam	RH	LH	White	

Fiberglass Showers

Fiberglass Shower Modules (Continued)

SH3P-6032-ABF Vursa Series 3-Pc Fiberglass Shower Module with Seat - Above Floor Rough

Part #	Mfg #	Description	Seat	Drain	Finish	Price
150329	SH3P-6032L-RS-ABF-BSC	75-1/2" x 60" x 32" with 4" Dam	LH	RH	Biscuit	

SH-3 1-Pc Fiberglass Shower Module

- Rough-in dimensions: 78" x 36" x 37"
- Twin/elevated corner shelves



Part #	Mfg #	Description	Drain	Finish	Price
145794	SH-3-WHT	76-3/4" x 36" x 35-3/4"	Center	White	
092385	SH-3-BSC	76-3/4" x 36" x 35-3/4"	Center	Biscuit	

SH-5 1-Pc Fiberglass Shower Module

- Rough-in dimensions: 77-1/2" x 60" x 35-1/4"
- Elevated back wall shelves
- Acrylic towel rod
- Textured floor pattern



Part #	Mfg #	Description	Drain	Finish	Price
085796	SH-5-WHT	76-1/4" x 60" x 34"	Center	White	

SH-BMW-4 ABF 1-Pc Fiberglass Shower Module

- Rough-in dimensions: 78-1/2" x 42" x 35-1/4"
- Twin/elevated back wall shelves
- ABF = Above floor rough-in provides 3" drain clearance



Part #	Mfg #	Description	Drain	Finish	Price
092380	SH-BW-4 ABF-WHT	77-1/4" x 42" x 34"	Center	White	

Showers

Fiberglass Showers

SH-DS-4 1-Pc Fiberglass Shower Module

- *Rough-in dimensions: 77-3/4" x 48" x 34-7/8"*
- *Twin/contoured corner seats*
- *Dual/elevated shelves*
- *Lower level soap tray with acrylic rod*



Part #	Mfg #	Description	Seat	Drain	Finish	Price
099805	SH-DS-4-WHT	76-1/2" x 48" x 35-5/8"	Twin Corner	Center	White	

SH-DS-5 1-Pc Fiberglass Shower Module

- *Rough-in dimensions: 77-3/4" x 60" x 38-5/8"*
- *Twin/contoured corner seats*
- *Dual/elevated shelves*
- *Lower level soap tray with acrylic rod*



Part #	Mfg #	Description	Seat	Drain	Finish	Price
137380	SH-DS-5-WHT	76-1/2" x 60" x 33-3/8"	Twin Corner	Center	White	

SH-FL-4 1-Pc Fiberglass Shower Module

- *Rough-in dimensions: 79-1/8" x 47-3/4" x 34-3/4"*
- *Elevated back wall shelf*
- *Lower level, corner soap tray with acrylic rod*



Part #	Mfg #	Description	Drain	Finish	Price
133944	SH-FL-4-WHT	77-7/8" x 47-3/4" x 33-1/2"	Center	White	

Showers

Fiberglass Showers

SH-N-38 1-Pc Fiberglass Neo-Angle Shower Module

- Rough-in dimensions: 82-1/2" x 39-1/4" x 39-1/4"
- Single, elevated corner shelf



Part #	Mfg #	Description	Drain	Finish	Price
115076	SH-N-38-WHT	81-1/4" x 38" x 38"	Center	White	

SH-P-48 3-Pc Fiberglass Shower Module

- Rough-in dimensions: 81-1/8" x 47-3/4" x 33"
- Elevated corner shelf
- Single, contoured seat



Part #	Mfg #	Description	Seat	Drain	Finish	Price
092311	SH-P-48L-WHT	79-7/8" x 47-3/4" x 31-3/4"	LH	Center	White	

Fiberglass Assisted-Living Shower Modules

- Sanitary grade polyester gel coat surface
- 3-3/8" Diameter drain
- 1/2" Threshold
- 1" Floor flange
- Textured floor pattern
- Balsa wood core floor structure

SHFW-6235/ADA-RI 1-Pc Standard Roll-In Barrier-Free Shower Module

- Rough-in dimensions: 76-3/4" x 62" x 36-1/4"
- Contoured threshold
- Package includes:
 - (3) 1-1/2" Diameter stainless steel, horizontally mounted bars
 - (1) 1" Diameter stainless steel shower rod



Part #	Mfg #	Description	Drain	Finish	Price
147567	SHFW-6235/ADA-RI-WHT	75-1/2" x 62" x 35"	Center	White	

Showers

Vikrell - Sterling Showers

Vikrell® Shower Modules

- Solid Vikrell® material for strength and durability
- High-gloss finish



6205 Transfer Swirl Gloss Shower Module

- Folding transfer seat with stainless steel support
- Modular 4-piece design
- Tongue-and-groove "snap together" design for easy installation
- Factory installed stainless steel grab bars
- Lightly pebbled, slip-resistant bottom for better traction and safer footing
- Low profile threshold for easy wheelchair access
- Complete direct-to-stud unit rough-in dimensions including flange: 73-1/4" x 39-5/8" x 40-5/8"
- 10-Year consumer limited warranty
- 3-Year commercial limited warranty



Part #	Mfg #	Description	Drain	Finished Dimensions	Color	Price
096859	62051100-0	Base Only	Center	1/2" x 39-3/8" x 39-3/8"	White	
105933	62052123-0	Back Wall with Grab Bar at Right	-	65-1/4" x 39-3/8"	White	
093971	62055125-0	End Wall Set w/Seat Left, Grab Bar Right	-	65-9/16" x 40-5/8"	White	

7224 Accord® Alcove Shower Module

- 3-Piece wall set
- Completely caulkless seams
- Interlocking wall clips click securely into place
- Large, deep shelves and semi-hidden storage design
- Complete unit rough-in dimensions for 72240100: 76" x 36-1/4" x 37-1/4"



Part #	Mfg #	Description	Drain	Finished Dimensions	Color	Price
122831	72240100-0	Shower Complete	Center	77" x 36" x 36"	White	
122830	72241100-0	Base Only	Center	36" x 36"	White	
122829	72242100-0	Back Wall Only	-	77" x 36"	White	
122039	72245100-0	End Wall Set	-	77" x 36"	White	
123022	72245100-96	End Wall Set	-	77" x 36"	Biscuit	
124292	72245106-0	End Wall Set with Backers	-	77" x 36"	White	

7226 Accord® Alcove Shower Module

- 3-Piece wall set
- Completely caulkless seams
- Interlocking wall clips click securely into place
- Large, deep shelves and semi-hidden storage design
- Complete unit rough-in dimensions for 72260100: 77" x 48-1/4" x 37-1/4"



Part #	Mfg #	Description	Drain	Finished Dimensions	Color	Price
123026	72260100-0	Shower Complete	Center	75-3/4" x 48" x 36"	White	
189315	72260103-N-0	Shower Complete, w/ Nickel Grab Bars	Center	75-3/4" x 48" x 36"	White	
123024	72261100-0	Base Only	Center	48" x 36"	White	
125073	72261100-96	Base Only	Center	48" x 36"	Biscuit	
123025	72262100-0	Back Wall Only	-	77" x 48"	White	

Vikrell - Sterling Showers

Vikrell® Shower Modules (Continued)

7226 Accord® Alcove Shower Module

Part #	Mfg #	Description	Drain	Finished Dimensions	Color	Price
125072	72262100-96	Back Wall Only	-	77" x 48"	Biscuit	

7227 Accord® Alcove Shower Module

- 3-Piece wall set
- Completely caulkless seams
- Interlocking wall clips click securely into place
- Large, deep shelves and semi-hidden storage design
- Complete unit rough-in dimensions for 72270100: 77" x 60-1/4" x 37-1/4"



Part #	Mfg #	Description	Drain	Finished Dimensions	Color	Price
123416	72271100-0	Base Only	Center	60" x 36"	White	
123417	72272100-0	Back Wall Only	-	77" x 60"	White	
123021	72272100-96	Back Wall Only	-	77" x 60"	Biscuit	

7228 Accord® Seated Shower Module

- 3-Piece wall set
- Completely caulkless seams
- Interlocking wall clips click securely into place
- Large, deep shelves and semi-hidden storage design
- 12" Wide seat can be positioned on the left or right or removed
- Complete unit rough-in dimensions for 72280100/72280106: 76" x 48-1/4" x 37-1/4"



Part #	Mfg #	Description	Drain	Finished Dimensions	Color	Price
132600	72280100-0	Seated Shower Complete	Center	76" x 48" x 36"	White	
132598	72281100-0	Base Only	Center	20-1/2" x 48" x 36"	White	
135853	72281100-96	Base Only	Center	20-1/2" x 48" x 36"	Biscuit	
132599	72284100-0	Complete Wall Set	-	55-1/8" x 48" x 36"	White	
135854	72284100-96	Complete Wall Set	-	55-1/8" x 48" x 36"	Biscuit	
138146	72284106-0	Complete Wall Set	-	55-1/8" x 48" x 36"	White	
140147	72286104-0	Removable Seat	-	16" x 12" x 21-1/4"	White	

7229 Accord® Seated Shower Module

- 3-Piece wall set
- Completely caulkless seams
- Interlocking wall clips click securely into place
- Large, deep shelves and semi-hidden storage design
- 12" Wide seat can be positioned on the left or right or removed
- Complete unit rough-in dimensions for 72290100: 75-7/8" x 60-1/4" x 37-1/4"



Part #	Mfg #	Description	Drain	Finished Dimensions	Color	Price
132654	72290100-0	Seated Shower Complete	Center	75-7/8" x 60" x 36"	White	
132439	72290106-0	Seated Shower Complete with Backers	Center	74-1/2" x 60" x 36"	White	
132437	72291100-0	Base Only	Center	20-1/2" x 60" x 36"	White	
133694	72291100-96	Base Only	Center	20-1/2" x 60" x 36"	Biscuit	

Showers

Vikrell - Sterling Showers

Vikrell® Shower Modules (Continued)
7229 Accord® Seated Shower Module

Part #	Mfg #	Description	Drain	Finished Dimensions	Color	Price
136390	72294103-96	Complete Wall Set	-	55-1/8" x 60" x 36"	Biscuit	
134000	72294106-96	Complete Wall Set with Backers	-	74-1/2" x 60" x 36"	Biscuit	

6201 Advantage™ Shower Module

- Lightly textured swirl-gloss finish hides scratches from use
- Lightly pebbled base
- 3-Piece wall set
- Tongue and groove interlocking joints
- (2) Shelves and acrylic towel bar on back wall
- Complete unit rough-in dimensions for 62010100: 73-1/4" x 32-1/4" x 35-1/4"

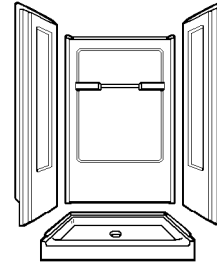

Part #	Mfg #	Description	Drain	Finished Dimensions	Color	Price
007852	62010100-0	Shower Complete	Center	72" x 32" x 34"	White	
007854	62011100-0	Base Only	Center	32" x 34"	White	
007853	62012100-0	Back Wall Only	-	67" x 32" x 34"	White	
007834	62015100-0	End Wall Set	-	66-1/4" x 32" x 35-1/4"	White	

6202 Advantage™ Shower Module

- Lightly textured swirl-gloss finish hides scratches from use
- Lightly pebbled base
- 3-Piece wall set
- Tongue and groove interlocking joints
- (2) Shelves and acrylic towel bar on back wall
- Complete unit rough-in dimensions for 62020100: 73-1/4" x 36-1/4" x 35-1/4"

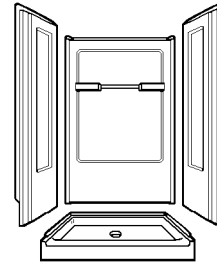

Part #	Mfg #	Description	Drain	Finished Dimensions	Color	Price
007856	62020100-0	Shower Complete	Center	73-1/4" x 36" x 35-1/4"	White	
007838	62021100-0	Base Only	Center	36" x 34"	White	
007835	62022100-0	Back Wall Only	-	67" x 36" x 34"	White	

6203 Advantage™ Seated Shower Module

- Lightly textured swirl-gloss finish hides scratches from use
- Base includes (2) molded-in seats, lightly pebbled bottom
- 3-Piece wall set
- Tongue and groove interlocking joints
- (2) Shelves and 18" towel bar on back wall
- Complete unit rough-in dimensions for 62030100: 73-1/4" x 48-1/4" x 35-1/4"

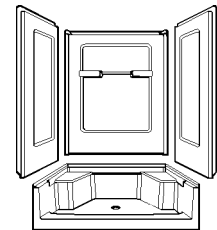

Part #	Mfg #	Description	Drain	Finished Dimensions	Color	Price
007848	62030100-0	Seated Shower Complete	Center	72" x 48" x 34"	White	
136004	62030106-0	Seated Shower Complete with Backers	Center	72" x 48" x 34"	White	
007826	62031100-0	Seated Base Only	Center	48" x 34"	White	
039773	62034100-0	Seated Shower Smooth Wall Set	-	56" x 48" x 35-1/4"	White	
126480	62034106-0	Seated Shower Wall Set with Backers	-	55-1/4" x 48" x 35-1/4"	White	

Vikrell - Sterling Showers

6204 Advantage™ Seated Shower Module

- Lightly textured swirl-gloss finish hides scratches from use
- Base includes (2) molded-in seats, lightly pebbled bottom
- 3-Piece wall set
- Tongue and groove interlocking joints
- (2) Shelves and 18" towel bar on back wall
- Complete unit rough-in dimensions for 62040100: 77-1/4" x 60-1/4" x 35-1/4"

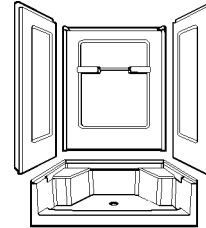

Part #	Mfg #	Description	Drain	Finished Dimensions	Color	Price
007850	62040100-0	Seated Shower Complete	Center	76" x 60" x 34"	White	
007832	62041100-0	Seated Base Only	Center	60" x 34"	White	
043191	62044100-0	Seated Shower Tile Wall Set	-	59-1/4" x 60" x 35-1/4"	White	

7210 Ensemble™ Tile Alcove Shower Module

- Order back wall and end walls separately
- Lightly pebbled base
- 3-Piece wall set
- Base can be installed using Ensemble™ Tile wall surround and Ensemble™ Curve wall surround, also perfect for tile down applications
- Realistic tile look
- Tongue and groove interlocking joints
- Shelving on back wall



Part #	Mfg #	Description	Drain	Finished Dimensions	Color	Price
067684	72101100-0	Base Only	Center	4-1/2" x 36" x 34"	White	
067173	72101100-96	Base Only	Center	4-1/2" x 36" x 34"	Biscuit	
067876	72102100-0	Tile Back Wall	-	72-1/2" x 36"	White	
067878	72105100-0	Tile End Wall Set	-	72-1/2" x 36"	White	
067879	72105100-96	Tile End Wall Set	-	72-1/2" x 36"	Biscuit	
110396	72105106-0	Tile End Wall Set with Backers	-	72-1/2" x 35-1/4"	White	

7211 Ensemble™ Tile Alcove Shower Module

- Order back wall and end walls separately
- Lightly pebbled base
- 3-Piece wall set
- Base can be installed using Ensemble™ Tile wall surround and Ensemble™ Curve wall surround, also perfect for tile down applications
- Realistic tile look
- Tongue and groove interlocking joints
- Shelving on back wall



Part #	Mfg #	Description	Drain	Finished Dimensions	Color	Price
067124	72111100-0	Base Only	Center	4-1/2" x 42" x 34"	White	

Showers

Vikrell - Sterling Showers

7212 Ensemble™ Tile Alcove Shower Module

- Order back wall and end walls separately
- Lightly pebbled base
- 3-Piece wall set
- Base can be installed using Ensemble™ Tile wall surround and Ensemble™ Curve wall surround, also perfect for tile down applications
- Realistic tile look
- Tongue and groove interlocking joints
- Shelving on back wall
- Complete unit rough-in dimensions including nailing flange for 72120100: 77" x 48-1/4" x 35-1/4"



Part #	Mfg #	Description	Drain	Finished Dimensions	Color	Price
067941	72120100-0	Tile Shower Complete	Center	75-3/4" x 48" x 34"	White	
067663	72121100-0	Base Only	Center	4-1/2" x 48" x 34"	White	
067143	72121100-96	Base Only	Center	4-1/2" x 48" x 34"	Biscuit	
067909	72122100-0	Tile Back Wall	-	72-1/2" x 48"	White	

7213 Ensemble™ Tile Alcove Shower Module

- Order back wall and end walls separately
- Lightly pebbled base
- 3-Piece wall set
- Base can be installed using Ensemble™ Tile wall surround and Ensemble™ Curve wall surround, also perfect for tile down applications
- Realistic tile look
- Tongue and groove interlocking joints
- Shelving on back wall
- Complete unit rough-in dimensions including nailing flange for 72130100: 77" x 60-1/4" x 35-1/4"



Part #	Mfg #	Description	Drain	Finished Dimensions	Color	Price
067945	72130100-0	Tile Shower Complete	Center	75-3/4" x 60" x 34"	White	
189506	72130106-96	Tile Shower Complete w/ Backer Boards	Center	75-3/4" x 60" x 34"	White	
067145	72131100-0	Base Only	Center	4-1/2" x 60" x 34"	White	
067915	72131100-96	Base Only	Center	4-1/2" x 60" x 34"	Biscuit	
067916	72132100-0	Tile Back Wall	-	72-1/2" x 60"	White	
067918	72132100-96	Tile Back Wall	-	72-1/2" x 60"	Biscuit	

7220 Ensemble™ Smooth Wall Curve Alcove Shower Module

- Lightly pebbled base
- 3-Piece wall set
- Base can be installed using Ensemble™ Tile wall surround and Ensemble™ Curve wall surround, also perfect for tile down applications
- Tongue and groove interlocking joints
- Shelving on back wall
- Complete unit rough-in dimensions for 72200100: 77" x 36-1/4" x 35-1/4"



Part #	Mfg #	Description	Drain	Finished Dimensions	Color	Price
067925	72200100-0	Curve Shower Complete	Center	75-3/4" x 36" x 34"	White	
067880	72202100-0	Curve Back Wall	-	72-1/2" x 36"	White	
067881	72202100-96	Curve Back Wall	-	72-1/2" x 36"	Biscuit	

Showers

Vikrell - Sterling Showers

Vikrell® Shower Modules (Continued)

7220 Ensemble™ Smooth Wall Curve Alcove Shower Module

Part #	Mfg #	Description	Drain	Finished Dimensions	Color	Price
067882	72205100-0	Curve End Wall Set	-	72-1/2" x 35-1/4"	White	
067883	72205100-96	Curve End Wall Set	-	72-1/2" x 35-1/4"	Biscuit	

7221 Ensemble™ Smooth Wall Curve Alcove Shower Module

- Lightly pebbled base
- 3-Piece wall set
- Base can be installed using Ensemble™ Tile wall surround and Ensemble™ Curve wall surround, also perfect for tile down applications
- Tongue and groove interlocking joints
- Shelving on back wall



Part #	Mfg #	Description	Drain	Finished Dimensions	Color	Price
067907	72212100-0	Curve Back Wall	-	72-1/2" x 42"	White	

7222 Ensemble™ Smooth Wall Curve Alcove Shower Module

- Lightly pebbled base
- 3-Piece wall set
- Base can be installed using Ensemble™ Tile wall surround and Ensemble™ Curve wall surround, also perfect for tile down applications
- Tongue and groove interlocking joints
- Shelving on back wall
- Complete unit rough-in dimensions for 72220100: 77" x 48-1/4" x 35-1/4"



Part #	Mfg #	Description	Drain	Finished Dimensions	Color	Price
067943	72220100-0	Curve Shower Complete	Center	75-3/4" x 48" x 34"	White	
067944	72220100-96	Curve Shower Complete	Center	75-3/4" x 48" x 34"	Biscuit	
067911	72222100-0	Curve Back Wall	-	72-1/2" x 48"	White	
067912	72222100-96	Curve Back Wall	-	72-1/2" x 48"	Biscuit	

7223 Ensemble™ Smooth Wall Curve Alcove Shower Module

- Lightly pebbled base
- 3-Piece wall set
- Base can be installed using Ensemble™ Tile wall surround and Ensemble™ Curve wall surround, also perfect for tile down applications
- Tongue and groove interlocking joints
- Shelving on back wall
- Complete unit rough-in dimensions for 72230100: 77" x 60-1/4" x 35-1/4"



Part #	Mfg #	Description	Drain	Finished Dimensions	Color	Price
067947	72230100-0	Curve Shower Complete	Center	75-3/4" x 60" x 34"	White	
067948	72230100-96	Curve Shower Complete	Center	75-3/4" x 60" x 34"	Biscuit	
067919	72232100-0	Curve Back Wall	-	72-1/2" x 60"	White	
067920	72232100-96	Curve Back Wall	-	72-1/2" x 60"	Biscuit	

Showers

Vikrell - Sterling Showers

Vikrell® Shower Modules (Continued)

7223 Ensemble™ Smooth Wall Curve Alcove Shower Module

Part #	Mfg #	Description	Drain	Finished Dimensions	Color	Price
130591	72232106-0	Curve Back Wall with Backers	-	72-1/2" x 60"	White	

Ensemble™ Shower Base

- 10-Year consumer and 3-year commercial limited warranty

Part #	Mfg #	Description	Drain	Finished Dimensions	Color	Price
104145	72141110-0	Base Only	LH	60" x 30"	White	
124449	72151100-0	Base Only	Center	3-1/2" x 42" x 42"	White	

7217 Ensemble™ Curve Shower Module

- Solid Vikrell® material for strength and durability
- High-gloss finish
- Tongue and groove 4-piece modular design with interlocking joints for snap together installation
- Curve wall with smooth look and feel
- Shelving on back wall
- Shaving ledge and foot rest
- Receptor can be ordered separately
- Complete unit rough-in dimensions: 76-1/2" x 60-1/4" x 31-1/4"
- 10-Year consumer and 3-year commercial limited warranty



Part #	Mfg #	Description	Drain	Finished Dimensions	Color	Price
146124	72170110-0	Curve Shower Complete	LH	76-1/2" x 60" x 30"	White	
146155	72170120-0	Curve Shower Complete	RH	76-1/2" x 60" x 30"	White	
146119	72171110-0	Base Only	LH	4" x 60" x 30"	White	
146120	72171110-96	Base Only	LH	4" x 60" x 30"	Biscuit	
146153	72171120-0	Base Only	RH	4" x 60" x 30"	White	
146154	72171120-96	Base Only	RH	4" x 60" x 30"	Biscuit	
146121	72175100-0	Curved End Wall Set	-	72-1/2" x 31-1/4"	White	
146123	72175100-96	Curved End Wall Set	-	72-1/2" x 31-1/4"	Biscuit	

7204 Intrigue™ Tile Neo-Angle Shower Module

- Lightly pebbled base
- 2-Piece back wall
- Tongue and groove interlocking joints
- (3) Shelves in corner column
- Complete unit rough-in dimensions: 80-1/4" x 40-1/4" x 40-1/4"

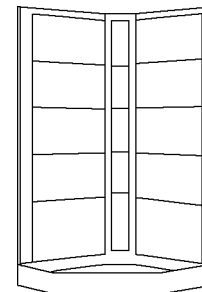

Part #	Mfg #	Description	Drain	Finished Dimensions	Color	Price
050273	72040100-0	Neo-Angle Shower Complete	Center	79" x 39"	White	
050271	72041100-0	Base Only	Center	39" x 39" Neo	White	
050272	72044100-0	Complete Tile Wall Set		75" x 39"	White	

Vikrell - Sterling Showers

Store+™ Shower Module

- Customizable 8-shelf storage system
- Holds up to 30 bottles
- Easy to clean - removable accessories are dishwasher safe
- Convenient molded-in shaving ledges
- Four-sided water containment with full-length threshold guard and weep channels for added protection
- Low 3-inch profile for easy entry and exit
- Durable high gloss finish
- Caulk-free installation
- Tongue-and-groove 4-piece modular design
- Sturdy accessories snap in place



Part #	Mfg #	Description	Drain	Finished Dimensions	Color	Price
223491	72320100-0	Four-Piece Complete	Center	75-3/4" x 48" x 34"		
224366	72320106-0	Four-Piece Complete with AIP Backers	Center	75-3/4" x 48" x 34"		
224686	72330100-0	Four-Piece Complete	Center	75-3/4" x 60" x 34"		

Guard+™ Shower Base

- Four-sided water containment with full-length threshold guard and weep channels for added protection
- Low 3-inch profile for easy entry and exit
- Durable high gloss finish
- Suitable for tile down application or with sterling STORE+™ wall surround



Part #	Mfg #	Description	Drain	Finished Dimensions	Color	Price
223488	72321100-0	Base Only	Center	3-1/8" x 48" x 34"		
224684	72331100-0	Base Only	Center	4-3/16" x 60" x 34"		

Fiberglass Showers

Shower Modules

1363TRIO Remodeline Sectional 3-Piece Shower Module

- Smooth wall finish
- Molded toiletry shelves
- Slip resistant, textured bottom



Part #	Mfg #	Finished Dimensions	Drain	Color	Price
029528	1363-TRIO-WH	36" x 36" x 72-3/4"	Center	White	

1363-2P Remodeline Sectional 2-Piece Shower Module

- Smooth wall finish
- Molded toiletry shelf
- Requires 52" turning space
- Gelcoat surface



Part #	Mfg #	Finished Dimensions	Drain	Color	Price
029558	1363-2P-WH	36" x 36" x 72"	Center	White	

1363C Everyday 1-Piece Shower Module

- Smooth wall finish
- Molded toiletry shelves
- Slip resistant textured bottom
- Gelcoat surface



Part #	Mfg #	Finished Dimensions	Drain	Color	Price
029568	1363C-WH	36" x 36" x 72"	Center	White	

Showers

Fiberglass Showers

1382NA2P Remodeline 2-Piece Neo-Angle Shower Module

- Smooth wall finish
- 2-Wall neo-angle corner design
- Overhang drip ledge disguises horizontal seam
- Integral soap shelf on wall
- Slip resistant, textured bottom



Part #	Mfg #	Finished Dimensions	Drain	Color	Price
029581	1382NA2P-WH	38" x 38" x 72"	Center	White	

1382NAC Everyday 1-Piece Neo-Angle Corner Shower Module

- Smooth wall finish
- Two-wall, neo-angle corner design
- Molded toiletry shelf
- Slip resistant textured bottom
- Gelcoat surface



Part #	Mfg #	Finished Dimensions	Drain	Color	Price
029583	1382NAC-WH	38" x 38" x 72"	Center	White	

1423C Builders' Choice Everyday 1-Piece Shower Module

- Smooth wall finish
- Molded toiletry shelves
- Slip resistant textured bottom
- Gelcoat surface



Part #	Mfg #	Finished Dimensions	Drain	Color	Price
029990	1423C-WH	42" x 34" x 72"	Center	White	

1483CST Everyday 1-Piece Shower Module

- Smooth wall finish
- Molded toiletry shelf
- Slip resistant textured bottom



Part #	Mfg #	Finished Dimensions	Drain	Color	Price
032055	1483CST-WH	48" x 33-1/2" x 76"	Center	White	

Showers

Fiberglass Showers

1483DTS Everyday 1-Piece Shower Module

- Diagonal tile surface
- Installed acrylic grab bar
- Molded seat
- Molded toiletry shelf
- Slip resistant textured bottom
- Gelcoat surface



Part #	Mfg #	Finished Dimensions	Drain	Seat	Color	Price
093699	1483DTS-L-WH	48" x 36" x 76"	Center	LH	White	
092082	1483DTS-L-BI	48" x 36" x 76"	Center	LH	Biscuit	
087765	1483DTS-R-WH	48" x 36" x 76"	Center	RH	White	

14832P Remodeline Sectional 2-Piece Shower Module

- Smooth wall finish
- Integral seat
- Molded toiletry shelf
- Requires 60" turning space
- Gelcoat surface



Part #	Mfg #	Finished Dimensions	Drain	Seat	Color	Price
029556	14832P-WH	48" x 34" x 72"	Center	(2) Seats	White	

1483SG Everyday 1-Piece Shower Module

- Smooth wall finish
- Molded seat
- Installed acrylic grab bar
- Molded toiletry shelves
- Slip resistant textured bottom



Part #	Mfg #	Finished Dimensions	Drain	Seat	Color	Price
029546	1483SG-WH	48" x 35" x 75"	Center	(2) Seats	White	
030662	1483SGT-WH	48" x 35" x 78"	Center	(2) Seats	White	

Showers

Fiberglass Showers

1483STS Everyday 1-Piece Shower Module

- Smooth wall finish
- Integral toiletry shelves
- Molded seat
- Slip resistant, textured bottom
- East zone only
- Gelcoat surface



Part #	Mfg #	Finished Dimensions	Drain	Seat	Color	Price
126434	1483STS-L-WH	48" x 36" x 76"	Center	LH	White	
127164	1483STS-L-BI	48" x 36" x 76"	Center	LH	Biscuit	
126433	1483STS-R-WH	48" x 36" x 76"	Center	RH	White	
127166	1483STS-R-BI	48" x 36" x 76"	Center	RH	Biscuit	

148344PSC 4-Piece Shower Module

- Pocketed connection system locks sections together without fasteners
- Smooth wall finish
- Integral acrylic grab bar
- Integral seat
- Slip resistant, textured bottom
- Gelcoat surface



Part #	Mfg #	Finished Dimensions	Drain	Seat	Color	Price
111307	148344PSC-R	48" x 34" x 76"	Center	RH	White	

16033P Remodeline 3-Piece Shower Module

- Smooth wall finish
- Integral seats
- Molded toiletry shelf
- Slip resistant, textured bottom
- Gelcoat surface



Part #	Mfg #	Finished Dimensions	Drain	Seat	Color	Price
031321	16033P-WH	60" x 34" x 72"	Center	(2) Seats	White	

Fiberglass Showers

1603DTS Everyday 1-Piece Shower Module

- Smooth tile finish with diagonal tile trim
- Molded seat
- Installed acrylic grab bar
- Molded toiletry shelves
- Slip resistant textured bottom
- Gelcoat surface



Part #	Mfg #	Finished Dimensions	Drain	Seat	Color	Price
072802	1603DTS-L-WH	60" x 36" x 76"	Center	LH	White	
094162	1603DTS-L-BI	60" x 36" x 76"	Center	LH	Biscuit	
083817	1603DTS-R-BI	60" x 36" x 76"	Center	RH	Biscuit	

1603STS Everyday 1-Piece Shower Module

- Smooth wall finish
- Integral toiletry shelves
- Molded seat
- Integral acrylic grab bar
- East zone only
- Slip resistant, textured bottom
- Gelcoat surface



Part #	Mfg #	Finished Dimensions	Drain	Seat	Color	Price
126438	1603STS-L-WH	60" x 36" x 76"	Center	LH	White	
129229	1603STS-L-BI	60" x 36" x 76"	Center	LH	Biscuit	
126437	1603STS-R-WH	60" x 36" x 76"	Center	RH	White	

160344PSC Everyday 4-Piece Shower Module

- Smooth wall finish
- Integral seat
- Molded toiletry shelves
- Installed acrylic grab bar
- Gelcoat surface



Part #	Mfg #	Finished Dimensions	Drain	Seat	Color	Price
111308	160344PSC-L-WH	60" x 34" x 76"	Center	LH	White	
111309	160344PSC-R-WH	60" x 34" x 76"	Center	RH	White	

Shower Stalls

Durastall® Shower Stalls and Enclosures

- Ideal for bathrooms, basements, breezeways, garages, utility rooms and vacation homes
- Free-standing knock-down construction
- Hi-gloss thermoplastic wall panels - choice of decorative trim
- Floor drain assembly and brass shower valve included
- Leak/rust resistant construction and components
- Resistant to mold and mildew, easy to clean



30, 70



80, 82, 140, 142

Part #	Mfg #	Height x Size	Base	Price
007503	30	73" x 30" x 30"	Standard	
007553	80	75-3/8" x 32" x 32"	Standard	
007486	140	75-3/8" x 36" x 36"	Standard	

Shower Bases

Shower Pans

6030CPAN Shower Pan

- High gloss finish
- A² Composite surface
- Pre-leveled slip-resistant, textured bottom
- Weep channels in all (4) corners
- Finishing step for application of various finishing materials



Part #	Mfg #	Finished Dimensions	Drain	Color	Price
140399	6030CPAN-L-WH	60" x 30" x 6"	Left	White	
136929	6030CPAN-R-WH	60" x 30" x 6"	Right	White	

4834APAN Acrylic Shower Pan



Part #	Mfg #	Dimensions	Color	Price
032650	4834APAN-WH	48" x 34"	White	

Showers

Shower Bases

Durabase® Fiberglass Shower Floors and Barrier-Free Shower Floor System

- *Styles and sizes for every installation*
- *Sturdy 1-piece molded construction*
- *Ribbed underbody for extra strength, slip-resistant surface*
- *Integrally molded drain with seal - removable stainless steel strainer*
- *Semi-gloss surface, resistant to mold and mildew, easy to clean*



Fiberglass Square Shower Floor- Single Threshold

Part #	Mfg #	Size	Color	Price
027149	3636M	36" x 36"	White	

Fiberglass Neo-Angle Shower Floor - Corner Threshold



Part #	Mfg #	Size	Color	Price
028425	3636CM	36" x 36"	White	

CareGiver® Easy-Access Showers Shower Tub™ - Single Threshold

- *1-Piece molded fiberglass*
- *Slip-resistant floor*

Part #	Mfg #	Description	Color	Price
070172	3060L	30" x 60", LH Drain	White	
068552	3060R	30" x 60", RH Drain	White	

Barrier-Free Shower Floor with Entry Ramp

- *Easy wheelchair access*
- *Strong molded fiberglass*
- *Resistance to mold, mildew and stains*
- *Offset 8-1/2" x 15" to utilize existing plumbing when replacing standard 5' tub*



Part #	Mfg #	Drain	Color	Price
023175	360R	RH	White	

Showers

Shower Bases & Accessories

Veritek™ Fiberglass Shower Floors

- Made of Veritek™ with no surface coating to chip or crack
- Slip resistant, large pebble surface
- Up to 50% lighter than other molded type shower floors, yet three times stronger
- Ribbed bottom means added strength, there is no "give"
- Made of Veritek™ with no surface coating to chip or crack
- Will not mold or mildew, no grout to clean
- Pebbled, slip-resistant surface
- Building and fire code approved

Single Threshold Shower Floor

- Includes:
 - (1) Code approved compression molded Swanstone floor
 - (1) Code approved self caulking Fit-Flo drain
 - Complete installation instructions
- Limited lifetime warranty



Part #	Mfg #	Dimensions	Color	Price
080243	SS-3448-040	34" x 48"	Bermuda Sand	

Showers

Shower Bases & Accessories

Shower Bases

Archer™ Acrylic Low Threshold Shower Base

- Covered drain
- Alcove installation
- (3) Side tile flange



36" x 36"

Part #	Mfg #	Description	Drain	Color	Price
123460	K-9396-0	36" x 36" x 3-11/16", Low Threshold	Center	White	
183164	K-9396-47	36" x 36" x 3-11/16", Low Threshold	Center	Almond	
225761	K-9396-7	36" x 36" x 3-11/16", Low Threshold	Center	Black	
145692	K-9396-95	36" x 36" x 3-11/16", Low Threshold	Center	Ice Grey	
144314	K-9396-96	36" x 36" x 3-11/16", Low Threshold	Center	Biscuit	
228602	K-9396-NY	36" x 36" x 3-11/16", Low Threshold	Center	Dune	

48" x 36"

Part #	Mfg #	Description	Drain	Color	Price
116143	K-9397-0	48" x 36" x 3-11/16", Low Threshold	Center	White	
174847	K-9397-58	48" x 36" x 3-11/16", Low Threshold	Center	Thunder Grey	
174847	K-9397-58	48" x 36" x 3-11/16", Low Threshold	Center	Thunder Grey	
174712	K-9397-95	48" x 36" x 3-11/16", Low Threshold	Center	Ice Grey	
119788	K-9397-96	48" x 36" x 3-11/16", Low Threshold	Center	Biscuit	
117761	K-9397-G9	48" x 36" x 3-11/16", Low Threshold	Center	Sandbar	
179515	K-9397-NY	48" x 36" x 3-11/16", Low Threshold	Center	Dune	

48" x 48"

Part #	Mfg #	Description	Drain	Color	Price
107459	K-9394-0	48" x 48" x 3-15/16", Low Threshold	Center	White	
129767	K-9394-33	48" x 48" x 3-15/16", Low Threshold	Center	Mexican Sand	
154199	K-9394-47	48" x 48" x 3-15/16", Low Threshold	Center	Almond	
119248	K-9394-96	48" x 48" x 3-15/16", Low Threshold	Center	Biscuit	
157836	K-9394-G9	48" x 48" x 3-15/16", Low Threshold	Center	Sandbar	
228469	K-9394-K4	48" x 48" x 3-15/16", Low Threshold	Center	Cashmere	

60" x 36"

Part #	Mfg #	Description	Drain	Color	Price
110016	K-9479-0	60" x 36" x 3-11/16", Low Threshold	Center	White	
139701	K-9479-47	60" x 36" x 3-11/16", Low Threshold	Center	Almond	
186377	K-9479-58	60" x 36" x 3-11/16", Low Threshold	Center	Thunder Grey	
178481	K-9479-95	60" x 36" x 3-11/16", Low Threshold	Center	Ice Grey	
111994	K-9479-96	60" x 36" x 3-11/16", Low Threshold	Center	Biscuit	
137310	K-9479-G9	60" x 36" x 3-11/16", Low Threshold	Center	Sandbar	
152795	K-9479-K4	60" x 36" x 3-11/16", Low Threshold	Center	Cashmere	
179640	K-9479-NY	60" x 36" x 3-11/16", Low Threshold	Center	Dune	

Showers

Shower Bases & Accessories

60" x 60"

Part #	Mfg #	Description	Drain	Color	Price
116073	K-9395-0	60" x 60" x 3-15/16", Low Threshold	Center	White	
170977	K-9395-96	60" x 60" x 3-15/16", Low Threshold	Center	Biscuit	

Ballast™ Low Threshold Shower Base

- Resin concrete core with acrylic surface



48" x 36"

Part #	Mfg #	Description	Drain	Color	Price
159806	K-1935-0	48" x 36" x 1-5/8"	Center	White	

60" x 32"

Part #	Mfg #	Description	Drain	Color	Price
159072	K-1936-0	60" x 32" x 1-15/16"	RH	White	
160324	K-1937-0	60" x 32" x 1-15/16"	LH	White	

66" x 36"

Part #	Mfg #	Description	Drain	Color	Price
157485	K-1938-0	66" x 36" x 1-5/8"	Center	White	

Bellwether® Single Threshold Shower Base

- Safeguard® slip-resistant finish
- Cast iron
- Recessed rain (can be used with K-9157 or K-9159 drain cover)



60" x 34"

Part #	Mfg #	Description	Drain	Color	Price
229434	K-9177-0	60" x 34" x 4-1/2"	LH	White	
222924	K-9178-0	60" x 34" x 4-1/2"	RH	White	
228056	K-9178-96	60" x 34" x 4-1/2"	RH	Biscuit	
225691	K-9178-G9	60" x 34" x 4-1/2"	RH	Sandbar	
170389	K-9193-0	60" x 34" x 4-1/2"	LH Offset	White	
223786	K-9193-96	60" x 34" x 4-1/2"	LH Offset	Biscuit	

60" x 32"

Part #	Mfg #	Description	Drain	Color	Price
167296	K-9163-0	60" x 32" x 4-1/2"	LH	White	
223644	K-9163-95	60" x 32" x 4-1/2"	LH	Ice Grey	
186226	K-9136-96	60" x 32" x 4-1/2"	LH	Biscuit	
224674	K-9164-G9	60" x 32" x 4-1/2"	RH	Sandbar	

Shower Bases & Accessories

Groove® Acrylic Low Threshold Shower Base

- Recessed rear drain
- Durable acrylic construction
- Single threshold for three wall or alcove installation



48" x 36"

Part #	Mfg #	Description	Drain	Color	Price
125049	K-9925-0	48" x 36" x 4-1/4", Low Threshold	Rear Center	White	
141746	K-9925-96	48" x 36" x 4-1/4", Low Threshold	Rear Center	Biscuit	
157588	K-9925-G9	48" x 36" x 4-1/4", Low Threshold	Rear Center	Sandbar	
180817	K-9925-NY	48" x 36" x 4-1/4", Low Threshold	Rear Center	Dune	

48" x 48"

Part #	Mfg #	Description	Drain	Color	Price
137180	K-9998-0	48" x 48" x 4-9/16", Low Threshold	Rear Center	White	

60" x 32"

Part #	Mfg #	Description	Drain	Color	Price
121538	K-9948-0	60" x 32" x 4-3/4", Low Threshold	RH Drain	White	

60" x 36"

Part #	Mfg #	Description	Drain	Color	Price
126221	K-9928-0	60" x 36" x 4-3/8", Low Threshold	Rear Center	White	
167083	K-9928-47	60" x 36" x 4-3/8", Low Threshold	Rear Center	Almond	
144411	K-9928-96	60" x 36" x 4-3/8", Low Threshold	Rear Center	Biscuit	
184793	K-9928-G9	60" x 36" x 4-3/8", Low Threshold	Rear Center	Sandbar	

60" x 42"

Part #	Mfg #	Description	Drain	Color	Price
126227	K-9996-0	60" x 42" x 4-9/16", Low Threshold	Rear Center	White	
134553	K-9996-47	60" x 42" x 4-9/16", Low Threshold	Rear Center	Almond	
120675	K-9996-95	60" x 42" x 4-9/16", Low Threshold	Rear Center	Ice Grey	
124326	K-9996-96	60" x 42" x 4-9/16", Low Threshold	Rear Center	Biscuit	
152044	K-9996-G9	60" x 42" x 4-9/16", Low Threshold	Rear Center	Sandbar	

Kathryn® Single Threshold Shower Base — 48" x 36"

- Center drain
- Textured bottom surface
- Three-wall or alcove installation
- Cast iron with Safeguard® slip-resistant finish



Part #	Mfg #	Description	Drain	Color	Price
079072	K-9025-0	48" x 36" x 4-5/8", Low Threshold	Center	White	

Showers

Shower Bases & Accessories

Memoirs® Single Threshold Acrylic Shower Base — 60" x 34"

- Textured floor pattern
- Single threshold for three-wall or alcove installation
- Rear center drain
- Internal flange
- Durable acrylic construction



Part #	Mfg #	Description	Drain	Color	Price
188743	K-9568-96	60" x 34" x 6", Single Threshold	Rear Center	Biscuit	

Memoirs® Acrylic Single Threshold Shower Base with Seat

- Single threshold
- Integral seat design for comfort



Part #	Mfg #	Description	Drain	Color	Price
120357	K-9496-0	60" x 36" x 21", Single Threshold	RH Drain	White	
138466	K-9496-47	60" x 36" x 21", Single Threshold	RH Drain	Almond	
138116	K-9496-95	60" x 36" x 21", Single Threshold	RH Drain	Ice Grey	
103529	K-9496-96	60" x 36" x 21", Single Threshold	RH Drain	Biscuit	
174853	K-9496-G9	60" x 36" x 21", Single Threshold	RH Drain	Sandbar	
103352	K-9496-K4	60" x 36" x 21", Single Threshold	RH Drain	Cashmere	

Tresham® Acrylic Single Threshold Shower Base with Seat

- Left- or right-hand seat options
- For alcove installations
- (3) Side tile flange



60" x 32"

Part #	Mfg #	Description	Drain	Color	Price
157468	K-1976-0	60" x 32" x 21-1/8", Single Threshold	Right Hand	White	
186771	K-1976-47	60" x 32" x 21-1/8", Single Threshold	Right Hand	Almond	
157223	K-1976-96	60" x 32" x 21-1/8", Single Threshold	Right Hand	Biscuit	
156511	K-1977-0	60" x 32" x 21-1/8", Single Threshold	Left Hand	White	
175910	K-1977-95	60" x 32" x 21-1/8", Single Threshold	Left Hand	Ice Grey	

60" x 36"

Part #	Mfg #	Description	Drain	Color	Price
152089	K-1978-0	60" x 36" x 21-1/8", Single Threshold	Right Hand	White	
190353	K-1978-NY	60" x 36" x 21-1/8", Single Threshold	Right Hand	Dune	
181701	K-1978-G9	60" x 36" x 21-1/8", Single Threshold	Right Hand	Sandbar	
149860	K-1979-0	60" x 36" x 21-1/8", Single Threshold	Left Hand	White	
159403	K-1979-96	60" x 36" x 21-1/8", Single Threshold	Left Hand	Biscuit	
181702	K-1979-G9	60" x 36" x 21-1/8", Single Threshold	Left Hand	Sandbar	

Shower Bases & Accessories

Tresham® Acrylic Single Threshold Shower Base

- Single, low-threshold design
- Center drain
- Reinforced with fiberglass (FRP)
- Molded-in floor pattern



Part #	Mfg #	Description	Drain	Color	Price
157719	K-1974-0	48" x 36" x 4-3/8", Single Threshold	Center	White	
223363	K-1974-47	48" x 36" x 4-3/8", Single Threshold	Center	Almond	
230266	K-1974-95	48" x 36" x 4-3/8", Single Threshold	Center	Ice Grey	
177483	K-1974-96	48" x 36" x 4-3/8", Single Threshold	Center	Biscuit	

Salient® Cast Iron Single Threshold Shower Base

- For Alcove installation with (3) tile-in flanges
- Safeguard® slip-resistant finish for added safety



60" x 30"

Part #	Mfg #	Description	Drain	Color	Price
108183	K-9053-0	60" x 30", Single Threshold	Center	White	
188742	K-9053-58	60" x 30", Single Threshold	Center	Thunder Grey	
124194	K-9053-96	60" x 30", Single Threshold	Center	Biscuit	
141897	K-9053-FF	60" x 30", Single Threshold	Center	Sea Salt	
140242	K-9053-FD	60" x 30", Single Threshold	Center	Cane Sugar	
183158	K-9053-G9	60" x 30", Single Threshold	Center	Sandbar	

60" x 36"

Part #	Mfg #	Description	Drain	Color	Price
113436	K-9055-0	60" x 36", Single Threshold	Center	White	
113231	K-9055-47	60" x 36", Single Threshold	Center	Almond	
157521	K-9055-58	60" x 36", Single Threshold	Center	Thunder Grey	
123537	K-9055-7	60" x 36", Single Threshold	Center	Black	
117131	K-9055-95	60" x 36", Single Threshold	Center	Ice Grey	
119445	K-9055-96	60" x 36", Single Threshold	Center	Biscuit	
120565	K-9055-FF	60" x 36", Single Threshold	Center	Sea Salt	
127405	K-9055-FT	60" x 36", Single Threshold	Center	Basalt	
126659	K-9055-G9	60" x 36", Single Threshold	Center	Sandbar	
155028	K-9055-KA	60" x 36", Single Threshold	Center	Black n' Tan	
126534	K-9055-K4	60" x 36", Single Threshold	Center	Cashmere	

Purist® Cast Iron Shower Base

- Safeguard® slip-resistant finish
- Single threshold for tile-in or drop-in installation



Part #	Mfg #	Description	Drain	Color	Price
074444	K-9026-96	48" x 36", Single Threshold	Center	Biscuit	
188483	K-9026-NY	48" x 36", Single Threshold	Center	Dune	

Showers

Shower Bases & Accessories

Shower Lockers™

Choreograph® Shower Locker Storage

- Four removable shelves; easy for cleaning
- Unique design ensures no water can collect on shelves
- Shelves and basket are height-adjustable to 10 positions
- Acrylic with matte finish
- 3/16" x 95-5/16"



Part #	Mfg #	Description	Drain	Color	Price
183468	K-97630-G9		Sandbar		

Echelon™ Shower Locker

- Integral tile-in flange
- Four easy-to-clean, built in shelves
- One-piece configuration
- 17-3/8" x 61-7/8"



Part #	Mfg #	Description	Price
111811	K-1842-0	White	
120103	K-1842-33	Mexican Sand	
129175	K-1842-47	Almond	
110546	K-1842-58	Thunder Grey	
127391	K-1842-7	Black	
150466	K-1842-95	Ice Grey	
107354	K-1842-96	Biscuit	
124605	K-1842-G9	Sandbar	
147153	K-1842-K4	Cashmere	
151074	K-1842-NY	Dune	

Shower Bases & Accessories

Shower Seats

Echelon® Shower Seat

- 17-3/8" x 43-1/2"
- Molded shower seat
- Integral tile-in flange



Part #	Mfg #	Description	Drain	Color	Price
186592	K-1843-95	Shower Seat	17-3/8" x 43-1/2"	Ice Grey	

Removable Shower Seat

- L 23-1/2", H 4", W 9-13/16"
- Plastic construction
- For use with Sonata® 4-foot and 5-foot shower stalls



Part #	Mfg #	Description	Drain	Color	Price
070471	K-9499-0	Shower Seat	23-1/2" x 4" x 9-13/16"	White	

Shower Accessories

Expanse® Curved Shower Rod

- Stainless steel construction
- Adjustable to fit standard 60- or 72-inch enclosures



Traditional Design

Part #	Mfg #	Description	Drain	Color	Price
151950	K-9349-BS		Brushed Stainless		
171615	K-9349-2BZ		Oil-Rubbed Bronze		
145053	K-9350-BS		Brushed Stainless		
184901	K-9350-2BZ		Oil-Rubbed Bronze		
142224	K-9350-S		Polished Stainless		

Contemporary Design

Part #	Mfg #	Description	Drain	Color	Price
132946	K-9351-BS		Brushed Stainless		
139106	K-9351-S		Polished Stainless		

Showers

Shower Bases & Accessories

Groove® Aluminum Drain Cover for 60" Receptor

- For use with the K-9928 or K-9996 Groove® acrylic shower base



Part #	Mfg #	Description	Drain	Color	Price
120676	K-9333-SH		Bright Silver		

Groove® Teak Drain Cover for 60" Receptor

- High-grade teak wood
- For use with the K-9928 or K-9996 Groove® shower base



Part #	Mfg #	Description	Drain	Color	Price
156592	K-9337-NA		Teak Wood		

Bellwether® Drain Cover for Bellwether® Shower Base

- Plastic construction



60" x 32"

Part #	Mfg #	Description	Drain	Color	Price
167297	K-9155-0	For 60" x 32" Bellwether® Shower Base	White		
223646	K-9155-95	For 60" x 32" Bellwether® Shower Base	Ice Grey		
188189	K-9155-96	For 60" x 32" Bellwether® Shower Base	Biscuit		
224675	K-9155-G9	For 60" x 32" Bellwether® Shower Base	Sandbar		
186227	K-9156-NX	For 60" x 32" Bellwether® Shower Base	Brushed Nickel		

60" x 34"

Part #	Mfg #	Description	Drain	Color	Price
170390	K-9157-0	For 60" x 34" Bellwether® Shower Base	White		
228057	K-9157-96	For 60" x 34" Bellwether® Shower Base	Biscuit		
225693	K-9157-G9	For 60" x 34" Bellwether® Shower Base	Sandbar		
224481	K-9159-NX	For 60" x 34" Bellwether® Shower Base	Brushed Nickel		

Corner Shower Basket 8-1/16" x 8-1/16"

- Stainless steel construction
- Mounting hardware included



Part #	Mfg #	Description	Drain	Color	Price
178560	K-1897-2BZ	8-1/16" x 8-1/16"	Oil-Rubbed Bronze		

Shower Doors

Swing Shower Doors Deluxe Framed Pivot Swing Shower Door

- Pivot jamb
- Drip system
- Magnetic latch

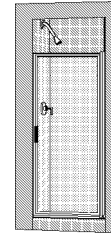

Part #	Mfg #	Fits Openings Between	Height	Glass	Frame	Price
043102	100-5	27-1/4" - 29"	63-1/2"	Obscure	Silver	
043281	100-6	28-3/4" - 30-1/2"	63-1/2"	Obscure	Silver	
043104	100-8	31-1/8" - 32-7/8"	63-1/2"	Obscure	Silver	
045535	200-7	31-1/8" - 32-7/8"	67"	Obscure	Silver	
043297	200-8	33-1/8" - 34-7/8"	67"	Obscure	Silver	
100354	500-8	28-3/4" - 30-1/2"	70-1/2"	Obscure	Silver	
112731	500-10	30-3/4" - 32-1/2"	70-1/2"	Obscure	Silver	

Classic Frameless Pivot Shower Door

- Magnetic handle
- Clear vinyl seal to eliminate leakage
- Pivot jamb makes out-of-square adjustments easy



Part #	Mfg #	Fits Openings Between	Height	Glass	Frame	Price
098980	3600-6	31-3/4" - 33-1/4"	66"	Obscure	Silver	

Thinline Framed & Frameless Shower Doors

Thinline Framed Pivot Door & Panel Shower

- Quick 'N Stall
- Drip system
- Splash guard pivot rail



Part #	Mfg #	Fits Openings Between	Height	Glass	Frame	Price
074062	735 38-1/4	38-1/4"	72"	Obscure	Silver	

Showers

Shower Doors

Quick 'N Stall Framed Neo Angle Shower Doors

- For fiberglass
- Pre-assembled header and curb
- Centerline dimensions based on 3/4" wall thickness
- Requires exact measurement of your opening



Part #	Mfg#	Model #	Height	Glass	Frame	Price
043293	160ST	Sterling 72040100	68-1/2"	Obscure	Silver	
047422	160-WR	Fits Warm Rain 490/492	68-1/2"	Obscure	Silver	

Showers

Shower Doors

Shower Doors

Deluxe Framed By-Pass Shower Door

- 1-1/2" Frame
- Reversible top track and towel bar
- Smooth, quiet operation
- Limited 3-year warranty



Part #	Mfg #	Description	Glass	Frame	Price
108710	5970-48S	70" x 48-7/8"	Pebble	Silver	
088977	5970-59S	70" x 59-3/8"	Pebble	Silver	
227306	5975-48S-G78	70" x 48-7/8"	Birchwood	Silver	
227301	5975-59S-G78	70" x 59-3/8"	Birchwood	Silver	

Finesse™ Frameless Hinge Shower Door

- CleanCoat® technology creates a barrier between the water and glass to help keep your shower door looking new
- Elegant rounded handles are mounted through the glass
- Two roller-compression latches allow for secure do
- Hidden continuous hinge runs the full-length of the jamb
- Limited 5-year warranty



Part #	Mfg #	Description	Glass	Frame	Price
077774	6305-34N	65-1/2" x 34"	Clear	Nickel	
075554	6305-34S	65-1/2" x 34"	Clear	Silver	
188793	6305-37N	65-1/2" x 37-3/4"	Clear	Nickel	
115736	6305-39N	65-1/2" x 39"	Clear	Nickel	

Finesse™ Peak™ Sliding Shower Door

- 5/16" thick tempered glass
- CleanCoat® barrier
- Reversible top track can be installed with either the concave or flat side facing out
- Door tracking system features a hidden, cushioned, center guide for smooth, quiet sliding action
- Two through-the-glass vertical handles, located both inside and outside, showcase a clean, uninterrupted look
- Frameless design highlights showering area
- Anodized aluminum hardware prevents rusting or corrosion
- Out-of-plumb adjustability allows for easy installation

Part #	Mfg #	Description	Drain	Finished Dimensions	Color	Price
227043	547808-48N-G03	70-1/16" x 47-5/8"	Frosted	Nickel		
227158	542808-59S-G05	59-5/8" x 55-1/2"	Clear	Silver		

Showers

Shower Doors

Finesse™ Frameless By-Pass Shower Door

- CleanCoat® glass coating
- Heavy-duty, anodized aluminum-framed glass doors
- Reversible top track can be installed with either the round or flat side facing out
- 1/4" Thick tempered glass
- (2) Through-the-glass towel bars



Part #	Mfg #	Description	Glass	Frame	Price
120218	SP5465-45S-G05	65-1/2" x 45-3/8"	Smooth Clear	Silver	
147401	5475-59N-G03	70-1/16" x 59-5/8"	Frosted	Nickel	
109153	5475-59N-G05	70-1/16" x 59-5/8"	Smooth Clear	Nickel	
109152	5475-59S-G05	70-1/16" x 59-5/8"	Smooth Clear	Silver	

Finesse™ Quick-Install™ Frameless By-Pass Shower Door

- CleanCoat® technology creates a barrier between the water and glass to help keep your shower door looking new
- Quick Install™ compression fit technology eliminates track cutting and tile drilling
- Pre-installed roller mechanisms for easier installation



Part #	Mfg #	Description	Glass	Frame	Price
227244	5305EZ-59S-G69	58-3/4" x 59-1/4"	Lake Mist	Silver	
224965	5325EZ-57S-G69	55-3/4" x 57"	Lake Mist	Silver	
189581	5375EZ-DR	70-5/16" x 57-1/2"	Clear	Deep Bronze	
104035	5375EZ-47N	70-5/16" x 47-1/4"	Smooth Clear	Nickel	
097861	5375EZ-47S	70-5/16" x 47-1/4"	Smooth Clear	Silver	

Prevail® Framed Sliding Shower Door

- Can be installed to open to left or right
- Smooth, easy-to-clean wall jambs
- Featuring ComforTrack™ Technology - a cushioned bottom track that allows for easier access to the showering space
- Out-of-plumb adjustability allows for simpler installation



Part #	Mfg #	Description	Drain	Finished Dimensions	Color	Price
189157	572075-48ADR-G10	70-1/8" x 48-7/8"	Pebbled	Deep Bronze		
189398	572075-59N-G03	70-1/8" x 59-3/8"	Frosted	Nickel		

Shower Doors

Intrigue™ Framed Neo-Angle Shower Door

- Corner design
- Threshold direct water back into shower
- Watertight flexible door magnet and seal
- Tempered glass
- No track cutting required
- Aluminum components extruded from alloy 6063-T5
- Stainless steel hardware
- Made for Sterling Intrigue Series 7204



Part #	Mfg #	Description	Glass	Frame	Price
052640	SP2270A-38S	72" x 15-13/16" x 27-9/16"	Pebbled	Silver	
072958	SP2276A-38N	72" x 15-13/16" x 27-9/16"	Rain	Nickel	
057795	SP2276A-38S	72" x 15-13/16" x 27-9/16"	Rain	Silver	

Solitaire® Frameless Neo-Angle Corner Shower Kit

- Installs left- or right-handed
- Easy to clean high-gloss finish
- Tempered glass ensures maximum safety and durability
- CleanCoat™ barrier
- Recessed walls provide more showering space
- Kit includes door, walls with corner caddy, drain, and 42" molded base
- Quick and easy to install with no track-cutting required



Part #	Mfg #	Description	Drain	Finished Dimensions	Color	Price
223390	2375-42S-G05	29-7/16" x 78-1/4"	Clear	Nickel		

Meritor™ Frameless Sliding Bath Door

- Can be installed to open left or right
- Smooth, easy-to-clean wall jambs
- Frameless, 5/16" thick tempered glass door
- ComforTrack™ enables you to sit, lean or kneel on the bottom track of the door to easily bathe children or clean the bathing space
- CleanCoat® barrier
- Center-guided mechanism for smooth, quiet sliding action and easy cleaning
- Out-of-plumb adjustability allows for simpler installation



Part #	Mfg #	Description	Drain	Finished Dimensions	Color	Price
190385	581005-59S-G05	59-3/8" x 55-1/8"	Clear	Anodized Deep Bronze		

Showers

Shower Rods

Shower Rods

Aluminum Shower Rod with Holder

- 1" OD - .025 Wall



Part #	Mfg #	Description	Price
076253	S02-059	5' Rod w/Chrome Flange & Screws	
076254	S02-072	6' Rod w/Chrome Flange & Screws	

Shower Rods

Shower Rods

Shower Rod

- Fits standard 72" x 72" shower curtains
- Adjusts around 5' tub surrounds
- 1-Year limited warranty



Part #	Mfg #	Finish	Price
132474	52-5	Chrome	
143294	55-5	Satin Stainless	
143746	2-10155SS	Stainless Steel	

Tension Shower Rod

- Adjusts from 5' to 6'
- Features decorative covers



Part #	Mfg #	Finish	Price
142275	TR1000CH	Chrome	
142251	TR1000BN	Brushed Nickel	
142682	TR1000OWB	Old World Bronze	

Adjustable Length Curved Shower Rod

- Adjusts to fit shower enclosures between 54" and 72"
- Pivoting flanges
- Stainless steel rod and covers
- Works with standard shower curtains



Part #	Mfg #	Finish	Price
109408	CSR2160CH	Chrome	
114698	CSR2160BN	Brushed Nickel	
106621	CSR2160OWB	Old World Bronze	

Adjustable Curved Shower Rod

- Fits standard 72"x72" shower curtains
- Pivoting flanges make installation easier
- Adjustable bar



Part #	Mfg #	Finish	Price
181076	CSR2164BN	5' to 6', Brushed Nickel	
181278	CSR2164CH	5' to 6', Chrome	
222587	CSR2164OWB	5' to 6', Old World Bronze	

Double Curved Shower Rod

- Fits standard 72"x72" shower curtains
- Adjusts up to 5' for a more flexible installation



Part #	Mfg #	Finish	Price
145182	DN2141CH	Chrome	
143453	DN2141BN	Brushed Nickel	

Fixed Length Curved Shower Rod

- Available in 5' and 6' lengths
- Pivoting flanges
- Stainless steel rod and covers
- Works with standard shower curtain



CSR2145

Part #	Mfg #	Finish	Price
108203	CSR2165CH	5', Chrome	
106324	CSR2165BN	5', Brushed Nickel	
111747	CSR2165OWB	5', Old World Bronze	
225903	CSR2145BN	5', Brushed Nickel	

Tension Curved Shower Rod



Part #	Mfg #	Finish	Price
171603	CSR2172BN	5', Brushed Nickel	

Shower Curtain Rings

- 12/Pk



SR2201



SR2100

Part #	Mfg #	Finish	Price
129883	SR2100BN	Brushed Nickel	
132169	SR2100CH	Chrome	
126034	SR2100OWB	Old World Bronze	
150444	SR2201BN	Brushed Nickel	
155982	SR2201CH	Chrome	
146651	SR2201OWB	Old World Bronze	

Shower Rods

Shower Rod Flange



Part #	Mfg #	Finish	Price
098391	65-F-PS	Chrome	

Commercial Accessories

2-100-5 Commercial Shower Rod

- Dimensions: 1" diameter x 5' length
- No flanges

Part #	Mfg #	Finish	Price
106251	2-100-5SS	Stainless Steel	
190076	2-100-5A	Chrome	

61-5 Commercial Shower Rod

- Fits standard 72" x 72" shower curtains
- Fits 5' tub surrounds
- Includes decorative covers for ends to conceal the mounting hardware



Part #	Mfg #	Finish	Price
106288	61-F	Chrome	
143747	61-5-SS	Stainless	

Commercial Shower Rod Flange Set

- Concealed mounting screws
- (2) Assemblies per set
- Fits 1" diameter rods



Part #	Mfg #	Finish	Price
126389	55-F	Stainless	

Shower Walls

Shower Wall Panels and Kits

Choreograph™ Shower Wall Kit 72"

- Factory installed edge - no need for trim
- Joint system hides caulk and silicone
- Serica™, KOHLER'S® proprietary composite material
- Adheres to water-resistant wallboard
- 72" Height

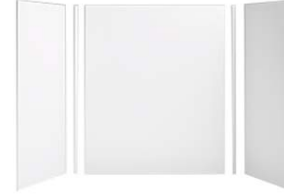

Part #	Mfg #	Description	Size	Color	Price
190223	K-97618-47	Shower Wall Kit	60" x 32" x 72"	Almond	
225768	K-97618-W07	Shower Wall Kit	60" x 32" x 72"	VeinCut Dune	
186880	K-97618-W09	Shower Wall Kit	60" x 32" x 72"	VeinCut Sandbar	
178629	K-97618-W11	Shower Wall Kit	60" x 32" x 72"	CrossCut Biscuit	
175301	K-97618-0	Shower Wall Kit	60" x 32" x 72"	White	
189466	K-97618-W10	Shower Wall Kit	60" x 32" x 72"	CrossCut Dune	
189430	K-97619-W09	Shower Wall Kit	60" x 36" x 72"	VeinCut Sandbar	
176800	K-97619-0	Shower Wall Kit	60" x 36" x 72"	White	
187246	K-97619-47	Shower Wall Kit	60" x 36" x 72"	Almond	
176720	K-97619-96	Shower Wall Kit	60" x 36" x 72"	Biscuit	
174059	K-97619-W07	Shower Wall Kit	60" x 36" x 72"	VeinCut Dune	
176915	K-97619-W08	Shower Wall Kit	60" x 36" x 72"	VeinCut Biscuit	
176914	K-97619-W10	Shower Wall Kit	60" x 36" x 72"	CrossCut Dune	
228265	K-97620-0	Shower Wall Kit	60" x 42" x 72"	White	
226145	K-97620-W11	Shower Wall Kit	60" x 42" x 72"	CrossCut Biscuit	

Choreograph™ Shower Wall Kit

- Factory installed edge - no need for trim
- Joint system hides caulk and silicone
- Serica™, KOHLER'S® proprietary composite material
- Adheres to water-resistant wallboard
- (T01)-Brick texture— (T02)-Core texture
- 96" Height

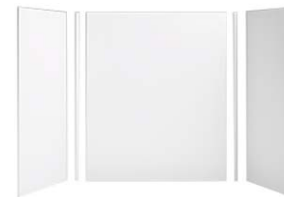

Part #	Mfg #	Description	Size	Color	Price
179769	K-97611-0	Shower Wall Kit	36" x 36" x 96"	White	
222448	K-97611-95	Shower Wall Kit	36" x 36" x 96"	Ice Grey	
229596	K-97611-T01-0	Shower Wall Kit, Brick Texture	36" x 36" x 96"	White	
228603	K-97611-W07	Shower Wall Kit	36" x 36" x 96"	VeinCut Dune	
176906	K-97614-0	Shower Wall Kit	48" x 36" x 96"	White	
176908	K-97614-96	Shower Wall Kit	48" x 36" x 96"	Biscuit	
223082	K-97614-G9	Shower Wall Kit	48" x 36" x 96"	Sandbar	
187721	K-97614-W07	Shower Wall Kit	48" x 36" x 96"	VeinCut Dune	
176909	K-97614-W08	Shower Wall Kit	48" x 36" x 96"	VeinCut Biscuit	
225068	K-97614-W09	Shower Wall Kit	48" x 36" x 96"	VeinCut Sandbar	
176907	K-97614-W10	Shower Wall Kit	48" x 36" x 96"	CrossCut Dune	
226637	K-99659-W07	Shower Wall Kit	48" x 48" x 96"	VeinCut Dune	
177200	K-97615-0	Shower Wall Kit	60" x 32" x 96"	White	

SHOWERS

Shower Walls

Shower Wall Panels and Kits (Continued)

Choreograph™ Shower Wall Kit

Part #	Mfg #	Description	Size	Color	Price
224676	K-97615-W09	Shower Wall Kit	60" x 32" x 96"	VeinCut Sandbar	
180426	K-97615-W10	Shower Wall Kit	60" x 32" x 96"	CrossCut Dune	
176910	K-97616-0	Shower Wall Kit	60" x 36" x 96"	White	
176912	K-97616-96	Shower Wall Kit	60" x 36" x 96"	Biscuit	
176798	K-97616-T01-0	Shower Wall Kit, Brick Texture	60" x 36" x 96"	White	
224176	K-97616-T01-95	Shower Wall Kit, Brick Texture	60" x 36" x 96"	Ice Grey	
188143	K-97616-T02-0	Shower Wall Kit, Core Texture	60" x 36" x 96"	White	
179868	K-97616-T02-96	Shower Wall Kit, Core Texture	60" x 36" x 96"	Biscuit	
180387	K-97616-T01-NY	Shower Wall Kit, Brick Texture	60" x 36" x 96"	Dune	
187722	K-97616-W07	Shower Wall Kit	60" x 36" x 96"	VeinCut Dune	
176913	K-97616-W08	Shower Wall Kit	60" x 36" x 96"	VeinCut Biscuit	
181697	K-97616-W09	Shower Wall Kit	60" x 36" x 96"	VeinCut Sandbar	
176911	K-97616-W10	Shower Wall Kit	60" x 36" x 96"	CrossCut Dune	
222211	K-97616-W11	Shower Wall Kit	60" x 36" x 96"	CrossCut Biscuit	
184797	K-97617-95	Shower Wall Kit	60" x 42" x 96"	Ice Grey	
226177	K-97617-W07	Shower Wall Kit	60" x 42" x 96"	VeinCut Dune	
177481	K-97617-W08	Shower Wall Kit	60" x 42" x 96"	VeinCut Biscuit	
226146	K-97617-W11	Shower Wall Kit	60" x 42" x 96"	CrossCut Biscuit	

Choreograph™ Shower Wall Kit

- Serica®
- Matte finish
- In-field trimmable
- Factory-installed edge trim
- Joint system hides caulk and silicone
- Includes three 60" x 96" walls and two 96" corner joints

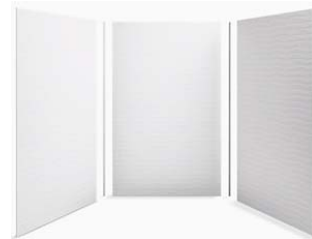

Part #	Mfg #	Description	Size	Color	Price
230143	K-99660-T01-0	Shower Wall Kit	60" x 60" x 96"	White	

72" Choreograph™ End Wall Panels

32"

Part #	Mfg #	Description	Size	Color	Price
189932	K-97605-0	Wall Panel Only	32" x 72"	White	
181817	K-97605-96	Wall Panel Only	32" x 72"	Biscuit	
229768	K-97605-G9	Wall Panel Only	32" x 72"	Sandbar	
225606	K-97605-W07	Wall Panel Only	32" x 72"	VeinCut Dune	
225582	K-97605-W10	Wall Panel Only	32" x 72"	CrossCut Dune	

36"

Part #	Mfg #	Description	Size	Color	Price
181712	K-97606-0	Wall Panel Only	36" x 72"	White	
181919	K-97606-G9	Wall Panel Only	36" x 72"	Sandbar	

Shower Walls

Shower Wall Panels and Kits (Continued)

72" Choreograph™ End Wall Panels

36"

Part #	Mfg #	Description	Size	Color	Price
181918	K-97606-W09	Wall Panel Only	36" x 72"	VeinCut Sandbar	

42"

Part #	Mfg #	Description	Size	Color	Price
187917	K-97607-W08	Wall Panel Only	42" x 72"	VeinCut Biscuit	

60"

Part #	Mfg #	Description	Size	Color	Price
230703	K-97608-W07	Wall Panel Only	60" x 72"	VeinCut Dune	
181816	K-97608-W09	Wall Panel Only	60" x 72"	VeinCut Sandbar	

96" Choreograph™ End Wall Panels

32"

Part #	Mfg #	Description	Size	Color	Price
225320	K-97600-0	Wall Panel Only	32" x 96"	White	
185839	K-97600-NY	Wall Panel Only	32" x 96"	Dune	
177480	K-97600-W08	Wall Panel Only	32" x 96"	VeinCut Biscuit	

36"

Part #	Mfg #	Description	Size	Color	Price
179770	K-97601-0	Wall Panel Only	36" x 96"	White	
186225	K-97601-96	Wall Panel Only	36" x 96"	Biscuit	
182130	K-97601-G9	Wall Panel Only	36" x 96"	Sandbar	
228415	K-97601-NY	Wall Panel Only	36" x 96"	Dune	
225769	K-97601-W10	Wall Panel Only	36" x 96"	CrossCut Dune	
179518	K-97601-T01-NY	Wall Panel Only, Brick Texture	36" x 96"	Dune	
178423	K-97601-T02-0	Wall Panel Only, Cord Texture	36" x 96"	White	
225405	K-97601-T02-95	Wall Panel Only, Cord Texture	36" x 96"	Ice Grey	
179517	K-97601-T02-NY	Wall Panel Only, Cord Texture	36" x 96"	Dune	

42"

Part #	Mfg #	Description	Size	Color	Price
177531	K-97602-0	Wall Panel Only	42" x 96"	White	
177556	K-97602-W10	Wall Panel Only	42" x 96"	CrossCut Dune	

48"

Part #	Mfg #	Description	Size	Color	Price
179972	K-97603-0	Wall Panel Only	48" x 96"	White	
223215	K-97603-G9	Wall Panel Only	48" x 96"	Sandbar	
179516	K-97603-W07	Wall Panel Only	48" x 96"	VeinCut Dune	

Showers

Shower Walls

Shower Wall Panels and Kits (Continued)

96" Choreograph™ End Wall Panels

48"

Part #	Mfg #	Description	Size	Color	Price
182129	K-97603-W09	Wall Panel Only	48" x 96"	VeinCut Sandbar	

60"

Part #	Mfg #	Description	Size	Color	Price
177276	K-97604-T01-0	Wall Panel Only, Brick Texture	60" x 96"	White	
183132	K-97604-W09	Wall Panel Only	60" x 96"	VeinCut Sandbar	
226144	K-97604-W11	Wall Panel Only	60" x 96"	CrossCut Biscuit	

Choreograph™ Accent Panels Stix or Linen Texture

Part #	Mfg #	Description	Size	Color	Price
227481	K-97610-T04-0	Accent Panel Only, Stix Texture	60" x 28"	White	
176801	K-97610-T04-95	Accent Panel Only, Stix Texture	60" x 28"	Ice Grey	
229769	K-97610-T04-G9	Accent Panel Only, Linen Texture	60" x 28"	Sandbar	
176724	K-97610-T05-96	Accent Panel Only, Linen Texture	60" x 28"	Biscuit	

Choreograph™ Joints and Trim

96" Corner Joint

- For use with Choreograph wall panels
- Aluminum construction
- Height in-field trimmable
- Set of 2



Part #	Mfg #	Description	Size	Color	Price
176916	K-97635-0	Corner Joint	96"	White	
176802	K-97635-95	Corner Joint	96"	Ice Grey	
176732	K-97635-96	Corner Joint	96"	Biscuit	
176919	K-97635-ABZ	Corner Joint	96"	Anodized Dark Bronze	
176920	K-97635-BNK	Corner Joint	96"	Anodized Brushed Nickel	
182131	K-97635-G9	Corner Joint	96"	Sandbar	
176917	K-97635-NY	Corner Joint	96"	Dune	
176918	K-97635-SHP	Corner Joint	96"	Bright Polished Silver	

Shower Walls

96" Seam Joint

- For use with Choreograph wall panels and accent panels
- Use to install two shower wall panels vertically or horizontally on the wall
- Use to install an accent panel
- Use to install Shower Locker® storage
- Aluminum construction
- Height in-field trimmable
- Set of 2



For use only with KOHLER® wall panels with a rounded finish edge. Choreograph K-97635 corner joint or K-97638 edge trim may be required to complete rough-edge installations

Part #	Mfg #	Description	Size	Color	Price
176927	K-97636-0	Seam Joint	96"	White	
176803	K-97636-95	Seam Joint	96"	Ice Grey	
176728	K-97636-96	Seam Joint	96"	Biscuit	
176930	K-97636-ABZ	Seam Joint	96"	Anodized Dark Bronze	
176931	K-97636-BNK	Seam Joint	96"	Anodized Brushed Nickel	
183536	K-97636-G9	Seam Joint	96"	Sandbar	
176928	K-97636-NY	Seam Joint	96"	Dune	
176929	K-97636-SHP	Seam Joint	96"	Bright Polished Silver	

96" Edge Trim

- For use with Choreograph wall panels
- Aluminum construction
- Height in-field trimmable
- Set of 2



Part #	Mfg #	Description	Size	Color	Price
176922	K-97638-0	Edge Trim	96"	White	
176804	K-97638-95	Edge Trim	96"	Ice Grey	
176725	K-97638-96	Edge Trim	96"	Biscuit	
176925	K-97638-ABZ	Edge Trim	96"	Anodized Dark Bronze	
176926	K-97638-BNK	Edge Trim	96"	Anodized Brushed Nickel	
183467	K-97638-G9	Edge Trim	96"	Sandbar	
176923	K-97638-NY	Edge Trim	96"	Dune	
176924	K-97638-SHP	Edge Trim	96"	Bright Polished Silver	

Shower Walls

72" Corner Joint

- For use with Choreograph wall panels
- Aluminum construction
- Height in-field trimmable
- Set of 2



Part #	Mfg #	Description	Size	Color	Price
189933	K-97735-0	Corner Joint	72"	White	
181818	K-97735-96	Corner Joint	72"	Biscuit	
181926	K-97735-G9	Corner Joint	72"	Sandbar	
175790	K-97735-NY	Corner Joint	72"	Dune	

72" Seam Joint

- For use with Choreograph wall panels and accent panels
- Use to install two shower wall panels vertically or horizontally on the wall
- Use to install an accent panel
- Use to install Shower Locker® storage
- Aluminum construction
- Height in-field trimmable
- Set of 2



For use only with KOHLER® wall panels with a rounded finish edge.
Choreograph K-97735 corner joint or K-97738 edge trim may be required to complete rough-edge installations

Part #	Mfg #	Description	Size	Color	Price
180404	K-97736-0	Seam Joint	72"	White	
176727	K-97736-96	Seam Joint	72"	Biscuit	
179561	K-97736-BNK	Seam Joint	72"	Anodized Dark Bronze	
181925	K-97736-G9	Seam Joint	72"	Sandbar	
225583	K-97736-NY	Seam Joint	72"	Dune	

72" Edge Trim



Part #	Mfg #	Description	Size	Color	Price
176726	K-97738-96	Edge Trim	72"	Biscuit	

Shower Walls

Choreograph™ Joints and Trim (Continued) 72" Edge Trim

Part #	Mfg #	Description	Size	Color	Price
181924	K-97738-G9	Edge Trim	72"	Sandbar	

Choreograph™ Accessories

Choreograph™ 14" Shower Locker® Storage

- 16-13/16" x 95-5/16"
- For use with KOHLER Choreograph wall panels
- Four shelves; all removable for easy cleaning
- Unique design ensures no water can collect on the shelves
- Shower basket offers concealed storage for small items
- Shelves and basket are height-adjustable to 10 positions
- One shelf includes a hook for hanging storage and a cup for toothbrushes or razors
- Integrated foot ledge makes it easier to shave or wash your feet
- Recommended K-97636 Choreograph seam joint for installation (sold separately)



Part #	Mfg #	Description	Size	Color	Price
177532	K-97631-0	Shower Locker Storage	16-13/16" x 95-5/16"	White	
177547	K-97631-96	Shower Locker Storage	16-13/16" x 95-5/16"	Biscuit	
186909	K-97631-G9	Shower locker Storage	16-13/16" x 95-5/6"	Sandbar	
177549	K-97631-NY	Shower Locker Storage	16-13/16" x 95-5/16"	Dune	

Choreograph™ 9" Shower Locker® Storage

- 10-7/8" x 95-5/16"
- For use with KOHLER Choreograph wall panels
- Four shelves; all removable for easy cleaning
- Unique design ensures no water can collect on the shelves
- Shower basket offers concealed storage for small items
- Shelves and basket are height-adjustable to 10 positions
- One shelf includes a hook for hanging storage and a cup for toothbrushes or razors
- Integrated foot ledge makes it easier to shave or wash your feet
- Recommended K-97636 Choreograph seam joint for installation (sold separately)



Part #	Mfg #	Description	Size	Color	Price
177158	K-97630-0	Shower Locker Storage	10-7/8" x 95-5/16"	White	
224184	K-97630-95	Shower Locker Storage	10-7/8" x 95-5/16"	Ice Grey	
176721	K-97630-96	Shower Locker Storage	10-7/8" x 95-5/16"	Biscuit	
177546	K-97630-NY	Shower Locker Storage	10-7/8" x 95-5/16"	Dune	

Showers

Shower Walls

Choreograph™ Freestanding Shower Stool

- 13-1/4" x 14" x 26-7/16"



Part #	Mfg #	Description	Size	Color	Price
177487	K-97632-0	Shower Stool	13-1/4" x 14" x 26-7/16"	White	

Choreograph™ Shower Bar

- For use with Choreograph wall panels
- Slim, flat profile doubles as shower storage space
- 300 lbs of support



Part #	Mfg #	Description	Size	Color	Price
177540	K-97625-ABZ	Shower Bar	24"	Anodized Dark Bronze	
177541	K-97625-BNK	Shower Bar	24"	Anodized Brushed Nickel	
176722	K-97625-SHP	Shower Bar	24"	Bright Polished Silver	
176480	K-97626-ABZ	Shower Bar	36"	Anodized Dark Bronze	
176799	K-97626-BNK	Shower Bar	36"	Anodized Brushed Nickel	
174060	K-97626-SHP	Shower Bar	36"	Bright Polished Silver	
177543	K-97627-ABZ	Shower Bar	40"	Anodized Dark Bronze	
177533	K-97627-BNK	Shower Bar	40"	Anodized Brushed Nickel	
177542	K-97627-SHP	Shower Bar	40"	Bright Polished Silver	
177545	K-97628-ABZ	Shower Bar	54"	Anodized Dark Bronze	
175294	K-97628-BNK	Shower Bar	54"	Anodized Brushed Nickel	
177544	K-97628-SHP	Shower Bar	54"	Bright Polished Silver	

Choreograph™ Hook

- 1-3/16" Reach
- Easily removed from wall cleat for easy cleaning
- Works inside and outside shower space



Part #	Mfg #	Description	Size	Color	Price
180388	K-97624-BNK	Shower Hook	1-3/16"	Anodized Brushed Nickel	
176481	K-97624-SHP	Shower Hook	1-3/16"	Bright Polished Silver	

Shower Walls

Choreograph™ Floating Shower Shelf

- Works best with KOHLER® Choreograph™ wall panels
- Can install over tile and other wall surfaces, inside or outside the shower space
- Includes trivet to hold bar of soap
- Designed for quick water drainage and easy cleaning
- Removable for more thorough cleaning
- Wall attachment is concealed
- Cleat system installation allows shelf to be removed without tools



Part #	Mfg #	Description	Size	Color	Price
177535	K-97621-ABZ	Shower Shelf	7"	Anodized Dark Bronze	
177010	K-97621-BNK	Shower Shelf	7"	Anodized Brushed Nickel	
177013	K-97621-SHP	Shower Shelf	7"	Bright Polished Silver	
177537	K-97622-ABZ	Shower Shelf	14"	Anodized Dark Bronze	
177534	K-97622-BNK	Shower Shelf	14"	Anodized Brushed Nickel	
177536	K-97622-SHP	Shower Shelf	14"	Bright Polished Silver	
177539	K-97623-ABZ	Shower Shelf	21"	Anodized Dark Bronze	
177011	K-97623-BNK	Shower Shelf	21"	Anodized Brushed Nickel	
177538	K-97623-SHP	Shower Shelf	21"	Bright Polished Silver	

Shower Walls

Walls

Tub & Shower Side Wall Set

- Includes (1) right and (1) left side wall

Part #	Mfg #	Dimensions	Color	Price
136931	2374CSW-WH	23" x 74"	White	

Tub & Shower Back Wall

Part #	Mfg #	Dimensions	Color	Price
136930	6074CBW-WHT	60" x 74"	White	

Shower Walls

Durawall® Shower Walls

Durawall® Thermoplastic Deluxe Shower Wall

- 5-Piece construction
- Overlapping edges
- Adhesive mount
- Formed shelves



Part #	Mfg #	Description	Color	Price
020226	260WHT	Up to 60"W & 34"D	White	

Durawall® Fiberglass Premier Neo-Angle/Corner Shower Wall

- 3-Piece molded fiberglass
- Walls interlock and mount with screws direct to stud walls
- Molded-in shelves
- Single threshold

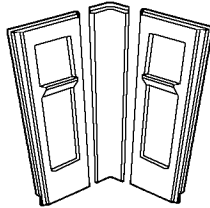

Part #	Mfg #	Fits Corner	Color	Price
007549	736CWHT	36" x 36"	White	

Bar/Entertainment Cast Iron Sinks

Dual-Mount

Porto Fino™ Dual-Mount Bar Sink

- Single bowl round
- 21" Minimum base cabinet width
- No faucet holes



Part #	Mfg #	Overall Dimensions	Basin Depth	Holes	Color	Price
071318	K-6565-0	18-3/8" X 18-3/8"	8"	N/A	White	
094834	K-6565-33	18-3/8" X 18-3/8"	8"	N/A	Mexican Sand	
084352	K-6565-47	18-3/8" X 18-3/8"	8"	N/A	Almond	
060870	K-6565-7	18-3/8" X 18-3/8"	8"	N/A	Black	
078506	K-6565-96	18-3/8" X 18-3/8"	8"	N/A	Biscuit	
099930	K-6565-FD	18-3/8" X 18-3/8"	8"	N/A	Cane Sugar	
106132	K-6565-G9	18-3/8" X 18-3/8"	8"	N/A	Sandbar	
097387	K-6565-KA	18-3/8" X 18-3/8"	8"	N/A	Black n' Tan	
082467	K-6565-K4	18-3/8" X 18-3/8"	8"	N/A	Cashmere	
225241	K-6565-NY	18-3/8" X 18-3/8"	8"	N/A	Dune	

Iron/Tones® Dual-Mount Bar Sink

- Single bowl square
- 18" Minimum base cabinet width
- No faucet holes



Part #	Mfg #	Overall Dimensions	Basin Depth	Holes	Color	Price
059641	K-6584-0	18-3/4" X 17"	8-1/4"	N/A	White	
081421	K-6584-33	18-3/4" X 17"	8-1/4"	N/A	Mexican Sand	
084356	K-6584-47	18-3/4" X 17"	8-1/4"	N/A	Almond	
064293	K-6584-7	18-3/4" X 17"	8-1/4"	N/A	Black	
142854	K-6584-95	18-3/4" X 17"	8-1/4"	N/A	Ice Grey	
062307	K-6584-96	18-3/4" X 17"	8-1/4"	N/A	Biscuit	
139468	K-6584-FD	18-3/4" X 17"	8-1/4"	N/A	Cane Sugar	
098428	K-6584-FF	18-3/4" X 17"	8-1/4"	N/A	Sea Salt	
153284	K-6584-FP	18-3/4" X 17"	8-1/4"	N/A	Caviar	
065894	K-6584-G9	18-3/4" X 17"	8-1/4"	N/A	Sandbar	
091560	K-6584-KA	18-3/4" X 17"	8-1/4"	N/A	Black n' Tan	
095504	K-6584-K4	18-3/4" X 17"	8-1/4"	N/A	Cashmere	
163271	K-6584-NY	18-3/4" X 17"	8-1/4"	N/A	Dune	

Iron/Tones® Dual-Mount Bar Sink

- Single bowl square
- 21" Minimum base cabinet width
- No faucet holes



Part #	Mfg #	Overall Dimensions	Basin Depth	Holes	Color	Price
055432	K-6587-0	20-7/8" X 20-7/8"	9-1/2"	N/A	White	

Bar/Entertainment Cast Iron Sinks

Dual-Mount (Continued) Iron/Tones® Dual-Mount Bar Sink

Part #	Mfg #	Overall Dimensions	Basin Depth	Holes	Color	Price
164121	K-6587-20	20-7/8" X 20-7/8"	9-1/2"	N/A	Suede	
092304	K-6587-33	20-7/8" X 20-7/8"	9-1/2"	N/A	Mexican Sand	
107316	K-6587-47	20-7/8" X 20-7/8"	9-1/2"	N/A	Almond	
134002	K-6587-58	20-7/8" X 20-7/8"	9-1/2"	N/A	Thunder Grey	
070119	K-6587-7	20-7/8" X 20-7/8"	9-1/2"	N/A	Black	
089413	K-6587-96	20-7/8" X 20-7/8"	9-1/2"	N/A	Biscuit	
107124	K-6587-FD	20-7/8" X 20-7/8"	9-1/2"	N/A	Cane Sugar	
153440	K-6587-FF	20-7/8" X 20-7/8"	9-1/2"	N/A	Sea Salt	
152233	K-6587-FP	20-7/8" X 20-7/8"	9-1/2"	N/A	Caviar	
107564	K-6587-G9	20-7/8" X 20-7/8"	9-1/2"	N/A	Sandbar	
093664	K-6587-KA	20-7/8" X 20-7/8"	9-1/2"	N/A	Black n' Tan	
146377	K-6587-K4	20-7/8" X 20-7/8"	9-1/2"	N/A	Cashmere	

Iron/Tones® Dual-Mount Entertainment Sink

- Single bowl square
- 21" Minimum base cabinet width
- No faucet holes



Part #	Mfg #	Overall Dimensions	Basin Depth	Holes	Color	Price
067505	K-6585-0	24-1/4" X 18-3/4"	8-1/4"	N/A	White	
092303	K-6585-33	24-1/4" X 18-3/4"	8-1/4"	N/A	Mexican Sand	
072123	K-6585-47	24-1/4" X 18-3/4"	8-1/4"	N/A	Almond	
066489	K-6585-7	24-1/4" X 18-3/4"	8-1/4"	N/A	Black	
059003	K-6585-96	24-1/4" X 18-3/4"	8-1/4"	N/A	Biscuit	
134178	K-6585-FD	24-1/4" X 18-3/4"	8-1/4"	N/A	Cane Sugar	
068590	K-6585-G9	24-1/4" X 18-3/4"	8-1/4"	N/A	Sandbar	
097238	K-6585-KA	24-1/4" X 18-3/4"	8-1/4"	N/A	Black n' Tan	

Top-Mount

Northland™ Top-Mount Bar Sink

- Single bowl
- 15" Minimum base cabinet width
- Available with 1, 2, or 3 faucet holes



Part #	Mfg #	Overall Dimensions	Basin Depth	Holes	Color	Price
055501	K-6579-1-0	15" X 15"	7"	1	White	
127852	K-6579-1-47	15" X 15"	7"	1	Almond	
103202	K-6579-1-7	15" X 15"	7"	1	Black	
055502	K-6579-1-96	15" X 15"	7"	1	Biscuit	
055133	K-6579-2-0	15" X 15"	7"	2	White	
058062	K-6579-2-7	15" X 15"	7"	2	Black	
055503	K-6579-2-96	15" X 15"	7"	2	Biscuit	

Bar/Entertainment Cast Iron Sinks

Top-Mount (Continued) Northland™ Top-Mount Bar Sink

Part #	Mfg #	Overall Dimensions	Basin Depth	Holes	Color	Price
062697	K-6579-3-0	15" X 15"	7"	3	White	

Under-Mount Napa™ Under-Mount Bar Sink

- Single bowl
- 21" Minimum base cabinet width
- 2 Oversized faucet holes allow for easy installation (-2U Only)



Part #	Mfg #	Overall Dimensions	Basin Depth	Holes	Color	Price
222397	K-5848-0	18-3/4" X 20-7/8"	9"	N/A	White	

Northland™ Under-Mount Bar Sink

- Single bowl
- 15" Minimum base cabinet width
- No faucet holes
- Under-mount installation



Part #	Mfg #	Overall Dimensions	Basin Depth	Holes	Color	Price
061848	K-6589-U-0	15" X 12-3/8"	7"	N/A	White	
172041	K-6589-U-20	15" X 12-3/8"	7"	N/A	Suede	
066649	K-6589-U-33	15" X 12-3/8"	7"	N/A	Mexican Sand	
152048	K-6589-U-47	15" X 12-3/8"	7"	N/A	Almond	
060644	K-6589-U-7	15" X 12-3/8"	7"	N/A	Black	
054866	K-6589-U-95	15" X 12-3/8"	7"	N/A	Ice Grey	
060353	K-6589-U-96	15" X 12-3/8"	7"	N/A	Biscuit	
104223	K-6589-U-FD	15" X 12-3/8"	7"	N/A	Cane Sugar	
137983	K-6589-U-FF	15" X 12-3/8"	7"	N/A	Sea Salt	
149779	K-6589-U-FP	15" X 12-3/8"	7"	N/A	Caviar	
071753	K-6589-U-G9	15" X 12-3/8"	7"	N/A	Sandbar	
109378	K-6589-U-KA	15" X 12-3/8"	7"	N/A	Black n' Tan	
084989	K-6589-U-K4	15" X 12-3/8"	7"	N/A	Cashmere	

Bar/Entertainment Stainless Steel Sinks

Dual-Mount

Vault™ Dual-Mount Entertainment Sink

- 18 Gauge stainless steel
- Installation hardware and bottom basin rack included

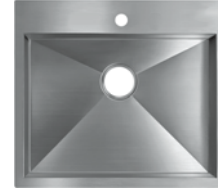

Part #	Mfg #	Overall Dimensions	Basin Depth	Holes		Price
142929	K-3840-1-NA	15" x 15"	9"	1	Single	
173444	K-3840-3-NA	15" x 15"	9"	3	Single	
138559	K-3822-1-NA	25" x 22"	9"	1	Single	
145189	K-3822-3-NA	25" x 22"	9"	3	Single	
132127	K-3822-4-NA	25" x 22"	9"	4	Single	

Top-Mount

Staccato™ Drop-In Entertainment Sink

- 18 Gauge stainless steel
- Installation hardware included



Part #	Mfg #	Overall Dimensions	Basin Depth	Holes		Price
064857	K-3363-1-NA	20" x 20"	8"	1	Single	
070943	K-3363-2-NA	20" x 20"	8"	2	Single	
083623	K-3362-1-NA	25" x 22"	8"	1	Single	

Taccato™ Drop-In Entertainment Sink

- 19 Gauge stainless steel
- Installation hardware included
- SilentShield® sound-absorption pads
- 18" Minimum base cabinet width



Part #	Mfg #	Overall Dimensions	Basin Depth	Holes	Color	Price
053333	K-3349-1-NA	15" x 15"	7"	1	Single	
053334	K-3349-2-NA	15" x 15"	7"	2	Single	

Under-Mount

Poise® Under-Mount Entertainment Sink

- 16 Gauge stainless steel
- Silent Shield® sound-absorption pads
- Installation hardware included
- 21" Minimum base cabinet width



Part #	Mfg #	Overall Dimensions	Basin Depth	Holes	Color	Price
108769	K-3391-NA	18" x 18"	9"	Less Holes	Single	

Bar/Entertainment Stainless Steel Sinks

Poise® Under-Mount Entertainment Sink with Bottom Bowl Rack and Cutting Board

- 16-gauge stainless steel
- 9-inch depth
- SilentShield® sound-absorption
- 21-inch minimum base cabinet width
- Includes installation hardware, bottom sink rack, and bamboo cutting board



Part #	Mfg #	Overall Dimensions	Basin Depth	Holes	Color	Price
108767	K-3161-NA	18" x 18"	9"	Less Holes	Single	

Strive™ Under-Mount Entertainment Sink

- 16 Gauge stainless steel
- Rear drain
- SilentShield® sound-absorption technology
- Includes dishcloth bar/utility shelf and bottom basin rack
- 27" Minimum base cabinet width



Part #	Mfg #	Overall Dimensions	Basin Depth	Holes	Color	Price
166623	K-5286-NA	24" x 18-1/4"	9"	Less Holes	Single	
166420	K-5287-NA	15" x 15"	9"	Less Holes	Single	

Undertone® Preserve™ Under-Mount Entertainment Sink

- 18 Gauge stainless steel
- SilentShield® sound-absorption technology
- Rear drain
- Innovative Preserve™ sink resists scratching
- Installation hardware included and bottom basin rack
- 27" Minimum base cabinet width



Part #	Mfg #	Overall Dimensions	Basin Depth	Holes	Color	Price
178499	K-3325-HCF-NA	23" x 17-1/2"	9-3/16"	Less Holes	Single	

Undertone® Extra-Large Squared Under-Mount Entertainment Sink

- 18 Gauge stainless steel
- SilentShield® sound-absorption pads
- Rear drain
- Includes installation hardware
- 27-inch minimum base cabinet width



Part #	Mfg #	Overall Dimensions	Basin Depth	Holes	Color	Price
056174	K-3332-NA	23" x 17-1/2"	7-1/2"	Less Holes	Single	

Bar/Entertainment Stainless Steel Sinks

Undertone® Under-Mount Entertainment Sink

- 18 Gauge stainless steel
- SilentShield® sound-absorption technology
- Center drain
- Installation hardware included and bottom basin rack
- 21" Minimum base cabinet width



Part #	Mfg #	Overall Dimensions	Basin Depth	Holes	Color	Price
094648	K-3182-NA	16-1/4" x 20-1/2"	8"	Less Holes	Single	

Undertone® Trough Sink

- 16 Gauge stainless steel
- No faucet holes
- SilentShield® sound-absorption pads
- Includes installation hardware, wire storage basket, and wire rack



Part #	Mfg #	Overall Dimensions	Basin Depth	Holes	Color	Price
083596	K-3155-NA	33" x 8-1/4"	5-15/16"	Less Holes	Single	

Bar/Entertainment Stainless Steel Sinks

Stainless Steel Entertainment Sinks
Self-Rimming Single Bowl Entertainment Sink

- Ledge back
- Stud mounting
- Type 302 series nickel-bearing stainless steel
- Rounded corners
- Self-rimming; rolled rim
- SilentShield™ sound-absorption technology



Sinks

Part #	Mfg #	Overall Dimensions	Depth	Holes	Drain	Finish	Price
081703	B153-2	15" x 15"	5-1/2"	2	3-5/8"	22ga Satin	

Springdale® Undercounter Single Bowl Entertainment Sink

- SilentShield™ sound-deadening system



Part #	Mfg #	Overall Dimensions	Depth	Holes	Drain	Finish	Price
102103	11448-NA	16-1/4" x 17-3/4"	8"	Less Holes	3-3/4"	18ga Satin	
102104	11449-NA	16" x 20-1/4"	8"	Less Holes	3-3/4"	18ga Satin	

Undercounter Single Bowl Entertainment Sink

- Wide undermount lip, rimless
- SilentShield™ sound deadening



Part #	Mfg #	Overall Dimensions	Depth	Holes	Drain	Finish	Price
099058	UCL1515	14-1/4" x 11-3/4"	7"	Less Holes	3-5/8"	18ga Satin	

Bar/Entertainment Stainless Steel Sinks

Sinks

Stainless Steel Bar Sinks

Spex™ Undermount Bar Sink

- 304 Series, 20 gauge stainless steel
- 18/8 Chrome/nickel content
- Satin finish
- Rear drain placement
- Sound deadening pads



Part #	Mfg #	Finish	Bowl Depth	Overall Size	Cabinet Size	Drain Dia	Price
061164	440320	Stainless Steel	7"	23" x 18"	27"	3-1/2"	

Steelart™ Precision™ Undermount Bar Sink

- 304 Series, 18 gauge stainless steel
- 18/10 Chrome/nickel content
- Satin polished finish
- Rear drain placement
- Sound deadening pads



Part #	Mfg #	Finish	Bowl Depth	Overall Size	Cabinet Size	Drain Dia	Price
092900	512746	Stainless Steel	10"	20" x 15"	24"	3-1/2"	
126106	516209	Stainless Steel	10"	19" x 18"	21"	3-1/2"	

Steelart™ Precision™ R10 Undermount Bar Sink

- 304 Series, 18 gauge stainless steel
- 18/10 Chrome/nickel content
- 10mm radius corners
- Satin polished finish
- Rear drain placement
- Sound deadening pads



Part #	Mfg #	Finish	Bowl Depth	Overall Size	Cabinet Size	Drain Dia	Price
126381	515638	Stainless Steel	8"	17" x 17"	21"	3-1/2"	
137474	516224	Stainless Steel	10"	19" x 18"	21"	3-1/2"	
136268	516223	Stainless Steel	10"	22" x 18"	27"	3-1/2"	

Stellar™ Undermount Bar Sink

- 304 Series, 18 gauge stainless steel
- 18/10 Chrome/nickel content
- Refined brushed finish
- Rear drain placement



Part #	Mfg #	Finish	Bowl Depth	Overall Size	Cabinet Size	Drain Dia	Price
123284	441026	Stainless Steel	6-1/2"	15" x 15"	18"	3-1/2"	

Bar/Entertainment Stainless Steel Sinks

Blanco Quatrus™ Undermount Bar Sink

- 304 Series, 18 gauge stainless steel
- 18/10 Chrome/nickel content
- Satin Finish
- Rear drain placement



Part #	Mfg #	Finish	Bowl Depth	Overall Size	Cabinet Size	Drain Dia	Price
153852	518168	Stainless Steel	8"	17" x 17"	21"	3-1/2"	

Quatrus™ R15 Undermount Bar Sink

- 304 Series, 18 gauge stainless steel
- 18/10 Chrome/nickel content
- Satin finish
- Rear drain placement
- Sound deadening pads



Part #	Mfg #	Finish	Bowl Depth	Overall Size	Cabinet Size	Drain Dia	Price
168240	519545	Stainless Steel	8"	17" x 17"	21"	3-1/2"	

Precision™ Bowl Undermount Bar Sink

- 304 Series, 18 gauge stainless steel
- 18/10 Chrome/nickel content
- Zero radius corners
- Satin polished finish
- Rear drain placement
- Sound deadening pads



Part #	Mfg #	Finish	Bowl Depth	Overall Size	Cabinet Size	Drain Dia	Price
163060	516208	Stainless Steel	10"	15" x 18"	18"	3-1/2"	
115548	512743	Stainless Steel	8"	11" x 20"	15"	3-1/2"	

Sinks

Bar/Entertainment Stainless Steel Sinks

Sinks

Stainless Steel Bar Sinks

Avado® Undermount SS Single Bowl Sink

- 16" Gauge
- Polished satin finish
- Sound guard undercoating
- Drains not included



Part #	Mfg #	Overall Size	Holes	Depth	Drain Opening	Min Sink Base	Price
180433	EFRU131610	16" x 18-1/2"	N/A	10"	3-1/2"	21"	

Avado® Undermount SS Single Bowl Sink with Zero Radius

- 16" Gauge
- Polished satin finish
- Sound guard undercoating
- Drains not included



Part #	Mfg #	Overall Size	Holes	Depth	Drain Opening	Min Sink Base	Price
101669	EFU131610	16" x 18-1/2"	N/A	10"	3-1/2"	21"	

Crosstown™ Dual Mount SS Single Bowl Bar Sink

- 18" Gauge
- Polished satin finish
- 1 2 MR2 3 faucet holes
- Sound gaurd undercoating
- Includes for model (ECTSR25229BG0)
-bottom grid (CTOBG2115SS)
- Drains not included



ECTSR25229BG0



ECTSR15159BG1

Part #	Mfg #	Overall Size	Holes	Depth	Drain Opening	Min Sink Base	Price
185640	ECTSR15159BG1	15" x 15"	1	9"	3-1/2"	18"	
176608	ECTSR15159BG2	15" x 15"	2	9"	3-1/2"	18"	
174828	ECTSR15159BG3	15" x 15"	3	9"	3-1/2"	18"	
172005	ECTSR25229BG0	25" x 22"	0	9"	3-1/2"	30"	
173159	ECTSR25229BG3	25" x 22"	3	9"	3-1/2"	30"	
172757	ECTSR25229BG4	25" x 22"	4	9"	3-1/2"	30"	

Crosstown™ SS Undermount Single Bowl Sink

- 18" Gauge
- Polished satin finish
- Sound gaurd opening
- Drains not included



ECTRU17179



ECTRU24179R

Part #	Mfg #	Overall Size	Holes	Depth	Drain Opening	Min Sink Base	Price
166628	ECTRU12179	13-1/2" x 18-1/2"	N/A	9"	3-1/2"	18"	
163930	ECTRU17179	18-1/2" x 18-1/2"	N/A	9"	3-1/2"	24"	
181091	ECTRU24179R	25-1/2" x 18-1/2"	N/A	9"	3-1/2"	30"	

Bar/Entertainment Stainless Steel Sinks

Gourmet® Celebrity® SS Self-Rimming Single Bowl Bar Sink

- 20" Gauge
- Brushed satin finish
- 1 2 MR2 3 4 5 faucet holes
- Fully undercoated
- Coved corners: 3" radius
- BCR150-C Package includes:
 - Bar sink (BCR15)
 - 2-Handle faucet with 5-1/2" high deck to aerator gooseneck swing spout (LKA-2479-8)
 - Basket strainer (LK-58)
- Drains not included



BCR15MR2

Part #	Mfg #	Overall Size	Holes	Depth	Drain Opening	Min Sink Base	Price
006049	BCR151	15" x 15"	1	6"	2"	18"	
006050	BCR152	15" x 15"	2	6"	2"	18"	
167582	BCR15MR2	15" x 15"	1	6"	2"	18"	

Gourmet® Celebrity® SS Self-Rimming Single Bowl Bar Sink

- 20" Gauge
- Brushed satin finish
- 1 2 MR2 3 faucet holes
- Fully undercoated
- Coved corners: 3" radius
- Drains not included



Part #	Mfg #	Overall Size	Holes	Depth	Drain Opening	Min Sink Base	Price
166695	CR17210	17" x 21-1/4"	0	6-7/8"	3-1/2"	21"	
024578	CR17211	17" x 21-1/4"	1	6-7/8"	3-1/2"	21"	
006060	CR17212	17" x 21-1/4"	2	6-7/8"	3-1/2"	21"	
006061	CR17213	17" x 21-1/4"	3	6-7/8"	3-1/2"	21"	
179262	CR1721MR2	17" x 21-1/4"	MR2	6-7/8"	3-1/2"	21"	

Gourmet® Celebrity® SS Self-Rimming Single Bowl Bar Sink

- 20" Gauge
- Brushed satin finish
- 1 2 MR2 3 4 5 faucet holes
- Fully undercoated
- Coved corners: 3" radius
- Drains not included



CR25223



DCR2522101
Deep Bowl-10-1/4"

Part #	Mfg #	Overall Size	Holes	Depth	Drain Opening	Min Sink Base	Price
006063	CR25223	25" x 22"	3	7"	3-1/2"	30"	
006064	CR25224	25" x 22"	4	7"	3-1/2"	30"	
079177	DCR2522101	25" x 22"	1	10-1/4"	3-1/2"	30"	

Sinks

Bar/Entertainment Stainless Steel Sinks

Sinks

Gourmet® Celebrity® SS Self-Rimming Single Bowl Bar Sink

- 20" Gauge
- Brushed satin finish
- 1 2 MR2 3 4 5 faucet holes
- Fully undercoated
- Coved corners: 3" radius
- Drains not included



GEGR2521RMR2



GEGR25213

Part #	Mfg #	Overall Size	Holes	Depth	Drain Opening	Min Sink Base	Price
223769	GEGR25212	25" x 21-1/4"	2	5-3/8"	3-1/2"	30"	
091941	GEGR25213	25" x 21-1/4"	3	5-3/8"	3-1/2"	30"	
172751	GEGR25214	25" x 21-1/4"	4	5-3/8"	3-1/2"	30"	
157392	GEGR2521RMR2	25" x 21-1/4"	MR2	5-3/8"	3-1/2"	30"	

Gourmet® Lustertone® Self-Rimming Single Bowl Bar Sink

- 18" Gauge
- Lustrous highlighted satin finish
- 1 2 MR2 3 faucet holes
- Fully undercoated
- Drains not included



BLR15



BLR15162

Part #	Mfg #	Overall Size	Holes	Depth	Drain Opening	Min Sink Base	Price
098244	BLR152	15" x 15"	2	7-1/8"	2"	18"	
124162	BLR15MR2	15" x 15"	MR2	7-1/8"	2"	18"	
102101	BLR153	15" x 15"	3	7-1/8"	2"	18"	
086402	BLR15162	15" x 15"	2	7-1/8"	3-1/2"	18"	
176562	BLR15602	15" x 15"	2	6-1/8"	2"	18"	

Gourmet® Lustertone® Self-Rimming SS Single Bowl Sink with No Faucet Ledge

- 18" Gauge
- Lustrous highlighted satin finish
- Fully undercoated
- Drains not included



Part #	Mfg #	Overall Size	Holes	Depth	Drain Opening	Min Sink Base	Price
170486	LFR1915	19" x 15"	0	7-5/8"	3-1/2"	24"	

Gourmet® Lustertone® Self-Rimming SS Single Bowl Sink

- 18" Gauge
- Lustrous highlighted satin finish
- 1 2 MR2 3 faucet holes
- Fully undercoated
- Drains not included



Part #	Mfg #	Overall Size	Holes	Depth	Drain Opening	Min Sink Base	Price
167811	LR13161	13" x 16"	1	7-5/8"	3-1/2"	18"	
092351	LR15172	15" x 17-1/2"	2	7-5/8"	3-1/2"	18"	

Bar/Entertainment Stainless Steel Sinks

Stainless Steel Bar Sinks (Continued)

Gourmet® Lustertone® Self-Rimming SS Single Bowl Sink

Part #	Mfg #	Overall Size	Holes	Depth	Drain Opening	Min Sink Base	Price
085623	LR15173	15" x 17-1/2"	3	7-5/8"	3-1/2"	18"	

Gourmet® Lustertone® Self-Rimming SS Single Bowl Sink—No Faucet Holes

- 18" Gauge
- Lustrous highlighted satin finish
- 1 2 MR2 3 OS4 faucet holes
- Fully undercoated
- Drains not included



Part #	Mfg #	Overall Size	Holes	Depth	Drain Opening	Min Sink Base	Price
065717	LR1720	17" x 20"	0	7-5/8"	3-1/2"	21"	
077057	LR1722	17" x 22"	0	7-5/8"	3-1/2"	21"	
106165	LR1918	19" x 18"	0	7-1/2"	3-1/2"	24"	
064279	LR2022	19-1/2" x 22"	0	7-5/8"	3-1/2"	24"	
064278	LR2222	22" x 22"	0	7-5/8"	3-1/2"	27"	

Gourmet® Lustertone® Self-Rimming SS Single Bowl Sink—One Faucet Holes

- 18" Gauge
- Lustrous highlighted satin finish
- 1 2 MR2 3 OS4 faucet holes
- Fully undercoated
- Drains not included



Part #	Mfg #	Overall Size	Holes	Depth	Drain Opening	Min Sink Base	Price
098542	LR20221	19-1/2" x 22"	1	7-5/8"	3-1/2"	24"	

Gourmet® Lustertone® Self-Rimming SS Single Bowl Sink—Two Faucet Holes

- 18" Gauge
- Lustrous highlighted satin finish
- 1 2 MR2 3 OS4 faucet holes
- MR2 holes are offset right
- Fully undercoated
- Drains not included



Part #	Mfg #	Overall Size	Holes	Depth	Drain Opening	Min Sink Base	Price
098824	LR17202	17" x 20"	2	7-5/8"	3-1/2"	21"	
187901	LR1716MR2	17" x 16"	MR2	7-5/8"	3-1/2"	21"	
006133	LR17222	17" x 22"	2	7-5/8"	3-1/2"	21"	
134834	LR1722MR2	17" x 22"	MR2	7-5/8"	3-1/2"	21"	
113491	LR19192	19-1/2" x 19"	2	7-1/2"	3-1/2"	24"	
170721	LR1919PD2	19-1/2" x 19"	2	7-1/2"	3-1/2"	24"	
223669	LR2022MR2	19-1/2" x 22"	1	7-5/8"	3-1/2"	24"	
108213	LR22192	22" x 19-1/2"	2	7-5/8"	3-1/2"	27"	
187900	LR2521MR2	25" x 21-1/4"	MR2	7-7/8"	3-1/2"	30"	

Sinks

Bar/Entertainment Stainless Steel Sinks

Sinks

Gourmet® Lustertone® Self-Rimming SS Single Bowl Sink—Three Faucet Holes

- 18" Gauge
- Lustrous highlighted satin finish
- 1 2 MR2 3 OS4 faucet holes
- Fully undercoated
- Drains not included



LR17163

Part #	Mfg #	Overall Size	Holes	Depth	Drain Opening	Min Sink Base	Price
120161	LR17163	17" x 16"	3	7-5/8"	3-1/2"	21"	
176888	LR17223	17" x 22"	3	7-5/8"	3-1/2"	21"	
095325	LR19183	19" x 18"	3	7-1/2"	3-1/2"	24"	
088756	LR19193	19-1/2" x 19"	3	7-1/2"	3-1/2"	24"	
089074	LR22193	22" x 19-1/2"	3	7-5/8"	3-1/2"	27"	
089902	LR22223	22" x 22"	3	7-5/8"	3-1/2"	27"	
095309	LR25213	25" x 21-1/4"	3	7-7/8"	3-1/2"	30"	
099505	LR25223	25" x 22"	3	8-1/8"	3-1/2"	30"	

Gourmet® Lustertone® Self-Rimming SS Single Bowl Sink—Four Faucet Holes

- 18" Gauge
- Lustrous highlighted satin finish
- 1 2 MR2 3 OS4 faucet holes
- Fully undercoated
- OS4 holes are evenly dispersed across faucet
- Drains not included



LR22224

Part #	Mfg #	Overall Size	Holes	Depth	Drain Opening	Min Sink Base	Price
027061	LR1720OS4	17" x 20"	OS4	7-5/8"	3-1/2"	21"	
151049	LR1722OS4	17" x 22"	OS4	7-5/8"	3-1/2"	21"	
033862	LR22224	22" x 22"	4	7-5/8"	3-1/2"	27"	

Gourmet® Lustertone® Self-Rimming ADA Single Bowl Sink—One Faucet Hole

- 18" Gauge
- Lustrous highlighted satin finish
- 1 2 MR2 3 OS4 faucet holes (models 1716, 1720, 1918, 1919, 2022, 2219)
- 1 2 MR2 2 4 5 faucet holes (models 2219, 2521)
- 1 2 MR2 3 faucet holes (models 1517)
- Fully undercoated
- Drains not included



LRAD1517651

LRAD2521651

Part #	Mfg #	Overall Size	Holes	Depth	Drain Opening	Min Sink Base	Price
143335	LRAD1517651	15" x 17-1/2"	1	6-1/2"	3-1/2"	18"	
224400	LRAD1716651	17" x 16"	1	6-1/2"	3-1/2"	21"	
167162	LRAD1720551	17" x 20"	1	5-1/2"	3-1/2"	21"	
157348	LRAD1918601	19" x 18"	1	6"	3-1/2"	24"	
178361	LRAD1918651	19" x 18"	1	6-1/2"	3-1/2"	24"	
185425	LRAD1919651	19-1/2" x 19"	1	6-1/2"	3-1/2"	24"	
155638	LRAD2022601	19-1/2" x 22"	1	6"	3-1/2"	24"	
174677	LRAD2219551	22" x 19-1/2"	1	5-1/2"	3-1/2"	27"	
152025	LRAD2219601	22" x 19-1/2"	1	6"	3-1/2"	27"	

Bar/Entertainment Stainless Steel Sinks

Stainless Steel Bar Sinks (Continued)

Gourmet® Lustertone® Self-Rimming ADA Single Bowl Sink—One Faucet Hole

Part #	Mfg #	Overall Size	Holes	Depth	Drain Opening	Min Sink Base	Price
210404	LRAD2521551	25" x 21-1/4"	1	5-1/2"	3-1/2"	30"	
122978	LRAD2521651	25" x 21-1/4"	1	6-1/2"	3-1/2"	30"	

Gourmet® Lustertone® Self-Rimming ADA Single Bowl Sink—Two Faucet Holes

- 18" Gauge
- Lustrous highlighted satin finish
- 1 2 MR2 3 OS4 faucet holes (models 1716, 1720, 1722, 1918, 1919)
- 1 2 MR2 3 4 5 faucet holes (models 2219, 2222, 2522)
- 1 2 MR2 3 faucet holes (models 1316, 1517)
- OS4 holes are evenly spread across faucet top
- MR2 holes are offset to the right
- Fully undercoated
- Drains not included



LRAD1316602



LRAD2522552

Part #	Mfg #	Overall Size	Holes	Depth	Drain Opening	Min Sink Base	Price
158828	LRAD1316602	13" x 16"	2	6"	3-1/2"	18"	
131530	LRAD1517552	15" x 17-1/2"	2	5-1/2"	3-1/2"	18"	
186047	LRAD1522552	15" x 22"	2	5-1/2"	3-1/2"	18"	
155841	LRAD1716652	17" x 16"	2	6-1/2"	3-1/2"	21"	
181188	LRAD1720552	17" x 20"	2	5-1/2"	3-1/2"	21"	
151473	LRAD1722552	17" x 22"	2	5-1/2"	3-1/2"	21"	
158274	LRAD1918652	19" x 18"	2	6-1/2"	3-1/2"	24"	
156430	LRAD191865MR2	19" x 18"	MR2	6-1/2"	3-1/2"	24"	
157831	LRAD191965MR2	19-1/2" x 19"	MR2	6-1/2"	3-1/2"	24"	
180925	LRAD2219602	22" x 19-1/2"	2	6"	3-1/2"	27"	
185800	LRAD221960MR2	22" x 19-1/2"	MR2	6"	3-1/2"	27"	
103157	LRAD2219652	22" x 19-1/2"	2	6-1/2"	3-1/2"	27"	
160562	LRAD221965MR2	22" x 19-1/2"	MR2	6-1/2"	3-1/2"	27"	
157832	LRAD222265MR2	22" x 22"	MR2	6-1/2"	3-1/2"	27"	
172756	LRAD2522552	25" x 22"	2	5-1/2"	3-1/2"	30"	
171498	LRADQ1517552	15" x 17-1/2"	2	5-1/2"	3-1/2"	18"	
171462	LRADQ1918652	19" x 18"	2	6-1/2"	3-1/2"	24"	

Sinks

Bar/Entertainment Stainless Steel Sinks

Sinks

Gourmet® Lustertone® Self-Rimming ADA Single Bowl Sink—Three Faucet Holes

- 18" Gauge
- Lustrous highlighted satin finish
- 1 2 MR2 3 (models 1517, 1522)
- 1 2 MR2 3 OS4 faucet holes (models 1716, 1722, 1918, 1919)
- 1 2 MR2 3 4 5 faucet holes (models 2219, 2222, 2521, 2522)
- OS4 holes are evenly spread across faucet top
- MR2 holes are offset to the right
- Fully undercoated
- Drains not included



LRAD1722403

Part #	Mfg #	Overall Size	Holes	Depth	Drain Opening	Min Sink Base	Price
188992	LRAD1517503	15" x 17-1/2"	3	5"	3-1/2"	18"	
175207	LRAD1517553	15" x 17-1/2"	3	5-1/2"	3-1/2"	18"	
141402	LRAD1517653	15" x 17-1/2"	3	6-1/2"	3-1/2"	18"	
157684	LRAD1522603	15" x 22"	3	6"	3-1/2"	18"	
092207	LRAD1716603	17" x 16"	3	6"	3-1/2"	21"	
190481	LRAD1722403	17" x 22"	3	4"	3-1/2"	21"	
166124	LRAD1722553	17" x 22"	3	5-1/2"	3-1/2"	21"	
140449	LRAD1722653	17" x 22"	3	6-1/2"	3-1/2"	21"	
107885	LRAD1918653	19" x 18"	3	6-1/2"	3-1/2"	24"	
150690	LRAD1919653	19-1/2" x 19"	3	6-1/2"	3-1/2"	24"	
222840	LRAD2219403	22" x 19-1/2"	3	4"	3-1/2"	27"	
175206	LRAD2219553	22" x 19-1/2"	3	5-1/2"	3-1/2"	27"	
127949	LRAD2219653	22" x 19-1/2"	3	6-1/2"	3-1/2"	27"	
115453	LRAD2222653	22" x 22"	3	6-1/2"	3-1/2"	27"	
189491	LRAD2521403	25" x 21-1/4"	3	4"	3-1/2"	30"	
188991	LRAD2521503	25" x 21-1/4"	3	5"	3-1/2"	30"	
167416	LRAD2522553	25" x 22"	3	5-1/2"	3-1/2"	30"	
224377	LRAD2522603	25" x 22"	3	6"	3-1/2"	30"	
068904	LRADQ2219553	22" x 19-1/2"	3	5-1/2"	3-1/2"	27"	
138901	LRADQ2219653	22" x 19-1/2"	3	6-1/2"	3-1/2"	27"	
222730	LRADQ2521403	25" x 21-1/4"	3	4"	3-1/2"	30"	

Gourmet® Lustertone® Self-Rimming ADA Single Bowl Sink—Four Faucet Holes

- 18" Gauge
- Lustrous highlighted satin finish
- 1 2 MR2 3 4 5 faucet holes
- 1 2 MR2 3 OS4 faucet holes (models 1720 & 1722)
- OS4 holes are evenly spread across faucet top
- MR2 holes are offset to the right
- Fully undercoated
- Drains not included



LRADQ2222504

Part #	Mfg #	Overall Size	Holes	Depth	Drain Opening	Min Sink Base	Price
226990	LRAD172055OS4	17" x 20"	OS4	5-1/2"	3-1/2"	21"	
185172	LRAD172255OS4	17" x 22"	OS4	5-1/2"	3-1/2"	21"	
130331	LRAD2219654	22" x 19-1/2"	4	6-1/2"	3-1/2"	27"	

Bar/Entertainment Stainless Steel Sinks

Stainless Steel Bar Sinks (Continued)

Gourmet® Lustertone® Self-Rimming ADA Single Bowl Sink—Four Faucet Holes

Part #	Mfg #	Overall Size	Holes	Depth	Drain Opening	Min Sink Base	Price
224381	LRAD2522604	25" x 22"	4	6"	3-1/2"	30"	
154692	LRADQ2222504	22" x 22"	4	5"	3-1/2"	27"	
154757	LRADQ2222604	22" x 22"	4	6"	3-1/2"	27"	
172885	LRADQ2522654	25" x 22"	4	6-1/2"	3-1/2"	30"	

Gourmet® Lustertone® Self-Rimming ADA Single Bowl Sink—Five Faucet Holes

- 18" Gauge
- Lustrous highlighted satin finish
- 1 2 MR2 3 4 5 faucet holes
—MR2 holes are offset to the right
- Fully undercoated
- Drains not included



Part #	Mfg #	Overall Size	Holes	Depth	Drain Opening	Min Sink Base	Price
173304	LRAD2521605	25" x 21-1/4"	5	6"	3-1/2"	30"	

Gourmet® Lustertone® Self-Rimming SS Deep Single Bowl Sink

- 18" gauge
- Lustrous highlighted satin finish
- 1 2 MR2 3 4 5 faucet holes
- 1 2 MR2 3 faucet holes (**model 151710**)
- 1 2 MR2 3 OS4 faucet hole (**models 171610, 172010, 172210, & 202210**)
- Fully undercoating
- Drains not included unless **(PD)** appears in model number



Part #	Mfg #	Overall Size	Holes	Depth	Drain Opening	Min Sink Base	Price
116652	DLR1517102	15" x 17-1/2"	2	10"	3-1/2"	18"	
162110	DLR1716102	17" x 16"	2	10-1/8"	3-1/2"	21"	
088464	DLR1716103	17" x 16"	3	10-1/8"	3-1/2"	21"	
223922	DLR1720101	17" x 20"	1	10-1/8"	3-1/2"	21"	
051426	DLR1722101	17" x 22"	1	10-1/8"	3-1/2"	21"	
166123	DLR1722103	17" x 22"	3	10-1/8"	3-1/2"	21"	
128819	DLR172210MR2	17" x 22"	MR2	10-1/8"	3-1/2"	21"	
152633	DLFR191810	19" x 18"	0	10-1/8"	3-1/2"	24"	
098818	DLR2022101	19-1/2" x 22"	1	10-1/8"	3-1/2"	24"	
143137	DLR202210MR2	19-1/2" x 22"	MR2	10-1/8"	3-1/2"	24"	
101046	DLR2219100	22" x 19-1/2"	0	10-1/8"	3-1/2"	27"	
141322	DLR2219101	22" x 19-1/2"	1	10-1/8"	3-1/2"	27"	
096392	DLR2219103	22" x 19-1/2"	3	10-1/8"	3-1/2"	27"	
110513	DLR221910MR2	22" x 19-1/2"	MR2	10-1/8"	3-1/2"	27"	
038381	DLR2222101	22" x 22"	1	10-1/8"	3-1/2"	27"	
048606	DLR2222102	22" x 22"	2	10-1/8"	3-1/2"	27"	
047469	DLR2222103	22" x 22"	3	10-1/8"	3-1/2"	27"	
167418	DLR2222104	22" x 22"	4	10-1/8"	3-1/2"	27"	
100884	DLR2222120	22" x 22"	0	12"	3-1/2"	27"	

Sinks

Bar/Entertainment Stainless Steel Sinks

Stainless Steel Bar Sinks (Continued)

Gourmet® Lustertone® Self-Rimming SS Deep Single Bowl Sink

Part #	Mfg #	Overall Size	Holes	Depth	Drain Opening	Min Sink Base	Price
178712	DLR2222121	22" x 22"	1	12"	3-1/2"	27"	
185407	DLR2222122	22" x 22"	2	12"	3-1/2"	27"	
133137	DLR2222124	22" x 22"	4	12"	3-1/2"	27"	
172516	DLR2521104	25" x 21-1/4"	4	10-1/8"	3-1/2"	30"	
224148	DLR252110PD3	25" x 21-1/4"	3	10-1/8"	3-1/2"	30"	
103335	DLR2522101	25" x 22"	1	10-3/8"	3-1/2"	30"	
110857	DLR2522103	25" x 22"	3	10-3/8"	3-1/2"	30"	
047543	DLR2522121	25" x 22"	1	12-1/8"	3-1/2"	30"	

Gourmet® Slim Rim Dual-Mount SS Single Bowl Sink

- 18" Gauge
- Lustrous highlighted satin finish
- 1 2 MR2 3 4 5 faucet holes
- Sound gaurd undercoating
- Slim rim — ultra-thin edge virtually eliminates the barrier between sink and countertop
- Models with **(PD)** included in number have perfect drain kits
- Drains not included unless **(PD)** appears in model number



Part #	Mfg #	Overall Size	Holes	Depth	Drain Opening	Min Sink Base	Price
159221	DLSR2722104	27" x 22"	4	10"	3-1/2"	30"	
226238	DLSR272210PD	27" x 22"	0	10"	3-1/2"	30"	
226684	DLSR272210PD3	27" x 22"	3	10"	3-1/2"	30"	
174185	LSR27222	27" x 22"	2	8"	3-1/2"	30"	

Gourmet® Undermount SS Single Bowl Sink

- 18" Gauge
- Lustrous highlighted satin finish
- Sound gaurd undercoating
- Fully undercoated with pad(s) (**ELUHAD** models)
- **ELUHAD** model is ADA compliant
- Includes:
Perfect drain kit (**ELUH1814PD** model)
- Drains not included unless **(PD)** appears in model number



Part #	Mfg #	Overall Size	Holes	Depth	Drain Opening	Min Sink Base	Price
169886	ELUH1814PD	20-1/2 x 16-1/2"	N/A	7-7/8"	3-1/2"	24"	
161792	ELUH2416	26-1/2" x 18-1/2"	N/A	8"	3-1/2"	30"	
159293	ELUHAD141455	16-1/2" x 16-1/2"	N/A	5-1/2"	3-1/2"	21"	
159264	ELUHAD191655	21-1/2" x 18-1/2"	N/A	5-1/2"	3-1/2"	27"	
168722	ELUH241610	26-1/2" x 18-1/2"	N/A	10"	3-1/2"	30"	

Bar/Entertainment Stainless Steel Sinks

Gourmet® Lustertone® Undermount SS Single Bowl Sink

- 18" Gauge
- Lustrous highlighted satin finish
- Sound guard undercoating
- Drains not included



Part #	Mfg #	Overall Size	Holes	Depth	Drain Opening	Min Sink Base	Price
159292	ELUHAD211555	23-1/2" x 18-1/4"	N/A	5-1/2"	3-1/2"	27"	

Gourmet® Stainless Steel Undermount Bar Sink

- 18" Gauge
- Hammered mirror finish
- Fully undercoated
- Drains not included



Part #	Mfg #	Overall Size	Holes	Depth	Drain Opening	Min Sink Base	Price
097413	SCUH1012SH	12" x 14"	N/A	6-1/2"	3-1/2"	15"	
087339	SCUH1212SH	14-1/8" x 14-1/8"	N/A	6-1/2"	3-1/2"	18"	
083010	SCUH1416SH	16" x 18"	N/A	7-1/2"	3-1/2"	21"	

Gourmet® Lustertone® Undermount SS Single Bowl Sink

- 18" Gauge
- Lustrous highlighted satin finish
- Sound guard undercoating
- Includes:
 - E-dock (for models **ELUH 231712L** & **ELUH281610** only)
 - Perfect drain (for models **ELUH281610PD** & **ELUH1316PD**)
- Drains not included unless **(PD)** appears in model number



ELUH1616



ELUH231712L

Part #	Mfg #	Overall Size	Holes	Depth	Drain Opening	Min Sink Base	Price
026880	ELUH1316	16" x 18-1/2"	N/A	7-7/8"	3-1/2"	21"	
177205	ELUH1316PD	16" x 18-1/2"	N/A	7-7/8"	3-1/2"	21"	
088798	ELUH1616	18-1/2" x 18-1/2"	N/A	7-7/8"	3-1/2"	24"	
132390	ELUH1814	20-1/2" x 16-1/2"	N/A	7-7/8"	3-1/2"	24"	
080555	ELUH2115	23-1/2" x 18-1/4"	N/A	7-1/2"	3-1/2"	27"	
157421	ELUH211510	23-1/2" x 18-1/4"	N/A	10"	3-1/2"	27"	
146047	ELUH231710R	25-1/2" x 19-1/4"	N/A	10"	3-1/2"	27"	
179679	ELUH231712L	25-1/2" x 19-1/4"	N/A	12"	3-1/2"	27"	

Gourmet® Lustertone® Undermount SS Single Bowl Sink

- 18" Gauge
- Lustrous highlighted satin finish
- Sound guard undercoating
- Fully undercoated with pad(s) (for model **ELUHAD121250**)
- Drains not included unless **(PD)** appears in model number



ELUHAD121250



ELUHAD131645PD

Part #	Mfg #	Overall Size	Holes	Depth	Drain Opening	Min Sink Base	Price
170066	ELUHAD121250	14-1/2" x 14-1/2"	N/A	5"	3-1/2"	18"	
187025	ELUHAD121255	14-1/2" x 14-1/2"	N/A	5-1/2"	3-1/2"	18"	

Sinks

Bar/Entertainment Stainless Steel Sinks

Stainless Steel Bar Sinks (Continued)

Gourmet® Lustertone® Undermount SS Single Bowl Sink

Part #	Mfg #	Overall Size	Holes	Depth	Drain Opening	Min Sink Base	Price
180779	ELUHAD131645PD	16" x 18-1/2"	N/A	4-1/2"	3-1/2"	21"	
156503	ELUHAD131655	16" x 18-1/2"	N/A	5-1/2"	3-1/2"	21"	
181343	ELUHAD131655PD	16" x 18-1/2"	N/A	5-1/2"	3-1/2"	21"	
157842	ELUHAD141850	16-1/2" x 20-1/2"	N/A	5"	3-1/2"	21"	

Gourmet® Pacemaker® SS Self-Rimming Single Bowl Sink

- 20" Gauge
- Bright satin finish
- 1 2 MR2 3 4 5 faucet holes
- 1 2 MR2 3 OS4 faucet holes (models 1716, 1720 & 1722, 19182)
- 1 2 MR2 3 faucet holes (models BPSR15, PSR1517)
- Fully undercoated
- Drains not included



PSR2522MR2



BPSR152

Part #	Mfg #	Overall Size	Holes	Depth	Min Sink Base	Mount Type	Price
050396	BPSR152	15" x 15"	2	6-1/8"	2"	18"	
006148	PSR15173	15" x 17-1/2"	3	7-1/8"	3-1/2"	18"	
054097	PSR17202	17" x 20"	2	7-1/8"	3-1/2"	21"	
020930	PSR17203	17" x 20"	3	7-1/8"	3-1/2"	21"	
177031	PSR1720MR2	17" x 20"	MR2	7-1/8"	3-1/2"	21"	
075557	PSR17221	17" x 22"	1	7-1/8"	3-1/2"	21"	
097649	PSR17222	17" x 22"	2	7-1/8"	3-1/2"	21"	
006151	PSR17223	17" x 22"	3	7-1/8"	3-1/2"	21"	
225852	PSR1722MR2	17" x 22"	MR2	7-1/8"	3-1/2"	21"	
006152	PSR19182	19" x 18"	2	7-1/8"	3-1/2"	24"	
016430	PSR19183	19" x 18"	3	7-1/8"	3-1/2"	24"	
186724	PSR1918MR2	19" x 18"	MR2	7-1/8"	3-1/2"	24"	
006153	PSR22193	22" x 19-1/2"	3	7-1/8"	3-1/2"	27"	
124600	PSR2219MR2	22" x 19-1/2"	MR2	7-1/8"	3-1/2"	27"	
079174	PSR25221	25" x 22"	1	7-1/2"	3-1/2"	30"	
006156	PSR25223	25" x 22"	3	7-1/2"	3-1/2"	30"	
110215	PSR2522MR2	25" x 22"	MR2	7-1/2"	3-1/2"	30"	

Gourmet® Slim Rim Dual-Mount Deep Single Bowl Sink

- 20" Gauge
- Bright satin finish
- Fully undercoated
- Drains not included



Part #	Mfg #	Overall Size	Holes	Depth	Drain Opening	Min Sink Base	Price
155643	DPSSR2722101	27" x 22"	1	10"	3-1/2"	30"	

Bar/Entertainment Stainless Steel Sinks

The Mystic® Lustertone® SS Undermount Single Bowl Sink

- 18" Gauge
- Lustrous highlighted satin finish
- Sound guard undercoating
- FB-flat bottom sink
- Drains not included



Part #	Mfg #	Overall Size	Depth	Drain Opening	Min Sink Base	Description	Price
079941	ELUH16FB	18-3/8" x 18-3/8"	N/A	8"	3-1/2"	24"	

The Mystic® Lustertone SS Self-Rimming Single Bowl Sink

- 18 Gauge
- Lustrous highlighted satin finish
- Fully undercoated
- ADA compliant



Part #	Mfg #	Overall Size	Holes	Depth	Drain Opening	Min Sink Base	Price
153111	RLR12FB	14-3/8" x 14-3/8"	0	6"	3-1/2"	18"	

The Mystic® Undermount SS Single Bowl Bar Sink

- 18" Gauge
- Soft highlighted satin finish
- Sound guard undercoating



Part #	Mfg #	Overall Size	Holes	Depth	Drain Opening	Min Sink Base	Price
222957	EGUH16FB	16-1/4" x 16-1/4"	N/A	7"	3-1/2"	21"	

Double Bowl Stainless Steel Bar Sinks

Gourmet® Lustertone® Self-Rimming Equal Double Bowl Sink

- 18" Gauge
- Lustrous highlighted satin finish
- 1 2 MR2 3 4 5 faucet holes
- Fully undercoated
- AD models are ADA compliant
- Drains not included



LR25193

Part #	Mfg #	Overall Size	Holes	Depth	Drain Opening	Min Sink Base	Price
115362	LR25193	25" x 19-1/2"	3	7-5/8"	3-1/2"	30"	
115313	LR25194	25" x 19-1/2"	4	7-5/8"	3-1/2"	30"	
027640	LR29182	29" x 18"	2	7-5/8"	3-1/2"	33"	
100426	LR29183	29" x 18"	3	7-5/8"	3-1/2"	33"	
185790	LRAD291845MR2	29" x 18"	MR2	4-1/2"	3-1/2"	33"	
128316	LRAD2918554	29" x 18"	4	5-1/2"	3-1/2"	33"	
136724	LRAD2918654	29" x 18"	4	6-1/2"	3-1/2"	33"	
142330	LRAD2922602	29 x 22"	2	6"	3-1/2"	33"	
189697	LRADQ2918554	29" x 18"	4	5-1/2"	3-1/2"	33"	

Sinks

Bar/Entertainment Stainless Steel Sinks

Harmony™ Lustertone® Undermount SS Double Bowl Sink

- 18" Gauge
- Lustrous highlighted satin finish
- Sound guard undercoating
- Drains not included



Sinks

Part #	Mfg #	Overall Size	Holes	Depth	Drain Opening	Min Sink Base	Price
137228	ELUH272010R	26-3/4" x 20"	N/A	10"	3-1/2"	30"	

Bar/Entertainment Composite Sinks

Bar Sinks

Diamond™ SILGRANIT® II Bar Sink

- Versatile dual deck design can be installed as a drop-in or undermount
- Cutout size: 14-1/4" x 14-1/4"
- Under-mount clips NOT included



Part #	Mfg#	Overall Dimensions	Bowl Depth	Cabinet Size	Color	Price
147697	440205	15" x 15"	8"	17"	White	
089383	440204	15" x 15"	8"	17"	Anthracite	
147696	440203	15" x 15"	8"	17"	Metallic Gray	
143337	440202	15" x 15"	8"	17"	Cafe Brown	
129149	440206	15" x 15"	8"	17"	Biscuit	
144733	441219	15" x 15"	8"	17"	Biscotti	
147698	441295	15" x 15"	8"	17"	Truffle	
170401	441477	15" x 15"	8"	17"	Cinder	

Performa™ Single Bowl Bar Sink

- Under-mount clips included
- Cut out template included



Part #	Mfg#	Overall Dimensions	Bowl Depth	Cabinet Size	Color	Price
120416	440079	17-1/2" x 17"	9"	21"	Anthracite	
137265	440080	17-1/2" x 17"	9"	21"	Biscuit	
142902	440081	17-1/2" x 17"	9"	21"	White	
135196	440082	17-1/2" x 17"	9"	21"	Metallic Gray	
131541	441224	17-1/2" x 17"	9"	21"	Biscotti	
138247	441288	17-1/2" x 17"	9"	21"	Truffle	
172957	441475	17-1/2" x 17"	9"	21"	Cinder	
120697	440078	17-1/2" x 17"	9"	21"	Cafe Brown	

Rondo™ SILGRANIT® II Bar Sink

- Versatile dual deck design can be installed as drop-in or undermount
- Cutout size: 16-15/16"
- Under-mount clips NOT included



Part #	Mfg#	Overall Dimensions	Bowl Depth	Cabinet Size	Color	Price
069561	511632	17-11/16"	6-5/8"	18"	Anthracite	
152015	513382	17-11/16"	6-5/8"	18"	Metallic Gray	
114488	515803	17-11/16"	6-5/8"	18"	Cafe Brown	
154338	513381	17-11/16"	6-5/8"	18"	Biscuit	
133060	517143	17-11/16"	6-5/8"	18"	Biscotti	

Bar/Entertainment Composite Sinks

Bar Sinks (Continued)
Rondo™ SILGRANIT® II Bar Sink

Part #	Mfg#	Overall Dimensions	Bowl Depth	Cabinet Size	Color	Price
177852	518911	17-11/16"	6-5/8"	18"	Cinder	

Precis™ SILGRANIT® II Medium Under-Mount Sink

- Under-mount installation clips included
- Cutout size: template provided



Part #	Mfg#	Overall Dimensions	Bowl Depth	Cabinet Size	Color	Price
139737	513422	13-3/4" x 18"	7-1/2"	18"	White	
097175	513424	13-3/4" x 18"	7-1/2"	18"	Anthracite	
152175	513425	13-3/4" x 18"	7-1/2"	18"	Metallic Gray	
117593	515653	13-3/4" x 18"	7-1/2"	18"	Cafe Brown	
149679	513423	13-3/4" x 18"	7-1/2"	18"	Biscuit	
164981	517110	13-3/4" x 18"	7-1/2"	18"	Biscotti	
152059	517676	13-3/4" x 18"	7-1/2"	18"	Truffle	

Precis™ SILGRANIT® II Large Under-Mount Sink

- Under-mount installation clips included
- Cutout template included with 1/8" reveal



Part #	Mfg#	Overall Dimensions	Bowl Depth	Cabinet Size	Color	Price
142666	513426	20-3/4" x 18"	7-1/2"	24"	White	
100106	513428	20-3/4" x 18"	7-1/2"	24"	Anthracite	
109579	513429	20-3/4" x 18"	7-1/2"	24"	Metallic Gray	
156209	515652	20-3/4" x 18"	7-1/2"	24"	Cafe Brown	
108828	513427	20-3/4" x 18"	7-1/2"	24"	Biscuit	
139471	517109	20-3/4" x 18"	7-1/2"	24"	Biscotti	
147871	517677	20-3/4" x 18"	7-1/2"	24"	Truffle	
170935	519049	20-3/4" x 18"	7-1/2"	24"	Cinder	

Blanco Precis™ Medium Single with Drainer

- Dual-Mount installation
- Reversible for greater flexibility
- Integrated drain board, drying/draining



Part #	Mfg#	Overall Dimensions	Bowl Depth	Cabinet Size	Color	Price
222118	520851	30-11/16" x 19-11/16"	7-1/2"	27"	Cinder	

Bar/Entertainment Composite Sinks

Vision™ SILGRANIT II® Large Under-Mount Sink

- Under-mount installation clips included
- Cutout template included



Part #	Mfg#	Overall Dimensions	Bowl Depth	Cabinet Size	Color	Price
161635	441367	24" x 18"	7-3/4"	27"	Anthracite	
152416	441369	24" x 18"	7-3/4"	27"	Cafe Brown	
160364	441368	24" x 18"	7-3/4"	27"	Biscotti	
173643	441370	24" x 18"	7-3/4"	27"	Truffle	
161215	441472	24" x 18"	7-3/4"	27"	Cinder	

Sinks

Commercial Stainless Steel Sinks

Stainless Steel Scrub and Handwash Sinks

Wall-Mount SS Handwash Sink

- 20" gauge
- Basin has 1-3/4" radius coved corners
- 7" High backsplash
- Buffed satin finish
- Exposed surfaces have a brushed finish
- Includes wall-hanger
- **CHS1716LRSC** comes with sidesplashes



No Faucet Holes (CHS17160)



CHS17161

- **CHSB1716C** Includes a chrome-plated gooseneck spout faucet with aerator

Part #	Mfg #	Overall Size	Holes	Depth	Drain Opening	Price
177259	CHS17160	16-3/4" x 15-1/2"	0	13"	2"	
051347	CHS17161	16-3/4" x 15-1/2"	1	13"	2"	
054177	CHS1716C	16-3/4" x 15-1/2"	2	13"	2"	
173847	CHS1716LRSC	16-3/4" x 15-1/2"	2	13"	2"	
128656	CHSB1716C	16-3/4" x 15-1/2"	2	13"	2"	

Stainless Steel Rectangular Single Compartment Handwash Sink

- 18" Gauge
- Buffed satin finish
- 1 2 CS3 faucet holes
- 1-3/4" Coved corners
- 2-1/2" High backsplash, 2-1/2" apron front and sides
- Front and side decks with raised rim
- Sound absorbing pads
- Rear centered outlet
- Includes wall hanger and intgral stainless steel support brackets
- NSF certified
- Drains not included



Part #	Mfg #	Overall Size	Holes	Depth	Drain Opening	Price
075960	ELVWO2219CS3	22" x 19"	CS3	5-1/2"	1-1/2", Overflow	

Sinks

Commercial Stainless Steel Sinks

Stainless Steel Rectangular Single Compartment Handwash Sink with No Faucet Holes

- 18" Gauge
- Buffed satin finish
- 1-3/4" Coved corners
- 2-1/2" High backsplash, 2-1/2" apron front and sides
- Front and side decks with raised rim
- Sound absorbing pads
- Rear centered outlet
- Includes wall hanger and intgral stainless steel support brackets
- NSF certified
- Drains not included



Sinks

Part #	Mfg #	Overall Size	Holes	Depth	Drain Opening	Price
174678	ELV22190	22" x 19"	0	5-1/2"	1-1/2", No Overflow	

Commercial Stainless Steel Multiple Station Hand Wash Sink

- Four station wash sink
- 14" Gauge
- Buffed satin finish
- 1/4" Coved corners
- 1-1/2" Wide inward sloping tio channel rims with 2" flat apron
- 10" Backsplash
- Square rim corners
- Slanted front
- Includes wall hangers and stainless steel support brackets



Part #	Mfg #	Overall Size	Holes	Depth	Drain Opening	Price
186325	EWMA96208	96" x 20"	8-Hole	93"	8" 3-1/2"	

Commercial Sensor Faucet Stainless Steel Single Compartment Wash Sink

- 16" Gauge
- Buffed satin finish
- Wall hanger
- Slant-front design
- Keyed access door(s) to hide plumbing
- Coved corners
- 4" Backsplash
- Undercoated for maximum sound deadening
- Full enclosure
- Model includes **LK188** drain



Part #	Mfg #	Overall Size	Holes	Depth	Drain Opening	Price
188663	EWSF13026SACC	30" x 20"	1-Hole	26"	11" 3-1/2"	

Commercial Stainless Steel Sinks

Sinks

48" Two Station Stainless Steel Wash Sink

- 14" Gauge, 304 stainless steel
- Lustrous buffed satin finish
- 1/4" Coved corners
- 1-1/2" Wide inward sloping top channel rims, with 2" flat apron
- 10" High, full length backsplash
- Square rim corners
- Slanted front
- Furnished with wall hangers and stainless steel support brackets



Part #	Mfg #	Overall Size	Holes	Depth	Drain Opening	Price
076819	EWMA48202	48" x 20"	2-Hole	45"	8" 3-1/2"	

48" Two Station Wash Sink—Sensor Faucet Package

- 14" Gauge, 304 stainless steel
- Lustrous buffed satin finish
- 1/4" Coved corners
- 1-1/2" Wide inward sloping top channel rims, with 2" flat apron
- 10" High, full length backsplash
- Square rim corners
- Slanted front
- Furnished with wall hangers and stainless steel support brackets
- Model includes:
 - (2) **LKB722C** sensor faucets
 - AC/battery power
 - Thermostatic mixing valves



Part #	Mfg #	Overall Size	Holes	Depth	Drain Opening	Price
187263	EWMA4820SACTM C	48" x 20"	1-Hole	45"	8" 3-1/2"	

Commercial Foodservice Scrub and Handwash sinks

Foodservice Stainless Steel Economy Series Handwash Sink with Gooseneck Faucet

- 18" Gauge
- 6" Backsplash with 2" return
- Faucet and strainer included
- Z-clip mounting bracket
- NSF certified



Part #	Mfg #	Overall Size	Holes	Depth	Drain Opening	Price
132730	EHS14X	14" x 16-1/2"	11"	5"	1-1/2"	
142566	EHS18X	18" x 14-1/2"	11"	5"	1-1/2"	

Commercial Stainless Steel Sinks

Foodservice Stainless Steel Economy Series Handwash Sink—Hands Free

- 18" Gauge
- 6" Backsplash with 2" return
- Includes:
 - Strainer
 - Goose neck faucet
 - Knee Valve
- Z-clip mounting bracket
- NSF certified



Sinks

Part #	Mfg #	Overall Size	Holes	Depth	Drain Opening	Price
226570	EHS18KVX	18" x 14-1/2"	11"	5"	1-1/2"	

Stainless Steel Classroom Sinks
Celebrity® Stainless Steel Classroom Sink

- 20" Gauge
- 3" corner radius
- Brushed satin finish
- Underside sink is fully coated
- 5/32" Raised rim
- AD models ADA compliant



Part #	Mfg #	Overall Size	Holes	Depth	Drain Opening	Price
178506	CDKAD2517652	25" x 17"	2	6-1/2"	3-1/2" 30"	

Lustertone® Stainless Steel Self-Rimming Classroom Sink

- 18" Gauge
- Lustrous highlighted satin finish
- 2, 2LM, 4, FR2, 2FRM, FR4 faucet holes
- 2, 3, 4 Faucet holes (L2 or 4 and R2 or 4 models only)
- AD models ADA compliant
- RQ models include Quick-Clip®
- **DRKR2217RC & DRKRQ2517C** models include:
 - LKD208513C Faucet
 - LKD2439C Faucet (for model **DRKRQ2517C**)
 - LK35 Strainer
 - LK1141A Bubbler



Part #	Mfg #	Overall Size	Holes	Depth	Drain Opening	Price
189527	DRKAD2517402FR M	25" x 17"	2FRM	4"	3-1/2" 30"	
189528	DRKAD2517402LM	25" x 17"	2LM	4"	3-1/2" 30"	
185143	DRKAD2517650	25" x 17"	0	6-1/2"	3-1/2" 30"	
178243	DRKAD2517654	25" x 17"	4	6-1/2"	3-1/2" 30"	
171582	DRKAD252250L2	25" x 22"	2	5"	3-1/2" 30"	
171583	DRKAD252250R2	25" x 22"	2	5"	3-1/2" 30"	
167959	DRKAD3119502	31" x 19-1/2"	2	5"	3-1/2" 36"	
178020	DRKAD3119652	31" x 19-1/2"	2	6-1/2"	3-1/2" 36"	

Commercial Stainless Steel Sinks

Stainless Steel Classroom Sinks (Continued)

Lustertone® Stainless Steel Self-Rimming Classroom Sink

Part #	Mfg #	Overall Size	Holes	Depth	Drain Opening	Price
048956	DRKR2217RC	22" x 17"	2	7-5/8"	3-1/2" 27"	
158936	DRKR2220L2	22" x 19-1/2"	2	7-1/2"	3-1/2" 27"	
158935	DRKR2220R2	22" x 19-1/2"	2	7-1/2"	3-1/2" 27"	
168221	DRKR2522L4	25" X 22"	4	7-5/8"	3-1/2" 30"	
168222	DRKR2522R4	25" X 22"	4	7-5/8"	3-1/2" 30"	
149651	DRKRQ2517C	25" x 17"	4	7-5/8"	3-1/2" 30"	

Stainless Steel Foodservice Dish Tables

Commercial Stainless Steel Foodservice Soiled Dish Table

- 16" Gauge
- Welded construction
- 3/4" Coved corners
- Rolled edge
- 10" Backsplash
- 1-1/2" Edge rim design
- 1-5/8" galvanized legs with 1" adjustable feet
- NSF certification



Part #	Mfg #	Overall Size	Holes	Depth	Drain Opening	Price
177917	DDT48LX	36" x 30"	44.75"	6"	3-1/2"	

Stainless Steel Foodservice Scullery Sinks

Commercial Stainless Steel 12" Standard Series Double Compartment Scullery

- 16" Gauge
- Welded construction
- 3/4" Coved radius
- 2" Divider between each tub
- 10" Backsplash
- 1-1/2" Edge rim design
- Basket strainers included with drain
- 1-5/8" Galvanized legs with 1" adjustable feet
- NSF certified



Part #	Mfg #	Overall Size	Holes	Depth	Drain Opening	Price
226505	2C18X180X	43" x 23.8"	44.8"	12"	3-1/2"	

Sinks

Commercial Stainless Steel Sinks

Commercial Stainless Steel 12" Standard Series Double Compartment Scullery Sink with Drainboard

- 16" Gauge
- Left or right drainboard
- Welded construction
- 3/4" Coved radius
- 2" Divider between each tub
- 10" Backsplash
- 1-1/2" Edge rim design
- Drainboards are die stamped
- Basket strainers included with drain
- 1-5/8" Galvanized legs with 1" adjustable feet
- NSF certified



Sinks

Part #	Mfg #	Overall Size	Holes	Depth	Drain Opening	Price
172672	2C24X24R24X	76.5" x 29.8"	44.8"	12"	3-1/2"	

Commercial Stainless Steel 12" Standard Series Triple Compartment Scullery Sink

- 16" Gauge
- Drainboard not included
- Welded construction
- 3/4" Coved radius
- 2" Divider between each tub
- 10" Backsplash
- 1-1/2" Edge rim design
- Basket strainers included with drain
- 1-5/8" Galvanized legs with 1" adjustable feet
- NSF certified



Part #	Mfg #	Overall Size	Holes	Depth	Drain Opening	Price
153793	3C18X180X	63" x 23.8"	44.8"	12"	3-1/2"	

Commercial Stainless Steel 12" Standard Series Triple Compartment Scullery Sink with Drainboards

- 16" Gauge
- Left and right drainboards
- Welded construction
- 3/4" Coved radius
- 2" Divider between each tub
- 10" Backsplash
- 1-1/2" Edge rim design
- Basket strainers included with drain
- 1-5/8" Galvanized legs with 1" adjustable feet
- NSF certified



Part #	Mfg #	Overall Size	Holes	Depth	Drain Opening	Price
168415	3C18X24218X	94" x 99.8"	44.8"	12"	3-1/2"	

Commercial Stainless Steel Sinks

Sinks

Commercial Stainless Steel 14" Standard Series Double Compartment Scullery Sink with Drainboard

- 16" Gauge
- Welded construction
- 3/4" Coved corners
- 2" Divider between tubs
- Left or right drainboard
- Drainboards are die stamped
- 9" Blacksplash with tile ledge
- 1-1/2" Edge rim design
- Basket strainers included with drain
- 1-5/8" Galvanized legs with 1" adjustable feet
- NSF certified



Part #	Mfg #	Overall Size	Holes	Depth	Drain Opening	Price
177921	142C16X20L18X	54.5" x 25.8"	43.8"	14"	3-1/2"	
166147	142C16X20R18X	54.5" x 25.8"	43.8"	14"	3-1/2"	

Commercial Stainless Steel 14" Standard Series Double Compartment Scullery Sink with Drainboard

- 16" Gauge
- Welded construction
- 3/4" Coved corners
- 2" Divider between tubs
- Left and right drainboards
- Drainboards are die stamped
- 9" Blacksplash with tile ledge
- 1-1/2" Edge rim design
- Basket strainers included with drain
- 1-5/8" Galvanized legs with 1" adjustable feet
- NSF certified



Part #	Mfg #	Overall Size	Holes	Depth	Drain Opening	Price
226498	142C18X24218X	74" x 29.8"	43.8"	14"	3-1/2"	

Commercial Stainless Steel 14" Standard Series Triple Compartment Scullery Sink

- 16" Gauge
- Welded construction
- 3/4" Coved corners
- 2" Divider between tubs
- Drainboards not included
- 9" Blacksplash with tile ledge
- 1-1/2" Edge rim design
- Basket strainers included with drain
- 1-5/8" Galvanized legs with 1" adjustable feet
- NSF certified



Part #	Mfg #	Overall Size	Holes	Depth	Drain Opening	Price
177915	143C18X240X	57" x 25.8"	43.8"	14"	3-1/2"	

Commercial Stainless Steel Sinks

Commercial Stainless Steel 14" Standard Series Triple Compartment Scullery Sink with Drainboard

- 16" Gauge
- Welded construction
- 3/4" Coved corners
- 2" Divider between tubs
- Right drainboard included is die stamped
- 9" Backsplash with tile ledge
- 1-1/2" Edge rim design
- Basket strainers included with drain
- 1-5/8" Galvanized legs with 1" adjustable feet
- NSF certified



Sinks

Part #	Mfg #	Overall Size	Holes	Depth	Drain Opening	Price
159296	143C18X24XR24X	72.5" x 25.8"	43.8"	14"	3-1/2"	

Commercial Stainless Steel Super Economy Series Single Compartment Scullery Sink

- 18" Gauge
- Welded construction
- 3/4" Coved radius
- Drain boards are die stamped
- 9" Backsplash with tile edge
- 1-1/2" Edge rim design
- Basket strainers included with drain
- 1-5/8" galvanized legs with 1" adjustable feet
- NSF certified



Part #	Mfg #	Overall Size	Holes	Depth	Drain Opening	Price
153435	SE1C18X18L18X	38.5" x 23.8"	43.8"	11"	3-1/2"	

Commercial Stainless Steel Economy Series Single Compartment Scullery Sink

- 18" Gauge
- Drainboards not included
- Welded construction
- 3/4" Coved radius
- 2" Divider between each tub
- Basket strainers included with drain
- 9" Backsplash
- 1-1/2" Edge rim design
- 1-5/8" Galvanized legs with 1" adjustable feet
- NSF certified



Part #	Mfg #	Overall Size	Holes	Depth	Drain Opening	Price
171718	E1C16X200X	21" x 25.8"	43.8"	12"	3-1/2"	
185679	E1C24X240X	29" x 29.8"	43.8"	12"	3-1/2"	

Commercial Stainless Steel Sinks

Sinks

Commercial Stainless Steel Economy Series Single Compartment Scullery Sink with Drainboard

- 18" Gauge
- Includes left or right drainboard
- Welded construction
- 3/4" Coved radius
- 2" Divider between each tub
- Drainboards are die stamped
- Basket strainers included with drain
- 9" Backsplash
- 1-1/2" Edge rim design
- 1-5/8" Galvanized legs with 1" adjustable feet
- NSF certified



Part #	Mfg #	Overall Size	Holes	Depth	Drain Opening	Price
177341	E1C16X20R18X	36-1/2" x 25-3/4"	36"	12"	3-1/2"	
138952	E1C20X20R20X	42-1/2" x 25-3/4"	36"	12"	3-1/2"	
162506	E1C24X24L24X	50-1/2" x 29-3/4"	36"	12"	3-1/2"	

Commercial Stainless Steel Economy Series Double Compartment Scullery Sink

- 18" Gauge
- Drainboards not included
- Welded construction
- 3/4" Coved radius
- 2" Divider between each tub
- Basket strainers included with drain
- 9" Backsplash
- 1-1/2" Edge rim design
- 1-5/8" Galvanized legs with 1" adjustable feet
- NSF certified



Part #	Mfg #	Overall Size	Holes	Depth	Drain Opening	Price
177421	E2C16X200X	39" x 25.8"	43.8"	12"	3-1/2"	

Commercial Stainless Steel Economy Series Triple Compartment Scullery Sink with Drainboards

- 18" gauge
- Includes left or right drainboards
- Welded construction
- 3/4" Coved radius
- 2" Divider between each tub
- Drainboards are die stamped
- Basket strainers included with drain
- 9" Backsplash
- 1-1/2" Edge rim design
- 1-5/8" Galvanized legs with 1" adjustable feet
- NSF certified



Part #	Mfg #	Overall Size	Holes	Depth	Drain Opening	Price
177422	E3C16X20R18X	72.5" x 25.8"	43.8"	12"	3-1/2"	

Commercial Stainless Steel Sinks

Commercial Economy Series Triple Compartment Complete Scullery Sink

- 18" gauge
- Includes left and right drainboards
- Welded construction
- 3/4" Coved radius
- 2" Divider between each tub
- Drainboards are die stamped
- Basket strainers included with drain
- 9" Backsplash
- 1-1/2" Edge rim design
- 1-5/8" Galvanized legs with 1" adjustable feet
- NSF certified



Sinks

Part #	Mfg #	Overall Size	Holes	Depth	Drain Opening	Price
189324	E3C20X20220X	104" x 25.8"	43.8"	12"	3-1/2"	

Commercial Deli Series Triple Compartment Scullery Sink

- 16" Gauge, stainless steel
- Welded construction
- Drainboards not included
- 3/4" Coved radius
- 2" Divider between tubs
- 9" Backsplash
- 1-1/2" Edge rim design
- Basket strainers included with drain
- 1-5/8" Galvanized legs with 1" adjustable feet
- NSF certified



Part #	Mfg #	Overall Size	Holes	Depth	Drain Opening	Price
189950	3C10X140X	39" x 19.8"	43.8"	10"	3-1/2"	

Commercial Stainless Steel Deli Series Triple Compartment Scullery Sink with Drainboards

- 16" Gauge
- Left or right drainboards
- Welded construction
- Drainboards are die stamped
- 2" Divider between each tub
- 9" Backsplash
- 3/4" Coved radius
- Basket strainers included with drain
- Raised 1-1/2" diameter rolled edge
- 1-5/8" galvanized legs with 1" adjustable plastic feet



Part #	Mfg #	Overall Size	Holes	Depth	Drain Opening	Price
187270	3C10X14L12X	48.5" x 19.8"	44.8"	10"	3-1/2"	
187836	3C10X14R12X	48.5" x 19.8"	44.8"	10"	3-1/2"	

Commercial Stainless Steel Sinks

Sinks

Deli Series Complete Triple Compartment Scullery Sink

- 16" Gauge, stainless steel
- Welded construction
- 3/4" Coved corners
- Includes left and right drainboards
- Drainboards are die stamped
- 9" Backsplash
- Raised 1-1/2" diameter rolled edge
- Basket strainers included with drain
- 1-5/8" Galvanized legs with 1" adjustable plastic feet
- 2" Divider between each tub



Part #	Mfg #	Overall Size	Holes	Depth	Drain Opening	Price
227337	3C10X14216X	66" x 19-3/4"	36"	10"	3-1/2"	
189835	3C12X16216X	72" x 21-3/4"	36"	10"	3-1/2"	

Rigidbilt® Commercial Single Compartment Complete Scullery Sink

- 16" Gauge, stainless steel
- Lustrous satin finish
- Left and right drainboards
- Large die-drawn sink compartments pitched to drain
- Seamless drawn 3-1/2" radius coved corners
- Optional undercoating
- Steel channel reinforced drainboards have a conical shaped pitch for drainage
- 8" Backsplash with 45° slope
- Channel rim design with 1" apron
- Stainless steel tubular legs with cross-brace supports
- 1-5/8" O.D. with up to 1" adjustable bullet shaped stainless steel feet
- NSF certified



Part #	Mfg #	Overall Size	Holes	Depth	Drain Opening	Price
223623	RNSF8124LR2	63" x 29-3/4"	36"	12-3/4"	3-1/2"	

Weldbilt® Commercial Stainless Steel Triple Compartment Scullery Sink

- 14" Gauge
- Buffed satin finish
- Welded construction
- Drain boards not included
- 1/4" Coved radius
- 8" Backsplash
- Channel rim design with 2" apron
- 1-5/8" O.D. tubular legs with 1" adjustable bullet shaped feet
- NSF certified



Part #	Mfg #	Overall Size	Holes	Depth	Drain Opening	Price
159186	WNSF83604	63" x 27-1/2"	36"	14"	3-1/2"	

Commercial Stainless Steel Sinks

Weldbilt® Commercial Stainless Steel Single Compartment Scullery Sink

- 14" Gauge
- Buffed satin finish
- Welded construction
- Left or right drainboard
- Drainboard and sink compartments pitched to drain
- 1/4" Coved radius
- 8" Backsplash
- Channel rim design with 2" apron
- 1-5/8" O.D. tubular legs with 1" adjustable bullet shaped feet
- NSF certified



Sinks

Part #	Mfg #	Overall Size	Holes	Depth	Drain Opening	Price
161623	WNSF8124R2	49-1/2" x 27-1/2"	36"	14"	3-1/2"	

General Use Stainless Steel Sinks

Commercial Stainless Steel Self-Rimming Specialty Cup Sink

- 16" Gauge
- 1-3/16" Flat rim with crimped edges



Part #	Mfg #	Overall Size	Holes	Depth	Drain Opening	Price
134653	CUPR6	8-7/8" x 8-7/8"	6-1/2"	5"	1-1/2"	

Copper Sinks

Sinks

Copper Kitchen & Bar Sinks

Harmony™ Undermount Apron Front Single Bowl Copper Sink

- 16" Gauge
- Antique copper hammered finish
- 10" Apron height
- Sound dampening pads



Part #	Mfg #	Overall Size	Holes	Depth	Drain Opening	Min Sink Base	Price
118508	ECUFS2915ACH	33" x 22"	N/A	10"	3-1/2"	36"	

Harmony™ Undermount Copper Double Bowl Kitchen Sink

- 16" Gauge
- Antique copper hammered finish
- Sound dampening



Part #	Mfg #	Overall Size	Holes	Depth	Drain Opening	Min Sink Base	Price
189172	ECU311910RACH	31-1/4" x 20"	N/A	10"	3-1/2"	36"	

The Mystic® Undermount Single Bowl Copper Bar Sink

- 16" Gauge
- Antique copper hammered finish
- Sound dampening pads



Part #	Mfg #	Overall Size	Holes	Depth	Drain Opening	Min Sink Base	Price
115294	ECU16FBACH	16" x 18-3/8"	N/A	7-3/4"	3-1/2"	24"	

Copper Lavatory Sinks

Asana® Copper Single Bowl Lavatory Vessel Sink

- 16" Gauge
- Vessel rests on countertop
- Antique copper hammered finish
- 6-1/2" Height above countertop



Part #	Mfg #	Overall Size	Holes	Depth	Drain Opening	Min Sink Base	Price
112230	ECU15ACH	16" x 15-3/4"	N/A	6-1/4"	1-1/2"	21"	

Kitchen Cast Iron Sinks

Cast Iron Drop-In Kitchen Sinks

Brookfield™ Drop-In Double Bowl Kitchen Sink

- Equal size bowl compartments with 9" depth
- 33" Minimum base cabinet width
- Rear drain increases workspace
- Available with 1, 3, or 4 faucet holes



Sinks

Part #	Mfg #	Overall Dimensions	Basin Depth	Holes	Color	Price
161304	K-5846-1-0	33" x 22"	9"	1	White	
173601	K-5846-1-96	33" x 22"	9"	1	Biscuit	
176858	K-5846-1-FD	33" x 22"	9"	1	Cane Sugar	
166668	K-5846-1-NY	33" x 22"	9"	1	Dune	
168932	K-5846-3-0	33" x 22"	9"	3	White	
173536	K-5846-4-0	33" x 22"	9"	4	White	
183592	K-5846-4-20	33" x 22"	9"	4	Suede	
187472	K-5846-4-96	33" x 22"	9"	4	Biscuit	
225190	K-5846-4-G9	33" x 22"	9"	4	Sandbar	

Bellgrove® Drop-In Double Bowl Kitchen Sink

- Equal size bowl compartments with 9" depth
- 33" Minimum base cabinet width
- Includes 2) bottom basin racks, 1) sponge caddy, 1) cast iron cleaner



Part #	Mfg #	Overall Dimensions	Basin Depth	Holes	Color	Price
173014	K-6482-1A4-0	33" x 22"	9"	1	White	
170719	K-6482-1A4-7	33" x 22"	9"	1	Black	
162758	K-6482-1A4-KA	33" x 22"	9"	1	Black n' Tan	
183609	K-6482-4A4-0	33" x 22"	9"	4	White	
186845	K-6482-5UA4-96	33" x 22"	9"	5U	Biscuit	

Cape Dory® Drop-In Single Bowl Kitchen Sink

- 9" Depth
- 33" minimum base cabinet width
- Three faucet holes with one accessory hole to the right



Part #	Mfg #	Overall Dimensions	Basin Depth	Holes	Color	Price
088078	K-5863-4-0	33" x 22"	9"	4	White	
086768	K-5863-4-7	33" x 22"	9"	4	Black	
104843	K-5863-4-96	33" x 22"	9"	4	Biscuit	
110204	K-5863-4-FF	33" x 22"	9"	4	Sea Salt	

Kitchen Cast Iron Sinks

Deerfield® Drop-In Double Bowl Kitchen Sink

- Equal size bowl compartments
- 33" Minimum base cabinet width
- Available with 1, 3, or 4 faucet holes



Sinks

Part #	Mfg #	Overall Dimensions	Basin Depth	Holes	Color	Price
160546	K-5873-1-0	33" x 22"	9"	1	White	
164929	K-5873-1-7	33" x 22"	9"	1	Black	
183600	K-5873-1-47	33" x 22"	9"	1	Almond	
167243	K-5873-1-96	33" x 22"	9"	1	Biscuit	
185072	K-5873-1-FF	33" x 22"	9"	1	Sea Salt	
181969	K-5873-1-KA	33" x 22"	9"	1	Black n' Tan	
183599	K-5873-1-K4	33" x 22"	9"	1	Cashmere	
157646	K-5873-3-0	33" x 22"	9"	3	White	
183601	K-5873-3-20	33" x 22"	9"	3	Suede	
170082	K-5873-3-7	33" x 22"	9"	3	Black	
159542	K-5873-3-96	33" x 22"	9"	3	Biscuit	
169336	K-5873-3-FF	33" x 22"	9"	3	Sea Salt	
177530	K-5873-3-K4	33" x 22"	9"	3	Cashmere	
156999	K-5873-4-0	33" x 22"	9"	4	White	
190390	K-5873-4-47	33" x 22"	9"	4	Almond	
160827	K-5873-4-7	33" x 22"	9"	4	Black	
157000	K-5873-4-96	33" x 22"	9"	4	Biscuit	

Delafield® Drop-In Double Bowl Kitchen Sink

- Equal size bowl compartments
- 33" Minimum base cabinet width
- Available with 3 or 4 faucet holes



Part #	Mfg #	Overall Dimensions	Basin Depth	Holes	Color	Price
082618	K-5817-3-0	33" x 22"	8"	3	White	
086420	K-5817-3-47	33" x 22"	8"	3	Almond	
082620	K-5817-3-96	33" x 22"	8"	3	Biscuit	
082450	K-5817-4-0	33" x 22"	8"	4	White	
085801	K-5817-4-47	33" x 22"	8"	4	Almond	
182048	K-5817-4-7	33" x 22"	8"	4	Black	
082619	K-5817-4-96	33" x 22"	8"	4	Biscuit	

Kitchen Cast Iron Sinks

Efficiency™ Drop-In Double Bowl Kitchen Sink

- Large/medium bowl compartments
- 33" Minimum base cabinet width
- Three faucet holes with one accessory hole to the right
- Offset faucet ledge
- 6-3/4" Depth and 10"8" basin depth



Part #	Mfg #	Overall Dimensions	Basin Depth	Holes	Color	Price
053223	K-5948-4-0	33" x 22"	6-3/4"	4	White	
186602	K-5948-4-7	33" x 22"	6-3/4"	4	Black Black	

Executive Chef™ Drop-In Double Bowl Kitchen Sink

- Large/medium size bowls
- 10" Left bowl depth, 8" right bowl depth
- 33" Minimum base cabinet width
- Offset faucet ledge
- Available with 4 faucet holes



Part #	Mfg #	Overall Dimensions	Basin Depth	Holes	Color	Price
053214	K-5932-4-0	33" x 22"	10"8"	4	White	
153967	K-5932-4-20	33" x 22"	10"8"	4	Suede	
054747	K-5932-4-33	33" x 22"	10"8"	4	Mexican Sand	
053215	K-5932-4-47	33" x 22"	10"8"	4	Almond	
150610	K-5932-4-58	33" x 22"	10"8"	4	Thunder Grey	
076220	K-5932-4-7	33" x 22"	10"8"	4	Black	
061847	K-5932-4-95	33" x 22"	10"8"	4	Ice Grey	
053216	K-5932-4-96	33" x 22"	10"8"	4	Biscuit	
108906	K-5932-4-FD	33" x 22"	10"8"	4	Cane Sugar	
159711	K-5932-4-FP	33" x 22"	10"8"	4	Caviar	
106249	K-5932-4-G9	33" x 22"	10"8"	4	Sandbar	
106567	K-5932-4-KA	33" x 22"	10"8"	4	Black n' Tan	
096275	K-5932-4-K4	33" x 22"	10"8"	4	Cashmere	

Hartland® Drop-In Double Bowl Kitchen Sink

- Equal double bowl compartments
- 36" Minimum base cabinet width
- 9" Depth
- Available with 1, 2, 3, or 4 faucet holes



Part #	Mfg #	Overall Dimensions	Basin Depth	Holes	Color	Price
130973	K-5818-1-0	33" x 22"	9"	1	White	
147677	K-5818-1-20	33" x 22"	9"	1	Suede	
144716	K-5818-1-47	33" x 22"	9"	1	Almond	
131350	K-5818-1-7	33" x 22"	9"	1	Black	
131933	K-5818-1-96	33" x 22"	9"	1	Biscuit	
171262	K-5818-1-FF	33" x 22"	9"	1	Sea Salt	
137089	K-5818-1-FD	33" x 22"	9"	1	Cane Sugar	
176295	K-5818-1-K4	33" x 22"	9"	1	Cashmere	

Kitchen Cast Iron Sinks

Cast Iron Drop-In Kitchen Sinks (Continued)

Hartland® Drop-In Double Bowl Kitchen Sink

Part #	Mfg #	Overall Dimensions	Basin Depth	Holes	Color	Price
133267	K-5818-2-0	33" x 22"	9"	2	White	
136863	K-5818-2-47	33" x 22"	9"	2	Almond	
142283	K-5818-2-7	33" x 22"	9"	2	Black	
138351	K-5818-2-96	33" x 22"	9"	2	Biscuit	
138933	K-5818-2-FD	33" x 22"	9"	2	Cane Sugar	
177330	K-5818-1-G9	33" x 22"	9"	1	Sandbar	
138379	K-5818-2-G9	33" x 22"	9"	2	Sandbar	
132820	K-5818-2-KA	33" x 22"	9"	2	Black n' Tan	
136647	K-5818-2-K4	33" x 22"	9"	2	Cashmere	
136408	K-5818-3-0	33" x 22"	9"	3	White	
133606	K-5818-3-47	33" x 22"	9"	3	Almond	
130173	K-5818-3-7	33" x 22"	9"	3	Black	
148960	K-5818-3-95	33" x 22"	9"	3	Ice Grey	
150702	K-5818-3-96	33" x 22"	9"	3	Biscuit	
140446	K-5818-3-FD	33" x 22"	9"	3	Cane Sugar	
224761	K-5818-3-FF	33" x 22"	9"	3	Sea Salt	
147164	K-5818-3-KA	33" x 22"	9"	3	Black n' Tan	
183078	K-5818-3-K4	33" x 22"	9"	3	Cashmere	
132063	K-5818-4-0	33" x 22"	9"	4	White	
131475	K-5818-4-47	33" x 22"	9"	4	Almond	
157464	K-5818-4-7	33" x 22"	9"	4	Black	
150878	K-5818-4-95	33" x 22"	9"	4	Ice Grey	
132114	K-5818-4-96	33" x 22"	9"	4	Biscuit	
139550	K-5818-4-FD	33" x 22"	9"	4	Cane Sugar	
183079	K-5818-4-KA	33" x 22"	9"	4	Black n' Tan	
131223	K-5818-4-K4	33" x 22"	9"	4	Cashmere	

Langlade® Drop-In Double Bowl Kitchen Sink

- Equal size bowls
- 33" Minimum base cabinet width
- Smart Divide® lower bowl divider
- Available with 1, 2, 3, 3F, 4, and 5 faucet holes



Part #	Mfg #	Overall Dimensions	Basin Depth	Holes	Color	Price
093456	K-6626-1-0	33" x 22"	9"	1	White	
103864	K-6626-1-33	33" x 22"	9"	1	Mexican Sand	
107036	K-6626-1-58	33" x 22"	9"	1	Thunder Grey	
093158	K-6626-1-7	33" x 22"	9"	1	Black	
094085	K-6626-1-96	33" x 22"	9"	1	Biscuit	
153779	K-6626-1-FD	33" x 22"	9"	1	Cane Sugar	
117062	K-6626-1-FF	33" x 22"	9"	1	Sea Salt	
139160	K-6626-1-FT	33" x 22"	9"	1	Basalt	

Kitchen Cast Iron Sinks

Cast Iron Drop-In Kitchen Sinks (Continued)

Langlade® Drop-In Double Bowl Kitchen Sink

Part #	Mfg #	Overall Dimensions	Basin Depth	Holes	Color	Price
094426	K-6626-1-KA	33" x 22"	9"	1	Black n' Tan	
100320	K-6626-1-K4	33" x 22"	9"	1	Cashmere	
097751	K-6626-2-0	33" x 22"	9"	2	White	
187582	K-6626-2-20	33" x 22"	9"	2	Suede	
183105	K-6626-2-47	33" x 22"	9"	2	Almond	
106262	K-6626-2-58	33" x 22"	9"	2	Thunder Grey	
096699	K-6626-2-7	33" x 22"	9"	2	Black	
109552	K-6626-2-96	33" x 22"	9"	2	Biscuit	
127848	K-6626-2-FD	33" x 22"	9"	2	Cane Sugar	
118346	K-6626-2-FF	33" x 22"	9"	2	Sea Salt	
133145	K-6626-2-FP	33" x 22"	9"	2	Caviar	
101421	K-6626-2-G9	33" x 22"	9"	2	Sandbar	
097912	K-6626-2-KA	33" x 22"	9"	2	Black n' Tan	
109402	K-6626-2-K4	33" x 22"	9"	2	Cashmere	
101312	K-6626-3-0	33" x 22"	9"	3	White	
093634	K-6626-3-33	33" x 22"	9"	3	Mexican Sand	
124219	K-6626-3-47	33" x 22"	9"	3	Almond	
102275	K-6626-3-7	33" x 22"	9"	3	Black	
094716	K-6626-3-96	33" x 22"	9"	3	Biscuit	
140850	K-6626-3-FD	33" x 22"	9"	3	Cane Sugar	
111784	K-6626-3-KA	33" x 22"	9"	3	Black n' Tan	
183106	K-6626-3F-0	33" x 22"	9"	3F	White	
139176	K-6626-3F-33	33" x 22"	9"	3F	Mexican Sand	
183107	K-6626-3F-7	33" x 22"	9"	3F	Black	
119777	K-6626-3F-96	33" x 22"	9"	3F	Biscuit	
126149	K-6626-3F-FD	33" x 22"	9"	3F	Cane Sugar	
097760	K-6626-3F-FF	33" x 22"	9"	3F	Sea Salt	
097173	K-6626-4-0	33" x 22"	9"	4	White	
106343	K-6626-4-47	33" x 22"	9"	4	Almond	
120457	K-6626-4-7	33" x 22"	9"	4	Black	
096446	K-6626-4-96	33" x 22"	9"	4	Biscuit	
126788	K-6626-4-FD	33" x 22"	9"	4	Cane Sugar	
148515	K-6626-4-FP	33" x 22"	9"	4	Caviar	
115315	K-6626-4-KA	33" x 22"	9"	4	Black n' Tan	
099960	K-6626-4-K4	33" x 22"	9"	4	Cashmere	
093499	K-6626-5-0	33" x 22"	9"	5	White	
122178	K-6626-5-96	33" x 22"	9"	5	Biscuit	
148332	K-6626-5-FD	33" x 22"	9"	5	Cane Sugar	
183109	K-6626-5-KA	33" x 22"	9"	5	Black n' Tan	

Kitchen Cast Iron Sinks

Mayfield™ Drop-In Single Bowl Kitchen Sink

- 25" x 22"
- 7-3/4-inch depth
- 27-inch minimum base cabinet width
- Acid-resistant enamel finish
- Three faucet holes with one accessory hole to the right



Part #	Mfg #	Overall Dimensions	Basin Depth	Holes	Color	Price
062598	K-5964-4-0	25" x 22"	7-3/4"	4	White	

Riverby® Drop-In Single Bowl Kitchen Sink

- 36" Minimum base cabinet width
- Available with 1, 3, or 4 faucet holes
- Offset drain
- Includes K-6239 colander and K-6237 LH bottom basin rack



Part #	Mfg #	Overall Dimensions	Basin Depth	Holes	Color	Price
162363	K-5871-1A2-0	33" x 22"	9"	1	White	
183595	K-5871-1A2-20	33" x 22"	9"	1	Suede	
152294	K-5871-1A2-96	33" x 22"	9"	1	Biscuit	
166479	K-5871-1A2-NY	33" x 22"	9"	1	Dune	
152484	K-5871-3A2-FF	33" x 22"	9"	3	Sea Salt	
185129	K-5871-4A2-0	33" x 22"	9"	4	White	
183992	K-5871-4A2-96	33" x 22"	9"	4	Biscuit	
226386	K-5871-4A2-FF	33" x 22"	9"	4	Sea Salt	
162514	K-5871-4A2-KA	33" x 22"	9"	4	Black n' Tan	
181517	K-5871-4A2-K4	33" x 22"	9"	4	Cashmere	

Riverby® Drop-In Medium Size Single Bowl Sink

- 25" Minimum base cabinet width
- Available with 1, 3 or 4 faucet holes
- Offset drain
- Stainless-steel basin rack included



Part #	Mfg #	Overall Dimensions	Basin Depth	Holes	Color	Price
171608	K-5872-1A1-0	25" x 22"	9"	1	White	
172091	K-5872-1A1-47	25" x 22"	9"	1	Almond	
150611	K-5872-1A1-58	25" x 22"	9"	1	Thunder Grey	
167337	K-5872-1A1-7	25" x 22"	9"	1	Black	
179273	K-5872-1A1-K4	25" x 22"	9"	1	Cashmere	
183598	K-5872-3A1-0	25" x 22"	9"	3	White	
225280	K-8668-1A1-0	27" x 22"	9"	1	White	

Kitchen Cast Iron Sinks

Woodfield® Drop-In Double Bowl Kitchen Sink

- Large/medium bowls
- 33" Minimum base cabinet width
- Smart Divide® lower bowl divider
- Available with 2 or 4 faucet holes



Part #	Mfg #	Overall Dimensions	Basin Depth	Holes	Color	Price
103191	K-5839-2-0	33" x 22"	9"	2	White	
125214	K-5839-2-47	33" x 22"	9"	2	Almond	
105939	K-5839-2-7	33" x 22"	9"	2	Black	
099475	K-5839-2-96	33" x 22"	9"	2	Biscuit	
122095	K-5839-2-FD	33" x 22"	9"	2	Cane Sugar	
110567	K-5839-2-FF	33" x 22"	9"	2	Sea Salt	
108096	K-5839-2-G9	33" x 22"	9"	2	Sandbar	
128144	K-5839-2-KA	33" x 22"	9"	2	Black n' Tan	
117170	K-5839-2-K4	33" x 22"	9"	2	Cashmere	
097005	K-5839-4-0	33" x 22"	9"	4	White	
118648	K-5839-4-47	33" x 22"	9"	4	Almond	
106285	K-5839-4-7	33" x 22"	9"	4	Black	
099686	K-5839-4-96	33" x 22"	9"	4	Biscuit	
131108	K-5839-4-G9	33" x 22"	9"	4	Sandbar	
149117	K-5839-4-KA	33" x 22"	9"	4	Black n' Tan	
121221	K-5839-4-K4	33" x 22"	9"	4	Cashmere	

Cast Iron Under-Mount Kitchen Sinks

Bakersfield™ Under-Mount Single Bowl Kitchen Sink

- 33" Minimum base cabinet width
- 5 Oversized faucet holes allow for easy installation
- Includes under-mount installation kit



Part #	Mfg #	Overall Dimensions	Basin Depth	Holes	Color	Price
132329	K-5832-5U-0	31" x 22"	8"	5U	White	
145080	K-5832-5U-47	31" x 22"	8"	5U	Almond	
183082	K-5832-5U-58	31" x 22"	8"	5U	Thunder Grey	
183083	K-5832-5U-96	31" x 22"	8"	5U	Biscuit	
132233	K-5832-5U-FD	31" x 22"	8"	5U	Cane Sugar	
144385	K-5832-5U-FP	31" x 22"	8"	5U	Caviar	
135098	K-5832-5U-G9	31" x 22"	8"	5U	Sandbar	
176957	K-5832-5U-K4	31" x 22"	8"	5U	Cashmere	

Sinks

Kitchen Cast Iron Sinks

Bellgrove® Under-Mount Double Bowl Kitchen Sink

- Equal size bowl compartments
- 36" Minimum cabinet base width
- 5 Oversized faucet holes for easy installation
- Includes 2) bottom basin racks, 1) sponge caddy, 1) cast iron cleaner



Part #	Mfg #	Overall Dimensions	Basin Depth	Holes	Color	Price
184233	K-6482-5UA4-47	33" x 22"	9"	5U	Almond	
162491	K-6482-5UA4-7	33" x 22"	9"	5U	Black	
148366	K-6482-5UA4-K4	33" x 22"	9"	5U	Cashmere	

Brookfield™ Under-Mount Double Bowl Kitchen Sink

- Equal size bowl compartments
- 36" minimum base cabinet width
- Includes cutout template
- Oversized holes for easy installation of faucets and accessories



Part #	Mfg #	Overall Dimensions	Basin Depth	Holes	Color	Price
162541	K-5846-5U-0	33" x 22"	9"	5U	White	
169582	K-5846-5U-20	33" x 22"	9"	5U	Suede	
158079	K-5846-5U-33	33" x 22"	9"	5U	Mexican Sand	
185533	K-5846-5U-58	33" x 22"	9"	5U	Thunder Grey	
159702	K-5846-5U-7	33" x 22"	9"	5U	Black	
225759	K-5846-5U-95	33" x 22"	9"	5U	Ice Grey	
183593	K-5846-5U-FD	33" x 22"	9"	5U	Cane Sugar	
183685	K-5846-5U-FF	33" x 22"	9"	5U	Sea Salt	
164459	K-5846-5U-FP	33" x 22"	9"	5U	Caviar	
183594	K-5846-5U-FT	33" x 22"	9"	5U	Basalt	
158262	K-5846-5U-G9	33" x 22"	9"	5U	Sandbar	
159442	K-5846-5U-KA	33" x 22"	9"	5U	Black n' Tan	
169160	K-5846-5U-K4	33" x 22"	9"	5U	Cashmere	

Cape Dory® Under-Mount Single Bowl Kitchen Sink

- 36" Minimum base cabinet width
- 3 Oversized faucet holes allow for easy installation
- Under-mount installation kit and mounting hardware included



Part #	Mfg #	Overall Dimensions	Basin Depth	Holes	Color	Price
085450	K-5864-5U-0	33" x 22"	9"	5U	White	
117310	K-5864-5U-33	33" x 22"	9"	5U	Mexican Sand	
183087	K-5864-5U-58	33" x 22"	9"	5U	Thunder Grey	
090473	K-5864-5U-7	33" x 22"	9"	5U	Black	
079533	K-5864-5U-96	33" x 22"	9"	5U	Biscuit	
121230	K-5864-5U-FD	33" x 22"	9"	5U	Cane Sugar	
143755	K-5864-5U-FF	33" x 22"	9"	5U	Sea Salt	
184858	K-5864-5U-FT	33" x 22"	9"	5U	Basalt	

Kitchen Cast Iron Sinks

Cast Iron Under-Mount Kitchen Sinks (Continued)

Cape Dory® Under-Mount Single Bowl Kitchen Sink

Part #	Mfg #	Overall Dimensions	Basin Depth	Holes	Color	Price
103523	K-5864-5U-G9	33" x 22"	9"	5U	Sandbar	
093121	K-5864-5U-KA	33" x 22"	9"	5U	Black n' Tan	
087592	K-5864-5U-K4	33" x 22"	9"	5U	Cashmere	

Deerfield® Under-Mount Double Bowl Kitchen Sink

- 9-inch depth
- Rear drain
- Equal size bowl compartments
- 36" Minimum base cabinet width
- 5 Oversized faucet holes allow for easy faucet installation
- Includes cutout template



Part #	Mfg #	Overall Dimensions	Basin Depth	Holes	Color	Price
167035	K-5873-5U-0	33" x 22"	9"	5U	White	
180547	K-5873-5U-33	33" x 22"	9"	5U	Mexican Sand	
166511	K-5873-5U-47	33" x 22"	9"	5U	Almond	
187821	K-5873-5U-95	33" x 22"	9"	5U	Ice Grey	
170571	K-5873-5U-96	33" x 22"	9"	5U	Biscuit	
159506	K-5873-5U-FD	33" x 22"	9"	5U	Cane Sugar	
183602	K-5873-5U-FF	33" x 22"	9"	5U	Sea Salt	
183133	K-5873-5U-G9	33" x 22"	9"	5U	Sandbar	
176159	K-5873-5U-KA	33" x 22"	9"	5U	Black 'n Tan	
183603	K-5873-5U-K4	33" x 22"	9"	5U	Cashmere	

Executive Chef™ Under-Mount Double Bowl Kitchen Sink

- Large/medium size bowls
- 10" Left bowl depth, 8" right bowl depth
- 33" Minimum base cabinet width
- Offset faucet ledge
- 4 oversized faucet holes allow for easy installation



Part #	Mfg #	Overall Dimensions	Basin Depth	Holes	Color	Price
058752	K-5931-4U-0	33" x 22"	10"/8"	4U	White	
153768	K-5931-4U-20	33" x 22"	10"/8"	4U	Suede	
072698	K-5931-4U-33	33" x 22"	10"/8"	4U	Mexican Sand	
090280	K-5931-4U-47	33" x 22"	10"/8"	4U	Almond	
106973	K-5931-4U-58	33" x 22"	10"/8"	4U	Thunder Grey	
066261	K-5931-4U-7	33" x 22"	10"/8"	4U	Black	
078515	K-5931-4U-95	33" x 22"	10"/8"	4U	Ice Grey	
056544	K-5931-4U-96	33" x 22"	10"/8"	4U	Biscuit	
120337	K-5931-4U-FD	33" x 22"	10"/8"	4U	Cane Sugar	
106430	K-5931-4U-FF	33" x 22"	10"/8"	4U	Sea Salt	
158125	K-5931-4U-FP	33" x 22"	10"/8"	4U	Caviar	
183088	K-5931-4U-FT	33" x 22"	10"/8"	4U	Basalt	
064353	K-5931-4U-G9	33" x 22"	10"/8"	4U	Sandbar	

Kitchen Cast Iron Sinks

Cast Iron Under-Mount Kitchen Sinks (Continued) Executive Chef™ Under-Mount Double Bowl Kitchen Sink

Part #	Mfg #	Overall Dimensions	Basin Depth	Holes	Color	Price
086487	K-5931-4U-KA	33" x 22"	10"/8"	4U	Black n' Tan	
081396	K-5931-4U-K4	33" x 22"	10"/8"	4U	Cashmere	
188733	K-5931-4U-NY	33" x 22"	10"/8"	4U	Dune	

Hartland® Under-Mount Double Bowl Kitchen Sink

- Equal bowl compartments
- 36" Minimum base cabinet width
- Under-mount installation kit included



Part #	Mfg #	Overall Dimensions	Basin Depth	Holes	Color	Price
139832	K-5818-5U-0	33" x 22"	9"	5U	White	
178610	K-5818-5U-20	33" x 22"	9"	5U	Suede	
135255	K-5818-5U-33	33" x 22"	9"	5U	Mexican Sand	
150984	K-5818-5U-47	33" x 22"	9"	5U	Almond	
183080	K-5818-5U-58	33" x 22"	9"	5U	Thunder Grey	
136918	K-5818-5U-7	33" x 22"	9"	5U	Black	
142853	K-5818-5U-95	33" x 22"	9"	5U	Ice Grey	
138590	K-5818-5U-96	33" x 22"	9"	5U	Biscuit	
139360	K-5818-5U-FD	33" x 22"	9"	5U	Cane Sugar	
158597	K-5818-5U-FF	33" x 22"	9"	5U	Sea Salt	
132939	K-5818-5U-FP	33" x 22"	9"	5U	Caviar	
138289	K-5818-5U-G9	33" x 22"	9"	5U	Sandbar	
132273	K-5818-5U-KA	33" x 22"	9"	5U	Black n' Tan	
141874	K-5818-5U-K4	33" x 22"	9"	5U	Cashmere	

Indio® Under-Mount Double Bowl Kitchen Sink

- Large/medium size bowls
- 36" Minimum base cabinet width
- Smart Divide® lower bowl divider
- Integrated faucet deck provides additional water containment
- Includes 2) bottom basin racks, cutting board, and colander
- Under-mount installation kit also included



Part #	Mfg #	Overall Dimensions	Basin Depth	Holes	Color	Price
160984	K-6411-1-0	33" x 22"	9"	1	White	
225196	K-6411-1-20	33" x 22"	9"	1	Suede	
135354	K-6411-1-33	33" x 22"	9"	1	Mexican Sand	
139526	K-6411-1-58	33" x 22"	9"	1	Thunder Grey	
143295	K-6411-1-7	33" x 22"	9"	1	Black	
183095	K-6411-1-96	33" x 22"	9"	1	Biscuit	
136645	K-6411-1-FD	33" x 22"	9"	1	Cane Sugar	
148531	K-6411-1-FF	33" x 22"	9"	1	Sea Salt	
135774	K-6411-1-FP	33" x 22"	9"	1	Caviar	
137333	K-6411-1-G9	33" x 22"	9"	1	Sandbar	

Kitchen Cast Iron Sinks

Cast Iron Under-Mount Kitchen Sinks (Continued)

Indio® Under-Mount Double Bowl Kitchen Sink

Part #	Mfg #	Overall Dimensions	Basin Depth	Holes	Color	Price
183094	K-6411-1-KA	33" x 22"	9"	1	Black n' Tan	
181495	K-6411-1-K4	33" x 22"	9"	1	Cashmere	
182684	K-6411-1-NY	33" x 22"	9"	1	Dune	
154458	K-6411-2-0	33" x 22"	9"	2	White	
160989	K-6411-2-33	33" x 22"	9"	2	Mexican Sand	
178277	K-6411-2-47	33" x 22"	9"	2	Almond	
176902	K-6411-2-58	33" x 22"	9"	2	Cashmere	
183097	K-6411-2-7	33" x 22"	9"	2	Black	
183098	K-6411-2-96	33" x 22"	9"	2	Biscuit	
139469	K-6411-2-FD	33" x 22"	9"	2	Cane Sugar	
140211	K-6411-2-FF	33" x 22"	9"	2	Sea Salt	
183096	K-6411-2-FP	33" x 22"	9"	2	Caviar	
139009	K-6411-2-G9	33" x 22"	9"	2	Sandbar	
172075	K-6411-2-K4	33" x 22"	9"	3	Cashmere	
162247	K-6411-3-0	33" x 22"	9"	3	White	
183607	K-6411-3-20	33" x 22"	9"	3	Suede	
183100	K-6411-3-47	33" x 22"	9"	3	Almond	
183101	K-6411-3-7	33" x 22"	9"	3	Black	
151163	K-6411-3-96	33" x 22"	9"	3	Biscuit	
163738	K-6411-3-FF	33" x 22"	9"	3	Sea Salt	
183099	K-6411-3-FP	33" x 22"	9"	3	Caviar	
134740	K-6411-3-FT	33" x 22"	9"	3	Basalt	
168536	K-6411-3-KA	33" x 22"	9"	3	Black n' Tan	
140236	K-6411-3-K4	33" x 22"	9"	3	Cashmere	
223517	K-6411-3-NY	33" x 22"	9"	3	Dune	

Sinks

Langlade® Under-Mount Double Bowl Kitchen Sink

- Equal size bowl compartments
- 36" Minimum base cabinet width
- Smart Divide® lower bowl divider
- 6 Oversized faucet holes allow for easy installation



Part #	Mfg #	Overall Dimensions	Basin Depth	Holes	Color	Price
100294	K-6626-6U-0	33" x 22"	9"	6U	White	
102942	K-6626-6U-33	33" x 22"	9"	6U	Mexican Sand	
102206	K-6626-6U-47	33" x 22"	9"	6U	Almond	
107082	K-6626-6U-58	33" x 22"	9"	6U	Thunder Grey	
094364	K-6626-6U-7	33" x 22"	9"	6U	Black	
169824	K-6626-6U-95	33" x 22"	9"	6U	Ice Grey	
094769	K-6626-6U-96	33" x 22"	9"	6U	Biscuit	
098957	K-6626-6U-FD	33" x 22"	9"	6U	Cane Sugar	
124488	K-6626-6U-FF	33" x 22"	9"	6U	Sea Salt	
138932	K-6626-6U-FP	33" x 22"	9"	6U	Caviar	
176217	K-6626-6U-FT	33" x 22"	9"	6U	Basalt	

Kitchen Cast Iron Sinks

Cast Iron Under-Mount Kitchen Sinks (Continued)

Langlade® Under-Mount Double Bowl Kitchen Sink

Part #	Mfg #	Overall Dimensions	Basin Depth	Holes	Color	Price
096618	K-6626-6U-G9	33" x 22"	9"	6U	Sandbar	
090083	K-6626-6U-KA	33" x 22"	9"	6U	Black n' Tan	
095507	K-6626-6U-K4	33" x 22"	9"	6U	Cashmere	
188995	K-6626-6U-NY	33" x 22"	9"	6U	Dune	

Riverby® Under-Mount Single Bowl Kitchen Sink

- 36" Minimum base cabinet width
- 5 Oversized faucet holes for easy installation
- Offset drain
- Includes K-6194 utility rack, K-6239 colander, and K-6237 LH bottom basin rack



Part #	Mfg #	Overall Dimensions	Basin Depth	Holes	Color	Price
147531	K-5871-5UA3-0	33" x 22"	9"	5U	White	
183597	K-5871-5UA3-20	33" x 22"	9"	5U	Suede	
164943	K-5871-5UA3-58	33" x 22"	9"	5U	Thunder Grey	
170801	K-5871-5UA3-7	33" x 22"	9"	5U	Black	
170711	K-5871-5UA3-95	33" x 22"	9"	5U	Ice Grey	
171533	K-5871-5UA3-96	33" x 22"	9"	5U	Biscuit	
149421	K-5871-5UA3-FD	33" x 22"	9"	5U	Cane Sugar	
228419	K-5871-5UA3-FF	33" x 22"	9"	5U	Sea Salt	
180382	K-5871-5UA3-FP	33" x 22"	9"	5U	Caviar	
169387	K-5871-5UA3-G9	33" x 22"	9"	5U	Sandbar	
158174	K-5871-5UA3-KA	33" x 22"	9"	5U	Black n' Tan	
165155	K-5871-5UA3-K4	33" x 22"	9"	5U	Cashmere	
229137	K-5871-5UA3-NY	33" x 22"	9"	5U	Dune	

Riverby® Under-Mount Medium Size Single Bowl Sink

- 28" Minimum base cabinet width
- 5 Oversized faucet holes allow for easy installation
- Offset drain
- Stainless-steel basin rack included



Part #	Mfg #	Overall Dimensions	Basin Depth	Holes	Color	Price
159860	K-5872-5UA1-0	25" x 22"	9"	5U	White	
182275	K-5872-5UA1-33	25" x 22"	9"	5U	Mexican Sand	
179808	K-5872-5UA1-FF	25" x 22"	9"	5U	Sea Salt	
156974	K-5872-5UA1-FP	25" x 22"	9"	5U	Caviar	
163078	K-5872-5UA1-G9	25" x 22"	9"	5U	Sandbar	
226442	K-5872-5UA1-K4	25" x 22"	9"	5U	Cashmere	
189224	K-8668-5UA2-0	27" x 22"	9"	5U	White	
186741	K-8668-5UA2-FT	27" x 22"	9"	5U	Basalt	

Kitchen Cast Iron Sinks

Riverby® Under-Mount Double Bowl Kitchen Sink

- 36" Minimum base cabinet width
- 5 Oversized faucet holes
- Offset drains
- Includes: K-6239 colander with integral cutting board
K-6194 utility rack with soaking cup



K-8669-5UA3



K-8679-5UA3

K-8669-5UA3

Large/Medium Bowls

K-9234 Left-hand bottom basin rack

K-8679-5UA3

Double Equal Bowls

K-9238 bottom basin rack

Part #	Mfg #	Overall Dimensions	Basin Depth	Holes	Color	Price
230863	K-8669-5UA3-0	33" x 22"	9"	5U	White	
222262	K-8669-5UA3-33	33" x 22"	9"	5U	Mexican Sand	
188674	K-8669-5UA3-G9	33" x 22"	9"	5U	Sandbar	
229428	K-8679-5UA3-KA	33" x 22"	9"	5U	Black n' Tan	

Wheatland® Under-Mount Double Bowl Kitchen Sink

- Large/medium bowls
- 36" Minimum base cabinet width
- 5 Oversized faucet holes allow for easy installation



Part #	Mfg #	Overall Dimensions	Basin Depth	Holes	Color	Price
172798	K-5870-5U-0	33" x 22"	9"	5U	White	
151732	K-5870-5U-47	33" x 22"	9"	5U	Almond	
145449	K-5870-5U-96	33" x 22"	9"	5U	Biscuit	

Tile-In and Dual-Mount Cast Iron Kitchen Sinks

Assure™ Tile-In/Under-Mount Double Bowl Kitchen Sink

- High/low, large/small bowl sizes
- 4-1/4" left depth, 6-1/4" right depth
- 36" Minimum base cabinet width
- Available with 3 or 4 faucet holes
- ADA compliant



Part #	Mfg #	Overall Dimensions	Basin Depth	Holes	Color	Price
135466	K-6536-3-0	33" x 22"	4-1/4" and 6-1/4"	3	White	
082167	K-6536-3-7	33" x 22"	4-1/4" and 6-1/4"	3	Black	

Kitchen Cast Iron Sinks

Cape Dory® Tile-In Single Bowl Kitchen Sink

- 33" Minimum base cabinet width
- Available with 2, 3, or 4 faucet holes
- Center drain



Part #	Mfg #	Overall Dimensions	Basin Depth	Holes	Color	Price
095372	K-5864-2-0	33" x 22"	9"	2	White	

Deerfield® Dual-Mount Double Bowl Kitchen Sink

- Equal bowl compartments
- 36" Minimum base cabinet width
- Top-mount or under-mount installation
- Smart Divide® lower bowl divider



Part #	Mfg #	Overall Dimensions	Basin Depth	Holes	Color	Price
163920	K-5838-0	33" x 20"	9"	N/A	White	
160995	K-5838-96	33" x 22"	9"	N/A	Biscuit	
183683	K-5838-FD	33" x 20"	9"	N/A	Cane Sugar	
188184	K-5838-FF	33" x 20"	9"	N/A	Sea Salt	
156021	K-5838-G9	33" x 20"	9"	N/A	Sandbar	
168121	K-5838-K4	33" x 22"	9"	N/A	Cashmere	
156941	K-5838-FP	33" x 20"	9"	N/A	Caviar	

Delafield® Tile-In/Metal Frame Drop-In Double Bowl Kitchen Sink

- 8" Depth
- Equal size bowl compartments
- 33" Minimum base cabinet width
- Available with 3 or 4 faucet holes
- Tile-in or drop-in installation



Part #	Mfg #	Overall Dimensions	Basin Depth	Holes	Color	Price
058969	K-5950-4-0	33" x 22"	8"	4	White	

Executive Chef™ Tile-In Double Bowl Kitchen Sink

- Large/medium size bowls
- 10" Left bowl depth, 8" right bowl depth
- 33" Minimum base cabinet width
- Offset faucet ledge
- Available with 4 faucet holes



Part #	Mfg #	Overall Dimensions	Basin Depth	Holes	Color	Price
078826	K-5931-4-0	33" x 22"	10"/8"	4	White	
110411	K-5931-4-7	33" x 22"	10"/8"	4	Black	
104460	K-5931-4-95	33" x 22"	10"/8"	4	Ice Grey	

Kitchen Cast Iron Sinks

Iron/Tones® Dual-Mount Double Bowl Kitchen Sink

- Large/medium size bowls
- 33" Minimum base cabinet for top-mount installation
- 36" Minimum base cabinet for under-mount installation
- Top-mount or under-mount installation
- Smart Divide® lower bowl divider



Part #	Mfg #	Overall Dimensions	Basin Depth	Holes	Color	Price
089516	K-6625-0	33" x 22"	9"	N/A	White	
157239	K-6625-20	33" x 22"	9"	N/A	Suede	
102829	K-6625-33	33" x 22"	9"	N/A	Mexican Sand	
095433	K-6625-47	33" x 22"	9"	N/A	Almond	
139033	K-6625-58	33" x 22"	9"	N/A	Thunder Grey	
096611	K-6625-7	33" x 22"	9"	N/A	Black	
161482	K-6625-95	33" x 22"	9"	N/A	Ice Grey	
089517	K-6625-96	33" x 22"	9"	N/A	Biscuit	
106583	K-6625-FD	33" x 22"	9"	N/A	Cane Sugar	
094243	K-6625-FF	33" x 22"	9"	N/A	Sea Salt	
156940	K-6625-FP	33" x 22"	9"	N/A	Caviar	
178621	K-6625-FT	33" x 22"	9"	N/A	Basalt	
097537	K-6625-G9	33" x 22"	9"	N/A	Sandbar	
101070	K-6625-KA	33" x 22"	9"	N/A	Black n' Tan	
098197	K-6625-K4	33" x 22"	9"	N/A	Cashmere	

Sinks

Apron Front Kitchen Sinks

Dickinson® Tile-In Apron- Front Kitchen Sink

- Single bowl
- Center drain
- 33" Minimum apron sink base cabinet width
- Available with 3, or 4 faucet holes



Part #	Mfg #	Overall Dimensions	Basin Depth	Holes	Color	Price
080809	K-6546-3-0	33" x 22"	8"	3	White	
089072	K-6546-4-0	33" x 22"	8"	4	White	

Dickinson® Under-Mount Apron Front Kitchen Sink

- Single bowl
- Center drain
- 33" Minimum apron sink base cabinet width
- 4 Oversized faucet holes allow for easy installation
- (K-14579-KG-G9) Alencon Lace™ Sandbar finish



Part #	Mfg #	Overall Dimensions	Basin Depth	Holes	Color	Price
068783	K-6546-4U-0	33" x 22"	8"	4U	White	
180840	K-6546-4U-20	33" x 22"	8"	4U	Suede	
104849	K-6546-4U-47	33" x 22"	8"	4U	Almond	

Kitchen Cast Iron Sinks

Apron Front Kitchen Sinks (Continued)

Dickinson® Under-Mount Apron Front Kitchen Sink

Part #	Mfg #	Overall Dimensions	Basin Depth	Holes	Color	Price
061698	K-6546-4U-7	33" x 22"	8"	4U	Black	
059926	K-6546-4U-96	33" x 22"	8"	4U	Biscuit	
126665	K-6546-4U-FD	33" x 22"	8"	4U	Cane Sugar	
138288	K-6546-4U-FF	33" x 22"	8"	4U	Sea Salt	
080036	K-6546-4U-G9	33" x 22"	8"	4U	Sandbar	
108176	K-6546-4U-KA	33" x 22"	8"	4U	Black n' Tan	
136841	K-6546-4U-K4	33" x 22"	8"	4U	Cashmere	
182811	K-14579-KG-G9	33" x 22-1/8"	8"	4U	Alencon Lace™ Sandbar	

Hawthorne™ Tile-In Apron Front Kitchen Sink

- Equal size bowl compartments
- 33" Minimum base cabinet width
- Available with 3 or 4 faucet holes



Part #	Mfg #	Overall Dimensions	Basin Depth	Holes	Color	Price
182508	K-6534-3-96	33" x 22"	8"	3	Biscuit	
068739	K-6534-4-0	33" x 22"	8"	4	White	
059169	K-6534-4-96	33" x 22"	8"	4	Biscuit	
189196	K-6534-4U-58	33" x 22"	8"	4U	Thunder Grey	

Hawthorne™ Under-Mount Apron Front Kitchen Sink

- Equal size bowl compartments
- 33" Minimum base cabinet width
- 3 Oversized faucet holes allow for easy installation



Part #	Mfg #	Overall Dimensions	Basin Depth	Holes	Color	Price
055651	K-6534-4U-0	33" x 22"	8"	4U	White	
077875	K-6534-4U-47	33" x 22"	8"	4U	Almond	
085844	K-6534-4U-7	33" x 22"	8"	4U	Black	
059595	K-6534-4U-96	33" x 22"	8"	4U	Biscuit	
158255	K-6534-4U-FD	33" x 22"	8"	4U	Cane Sugar	
127242	K-6534-4U-FF	33" x 22"	8"	4U	Sea Salt	
116245	K-6534-4U-FT	33" x 22"	8"	4U	Basalt	
080027	K-6534-4U-G9	33" x 22"	8"	4U	Sandbar	
105752	K-6534-4U-KA	33" x 22"	8"	4U	Black n' Tan	
101540	K-6534-4U-K4	33" x 22"	8"	4U	Cashmere	
175999	K-6534-4U-NY	33" x 22"	8"	4U	Dune	

Kitchen Cast Iron Sinks

Whitehaven® Under-Mount Short Apron-Front Sink

- Short, self-trimming apron
- Offset drain
- No faucet holes



Part #	Mfg #	Overall Dimensions	Basin Depth	Holes	Color	Price
167839	K-5826-0	33" x 22"	9"	N/A	White	
227299	K-5826-20	33" x 22"	9"	N/A	Suede	
178135	K-5826-FF	33" x 22"	9"	N/A	Sea Salt	
176865	K-5826-K4	33" x 22"	9"	N/A	Cashmere	
154602	K-6486-0	30" x 22"	9"	N/A	White	
183612	K-6486-95	30" x 22"	9"	N/A	Ice Grey	
183613	K-6486-96	30" x 22"	9"	N/A	Biscuit	
159495	K-6486-FD	30" x 22"	9"	N/A	Cane Sugar	
183610	K-6486-FF	30" x 22"	9"	N/A	Sea Salt	
183611	K-6486-NY	30" x 22"	9"	N/A	Dune	
152198	K-6488-0	36" x 22"	9"	N/A	White	
150107	K-6488-96	36" x 22"	9"	N/A	Biscuit	
160637	K-6488-FD	36" x 22"	9"	N/A	Cane Sugar	
157024	K-6488-FF	36" x 22"	9"	N/A	Sea Salt	
163717	K-6488-KA	36" x 22"	9"	N/A	Black n' Tan	
225972	K-6488-NY	36" x 22"	9"	N/A	Dune	

Center Drain 23-1/2" x 21-9/16"

Part #	Mfg #	Overall Dimensions	Basin Depth	Holes	Color	Price
178171	K-5664-0	23-1/2" x 21-9/16"	9"	N/A	White	
229000	K-5664-58	23-1/2" x 21-9/16"	9"	N/A	Thunder Grey	
186524	K-5664-FP	23-1/2" x 21-9/16"	9"	N/A	Caviar	

Whitehaven® Under-Mount Single Bowl Apron-Front Sink

- Tall, self-trimming apron
- Offset drain
- No faucet holes



Part #	Mfg #	Overall Dimensions	Basin Depth	Holes	Color	Price
167840	K-5827-0	33" x 22"	9"	N/A	White	
170787	K-5827-20	33" x 22"	9"	N/A	Suede	
228696	K-5827-47	33" x 22"	9"	N/A	Almond	
223917	K-5827-58	33" x 22"	9"	N/A	Thunder Grey	
223427	K-5827-7	33" x 22"	9"	N/A	Black	
224691	K-5827-95	33" x 22"	9"	N/A	Ice Grey	
183682	K-5827-96	33" x 22"	9"	N/A	Biscuit	

Kitchen Cast Iron Sinks

Apron Front Kitchen Sinks (Continued)

Whitehaven® Under-Mount Single Bowl Apron-Front Sink

Sinks

Part #	Mfg #	Overall Dimensions	Basin Depth	Holes	Color	Price
169871	K-5827-FF	33" x 22"	9"	N/A	Sea Salt	
185404	K-5827-G9	33" x 22"	9"	N/A	Sandbar	
183590	K-5827-K4	33" x 22"	9"	N/A	Cashmere	
183591	K-5827-NY	33" x 22"	9"	N/A	Dune	
146022	K-6487-0	30" x 22"	9"	N/A	White	
147939	K-6487-20	30" x 22"	9"	N/A	Suede	
151082	K-6487-7	30" x 22"	9"	N/A	Black	
185168	K-6487-95	30" x 22"	9"	N/A	Ice Grey	
153113	K-6487-96	30" x 22"	9"	N/A	Biscuit	
183618	K-6487-FD	30" x 22"	9"	N/A	Cane Sugar	
228139	K-6487-G9	30" x 22"	9"	N/A	Sandbar	
183619	K-6487-KA	30" x 22"	9"	N/A	Black n' Tan	
188964	K-6487-K4	30" x 22"	9"	N/A	Cashmere	
165905	K-6487-NY	30" x 22"	9"	N/A	Dune	
148357	K-6489-0	36" x 22"	9"	N/A	White	
148764	K-6489-20	36" x 22"	9"	N/A	Suede	
183621	K-6489-33	36" x 22"	9"	N/A	Mexican Sand	
153392	K-6489-47	36" x 22"	9"	N/A	Almond	
179437	K-6489-58	36" x 22"	9"	N/A	Thunder Grey	
145950	K-6489-7	36" x 22"	9"	N/A	Black	
144356	K-6489-96	36" x 22"	9"	N/A	Biscuit	
148797	K-6489-FD	36" x 22"	9"	N/A	Cane Sugar	
141638	K-6489-FF	36" x 22"	9"	N/A	Sea Salt	
163646	K-6489-FP	36" x 22"	9"	N/A	Caviar	
153770	K-6489-G9	36" x 22"	9"	N/A	Sandbar	
149955	K-6489-KA	36" x 22"	9"	N/A	Black n' Tan	
157415	K-6489-K4	36" x 22"	9"	N/A	Cashmere	
148645	K-6489-NY	36" x 22"	9"	N/A	Dune	

Center Drain

Part #	Mfg #	Overall Dimensions	Basin Depth	Holes	Color	Price
176667	K-5665-0	23-1/2" x 21-9/16"	9"	N/A	White	
183681	K-5665-FD	23-1/2" x 21-9/16"	9"	N/A	Cane Sugar	

Whitehaven® Under-Mount Double Bowl Apron Front Kitchen Sink with Short Apron

- Large/medium size bowls
- 36" Minimum base cabinet width
- Smart Divide® lower bowl divider
- Short apron



Part #	Mfg #	Overall Dimensions	Basin Depth	Holes	Color	Price
164009	K-6426-0	36" x 22"	9"	N/A	White	

Kitchen Cast Iron Sinks

Apron Front Kitchen Sinks (Continued)

Whitehaven® Under-Mount Double Bowl Apron Front Kitchen Sink with Short Apron

Part #	Mfg #	Overall Dimensions	Basin Depth	Holes	Color	Price
179442	K-6426-58	36" x 22"	9"	N/A	Thunder Grey	
186077	K-6426-96	36" x 22"	9"	N/A	Biscuit	
159801	K-6426-G9	36" x 22"	9"	N/A	Sandbar	
168922	K-6426-NY	36" x 22"	9"	N/A	Dune	

Whitehaven® Under-Mount Apron Front Kitchen Sink

- Large/medium size bowls
- 36" Minimum base cabinet width
- Smart Divide® lower bowl divider
- Tall Apron



Part #	Mfg #	Overall Dimensions	Basin Depth	Holes	Color	Price
159678	K-6427-0	33" x 22"	9"	N/A	White	
168298	K-6427-20	33" x 22"	9"	N/A	Suede	
172168	K-6427-47	33" x 22"	9"	N/A	Almond	
180909	K-6427-58	33" x 22"	9"	N/A	Thunder Grey	
182084	K-6427-7	33" x 22"	9"	N/A	Black	
172510	K-6427-96	33" x 22"	9"	N/A	Biscuit	
183608	K-6427-FF	33" x 22"	9"	N/A	Sea Salt	
179788	K-6427-FP	33" x 22"	9"	N/A	Caviar	
189040	K-6427-G9	33" x 22"	9"	N/A	Sandbar	
162053	K-6427-KA	33" x 22"	9"	N/A	Black n' Tan	
229641	K-6427-K4	33" x 22"	9"	N/A	Cashmere	
189143	K-6427-NY	33" x 22"	9"	N/A	Dune	

Whitehaven® Hayridge™ Design Under-Mount Apron Front Kitchen Sink

- Textured ridge design on apron-front
- Self-Trimming apron overlaps the cabinet face
- Basin slopes 2° toward drain to minimize water pooling



Part #	Mfg #	Overall Dimensions	Basin Depth	Holes	Color	Price
228948	K-7251-0	29-11/16" x 21-9/16"	9"	N/A	White	
182003	K-6351-0	35-11/16" x 21-9/16"	9"	N/A	White	

Kitchen Cast Iron Sinks

Whitehaven® Hayridge™ Design Under-Mount Apron Front Kitchen Sink

- Textured ridge design on apron-front
- Self-Trimming apron overlaps the cabinet face
- Basin slopes 2° toward drain to minimize water pooling



Part #	Mfg #	Overall Dimensions	Basin Depth	Holes	Color	Price
177022	K-6349-0	35-11/16" x 21-9/16"	9"	N/A	White	

Cast Iron Kitchen Sink Accessories



Alcott™ Bottom Sink Rack

- 19-5/8" x 13-3/8"



Part #	Mfg #	Overall Dimensions	Basin Depth	Holes	Color	Price	
170868	K-6005-ST	For Alcott™ Kitchen Sink, Stainless Steel					

Bakersfield™ Bottom Sink Rack

- 25" x 12-3/4"



Part #	Mfg #	Overall Dimensions	Basin Depth	Holes	Color	Price	
109399	K-6517-ST	For Model K-5832 Bakersfield™					

Brookfield™ Bottom Sink Rack

- 12-7/8" x 14-7/8"

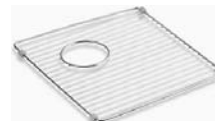

Part #	Mfg #	Overall Dimensions	Basin Depth	Holes	Color	Price	
162177	K-6197-ST	For Model K-5846, Left Bowl					

Cairn™ Bottom Sink Rack for Model K-8204

- Small Bowl—10-3/8" x 14-1/4" or large Bowl—17-1/4" x 14"

Part #	Mfg #	Overall Dimensions	Basin Depth	Holes	Color	Price	
178512	K-5198-ST	Small Bowl					
178511	K-5655-ST	Large Bowl					

Kitchen Cast Iron Sinks

Cape Dory™ Bottom Sink Rack for Models K-5863 and K-5864

- 13-3/8" x 27-1/2"

Part #	Mfg #	Description	Price
102211	K-6063-ST	For Models K-5863 and K-5864	

Dickinson® Bottom Sink Rack

- 27-1/2" x 13-1/4"



Part #	Mfg #	Overall Dimensions	Basin Depth	Holes	Color	Price
081337	K-6026-ST	For Model K-6546				

Deerfield® Bottom Sink Rack for Models K-5815 and K-5838

- 14-15/16" x 12-1/8"



Part #	Mfg #	Overall Dimensions	Basin Depth	Holes	Color	Price
161861	K-6039-ST	For Models K-5815 and K-5838				

Efficiency™ Executive Chef™ Sink Basket for Right Side Bowl

- 11-1/2" x 15-3/4"
- For models K-5931, K-5932, K-5948

Part #	Mfg #	Description	Price
106661	K-6521-ST	For Models K-5931, K-5932, and K-5948	

Efficiency™ Sink Rack for Left Bowl

- 14-1/4" x 17-1/2"

Part #	Mfg #	Overall Dimensions	Basin Depth	Holes	Color	Price
176731	K-6000-ST	For Model K-5948				

Executive Chef™ Bottom Sink Rack for Models K-5931 and K-5932

- 17-5/8" x 14-1/4"

Part #	Mfg #	Description	Price
102212	K-6001-ST	For Left Bowl	

Galleon™ Hardwood Cutting Board

- Fits over:
 - Alcott™ kitchen sinks
 - K-6546 Dickinson® kitchen sink
 - K-6534 Hawthorne™ kitchen sink



Part #	Mfg #	Overall Dimensions	Basin Depth	Holes	Color	Price
056176	K-5984-NA	Hardwood Construction				

Kitchen Cast Iron Sinks

Hartland® Stainless Steel Bottom Sink Rack with Rubber Feet for Model K-5818

- 12-1/4" x 16-3/4" (**K-6016R-ST** model)
- 13-1/8" x 16-7/8" (**K-5133-ST** & **K-5135-ST** models)

Part #	Mfg #	Overall Dimensions	Basin Depth	Holes	Color	Price
116718	K-6016R-ST	Right Bowl				
186214	K-5133-ST	Left Bowl				
177332	K-5135-ST	Right Bowl				

Hartland® Stainless Steel Sink Basket for Left Bowl with Rubber Feet

- 17-1/8" x 12-5/8"

Part #	Mfg #	Overall Dimensions	Basin Depth	Holes	Color	Price
116719	K-6603L-ST	For Model K-5818				

Indio® Colander for Model K-6411

- 14-3/8" x 8-7/16" x 4-3/8"
- Fits over Indio® kitchen sink



Part #	Mfg #	Overall Dimensions	Basin Depth	Holes	Color	Price
183093	K-6166-ST	Stainless Steel Mesh				

Indio® Hardwood Cutting Board for Model K-6411

- 18-1/4" x 10-1/2"
- Fits over Indio® Smart Divide kitchen sink



Part #	Mfg #	Overall Dimensions	Basin Depth	Holes	Color	Price
183092	K-6165-NA	American Walnut				

Iron/Tones® Sink Rack for K-6584 Kitchen Sink

- 13-3/8" x 14-5/8"
- Rack includes innovative wheels



Part #	Mfg #	Overall Dimensions	Basin Depth	Holes	Color	Price
174414	K-5184-ST	Stainless Steel				

Iron/Tones® Sink Rack for K-6625 Smart Divide® Kitchen Sink

- 8-1/4" x 14-3/8" (**5139-ST**)
- 18-1/4" x 14-3/8" (**5139-ST**)
- 17-1/2" x 14" (**6058-ST**)



Part #	Mfg #	Overall Dimensions	Basin Depth	Holes	Color	Price
181848	K-5137-ST	For Model K-6625 Large Bowl, Stainless Steel				
181849	K-5139-ST	For Model K-6625 Small Bowl, Stainless Steel				
094603	K-6058-ST	For Model K-6625 Large Bowl, Stainless Steel				

Kitchen Cast Iron Sinks

Langlade™ Smart Divide® Sink Rack for K-6626 Kitchen Sink

- 14-13/16" x 12-1/2" (K-6066-ST) or 14-7/8" x 12-1/2" (K-6061-ST)

Part #	Mfg #	Description	Price
094770	K-6061-ST	Left Bowl, Stainless Steel	
094543	K-6066-ST	Right Bowl, Stainless Steel	

Lawnfield® Bottom Sink Rack for K-5841 Kitchen Sink

- 15-3/8" x 16-1/2" (6160-ST) or 15-1/2" x 9-3/8" (6162-ST)

Part #	Mfg #	Overall Dimensions	Basin Depth	Holes	Color	Price
169469	K-6160-ST	Left Bowl, Stainless Steel				
169470	K-6162-ST	Right Bowl, Stainless Steel				

Octave® Sink Rack for K-3842 and K-3843 Kitchen Sinks

Part #	Mfg #	Overall Dimensions	Basin Depth	Holes	Color	Price
184801	K-6483-ST	Left Bowl, Stainless Steel				

Riverby® Sink Rack for K-5871 Kitchen Sink with Rubber Feet

- 14-1/16" x 9-9/16"

Part #	Mfg #	Overall Dimensions	Basin Depth	Holes	Color	Price
164945	K-6255-ST	Left Bowl, Stainless Steel				

Riverby® Hardwood Cutting Board for K-5871 and K-5872 Kitchen Sinks

Part #	Mfg #	Overall Dimensions	Basin Depth	Holes	Color	Price
164944	K-6246-NA	Maple Wood				

Whitehaven® Stainless Steel Sink Rack with Left and Right Racks

- Durable, electro-polished stainless steel construction
- Includes rubber feet



Part #	Mfg #	Description	Price
157424	K-6638-ST	For K-6486 and K-6487, 30"	
141639	K-6639-ST	For K-6488 and K-6489, 36"	
169955	K-6449-ST	For K-5826 and K-5827	

Whitehaven® Sink Rack for K-6426 and K-6427 Kitchen Sinks

- 17-5/8" x 14-9/16" (5828-ST) or 14-1/2" x 9-1/8" (5874-ST)



Part #	Mfg #	Description	Price
164010	K-5828-ST	Large Rack, Stainless Steel	
164011	K-5874-ST	Small Rack, Stainless Steel	

Kitchen Cast Iron Sinks

Woodfield™ Sink Rack for K-5839 Kitchen Sink

- 9-1/2" x 13" (**6021-ST**) or 13-3/4" x 15-3/4" (**6022-ST**)
- Model (**6021-ST**) is raised 2 inches for a shallow depth option



Part #	Mfg #	Description	Price
054721	K-6021-ST	Left Bowl, Stainless Steel	
054722	K-6022-ST	Right Bowl, Stainless Steel	

Sinks

Kitchen Fireclay Sinks

Apron Front Kitchen Sinks Alcott™ Tile-In Apron Front Sink

- 25" x 22" Single bowl
- Center drain
- 27" Minimum apron sink base cabinet width
- Available with 3 or 4 faucet holes
- Fireclay



Part #	Mfg #	Overall Dimensions	Basin Depth	Holes	Color	Price
099898	K-6573-3-0	25" x 22"	8"	3	White	
080214	K-6573-4-0	25" x 22"	8"	4	White	
123863	K-6573-4-96	25" x 22"	8"	4	Biscuit	

Alcott™ Under-Mount Apron Front Sink

- 25" x 22" Single bowl
- Center drain
- 27" Minimum apron sink base cabinet
- 5 Oversized faucet holes allow for easy installation
- Fireclay



Part #	Mfg #	Overall Dimensions	Basin Depth	Holes	Color	Price
069752	K-6573-5U-0	25" x 22"	8"	5U	White	
104325	K-6573-5U-47	25" x 22"	8"	5U	Almond	
091535	K-6573-5U-7	25" x 22"	8"	5U	Black	
059753	K-6573-5U-96	25" x 22"	8"	5U	Biscuit	

Evenweave® Design on Alcott™

- 25" x 22"
- Fireclay
- Center drain
- Fits minimum 27" apron sink base cabinet
- Decorated with a textured woven pattern



Part #	Mfg #	Overall Dimensions	Basin Depth	Holes	Color	Price
168489	K-14572-T3-W2	25" x 22"	8"	5U	Earthen White	

Kitchen Fireclay Sinks

Fireclay Sinks

Cerana™ Fireclay Apron Front Kitchen Sink

- Due to dual-style design, no cutout template is provided
- Ultra durable surface fired at over 2,100°F
- Apron face 10" deep
- Center drain (not included)



Part #	Mfg#	Overall Dimensions	Bowl Depth	Cabinet Size	Color	Price
175401	441695	33" x 19"	9-1/4"	36"	White	

Cerana™ Fireclay Undermount Bar Sink

- Fireclay material allows for perfect, smooth, and easy to clean surface
- Ultra durable surface fired at over 2,100°F
- Rear drain placement



Part #	Mfg#	Overall Dimensions	Bowl Depth	Cabinet Size	Color	Price
154557	518542	18-7/8" x 18-7/8"	7"	24"	White	

Sinks

Kitchen Fireclay Sinks

Fine Fireclay Sinks

Explore™ Fine Fireclay Undermount Farm Apron Front Double Bowl Kitchen Sink

- *Gloss finish*
- *10" High apron*
- *1/4" Reveal*
- *Center drain*



Sinks

Part #	Mfg #	Overall Size	Bowl Sizes	Depth	Drain Opening	Min Sink Base	Color	Price
176045	SWUF32189BI	32-3/4" x 19-7/8"	N/A	9"	3-1/2"	36"	Biscuit	
176042	SWUF32189WH	32-3/4" x 19-7/8"	N/A	9"	3-1/2"	36"	White	

Kitchen Composite Sinks

E-Granite™ Sinks

Gourmet® E-Granite™ Dual-Mount Single Bowl Sink

- Molded from E-Granite which is up to 80% natural quartz and acrylic resins
- Naturally sound deadened, heat resistant
- Can be mounted as top-mount or undermount
- 3/8" Rim height
- Drains not included



Part #	Mfg #	Overall Size	Holes	Depth	Drain Opening	Min Sink Base	Color	Price
149970	ELG1515GY0	16-5/8" x 16-5/8"	0	8"	3-1/2"	21"	Dusk Gray	
121170	ELG1515MC0	16-5/8" x 16-5/8"	0	8"	3-1/2"	21"	Mocha	
229399	ELG1616SD0	15-3/4" x 15-3/4"	0	7-11/16"	3-1/2"	21"	Sand	

Gourmet® E-Granite™ Undermount Single Bowl Kitchen Sink with Offset Drain

- Molded from E-Granite which is up to 80% natural quartz and acrylic resins
- Naturally sound deadened and heat-resistant
- Drains not included



Part #	Mfg #	Overall Size	Holes	Depth	Drain Opening	Min Sink Base	Color	Price
186640	ELGU13322BK0	33" x 18-3/4"	N/A	9-1/2"	3-1/2"	36"	Black	
187879	ELGU13322GY0	33" x 18-3/4"	N/A	9-1/2"	3-1/2"	36"	Dusk Gray	
171950	ELGU13322MCO	33" x 18-3/4"	N/A	9-1/2"	3-1/2"	36"	Mocha	
222801	ELGU13322WH0	33" x 18-3/4"	N/A	9-1/2"	3-1/2"	36"	White	

Gourmet® E-Granite™ Undermount Single Bowl Sink

- Molded from E-Granite which is up to 80% natural quartz and acrylic resins
- Naturally sound deadened and heat-resistant
- Drains not included



Part #	Mfg #	Overall Size	Holes	Depth	Drain Opening	Min Sink Base	Color	Price
108366	ELGU2522BK0	25" x 18-1/2"	N/A	9-1/2"	3-1/2"	30"	Black	
108367	ELGU2522BQ0	25" x 18-1/2"	N/A	9-1/2"	3-1/2"	30"	Bisque	
189667	ELGU2522GRO	25" x 18-1/2"	N/A	9-1/2"	3-1/2"	30"	Greige	
190084	ELGU2522GS0	25" x 18-1/2"	N/A	9-1/2"	3-1/2"	30"	Graystone	
149820	ELGU2522GY0	25" x 18-1/2"	N/A	9-1/2"	3-1/2"	30"	Dusk Gray	
121423	ELGU2522MC0	25" x 18-1/2"	N/A	9-1/2"	3-1/2"	30"	Mocha	
108368	ELGU2522WH0	25" x 18-1/2"	N/A	9-1/2"	3-1/2"	30"	White	

Kitchen Composite Sinks

Gourmet® E-Granite™ Self-Rimming Single Bowl Sink

- Molded from E-Granite which is up to 80% natural quartz and acrylic resins
- Non-porous and stain resistant
- Hard surface is scratch and chip resistant
- Naturally sound deadened and heat resistant
- Rim height: 3/8"
- Drains not included



Part #	Mfg #	Overall Size	Holes	Depth	Drain Opening	Min Sink Base	Color	Price
108354	ELG2522BK0	25" x 22"	Prescored up to 5	9-1/2"	3-1/2"	30"	Black	
222124	ELG2522GR0	25" x 22"	Prescored up to 5	9-1/2"	3-1/2"	30"	Greige	
173325	ELG2522GY0	25" x 22"	Prescored up to 5	9-1/2"	3-1/2"	30"	Dusk Grey	

Gourmet® E-Granite™ Self-Rimming Single Bowl Kitchen Sink

- Molded with 80% natural quartz and acrylic resins
- Non-porous and stain resistant
- Naturally sound deadening
- Drains not included



Part #	Mfg #	Overall Size	Holes	Depth	Drain Opening	Min Sink Base	Color	Price
185464	ELG13322BK0	33" x 22"	Pre-Scored up to 7	9-1/2"	3-1/2"	36"	Black	
189321	ELG13322GY0	33" x 22"	Pre-Scored up to 7	9-1/2"	3-1/2"	36"	Dusk Grey	
189317	ELG13322WH0	33" x 22"	Pre-Scored up to 7	9-1/2"	3-1/2"	36"	White	
223146	ELGR13322PT0	33" x 20-7/8"	Pre-Scored up to 5	9-7/16"	3-1/2"	36"	Putty	

Gourmet® E-Granite™ Undermount Single Bowl Kitchen Sink

- Molded with 80% natural quartz and acrylic resins
- Non-porous and stain resistant
- Naturally sound deadening
- Drains not included



Part #	Mfg #	Overall Size	Holes	Depth	Drain Opening	Min Sink Base	Color	Price
225671	ELGRU13322GS0	33" x 18-7/16"	N/A	9-7/16"	3-1/2"	36"	Graystone	
226410	ELGRU13322MC0	33" x 18-7/16"	N/A	9-7/16"	3-1/2"	36"	Mocha	
224612	ELGRU13322WH0	33" x 18-7/16"	N/A	9-7/16"	3-1/2"	36"	White	

Sinks

Kitchen Composite Sinks

Sinks

Harmony™ E-Granite™ Self-Rimming Single Bowl Sink

- Molded from up to 80% natural quartz and acrylic resins
- Naturally sound deadened, heat resistant
- 3/8" Rim height
- Drains not included



Part #	Mfg #	Overall Size	Bowl Sizes	Depth	Drain Opening	Min Sink Base	Color	Price
122788	ELGS3322RMC0	33" x 22"	Pre-scored up to 5	9-1/2"	3-1/2"	36"	Mocha	
227343	ELGS3322RPC0	33" x 22"	Pre-scored up to 5	9-1/2"	3-1/2"	36"	Pecan	
127639	ELGS3322RWH0	33" x 22"	Pre-scored up to 5	9-1/2"	3-1/2"	36"	White	

The Mystic® E-Granite™ Dual-Mount Single Bowl Bar Sink

- Molded from 80% natural quartz and acrylic resins
- Naturally sound deadening
- Rear center drain placement
- Drains not included



Part #	Mfg #	Overall Size	Bowl Sizes	Depth	Drain Opening	Min Sink Base	Color	Price
173611	ELG16FBBK0	18-1/8" x 18-1/8"	N/A	7-1/2"	3-1/2"	24"	Black	
217735	ELG16FBMC0	18-1/8" x 18-1/8"	N/A	7-1/2"	3-1/2"	24"	Mocha	

Gourmet® E-Granite™ Self-Rimming Single Bowl Kitchen Sink

- Molded from up to 80% natural quartz and acrylic resins
- Naturally sound deadened, heat resistant
- Rear center drain location
- Drains not included



Part #	Mfg #	Overall Size	Bowl Sizes	Depth	Drain Opening	Min Sink Base	Color	Price
226421	ELGS2522SD0	25" x 22"	Pre-scored up to 2	8-1/2"	3-1/2"	30"	Sand	

Gourmet® E-Granite™ Self-Rimming Double Bowl Sink

- Molded from E-Granite which is up to 80% natural quartz and acrylic resins
- Non-porous and stain resistant
- Hard surface is scratch and chip resistant
- Naturally sound deadened and heat resistant
- Drains not included



ELG3322BK

Part #	Mfg #	Overall Size	Holes	Depth	Drain Opening	Min Sink Base	Color	Price
108350	ELG3322BK0	33" x 22"	Pre-scored up to 4	9-1/2"	3-1/2"	36"	Black	
108352	ELG3322BQ0	33" x 22"	Pre-scored up to 4	9-1/2"	3-1/2"	36"	Bisque	
189660	ELG3322GR0	33" x 22"	Pre-scored up to 4	9-1/2"	3-1/2"	36"	Greige	

Kitchen Composite Sinks

E-Granite™ Sinks (Continued)

Gourmet® E-Granite™ Self-Rimming Double Bowl Sink

Part #	Mfg #	Overall Size	Holes	Depth	Drain Opening	Min Sink Base	Color	Price
121419	ELG3322MC0	33" x 22"	Pre-scored up to 4	9-1/2"	3-1/2"	36"	Mocha	
223425	ELG3322SD0	33" x 22"	Pre-scored up to 4	9-1/2"	3-1/2"	36"	Sand	
108353	ELG3322WH0	33" x 22"	Pre-scored up to 4	9-1/2"	3-1/2"	36"	White	

Gourmet® E-Granite™ Self-Rimming Double Bowl Sink

- Molded from E-Granite which is up to 80% natural quartz and acrylic resins
- Naturally sound deadened, heat resistant
- Top-mount
- Rim height: 3/8"
- Drains not included



ELG250RBK

Part #	Mfg #	Overall Size	Holes	Depth	Drain Opening	Min Sink Base	Color	Price
108347	ELG250RBK0	33" x 22"	0	9-1/2"	3-1/2"	36"	Black	
108348	ELG250RBQ0	33" x 22"	0	9-1/2"	3-1/2"	36"	Bisque	
121420	ELG250RMC0	33" x 22"	0	9-1/2"	3-1/2"	36"	Mocha	
174057	ELG250RGY0	33" x 22"	0	9-1/2"	3-1/2"	36"	Dusk Gray	
108349	ELG250RWH0	33" x 22"	0	9-1/2"	3-1/2"	36"	White	

Gourmet® E-Granite™ Undermount Single Bowl Kitchen Sink

- Molded from up to 80% natural quartz and acrylic resins
- Naturally sound deadened, heat resistant
- Rear center drain location
- Drains not included



Part #	Mfg #	Overall Size	Bowl Sizes	Depth	Drain Opening	Min Sink Base	Color	Price
227496	ELGSU2522BK0	25" x 22"	N/A	8-1/2"	3-1/2"	30"	Black	
229486	ELGSU2522WH0	25" x 22"	N/A	8-1/2"	3-1/2"	30"	White	

Gourmet® E-Granite™ Undermount Double Bowl Sink

- Molded from E-Granite which is up to 80% natural quartz and high performance acrylic resins
- Non-porous and stain resistant
- Hard surface is scratch and chip resistant
- Naturally sound deadened and heat resistant
- Drains not included



Part #	Mfg #	Overall Size	Holes	Depth	Drain Opening	Min Sink Base	Color	Price
108360	ELGU250RBK0	33" x 20-1/2"	N/A	9-1/2"	3-1/2"	36"	Black	
108361	ELGU250RBQ0	33" x 20-1/2"	N/A	9-1/2"	3-1/2"	36"	Bisque	
223144	ELGU250RGS0	33" x 20-1/2"	N/A	9-1/2"	3-1/2"	36"	Greystone	
147723	ELGU250RGY0	33" x 20-1/2"	N/A	9-1/2"	3-1/2"	36"	Dusk Gray	
120802	ELGU250RMC0	33" x 20-1/2"	N/A	9-1/2"	3-1/2"	36"	Mocha	

Kitchen Composite Sinks

E-Granite™ Sinks (Continued)

Gourmet® E-Granite™ Undermount Double Bowl Sink

Part #	Mfg #	Overall Size	Holes	Depth	Drain Opening	Min Sink Base	Color	Price
225118	ELGU250RPT0	33" x 20-1/2"	N/A	9-1/2"	3-1/2"	36"	Putty	
108362	ELGU250RWH0	33" x 20-1/2"	N/A	9-1/2"	3-1/2"	36"	White	

Gourmet® E-Granite™ Undermount Double Bowl Sink with Aqua Divide

- Molded from E-Granite™ which is up to 80% natural quartz and high performance acrylic resins
- Non-porous and stain resistant
- Hard surface is scratch and chip resistant
- Naturally sound deadened and heat resistant
- Drains not included



Part #	Mfg #	Overall Size	Holes	Depth	Drain Opening	Min Sink Base	Color	Price
181204	ELGULBO3322BK0	33" x 20-1/2"	N/A	9-1/2"	3-1/2"	36"	Black	
184850	ELGULBO3322BQ0	33" x 20-1/2"	N/A	9-1/2"	3-1/2"	36"	Bisque	
185402	ELGULBO3322GY0	33" x 20-1/2"	N/A	9-1/2"	3-1/2"	36"	Dusk Gray	
180485	ELGULBO3322MC0	33" x 20-1/2"	N/A	9-1/2"	3-1/2"	36"	Mocha	
223537	ELGULBO3322WH0	33" x 20-1/2"	N/A	9-1/2"	3-1/2"	36"	White	

Gourmet® E-Granite™ Undermount Offset Double Bowl Sink

- Molded from E-Granite™—up to 80% natural quartz and high performance acrylic resins
- Non-porous and stain resistant
- hard surface is scratch resistant
- Naturally sound deadening
- Drains not included



Part #	Mfg #	Overall Size	Holes	Depth	Drain Opening	Min Sink Base	Color	Price
225040	ELGOU3321LBK0	33" x 20-11/16"	N/A	9"	3-1/2"	36"	Black	
226150	ELGOU3321LGR0	33" x 20-11/16"	N/A	9"	3-1/2"	36"	Greige	
223948	ELGOU3321LGY0	33" x 20-11/16"	N/A	9"	3-1/2"	36"	Dusk Gray	
225645	ELGOU3321LMC0	33" x 20-11/16"	N/A	9"	3-1/2"	36"	Mocha	

Sinks

Kitchen Composite Sinks

Gourmet® E-Granite™ Undermount Double Equal Bowl Sink

- Molded from E-Granite which is up to 80% natural quartz and high performance acrylic resins
- Non-porous and stain resistant
- Hard surface is scratch and chip resistant
- Naturally sound deadened and heat resistant
- Drains not included



ELGU3322BK

Part #	Mfg #	Overall Size Color	Bowl Sizes	Depth	Drain Opening	Min Sink Base	Price
108363	ELGU3322BK0	33" x 18-3/4"	N/A	9-1/2"	3-1/2"	36"	Black
108364	ELGU3322BQ0	33" x 18-3/4"	N/A	9-1/2"	3-1/2"	36"	Bisque
189887	ELGU3322GR0	33" x 18-3/4"	N/A	9-1/2"	3-1/2"	36"	Greige
223143	ELGU3322GS0	33" x 18-3/4"	N/A	9-1/2"	3-1/2"	36"	Greystone
146193	ELGU3322GY0	33" x 18-3/4"	N/A	9-1/2"	3-1/2"	36"	Dusk Gray
121425	ELGU3322MC0	33" x 18-3/4"	N/A	9-1/2"	3-1/2"	36"	Mocha
223456	ELGU3322SD0	33" x 18-3/4"	N/A	9-1/2"	3-1/2"	36"	Sand

Gourmet® E-Granite™ Luxe Undermount Double Equal Bowl Sink

- Proprietary manufacturing process
—Combines natural quartz with high performance UV resins
- Patented webbing and embedded organic fibers
- Non-porous and stain resistant
- Hard surface is scratch and chip resistant
- Naturally sound deadened and heat resistant
- Drains not included



Part #	Mfg #	Overall Size Color	Bowl Sizes	Depth	Drain Opening	Min Sink Base	Price
227644	ELXU3322CN0	33" x 18-3/4"	N/A	9-1/2"	3-1/2"	36"	Chestnut

Harmony® E-Granite™ Undermount Single Bowl Sink

- Molded from E-Granite which is up to 80% natural quartz and acrylic resins
- Naturally sound deadened, heat resistant
- 3/8" Rim height
- Drains not included



Part #	Mfg #	Overall Size	Bowl Size	Depth	Drain Opening	Min Sink Base	Color	Price
122789	ELGUS3322RBK0	33" x 20"	N/A	9-1/2"	3-1/2"	36"	Black	
153305	ELGUS3322RGY0	33" x 20"	N/A	9-1/2"	3-1/2"	36"	Dusk Gray	
122791	ELGUS3322RMC0	33" x 20"	N/A	9-1/2"	3-1/2"	36"	Mocha	

Sinks

Kitchen Composite Sinks

Sinks

Harmony® E-Granite™ Self-Rimming Double Bowl Sink with Aqua Divide

- Molded from E-Granite which is up to 80% natural quartz and acrylic resins
- Non-porous and stain resistant
- Hard surface is scratch and chip resistant
- Naturally sound deadened and heat resistant
- Rim height: 3/8"
- Aqua divide height: 4"
- Drains not included

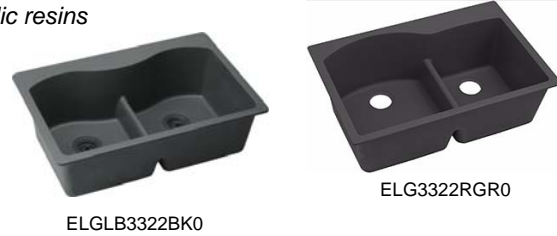

Part #	Mfg #	Overall Size	Holes	Depth	Drain Opening	Min Sink Base	Color	Price
122792	ELGLB3322BK0	33" x 22"	Pre-scored up to 5	9-1/2"	3-1/2"	36"	Black	
122793	ELGLB3322BQ0	33" x 22"	Pre-scored up to 5	9-1/2"	3-1/2"	36"	Bisque	
160967	ELGLB3322GY0	33" x 22"	Pre-scored up to 5	9-1/2"	3-1/2"	36"	Dusk Gray	
122794	ELGLB3322MC0	33" x 22"	Pre-scored up to 5	9-1/2"	3-1/2"	36"	Mocha	

Harmony® E-Granite™ Self-Rimming Offset Double Bowl Sink with Aqua Divide

- Molded from E-Granite which is up to 80% natural quartz and acrylic resins
- Non-porous and stain resistant
- Hard surface is scratch and chip resistant
- Naturally sound deadened and heat resistant
- Rim height: 3/8"
- Aqua divide height: 4"
- Drains not included



Part #	Mfg #	Overall Size	Holes	Depth	Drain Opening	Min Sink Base	Color	Price
189942	ELGH3322RGR0	33" x 22"	Pre-scored up to 4	10"	3-1/2"	36"	Greige	
225993	ELGH3322RGS0	33" x 22"	Pre-scored up to 4	10"	3-1/2"	36"	Graystone	
225621	ELGH3322RGY0	33" x 22"	Pre-scored up to 4	10"	3-1/2"	36"	Dusk Gray	
227033	ELGH3322RMC0	33" x 22"	Pre-scored up to 4	10"	3-1/2"	36"	Mocha	
227711	ELGH3322RSD0	33" x 22"	Pre-scored up to 4	10"	3-1/2"	36"	Sand	

Harmony® E-Granite™ Undermount Offset Double Bowl Sink

- Molded from E-Granite which is up to 80% natural quartz and acrylic resins
- Non-porous and stain resistant
- Hard surface is scratch and chip resistant
- Naturally sound deadened and heat resistant
- Rim height: 3/8"
- Aqua divide height: 4"
- Drains not included



Part #	Mfg #	Overall Size	Holes	Depth	Drain Opening	Min Sink Base	Color	Price
223424	ELGHU3220RBQ0	32-1/2" x 20"	N/A	10"	3-1/2"	36"	Bisque	
226116	ELGHU3220RPT0	32-1/2" x 20"	N/A	10"	3-1/2"	36"	Putty	
226429	ELGHU3322RGY0	32-1/2" x 20"	N/A	10"	3-1/2"	36"	Graystone	

Kitchen Composite Sinks

Harmony® E-Granite™ Self-Rimming Double Bowl Sink with Aqua Divide

- Molded from E-Granite which is up to 80% natural quartz and acrylic resins
- Non-porous and stain resistant
- Hard surface is scratch and chip resistant
- Naturally sound deadened and heat resistant
- Aqua divide height: 4"



Part #	Mfg #	Overall Size	Holes	Depth	Drain Opening	Min Sink Base	Color	Price
186758	ELGLB03322BK0	33" x 22"	Pre-scored up to 3	9-1/2"	3-1/2"	36"	Black	
224537	ELGLB03322GY0	33" x 22"	Pre-scored up to 3	9-1/2"	3-1/2"	36"	Dusk Gray	

Harmony® E-Granite™ Undermount Double Bowl Sink with Aqua Divide

- Molded from E-Granite which is up to 80% natural quartz and acrylic resins
- Non-porous and stain resistant
- Hard surface is scratch and chip resistant
- Naturally sound deadened and heat resistant
- Rim height: 3/8"
- Aqua divide height: 4"
- Drains not included



ELGULB3322BK

Part #	Mfg #	Overall Size	Bowl Sizes	Depth	Drain Opening	Min Sink Base	Color	Price
122795	ELGULB3322BK0	33" x 20"	N/A	9-1/2"	3-1/2"	36"	Black	
122796	ELGULB3322BQ0	33" x 20"	N/A	9-1/2"	3-1/2"	36"	Bisque	
223457	ELGULB3322GR0	33" x 20"	N/A	9-1/2"	3-1/2"	36"	Greige	
223145	ELGULB3322GS0	33" x 20"	N/A	9-1/2"	3-1/2"	36"	Greystone	
154713	ELGULB3322GY0	33" x 20"	N/A	9-1/2"	3-1/2"	36"	Dusk Gray	
122797	ELGULB3322MC0	33" x 20"	N/A	9-1/2"	3-1/2"	36"	Mocha	
131838	ELGULB3322WH0	33" x 20"	N/A	9-1/2"	3-1/2"	36"	White	

Harmony® E-Granite™ Undermount Double Bowl Sink with Aqua Divide and Deep Depth

- Molded from E-Granite which is up to 80% natural quartz and acrylic resins
- Non-porous and stain resistant
- Hard surface is scratch and chip resistant
- Naturally sound deadened and heat resistant
- Rim height: 3/8"
- Aqua divide height: 5"
- Drains not included



Part #	Mfg #	Overall Size	Bowl Sizes	Depth	Drain Opening	Min Sink Base	Color	Price
224441	ELGDULB3322BK0	33" x 19"	N/A	10"	3-1/2"	36"	Black	

Sinks

Kitchen Composite Sinks

Harmony® E-Granite™ Self-Rimming Double Bowl Sink with Aqua Divide and Deep Depth

- Molded from E-Granite which is up to 80% natural quartz and acrylic resins
- Non-porous and stain resistant
- Hard surface is scratch and chip resistant
- Naturally sound deadened and heat resistant
- Rim height: 3/8"
- Aqua divide height: 5"
- Drains not included



Sinks

Part #	Mfg #	Overall Size	Bowl Sizes	Depth	Drain Opening	Min Sink Base	Color	Price
227330	ELGDLB3322BQ0	33" x 22"	Pre-Scored up to 5	10"	3-1/2"	36"	Bisque	
224983	ELGDLB3322MC0	33" x 22"	Pre-Scored up to 5	10"	3-1/2"	36"	Mocha	
225486	ELGDLB3322SD0	33" x 22"	Pre-Scored up to 5	10"	3-1/2"	36"	Sand	

Kitchen Composite Sinks

Neoroc™ Composite Sinks

Cairn™ Under-Mount Double Bowl Kitchen Sink

- Versatile design allows large basin to be installed on left or right
- Slim divide creates more space in basins
- No faucet holes
- Includes K-5655 bottom basin rack and cutout template
- Neoroc™
- Matte finish
- Heat resistant up to 750° F
- Scratch, stain, chip, and thermal-shock resistant



K-8204: Offset bowls

K-8199: Double equal bowls

Part #	Mfg #	Overall Dimensions	Basin Depth	Holes	Color	Price
185391	K-8199-CM1	33-1/2" x 18-5/16"	9-1/2"	N/A	Matte Black	
185435	K-8199-CM2	33-1/2" x 18-5/16"	9-1/2"	N/A	Matte Brown	
178508	K-8204-CM1	33-1/2" x 18-1/4"	10"	N/A	Matte Black	
188253	K-8204-CM2	33-1/2" x 18-1/4"	10"	N/A	Matte Brown	

Cairn™ Under-Mount Single Bowl Kitchen Sink

- 36" Minimum base cabinet
- No faucet holes
- Neoroc™
- Includes K-5196 bottom basin rack and cutout template
- Matte finish
- Heat resistant up to 750° F
- Scratch, stain, chip, and thermal-shock resistant



Part #	Mfg #	Overall Dimensions	Basin Depth	Holes	Color	Price
188254	K-8206-CM1	33-1/2" x 18-5/16"	10"	N/A	Matte Black	
188255	K-8206-CM2	33-1/2" x 18-5/16"	10"	N/A	Matte Brown	

Kitchen Composite Sinks

Kitchen Sinks

- Resist stains
- Absorbs disposer vibration

Drop-In Double Bowl Composite Sink

- Contemporary design applied to classic sink features
- Standard size makes it an ideal replacement sink for an easy kitchen update
- Virtually indestructible - will not damage from kitchen use
- Made with 80% actual quartz stone - only a diamond is harder
- 9" Deep bowls

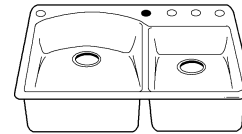

Part #	Mfg #	Dimensions	Bowl	Mounting	Color	Price
103258	QZAD-3322-077	33" x 22"	Ascend	Drop-In/Undermount	Nero	
090628	QZSB-2522-077	25" x 22"	Single	Drop-In/Undermount	Nero	
087023	QZDB-3322-077	33" x 22"	Double	Drop-In/Undermount	Nero	
102675	QZLS-3322-077	33" x 22"	Double (Lrg/Sml)	Drop-In/Undermount	Nero	

Under-Mount Double Bowl Composite Sink

- Contemporary design applied to classic sink features
- Standard size makes it an ideal replacement sink for an easy kitchen update
- Virtually indestructible - will not damage from kitchen use
- Made with 80% actual quartz stone - only a diamond is harder
- 9" Deep bowls

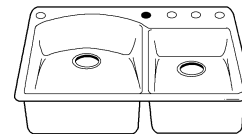

Part #	Mfg #	Dimensions	Bowl	Mounting	Color	Price
105400	QUAD-3322-077	32" x 21"	Ascend	Undermount	Nero	
099359	QUDB-3322-077	33" x 22"	Double	Undermount	Nero	
109792	QUDB-3322-076	33" x 22"	Double	Undermount	Granite	
106399	QUDB-3322-075	33" x 22"	Double	Undermount	Bianca	
131767	QUDB-3322-170	33" x 22"	Double	Undermount	Espresso	
102941	QULS-3322-077	33" x 22"	Double (Lrg/Sml)	Undermount	Nero	
131766	QULS-3322-170	33" x 22"	Double (Lrg/Sml)	Undermount	Espresso	

Granite Bar Sink

- Contemporary design applied to classic sink features
- Standard size makes it as a kitchen island sink
- Virtually indestructible - will not damage from kitchen use
- Made with 80% actual quartz stone - only a diamond is harder
- 8" Deep bowls

Part #	Mfg #	Size	Bowl	Mounting	Color	Price
130611	QZBS-1816-077	18" x 16"	Single	Drop-In/Undermount	Nero	

Sinks

Kitchen Composite Sinks

KSDB-3322 Solid Surface Double Bowl Kitchen Sink

- Easily accommodates all faucet styles
- Renewable surface will not wear away
- Hot pots and boiling water will not harm it



Part #	Mfg #	Dimensions	Color	Price
010230	KSDB-3322-046	33" x 22" x 9"	Almond Galaxy	
031736	KSDB-3322-015	33" x 22" x 9"	Black Galaxy	
032764	KSDB-3322-051	33" x 22" x 9"	Tahiti Sand	
038003	KSDB-3322-011	33" x 22" x 9"	Tahiti White	
010235	KSDB-3322-010	33" x 22" x 9"	White	

Sinks

Kitchen Composite Sinks

Top-Mount Single Bowl Kitchen Sinks

Diamond™ SILGRANIT® II Super Single Bowl Top-Mount Kitchen Sink

- Versatile dual deck design can be installed as a drop-in or undermount
- Pre-drilled with 1 hole, 6 additional knockout hole locations
- Under-mount clips NOT included
- Cutout template included



Part #	Mfg#	Overall Dimensions	Bowl Depth	Cabinet Size	Color	Price
134046	440195	33-1/2" x 22"	9-1/2"	36"	White	
127504	440194	33-1/2" x 22"	9-1/2"	36"	Anthracite	
065937	440193	33-1/2" x 22"	9-1/2"	36"	Metallic Gray	
142021	440192	33-1/2" x 22"	9-1/2"	36"	Cafe Brown	
172001	440196	33-1/2" x 22"	9-1/2"	36"	Biscuit	
141599	441214	33-1/2" x 22"	9-1/2"	36"	Biscotti	
138256	441287	33-1/2" x 22"	9-1/2"	36"	Truffle	
163162	441467	33-1/2" x 22"	9-1/2"	36"	Cinder	

Diamond™ SILGRANIT® II Single Bowl Top-Mount Sink

- Versatile dual deck design can be installed as a drop-in or undermount
- Pre-drilled with 1 hole, 1 additional knockout hole location
- Cutout size: 24-1/4" x 21-1/4"
- Under-mount clips NOT included



Part #	Mfg#	Overall Dimensions	Bowl Depth	Cabinet Size	Color	Price
153471	440211	25" x 22"	10"	27"	White	
132113	440210	25" x 22"	10"	27"	Anthracite	
155775	440209	25" x 22"	10"	27"	Metallic Gray	
150501	440208	25" x 22"	10"	27"	Cafe Brown	
155152	440212	25" x 22"	10"	27"	Biscuit	
146876	441215	25" x 22"	10"	27"	Biscotti	
155058	441280	25" x 22"	10"	27"	Truffle	
189703	441463	25" x 22"	10"	27"	Cinder	

Modex™ SILGRANIT II™ Top-Mount Kitchen Sink

- Unique 3" profile that sits above the counter
- Template provided



Part #	Mfg#	Overall Dimensions	Bowl Depth	Cabinet Size	Color	Price
182302	518619	47-1/4" x 23-3/4"	7-7/8"	27"	Anthracite	

Sinks

Kitchen Composite Sinks

Top-Mount Double Bowl Kitchen Sinks

Diamond™ SILGRANIT II® 1-3/4 Double bowl Top-Mount Kitchen Sink

- Versatile dual deck design can be installed as a drop-in or undermount
- Pre-drilled with 1 hole, 4 additional knockout hole locations
- Slim bowl divider
- Under-mount clips NOT included



Sinks

Part #	Mfg#	Overall Dimensions	Bowl Depth	Cabinet Size	Color	Price
139085	440221	33" x 22"	9-1/2"	36"	White	
132112	440220	33" x 22"	9-1/2"	36"	Anthracite	
150251	440219	33" x 22"	9-1/2"	36"	Metallic Gray	
127173	440218	33" x 22"	9-1/2"	36"	Cafe Brown	
098630	440222	33" x 22"	9-1/2"	36"	Biscuit	
131540	441217	33" x 22"	9-1/2"	36"	Biscotti	
138254	441285	33" x 22"	9-1/2"	36"	Truffle	
158978	441466	33" x 22"	9-1/2"	36"	Cinder	

Diamond™ SILGRANIT® II 1-3/4 Double Bowl Top-Mount Kitchen Sink

- Versatile dual deck design can be installed as a drop-in or undermount
- Pre-drilled with 1 hole, 4 additional knockout hole locations
- Slim bowl divider
- Under-mount clips NOT included
- Cutout size 32-1/4" x 21-1/4"



Part #	Mfg#	Overall Dimensions	Bowl Depth	Cabinet Size	Color	Price
138495	440216	33" x 22"	9-1/2" & 8"	36"	White	
062156	440215	33" x 22"	9-1/2" & 8"	36"	Anthracite	
155995	440214	33" x 22"	9-1/2" & 8"	36"	Metallic Gray	
126560	440213	33" x 22"	9-1/2" & 8"	36"	Cafe Brown	
084557	440217	33" x 22"	9-1/2" & 8"	36"	Biscuit	
131538	441216	33" x 22"	9-1/2" & 8"	36"	Biscotti	
138252	441283	33" x 22"	9-1/2" & 8"	36"	Truffle	
158014	441465	33" x 22"	9-1/2" & 8"	36"	Cinder	

Diamond™ SILGRANIT® II 1-1/2 Double Bowl Kitchen Sink

- Versatile dual deck design can be installed as a drop-in or undermount
- Pre-drilled with 1 hole, 4 additional knockout hole locations
- Slim bowl divider
- Under-mount clips NOT included
- Cutout size 32-1/4" x 21-1/4"



Part #	Mfg#	Overall Dimensions	Bowl Depth	Cabinet Size	Color	Price
166164	440200	33" x 22"	9-1/2" & 8"	33"	White	
086308	440199	33" x 22"	9-1/2" & 8"	33"	Anthracite	
138569	440198	33" x 22"	9-1/2" & 8"	33"	Metallic Gray	
144303	440197	33" x 22"	9-1/2" & 8"	33"	Cafe Brown	

Kitchen Composite Sinks

Top-Mount Double Bowl Kitchen Sinks (Continued)
Diamond™ SILGRANIT® II 1-1/2 Double Bowl Kitchen Sink

Part #	Mfg#	Overall Dimensions	Bowl Depth	Cabinet Size	Color	Price
151455	440201	33" x 22"	9-1/2" & 8"	33"	Biscuit	
149507	441221	33" x 22"	9-1/2" & 8"	33"	Biscotti	
158243	441282	33" x 22"	9-1/2" & 8"	33"	Truffle	
157912	441464	33" x 22"	9-1/2" & 8"	33"	Cinder	

Under-Mount Single Bowl Kitchen Sinks
Diamond™ Super Single Bowl Kitchen Sink

- Cutout template included with 1/8" reveal
- Under-mount clips included



Part #	Mfg#	Overall Dimensions	Bowl Depth	Cabinet Size	Color	Price
176225	441764	33-1/2" x 18-1/2"	9-1/2"	36"	Cinder	
175391	441765	33-1/2" x 18-1/2"	9-1/2"	36"	Truffle	
181170	441767	33-1/2" x 18-1/2"	9-1/2"	36"	White	
180964	441768	33-1/2" x 18-1/2"	9-1/2"	36"	Anthracite	
180709	441769	33-1/2" x 18-1/2"	9-1/2"	36"	Biscuit	
188244	441766	33-1/2" x 18-1/2"	9-1/2"	36"	Biscotti	
180128	441770	33-1/2" x 18-1/2"	9-1/2"	36"	Metallic Gray	
186625	441771	33-1/2" x 18-1/2"	9-1/2"	36"	Cafe Brown	

Ikon™ Apron Front Single Bowl Kitchen Sink

- Requires modified cabinet: 33" or 36"
- 80% solid granite
- Heat resistant up to 536°F
- Unsurpassed cleanability backed by industry leading 7 patents!
- Resistant to scratches, stains and all household acids and alkali solutions
- Template provided with approximate 1/8" reveal
- Apron front is 10" high
- Rim width is 1-1/2"



Part #	Mfg#	Overall Dimensions	Bowl Depth	Cabinet Size	Color	Price
187764	401733	30" x 19"	9-1/4"	33" or 36"	Cafe Brown	
189707	401734	30" x 19"	9-1/4"	33" or 36"	White	
189938	401732	30" x 19"	9-1/4"	33" or 36"	Anthracite	

Kitchen Composite Sinks

Precis™ SILGRANIT® II Single Bowl Under-Mount Kitchen Sink

- Cutout template included with 1/8" reveal
- Under-mount clips included



Part #	Mfg#	Overall Dimensions	Bowl Depth	Cabinet Size	Color	Price
170646	440150	32" x 19"	9-1/2"	3-1/2"	White	
106623	440149	32" x 19"	9-1/2"	3-1/2"	Anthracite	
154624	440148	32" x 19"	9-1/2"	3-1/2"	Metallic Gray	
119162	440147	32" x 19"	9-1/2"	3-1/2"	Cafe Brown	
149659	440151	32" x 19"	9-1/2"	3-1/2"	Biscuit	
138250	441299	32" x 19"	9-1/2"	3-1/2"	Biscotti	
138249	441297	32" x 19"	9-1/2"	3-1/2"	Truffle	
161001	441478	32" x 19"	9-1/2"	3-1/2"	Cinder	

Precis™ SILGRANIT® II Cascade Super Single Bowl Under-Mount Kitchen Sink

- Cutout template included with 1/8" reveal
- Under-mount clips included
- Integrated second level for drying, depositing, and draining
- Stainless steel mesh colander included



Part #	Mfg#	Overall Dimensions	Bowl Depth	Cabinet Size	Color	Price
159220	519450	28-3/4" x 18"	7-7/8" & 5-1/2"	33"	Anthracite	
179361	519452	28-3/4" x 18"	7-7/8" & 5-1/2"	33"	Cinder	
172630	519454	28-3/4" x 18"	7-7/8" & 5-1/2"	33"	Biscuit	
165876	519455	28-3/4" x 18"	7-7/8" & 5-1/2"	33"	Biscotti	
166975	519456	28-3/4" x 18"	7-7/8" & 5-1/2"	33"	Truffle	
174820	519457	28-3/4" x 18"	7-7/8" & 5-1/2"	33"	Cafe Brown	

Performa® SILGRANIT® II Cascade Under-Mount Kitchen Sink

- Raised ledge for placement of colander
- Cutout template included with 1/8" reveal
- Under-mount clips included



Part #	Mfg#	Overall Dimensions	Bowl Depth	Cabinet Size	Color	Price
150898	440066	32" x 19-1/2"	10" & 7-3/4"	36"	White	
132054	440064	32" x 19-1/2"	10" & 7-3/4"	36"	Anthracite	
153838	440067	32" x 19-1/2"	10" & 7-3/4"	36"	Metallic Gray	
143331	440063	32" x 19-1/2"	10" & 7-3/4"	36"	Cafe Brown	
131215	440065	32" x 19-1/2"	10" & 7-3/4"	36"	Biscuit	
131543	441227	32" x 19-1/2"	10" & 7-3/4"	36"	Biscotti	
138248	441291	32" x 19-1/2"	10" & 7-3/4"	36"	Truffle	

Kitchen Composite Sinks

Valea™ SILGRANIT™ Super Single Bowl Under-Mount Kitchen Sink

- Template provided with approximate 1/8" reveal
- Under-mount clips included



Part #	Mfg#	Overall Dimensions	Bowl Depth	Cabinet Size	Color	Price
169815	441610	32-1/4" x 19-1/4"	9-1/2"	36"	Anthracite	
178309	441611	32-1/4" x 19-1/4"	9-1/2"	36"	Cinder	
174169	441612	32-1/4" x 19-1/4"	9-1/2"	36"	Biscotti	
181957	441613	32-1/4" x 19-1/4"	9-1/2"	36"	Cafe Brown	
185957	441772	32-1/4" x 19-1/4"	9-1/2"	36"	Truffle	
176735	441774	32-1/4" x 19-1/4"	9-1/2"	36"	Biscuit	
178319	441775	32-1/4" x 19-1/4"	9-1/2"	36"	Metallic Gray	

Diamond™ SILGRANIT® II Single Bowl Under-Mount Sink

- Cutout template included with 1/8" reveal
- Under-mount clips included



Part #	Mfg#	Overall Dimensions	Bowl Depth	Cabinet Size	Color	Price
153724	440175	24" x 20-13/16"	10"	27"	White	
101395	440174	24" x 20-13/16"	10"	27"	Anthracite	
141598	440173	24" x 20-13/16"	10"	27"	Metallic Gray	
127833	440172	24" x 20-13/16"	10"	27"	Cafe Brown	
167483	440176	24" x 20-13/16"	10"	27"	Biscuit	
131926	440220	24" x 20-13/16"	10"	27"	Biscotti	
138255	441281	24" x 20-13/16"	10"	27"	Truffle	
173453	441468	24" x 20-13/16"	10"	27"	Cinder	

Under-Mount Double Bowl Kitchen Sinks

Diamond™ SILGRANIT® II 1-3/4 Bowl Under-Mount Sink With Low Divide

- Low divide, 1-3/4 bowl
- Cutout template included with 1/8" reveal
- Under-mount clips included



Part #	Mfg#	Overall Dimensions	Bowl Depth	Cabinet Size	Color	Price
164423	441590	32" x 20-7/8"	9-1/2"	36"	Anthracite	
166082	441592	32" x 20-7/8"	9-1/2"	36"	Metallic Gray	
178180	441593	32" x 20-7/8"	9-1/2"	36"	White	
166083	441597	32" x 20-7/8"	9-1/2"	36"	Cafe Brown	
189706	441594	32" x 20-7/8"	9-1/2"	36"	Biscuit	
171118	441595	32" x 20-7/8"	9-1/2"	36"	Biscotti	

Kitchen Composite Sinks

Under-Mount Double Bowl Kitchen Sinks (Continued)

Diamond™ SILGRANIT® II 1-3/4 Bowl Under-Mount Sink With Low Divide

Part #	Mfg#	Overall Dimensions	Bowl Depth	Cabinet Size	Color	Price
170520	441596	32" x 20-7/8"	9-1/2"	36"	Truffle	
169152	441591	32" x 20-7/8"	9-1/2"	36"	Cinder	

Diamond™ SILGRANIT® II 1-3/4 Reverse Bowl Under-Mount Sink

- Low divide, 1-3/4 reverse bowl
- Cutout template included with 1/8" reveal
- Under-mount clips included



Part #	Mfg#	Overall Dimensions	Bowl Depth	Cabinet Size	Color	Price
165344	441598	32" x 20-7/8"	9-1/2"	36"	Anthracite	
166084	441601	32" x 20-7/8"	9-1/2"	36"	Metallic Gray	
178394	441603	32" x 20-7/8"	9-1/2"	36"	White	
166085	441609	32" x 20-7/8"	9-1/2"	36"	Cafe Brown	
175892	441606	32" x 20-7/8"	9-1/2"	36"	Biscuit	
168756	441607	32" x 20-7/8"	9-1/2"	36"	Biscotti	
170219	441608	32" x 20-7/8"	9-1/2"	36"	Truffle	
165860	441600	32" x 20-7/8"	9-1/2"	36"	Cinder	

Diamond™ SILGRANIT® 1-3/4 Bowl Under-Mount Kitchen Sink

- 1-3/4 Bowl sizes
- Cutout template included with 1/8" reveal
- Under-mount clips included



Part #	Mfg#	Overall Dimensions	Bowl Depth	Cabinet Size	Color	Price
108052	440180	32" x 20-27/32"	9-1/2" & 8"	36"	White	
090325	440179	32" x 20-27/32"	9-1/2" & 8"	36"	Anthracite	
109578	440178	32" x 20-27/32"	9-1/2" & 8"	36"	Metallic Gray	
113643	440177	32" x 20-27/32"	9-1/2" & 8"	36"	Cafe Brown	
129147	440181	32" x 20-27/32"	9-1/2" & 8"	36"	Biscuit	
131537	441222	32" x 20-27/32"	9-1/2" & 8"	36"	Biscotti	
138251	441284	32" x 20-27/32"	9-1/2" & 8"	36"	Truffle	
156802	441469	32" x 20-27/32"	9-1/2" & 8"	36"	Cinder	

Kitchen Composite Sinks

Diamond™ SILGRANIT® Equal Double Bowl Undermount Kitchen Sink

- Double equal bowls
- Cutout template included with 1/8" reveal
- Under-mount clips included



Part #	Mfg#	Overall Dimensions	Bowl Depth	Cabinet Size	Color	Price
105692	440185	32" x 19-1/4"	9-1/2"	36"	White	
099090	440184	32" x 19-1/4"	9-1/2"	36"	Anthracite	
098765	440183	32" x 19-1/4"	9-1/2"	36"	Metallic Gray	
116705	440182	32" x 19-1/4"	9-1/2"	36"	Cafe Brown	
100782	440186	32" x 19-1/4"	9-1/2"	36"	Biscuit	
131539	441223	32" x 19-1/4"	9-1/2"	36"	Biscotti	
138253	441286	32" x 19-1/4"	9-1/2"	36"	Truffle	
157700	441470	32" x 19-1/4"	9-1/2"	36"	Cinder	

Diamond™ SILGRANIT® Equal Double Bowl Undermount Kitchen Sink with Low-Divide

Part #	Mfg#	Overall Dimensions	Bowl Depth	Cabinet Size	Color	Price
187796	442074	32" x 19-1/4"	9-1/2"	36"	White	
186738	442075	32" x 19-1/4"	9-1/2"	36"	Anthracite	
188356	442077	32" x 19-1/4"	9-1/2"	36"	Metallic Gray	
189931	442071	32" x 19-1/4"	9-1/2"	36"	Cinder	
226222	442072	32" x 19-1/4"	9-1/2"	36"	Truffle	

Precis™ SILGRANIT® II 1-3/4 Double Bowl Under-Mount Kitchen Sink

- 1-3/4 Double bowl
- Cutout template included with 1/8" reveal
- Under-mount clips included



Part #	Mfg#	Overall Dimensions	Bowl Depth	Cabinet Size	Color	Price
145906	441125	33" x 18"	9-1/2"	36"	White	
130876	441128	33" x 18"	9-1/2"	36"	Anthracite	
148687	441130	33" x 18"	9-1/2"	36"	Metallic Gray	
136169	441129	33" x 18"	9-1/2"	36"	Cafe Brown	
136680	441127	33" x 18"	9-1/2"	36"	Biscuit	
150321	441298	33" x 18"	9-1/2"	36"	Biscotti	
146771	441296	33" x 18"	9-1/2"	36"	Truffle	
165935	441479	33" x 18"	9-1/2"	36"	Cinder	

Sinks

Kitchen Composite Sinks

Precis™ SILGRANIT® II Equal Double Bowl Under-Mount Kitchen Sink

- Equal double bowl
- Cutout template included with 1/8" reveal
- Under-mount clips included



Sinks

Part #	Mfg#	Overall Dimensions	Bowl Depth	Cabinet Size	Color	Price
144370	516320	29-3/4" x 18-1/8"	8"	33"	White	
127059	516322	29-3/4" x 18-1/8"	8"	33"	Anthracite	
133886	516319	29-3/4" x 18-1/8"	8"	33"	Metallic Gray	
133906	516323	29-3/4" x 18-1/8"	8"	33"	Cafe Brown	
130920	516321	29-3/4" x 18-1/8"	8"	33"	Biscuit	
140421	517107	29-3/4" x 18-1/8"	8"	33"	Biscotti	
150673	517678	29-3/4" x 18-1/8"	8"	33"	Truffle	
162502	519050	29-3/4" x 18-1/8"	8"	33"	Cinder	

Precis™ SILGRANIT® II 1-3/4 Multi-Level Under-Mount Kitchen Sink

- Drainer board slopes 1/4" right to left
- Cutout template included with 1/8" reveal
- Under-mount clips included



Part #	Mfg#	Overall Dimensions	Bowl Depth	Cabinet Size	Color	Price
158463	440408	48" x 20"	9-1/2"	54"	Anthracite	
132915	440399	48" x 20"	9-1/2"	54"	Cafe Brown	
156602	440411	48" x 20"	9-1/2"	54"	Metallic Gray	
159450	441471	48" x 20"	9-1/2"	54"	Cinder	

Performa™ SILGRANIT® II 1-3/4 Double Bowl Under-Mount Kitchen Sink

- 1-3/4 Double bowl
- Cutout template included with 1/8" reveal
- Under-mount clips included



Part #	Mfg#	Overall Dimensions	Bowl Depth	Cabinet Size	Color	Price
168279	441310	33" x 19"	10"	36"	White	
138243	441312	33" x 19"	10"	36"	Anthracite	
150264	441309	33" x 19"	10"	36"	Metallic Gray	
138246	441313	33" x 19"	10"	36"	Cafe Brown	
138245	441311	33" x 19"	10"	36"	Biscuit	
138242	441314	33" x 19"	10"	36"	Biscotti	
138241	441315	33" x 19"	10"	36"	Truffle	

Kitchen Composite Sinks

Under-Mount Double Bowl Kitchen Sinks (Continued)

Performa™ SILGRANIT® II 1-3/4 Double Bowl Under-Mount Kitchen Sink

Part #	Mfg#	Overall Dimensions	Bowl Depth	Cabinet Size	Color	Price
165756	441474	33" x 19"	10"	36"	Cinder	

Performa™ SILGRANIT II® Equal Double Bowl Under-Mount Kitchen Sink

- Equal double bowl
- Cutout template included with 1/8" reveal
- Under-mount clips included



Part #	Mfg#	Overall Dimensions	Bowl Depth	Cabinet Size	Color	Price
161529	440071	33" x 20"	10"	36"	White	
149673	440069	33" x 20"	10"	36"	Anthracite	
149314	440072	33" x 20"	10"	36"	Metallic Gray	
119794	440068	33" x 20"	10"	36"	Cafe Brown	
147178	440070	33" x 20"	10"	36"	Biscuit	
131542	441226	33" x 20"	10"	36"	Biscotti	
155140	441290	33" x 20"	10"	36"	Truffle	
164088	441473	33" x 20"	10"	36"	Cinder	

Sinks

Kitchen Sink Accessories

Faucet Hole Covers
Faucet Solid Hole Cover

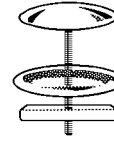

- 2" Diameter
- Solid top for covering unused hole in sink

Part #	Mfg #	Finish	Price
059911	103/15S	Satin Nickel	

Sinks

Kitchen Sink Accessories

Faucet Hole Covers

OD Faucet Hole Cover with Washer

- Stainless steel



Part #	Mfg #	Description	Price
169919	B10-201	1-3/4" OD with Washer	
169918	B10-202	2" OD with Washer	

Celcon Faucet Hole Cover

- Molded celcon-plastic will not chip or peel
- 1-3/4" Diameter top



Part #	Mfg #	Description	Price
173400	C06-011	1-3/4", Chrome	
159731	C06-014	1-3/4", Brushed Nickel	
153861	C06-016	1-3/4", Oil-Rubbed Bronze	

Decorative Faucet Hole Cover - Fit-All Screw Down

- Screw down type
- Fits all



Part #	Mfg #	Size	Color	Price
068710	C06-001	1-3/4"	Polar White	

Cock Hole Cover

- 1-3/4" Diameter top



Part #	Mfg #	Finish	Material	Price
139242	B10-20PS	Pol Stainless	Brass	

Rosette Escutcheons

Rosette



- Zinc-plated

Part #	Mfg #	Description	Price
133899	B10-110	Shallow Pattern	
133900	B10-111	Deep Pattern	

Kitchen and Bath Accessories

Brass Bar Plug

- Cast Brass
- Includes Ground Seat Plug
- 1"x 3"



Part #	Mfg #	Description	Price
157416	B02060	1" Brass Bar Plug	

Brass Lift Rod

- Brass
- Replacement Lift rod
- Chrome plated



Part #	Mfg #	Description	Price
170361	P35908	Brass Lift Rod CP	

Sink Accessories

Sink Hole Covers



Part #	Mfg #	Finish	Price
096290	BTAPS50/BRN	Brushed Nickel	
101081	BTAPS50/BRS	Brushed Stainless	
101082	BTAPS50/PW	Polar White	

Sinks

*PVD Finish

www.plumbsupply.com • Serving our Customers Since 1946 • www.waterconcepts.net

Sink Accessories

Sink Grids

Sink Grid for BlancoCerana™ Single Bowl Sink

- Durable stainless steel
- Protective feet and bumpers

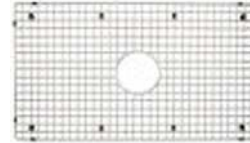

Part #	Mfg #	Description	Overall Size	Price
175402	229562	BlancoCerana Single Bowl	16" x 29-3/4"	

Sink Grid for BlancoDiamond™ Sink

- Durable stainless steel
- Protective feet and side bumpers

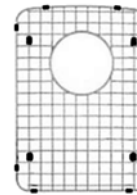

Part #	Mfg #	Description	Overall Size	Price
108055	220-999	BlancoDiamond™ 1-3/4 Small Bowl	10-7/8" x 15-3/8"	
166290	231342	BlancoDiamond™ 1-3/4 Small Bowl	10-7/8" x 15-3/8"	
110666	220998	BlancoDiamond™ 1-3/4 Large Bowl	14-1/2" x 16-13/16"	
137369	221009	BlancoDiamond™ Double Equal Right Bowl	15-1/4" x 12-3/4"	
137368	221008	BlancoDiamond™ Double Equal Left Bowl	15-1/4" x 12-3/4"	

Sink Grid for BlancoDiamond™ 1-3/4 Bowl Reverse Low Divide

- Durable stainless steel
- Protective feet and side bumpers

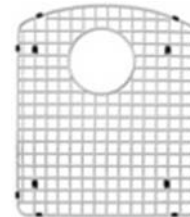

Part #	Mfg #	Description	Overall Size	Price
165345	231343	BlancoDiamond™ 1-3/4 Reverse Large Bowl	14-1/2" x 16-13/16"	

Sink Grid for BlancoDiamond™ Super Single Bowl

- Durable stainless steel
- Protective feet and side bumpers

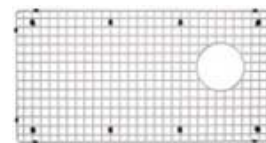

Part #	Mfg #	Description	Overall Size	Price
155590	221010	BlancoDiamond™ Super Single Bowl	28" x 14-1/4"	

Sinks

Sink Accessories

Sink Grid for BlancoPerforma™ Single Bowl Sink

- *Stainless steel*
- *Protective bumpers and feet*



Part #	Mfg #	Description	Overall Size	Price
124192	220586	BlancoPerforma™ 440104	28-3/8" x 15-1/8"	

Sink Grid for BlancoWave™ Plus

- *Durable stainless steel*
- *Protective bumpers and feet*

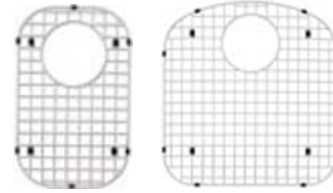

Part #	Mfg #	Description	Overall Size	Price
159253	220995	BlancoWave™ Plus Small Bowl	9" x 14-1/2"	
159254	220994	BlancoWave™ Plus Large Bowl	16-5/8" x 15-7/8"	

Sink Grid for BlancoPerforma™ Equal Double Bowl

- *Durable stainless steel*
- *Protective bumpers and feet*

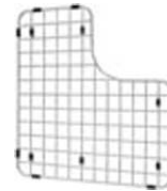

Part #	Mfg #	Description	Overall Size	Price
161034	220577	BlancoPerfoma™ Left Bowl	13-3/8" x 15-5/8"	

Sink Grid for BlancoPerforma™ 1-3/4 Bowl

- *Durable stainless steel*
- *Protective bumpers and feet*

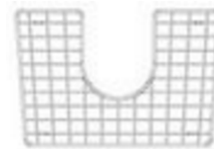

Part #	Mfg #	Description	Overall Size	Price
141355	226830	BlancoPerforma™ Right Bowl	12-15/16" x 12-3/4"	
141354	226828	BlancoPerforma™ Left Bowl	17-1/4" x 15-7/8"	

Sinks

Sink Accessories

Sinks

Sink Grid for BlancoPrecision™ and Precision16™ 1- 3/4 Bowl

- Durable stainless steel
- Protective bumpers and feet

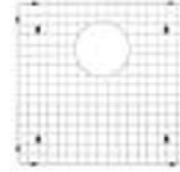

Part #	Mfg #	Description	Overall Size	Price
161021	516363	BlancoPrecis™ Equal Double Bowl	13-3/4" x 11-3/4"	
130878	516366	BlancoPrecis™ 1-3/4 Right Bowl	14-1/2" x 10-3/4"	
165515	223190	BlancoPrecision™ 1-3/4 Left Bowl	16-7/16" x 15-7/16"	
165516	223189	BlancoPrecision™ 1-3/4 Right Bowl	12-7/16" x 15-7/16"	
136269	516271	BlancoPrecision™ 16	19-1/2" x 15-1/2"	
130877	516364	BlancoPrecision™ 16 Left Bowl	14-1/2" x 14-3/4"	

Sink Grid for BlancoStellar™ 1-3/4 Bowl Sink

- Durable stainless steel
- Protective bumpers and feet

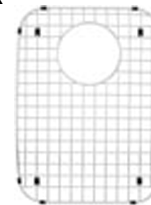

Part #	Mfg #	Description	Overall Size	Price
157857	515300	BlancoStellar™ 1-3/4 Large Bowl	17-1/8" x 13-5/8"	
157859	515297	BlancoStellar™ 1-3/4 Small Bowl	13-1/2" x 15-1/2"	
137739	515298	BlancoStellar™ 1.6 Large Bowl	17" x 16-1/2"	
138424	515301	BlancoStellar™ Super Single Bowl	24-3/4" x 14-1/2"	

Sink Grid for BlancoValea™ Super Single Bowl

- Durable stainless steel
- protective bumpers and feet



Part #	Mfg #	Description	Overall Size	Price
181663	230966	BlancoValea™ Super Single Bowl	27-3/8" x 15"	

Sink Accessories

Cutting Boards

Cutting Board for BlancoPerforma™ Silgranit II™ Equal Double Bowl Sinks

- Walnut wood



Part #	Mfg #	Description	Overall Size	Price
161555	222587	BlancoPerforma™ Silgrant II	18-13/16" x 12-13/16"	

Cutting Board for BlancoDiamond™ Double Bowl

- Red alder wood
- Durable rubber feet for countertop use



Part #	Mfg #	Description	Overall Size	Price
155241	440229	BlancoDiamond™ Equal Double Bowl	18-1/4" x 12-5/8"	
138793	440227	BlancoDiamond™ 1-1/2 Double Bowl	19-3/4" x 12"	

Cutting Board for BlancoVale™ Super Single Bowl



Part #	Mfg #	Description	Overall Size	Price
181664	230972	BlancoValea™ Super Single Bowl	20-3/4" x 11-3/4"	

Colanders

Stainless Steel Colander

- 304 Series, 18 gauge stainless steel
- 18/10 Chrome/nickel content
- Colander slides gently along countertop, supported by protective cushions
- For undermount installations.



Part #	Mfg #	Description	Overall Size	Price
160687	513730	Zero reveal thru a 1/8" positive reveal	19-1/4" x 10-3/8" x 3-1/8"	
146773	513520		17-1/4"L x 7-3/4"W x 5"D	

Sink Accessories

Stainless Steel Colander (2)

- 304 Series, 18 gauge stainless steel
- 18/10 Chrome/nickel content
- Colander slides gently along countertop
- For undermount installations



Part #	Mfg #	Description	Overall Size	Price
161880	514015	Zero reveal thru a 1/8" positive reveal	17" x 10" x 3"	

Misc Accessories

Deluxe Air Gap

- Solid brass construction
- Comes complete with tailpiece and mounting hardware
- 1-1/2" Maximum deck thickness



Part #	Mfg #	Description	Overall Size	Price
151539	440035	Satin Nickel	2-1/4" x 2-1/8"	

Solon Compost System

- Stainless steel
- Collects organic waste below the counter
- Lid designed to keep odors out of the kitchen
- 1.8 Gallon capacity



Part #	Mfg #	Description	Overall Size	Price
167210	512472	Flush Mount Compost Management System	8-3/8" x 8"	

Cleaners



406214

406203

Part #	Mfg #	Description	Price
063266	406214	15 oz BlancoClean Stainless Steel Sink Cleaner	
118288	406203	15 oz BlancoClean SILGRANIT® II Sink Polish	

Sinks

Kitchen Stainless Steel Sinks

Stainless Steel Top-Mount Kitchen Sinks

Cadence™ Drop-In Double Bowl Kitchen Sink—33" x 22"

- 20 Gauge stainless steel
- SilentShield™ sound absorption technology



Part #	Mfg #	Overall Dimensions	Basin Depth	Holes	Bowls	Price
106227	K-3145-4-NA	33" x 22"	8"	4	Double Equal	

Octave® Drop-In Double Bowl Kitchen Sink—33" x 22"

- 18 Gauge stainless steel
- SilentShield™ sound absorption technology
- 36" Minimum base cabinet width
- Included bottom basin rack for left bowl, sponge caddy, and stainless-steel cleaner K-3844



Part #	Mfg #	Overall Dimensions	Basin Depth	Holes	Color	Price
154306	K-3844-1-NA	33" x 22"	9"LH, 7-1/2"RH	1	Large/Medium	
168858	K-3844-3-NA	33" x 22"	9"LH, 7-1/2"RH	3	Large/Medium	
162665	K-3844-4-NA	33" x 22"	9"LH, 7-1/2"RH	4	Large/Medium	
158581	K-3842-1-NA	33" x 22"	9"	1	Double Equal	
164525	K-3842-3-NA	33" x 22"	9"	3	Double Equal	
168566	K-3842-4-NA	33" x 22"	9"	4	Double Equal	

Staccato™ Drop-In Double Bowl Kitchen Sink—33" x 22"

- 18 Gauge stainless steel
- SilentShield™ sound absorption
- Installation hardware included
- Faucet sold separately



Part #	Mfg #	Overall Dimensions	Basin Depth	Holes	Bowls	Price
065248	K-3361-1-NA	33" x 22"	8"	1	Large/Medium	
064260	K-3361-3-NA	33" x 22"	8"	3	Large/Medium	
060281	K-3361-4-NA	33" x 22"	8"	4	Large/Medium	
073003	K-3369-1-NA	33" x 22"	8"	1	Double Equal	
061104	K-3369-3-NA	33" x 22"	8"	3	Double Equal	
061833	K-3369-4-NA	33" x 22"	8"	4	Double Equal	

Staccato™ Drop-In Single Bowl Kitchen Sink—25" x 22"

- 18-gauge stainless steel
- SilentShield® sound-absorption
- 27-inch minimum base cabinet width



Part #	Mfg #	Overall Dimensions	Basin Depth	Holes	Color	Price
073558	K-3362-3-NA	25" x 22"	8"	3	Single	
069339	K-3362-4-NA	25" x 22"	8"	4	Single	

Kitchen Stainless Steel Sinks

Toccata™ Drop-In Double Equal Bowl Kitchen Sink—33" x 22"

- 18 Gauge stainless steel
- SilentShield™ sound absorption
- 36" Minimum cabinet base width



Part #	Mfg #	Overall Dimensions	Basin Depth	Holes	Color	Price
071972	K-3346-4-NA	33" x 22"	8"	4	Double Equal	
167656	K-3847-3-NA	33" x 22"	9-1/4"	3	Double Equal	
157135	K-3847-4-NA	33" x 22"	9-1/4"	4	Double Equal	
160916	K-4015-4-NA	33" x 22"	6"	4	Double Equal	

Toccata™ Drop-In High/Low Double Bowl Kitchen Sink with Disposal Bowl—33" x 22"

- 19-gauge stainless steel
- SilentShield® sound-absorption
- 36-inch minimum base cabinet width
- 4-1/8-inch left depth and 7-inch right depth
- Includes installation hardware



Part #	Mfg #	Overall Dimensions	Basin Depth	Holes	Color	Price
070780	K-3347L-4-NA	33" x 22"	4-1/8" or 7"	4	High/Low	

Toccata™ Drop-In Single Bowl Kitchen Sink

- 19 Gauge stainless steel
- SilentShield™ sound absorption
- 27" Minimum cabinet base width



Part #	Mfg #	Overall Dimensions	Basin Depth	Holes	Color	Price
183567	K-4011-4-NA	25" x 22"	6"	4	Single	

Toccata™ Drop-In Single Bowl Kitchen Sink

- 7" Depth
- 18 Gauge stainless steel
- SilentShield™ sound absorption
- 27" Minimum cabinet base width



Part #	Mfg #	Overall Dimensions	Basin Depth	Holes	Color	Price
059536	K-3348-3-NA	25" x 22"	7"	3	Single	
058455	K-3348-4-NA	25" x 22"	7"	4	Single	

Sinks

Kitchen Stainless Steel Sinks

Vault™ Drop-In Apron Front Kitchen Sink

- 18 Gauge stainless steel
- SilentShield™ sound absorption
- Single bowl
- Installation hardware included



K-3935



K-3942



K-3944

Part #	Mfg #	Overall Dimensions	Basin Depth	Holes	Color	Price
163971	K-3935-1-NA	29-3/4" x 24-5/16"	9-5/16"	1	Single	
158080	K-3935-3-NA	29-3/4" x 24-5/16"	9-5/16"	3	Single	
170751	K-3935-4-NA	29-3/4" x 24-5/16"	9-5/16"	4	Single	
149052	K-3942-1-NA	35-3/4" x 24-5/16"	9-5/16"	1	Single	
149224	K-3942-3-NA	35-3/4" x 24-5/16"	9-5/16"	3	Single	
166149	K-3972-4-NA	35-3/4" x 24-5/16"	9-5/16"	4	Single	
160966	K-3944-1-NA	35-3/4" x 24-5/16"	9-5/16"	1	Double Equal	
175275	K-3944-3-NA	35-3/4" x 24-5/16"	9-5/16"	3	Double Equal	
172610	K-3944-4-NA	35-3/4" x 24-5/16"	9-5/16"	4	Double Equal	

Stainless Steel Dual-Mount Kitchen Sinks

Vault™ Dual-Mount Single Bowl Kitchen Sink

- 18 Gauge stainless steel
- Low profile: 1.25mm rim provides undercounter or flush mount
- SilentShield® sound-absorption technology
- Drains and sink racks not included



Part #	Mfg #	Overall Dimensions	Basin Depth	Holes	Color	Price
131051	K-3821-1-NA	33" x 22"	9"	1	Single	
134617	K-3821-3-NA	33" x 22"	9"	3	Single	
137068	K-3821-4-NA	33" x 22"	9"	4	Single	
183564	K-3894-4-NA	25" x 22"	6"	4	Single	

Vault™ Dual-Mount Double Bowl Kitchen Sink—33" x 22"

- 18 Gauge stainless steel
- Low-profile 1.25mm rim provides undercounter or flush mount
- Lowered saddle prevents water from overflowing
- Faucet sold separately

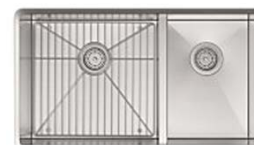

K-3823



K-3820

Part #	Mfg #	Overall Dimensions	Basin Depth	Holes	Color	Price
133964	K-3820-1-NA	33" x 22"	9"	1	Double Equal	
136935	K-3820-3-NA	33" x 22"	9"	3	Double Equal	
131035	K-3820-4-NA	33" x 22"	9"	4	Double Equal	
159070	K-3996-4-NA	33" x 22"	6"	4	Double Equal	
136196	K-3823-1-NA	33" x 22"	9"	1	Large/Medium	
141910	K-3823-3-NA	33" x 22"	9"	3	Large/Medium	

Kitchen Stainless Steel Sinks

Stainless Steel Dual-Mount Kitchen Sinks (Continued)

Vault™ Dual-Mount Double Bowl Kitchen Sink—33" x 22"

Part #	Mfg #	Overall Dimensions	Basin Depth	Holes	Color	Price
135808	K-3823-4-NA	33" x 22"	9"	4	Large/Medium	

Vault™ Dual-Mount Double Bowl Kitchen Sink with SmartDivide® — 33" x 22"

- 18 Gauge stainless steel
- 9-inch depth
- Smart Divide® lowered divider
- SilentShield® sound-absorption
- 36-inch minimum base cabinet width
- Installation hardware and left side bottom bowl rack included



Part #	Mfg #	Overall Dimensions	Basin Depth	Holes	Color	Price
145795	K-3838-1-NA	33" x 22"	9"	1	Double Equal	
149391	K-3838-4-NA	33" x 22"	9"	4	Double Equal	
141028	K-3839-1-NA	33" x 22"	9"	1	Double Offset	
156031	K-3839-3-NA	33" x 22"	9"	3	Double Offset	
150438	K-3839-4-NA	33" x 22"	9"	4	Double Offset	

Verse™ Double-Bowl Drop-In Kitchen Sink — 33" x 22"

- 18 Gauge stainless steel
- 9-inch depth
- SilentShield® sound-absorption
- Includes installation hardware
- 36-inch minimum base cabinet width



Part #	Mfg #	Overall Dimensions	Basin Depth	Holes	Color	Price
171394	K-5267-1-NA	33" x 22"	9"	1	Double Equal	
225967	K-5267-3-NA	33" x 22"	9"	3	Double Equal	
220795	K-5267-4-NA	33" x 22"	9"	4	Double Equal	
229053	K-75791-1-NA	33" x 22"	9"	1	Large/Medium	

Verse™ Single-Bowl Drop-In Kitchen Sink — 33" x 22"

- 18 Gauge stainless steel
- SilentShield® sound-absorption technology
- 36" Minimum base cabinet width
- Includes installation hardware



Part #	Mfg #	Overall Dimensions	Basin Depth	Holes	Color	Price
227467	K-20060-1-NA	33" x 22"	9"	1	Single	
228892	K-20060-3-NA	33" x 22"	9"	3	Single	

Sinks

Kitchen Stainless Steel Sinks

Stainless Steel Under-Mount Kitchen Sinks

8 Degree™ Offset Under-Mount Double Bowl Kitchen Sink

- 16 Gauge stainless steel
- Includes wine glass rack, bottom basin rack for each basin and installation hardware
- Racks not included



Part #	Mfg #	Overall Dimensions	Basin Depth	Holes	Bowls	Price
114845	K-3672-NA	31" x 16-1/2"	9-3/4"	Less Holes	Double Equal	

Staccato™ Under-Mount Double Bowl Kitchen Sink

- 31-5/8" x 19-9/16"
- 18 Gauge stainless steel
- SilentShield® sound absorption technology
- Installation hardware included



Part #	Mfg #	Overall Dimensions	Basin Depth	Holes	Bowls	Price
130386	K-3899-NA	31-5/8" x 19-9/16"	8"	Less Holes	Double Equal	

Octave® Under-Mount Double Bowl Kitchen Sink

- 33" x 20-1/4"
- 18 Gauge stainless steel
- SilentShield® sound absorption technology
- Includes 2 bottom basin racks, sponge caddy, and stainless-steel cleaner



Part #	Mfg #	Overall Dimensions	Basin Depth	Holes	Color	Price
151137	K-3843-NA	32" x 20-1/4"	9"	Less Holes	Double Equal	
159055	K-3845-NA	32" x 20-1/4"	9"	Less Holes	Large/Medium	

Poise® Under-Mount Single Bowl Kitchen Sink

- Part of K-3158-NA
- 33"L x 18"W
- Basin depth: 9"
- 16-gauge stainless steel
- SilentShield™ sound-absorption
- Please order the K-3158-NA sink which includes the following: sink and sink rack



Part #	Mfg #	Overall Dimensions	Basin Depth	Holes	Color	Price
085216	K-3387-NA	33" x 18"	9"	Less Holes	Single	

Prolific™ Under-Mount Single Bowl Kitchen Sink — 33" x 17-3/4"

- 18 Gauge stainless steel
- SilentShield® sound absorption technology
- (3) Graduated ledges in basin allow you to place accessories at your preferred height
- Includes: bamboo cutting board, (2) multipurpose grated racks, colander, and wash bin and installation hardware



Part #	Mfg #	Overall Dimensions	Basin Depth	Holes	Color	Price
172615	K-5540-NA	33" x 17-3/4"	10"	Less Holes	Single	

Kitchen Stainless Steel Sinks

Staccato™ Extra-Large/Medium Double Bowl Kitchen Sink — 31-5/8" x 19-9/16"

- 18 Gauge stainless steel
- SilentShield® sound absorption
- 36" Minimum base cabinet width
- Includes installation hardware



Part #	Mfg #	Overall Dimensions	Basin Depth	Holes	Bowls	Price
130385	K-3891-NA	31-5/8" x 19-9/16"	8"	Less Holes	Large/Medium	

Stages™ Under-Mount Single Bowl Kitchen Sink — 45" x 18-1/2"

- 16 Gauge stainless steel
- SilentShield® sound-absorption pads
- Single bowl with side platform
- 48" Minimum base cabinet width
- Includes:
 - Versatile flip trap
 - (6) Microwave and dishwasher-safe bowls
 - American walnut hardwood cutting board
 - Stainless steel accessory storage rack
 - Bottom bowl rack



Part #	Mfg #	Overall Dimensions	Basin Depth	Holes	Color	Price
130735	K-3761-NA	45" x 18-1/2"	9-1/2"	Less Holes	Single	

Strive™ Under-Mount Double Bowl Kitchen Sink

- 16 Gauge stainless steel
- SilentShield® sound absorption technology
- Includes divider dishcloth bar, divider utility shelf, and bottom basin rack
- 36" Minimum base cabinet width



Part #	Mfg #	Overall Dimensions	Basin Depth	Holes	Color	Price
159664	K-5281-NA	32" x 18-1/4"	9"	Less Holes	Double Equal	
169242	K-5282-NA	35-1/2" x 20-1/4"	9"	Less Holes	Extra-Large/Medium	

Strive™ Under-Mount Double Bowl Kitchen Sink with Smart Divide®

- 16 Gauge stainless steel
- SilentShield® sound absorption technology
- Includes sink bridge utility shelf with dishcloth bar and bottom basin rack
- 36" Minimum bas cabinet width



Part #	Mfg #	Overall Dimensions	Basin Depth	Holes	Color	Price
176419	K-5284-NA	32" x 18-5/16"	9"	Less Holes	Double Equal	

Sinks

Kitchen Stainless Steel Sinks

Strive™ Under-Mount Single Bowl Kitchen Sink

- 16 Gauge stainless steel
- SilentShield® sound absorption technology
- Includes sink bridge utility shelf with dishcloth bar and bottom basin rack
- 36" Minimum base cabinet width



Part #	Mfg #	Overall Dimensions	Basin Depth	Holes	Color	Price
167294	K-5283-NA	35" x 18-5/16"	9"	Less Holes	Extra-Large Single	
160598	K-5285-NA	32" x 18-1/4"	9"	Less Holes	Single	
167652	K-5409-NA	29" x 18-5/16"	9"	Less Holes	Single	

Strive™ Under-Mount Single Bowl Apron Front Sink — 35-1/2" x 21-1/4"

- 16 Gauge stainless steel
- SilentShield® sound absorption technology
- Includes bottom basin rack and installation hardware
- 36" Minimum base cabinet width
- 29-1/2" x 21-1/4" (**5417-NA Only**)



Part #	Mfg #	Overall Dimensions	Basin Depth	Holes	Color	Price
173738	K-5415-NA	35-1/2" x 21-1/4"	9"	Less Holes	Single	
177654	K-5416-NA	35-1/2" x 21-1/4"	9"	Less Holes	Double	
179825	K-5417-NA	29-1/2" x 21-1/4"	9"	Less Holes	Single	

Undertone® Rouded Under-Mount Single Bowl Kitchen Sink

- 7-1/2-inch depth
- 18-gauge stainless steel
- SilentShield® sound-absorption technology
- Includes installation hardware
- 21-inch minimum base cabinet width



Part #	Mfg #	Overall Dimensions	Basin Depth	Holes	Color	Price
056356	K-3336-NA	15-1/2" x 17-1/8"	7-1/2"	Less holes	Single	

Undertone® Extra-Large Rouded Under-Mount Single Bowl Kitchen Sink

- 9-1/2-inch depth
- 18-gauge stainless steel
- SilentShield® sound-absorption technology
- Includes installation hardware
- 24-inch minimum base cabinet width



Part #	Mfg #	Overall Dimensions	Basin Depth	Holes	Color	Price
057386	K-3335-NA	19-5/8" x 19-5/8"	9-1/2"	Less Holes	Single	

Kitchen Stainless Steel Sinks

Sinks

Undertone® Medium Squared Under-Mount Single Bowl Kitchen Sink

- 18-gauge stainless steel
- Rear drain
- 9-1/2-inch depth
- 21-inch minimum base cabinet width
- SilentShield® sound-absorption technology
- Includes installation hardware



Part #	Mfg #	Overall Dimensions	Basin Depth	Holes	Color	Price
075316	K-3325-NA	23" x 17-1/2"	9-1/2"	Less Holes	Single	
064083	K-3330-NA	15-3/4" x 17-1/2"	9-1/2"	Less Holes	Single	

Undertone® Small Squared Under-Mount Single Bowl Kitchen Sink

- 18-gauge stainless steel
- 5-1/2-inch depth
- SilentShield® sound-absorption technology
- 15-inch minimum base cabinet width
- Includes installation hardware



Part #	Mfg #	Overall Dimensions	Basin Depth	Holes	Color	Price
076121	K-3333-NA	10-3/4" x 17-1/2"	5-1/2"	Less Holes	Single	

Undertone® Under-Mount Square Single Bowl Kitchen Sink — 15-3/4" x 20-3/8"

- 9-1/2-inch depth
- 18-gauge stainless steel
- SilentShield® sound-absorption
- Includes installation hardware
- 21-inch minimum base cabinet width



Part #	Mfg #	Overall Dimensions	Basin Depth	Holes	Color	Price
092075	K-3163-NA	15-3/4" x 20-3/8"	9-1/2"	Less Holes	Single	

Undertone® Under-Mount Single Circular Bowl Kitchen Sink

- 5-1/4-inch depth
- 18-gauge stainless steel
- 18-inch minimum base cabinet width
- Includes installation hardware
- SilentShield® sound-absorption technology



Part #	Mfg #	Overall Dimensions	Basin Depth	Holes	Color	Price
066937	K-3339-NA	13-5/8" Diameter	5-1/4"	Less Holes	Single	

Kitchen Stainless Steel Sinks

Undertone™ Under-Mount Double Bowl Kitchen Sink with Rear Drain

- 18 Gauge stainless steel
- SilentShield® Plus sound absorption
- Installation hardware included
- Faucet sold separately



Part #	Mfg #	Overall Dimensions	Basin Depth	Holes	Bowls	Price
086135	K-3177-NA	29-1/4" x 18-5/8"	L 9-1/2", R 7-1/2"	Less Holes	Large/Medium/Square	
099975	K-3177-L-NA	29-1/4" x 18-5/8"	L 7-1/2", R 9-1/2"	Less Holes	Medium/Large/Square	
053331	K-3350-NA	29-1/4" x 15-3/4"	7-1/2"	Less Holes	Equal/Square	
053332	K-3351-NA	31-1/2" x 18"	L 9/12", R 7-1/2"	Less Holes	Equal/Square	
093255	K-3171-NA	31-1/2" x 18"	9-1/2"	Less Holes	Equal	
091716	K-3150-NA	31" x 20-1/8"	9-1/2"	Less Holes	Large/Medium/Round	

Undertone® Preserve™ Under-Mount Double Bowl Kitchen Sink with Rear Drain

- 18 Gauge stainless steel sink
- SilentShield® sound absorption technology
- Premium stainless steel resists scratching
- Includes bottom basin rack and installation hardware
- 36" Minimum base cabinet width
- 31-1/2" x 18" (**3171-HCF-NA**) or 35-1/8" x 20-1/8" (**3356-HCF-NA**)



Part #	Mfg #	Overall Dimensions	Basin Depth	Holes	Color	Price
172790	K-3171-HCF-NA	31-1/2" x 18"	9-3/4"	Less Holes	Equal	
053471	K-3356-NA	35-1/8" x 20-1/8"	9-3/4"	Less Holes	Large/Medium	
173459	K-3356-HCF-NA	35-1/8" x 20-1/8"	9-3/4"	Less Holes	Large/Medium	

Undertone® Preserve™ Under-Mount Double Bowl Kitchen Sink with Center Drain — 34-3/4" x 18-1/2"

- 18 Gauge stainless steel sink
- SilentShield® sound absorption technology
- Premium stainless steel resists scratching
- 39" Minimum base cabinet width



Part #	Mfg #	Overall Dimensions	Basin Depth	Holes	Color	Price
093333	K-3099-NA	34-3/4" x 18-1/2"	L9-1/2", R5-1/2"	Less Holes	Large/Small	

Undertone® Preserve™ Under-Mount Single Bowl Kitchen Sink — 31-1/4" x 17-7/8"

- 18 Gauge stainless steel sink
- SilentShield® sound absorption technology
- Innovative Preserve™
- Includes bottom basin rack and installation hardware
- 36" Minimum base cabinet width



Part #	Mfg #	Overall Dimensions	Basin Depth	Holes	Color	Price
189374	K-5290-HCF-NA	31-1/4" x 17-7/8"	9-5/16"	Less Holes	Large	

Kitchen Stainless Steel Sinks

Sinks

Undertone® Under-Mount Double Bowl Kitchen Sink — 31-3/4" x 18"

- 18-gauge stainless steel
- Large/small bowls with high/low design
- 5-1/2-inch left depth and 9-1/2-inch right depth
- SilentShield® sound-absorption
- Includes installation hardware
- 36" minimum base cabinet width



Part #	Mfg #	Overall Dimensions	Basin Depth	Holes	Color	Price
086961	K-3174-L-NA	31-3/4" x 18"	L5-1/2", R9-1/2"	Less Holes	High/Low	

Undertone® Under Mount Single Bowl Kitchen Sink — 31-1/4" x 17-7/8"

- 18 Gauge stainless steel
- SilentShield® sound absorption technology
- Includes installation hardware
- 36" Minimum base cabinet width



Part #	Mfg #	Overall Dimensions	Basin Depth	Holes	Color	Price
189037	K-5290-NA	31-1/4" x 17-7/8"	9-5/16"	Less Holes	Large	

Undertone® Under-Mount Single Bowl Kitchen Sink

- 18-gauge stainless steel
- 7-5/8-inch depth
- SilentShield® sound-absorption
- 21-inch minimum base cabinet width
- Includes installation hardware



Part #	Mfg #	Overall Dimensions	Basin Depth	Holes	Color	Price
080942	K-3184-NA	18-1/2" x 15-3/4"	7-5/8"	Less Holes	Single	

Undertone® Under-Mount Triple Bowl Kitchen Sink — 41-5/8" x 20-1/8"

- 18-gauge stainless steel
- Double equal bowls with center disposal bowl
- 9-1/2-inch left depth, 5-1/2-inch center depth, and 7-1/2-inch right depth
- SilentShield® sound-absorption
- Includes installation hardware
- 45-inch minimum base cabinet width



Part #	Mfg #	Overall Dimensions	Basin Depth	Holes	Color	Price
091942	K-3166-NA	41-5/8" x 20-1/8"	L9-1/2", C5-1/2", R7-1/2"	Less Holes	Triple	

Kitchen Stainless Steel Sinks

Vault™ Under-Mount Apron Front Sink with Rear Drain — 35-1/2" x 21-1/4"

- 18 Gauge stainless steel
- SilentShield® sound absorption technology
- Shortened apron allows sink to be used in most standard cabinetry or retrofitted to existing standard cabinetry
- Self-trimming apron overlaps the cabinet face for easy installation
- Includes installation hardware and bottom basin rack
- 29-1/2" x 21-1/4" (**K-3943-NA Only**)



K-3936



K-3945

Sinks

Part #	Mfg #	Overall Dimensions	Basin Depth	Holes	Color	Price
154322	K-3936-NA	29-1/2" x 21-1/4"	9"	Less Holes	Single	
142710	K-3943-NA	35-1/2" x 21-1/4"	9"	Less Holes	Single	
143391	K-3945-NA	35-1/2" x 21-1/4"	9"	Less Holes	Large/Medium	

Stainless Steel Kitchen Sink Accessories



Cadence®/Toccata™ Sink Rack for K-3145 and K-3847 Kitchen Sinks

Part #	Mfg #	Overall Dimensions	Basin Depth	Holes	Color	Price
168002	K-6401-ST	12-1/4" x 13-1/4", Stainless Steel				

Cairn™ Neoroc™ Basin Rack for K-8206 and K8207 Cairn™ Kitchen Sinks

Part #	Mfg #	Overall Dimensions	Basin Depth	Holes	Color	Price
188407	K-5192-ST	9-7/16" x 4", Stainless Steel				

Cairn™ Sink Rack for K-8199 Cairn™ Kitchen Sink

Part #	Mfg #	Overall Dimensions	Basin Depth	Holes	Color	Price
188406	K-5656-ST	13-3/4" x 14", Stainless Steel				

Colander for Ravinia™ and Undertone® Kitchen Sinks

- Polypropylene
- Dishwasher safe
- Fits in the bowl of the
 - Ravinia™ sinks K-3222, K-3224 and K-3232
 - Undertone® sinks: K-3336, K-3337, K-3354 and K-3356



Part #	Mfg #	Overall Dimensions	Basin Depth	Holes	Color	Price
057255	K-3291-0	15" x 15" x 4-1/16"				

Kitchen Stainless Steel Sinks

Deerfield® Sink Rack for Left or Right Bowl

- Reversible design
- Dishwasher safe
- Fits in the left bowl of the K-5873 Deerfield® kitchen sink
- Rubber feet provide added protection



Part #	Mfg #	Overall Dimensions	Basin Depth	Holes	Color	Price
168424	K-6121-ST	12-7/8" x 15-3/8", Left Bowl, Stainless Steel				
168425	K-6122-ST	12-7/8" x 15-3/8", Right Bowl, Stainless Steel				

Langlade® Smart Divide® Sink Rack for K-6626 Kitchen Sink

Part #	Mfg #	Overall Dimensions	Basin Depth	Holes	Color	Price
187222	K-5180-ST	13-1/2" x 15-1/4", Right Bowl, Stainless Steel				
187223	K-5182-ST	13-1/2" x 15-3/8", Left Bowl, Stainless Steel				

Lift Dish Rack

- Rim lifts up to support large items; collapses for compact storage in a cabinet
- Wine glass rack folds upward for use; easily folds down when not in use
- Collapsible corner utensil band
- Stacks dishes front to back or side to side
- Drains over sink rim
- Open design promotes airflow
- Angled drain board and round corners prevent standing water
- Stands on end or side for easy storage under sink or in slim cabinets
- Removable grate is dishwasher safe



Part #	Mfg #	Length	Height	Width	Price
231016	K-8631-0	19"	10-1/2"	14-1/2"	

Poise® Sink Rack

- Fits in the bowl of the K-3158 Poise® kitchen sink
- Stainless-steel construction
- Dishwasher safe
- Rubber feet provide added protection

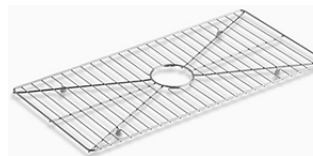

Part #	Mfg #	Overall Dimensions	Basin Depth	Holes	Color	Price
085217	K-3141-ST	28-3/16" x 13-3/16", Stainless Steel				

Octave® Sink Rack

- For K-3844 and K-3855 Octave® kitchen sinks (K6484-ST)
- For K-3842 and K3843 Octave® kitchen sinks (K-6453-ST)

Part #	Mfg #	Overall Dimensions	Basin Depth	Holes	Color	Price
159941	K-6484-ST	17-5/8" x 17-1/4", Left Bowl, Stainless Steel				
162276	K-6453-ST	14-1/4" x 17-5/8", Right Bowl, Stainless Steel				

Staccato™ Sink Rack for K-3369 Staccato® Kitchen Sink

Part #	Mfg #	Overall Dimensions	Basin Depth	Holes	Color	Price
071711	K-3194-ST	15-1/8" x 12", Left Bowl, Stainless Steel				

Kitchen Stainless Steel Sinks

Stainless Steel Kitchen Sink Accessories (Continued)

Staccato™ Sink Rack for K-3369 Staccato® Kitchen Sink

Part #	Mfg #	Overall Dimensions	Basin Depth	Holes	Color	Price
186452	K-5117-ST	13-1/4" x 15-7/8", Right Bowl, Stainless Steel				
186451	K-5119-ST	13" x 15-3/4", Left Bowl, Stainless Steel				

Stainless Steel Sink Rack

- For Models:
 - Verse™ K-3373
 - Undertone® K-3183
 - Verity® K-3156, K-3157
- Dishwasher safe
- Stainless-steel construction
- Rubber feet provide added protection

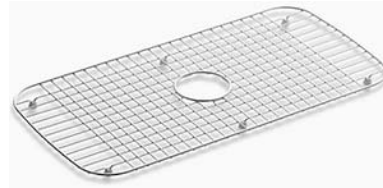

Part #	Mfg #	Finish	Price
085099	K-3133-ST	13-3/4" x 27-1/2", Stainless Steel	

Stainless Steel Sink Rack for K-8679 Riverby® Kitchen Sinks

- Comes included with K-8679 Riverby® sinks
- Dishwasher safe
- Rubber feet provide added protection



Part #	Mfg #	Overall Dimensions	Basin Depth	Holes	Color	Price
230864	K-9238-ST	12-7/8" x 14-5/16", Stainless Steel				

Tanager® Sink Rack for Right or Left Bowl

- 16-1/4" x 11-1/2"
- Stainless-steel construction
- Fits in the left bowl of the K-6491 Tanager® kitchen sink
- Dishwasher safe
- Rubber feet provide added protection

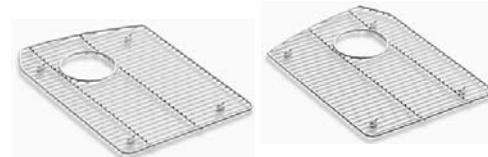

Part #	Mfg #	Overall Dimensions	Basin Depth	Holes	Color	Price
139990	K-6146-ST	Left Bowl, Stainless Steel				
139991	K-6147-ST	Right Bowl, Stainless Steel				

Undertone™ Iron/Tones® Coated Sink Basket — 13-1/2" x 15-1/4"

- Fits the Iron/Tones™ K-6584 and 6585 Iron/Tones™ kitchen sinks
- Fits the K-3163, K-3168, K-3171, K-3174, K-3177, K-3330, K-3331, K-3332, K-3334, K-3350, K-3351, K-3352, K-3353, K-3325 Undertone™ kitchen sinks



Part #	Mfg #	Finish	Price
103842	K-3277-ST	Stainless Steel	

Sinks

Kitchen Stainless Steel Sinks

Undertone™ Kitchen Wire Storage Basket

- For Models K-3154, K-3155, K-3156, and K-3157

Part #	Mfg #	Finish	Price
083452	K-3127-ST	Stainless Steel	

Undertone™ Sink Rack

- For K-3356 and K-3356-HCF Undertone™ kitchen sinks (K-6389-ST & K-6390-ST)
- For K-3171 and K-3171-HCF Undertone™ kitchen sinks (K-6388-ST)

Part #	Mfg #	Overall Dimensions	Basin Depth	Holes	Color	Price
172722	K-6388-ST	For Models K-3171 and K-3171-HCF, Stainless Steel				
174210	K-6389-ST	For Models K-3356 and K-3356-HCF, LH Bowl, Stainless Steel				
172723	K-6390-ST	For Models K-3356 and K-3356-HCF, RH Bowl, Stainless Steel				

Undertone® Sink Rack for Left Bowl

- Stainless-steel construction
- Dishwasher safe
- Fits in the left bowl of the K-3148 and K-3197 Undertone® kitchen sinks
- Rubber feet provide added protection



Part #	Mfg #	Overall Dimensions	Basin Depth	Holes	Color	Price
099032	K-2997-ST	14-1/4" x 14-3/4", Stainless Steel				

Utility Rack

- Fits K-3820, K-3821, K-3823, K-3838, K-3839, K-3935, K-3942, and K-3944 Vault™ kitchen sinks
- Comes included with the K-5285-NA, K-5283-NA, and 5409-NA Strive™ kitchen sinks



Part #	Mfg #	Overall Dimensions	Basin Depth	Holes	Color	Price
172042	K-6429-ST	Stainless Steel				

Vault™ Sink Rack

- For K-3944 Vault™ kitchen sink (K-6475-ST)
- For K-3820 and K-3838 Vault™ kitchen sinks (K-6475-ST)

Part #	Mfg #	Description	Price
138968	K-6641-ST	14" x 15-19/20", Stainless Steel	
179742	K-6475-ST	15-1/4" x 16-3/4" Stainless Steel	

Vault™/Strive™ Sink Rack for Apron Front Sinks

- Fits in the small bowl of the K-3945 Vault™ and K-5416 Strive™ kitchen sinks (K-6647-ST)
—For 36" offset apron-front sink
- Fits in the rectangular bowl of the K-3943 Vault™ and K-5415 Strive™ kitchen sinks (K-6474-ST)
—For 36" single bowl apron-front sink
- Fits in the rectangular bowl of the K-3936 Vault™ and K-5417 Strive™ kitchen sinks (K-6466-ST)
—For 30" single bowl apron-front sink

Part #	Mfg #	Overall Dimensions	Basin Depth	Holes	Color	Price
141042	K-6647-ST	11-1/8" x 16", Stainless Steel				
175216	K-6474-ST	32" x 16-3/4" , Stainless Steel				

Kitchen Stainless Steel Sinks

Stainless Steel Kitchen Sink Accessories (Continued)

Vault™/Strive™ Sink Rack for Apron Front Sinks

Part #	Mfg #	Overall Dimensions	Basin Depth	Holes	Color	Price
176498	K-6466-ST	26" x 16-3/4", Stainless Steel				

Vault™/Strive™ Sink Rack for Right Basin — 11-1/4" x 16-3/4"

- Fits in the small right bowl of the K-3823 and K-3839 Vault™ kitchen sinks and K-5284 Strive™ kitchen sink

Part #	Mfg #	Overall Dimensions	Basin Depth	Holes	Color	Price
141030	K-6477-ST	Stainless Steel				

Vault™/Strive™ Saddle Towel Bar

- Fits K-3820, K-3823, K-3838, K-3839, K-3944, and K-3945 Vault™ kitchen sinks.
- Comes included with K-5281-NA and K-5282-NA Strive™ kitchen sinks.
- 13-9/16" Width

Part #	Mfg #	Overall Dimensions	Basin Depth	Holes	Color	Price
159662	K-6432	13-9/16 Width, Stainless Steel				

Wheatland® Sink Rack for Left or Right Bowl

- Stainless-steel construction
- Fits in the left bowl of the K-5870 Wheatland® kitchen sink
- Dishwasher safe
- Rubber feet provide added protection



Part #	Mfg #	Overall Dimensions	Basin Depth	Holes	Color	Price
145450	K-6148-ST	9-1/8" x 14-3/8", Left Bowl, Stainless Steel				
145451	K-6159-ST	15-5/16" x 16-7/8", Right Bowl, Stainless Steel				

Saddle Utility Rack

- Fits K-3820, K-3823, K-3838, K-3839, K-3944, and K-3945 Vault™ kitchen sinks.
- Comes included with K-5281-NA and K-5282-NA Strive™ kitchen sinks.



Part #	Mfg #	Overall Dimensions	Basin Depth	Holes	Color	Price
167838	K-6434-ST	Stainless Steel				

Undertone™ Hardwood Cutting Board

- 15" x 14" x 10"
- Fits over:
 - Ravinia kitchen sinks: K-3222, K-3232, and K-3224
 - Undertone™ bar sink: K-14300
 - Undertone™ kitchen sinks: K-3150, K-3164, K-3165, K-3166, K-3336, K-3337, K-3354, K-3356, and K-3359



Part #	Mfg #	Overall Dimensions	Basin Depth	Holes	Color	Price
057026	K-3278-NA	Hardwood Construction				

Sinks

Kitchen Stainless Steel Sinks

Vault™/Strive™ Wood Cutting Board

- For K-3820, K-3822, K-3823, K-3839, K-3894, K-3895, K-3942, K-3943, K-3944, K-3945, K-3996 Vault™ kitchen sinks
- K-5282, K-5285, and K-5286 Strive™ kitchen sinks.



Part #	Mfg #	Overall Dimensions	Basin Depth	Holes	Color	Price
164742	K-6667-NA	Hardwood				

Poise® Sink Rack for K-3159 and K-3161 Poise® Kitchen Sinks

Part #	Mfg #	Overall Dimensions	Basin Depth	Holes	Color	Price
092812	K-3142-ST	13-1/4" x 13-1/4", Stainless Steel				

Poise® Hardwood Cutting Board

- Bamboo
- For Models K-3158, K-3159, K-3160, K-3161, K-3672, K-3673, and K-3671



Part #	Mfg #	Overall Dimensions	Basin Depth	Holes	Color	Price
081504	K-3140-NA	Bamboo				

Stages™ Hardwood Cutting Board for K-3760 and K-3761 Stages™ Kitchen Sinks

- American walnut construction



Part #	Mfg #	Finish
155164	K-6232-NA	Walnut, For Models K-3760 and K-3761

Sinks

Kitchen Stainless Steel Sinks

Stainless Steel Kitchen Sinks

Carthage® Undermount Single Bowl Kitchen Sink

- SilentShield® sound-absorption technology
- Undermount rimless design
- Installation hardware included



Part #	Mfg #	Overall Dimensions	Depth	Holes	Drain	Finish	Price
125000	11605-NA	32" x 18"	9"	Less Holes	3-5/8"	18ga Satin	

Carthage® Undermount Equal Double Bowl Kitchen Sink

- One-piece construction
- SilentShield® sound-absorption technology
- Undermount rimless design



Part #	Mfg #	Overall Dimensions	Depth	Holes	Drain	Finish	Price
129490	11445-NA	32" x 18"	8-1/4"	Less Holes	3-5/8"	18ga Satin	

McAllister® Undermount Single Bowl Kitchen Sink

- SilentShield™ sound deadening
- Installation hardware included
- Rimless design



Part #	Mfg #	Overall Dimensions	Depth	Holes	Drain	Gauge/Finish	Price
105392	11600-NA	30" x 18"	9"	Less Holes	3-5/8"	18ga Satin	
105391	11447-NA	24" x 18"	8"	Less Holes	3-5/8"	20ga Satin	

McAllister® Undermount Double Bowl Kitchen Sink

- SilentShield™ sound deadening
- Installation hardware included
- Rimless design



Part #	Mfg #	Overall Dimensions	Depth	Holes	Drain	Gauge/Finish	Price
098433	11406-NA	32" x 18"	8"	Less Holes	3-5/8"	20ga Satin	
098379	11409-NA	31-3/4" x 20-3/4"	8"	Less Holes	3-3/4"	18ga Satin	
098380	11409-L-NA	31-3/4" x 18"/20-3/4"	8"	Less Holes	3-3/4"	18ga Satin	
111437	11444-NA	32" x 18"	8-1/4"	Less Holes	3-5/8"	18ga Satin	

Southaven® Self-Rimming Single Bowl Kitchen Sink

- Ledge back
- Curved deck design
- Rolled rim
- SilentShield™ sound deadening



Part #	Mfg #	Overall Dimensions	Depth	Holes	Drain	Gauge/Finish	Price
136421	11878-3-NA	33" x 22"	9"	3	3-5/8"	19ga Satin	
147085	11878-4-NA	33" x 22"	9"	4	3-5/8"	19ga Satin	
189258	24912-4-NA	33" x 22"	8"	4	3-5/8"	20ga Satin	

Kitchen Stainless Steel Sinks

Southhaven® Self-Rimming Double Bowl Kitchen Sink

- Ledge back
- Curved deck design
- Rolled rim
- SilentShield™ sound deadening



Sinks

Part #	Mfg #	Overall Dimensions	Depth	Holes	Drain	Gauge/Finish	Price
084368	11400-3-NA	33" x 22"	6-1/2"	3	3-5/8"	22ga Satin	
074248	11400-4-NA	33" x 22"	6-1/2"	4	3-5/8"	22ga Satin	
085909	11402-3-NA	33" x 22"	8"	3	3-5/8"	20ga Satin	
085908	11402-4-NA	33" x 22"	8"	4	3-5/8"	20ga Satin	
115436	11850-3-NA	33" x 22"	8-1/2"	3	3-5/8"	18ga Satin	

Kitchen Sink Accessories

Stainless Steel Sink Accessories
Bottom Basin Rack

- *Protects the kitchen sink from scratches or stains*

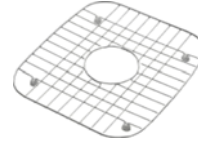

Part #	Mfg #	Dimensions	For:	Price
121712	11862-ST	11-3/4" x 13-1/4"	Springdale® Single or McAllister® Double Sink (Smaller Basin)	
128645	11863-ST	11-7/8" x 16-1/4"	Springdale® Single or McAllister® Double Sink (Larger Basin)	

Sinks

Kitchen Stainless Steel Sinks

Sinks

Undermount Single Bowl Stainless Steel Kitchen Sinks

Magnum™ Large Single Bowl Undermount Kitchen Sink

- 304 Series, 18 gauge stainless steel
- 18/8 Chrome/nickel content
- Satin finish
- 4 Diagonal drain groves channel water directly to center drain
- Sound deadening insulation



Part #	Mfg #	Finish	Bowl Depth	Overall Size	Cabinet Size	Drain Dia	Price
153859	440302	Stainless Steel	10"	31-1/4" x 18"	33"	3-1/2"	

One™ XL Single Bowl Undermount Kitchen Sink

- 304 Series, 18 gauge stainless steel
- 18/10 Chrome/nickel content
- Satin polished finish
- Rear drain placement
- Sound deadening pads



Part #	Mfg #	Finish	Bowl Depth	Overall Size	Cabinet Size	Drain Dia	Price
169513	441588	Stainless Steel	9"	30" x 20"	33"	3-1/2"	

Precision™ Steelart™ R10 Super Single Bowl Undermount Kitchen Sink

- 304 Series, 18 gauge stainless steel
- 18/10 Chrome/nickel content
- 10mm radius corners
- Satin polished finish
- Rear drain placement
- Sound deadening pads



Part #	Mfg #	Finish	Bowl Depth	Overall Size	Cabinet Size	Drain Dia	Price
114550	513686	Stainless Steel	10"	32" x 20"	36"	3-1/2"	

Precision™ Steelart™ Super Single Bowl Undermount Kitchen Sink

- 304 Series, 18 gauge stainless steel
- 18/10 Chrome/nickel content
- Zero radius corners
- Satin polished finish
- Rear drain placement
- Sound deadening pads



Part #	Mfg #	Finish	Bowl Depth	Overall Size	Cabinet Size	Drain Dia	Price
126101	515820	Stainless Steel	10"	32" x 18"	36"	3-1/2"	
090953	512747	Stainless Steel	10"	32" x 19"	36"	3-1/2"	

Kitchen Stainless Steel Sinks

Precision™ MicroEdge™ Large Single Bowl Undermount Kitchen Sink

- 304 Series, 18 gauge stainless steel
- 18/10 Chrome/nickel content
- Satin polished finish
- Versatile design with inset or flushmount installation capabilities
- Sink clips are installed in sink (will fit 3cm countertops)
- Sound deadening pads



Part #	Mfg #	Finish	Bowl Depth	Overall Size	Cabinet Size	Drain Dia	Price
158951	516201	Stainless Steel	10"	32" x 18"	33"	3-1/2"	

Precision™ MicroEdge™ Medium Single Bowl Undermount Kitchen Sink

- 304 Series, 18 gauge stainless steel
- 18/10 Chrome/nickel content
- Satin polished finish
- Versatile design with inset or flushmount installation capabilities
- Sink clips are installed in sink (will fit 3cm countertops)
- Sound deadening pads



Part #	Mfg #	Finish	Bowl Depth	Overall Size	Cabinet Size	Drain Dia	Price
161320	516199	Stainless Steel	10"	22" x 18"	24"	3-1/2"	

Quatrus™ Single Bowl Undermount Kitchen Sink

- 304 Series, 18 gauge stainless steel
- 18/10 Chrome/nickel content
- Stain polish finish
- Rear drain placement
- Sound deadening coating



Part #	Mfg #	Finish	Bowl Depth	Overall Size	Cabinet Size	Drain Dia	Price
158553	518478	Stainless Steel	9"	22" x 18"	27"	3-1/2"	
173025	518171	Stainless Steel	9"	25" x 18"	30"	3-1/2"	

Quatrus™ R15 Single Bowl Undermount Kitchen Sink

- R15 Radius offers transitional yet geometric design
- 304 Series, 18 gauge stainless steel
- 18/10 Chrom/nickel content
- Satin finish
- Rear drain placement
- Sound deadening pads



Part #	Mfg #	Finish	Bowl Depth	Overall Size	Cabinet Size	Drain Dia	Price
174056	519546	Stainless Steel	9"	22" x 18"	27"	3-1/2"	
224564	519547	Stainless Steel	9"	25" x 18"	30"	3-1/2"	
175431	519548	Stainless Steel	9"	32" x 18"	36"	3-1/2"	

Kitchen Stainless Steel Sinks

Sinks

Stellar™ Medium Single Bowl Undermount Kitchen Sink

- 304 Series, 18 gauge stainless steel
- 18/10 Chrome/nickel content
- Refined brushed finish
- Rear drain placement
- Sound deadening coating



Part #	Mfg #	Finish	Bowl Depth	Overall Size	Cabinet Size	Drain Dia	Price
123283	441025	Stainless Steel	8"	25" x 18"	27"	3-1/2"	

Wave™ Small Single Bowl Undermount Kitchen Sink

- 304 Series, 18 gauge stainless steel
- 18/10 Chrome/nickel content
- Stain polish finish
- Rear drain placement
- Sound deadening coating



Part #	Mfg #	Finish	Bowl Depth	Overall Size	Cabinet Size	Drain Dia	Price
183903	440164	Stainless Steel	8"	19-11/16" x 20-1/2"	21"	3-1/2"	
153557	440248	Stainless Steel	8"	22-7/16" x 20-7/16"	27"	3-1/2"	
036830	440249	Stainless Steel	10"	22-7/16" x 20-7/16"	27"	3-1/2"	

Undermount Double Bowl Stainless Steel Kitchen Sinks

Niagara™ 1-1/2 Bowl Undermount Kitchen Sink

- 304 Series, 18 gauge stainless steel
- 18/10 chrome/nickel content
- Satin polished finish
- Rear drain placement
- Sound deadening pads



Part #	Mfg #	Finish	Bowl Depth	Overall Size	Cabinet Size	Drain Dia	Price
135146	440161	Stainless Steel	8"/6-1/2"	27-1/2" x 18-1/8"	30"	3-1/2"	

Performa™ Equal Double Bowl Undermount Kitchen Sink

- 304 Series, 18 gauge stainless steel
- 18/10 Chrome/nickel content
- Satin polished finish
- Rear drain placement
- Sound deadening pads



Part #	Mfg #	Finish	Bowl Depth	Overall Size	Cabinet Size	Drain Dia	Price
154464	440110	Stainless Steel	10"	33-1/8" x 20"	36"	3-1/2"	

Kitchen Stainless Steel Sinks

Performa™ Medium 1-3/4 Bowl Undermount Kitchen Sink

- 304 Series , 18 gauge stainless steel
- 18/10 Chrome/nickel content
- Satin polished finish
- Rear drain placement
- Sound deadening pads



Part #	Mfg #	Finish	Bowl Depth	Overall Size	Cabinet Size	Drain Dia	Price
161033	441002	Stainless Steel	10" & 9"	33-1/8" x 20"	36"	3-1/2"	

Spex Plus™ Equal Double Bowl Kitchen Sink

- 304 Series, 18 gauge stainless steel
- 18/8 Chrome/nickel content
- Satin finish
- Rear drain placement
- Sound deadening pads



Part #	Mfg #	Finish	Bowl Depth	Overall Size	Cabinet Size	Drain Dia	Price
127505	440258	Stainless Steel	8-1/2"	31-1/8" x 18"	36"	3-1/2"	

Stellar™ Equal Double Bowl Undermount Kitchen Sink

- 304 Series, 18 gauge stainless steel
- 18/10 Chrome/nickel content
- Refined brushed finish
- Rear drain placement



Part #	Mfg #	Finish	Bowl Depth	Overall Size	Cabinet Size	Drain Dia	Price
123276	441020	Stainless Steel	8"	33-1/3" x 18-1/2"	36"	3-1/2"	

Stellar™ 1-3/4 Bowl Undermount Kitchen Sink

- 304 Series, 18 gauge stainless steel
- 18/10 Chrome/nickel content
- Refined brushed finish
- Rear drain placement



Part #	Mfg #	Finish	Bowl Depth	Overall Size	Small Bowl	Cabinet Size	Drain Dia	Price
123279	441023	Stainless Steel	9" & 7"	32-1/3" x 20-1/2"	RH	36"	3-1/2"	
137735	441261	Stainless Steel	7" & 9"	32-3/8" x 20-1/2"	LH	36"	3-1/2"	

Sinks

Kitchen Stainless Steel Sinks

Sinks

Stellar™ 1.6 Bowl Undermount Kitchen Sink

- 304 Series, 18 gauge stainless steel
- 18/10 Chrome/nickel content
- Refined brush finish
- Rear drain placement
- Sound deadening pads



441262

441022

Part #	Mfg #	Finish	Bowl Depth	Overall Size	Cabinet Size	Drain Dia	Price
123278	441022	Stainless Steel	9" & 7"	31-3/4" x 20-1/2"	36"	3-1/2"	
137734	441262	Stainless Steel	7" & 9"	31-3/4" x 20-1/2"	36"	3-1/2"	

Supreme™ 1-3/4 Bowl Undermount Kitchen Sink

- 304 Series, 18 gauge stainless steel
- 18/10 Chrome/nickel content
- Satin polished finish
- Rear drain placement
- Sound deadening pads



Part #	Mfg #	Finish	Bowl Depth	Overall Size	Cabinet Size	Drain Dia	Price
154178	440234	Stainless Steel	8" & 7"	31-5/16" x 20-7/8"	36"	3-1/2"	

Supreme™ 1-1/2 Bowl Undermount Kitchen Sink

- 304 Series, 18 gauge stainless steel
- 18/10 Chrome/nickel content
- Satin polished finish
- Rear drain placement
- Sound deadening pads



Part #	Mfg #	Finish	Bowl Depth	Overall Size	Cabinet Size	Drain Dia	Price
142624	440163	Stainless Steel	10"/6"	25-3/4" x 20-7/16"	30"	3-1/2"	

Blanco Wave™ 1-1/2" Bowl Undermount Kitchen Sink

- 304 Series, 18 gauge stainless steel
- 18/10 Chrome/nickel content
- Satin polish finish
- Rear drain placement
- Sound deadening pads



Part #	Mfg #	Finish	Bowl Depth	Overall Size	Cabinet Size	Drain Dia	Price
167785	440246	Stainless Steel	10" & 6"	32-3/32" x 20-7/8"	36"	3-1/2"	

Kitchen Stainless Steel Sinks

Blanco Wave™ PLUS 1-1/2 Bowl Undermount Kitchen Sink

- 304 Series, 18 gauge stainless steel
- 18/10 Chrome/nickel content
- Satin polish finish
- Rear drain placement
- Sound deadening pads



Part #	Mfg #	Finish	Bowl Depth	Overall Size	Cabinet Size	Drain Dia	Price
133555	440167	Stainless Steel	10"	31-1/2" x 20-7/8"	36"	3-1/2"	

Quatrus™ Equal Double Bowl Undermount Kitchen Sink

- 304 Series, 18 gauge stainless steel
- 18/10 Chrome/nickel content
- Stain finish
- Rear drain placement
- Sound deadening pads



Part #	Mfg #	Finish	Bowl Depth	Overall Size	Cabinet Size	Drain Dia	Price
165816	518170	Stainless Steel	9"	32" x 18"	36"	3-1/2"	

Quatrus™ 1-3/4 Bowl Undermount Kitchen Sink

- 304 Series, 18 gauge stainless steel
- 18/10 Chrome/nickel content
- Satin finish
- Rear drain placement
- Sound deadening pads



Part #	Mfg #	Finish	Bowl Depth	Overall Size	Cabinet Size	Drain Dia	Price
170286	518169	Stainless Steel	9"	33" x 18"	36"	3-1/2"	
185583	519550	Stainless Steel	9"	33" x 18"	36"	3-1/2"	

Quatrus™ R15 Equal Double Bowl Undermount Kitchen Sink

- R15 radius offers transitional yet geometric design
- 304 Series, 18 gauge stainless steel
- 18/10 Chrome/nickel content
- Stain finish
- Rear drain placement
- Sound deadening pads



Part #	Mfg #	Finish	Bowl Depth	Overall Size	Cabinet Size	Drain Dia	Price
174568	519549	Stainless Steel	9"	32" x 18"	36"	3-1/2"	

Sinks

Kitchen Stainless Steel Sinks

Sinks

Precision™ 16" Equal Double Bowl Undermount Kitchen Sink

- 304 Series, 18 gauge stainless steel
- 18/10 Chrome/nickel content
- Satin polished finish
- Rear drain placement
- Sound deadening pads



Part #	Mfg #	Finish	Bowl Depth	Overall Size	Cabinet Size	Drain Dia	Price
183262	516212	Stainless Steel	10"	37" x 18"	39"	3-1/2"	
224390	516211	Stainless Steel	10"	29" x 18"	33"	3-1/2"	

Precision™ 16" 1-3/4 Bowl Undermount Kitchen Sink

- 304 Series, 18 gauge stainless steel
- 18/10 Chrome/nickel content
- Satin polished finish
- Rear drain placement
- Sound deadening pads



Part #	Mfg #	Finish	Bowl Depth	Overall Size	Cabinet Size	Drain Dia	Price
224460	515821	Stainless Steel	10"	33" x 18"	36"	3-1/2"	

Precision™ 16"R10 Equal Double Bowl Undermount Kitchen Sink

- 304 Series, 18 gauge stainless steel
- 18/10 Chrome/nickel content
- Satin polished finish
- Rear drain placement
- 10mm Radius corners
- Sound deadening pads



Part #	Mfg #	Finish	Bowl Depth	Overall Size	Cabinet Size	Drain Dia	Price
157352	516219	Stainless Steel	10"	37" x 18"	39"	3-1/2"	
167209	516220	Stainless Steel	10"	32" x 18"	36"	3-1/2"	

Precision™ 16"R10 1-3/4 Bowl Undermount Kitchen Sink

- 304 Series, 18 gauge stainless steel
- 18/10 Chrome/nickel content
- Satin polished finish
- Rear drain placement
- 10mm Radius corners
- Sound deadening pads



Part #	Mfg #	Finish	Bowl Depth	Overall Size	Cabinet Size	Drain Dia	Price
167472	515824	Stainless Steel	10"	33" x 18"	36"	3-1/2"	

Kitchen Stainless Steel Sinks

Precision™ 16" R10 1-1/2 Bowl Undermount Kitchen Sink

- 304 Series, 18 gauge stainless steel
- 18/10 Chrome/nickel content
- Satin polished finish
- Rear drain placement
- 10mm Radius corners
- Sound deadening pads



Part #	Mfg #	Finish	Bowl Depth	Overall Size	Cabinet Size	Drain Dia	Price
153853	516218	Stainless Steel	10" & 8"	33" x 18"	36"	3-1/2"	

Spex™ 1-3/4" Bowl Undermount Kitchen Sink

- 304 Series, 18 gauge stainless steel
- 18/10 Chrome/nickel content
- Satin finish
- Rear drain placement
- Sound deadening insulation



Part #	Mfg #	Finish	Bowl Depth	Overall Size	Cabinet Size	Drain Dia	Price
157368	440256	Stainless Steel	8-1/2" & 5-1/4"	32" x 18"	36"	3-1/2"	

Sinks

Kitchen Stainless Steel Sinks

Single Bowl Stainless Steel Kitchen Sinks

Avado® Undermount Stainless Steel Deep Single Bowl Sink

- 16" Gauge
- Polished satin finish
- Sound guard undercoating



Part #	Mfg #	Overall Size	Holes	Depth	Drain Opening	Min Sink Base	Price
102476	EFU281610	30-1/2" x 18-1/2"	N/A	10"	3-1/2"	36"	

Avado™ Undermount SS Single Bowl Sink

- 16" Gauge
- Polished satin finish
- Sound guard undercoating



Part #	Mfg #	Overall Size	Holes	Depth	Drain Opening	Min Sink Base	Price
166322	EFUS342110R	34-1/2" x 20-1/2"	N/A	10"	3-1/2"	39"	

Crosstown™ Apron Front SS Single Bowl Sink

- 18" Gauge
- Polished satin finish
- Sound guard opening



Part #	Mfg #	Overall Size	Holes	Depth	Drain Opening	Min Sink Base	Price
174150	ECTRUF30179R	31-1/2" x 18-1/2"	N/A	9"	3-1/2"	36"	

Crosstown™ Undermount SS Single Bowl Sink

- 18" Gauge
- Polished satin finish
- Sound guard undercoating



Part #	Mfg #	Overall Size	Holes	Depth	Drain Opening	Min Sink Base	Price
170596	ECTRU30179R	31-1/2" x 18-1/2"	N/A	9"	3-1/2"	36"	

Crosstown™ Dual Mount SS Single Bowl Sink

- 18" Gauge
- Polished satin finish
- 1 2 FR2 MR2 3 4 5 faucet holes
- 1 2 FR2 ML2 MR2 3 4 5 faucet holes (ECTSRS33229BG Only)
- Sound guard opening
- Includes **for models (ECTSRS33229BG):**
-Bottom grid (CTOBG2915SS)



Part #	Mfg #	Overall Size	Holes	Depth	Drain Opening	Min Sink Base	Price
169562	ECTSRS33229BG1	33" x 22"	1	9"	3-1/2"	36"	
169968	ECTSRS33229BG2	33" x 22"	2	9"	3-1/2"	36"	
226681	ECTSRS33229BG3	33" x 22"	3	9"	3-1/2"	36"	
226240	ECTSRS33229BG4	33" x 22"	4	9"	3-1/2"	36"	
169810	ECTSRS33229BG5	33" x 22"	5	9"	3-1/2"	36"	

Kitchen Stainless Steel Sinks

Single Bowl Stainless Steel Kitchen Sinks (Continued)

Crosstown™ Dual Mount SS Single Bowl Sink

Part #	Mfg #	Overall Size	Holes	Depth	Drain Opening	Min Sink Base	Price
170560	ECTSRS33229BGR2	33" x 22"	FR2	9"	3-1/2"	36"	

Gourmet® Celebrity® Self-Rimming SS Single Bowl Sink

- 20" Gauge
- Brushed satin finish
- 1 2 MR2 3 4 5 faucet holes
- Fully undercoated



Part #	Mfg #	Overall Size	Holes	Depth	Drain Opening	Min Sink Base	Price
131057	CR31221	31" x 22"	1	6-7/8"	3-1/2"	36"	

Gourmet® Elumina Undermount Stainless Steel Deep Single Bowl Sink

- 18" Gauge
- Soft highlighted satin finish
- Sound guard undercoating



Part #	Mfg #	Overall Size	Holes	Depth	Drain Opening	Min Sink Base	Price
146881	EGUH281610R	30-1/2" x 18-1/4"	N/A	10"	3-1/2"	30"	

Gourmet® Lustertone® SS Self-Rimming Single Bowl Sink

- 18" Gauge
- Lustrous highlighted satin finish
- 1 2 MR2 3 4 5 faucet holes
- Fully undercoated
- AD models are ADA compliant



LR31221

Part #	Mfg #	Overall Size	Holes	Depth	Drain Opening	Min Sink Base	Price
179992	LR31221	31" x 22"	1	7-5/8"	3-1/2"	36"	
186048	LRAD3122554	31" x 22"	4	5-1/2"	3-1/2"	36"	
169142	LRAD3122651	31" x 22"	1	6-1/2"	3-1/2"	36"	
158461	LRAD312265MR2	31" x 22"	MR2	6-1/2"	3-1/2"	36"	
119743	LRADQ3122653	31" x 22"	3	6-1/2"	3-1/2"	36"	

Gourmet® Lustertone® Self-Rimming SS Deep Bowl Sink

- 18" Gauge
- Lustrous highlighted satin finish
- 1 2 MR2 3 4 5 faucet holes
- Fully undercoated



Part #	Mfg #	Overall Size	Holes	Depth	Drain Opening	Min Sink Base	Price
081756	DLR3122121	31" x 22"	1	11-5/8"	3-1/2"	36"	
104092	DLR3122123	31" x 22"	3	11-5/8"	3-1/2"	36"	
084847	DLRS3322103	33" x 22"	3	10-1/8"	3-1/2"	36"	

Kitchen Stainless Steel Sinks

Single Bowl Stainless Steel Kitchen Sinks (Continued)

Gourmet® Lustertone® Self-Rimming SS Deep Bowl Sink

Part #	Mfg #	Overall Size	Holes	Depth	Drain Opening	Min Sink Base	Price
162373	DLRS3322120	33" x 22"	0	12"	3-1/2"	36"	
173127	DLRS3322121	33" x 22"	1	12"	3-1/2"	36"	
162372	DLRS3322123	33" x 22"	3	12"	3-1/2"	36"	

Gourmet® Lustertone® Self-Rimming Kitchen Sink with Countertop Ledge

- 18" Gauge
- Lustrous highlighted satin finish
- 1 2 MR2 3 4 faucet holes
- Stainless Steel Material
- Single Bowl
- Fully undercoated



ILR4322RMR2

ILR4322LMR2

Part #	Mfg #	Overall Size	Holes	Depth	Drain Opening	Min Sink Base	Price
171109	ILR4322LMR2	43" x 22"	MR2	7-5/8"	3-1/2"	48"	
171840	ILR4322RMR2	43" x 22"	MR2	7-5/8"	3-1/2"	48"	

Gourmet® Lustertone® Self-Rimming Single Bowl Kitchen Sink with Countertop Ledge

- 18" Gauge
- Lustrous highlighted satin finish
- 1 2 MR2 3 4 5 faucet holes
- Fully undercoated



Part #	Mfg #	Overall Size	Holes	Depth	Drain Opening	Min Sink Base	Price
151173	ILR5422DD2	54" x 22"	2	7-5/8"	3-1/2"	57"	

Gourmet® Lustertone® Undermount Farm Apron Front SS Single Bowl Sink

- 18" Gauge
- Lustrous highlighted satin finish
- Sound guard undercoating
- DBG models include:
-LKWOBG2816SS Bottom grid
-LK99 Drain



Part #	Mfg #	Overall Size	Holes	Depth	Drain Opening	Min Sink Base	Price
075702	ELUHFS2816	33" x 20-1/2"	N/A	8"	3-1/2"	36"	
226049	ELUHFS2816DBG	33" x 20-1/2"	N/A	8"	3-1/2"	36"	

Gourmet® Lustertone® Undermount SS Single Bowl Sink

- 18" Gauge
- Lustrous highlighted satin finish
- Sound guard undercoating
- AD models are ADA compliant



ELUH2816

Part #	Mfg #	Overall Size	Holes	Depth	Drain Opening	Min Sink Base	Price
105655	ELUH2816	30-1/2" x 18-1/2"	N/A	7-1/2"	3-1/2"	36"	

Kitchen Stainless Steel Sinks

Single Bowl Stainless Steel Kitchen Sinks (Continued)

Gourmet® Lustertone® Undermount SS Single Bowl Sink

Part #	Mfg #	Overall Size	Holes	Depth	Drain Opening	Min Sink Base	Price
057696	ELUH281610	30-1/2" x 18-1/2"	N/A	10"	3-1/2"	36"	
082719	ELUH281612	30-1/2" x 18-1/2"	N/A	11-1/2"	3-1/2"	36"	
185138	ELUHAD281645	30-1/2" x 18-1/2"	N/A	4-1/2"	3-1/2"	36"	

Pursuit™ Outdoor Undermount Stainless Steel Sink

- 18" Gauge, type 316 stainless steel
- Lustrous highlighted satin finish
- Sound guard plus undercoating
- Drain not included



Part #	Mfg #	Overall Size	Holes	Depth	Drain Opening	Min Sink Base	Price
225572	PODUH2816	30-1/2" x 18-1/2"	N/A	7-7/8"	3-1/2"	36"	

Double Bowl Stainless Steel Kitchen Sinks

Avado® Undermount SS Double Bowl Sink

- 16" Gauge
- Polished satin finish
- Sound guard undercoating
- 3219 model has reversible design
- **DBG** model includes:
 - LKOBG1316SS bottom grid
 - LK99 drain



Part #	Mfg #	Overall Size	Holes	Depth	Drain Opening	Min Sink Base	Price
180432	EFRU3118DBG	30-3/4" x 18-1/2"	N/A	8"	3-1/2"	36"	
167092	EFRU312010R	31-1/4" x 20-1/2"	N/A	10"	3-1/2"	36"	
168370	EFU312010R	31-1/4" x 20-1/2"	N/A	10"	3-1/2"	36"	
168194	EFRU3219	32-1/4" x 18-1/4"	N/A	8"	3-1/2"	36"	

Crosstown™ Apron Front SS Double Bowl Sink

- 18" Gauge
- Polished satin finish
- Sound guard opening



Part #	Mfg #	Overall Size	Holes	Depth	Drain Opening	Min Sink Base	Price
170170	ECTRUF32179R	31-1/2" x 20-1/4"	N/A	9"	3-1/2"	36"	

Sinks

Kitchen Stainless Steel Sinks

Sinks

Crosstown™ Undermount SS Double Bowl Sink

- 18" Gauge
- Polished satin finish
- Sound guard undercoating



Part #	Mfg #	Overall Size	Holes	Depth	Drain Opening	Min Sink Base	Price
173312	ECTRU31179	31-1/2" x 18-1/2"	N/A	9"	3-1/2"	36"	
178574	ECTRU32179R	31-1/2" x 18-1/2"	N/A	9"	3-1/2"	36"	

Crosstown® Dual-Mount SS Double Bowl Sink

- 18" Gauge
- Polished satin finish
- 1 2 FR2 MR2 3 4 5 faucet holes
- Sound guard undercoating
- Includes (CTOBG1315SS) bottom grid
- AD models are ADA compliant



Part #	Mfg #	Overall Size	Holes	Depth	Drain Opening	Min Sink Base	Price
180778	ECTSRAD33226BG0	33" x 22"	0	6"	3-1/2"	36"	
170950	ECTSR33229BG1	33" x 22"	1	9"	3-1/2"	36"	
178017	ECTSR33229BG3	33" x 22"	3	9"	3-1/2"	36"	
226526	ECTSR33229BG5	33" x 22"	5	9"	3-1/2"	36"	
223610	ECTSR33229BGFR2	33" x 22"	FR2	9"	3-1/2"	36"	
180268	ECTSRO33229RBG1	33" x 22"	1	9"	3-1/2"	36"	
186546	ECTSRO33229RBG3	33" x 22"	3	9"	3-1/2"	36"	
174827	ECTSRO33229RBG5	33" x 22"	5	9"	3-1/2"	36"	
188383	ECTSRO33229RBGFR2	33" x 22"	FR2	9"	3-1/2"	36"	
177161	ECTSRO33229RBGMR2	33" x 22"	MR2	9"	3-1/2"	36"	

Crosstown® Dual-Mount SS Offset (60/40) Double Bowl Sink

- 18" Gauge
- Polished satin finish
- Sound guard undercoating
- Includes (CTOBG1515SS) bottom grid (large bowl)



Part #	Mfg #	Overall Size	Holes	Depth	Drain Opening	Min Sink Base	Price
229447	ECTSRO33229RBG2	33" x 22"	2	9"	3-1/2"	36"	

Kitchen Stainless Steel Sinks

Gourmet® Celebrity® SS Self-Rimming 30/70 Double Bowl Sink

- 20" Gauge
- Brushed satin finish
- Fully undercoated
- 1 2 MR2 3 4 5 faucet holes



Part #	Mfg #	Overall Size	Holes	Depth	Drain Opening	Min Sink Base	Price
171219	CMR33221	33" x 22"	1	7"	3-1/2"	36"	
023172	CMR33223	33" x 22"	3	7"	3-1/2"	36"	

Gourmet® Celebrity® SS Self-Rimming Equal Double Bowl Sink

- 20" Gauge
- Brushed satin finish
- Fully undercoated
- 1 2 MR2 3 4 5 faucet holes



CR33221

CR33211

Part #	Mfg #	Overall Size	Holes	Depth	Drain Opening	Min Sink Base	Price
006065	CR33213	33" x 21-1/4"	3	7"	3-1/2"	36"	
006066	CR33214	33" x 21-1/4"	4	7"	3-1/2"	36"	
027523	CR33221	33" x 22"	1	7"	3-1/2"	36"	
006067	CR33223	33" x 22"	3	7"	3-1/2"	36"	
006068	CR33224	33" x 22"	4	7"	3-1/2"	36"	
093414	CR3322MR2	33" x 21-1/4"	2	6-7/8"	3-1/2"	36"	
021600	CR43224	43" x 22"	4	6-7/8"	3-1/2"	48"	

Gourmet® Celebrity® SS Self-Rimming Double Bowl Sink

- 20" Gauge
- Brushed satin finish
- Fully undercoated
- 1 2 MR2 3 4 5 faucet holes
- Ribbed area on the faucet deck



Part #	Mfg #	Overall Size	Holes	Depth	Drain Opening	Min Sink Base	Price
006090	ECC33224	33" x 22"	4	7-1/2"	3-1/2"	36"	
158940	ECC3322MR2	33" x 22"	MR2	7-1/2"	3-1/2"	36"	

Gourmet® Celebrity® SS Self-Rimming Double Bowl Sink

- 20" Gauge
- Brushed satin finish
- Fully undercoated
- 1 2 MR2 3 4 5 faucet holes



Part #	Mfg #	Overall Size	Holes	Depth	Drain Opening	Min Sink Base	Price
174567	GECCR3321MR2	33" x 21-1/4"	MR2	5-3/8"	3-1/2"	36"	

Kitchen Stainless Steel Sinks

Sinks

Gourmet® Celebrity® Stainless Steel Deep Self-Rimming Double Bowl Sink

- 20" Gauge
- Brushed satin finish
- Fully undercoated
- 1 2 MR2 3 4 5 faucet holes
- Suffix L or R signifies side of deeper bowl



Part #	Mfg #	Overall Size	Holes	Depth	Drain Opening	Min Sink Base	Price
151023	STCR3322LMR2	33" x 22"	MR2	10-1/4"	3-1/2"	36"	

Gourmet® Celebrity® SS Self-Rimming Double Bowl Corner Sink

- 20" gauge
- Brushed satin finish
- Fully undercoated



Part #	Mfg #	Overall Size	Holes	Depth	Drain Opening	Min Sink Base	Price
166713	CCR32321	31-7/8" x 31-7/8"	1	6-7/8"	3-1/2"	36"	
166801	CCR32322	31-7/8" x 31-7/8"	2	6-7/8"	3-1/2"	36"	
022011	CCR32323	31-7/8" x 31-7/8"	3	6-7/8"	3-1/2"	36"	
006056	CCR32324	31-7/8" x 31-7/8"	4	6-7/8"	3-1/2"	36"	

Gourmet® Lustertone® SS Self-Rimming Equal Double Bowl Sink

- 18" Gauge
- Lustrous highlighted satin finish
- 1 2 MR2 3 4 5 faucet holes
- Sound guard undercoating
- **LR3322PD3** model includes:
-Perfect Drain



Part #	Mfg #	Overall Size	Holes	Depth	Drain Opening	Min Sink Base	Price
118628	LR33191	33" x 19-1/2"	1	7-5/8"	3-1/2"	36"	
094201	LR33193	33" x 19-1/2"	3	7-5/8"	3-1/2"	36"	
108214	LR33194	33" x 19-1/2"	4	7-5/8"	3-1/2"	36"	
173820	LR33195	33" x 19-1/2"	5	7-5/8"	3-1/2"	36"	
103606	LR33211	33" x 21-1/4"	1	7-7/8"	3-1/2"	36"	
102842	LR33213	33" x 21-1/4"	3	7-7/8"	3-1/2"	36"	
089176	LR33214	33" x 21-1/4"	4	7-7/8"	3-1/2"	36"	
101218	LR33223	33" x 22"	3	8-1/8"	3-1/2"	36"	
099176	LR33224	33" x 22"	4	8-1/8"	3-1/2"	36"	
095408	LR3322MR2	33" x 22"	MR2	8-1/8"	3-1/2"	36"	
179714	LR3322PD3	33" x 22"	3	8-1/8"	3-1/2"	36"	

Kitchen Stainless Steel Sinks

Gourmet® Lustertone® SS Self-Rimming Equal Double Bowl Sink

- 18" Gauge
- Lustrous highlighted satin finish
- 1 2 MR2 3 4 5 faucet holes
- Sound guard undercoating
- Fully undercoated



LRAD3322601



LRAD3319504

Part #	Mfg #	Overall Size	Holes	Depth	Drain Opening	Min Sink Base	Price
181976	LRAD3319503	33" x 19-1/2"	3	5"	3-1/2"	36"	
153643	LRAD3319504	33" x 19-1/2"	4	5"	3-1/2"	36"	
111517	LRAD3319603	33" x 19-1/2"	3	6"	3-1/2"	36"	
154314	LRAD3321604	33" x 21-1/4"	4	6"	3-1/2"	36"	
159986	LRAD332165MR2	33" x 21-1/4"	MR2	6-1/2"	3-1/2"	36"	
188925	LRAD3322554	33" x 22"	4	5-1/2"	3-1/2"	36"	
128418	LRAD3322601	33" x 22"	1	6"	3-1/2"	36"	
156923	LRAD3322652	33" x 22"	2	6-1/2"	3-1/2"	36"	
188325	LRAD3722653	37" x 22"	3	6-1/2"	3-1/2"	42"	
156215	LRAD3722654	37" x 22"	4	6-1/2"	3-1/2"	42"	
168266	LRADQ3319501	33" x 19-1/2"	1	5"	3-1/2"	36"	
179735	LRADQ3319601	33" x 19-1/2"	1	6"	3-1/2"	36"	
181410	LRADQ3321554	33" x 21-1/4"	4	5-1/2"	3-1/2"	36"	

Gourmet® Lustertone® Self-Rimming SS Deep Double Bowl Sink

- 18" Gauge
- Lustrous highlighted satin finish
- 1 2 MR2 3 4 5 faucet holes
- Fully undercoated



DLR4322103



DLR37722102



DLR3319101

Part #	Mfg #	Overall Size	Holes	Depth	Drain Opening	Min Sink Base	Price
103554	DLR3319101	33" x 19-1/2"	1	10-1/8"	3-1/2"	36"	
089944	DLR3322103	33" x 22"	3	10-1/8"	3-1/2"	36"	
086752	DLR3322104	33" x 22"	4	10-1/8"	3-1/2"	36"	
084511	DLR3322123	33" x 22"	3	12-1/8"	3-1/2"	36"	
162379	DLR3722102	37" x 22"	2	10"	3-1/2"	42"	
222603	DLR3722103	37" x 22"	3	10"	3-1/2"	42"	
149622	DLR4322103	43" x 22"	3	10-1/8"	3-1/2"	48"	

Gourmet® Lustertone® Self-Rimming Offset Double Bowl Sink

- 18" Gauge
- Lustrous highlighted satin finish
- 1 2 S2 3 4 faucet holes
- Fully undercoated
- Sound guard undercoating (LR2503 only)
- AD models are ADA compliant



Part #	Mfg #	Overall Size	Holes	Depth	Drain Opening	Min Sink Base	Price
138481	LR2503	33" x 22"	3	7-7/8"	3-1/2"	36"	
047861	LR2504	33" x 22"	4	7-7/8"	3-1/2"	36"	

Sinks

Kitchen Stainless Steel Sinks

Double Bowl Stainless Steel Kitchen Sinks (Continued)

Gourmet® Lustertone® Self-Rimming Offset Double Bowl Sink

Part #	Mfg #	Overall Size	Holes	Depth	Drain Opening	Min Sink Base	Price
153645	LRAD250502	33" x 22"	2	5"	3-1/2"	36"	
167417	LRAD250554	33" x 22"	4	5-1/2"	3-1/2"	36"	

Gourmet® Lustertone® Self-Rimming 60/40 Offset Double Bowl Kitchen Sink

- 18" Gauge
- Lustropus highlighted satin finish
- 1 2 MR2 3 4 5 faucet holes
- Fully undercoated



Part #	Mfg #	Overall Size	Holes	Depth	Drain Opening	Min Sink Base	Price
225586	LWR3322L4	33" x 22"	4	7-5/8"	3-1/2"	36"	
162958	LWR3322R4	33" x 22"	4	7-5/8"	3-1/2"	36"	

Gourmet® Lustertone® Self-Rimming Equal Double Bowl Kitchen Sink

- 18" Gauge
- Lustrous highlighted satin finish
- 1 2 MR2 3 4 5 faucet holes
- Fully undercoated



Part #	Mfg #	Overall Size	Holes	Depth	Drain Opening	Min Sink Base	Price
175362	STLR3322L2	33" x 22"	2	10-1/8"	3-1/2"	36"	
186428	STLR3322R5	33" x 22"	5	10-1/8"	3-1/2"	36"	

Gourmet® Elumina Undermount Stainless Steel Double Bowl Sink

- 18" Gauge
- Soft highlighted finish
- Sound guard undercoating
- Drains not included



Part #	Mfg #	Overall Size	Holes	Depth	Drain Opening	Min Sink Base	Price
082405	EGUH3118	31-3/4" x 18-1/4"	0	8"	3-1/2"	36"	

Gourmet® Lustertone® SS Undermount Equal Double Bowl Sink

- 18" Gauge
- Lustrous highlighted satin finish
- Sound guard undercoating
- **ELUH3118PD model** includes two perfect drain kits
- Drains not included unless **PD** exist in model number



Part #	Mfg #	Overall Size	Left Bowl	Right Bowl	Depth	Drain Opening	Min Sink Base	Price
020222	ELUH3118	30-3/4" x 18-1/2"	N/A	10"	3-1/2"	36"		
172772	ELUH311810L	30-3/4" x 18-1/2"	N/A	10"	3-1/2"	36"		
179739	ELUH311810PD	30-3/4" x 18-1/2"	N/A	10"	3-1/2"	36"		

Kitchen Stainless Steel Sinks

Double Bowl Stainless Steel Kitchen Sinks (Continued)

Gourmet® Lustertone® SS Undermount Equal Double Bowl Sink

Part #	Mfg #	Overall Size	Left Bowl	Right Bowl	Depth	Drain Opening	Min Sink Base	Price
117038	ELUH361710	35-3/4" x 18-1/2"	N/A	10"	3-1/2"	39"		

Gourmet® Lustertone® SS Undermount Double Bowl Sink with Reversible Design

- 18" Gauge
- Lustrous highlighted satin finish
- Sound guard undercoating
- Drains not included



Part #	Mfg #	Overall Size	Left Bowl	Right Bowl	Depth	Drain Opening	Min Sink Base	Price
085128	ELUH3129	32-1/4" x 18-1/4"	N/A	7-3/4"	3-1/2"	36"		

Gourmet® Lustertone® SS Undermount Offset Double Bowl Sink

- 18" Gauge
- Lustrous highlighted satin finish
- Sound guard undercoating
- PD includes two perfect drains
- PBG includes two perfect drain kits & bottom grid kit
- PDK includes two perfect drain kits & e-dock
- Drains not included unless stated through model number



ELUH3120L



ELUH3120R

Part #	Mfg #	Overall Size	Left Bowl	Right Bowl	Depth	Drain Opening	Min Sink Base	Price
038604	ELUH3120L	31-1/4" x 20-1/2"	N/A	9-7/8"	3-1/2"	36"		
177202	ELUH3120LPD	31-1/4" x 20-1/2"	N/A	9-7/8"	3-1/2"	36"		
186061	ELUH3120LPDBG	31-1/4" x 20-1/2"	N/A	9-7/8"	3-1/2"	36"		
182840	ELUH3120LPDK	31-1/4" x 20-1/2"	N/A	9-7/8"	3-1/2"	36"		
018512	ELUH3120R	31-1/4" x 20-1/2"	N/A	9-7/8"	3-1/2"	36"		
172758	ELUH3120RPD	31-1/4" x 20-1/2"	N/A	9-7/8"	3-1/2"	36"		

Gourmet® Lustertone® SS Undermount Offset 60/40 Double Bowl Sink

- 18" Gauge
- Lustrous highlighted satin finish
- Sound guard undercoating
- Drains not included



Part #	Mfg #	Overall Size	Left Bowl	Right Bowl	Depth	Drain Opening	Min Sink Base	Price
085842	ELUH3520L	35-1/4" x 20-1/2"	N/A	9-7/8"	3-1/2"	39"		
081134	ELUH3520R	35-1/4" x 20-1/2"	N/A	9-7/8"	3-1/2"	39"		

Sinks

Kitchen Stainless Steel Sinks

Sinks

Gourmet® Lustertone® SS Undermount Double Bowl Sink

- 18" Gauge
- Lustrous highlighted satin finish
- Sound guard undercoating
- Fully undercoated with pad(s) (**ELUHAD2316** model)
- **ELUHAD311855PD** includes two perfect drains
- Drains not included unless **PD** exist in model number



ELUHAD311845



ELUHAD311855PD

Part #	Mfg #	Overall Size	Left Bowl	Right Bowl	Depth	Drain Opening	Min Sink Base	Price
154507	ELUHAD311845	30-3/4" x 18-1/2"	N/A	4-1/2"	3-1/2"	36"		
181979	ELUHAD311845PD	30-3/4" x 18-1/2"	N/A	4-1/2"	3-1/2"	36"		
175153	ELUHAD311855	30-3/4" x 18-1/2"	N/A	5-1/2"	3-1/2"	36"		
226195	ELUHAD311855PD	30-3/4" x 18-1/2"	N/A	5-1/2"	3-1/2"	36"		
159960	ELUHAD321650	31-3/4" x 16-1/2"	N/A	5"	3-1/2"	36"		

Gourmet® Lustertone® Undermount SS Equal Double Bowl Corner Sink

- 18" Gauge
- Lustrous highlighted satin finish
- Sound guard undercoating
- Drains not included



Part #	Mfg #	Overall Size	Holes	Depth	Drain Opening	Min Sink Base	Price
093856	ELUH3232	32" x 32"	N/A	7-7/8"	3-1/2"	36"	

Gourmet® Lustertone® Undermount Farm Apron Front Double Bowl Sink

- 18" Gauge
- Lustrous highlighted satin finish
- 8" High apron
- Sound guard undercoating
- **DBG** models include:
 - LKWOBG1316SS Bottom grid
 - LK99 Drain
- Drains included **ONLY** in **DBG** models



ELUHF332010DBG



ELUHF3320

Part #	Mfg #	Overall Size	Holes	Depth	Drain Opening	Min Sink Base	Price
082964	ELUHF3320	33" x 20-1/2"	N/A	7-7/8"	3-1/2"	36"	
225357	ELUHF332010	33" x 20-1/2"	N/A	10"	3-1/2"	36"	
227482	ELUHF332010DBG	33" x 20-1/2"	N/A	10"	3-1/2"	36"	
165329	ELUHF3320DBG	33" x 20-1/2"	N/A	7-7/8"	3-1/2"	36"	

Gourmet® Pacemaker® SS Self-Rimming Offset Double Bowl Sink

- 20" Gauge
- Bright satin finish
- 1 2 S2 3 4 faucet holes
- Fully undercoated
- Drains not included



PSR2503

Part #	Mfg #	Overall Size	Holes	Depth	Drain Opening	Min Sink Base	Price
098831	PSR2501	33" x 22"	1	7-1/4"	3-1/2"	36"	

Kitchen Stainless Steel Sinks

Double Bowl Stainless Steel Kitchen Sinks (Continued)

Gourmet® Pacemaker® SS Self-Rimming Offset Double Bowl Sink

Part #	Mfg #	Overall Size	Holes	Depth	Drain Opening	Min Sink Base	Price
040804	PSR2503	33" x 22"	3	7-1/4"	3-1/2"	36"	
084597	PSR250S2	33" x 22"	2	7-1/4"	3-1/2"	36"	

Gourmet® Pacemaker® SS Self-Rimming Equal Double Bowl Sink

- 20" Gauge
- Bright satin finish
- 1 2 MR2 3 4 5 faucet holes
- Fully undercoated
- Drains not included



PSR33191

Part #	Mfg #	Overall Size	Holes	Depth	Drain Opening	Min Sink Base	Price
120694	PSR33191	33" x 19-1/2"	1	7-1/8"	3-1/2"	36"	
171066	PSR33192	33" x 19-1/2"	2	7-1/8"	3-1/2"	36"	

Gourmet® Pacemaker® SS Self-Rimming Double Bowl Sink with No Faucet Ledge

- 20" Gauge
- Bright satin finish
- Fully undercoated
- Drains not included



Part #	Mfg #	Overall Size	Holes	Depth	Drain Opening	Min Sink Base	Price
027508	PSFR3319	33" x 19-1/2"	0	7-1/8"	3-1/2"	36"	

Gourmet® Pacemaker® SS Self-Rimming 70/30 Double Bowl Kitchen Sink

- 20" Gauge
- Bright satin finish
- 1 2 MR2 3 4 5 6 faucet holes
- Fully undercoated
- Drains not included



Part #	Mfg #	Overall Size	Holes	Depth	Drain Opening	Min Sink Base	Price
185892	PSMR33222	33" x 22"	2	7-1/4"	3-1/2"	36"	
186775	PSMR3322R2	33" x 22"	2	7-1/4"	3-1/2"	36"	

Gourmet® Undermount SS Double Bowl Sink

- 18" Gauge
- Lustrous highlighted satin finish
- Sound guard undercoating
- AQD models include high aqua divide
-ELUHAQD3218 4-5/8" high aqua divide
- ELUH322010PD model includes:
-Perfect drain
- Drains not included



Part #	Mfg #	Overall Size	Holes	Depth	Drain Opening	Min Sink Base	Price
155538	ELUH3121L	30-3/4" x 21"	N/A	9-7/8"	3-1/2"	36"	

Kitchen Stainless Steel Sinks

Double Bowl Stainless Steel Kitchen Sinks (Continued)

Gourmet® Undermount SS Double Bowl Sink

Part #	Mfg #	Overall Size	Holes	Depth	Drain Opening	Min Sink Base	Price
134104	ELUH3220	31-1/4" x 20"	N/A	7-7/8"	3-1/2"	36"	
169877	ELUH322010PD	31-1/4" x 20"	N/A	10"	3-1/2"	36"	
144078	ELUHAQD3218	32-1/16" x 16-1/2"	N/A	8"	3-1/2"	36"	

Gourmet® Undermount Stainless Steel Equal Double Bowl Sink with Aqua Divide

- 19" Gauge
- Bright highlighted satin finish
- 4-7/8" High aqua divide
- Fully undercoated with pad(s)
- Drains not included



Part #	Mfg #	Overall Size	Holes	Depth	Drain Opening	Min Sink Base	Price
129305	EAQDUH3118	32-1/2" x 18-1/8"	N/A	8"	3-1/2"	36"	

Harmony™ Elumina Undermount SS Double Bowl Sink

- 18" Gauge
- Soft highlighted satin finish
- Sound guard undercoating
- Drains not included



Part #	Mfg #	Overall Size	Holes	Depth	Drain Opening	Min Sink Base	Price
161116	EGUH3119L	31-1/4" x 20"	N/A	8"	3-1/2"	36"	
055152	ELUH3119R	31-1/4" x 20"	N/A	7-1/2"	3-1/2"	36"	

Harmony™ Lustertone® Undermount SS Double Bowl Sink

- 18" Gauge
- Lustrous highlighted satin finish
- Sound guard undercoating
- Drains not included



Part #	Mfg #	Overall Size	Holes	Depth	Drain Opening	Min Sink Base	Price
086845	ELUH311910L	31-1/4" x 20"	N/A	10"	3-1/2"	36"	
068543	ELUH311910R	31-1/4" x 20"	N/A	10"	3-1/2"	36"	

Harmony™ Undermount SS Double Bowl Sink

- 18" Gauge
- Lustrous highlighted satin finish
- Sound guard undercoating
- **PD** models include:
-Two perfect drain kits



Part #	Mfg #	Overall Size	Holes	Depth	Drain Opening	Min Sink Base	Price
168914	ELUH31229RPD	32-3/4" x 21"	N/A	9"	3-1/2"	36"	
168445	ELUH32229PD	32-3/4" x 21-1/2"	N/A	9"	3-1/2"	36"	

Kitchen Stainless Steel Sinks

Harmony™ Slim Rim Dual-Mount SS Double Bowl Sink

- 18" Gauge
- Lustrous highlighted satin finish
- Sound guard undercoating
- 1 3/2L 2R faucet holes for self-rimming installation
- Includes:
-Two perfect drain kits



Part #	Mfg #	Overall Size	Holes	Depth	Drain Opening	Min Sink Base	Price
155790	LKHSR2509RPD3	33" x 22"	3	9"	3-1/2"	36"	

Triple Bowl Stainless Steel Kitchen Sinks

Gourmet® Lustertone® Self-Rimming SS Triple Bowl Sink

- 18" Gauge
- Lustrous highlighted satin finish
- 3 4 6 8 Faucet holes
- Fully undercoated
- Drains not included



Part #	Mfg #	Overall Size	Holes	Depth	Drain Opening	Min Sink Base	Price
149561	LTR46220	46" x 22"	0	7-5/8"	3-1/2"	51"	
146917	LTR46223	46" x 22"	3	7-5/8"	3-1/2"	51"	
109648	LTR46226	46" x 22"	6	7-5/8"	3-1/2"	51"	
168113	LTR46228	46" x 22"	8	7-5/8"	3-1/2"	51"	
128311	LTR5422103	54" x 22"	3	10-1/8"	3-1/2"	57"	

Harmony™ Lustertone® Undermount SS Triple Bowl Sink

- 18" Gauge
- Lustrous highlighted satin finish
- Sound guard undercoating
- Drains not included



Part #	Mfg #	Overall Size	Holes	Depth	Drain Opening	Min Sink Base	Price
043543	ELUH4020	40" x 20-1/2"	N/A	9-7/8"	3-1/2"	45"	

Stainless Steel Sink Cleaners

Stainless Butler Cleaner

- For day-to-day care of all of your stainless surfaces
- Cleans and polishes in one easy step
- Non-abrasive no-drip spray gel with fresh citrus scent



Part #	Mfg #	Overall Size	Holes	Depth	Drain Opening	Min Sink Base	Price
101381	LKSB16	(12) Spray Bottles					

Sinks

Kitchen Stainless Steel Sinks

Sink Accessories

Bottom Grids

Sinks

Part #	Mfg #	Overall Size	Holes	Depth	Drain Opening	Min Sink Base	Price
186065	CTOBG1215SS	Rear Center Drain Opening, Fits Crosstown™ Bowl Size 13-1/2" x 16-3/4"					
186378	CTOBG1315SS	Rear Center Drain Opening, Fits Crosstown™ Bowl Size 14-3/4" x 16-3/4"					
173331	GFOBG1217SS	Rear Center Drain Opening, Fits Crosstown™ Bowl Size 12" x 17"					
175902	GFOBG1517SS	Rear Center Drain Opening, Fits Crosstown™ Bowl Size 14-1/2" x 17"					
188296	GFOBG1717SS	Rear Center Drain Opening, Fits Crosstown™ Bowl Size 17" x 17"					
170598	GFOBG3017RSS	Right Rear Drain Opening, Fits Crosstown™ Bowl Size 30" x 17"					
154495	LKFOB1116SS	Rear Center Drain Opening, Fits Avado™ Bowl Size 11-1/2" x 16"					
181423	LKFOB1316SS	Rear Center Drain Opening, Fits Avado™ Bowl Size 13-1/2" x 16"					
165343	LKFOB1916SS	Rear Center Drain Opening, Fits Avado™ Bowl Size 19" x 16"					
167474	LKFOBG3218SS	Left Center Drain Opening, Fits Avado™ Bowl Size 32" x 18"					
225437	LKOBG1115SS	Rear Center Drain Opening, Fits Bowl Size 13-1/8" x 16-5/8"					
186383	LKWBG1519SS	Center Drain Opening, Fits Bowl Size 15-3/8" x 18-1/8"					
168918	LKWOBG1118SS	Rear Center Drain Opening, Fits Bowl Size 11" x 17-11/16"					
187276	LKWOBG1216SS	Rear Center Drain Opening, Fits Bowl Size 16-1/2" x 16-1/2"					
100563	LKWOBG1316SS	Center Drain Opening, Fits Bowl Size 13-1/2" x 16"					
124105	LKWOBG1417RSS	Rear Center Drain Opening, Fits Bowl Size 15-3/16" x 17-7/8"					
098158	LKWOBG1418SS	Rear Center Drain Opening, Fits Bowl Size 14" x 18"					
128624	LKWOBG1516SS	Rear Center Drain Opening, Fits Bowl Sizes 15-1/2" x 16-3/8" and 15-1/4" x 16-1/8"					
168446	LKWOBG1520LSS	Rear Center Drain Opening, Fits Bowl Size 14-1/2" x 18-1/2"					
168447	LKWOBG1520RSS	Rear Center Drain Opening, Fits Bowl Size 14-1/2" x 18-1/2"					
177773	LKWOBG1618SS	Rear Center Drain Opening, Fits Bowl Size 16" x 18"					
187274	LKWOBG1718SS	Rear Center Drain Opening, Fits Bowl Size 16-1/2" x 16-1/2"					
168916	LKWOBG1819SS	Rear Center Drain Opening, Fits Bowl Size 18" x 18-1/2"					
154525	LKWOBG2317SS	Rear Center Drain Opening, Fits Bowl Size 23" x 16-3/4"					
161793	LKWOBG2416SS	Rear Center Drain Opening, Fits Bowl Size 24" x 16"					
165311	LKWOBG2815RSS	Right Rear Corner, Fits Bowl Size 28" x 15-3/4"					
108131	LKWOBG2816SS	Rear Center Drain, Fits Bowl Size 28" x 16"					

Rinse Baskets

Part #	Mfg #	Overall Size	Holes	Depth	Drain Opening	Min Sink Base	Price
185151	LKFRB1316SS	Fits Avado™ Bowl Size 13-1/2" x 16"					
170310	LKFRB1418SS	Fits Avado™ Bowl Size 14" x 18"					
169788	LKFRB2816SS	Fits Avado™ Bowl Sizes 28" x 16" and 30-1/2" x 16"					
157244	LKWRB1318SS	Fits Bowl Size 13-1/2" x 18"					
186256	LKWRB1716SS	Fits Bowl Size 16-1/2" x 16-1/2"					

Cutting Boards

Part #	Mfg #	Overall Size	Holes	Depth	Drain Opening	Min Sink Base	Price
167786	CB912	Fits Bowl Size 12" x 9-1/4", 12" x 10", and 12" x 12"					
185025	LKCB2317HW	Fits Bowl Sizes 23" x 16-3/4"					
154125	LKCBF1116HW	Fits Avado™ Bowl Size 11-1/2" x 16"					
175873	LKCBF17HW	Fits Crosstown™ Sink Models					
167473	LKCBF3218HW	Fits Avado™ Bowl Size 32" x 18"					

Kitchen Stainless Steel Sinks

SinkMate™ Kits

SinkMate™ Kit with Hook, Sponge Holder, and Ledge

- *Stainless steel*
- *Includes:*
 - 17" Backing strip
 - Hook (LKEKHOOK)
 - Ledge (LKEKLEDGE)
 - Magnet (LKEKMAGNET)
 - Sponge holder (LKEKSPONGE)



Part #	Mfg #	Overall Size	Holes	Depth	Drain Opening	Min Sink Base	Price	
182938	LKSMHSL	For Any Size Sink Bowl, 8" x 4-13/16" x 3-5/8"						

Sinks

Kitchen Stainless Steel Sinks

Sinks

Dayton® Double Bowl Stainless Steel Sinks

Dayton® Elite Self-Rimming Double Bowl SS Sink

- 20" Gauge
- Elite satin finish
- 1 2 MR2 3 4 5 faucet holes
- Fully undercoated
- Drains not included



DSE-23322-4

Part #	Mfg #	Overall Size	Holes	Depth	Drain Opening	Min Sink Base	Price
173233	DSE233222	33" x 22"	2	8-1/16"	3-1/2"	36"	
041910	DSE233223	33" x 22"	3	8-1/16"	3-1/2"	36"	
049617	DSE233224	33" x 22"	4	8-1/16"	3-1/2"	36"	
175960	DSE233191	33" x 19"	1	8"	3-1/2"	36"	
163486	DSE233193	33" x 19"	3	8"	3-1/2"	36"	
187832	DSE23319MR2	33" x 19"	MR2	8"	3-1/2"	36"	
181900	DSE233214	33" x 21-1/4"	4	8-1/16"	3-1/2"	36"	

Dayton® Premium Dual-Mount Double Bowl SS Sink

- 18" Gauge
- Premium highlighted satin finish
- 1 2L 2R 3 faucet holes
- Slim Rim —ultra-thin edge virtually eliminates barrier between sink & countertop
- Fully undercoated
- R or L at end of model number indicates which side is larger on offset bowl
- Drains not included



Part #	Mfg #	Overall Size	Holes	Depth	Drain Opening	Min Sink Base	Price
166793	DPXSR2250R1	33" x 22"	1	8"	3-1/2"	36"	
177215	DPXSR2250R2R	33" x 22"	2R	8"	3-1/2"	36"	
166120	DPXSR233221	33" x 22"	1	8"	3-1/2"	36"	
169118	DPXSR233223	33" x 22"	3	8"	3-1/2"	36"	
160927	DPXSR233222R	33" x 22"	2R	8"	3-1/2"	36"	

Dayton® Premium Self-Rimming SS Double Bowl Sink

- 20" Gauge
- Premium highlighted satin finish
- 1 2 MR2 3 4 5 faucet holes
- Fully undercoated
- Drains not included



Part #	Mfg #	Overall Size	Holes	Depth	Drain Opening	Min Sink Base	Price
176755	DPC233221	33" x 22"	1	8-1/4"	3-1/2"	36"	
225763	DPC23322MR2	33" x 22"	MR2	8-1/4"	3-1/2"	36"	

Kitchen Stainless Steel Sinks

Dayton® Self-Rimming Equal Double Bowl SS Sink

- 22" gauge
- Satin finish
- Undercoated on bottom of bowls
- 1 2 MR2 3 4 5 faucet holes
- 1 3 4 Faucet holes (for model **22519** only)
- Drains not included



Sinks

Part #	Mfg #	Overall Size	Holes	Depth	Drain Opening	Min Sink Base	Price
155039	D225191	25" x 19"	1	6-1/4"	3-1/2"	30"	
006082	D225193	25" x 19"	3	6-1/4"	3-1/2"	30"	
004174	D225194	25" x 19"	4	6-1/4"	3-1/2"	30"	
170370	D233191	33" x 19"	1	6-7/16"	3-1/2"	36"	
004175	D233193	33" x 19"	3	6-7/16"	3-1/2"	36"	
004176	D233194	33" x 19"	4	6-7/16"	3-1/2"	36"	
154843	D233194	33" x 19"	4	6-7/16"	3-1/2"	36"	
004177	D233213	33" x 21-1/4"	3	6-1/2"	3-1/2"	36"	
004178	D233214	33" x 21-1/4"	4	6-1/2"	3-1/2"	36"	
161612	D233221	33" x 22"	1	6-9/16"	3-1/2"	36"	
141784	D23322MR2	33" x 22"	MR2	6-9/16"	3-1/2"	36"	
004179	D233223	33" x 22"	3	6-9/16"	3-1/2"	36"	
004180	D233224	33" x 22"	4	6-9/16"	3-1/2"	36"	
156270	GE233223	33" x 22"	3	5-3/8"	3-1/2"	36"	

Dayton® Self-Rimming Equal Double Bowl SS Sink

- 20" Gauge
- Satin finish
- 1 2 MR2 4 5 faucet holes
- Undercoated on bottom of bowls
- ADA compliant- **DG23322** only
- Drains not included



Part #	Mfg #	Overall Size	Holes	Depth	Drain Opening	Min Sink Base	Price
189983	DDG233224	33" x 22"	1	7-1/16"	3-1/2"	36"	
163536	DG233221	33" x 22"	1	6-3/8"	3-1/2"	36"	
180812	DG233223	33" x 22"	3	6-3/8"	3-1/2"	36"	

Dayton® Self-Rimming Equal Double Bowl SS Kitchen Sink

- 22" Gauge
- Satin finish
- 1 2 MR2 3 4 or 5 faucet holes
- Undercoated on bottom of bowls
- Drains not included



Part #	Mfg #	Overall Size	Holes	Depth	Drain Opening	Min Sink Base	Price
149510	DD233224	33" x 22"	1	7-1/16"	3-1/2"	36"	

Kitchen Stainless Steel Sinks

Sinks

Dayton® DXR Series Self-Rimming Double Bowl SS Sink

- 18 Gauge"
- Satin finish
- Fully undercoated
- 1 2 S2 3 4 faucet holes
- 1 2 MR2 3 4 5 faucet holes (**3322** model only)
- Drains not included



Part #	Mfg #	Overall Size	Holes	Depth	Drain Opening	Min Sink Base	Price
160655	DXR250R2	33" x 22"	2	8-1/8"	3-1/2"	36"	
181323	DXR250R3	33" x 22"	3	8-1/8"	3-1/2"	36"	
155919	DXR250RS2	33" x 22"	S2	8-1/8"	3-1/2"	36"	
156083	DXR33221	33" x 22"	1	8-3/16"	3-1/2"	36"	
156711	DXR33223	33" x 22"	3	8-3/16"	3-1/2"	36"	
141488	DXR33224	33" x 22"	4	8-3/16"	3-1/2"	36"	
175408	DXR3322MR2	33" x 22"	MR2	8-3/16"	3-1/2"	36"	

Dayton® Undermount Double Bowl SS Sink

- 18" Gauge
- Radiant satin finish
- Fully undercoated over pads
- Drains not included



Part #	Mfg #	Overall Size	Holes	Depth	Drain Opening	Min Sink Base	Price
123314	DXUH3118	31-3/4" x 18-1/4"	N/A	8"	3-1/2"	36"	

Dayton® Undermount Offset Double Bowl SS Kitchen Sink

- 18" Gauge
- Radiant satin finish
- Fully undercoated over pads
- L and R represents larger bowl
- Drains not included



Part #	Mfg #	Overall Size	Holes	Depth	Drain Opening	Min Sink Base	Price
146365	DXUH312010L	31-3/4" x 20-1/2"	N/A	10"	3-1/2"	36"	
140905	DXUH312010R	31-3/4" x 20-1/2"	N/A	10"	3-1/2"	36"	

Kitchen Stainless Steel Sinks

Dayton® Single Bowl Stainless Steel Sinks

Dayton® Elite Self-Rimming Single Bowl SS Kitchen Sink

- 20" Gauge
- Elite satin finish
- 1 2 MR2 3 4 or 5 faucet holes
- Fully undercoated
- Drains not included



Part #	Mfg #	Overall Size	Holes	Depth	Drain Opening	Min Sink Base	Price
106282	DSE125222	25" x 22"	2	8-1/16"	3-1/2"	30"	

Dayton® Self-Rimming Single Bowl SS Sink

- 22" Gauge
- Satin finish
- 1 2 MR2 3 4 5 faucet holes
- Undercoated on bottom of bowl
- Drains not included



Part #	Mfg #	Overall Size	Holes	Depth	Drain Opening	Min Sink Base	Price
166276	D125211	25" x 21-1/4"	1	6-1/2"	3-1/2"	30"	
090995	D125212	25" x 21-1/4"	2	6-1/2"	3-1/2"	30"	
004171	D125214	25" x 21-1/4"	4	6-1/2"	3-1/2"	30"	
004172	D125223	25" x 22"	3	6-1/2"	3-1/2"	30"	
004173	D125224	25" x 22"	4	6-1/2"	3-1/2"	30"	

Dayton® Self-Rimming Single Bowl SS Bar Sink

- 22" Gauge
- 23" Gauge (**D11515** & **D11516** models only)
- Satin finish
- 1 2 3 Faucet holes
- Undercoated on bottom of bowl
- Drains not included



D117213



D115152



D117193

Part #	Mfg #	Overall Size	Holes	Depth	Drain Opening	Min Sink Base	Price
004169	D115152	15" x 15"	2	5-1/8"	2"	18"	
146719	D115163	15" x 15"	3	5-1/8"	3-1/2"	18"	
061808	D117192	17" x 19"	2	6-1/8"	3-1/2"	21"	
033360	D117193	17" x 19"	3	6-1/8"	3-1/2"	21"	
068528	D117212	17" x 21-1/4"	2	6-1/2"	3-1/2"	21"	
004170	D117213	17" x 21-1/4"	3	6-1/2"	3-1/2"	21"	

Sinks

Kitchen Stainless Steel Sinks

Sinks

Dayton® Elite Dual-Mount Single Bowl SS Sink

- 20" Gauge
- Elite satin finish
- 1 2 MR2 3 4 5 faucet holes
- Slim Rim
- Fully undercoated
- Drains not included



Part #	Mfg #	Overall Size	Holes	Depth	Drain Opening	Min Sink Base	Price
172902	DSESR127224	27" x 22"	4	8"	3-1/2"	30"	
166175	DSESR12722MR 2	27" x 22"	MR2	8"	3-1/2"	30"	

Dayton® Premium Self-Rimming Single Bowl SS Sink

- 20" Gauge
- Premium highlighted satin finish
- 1 2 MR2 3 4 5 faucet holes
- Fully undercoated
- Drains not included



Part #	Mfg #	Overall Size	Holes	Depth	Drain Opening	Min Sink Base	Price
156591	DPC133221	33" x 22"	1	8"	3-1/2"	36"	
181285	DPC133223	33" x 22"	3	8"	3-1/2"	36"	
161518	DPC133224	33" x 22"	4	8"	3-1/2"	36"	
160830	DPC12522101	25" x 22"	1	10"	3-1/2"	30"	
170391	DPC12522103	25" x 22"	3	10"	3-1/2"	30"	

Dayton® Self Rimming Single Bowl SS Sink

- 22" Gauge
- Satin finish
- 1 2 MR2 3 4 5 faucet holes
- Drain opening in rear center (GE12521)
- Drain opening in right rear corner (GE12521R)
- Drain opening in left rear corner (GE12521L)
- Undercoated on bottom of bowl
- Drains not included



Part #	Mfg #	Overall Size	Holes	Depth	Drain Opening	Min Sink Base	Price
168552	GE125211	25" x 21-1/4"	1	5-3/8"	3-1/2"	30"	
151039	GE125213	25" x 21-1/4"	3	5-3/8"	3-1/2"	30"	

Kitchen Stainless Steel Sinks

Dayton® Self-Rimming SS Single Bowl Kitchen Sink

- 22" Gauge
- Satin finish
- 1 2 MR2 3 4 5 faucet holes
- Drain opening in left rear corner (GE12522L)
- Drain opening in right rear corner (GE12522R)
- Drain opening in rear center (GE12522)
- Undercoated on bottom of bowl
- Drains not included



Sinks

Part #	Mfg #	Overall Size	Holes	Depth	Drain Opening	Min Sink Base	Price
186996	GE12522RMR2	25" x 22"	MR2	5-3/8"	3-1/2"	30"	

Dayton® Undermount SS Single Bowl Sink with Round Edges

- 18" Gauge
- Radiant satin finish
- Fully undercoated with pad
- Drains not included



Part #	Mfg #	Overall Size	Holes	Depth	Drain Opening	Min Sink Base	Price
165803	DXUH2118	23-1/2" x 21-3/16"	N/A	8"	3-1/2"	27"	

Dayton® Undermount SS Single Bowl Sink

- 18" Gauge
- Radiant satin finish
- Fully undercoated over pad
- Drains not included



Part #	Mfg #	Overall Size	Holes	Depth	Drain Opening	Min Sink Base	Price
179775	DXUH1318	16" x 20-1/2"	N/A	8"	3-1/2"	21"	
120525	DXUH1618	16-1/2" x 18-1/4"	N/A	8"	3-1/2"	21"	
170263	DXUH2416	26-1/2" x 18-1/2"	N/A	8"	3-1/2"	30"	

Dayton® Sink Accessories

Bottom Grids

Part #	Mfg #	Size	Fits Bowl Sizes	Material
168887	GBG1318SS	Fits Bowl Size 13-1/2" x 15-3/16"		
177166	GBG1415SS	Fits Bowl Size 14" x 15-3/4"		
166121	GOBG1520LSS	Rear Center Drain Opening, Fits Bowl Size 14-1/2" x 18-1/2"		
166122	GOBG1520RSS	Rear Center Drain Opening, Fits Bowl Size 14-1/2" x 18-1/2"		

Kitchen Stainless Steel Sinks

Stainless Steel Kitchen Sinks Double Bowl Undermount Stainless Steel Sink



Part #	Mfg #	Overall Dimensions	Basin Depth	Holes	Bowls	Price
159969	G20273	20" x 17"	7.5"	NA		
160126	G18256	29-1/4" x 18-1/2"	7"	NA		
164469	G18265	34-1/4" X 20"	8"	NA		
176356	G18264	34-1/4" x 20"	10,8	NA		

1800 Single Bowl Stainless Steel Undermount Sink



Part #	Mfg #	Overall Dimensions	Basin Depth	Holes	Bowls	Price
187631	G18442	16" x 18"	10"	NA	Single	
164471	G18190	18" x 23"	8"	NA	Single	
173764	G18191	18" x 23"	8"	NA	Single	
181993	G18185	22" x 20"	8-1/2"	NA	Single	

2000 Single Bowl Stainless Steel Undermount Sinks

- 20 Gauge stainless steel
- Features SoundSHIELD™
- 3-1/2" Drain opening



Part #	Mfg #	Overall Dimensions	Basin Depth	Holes	Bowls	Price
225541	G20192	18" x 23"	7-1/2"	NA	Single	

1800 Undermount Stainless Steel Apron Front Sink

- 18 Gauge stainless steel
- Rear drain location
- Mounting brackets included, other standard mounting hardware and silicone sealant not included
- SoundSHIELD sound absorbing system
- Template number 22512



Part #	Mfg #	Overall Dimensions	Basin Depth	Holes	Bowls	Price
184851	G18121	30" x 21"	9"	NA	Single	
177121	G18220	30" x 21"	9"	NA	Double Equal	

Kitchen Stainless Steel Sinks

Double Bowl Drop In Stainless Steel Sink



Part #	Mfg #	Overall Dimensions	Basin Depth	Holes	Bowls	Price
167385	G202714	25" x 22"	7"	4	Double Offset	
170178	G202721	25" x 18-3/4"	7"	1	Double Offset	

2000 Double Bowl Drop In Stainless Steel Sink

- 22 Gauge stainless steel, brushed finish
- Center drain
- U-channel mounting system, hardware included
- Up to 1-1/8" max deck thickness
- Includes SoundShield sound absorbing system



Part #	Mfg #	Overall Dimensions	Basin Depth	Holes	Bowls	Price
184032	G222133	33" x 22"	8"	3	Double Equal	
170651	G222134	33" x 22"	8"	4	Double Equal	

2000 Single Bowl Drop In Stainless Steel Sink

- 20 Gauge stainless steel
- Center drain, 3-1/2" opening
- Features SoundSHIELD™ sound absorbing system



Part #	Mfg #	Overall Dimensions	Basin Depth	Holes	Bowls	Price
188125	G201961	25" x 22"	7"	1	Single	

2000 Single Bowl Stainless Steel Sink with Faucet

- 20 Gauge stainless steel
- Center drain
- U-Channel mounting system, hardware included
- SoundSHIELD sound absorbing system
- Sealite integrated drain assembly included
- Faucet sku #4904



Part #	Mfg #	Overall Dimensions	Basin Depth	Holes	Bowls	Price
211072	TG2045522	16-5/8" x 17-5/16"	5.5"	2-Hole w/ Faucet	Single	

Floor Sinks

Floor Sinks

Square Top Sanitary Floor Sink

- 8" Square top x 6" Deep sink
- Sink has white porcelain enamel-coated interior
- Loose set porcelain enamel-coated cast iron grate
- Aluminum dome bottom strainer
- Options:
 - Suffix P = Push-on outlet
 - Suffix 1 = Nickel bronze top
 - Suffix 22 = Less grate
 - Suffix 175 = 3/4" Grate



Part #	Mfg #	Description	Price
076231	FS-712-P-22	For 2" Pipe	
106212	FS-713-P-1-175	For 3" Pipe	
080485	FS-713-P-22	For 3" Pipe	

Large Square Top Sanitary Floor Sink

- 12" Square top x 6" Deep sink
- Sink has white porcelain enamel-coated interior
- Loose set enamel-coated cast iron grate
- Aluminum dome bottom strainer
- Options:
 - Suffix P = Push-on outlet
 - Suffix 22 = Less grate



Part #	Mfg #	Description	Price
046245	FS-732-22	For 2" Pipe	
046242	FS-732-P-22	For 2" Pipe	
046246	FS-733-22	For 3" Pipe	
046243	FS733-P-22	For 3" Pipe	
046247	FS-734-22	For 4" Pipe	
046244	FS734-P-22	For 4" Pipe	

Deep Sanitary Floor Sink

- 12" Square top x 8" Deep sink
- Sink has white porcelain enamel-coated interior
- Loose set porcelain enamel-coated cast iron grate
- Aluminum dome strainer
- Options:
 - Suffix P = Push-on outlet
 - Suffix 22 = Less grate



Part #	Mfg #	Description	Price
097024	FS-744-P-22	For 4" Pipe	

Components for Floor Drains

Grate/Top Assembly

Part #	Mfg #	Description	Price
073688	FG-8NB	Full Grate, 8" x 8", NB	
082078	FG-12NB-1/2	8" sq NB 1/2 Grate Top Assembly for FS-710	
046248	FG-12	Full Grate, 12" x 12"	
046249	FG-12-1/2	1/2" Grate, 12" x 12"	
046250	FG-12-3/4	3/4" Grate, 12" x 12"	
063595	FS-DS	Dome Strainer	

Sinks

Mop & Utility Sinks

Vitreous China

Camerton™ Wall-Mount Blow-Out Service Sink—25" x 21-1/2"

- No faucet holes
- Blow-out action flushing rim



Part #	Mfg #	Overall Dimensions	Bowl Depth	Holes	Color	Price
070981	K-12867-0	25" x 21-1/2"	-	-	White	

Gilford™ Wall-Mount Scrub-Up/ Plaster Utility Sink

- 30" x 22"
- Back drilled on 8" centers



Part #	Mfg #	Overall Dimensions	Bowl Depth	Holes	Color	Price
099693	K-12787-0	30" x 22"	8-5/8"	2	White	

Cast Iron Utility Sinks

Bannon™ Wall-Mounted or P-Trap Service Sink

- 22-1/4" x 18-1/4"
- (K-6716 & K-6719) 24" x 20-1/4"
- Without overflow
- Back drilled on 8" centers
- Includes rim guard for added durability
- Blank black included with (K-6718-0) model



Part #	Mfg #	Overall Dimensions	Bowl Depth	Holes	Color	Price
059232	K-6714-0	22-1/4" x 18-1/4"	12"	3	White	
059232	K-6716-0	24" x 20-1/4"	12"	3	White	
053473	K-6718-0	22-1/4" x 18-1/4"	12"	0	White	
059515	K-6719-0	24" x 20-1/4"	12"	0	White	

Brockway™ 3' Wall-Mounted Wash Sink

- Without overflow
- 36" x 17-1/2" x 15-5/8"
- Acid resistant enamel finish
- Drilled for three K-8892 Cannock™ faucets and two K-8880 soap dishes



Part #	Mfg #	Overall Dimensions	Bowl Depth	Holes	Color	Price
078907	K-3200-0	36" x 17-1/2"	7"	2	White	

* Vibrant Limited Lifetime Warranty

www.plumbsupply.com • Serving our Customers Since 1946 • www.waterconcepts.net

Mop & Utility Sinks

Brockway™ 4' Wall-Mount Wash Sink

- Without overflow
- 48" x 17-1/2" x 15-5/8"
- Acid resistant enamel finish
- Drilled for three K-8892 Cannock™ faucets and two K-8880 soap dishes



Part #	Mfg #	Overall Dimensions	Bowl Depth	Holes	Color	Price
142733	K-3202-0	48" x 17-1/2"	7"	2	White	

Brockway™ 5' Wall-Mounted Wash Sink

- Without overflow
- 60" x 17-1/2" x 15-5/8"
- Acid resistant enamel finish
- Drilled for three K-8892 Cannock™ faucets and two K-8880 soap dishes



Part #	Mfg #	Overall Dimensions	Bowl Depth	Holes	Color	Price
055217	K-3203-0	60" x 17-1/2"	7"	6	White	

Glen Falls™ Dual-Mount Utility Sink

- 21-1/2" x 15-1/2"
- 13" depth
- 27" minimum base cabinet if installed as top-mount or under-mount
- Includes cutout templates
- Under-mount installation kit not included



Part #	Mfg #	Overall Dimensions	Bowl Depth	Holes	Color	Price
188398	K-19017-3-FD	21-1/2" x 15-1/2"	13"	3	Cane Sugar	

Park Falls™ Top-Mount/Under-Mount Utility Sink

- 22" x 10-1/2"
- Fits minimum 21-inch base cabinet if installed as top-mount.
- Fits minimum 24-inch base cabinet if installed as under-mount.
- 12-1/2-inch depth provides generous workspace.
- Small size fits compact spaces.



Part #	Mfg #	Overall Dimensions	Bowl Depth	Holes	Color	Price
178009	K-19022-1-0	22" x 10-1/2"	12-1/2"	1	White	
183494	K-19022-3-0	22" x 10-1/2"	12-1/2"	3	White	

River Falls™ Top-Mount Utility Sink

- 25" x 22"
- 27" Minimum base cabinet width
- Available with 1, 2, 3, or 4 faucet holes
- Includes wire rack and soaking pan



Part #	Mfg #	Overall Dimensions	Bowl Depth	Holes	Color	Price
112532	K-6657-1-0	25" X 22"	14-1/4"	1	White	
145991	K-6657-1-96	25" X 22"	14-1/4"	1	Biscuit	
186189	K-6657-1-FF	25" x 22"	14-1/4"	1	Sea Salt	
153802	K-6657-1-G9	25" X 22"	14-1/4"	1	Sandbar	

* Vibrant Limited Lifetime Warranty

www.waterconcepts.net • Serving our Customers Since 1946 • www.plumbsupply.com

Mop & Utility Sinks

Cast Iron Utility Sinks (Continued) River Falls™ Top-Mount Utility Sink

Part #	Mfg #	Overall Dimensions	Bowl Depth	Holes	Color	Price
140388	K-6657-2-0	25" X 22"	14-1/4"	2	White	
124462	K-6657-2-96	25" X 22"	14-1/4"	2	Biscuit	
055713	K-6657-3-0	25" X 22"	14-1/4"	3	White	
090281	K-6657-3-47	25" X 22"	14-1/4"	3	Almond	
067756	K-6657-3-96	25" X 22"	14-1/4"	3	Biscuit	
073686	K-6657-3-G9	25" X 22"	14-1/4"	3	Sandbar	
116906	K-6657-3R-0	25" X 22"	14-1/4"	3R	White	
160635	K-6657-4-0	25" X 22"	14-1/4"	4	White	

River Falls™ Under-Mount Utility Sink

- 22" x 22"
- 27" Minimum base cabinet width
- 4 oversized faucet holes
- Includes white soaking pan and wire rack



Part #	Mfg #	Overall Dimensions	Bowl Depth	Holes	Color	Price
134385	K-6657-4U-0	25" X 22"	14-1/4"	4U	White	
153405	K-6657-4U-7	25" X 22"	14-1/4"	4U	Black	
154374	K-6657-4U-96	25" X 22"	14-1/4"	4U	Biscuit	

Glen Falls™ Top-Mount Utility Sink

- 25" x 22"
- 27" Minimum base cabinet with
- Available with 1, 2, or 3 faucet holes



K-19017 Dual-Mount

Part #	Mfg #	Overall Dimensions	Bowl Depth	Holes	Color	Price
179617	K-19017-1-0	25" X 22"	13-5/8"	1	White	
224067	K-19017-3-0	25" X 22"	13-5/8"	3	White	
187475	K-19017-1-96	25" X 22"	13-5/8"	1	Biscuit	
188033	K-19017-1-FF	25" X 22"	13-5/8"	1	Sea Salt	

Harborview™ Top-Mount or Wall-Mount Utility Sink

- 48" x 28"
- 50" Minimum base cabinet width
- Available with 1,3, or 4 faucet holes
- Integral apron and backsplash
- Can be wall-mounted with K-6617 legs (sold separately)



Part #	Mfg #	Overall Dimensions	Bowl Depth	Holes	Color	Price
182865	K-6607-1-0	48" X 28"	10"	1	White	

* Vibrant Limited Lifetime Warranty

www.plumbsupply.com • Serving our Customers Since 1946 • www.waterconcepts.net

Mop & Utility Sinks

Cast Iron Utility Sinks (Continued)

Harborview™ Top-Mount or Wall-Mount Utility Sink

Part #	Mfg #	Overall Dimensions	Bowl Depth	Holes	Color	Price
102524	K-6607-1-47	48" X 28"	10"	1	Almond	
081328	K-6607-1-96	48" X 28"	10"	1	Biscuit	
082659	K-6607-4-0	48" X 28"	10"	4	White	

Tyrell™ Floor-Mounted Siphon-jet Flushing Rim Service Sink

- 21" x 27-1/8"
- 2-1/2" Trapway
- Large basin allows placement of more volume
- 1-1/2" Top spud



Part #	Mfg #	Overall Dimensions	Bowl Depth	Holes	Color	Price
058657	K-6676-0	21" x 27-1/8"	20"	-	White	

Whitby™ Floor-Mounted Corner Service Sink

- 28" x 28"
- Without overflow
- Rim guard is not included
- Acid-resistant enamel finish



Part #	Mfg #	Overall Dimensions	Water Depth	Holes	Color	Price
060839	K-6710-0	28" x 28"	6-3/4"	Less Holes	White	

Stainless Steel Utility Sinks

Ballad™ Top-Mount Utility Sink

- 25" x 22"
- 18 Gauge stainless steel
- SilentShield® sound-absorption technology
- 27" Minimum base cabinet width



Part #	Mfg #	Overall Dimensions	Bowl Depth	Holes	Color	Price
223325	K-5798-1-NA	25" x 22"	11-5/8"	1	Single	
185531	K-5798-3-NA	25" x 22"	11-5/8"	3	Single	

Undertone® Under-Mount Utility Sink

- 23" x 17-1/2"
- 18 Gauge stainless steel
- SilentShield® sound-absorption technology
- 27" Minimum base cabinet width



Part #	Mfg #	Overall Dimensions	Bowl Depth	Holes	Color	Price
119414	K-6661-NA	23" x 17-1/2"	11-1/4"	-	Single	

* Vibrant Limited Lifetime Warranty

www.waterconcepts.net • Serving our Customers Since 1946 • www.plumbsupply.com

Mop & Utility Sinks

Service Sink Drains

Adjustable Trap With Cleanout Plug and Strainer



		Description
053474	K-6672-NA	Adjustable Trap for 2" Iron Pipe Connection
053194	K-6673-NA	Adjustable Trap for 3" Iron Pipe Connection

Mop and Utility Sink Accessories

Whitby™ Sink Rim Guard Coated Wire

- Durable coated wire construction
- For use with the K-6710 Whitby service sink



Part #	Mfg #	Overall Dimensions	Bowl Depth	Holes	Color	Price
078257	K-8940-NA	29-1/2" x 5-3/4"	3-7/16"	Wire		

Kitchen Sink Utility Rack

- Nonslip coating
- Dishcloth rail
- Dishwasher safe
- Removable soaking cup
- Rust-resistant stainless steel
- Expands 3 inches to fit most sinks



Part #	Mfg #	Description	Price
228562	K-5473-0	White	

* Vibrant Limited Lifetime Warranty

www.plumbsupply.com • Serving our Customers Since 1946 • www.waterconcepts.net

Mop & Utility Sinks

Vikrell® Utility Sinks

- Compression molded from solid Vikrell™ material
- Double high gloss finish



Latitude® Self-Rimming Utility Sink

- Unique design features a quarter deck; perfect for cleaning smaller items
- Slight outside curves add a style dimension not found in other utility sinks
- Bond surface texture maintains a superior stain and scratch resistance
- Drill marks provided for drilling the faucet holes
- CSA Certified
- Faucet sold separately



Part #	Mfg #	Dimensions	Color	Price
102432	995-0	25" x 22" x 12"	White	
102433	995-47	25" x 22" x 12"	Almond	
102434	995-96	25" x 22" x 12"	Biscuit	

Latitude® Undercounter Utility Sink

- Unique design features a quarter-deck; perfect for cleaning smaller items
- Slight outside curves add a style dimension not found in other utility sinks
- Bond surface texture maintains a superior stain and scratch resistance
- Drill marks provided for drilling the faucet holes
- CSA Certified
- Faucet sold separately



Part #	Mfg #	Dimensions	Color	Price
123091	995-U-0	25" x 22" x 12"	White	
118165	995-U-96	25" x 22" x 12"	Biscuit	

Latitude® Self-Rimming/Undercounter Utility Sink with Stand

- Durable bond finish
- Gray powder-coated steel stand
- Includes foot levelers and wall brackets
- Lifetime limited warranty



Part #	Mfg #	Dimensions	Color	Price
112446	996-0	25" x 22" x 36"	White	

Vikrell® Utility Sinks (Continued)

Latitude® Self-Rimming/Undercounter Utility Sink with Stand

Part #	Mfg #	Dimensions	Color	Price
113845	996-96	25" x 22" x 36"	Biscuit	

Sinks

Mop & Utility Sinks

Stainless Steel Laundry Sinks

Stellar™ Single Bowl Undermount Laundry Sink

- 304 Series, 18 gauge stainless steel
- 18/10 Chrome/nickel content
- Refined brushed finish
- Center drain placement
- Sound deadening insulation and pads
- Deep functional bowl design



Part #	Mfg #	Finish	Bowl Depth	Overall Size	Cabinet Size	Drain Dia	Price
160335	441398	Stainless Steel	12"	23" x 17-3/4"	27"	3-1/2"	

Essential™ Single Bowl Drop-In Laundry Sink

- 304 Series, 18 gauge stainless steel
- 18/10 chrome/nickel content
- Brushed satin finish
- Sound deadening pads



Part #	Mfg #	Finish	Bowl Depth	Overall Size	Cabinet Size	Drain Dia	Price
151577	441078	Stainless Steel	1-Hole, 12"	25" x 22"	24"	3-1/2"	
158134	441400	Stainless Steel	3-Hole, 12"	25" x 22"	24"	3-1/2"	

Sinks

Mop & Utility Sinks

Durastone® Laundry Tubs

- Made with Durastone® - combination of fiberglass and crushed stone blended with special resins for extra strength and durability, marbled white

10C Durastone® Countertop Utility Sink

- 17 Gallon capacity
- 13-3/4" Extra deep self-rimming bowl
- Accommodates single or dual-handle faucet with 4" or 8" centers
- Hooks up to standard 1-1/2" P- or S-trap
- Stain resistant, semi-gloss, colorfast finish
- (10) Includes 1-1/2" drain assembly w/ stopper
- (10C) 3-1/2" Reinforced drain opening - fits standard basket drain assembly



Part #	Mfg #	Size	Holes	Capacity	Mounting	Price
007482	10	25"W x 22"L	2 (4"cc or 8"cc)	17 gal	Drop-In	
041226	10C	25"W x 22"L	2 (4"cc or 8"cc)	17 gal	Drop-In	

17F & 17W Utilatub® Durastone® Laundry Tub

- Sturdy, 1-piece, extra deep molded tub
- 13" Deep
- Built in scrub board
- Leakproof, integrally molded-in drain with stopper
- Hooks up to standard 1-1/2" P- or S-trap
- Floor model includes adjustable leg levelers
- Wall model includes wall mounting bracket, side supports and hardware for securing tub to concrete or stud wall
- Smooth surface, rust resistant

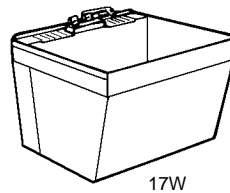

Part #	Mfg #	Size	Holes	Capacity	Mounting	Price
007493	17W	23"W x 23-1/2"L	(2) 4"cc	19 gal	Wall	
007492	17F	23"W x 23-1/2"L	(2) 4"cc	19 gal	Floor	

18F & 18W Utilatub® Durastone® Laundry Tub

- Sturdy, 1-piece, extra deep molded tub
- 13" Deep with smooth surface
- Leakproof, integrally molded-in drain with stopper
- Hooks up to standard 1-1/2" P- or S-trap
- Floor model includes adjustable leg levelers
- Wall model includes wall mounting bracket, side supports and hardware for securing tub to concrete or stud wall



Part #	Mfg #	Size	Holes	Capacity	Mounting	Price
017774	18W	20"W x 24"L	(1 or 2) 4"cc or 8"cc	19 gal	Wall	
007496	18F	20"W x 24"L	(1 or 2) 4"cc or 8"cc	19 gal	Floor	

Sinks

Mop & Utility Sinks

26F & 26W Utilatwin® Durastone® Laundry Tub

- Sturdy, 1-piece, extra deep molded tub
- Includes twin drain waste connector - joins drain assemblies, assures rapid and uniform discharge of waste water, washers, slip nuts and stoppers provided
- 13" Deep
- Hooks up to standard 1-1/2" P- or S-trap
- Floor model includes adjustable leg levelers
- Wall model includes wall mounting bracket, side supports and hardware for securing tub to concrete or stud wall
- Smooth surface, rust resistant



Sinks

Part #	Mfg #	Size	Holes	Capacity	Mounting	Price
007501	26W	40"W x 24"L	(1 or 2) 4"cc or 8"cc	19 gal	Wall	
007500	26F	40"W x 24"L	(1 or 2) 4"cc or 8"cc	19 gal	Floor	

Laundry & Utility Tubs

28CF BigTub™ Utilatub® Combo Utility Tub

- Molded 1-piece tub
- Impact-resistant polypropylene with heavy gauge steel legs
- Adjustable levelers
- Swivel faucet with 24" long pull-out spout and lever handles
- 1-1/2" P-trap with 12" tailpiece
- (2) 20" Flexible braided supply lines
- Drain stopper for 1-1/2" molded-in drain
- Large, self-draining back shelf
- Mold and mildew-resistant components
- Color-fast, stain-resistant white finish
- Inside dimensions: 36-1/2"W x 12-1/2"L x 17-1/2"D



Part #	Mfg #	Size	Mounting	Price
143590	28CF	40"W x 24"L	Floor	

Mop & Utility Sinks

Veritek® Laundry Tubs

MF-1 Veritek® Single Laundry Tub

- Made of sturdy Veritek® with no surface coating to chip or crack
- (2) Molded-in self-draining soap dishes, drain assemblies, stopper, molded in washboard and hardware
- Pre-punched centers and pre-installed drain
- Kit includes:
 - (1) Tub
 - (4) Angular legs
 - Hardware or wall bracket assembly
- 1-Year limited warranty



Floor-Mount



Wall-Mount

Part #	Mfg #	Dimension	Holes	Depth	Description	Price
037020	MF-1F	22-7/8"W x 23-3/8"D	(2) 4"cc	13"	Floor-Mount	
037021	MF1W	22-7/8"W x 23-3/8"D	(2) 4"cc	13"	Wall-Mount	

Veritek® Drop-In Fiberglass Tub

- 17-1/2 Gallon capacity
- Made of sturdy Veritek® with no surface coating to chip or crack
- Will not mold or mildew
- Flat deck for a variety of faucet applications
- Installs into countertop for an upgrade laundry room
- 4" & 8" Centers marked but not drilled



Part #	Mfg #	Dimension	Color	Price
022763	DIT	25" x 22"	White	
022764	DIT-037	25" x 22"	Bone	
066484	DIT-018	25" x 22"	Bisque	

Veritek® Small Drop-In Fiberglass Tub

- 7 Gallon capacity
- Made of sturdy Veritek® with no surface coating to chip or crack
- Will not mold or mildew
- Flat deck for a variety of faucet applications
- Compact size
- 4" & 8" Centers marked but not drilled



Part #	Mfg #	Dimension	Color	Price
028569	DITS	17-1/4" x 20"	White	
068568	DIT-S-018	17-1/4" x 20"	Bisque	

Laundry Tub Accessories

Part #	Mfg #	Description	Price
066990	IP31010002	Wall Mount Kit for MF-1 Series Laundry Tubs	

Mop & Utility Sinks

Laundry Tubs

Wall-Mount Serv-A-Sink® Laundry Tub

- Single compartment, molded-stone
- Heavy-gauge, galvanized wall bracket
- Side fillers white molded plastic polymers



Part #	Mfg #	Dimension	Holes	Capacity	Color	Price
035540	L-1	23"W x 22"D	(2) 4"cc	20 gal	White	

Floor-Mount Serv-A-Sink® Laundry Tub

- Single compartment, molded-stone
- White baked enamel legs and leveling feet



Part #	Mfg #	Dimension	Holes	Capacity	Color	Price
082152	FL-1	23"W x 22"D	(2) 4"cc	20 gal	White	

Sinks

Mop & Utility Sinks

Mop Service Sinks

- Up to three times stronger than a molded stone type product
- Each unit includes a cast brass drain in either 2" or 3" IPS with a stainless steel dome strainer and lint basket



Part #	Mfg #	Description	Price
023793	MS-2424-3-010	24" x 24" White with 3" Drain	

Accessories

Part #	Mfg #	Description	Price
044027	MS-2410	3" to 2" Rubber Drain Adapter	

Sinks

Mop & Utility Sinks

Durastone® Mop Basins

- White 1-piece molded construction
- Integrally molded drain with seal
- Model 65M has elevated self-draining shelf
- Meets or exceeds ANSI specifications Z124.2 and 124.6

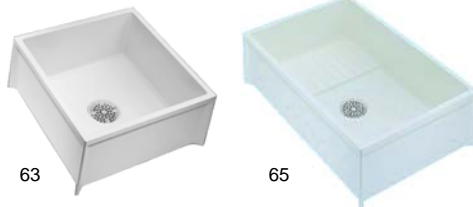

Part #	Mfg #	Size	IPS	Price
028428	63M	10"H x 24"W x 24"L	3"	
028429	65M	10"H x 36"W x 24"L	3"	

Mop Basin Accessories

Part #	Mfg #	Description	Price
028535	65.308	2" Drain Seal for 63M	

Sinks

Mop & Utility Sinks

Mop Basins

Terrazzo Mop Service Basin

- Terrazzo is made of marble chips cast in grey portland cement



TSB-100

TSBC-1610

TSB-3000

Part #	Mfg #	Description	Price
004342	TSB-100	24" x 24" x 12" w/SS Caps on Curbs	
053122	TSBC-1610	24" x 24" x 12" w/6" Drop Front Neo-Corner	
096028	TSB-3000	24" x 24" x 12", 6" Drop Front w/SS Caps on Curbs	

Mop Service Basin

- Molded-Stone® product
- 10" High walls and not less than 1" wide shoulders
- Stainless steel drain body
- Stainless steel combination dome strainer and lint basket



Part #	Mfg #	Description	Price
139126	MSBID2424	24" x 24" x 10" w/Integral Drain	
035937	MSB3624	36" x 24" x 10"	

Mop Service Basin Optional Equipment

Bumper Guard

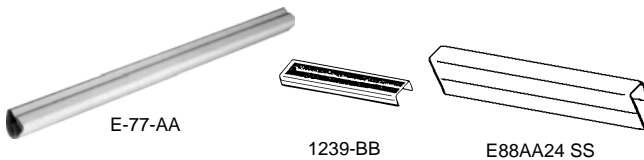

E-77-AA

1239-BB

E88AA24 SS

Part #	Mfg #	Description	Price
019904	E77AA-24	24" Vinyl Bumper Guard	
036477	E77AA-36	36" Vinyl Bumper Guard	
093129	1239BB24	24" Aluminum Bumper Guard	
032989	E88AA24 SS	24" Stainless Steel Bumper Guard	

Wall Guard

- Stainless steel

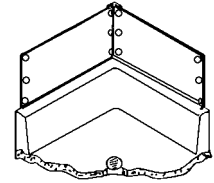

Part #	Mfg #	Description	Price
019906	MSG-2424	24" x 24" Wall Guards	
075666	MSG-3624	36" x 24" Wall Guards	

Quick Drain Connector

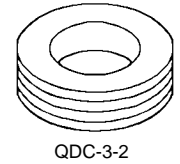

Part #	Mfg #	Description	Price
141765	QIC32	2"	
057001	QDC-3-2	Facilitates Connection of 2" Pipe to 3" Drain	
141767	QIC3SN	3", for Cast Iron Soil Pipe	

Sealant

Part #	Mfg #	Description	Price
029794	833-AA	Silicone Sealant	

Strainers

Part #	Mfg #	Description	Price
034416	1453-BB	Flat Strainer Plate	

Deck Type Faucets

- 6-3/4" Threaded spout



Part #	Mfg #	Description	Price
040737	A-1	4" Centers	

Service Faucet Accessories



Part #	Mfg #	Description	Price
019903	832-AA	Hose & Hose Bracket	
020373	889-CC	Mop Hanger Bracket	

Mop & Utility Sinks

830-AA Group Replacement Assembly Parts



Part #	Mfg #	Description	Price
104739	GRA-07	Vacuum Breaker & Disc Assembly	

Mop & Utility Sinks

Sinks

Stainless Steel Laundry Sinks

Gourmet® Lustertone® Self-Rimming Single Bowl SS Laundry Sink

- 18" Gauge
- Lustrous highlighted satin finish
- 1 2 MR2 3 OS4 faucet holes
- Fully undercoated
- **DLR191910EK3** includes e-dock hook



Part #	Mfg #	Overall Size	Holes	Depth	Drain Opening	Min Sink Base	Price
150926	DLR1919101	19-1/2" x 19"	1	10-1/8"	3-1/2"	24"	
088763	DLR1919103	19-1/2" x 19"	3	10-1/8"	3-1/2"	24"	

Gourmet® Celebrity Self-Rimming Stainless Steel Single Bowl Laundry Sink

- 20" gauge
- Brushed satin finish
- 1 2 MR2 3 OS4 faucet holes
- Fully undercoated



Part #	Mfg #	Overall Size	Holes	Depth	Drain Opening	Min Sink Base	Price
118554	ESE2020101	20" x 20"	1	10-1/8"	3-1/2"	24"	

Dayton® Premium Self-Rimming SS Single Bowl Laundry Sink

- 20" Gauge
- Premium highlighted satin finish
- 1 2 MR2 3 OS4 faucet holes
- Fully undercoated
- Drains not included



Part #	Mfg #	Overall Size	Holes	Depth	Drain Opening	Min Sink Base	Price
168295	DPC12020101	20" x 20"	1	10"	3-1/2"	24"	
165034	DPC12020102	20" x 20"	2	10"	3-1/2"	24"	
179920	DPC12020103	20" x 20"	3	10"	3-1/2"	24"	

Commercial Wash-Up SS Wall-Mount Lavatory Sink with Overflow

- 18" Gauge
- Buffed satin
- 1 3 CS3 faucet holes
- 1-3/4" Coved corners
- 2-1/2" High backsplash & apron front and sides
- Front and side decks with raised rim
- Rear centered outlet
- Meets ADA requirements
- Sound absorbing pads



No Faucet Holes



Part #	Mfg #	Overall Size	Holes	Depth	Drain Opening	Min Sink Base	Price
114286	ELV2219CS3	22" x 19"	CS3	5-1/2"	1-5/8"	N/A	

Mop & Utility Sinks

Stainless Steel Service and Utility Scullery Sinks

Sturdibilt® Service and Utility SS Single Compartment Scullery Sink

- 14" Gauge
- Lustrous satin finish
- Drainboards not included
- Square corner welded compartment construction
- Channel rim design with 2" apron
- Straight line styling
- 8" High, full length backsplash with 45° slope
- 14" Deep compartments
- Sink compartments pitched to drain
- Sink supported on (4) LK251 adjustable tubular legs
- 1-5/8" O.D. with up to 1" adjustable bullet shaped feet



Sinks

Part #	Mfg #	Overall Size	Holes	Depth	Drain Opening	Min Sink Base	Price
156815	SS81362	27-1/2" x 39"	36"	14"	3-1/2"		

Sturdibilt® Service and Utility SS Double Compartment Scullery Sink

- 14" Gauge
- Lustrous satin finish
- Drainboards not included
- Square corner welded compartment construction
- Channel rim design with 2" apron
- Straight line styling
- 8" High, full length backsplash with 45° slope
- 14" Deep compartments
- Sink compartments pitched to drain
- Sink supported on (4) LK251 adjustable tubular legs
- 1-5/8" O.D. with up to 1" adjustable bullet shaped feet



Part #	Mfg #	Overall Size	Holes	Depth	Drain Opening	Min Sink Base	Price
173638	SS82362	39" x 27-1/2"	36"	14"	3-1/2"		

Sturdibilt® Service and Utility SS Double Compartment Scullery Sink with Drainboard

- 14" Gauge
- Buffed satin finish
- Left or right drainboard
- Drainboard and sink compartments pitched to drain
- Square corner welded compartment construction
- Channel rim design with 2" apron
- Straight line styling
- 8" Backsplash with 45° slope
- Sink supported on (4) LK251 adjustable tubular legs
- 1-5/8" O.D. with up to 1" adjustable bullet shaped steel feet



Part #	Mfg #	Overall Size	Holes	Depth	Drain Opening	Min Sink Base	Price
173636	SS8236L2	61-1/2" x 27-1/2"	36"	14"	3-1/2"		

Mop & Utility Sinks

Sinks

Sturdibilt® Service and Utility SS Double Compartment Scullery Sink with Drainboard

- 14" Gauge
- Buffed satin finish
- Left and right drainboard
- Drainboard and sink compartments pitched to drain
- Square corner welded compartment construction
- Channel rim design with 2" apron
- Straight line styling
- 8' Backsplash with 45° slope
- Sink supported on (4) LK251 adjustable tubular legs
- 1-5/8" O.D. with up to 1" adjustable bullet shaped steel feet



Part #	Mfg #	Overall Size	Holes	Depth	Drain Opening	Min Sink Base	Price
173637	SS8260LR2	108" x 27-1/2"	36"	14"	3-1/2"		

Commercial Foodservice Budget Series Utility SS Single Compartment Scullery Sink

- 18" Gauge
- Welded construction
- 8" backsplash
- Drainboards not included
- 1-1/2" Edge rim design
- Basket strainers included with drain
- 1-5/8" galvanized legs with 1" adjustable feet



Part #	Mfg #	Overall Size	Holes	Depth	Drain Opening	Min Sink Base	Price
177850	B1C18X180X	21" x 21.5"	42"	12"	3-1/2"		
172990	B1C18X210X	21" x 24.5"	42"	12"	3-1/2"		
190455	B1C24X240X	27" x 27.5"	42"	12"	3-1/2"		

Commercial Foodservice Utility SS Double Compartment Scullery Sink

- 18" Gauge
- Welded construction
- Drainboards not included
- 8" Backsplash
- 1-1/2" Edge rim design
- Basket strainers included with drain
- 1-5/8" Galvanized legs with 1" adjustable feet



Part #	Mfg #	Overall Size	Holes	Depth	Drain Opening	Min Sink Base	Price
188327	B2C4X240X	51" x 27.5"	42"	12"	3-1/2"		

Mop & Utility Sinks

Commercial Stainless Steel Wall Service Sinks

Commercial Stainless Steel Single Bowl Wall Service Sink with No Faucet Holes

- 14" Gauge
- Buffed satin finish
- 1-3/4" Coved corners
- 1-1/2" Rolled rims
- 12" backsplash
- Includes wall hanger and stainless steel support brackets



Sinks

Part #	Mfg #	Overall Size	Holes	Depth	Drain Opening	Min Sink Base	Price
176328	ESS25200	25" x 19-1/2"	12"	12"	3-1/2"		

Commercial Stainless Steel Wall Service Sink

- 14" Gauge
- Buffed satin finish
- 1-3/4" Coved corners
- 1-1/2" Rolled rims
- 12" High backsplash
- Includes wall hanger and stainless steel support brackets



Part #	Mfg #	Overall Size	Holes	Depth	Drain Opening	Min Sink Base	Price
087323	ESS23192	23" x 18-1/2"	2-Hole	20"	12"	3-1/2"	
098017	ESS25202	25" x 19-1/2"	2-Hole	22"	12"	3-1/2"	

Commercial Stainless Steel Wall Service Sink—Lever Faucet Package

- 14" Gauge
- Buffed satin finish
- 1-3/4" Coved corners
- 1-1/2" Rolled rims
- 12" High backsplash
- Includes wall hanger and stainless steel support brackets
- Model includes:
 - (LK940BR03L2H) faucet
 - (LK173) cast iron P-trap



Part #	Mfg #	Overall Size	Holes	Depth	Drain Opening	Min Sink Base	Price
036727	ESSB2520C	25" x 19-1/2"	1-Hole	22"	12"	3-1/2"	

Adapters

Brass Compression Fittings

Brass Union (FIP x Comp) - Drill Through



Part #	Mfg #	Size	Finish	Price
002645	10 C	3/8" x 3/8"	CP	
002657	12 C	1/2" x 3/8"	CP	

Brass Union (Swt x Comp)



Part #	Mfg #	Size	Finish	Price
002664	14C	1/2" x 3/8"	CP	

Supplies & Fittings

Adapters

Plastic Adapters & Connectors

Solvent Weld Adapter

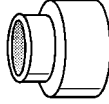

Part #	Mfg #	Size	Description	Price
073556	P9000	1-1/2"	PVC	

Supplies & Fittings

Bath Supplies

Offset Bath Supplies

- Chrome-plated
- Includes all hardware for connection



Part #	Mfg #	Description	Price
077846	B49-021	Double Offset (Pair)	

Bath Cock Accessories

- 3-3/8" Centers
- 3/4" Threaded inlets
- Chrome-plated brass body
- Replaceable stem and seat



Part #	Mfg #	Description	Price
126826	B49-010	Coupling Elbows (Pair) 3/4" Threads x 1/2" Male IPS	

Closet Kits

Closet Supply Kits

Angle Supply with Stop & Annealed Vertical Tube

- Sold individually
- Brass construction
- Compression valve
- Vertical metal supply tube
- Flange



Part #	Mfg #	Description	Price
068471	K-7637-AF	3/8" IPS, *French Gold	
109279	K-7637-BKB	3/8" IPS, Brushed Black	
056596	K-7637-BN	3/8" IPS, *Brushed Nickel	
070719	K-7637-BV	3/8" IPS, *Brushed Bronze	
069016	K-7637-CP	3/8" IPS, Polished Chrome	
076713	K-7637-G	3/8" IPS, Brushed Chrome	
089414	K-7637-PB	3/8" IPS, *Polished Brass	
139146	K-7637-SN	3/8" IPS, *Polished Nickel	
182518	K-7638-CP	1/2" NPT, Polished Chrome	

* Vibrant Limited Lifetime Warranty

www.plumbsupply.com • Serving our Customers Since 1946 • www.waterconcepts.net

Closet Kits

Closet Supply Kits

Closet Angle Stop Supply Kit (Comp x Comp)



Part #	Mfg #	Nom x OD x Lgth	Finish	Price
019939	OCR1912DLX	1/2" x 3/8" x 12"	CP	



Closet Kits

Closet Supply Valves & Tubes

5/8" OD Compression x 3/8" OD Compression Valve Kit

- Includes:
 - (1) 5/8" OD Comp x 3/8" OD Comp angle valve (5812)
 - (1) 20" Supply tube (772)
 - (1) 5/8" OD Sure grip escutcheon (7463)



Part #	Mfg #	Finish	Price
115750	5812-72-ORB	Oil Rubbed Bronze	
115749	5812-72-SN	Satin Nickel	

5/8" OD Compression x 3/8" OD Compression Valve Kit with Cover Tube & Bell Escutcheon

- Includes:
 - (1) 5/8" OD Comp x 3/8" OD Comp angle valve (5812)
 - (1) 20" Supply tube (772)
 - (1) 5-1/4" Cover tube (579)
 - (1) 11/16" Bell escutcheon (7116)



Part #	Mfg #	Finish	Price
141939	5812-72CT-ORB	Oil Rubbed Bronze	

Closet Kits

Closet Supply Kits

- Supply Stop & Escution
- 3/8"x20" Supply
- 3/8"x5/8" Angle Stop
- Lead Free



Part #	Mfg #	Description	Price
169569	S1037BB	3/8"x20" Supply & 3/8"x 5/8" Angle Stop Brushed Bronze	
169570	S1037WB	3/8"x20" Supply & 3/8"x 5/8" Angle Stop Old World Bronze	



Closet Supplies

Closet Supply Tubes

Flexible Smooth Copper Supply Tube - 3/8" OD

- Use with 3/8" OD supply valves
- 662 & 663: Compliant with California's AB-1953 and Vermont's S152



Part #	Mfg #	Description	Price
115980	772-ORB	20", Oil Rubbed Bronze	
115975	772-SN	20", Satin Nickel	

Closet Supplies

Closet Risers

- Suffix:
 - CP = Chrome plated bulk pack
 - C2 = (1) Pair boxed
 - PB = Polished brass
 - RP = Rough /unplated bulk pack

Closet Riser with Gasket Nosepiece



Part #	Mfg #	OD x Length	Finish	Price
002651	1-12DL C	3/8" x 12"	CP	
002653	1-12DL PP	3/8" x 12"	PB	
002660	1-20DL C	3/8" x 20"	CP	

Closet Riser with HD Rubber Nosepiece



Part #	Mfg #	OD x Length	Finish	Price
002650	1-12DE C	3/8" x 12"	CP	
002659	1-20DE C	3/8" x 20"	CP	

InnoFlex™ Closet Riser

Part #	Mfg #	OD x Length	Finish	Price
107400	XP1-20DLSF	3/8" x 20"	Silver	

Supplies & Fittings

Closet Supplies

Closet Supply Tubes PEX Closet Supply Tube

- Molded head with bagged nylon ferrules



Part #	Mfg #	O.D. x PEX	Price
128319	287-12	3/8" x 12"	
034836	287-20	3/8" x 20"	

Nylon Supply Tube Ferrule

- Poly construction for PEX tubes

Part #	Mfg #	Description	Price
146598	285-100	3/8" Nominal	

Anti-Siphon Ballcock

- 8½" Hoov-R-Line† Replacement
- Rebuild kit includes spare screw (reuse original brass screws when repairing)
- Conforms to ASSE 1002



490-10465

Part #	Mfg #	Assembly Size	Price
163061	490-10465	8-1/2"	

Flappers

- Produced with high quality co-polymer vinyl or ABS materials
- Replacement flappers for most popular closet brands
- Chemical-resistant flappers prevent warping
- Stainless steel (Type 303) chains will not rust



490-10108

Chemical Resistant—Vinyl Resists Warping

Part #	Mfg #	Description	Price
183411	490-10108	Blue Vinyl with 9" Stainless Steel Chain and Hook	
183412	490-10112	Clear Vinyl with 9" Chain. 1.6 GPF with 4 Orifices	

Replacement Flush Valve Tank Balls (For Douglas & Eljer Models)

Part #	Mfg #	Size	For:	Price
183413	490-10206	3"	Douglas	
183415	490-10211	N/A	Eljer	

American Standard Flush Valve Disc

- With helmet
 - Snap-on or screw-on
- Without helmet
 - Genuine American standard – snap-on or screw-on
 - Model (490-10302) goes with A.S. #33643-07
 - Model (490-10312) goes with A.S. #73383-07



490-10312

Without Helmet

Part #	Mfg #	Attachment Method	Price
183417	490-10302	Snap-On	
183418	490-10312	Screw-On	



Closet Supplies

PRO Toilet Connectors

- Made of a tough polymer core covered in braided stainless steel wire
- Ample inside diameter for high flow capacity
- Won't kink or crease
- Exceeds all requirements for flexible water connectors as defined by ASME A112.18.6 and CSA B125
- 10-Year warranty

PRO Toilet Connector (Fem Comp x Fem Ballcock)



Part #	Mfg #	Length	Fittings	Price
004367	PRO1T09	9"	3/8" x 7/8"	
004368	PRO1T12	12"	3/8" x 7/8"	
057209	PRO1T16	16"	3/8" x 7/8"	
004369	PRO1T20	20"	3/8" x 7/8"	

Supplies & Fittings

Dishwasher Supply Hoses

Speedi Plumb® Plus Braided Connectors

- Engineered polymer braid
- Chrome plated nuts and ferrules
- Tough inner core
- Large cone washer
- Unique flexibility



Dishwasher Connector Quick Connect

Part #	Mfg #	Description	Price
135403	B1-48DW	3/8" Comp x 3/8" Comp x 48"L	
135404	B1-60DW	3/8" Comp x 3/8" Comp x 60"L	
135405	B1-72DW	3/8" Comp x 3/8" Comp x 72"L	

Garden Hose Elbow Dishwasher Fitting

- Swivel makes it easier to align
- 1-Piece forged fitting
- High temperature resistant washer
- For Whirlpool, Maytag, Amana, Kitchen Aid and Jenn-Air dishwashers manufactured after September 2009



Part #	Mfg #	Description	Price
129124	HES-6-12	3/8" OD Compression x 3/4" Garden Hose Swivel	

Supplies & Fittings

Dishwasher Supply Hoses

No-Burst® Braided Stainless Steel Appliance Water Supply Connectors

- Non-toxic polymer inner core surrounded by braided stainless steel
- Captured cone washers for perfect seal
- IAPMO Listed
- 10-Year warranty



Dishwasher Connector (Fem Comp x FIP)

- Includes elbow
- B Prefix: bulk packaging

Part #	Mfg #	Length	Fittings	Price
068907	B1W48	48"	3/8" x 1/2"	
034640	B1W60	60"	3/8" x 1/2"	

Dishwasher Connector (Fem Comp x Fem Comp)

- Includes elbow
- B Prefix: bulk packaging



Part #	Mfg #	Length	Fittings	Pkg	Price
004371	B6W48	48"	3/8" x 3/8"	Bulk	
056187	B6W60	60"	3/8" x 3/8"	Bulk	
056188	6W72	72"	3/8" x 3/8"	Carded	

Dishwasher Supply Kit

- Machined brass and large inner diameter for better flow
- B Prefix: bulk packaging



Part #	Mfg #	Length	Fittings	Elbows	Price
140815	B6W48K	48"	3/8" x 3/8"	3/4" & 3/8"	
140816	B6W60K	60"	3/8" x 3/8"	3/4" & 3/8"	
140817	B6W72K	72"	3/8" x 3/8"	3/4" & 3/8"	

Washing Machine Water Supply (Hose Fitting x Hose Fitting)

- B Prefix: bulk packaging



Part #	Mfg #	Length	Fittings	Price
004373	B9WM48	48"	3/4" x 3/4"	
055442	B9WM60	60"	3/4" x 3/4"	
055443	B9WM72	72"	3/4" x 3/4"	

Ice Maker Water Supply Connectors

Ice Maker Connectors (Comp x Comp)

- Sleeve packaged



Part #	Mfg #	Length	Fittings	Price
037754	12IM60	60"	1/4" x 1/4"	
055441	12IM84	84"	1/4" x 1/4"	
091625	12IM120	120"	1/4" x 1/4"	



Dishwasher Supply Hoses

Washing Machine Hose



Part #	Mfg #	Description	Price
116669	093283	3/8" x 10' Braided Hose	

Dishwasher Supply Hoses

Dishwasher Hose

- IAPMO/UPC Listed; meets ANSI, AHAM-DWI specifications
- 5/8" Connects dishwasher pump to air gap inlet or dishwasher tailpiece
- 7/8" Connects air gap outlet to branch tailpiece or disposer
- EDPM Material with single spiral reinforcement
- Marked per foot

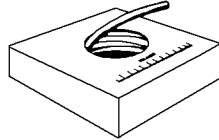

Part #	Mfg #	Size	Price
005880	D10-625	5/8" ID x 50'	
104991	D10-875	7/8" ID x 50'	

Dishwasher Drain Connector

- Includes (2) worm gear clamps



Part #	Mfg #	Description	Price
005892	D10-001	Universal Connector	

Dishwasher Supply Hoses

Hoses

Dishwasher Drain Hose

- 5/8" connects dishwasher pump to air gap inlet, directly to our long branch tailpiece or to a disposal tap-in- (with a connector kit)
- 7/8" connects the air gap outlet to branch tailpiece or disposal tap-in
- Maximum Temperature: 225°F at 20 PSI



Part #	Mfg #	Description	Price
224627	905	5/8" I.D. x 50 ft. Coil	

Supplies & Fittings

Escutcheons

Flanges

Low Pattern Flange



Part #	Mfg #	Size	Finish	Price
003065	1097	3/8" OD	CP	
003066	1098	1/2"OD for 3/8" Nom	CP	
003068	1099A	7/8"OD for 3/4" Nom	CP	
003067	1099B	5/8"OD for 1/2" Nom	CP	
003069	1100	3/8" NPT	CP	
003070	1101	1/2" NPT	CP	
003071	1101A	3/4" NPT	CP	
003072	1102	1-1/4"OD	CP	
003073	1104	1-1/2"OD	CP	
003074	1106	1-1/2" NPT	CP	

High Pattern Flange



Part #	Mfg #	Size	Finish	Price
003076	1107C	5/8" OD for 1/2" Nom	CP	
003077	1109	3/8" IPS	CP	
003078	1110	1/2" IPS	CP	
003079	1114	1-1/4" OD	CP	
003081	1115	1-1/2" OD	CP	

Box Pattern Flange



Part #	Mfg #	Size	Finish	Price
003083	1116	1-1/4" OD	CP	
003086	1117A	1-1/2" NPT	CP	

Box Pattern Flange - Tube In Flange Display Box



Part #	Mfg #	Size	Finish	Price
003085	H1117	1-1/2" OD	CP	

Floor & Ceiling Plates

Heavy Grade Floor & Ceiling Plate with Spring



Part #	Mfg #	Size	Price
003173	5340H	1/2" CTS	
003174	5341H	3/4" CTS	
003175	5342H	1" CTS	
003176	5343H	1-1/4" CTS	
003177	5344H	1-1/2" CTS	
003178	5345H	2" CTS	
003180	5351H	1/2" IPS	
003181	5352H	3/4" IPS	
003182	5353H	1" IPS	
003185	5356H	2" IPS	
003186	5357H	2-1/2" IPS	
003187	5358H	3" IPS	
057644	5360H	4" IPS	

Floor & Ceiling Plate with Spring



Part #	Mfg #	Size	Price
003183	5354	1-1/4" IPS	
003184	5355	1-1/2" IPS	

Supplies & Fittings

Escutcheons

Flanges & Ceiling Plates

Sure Grip Flange

- Chrome-plated steel



Part #	Mfg #	IPS	CWT	Outside Diameter	Price
008031	1225	3/8"	--	2-1/2"	
008032	1226	1/2"	--	2-1/2"	
008033	1227	3/4"	--	2-1/2"	
008034	1230	--	1/2"	2-1/2"	
008035	1231	--	3/4"	2-1/2"	

Sure Grip Box Flange

- Chrome-plated steel



Part #	Mfg #	IPS	CWT	Outside Diameter	Price
008036	1236	--	1-1/4"	3"	
008037	1237	--	1-1/2"	3"	

Sure Grip Bell Flange

- Chrome-plated steel



Part #	Mfg #	IPS	CWT	Tubular	Outside Diameter	Price
008090	2842	1/2"	--	--	2-1/2"	
056622	2845	-	1/2"	-	2-1/2"	
008091	2853	--	--	1-1/4"	3"	
008092	2854	--	--	1-1/2"	3"	

Split-One™ Floor and Ceiling Plate

- Simply bend and place around pipe
- Chrome or white finish
- 100% rustproof
- Non-corrosive - non-breakable



Part #	Mfg #	IPS	CWT	Outside Diameter	Price
059147	2856	1/2"	-	2-3/4"	
057215	2860	1-1/2"	-	4-1/4"	
057216	2861	2"	-	4-1/4"	
008093	2873	-	1/2"	2-1/2"	

Sure Grip Floor and Ceiling Plate

- Light pattern - no springs
- Chrome-plated steel



Part #	Mfg #	IPS	CWT	Outside Diameter	Price
008088	2821	-	1/2"	3"	
008089	2822	-	3/4"	2-3/4"	

Floor and Ceiling Plate

- Heavy pattern with springs
- Chrome-plated steel



Part #	Mfg #	IPS	CWT	Outside Diameter	Price
008094	2880	3/8"	-	2-1/4"	
008095	2881	1/2"	-	2-3/4"	
021288	2882	3/4"	-	2-3/4"	
021289	2883	1"	-	3-1/4"	
008096	2884	1-1/4"	-	3-1/2"	
008097	2885	1-1/2"	-	4"	
008098	2886	2"	-	4-1/2"	
091964	2895	-	2"	4-1/2"	

Supplies & Fittings

Escutcheons

Escutcheons

Trim Tite™ PVC Shallow/Deep Escutcheon

- Corrosion proof—will never rust or pit
- Will not come loose. molded-in “memory” retains a permanent grip on pipe or tube
- Will not scratch the tube and disrupt compression connections
- Low cost and attractive white color makes the TrimTite™ an excellent substitution for chrome-plated or stainless steel escutcheons
- CTS and IPS available in a variety of sizes
- 1" through 2" IPS sizes have deluxe 3 1/2" O.D.
- Deep tubular escutcheons are 3" deep and have an extra wide 4" base which are perfect for covering waste-arm adapters and pedestal lavatory installations



920-2W

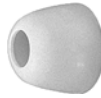

922-5W

Shallow Escutcheon

Part #	Mfg #	Dia.	O.D.	Thickness	Price
027596	920-2W	1/2" CTS	2-1/2"	9/16"	
084391	920-3W	3/4" CTS	2-1/2"	9/16"	
184074	920-4W	1" CTS	3-1/2"	9/16"	
184075	921-3W	3/4" IPS	2-1/2"	1/2"	
029293	921-6W	1-1/2" IPS	3-1/2"	9/16"	
037168	921-7W	2" IPS	3-1/2"	9/16"	

Deep Tubular Escutcheon

Part #	Mfg #	Dia.	O.D.	Thickness	Price
146721	922-5W	1-1/4"	4"	3"	

Snap One™ Floor and Ceiling Plate

- Split for pre-piped jobs
- 100% rust proof
- 3/8" Thickness



926-2W

Chrome-Plated

Part #	Mfg #	Inner Dia.	Outer Dia.	Price
039233	926-2	1/2" CTS	2-1/2"	
087909	926-3	3/4" CTS	2-3/4"	
035271	927-6	1-1/2" IPS	3-3/8"	
184076	927-2	1/2" IPS	2-3/4"	
095737	927-7	2" IPS	4-3/8"	

White

Part #	Mfg #	Inner Dia.	Outer Dia.	Price
039234	926-2W	1/2" CTS	2-1/2"	
225731	926-3W	3/4" CTS	2-3/4"	
125029	926-4W	1" CTS	3"	

One-Piece Plastic Access Panel

- Provides economical access to pressure and drainage plumbing, pipes and wiring
- Surface allows for painting or wallpapering
- Four countersunk holes
- 1/8" thick



Part #	Mfg #	Size	Material	Price
159813	970-112	White ABS	12" x 12"	

Escutcheons

Escutcheons

1/2" CTS - 5/8" OD Bell Pattern - 2-3/8" OD



Part #	Mfg #	Finish	Price
109290	E07-05BN	Brushed Nickel	
105775	E07-05RB	Oil Rubbed Bronze	

Sure Grip Escutcheons

Bell Pattern - Copper Tube Size

- Chrome-plated steel
- CTS



Part #	Mfg #	Size	Flange OD	Price
123069	E07-050	1/2" CTS (5/8" OD)	2-3/8"	

Bell Pattern Iron Pipe Size

- IPS
- Chrome Plated Steel



Part #	Mfg #	Description	Price
165662	E06125	1-1/4" IPS	

Sure Grip Bell Escutcheons

- Chrome plated



Part #	Mfg #	Description	Price
169938	E06050	1/2" IPS	

Sure Grip Tubular Bell Escutcheon

- Chrome plated
- Tubular



Part #	Mfg #	Description	Price
169939	E08125	1-1/4" OD	
169940	E08150	1-1/2" OD	

Low Pattern Escutcheon - Iron Pipe Size

- Chrome-plated steel



Part #	Mfg #	Size	Flange OD	Price
169911	E02-375	3/8" IPS	2-1/2"	
169912	E02-050	1/2" IPS	2-1/2"	
169913	E02-075	3/4" IPS	2-1/2"	
142580	E02-200	2"	3-1/2"	

Sure Grip Escutcheon

- Low pattern
- Chrome Plated Steel
- CTS



Part #	Mfg #	Description	Price
169722	E01050	1/2" Nom	
169914	E01075	3/4"Nom	
225569	E01100	1"Nom	

Tubular Sure Grip Escutcheon

- Tubular
- Box Pattern



Part #	Mfg #	Description	Price
169915	E04125	1-1/4"OD	
169916	E04150	1-1/2" OD	
171370	E0415WB	1-1/2" OD	

Chrome Plated Floor & Ceiling Flange CTS

Floor & Ceiling Plate CTS

- Chrome Plated
- Light Gauge
- CTS



Part #	Mfg #	Description	Price
169936	F01050	1/2" NOM	
169937	F01075	3/4" NOM	

Supplies & Fittings

Escutcheons

Flexible Floor & Ceiling Plates

White Plastic



Part #	Mfg #	Size	Price
119056	F07-150	1-1/2" IPS	
119055	F07-200	2" IPS	
167780	F07-201	2" CTS	

Chrome-Plated Plastic



Part #	Mfg #	Size	Price
056648	F06-375	3/8" IPS, 1/2" CTS	
106391	F06-050	1/2" IPS, 3/4" CTS	
106392	F06-075	3/4" IPS	
106393	F06-099	1" CTS	
113371	F06-100	1" IPS	
106394	F06-124	1-1/4" CTS	
106395	F06-125	1-1/4" IPS, 1-1/2" CTS	
106396	F06-150	1-1/2" IPS	
106397	F06-200	2" IPS	
106398	F06-201	2" CTS	
161801	F06-251	2- 1/2CTS	
169230	F06-500	5" IPS	

Chrome Plated Heavy Gauge

- Chrome Plated
- Heavy Gauge with springs
- Floor & Ceiling



Part #	Mfg #	Description	Price
169943	F04375	3/8"IPS	
169944	F04050	1/2" IPS	
169945	F04075	3/4" IPS	
169946	F04100	1" IPS	
169947	F04125	1 1/4" IPS	
169948	F04150	1 1/2" IPS	
169949	F04200	2"IPS	
169950	F04400	4" IPS	



Escutcheons

Escutcheons

Low Pattern 5/8" OD Escutcheon

- Fits 1/2" copper
- Sure grip - no side set screw



Part #	Mfg #	Finish	Price
116149	7463-SC	Satin Chrome	
116150	7463-BKN	Black Nickel	
116151	7463-BU	Bronze Umber	
116152	7463-MBK	Matte Black	
116153	7463-ORB	Oil Rubbed Bronze	
116154	7463-PEW	Pewter	
116257	7463-PN	Pol Nickel	
116148	7463-SN	Satin Nickel	

Box Escutcheon

- 1-1/2" OD (Fits 1-1/2" "P" trap)
- 3" Diameter
- 1-3/4" High



Part #	Mfg #	Finish	Price
165292	767-ORB	Oil Rubbed Bronze	
155723	767-SN	Satin Nickel	

Diameter Bell Escutcheon

- Sure grip - no side set screw



Part #	Mfg #	Finish	Price
116157	7158-SC	Satin Chrome	
116158	7158-BKN	Black Nickel	
116159	7158-BU	Bronze Umber	
116160	7158-MBK	Matte Black	
116161	7158-ORB	Oil Rubbed Bronze	
116162	7158-PEW	Pewter	
116255	7158-PN	Pol Nickel	
116156	7158-SN	Satin Nickel	

Escutcheon

- Cast with set screw
- For use with 1/2" IPS and 1/2" showerarms



Part #	Mfg #	Finish	Price
123369	6004-SN	Satin Nickel	

Lavatory Kits

Lavatory Supply Kits

Angle Supply with Stops - Pair

- Brass construction
- Annealed vertical tube
- Compression valve
- Flange



Part #	Mfg #	Description	Price
117725	K-7605-P-AF	3/8" NPT, *French Gold	
189570	K-7605-P-BKB	3/8" NPT, Brushed Black	
054474	K-7605-P-BN	3/8" NPT, *Brushed Nickel	
070716	K-7605-P-BV	3/8" NPT, *Brushed Bronze	
055575	K-7605-P-CP	3/8" NPT, Polished Chrome	
076716	K-7605-P-G	3/8" NPT, Brushed Chrome	
056527	K-7605-P-PB	3/8" NPT, *Polished Brass	
070690	K-7605-P-SN	3/8" NPT, *Polished Nickel	

Angle Supply with Stop (pair)

- Brass construction
- Compression valve
- Pair of angle supplies with stop
- Annealed vertical tub with union connection
- Loose key stop



Part #	Mfg #	Description	Price
182515	K-7608-CP	1/2" NPT, Polished Chrome	

Sink Traps

Contemporary Bottle Trap

- 1-1/4" x 1-1/4"
- Alternative to the traditional P-trap fitting
- Decorative solution for vessels and exposed plumbing applications



Part #	Mfg #	Description	Price
226609	K-9033-AF	*French Gold	
137293	K-9033-BN	*Brushed Nickel	
190535	K-9033-BV	*Brushed Bronze	
134426	K-9033-CP	Polished Chrome	
147073	K-9033-2BZ	Oil-Rubbed Bronze	

P-Trap with Tubing Outlet

- 1-1/4" x 1-1/4"
- Adjustable rotation on outlet tube
- Slip-joint inlet
- Cleanout plug
- Brass construction



Part #	Mfg #	Description	Price
069041	K-8998-CP	Polished Chrome	

P-Trap With Long Tubing Outlet

- 1-1/4" x 1-1/4" O.D inlet and outlet
- Adjustable rotation on outlet tube
- Cleanout plug, flange
- Extension and tubing outlet
- Brass construction
- Recommended for above-the-floor bidet and lavatory sink installations



Part #	Mfg #	Description	Price
189571	K-9018-2BZ	Oil-Rubbed Bronze	

* Vibrant Limited Lifetime Warranty

www.waterconcepts.net • Serving our Customers Since 1946 • www.plumbsupply.com

Lavatory Kits

Lavatory/Sink Supply Kits

Lavatory Angle Stop Supply Kit (Comp x Comp)

- SCR Has loose key handle



Part #	Mfg #	Nom x OD x Lgth	Desc	Price
019937	OCR1912AX C	1/2" x 3/8" x 12"	CP	
002620	SCR1912AX C	1/2" x 3/8" x 12"	CP Esc	

Supplies & Fittings



Lavatory Kits

Lavatory Supply Kits

5/8" OD Compression x 3/8" OD Compression Valve Kit

• Includes:

- (2) 5/8" OD Comp x 3/8" OD Comp angle valves (5812)
- (2) 3/8" OD x 20" Supply tubes (662)
- 5/8" OD Sure grip escutcheons (7463)



Part #	Mfg #	Finish	Price
115742	5812-62-SN	Satin Nickel	

Lavatory Kits

Lavatory Supply Kits

Lavatory Angle Stop Kit

- 2- Supplies, Angle Stops, Escutcheon
- Lead Free



Part #	Mfg #	Description	Price
169572	S1036BN	3/8"x20" Supply & 3/8"x 5/8" Angle Stop Brushed Nickel	

Lavatory Straight Stop Kit

- 2- Supplies, Straight Stops, Escutcheon
- Lead Free



Part #	Mfg #	Description	Price
169574	S1035BN	Brushed Nickel 3/8"x20" Lav Supply Kit with 3/8"x5/8" Straight stop	
169575	S1035WB	Old World Bronze 3/8"x20" Lav Supply Kit with 3/8"x5/8" Straight stop	

Lavatory Supplies

Lavatory/Sink Risers

- Actual riser length is length to connect less 1/2"
- Suffix:
 - CP = Chrome-plated bulk pack
 - RB = Rough brass

Lav/Sink Riser - 1-Piece with Insert



Part #	Mfg #	OD x Length	Finish	Price
002647	1-12A C	3/8" x 12"	CP	
002649	1-12A R	3/8" x 12"	RB	
002658	1-20A C	3/8" x 20"	CP	
022260	1-20A R	3/8" x 20"	RB	
002663	1-36A C	3/8" x 36"	CP	

Lav/Sink Riser (Comp)



Part #	Mfg #	OD x Length	Finish	Price
002655	1-12KC C	3/8" x 12"	CP	
002656	1-20KC C	3/8" x 20"	CP	

Supplies & Fittings

Lavatory Supplies

Supply Tube
PEX Sink Supply

- 3/8" NPT



Part #	Mfg #	Size	Price
057821	34312	3/8" OD, 20" Length	

Supplies & Fittings



Lavatory Supplies

Lavatory Supply Tubes

PEX Lav-Sink Supply Tube

- PEX tubes have molded head and include nylon ferrule  285-12

Part #	Mfg #	Size	Material	Price
128318	285-12	3/8" O.D. x 12"	PEX	
034834	285-20	3/8" O.D. x 20"	PEX	
034835	285-36	3/8" O.D. x 36"	PEX	

Soft Copper Supply Tube Extension Connectors

- Great for faucet change-outs or supply tube extensions

Part #	Mfg #	MSwt x FSwt	Length	Price
064542	289-12	3/8" O.D.	12"	



Lavatory Supplies

Lavatory Supply Tubes

Flexible Smooth Copper Supply Tube For 3/8" OD

- Use with 3/8" OD supply valves
- 662 & 663: Compliant with California's AB-1953 and Vermont's S152

Part #	Mfg #	Description	Price
116263	662-ORB	20", Oil Rubbed Bronze	
115955	662-SN	20", Satin Nickel	
115957	662-BU	20", Bronze Umber	

Flexible Smooth Copper Supply Tube for 1/2" OD

- Use with 1/2" OD supply valves
- 6620 is Compliant with California's AB-1953 and Vermont's S152

Part #	Mfg #	Description	Price
115969	6620-ORB	20", Oil Rubbed Bronze	
115965	6620-SN	20", Satin Nickel	

Supplies & Fittings

Lavatory Supplies

Faucet Water Supply Connectors

- Made of a tough polymer core covered with braided stainless steel wire
- Large inside diameter for higher flow capacity
- Won't kink or crease
- Heavy-duty brass hex nuts are easy to grip and nickel-plated for durability
- Exceeds all code requirements for flexible water connectors

Faucet Connector (Fem Comp x FIP Straight)

- B Prefix: bulk packaging



Part #	Mfg #	Length	Fittings	Price
047162	B1F09	9"	3/8" x 1/2"	

Faucet Connector (FIP Straight x FIP Straight)

- B Prefix: bulk packaging



Part #	Mfg #	Length	Fittings	Price
055109	B4F30	30"	1/2" x 1/2"	

Faucet Connector (Fem Comp x Fem Comp)

- B Prefix: bulk packaging



Part #	Mfg #	Length	Fittings	Price
061839	B6F16	16"	3/8" x 3/8"	

Faucet Connector (Fem Comp x OD Copper Tubing Coupling)

- B Prefix: bulk packaging



Part #	Mfg #	Length	Fittings	Price
039222	B8F16	16"	3/8" x 3/8"	

PRO Faucet Connectors

- Made of a tough polymer core covered in braided stainless steel wire
- Ample inside diameter for high flow capacity
- Won't kink or crease
- Exceeds all requirements for flexible water connectors as defined by ASME A112.18.6 ad CSA B125
- 10-Year warranty

PRO Faucet Connector (Fem Comp x FIP Straight)



Part #	Mfg #	Length	Fittings	Price
004364	B1F12	12"	3/8" x 1/2"	
004365	B1F16	16"	3/8" x 1/2"	
004366	B1F20	20"	3/8" x 1/2"	
019833	B1F30	30"	3/8" x 1/2"	

PRO Faucet Connector (FIP Straight x FIP Straight)



Part #	Mfg #	Length	Fittings	Price
042948	B4F12	12"	1/2" x 1/2"	
059323	B4F16	16"	1/2" x 1/2"	
042949	B4F20	20"	1/2" x 1/2"	

PRO Faucet Connector (Fem Comp x Fem Comp)



Part #	Mfg #	Length	Fittings	Price
056587	B6F12	12"	3/8" x 3/8"	
051582	B6F20	20"	3/8" x 3/8"	



Lavatory Supplies

PRO Faucet Connector (Fem Comp x OD Copper Tubing Coupling)



Part #	Mfg #	Length	Fittings	Price
004372	B8F12	12"	3/8" x 3/8"	
023095	B8F20	20"	3/8" x 3/8"	

Supplies & Fittings

Nuts & Washers

Nuts

Brass Nut (Comp)



Part #	Mfg #	Size	Finish	Price
002641	61-6-C	3/8" OD	CP	

Washers

Lavatory Riser Tube Component

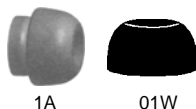

Part #	Mfg #	Description	Price
002644	1A	3/8" Lavatory Riser Nosepiece	
002642	01W	Lavatory Cone Washer	

Multi-Turn Stop Washer

Part #	Mfg #	Description	Price
002608	R15-6	Brass Thrust Washer	

Supplies & Fittings



Nuts & Washers

Plumbing Washers

Cone Shaped Washer

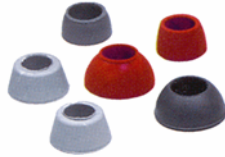

Part #	Mfg #	Description	Price
006239	804	1/2" Red	

Step Style Washer

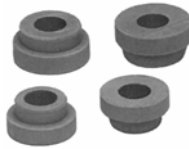

Part #	Mfg #	Size	Qty	Price
006237	802	3/8" x 3/4" x 3/8"	20	

Stops - Angle

Multi-Turn Angle Stop Valves

- Suffix after the space:
- CP = Chrome-plated
- Suffix X before space is California lead-free

Angle Stop (Comp x Comp)



Part #	Mfg #	Nom x OD	Finish	Price
002578	OCR09XC	3/8" x 3/8"	CP	
036172	OCR09XC	1/2" x 1/4"	CP	
002596	OCR19XC	1/2" x 3/8"	CP	
002589	OCR39X	1/2" x 1/2"	CP	

Angle Stop (FIP x Comp)



Part #	Mfg #	Nom x OD	Finish	Price
002598	OR15X	3/8" x 3/8"	CP	
019935	OR17XC	1/2" x 3/8"	CP	

Angle Stop (Swt x Comp)



R09 R

R19 C

Part #	Mfg #	Nom x OD	Finish	Price
019080	R09XR	1/2" x 1/4"	RB	
002610	R19XC	1/2" x 3/8"	CP	
002611	R19XR	1/2" x 3/8"	RB	

Pushconnect Angle Stops

G2 Angle Stop (Push Connect x Comp)



Part #	Mfg #	Nom x OD	Finish	Price
158655	G2PS19X C	1/2" x 3/8"	CP	

G2 Angle Stop (Push Connect x Push Connect)



Part #	Mfg #	Nom x OD	Finish	Price
158657	G2QPS19X C	1/2" x 3/8"	CP	

G2 Series Twist In 1/4-Turn Angle Stops

**G2 Angle Stop
(Cold Expansion Barb for PEX x Comp)**



Part #	Mfg #	Nom x OD	Finish	Price
107384	G2CEPX19X C	1/2" x 3/8"	CP	

G2 Angle Stop (Comp x Comp)



Part #	Mfg #	Nom x OD	Finish	Price
162148	G2CR19X C	1/2" x 3/8"	CP	

G2 Angle Stop (FIP x Comp)



Part #	Mfg #	Nom x OD	Finish	Price
166382	G2R15X C	3/8" x 3/8"	CP	

Supplies & Fittings

Stops - Angle

1/4-Turn Ball Angle Stops

- PTFE Seats provide corrosion resistance and watertight seal
- Blow-out proof stem
- Plated stem
- 100% Leak tested
- Suffix after the space:
- C is Chrome
- Suffix X before space is California lead-free

Angle Stop (Comp x Comp)



Part #	Mfg #	Nom x OD	Finish	Price
050641	KTCR19X C	1/2" x 3/8"	CP	

Angle Stop (FIP x Comp)



Part #	Mfg #	Nom x OD	Finish	Price
158741	KTR15X C1	3/8" x 3/8"	CP	

Angle Stop (Swt x Comp)



Part #	Mfg #	Nom x OD	Finish	Price
050643	KTR19X C	1/2" x 3/8"	CP	

Commercial Water Supplies

Angle Stop Valve with Loose Key - Regular Pattern (FIP)



Part #	Mfg #	Size	Finish	Price
002622	SR17X C	1/2" x 3/8"	CP	

Angle Stop Valve with Loose Key (Swt x Comp)

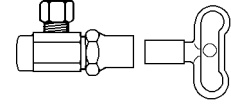

Part #	Mfg #	Size	Finish	Price
161876	SCR19X C	1/2" x 3/8"	CP	

Angle Stop Valve with Loose Key (Comp)



Part #	Mfg #	Inlet x OD	Finish	Price
002619	SCR19 C	1/2" x 3/8"	CP	

Stops - Angle

Dual Outlet Stops

- Suffix after the space:
 - CP = Chrome plated
 - RB = Rough Brass
- Suffix X before space is California lead-free

Dual Outlet (Comp Inlet x Comp x Comp)

- Suffix:
 - CRxxxxLR = neutral
 - C1 (chrome) and R1 (rough) are with window tray

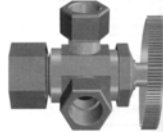

Part #	Mfg #	Nom x OD x OD, Direction	Finish	Price
067556	CR1901LRXC	1/2" x 3/8" x 3/8"	CP	
002584	CR1901LRXR	1/2" x 3/8" x 3/8"	RB	

Brass Valve Adapter (Comp)

- Suffix X is California lead-free



Part #	Mfg #	Size (OD Fem x OD x OD)	Price
135929	CT2-664X P	3/8" x 3/8" x 1/4"	
134129	CT2-666X P	3/8" x 3/8" x 3/8"	

Dual Shut-Off Stops

- Suffix after the space:
 - RB = Rough Brass
- Suffix X before space is California lead-free

Dual Shut-Off Stop (Comp Inlet x Comp x Comp)



Part #	Mfg #	Nom x OD x OD	Finish	Price
110566	CR1901DVSR	1/2" x 3/8" x 3/8"	RB	

Stop Component Parts

Multi-Turn Stop Component

Part #	Mfg #	Description	Price
115113	S15-10C	Die Cast Zinc Loose Key Handle	

Brass Compression Fittings

Brass Union (MIP x Comp) - Drill Through



Part #	Mfg #	Size	Finish	Price
002646	11C	3/8" x 3/8"	CP	

Supplies & Fittings



Stops - Angle

Supply Valves & Tubes

Angle Pattern 5/8" OD Compression x 3/8" OD Compression Valve

- All brass body and stem
- 5/8" OD Compression fits 1/2" copper tubing



Part #	Mfg #	Finish	Price
115951	5812-ORB	Oil Rubbed Bronze	
115949	5812-SC	Satin Chrome	
115950	5812-SN	Satin Nickel	

Cross Angle Pattern 5/8" OD Compression x 3/8" OD Compression Valve

- Brass button on handle matches finish on valve
- Handle options:
 - 621-8: Oval handle



Part #	Mfg #	Finish	Price
115929	621-8-BU	Bronze Umber	
115926	621-8-SN	Satin Nickel	

Stops - Angle

PRO-Stop Supply Stops - Angle Pattern

**PRO-Stop 7125 Angle Pattern 1/4-Turn Supply Stop
(C x Comp)**



Part #	Mfg #	Size	Price
128954	7125A	1/2" Swt x 3/8" OD Comp	

**PRO-Stop 7145 Angle Pattern 1/4-Turn Supply Stop
(Comp x Comp)**



Part #	Mfg #	Size	Price
136908	7145	5/8" OD x 1/4" OD Comp	
128951	7145A	5/8" OD x 3/8" OD Comp	

**PRO-Stop 7155A Angle Pattern 1/4-Turn Supply
Stop (FIP x Comp)**



Part #	Mfg #	Size	Price
128952	ND617H5	3/8" FIP x 3/8" OD Comp	
128953	ND617H7	1/2" FIP x 3/8" OD Comp	

Supplies & Fittings

Stops - Angle

Mini-Ball™ Valves

5000 Series Dual Shut-Off Valve

- *With integral water hammer arrester*
- *Pattern: (2) straight with tee*
- *Operation: handle*
- *Chrome plated*



Part #	Mfg #	Description	Price
086475	33-5001-WHA	5/8" OD Copper Comp x 3/8" OD Copper Comp	

6000 Series Dual Shut-Off Valve

- *With integral water hammer arrester*
- *Pattern: (1) straight, (1) angle with tee*
- *Operation: handle*
- *Chrome plated*



Part #	Mfg #	Description	Price
086477	33-6001	5/8" OD Comp x 3/8" OD Comp x 3/8" OD Comp	

Supplies & Fittings

Stops - Angle

Angle Stop

180 Degree Angle Stop

- Chrome Plated
- Lead Free
- UPC listed



Part #	Mfg #	Description	Price
159455	S10324	5/8"ODx 1/4" OD Angle Stop	

PlumBite Angle Stops

- Heat free method for joining copper, CPVC & PEX tube
- #### PlumBite Angle Supply Stop
- 1/4-Turn
 - Chrome finish

Part #	Mfg #	Description	Price
133426	C76-571	1/2" PlumBite x 3/8" OD Angle	

Stops - Angle

Angle Stops

PDQ™ Push Quarter-Turn Stop Valve—No Lead

- *Plumbing Done Quickly*
- *Easy & fast compliant plumbing solutions*
- *Universal: works with all CTS pipe types*
- *Removable, replaceable, reusable.*
- *Valves tested to 200 PSI at 200°F*



Part #	Mfg #	Push-Fit x O.D	Finish	Price
186105	648QG220A	1/2" x 3/8"	Chrome-Plated	

Straight Stops

PDQ™ Push Quarter-Turn Stop Valve—No Lead

- *Plumbing Done Quickly*
- *Easy & fast compliant plumbing solutions*
- *Universal: works with all CTS pipe types*
- *Removable, replaceable, reusable.*
- *Valves tested to 200 PSI at 200°F*



Part #	Mfg #	Push-Fit x O.D	Finish	Price
186104	648QG220S	1/2" x 3/8"	Chrome-Plated	

Supplies & Fittings

Stops - Straight

Multi-Turn Straight Stop Valves

- Suffix after the space:
- CP = Chrome-plated
- Suffix X before space is California lead-free

Straight Stop (Swt x Comp)



Part #	Mfg #	Nom x OD	Finish	Price
002603	R14X C	1/2" x 3/8"	CP	

G2 Series Twist In 1/4-Turn Straight Stops

G2 Straight Stop (Comp x Comp)



Part #	Mfg #	Nom x OD	Finish	Price
162147	G2CR14XCLF	1/2" x 3/8"	CP	

G2 Straight Stop (FIP x Comp)



Part #	Mfg #	Nom x OD	Finish	Price
166383	G2R10X C	3/8" x 3/8"	CP	

G2 Series (Push Connect x Push Connect)



Part #	Mfg #	Nom x OD	Finish	Price
158656	G2QPS14X C	1/2" x 3/8"	CP	

Commercial Straight Stops

Straight Stop Valve with Loose Key (Comp)

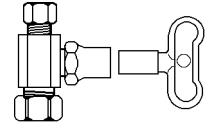

Part #	Mfg #	Nom Comp x OD	Finish	Price
031922	SCR14C	1/2" Comp x 3/8" OD	CP	

Supply Kit Components

Brass Cover Tube

- For 1/2" nominal copper tube



Part #	Mfg #	Size	Finish	Price
002675	8491 C	36"	CP	

Supplies & Fittings

Stops - Straight

Pushconnect Straight Stops

Straight Stop (Pushconnect x Comp)

- Dual o-rings
- Pre-inserted tube stiffener
- Locking clip
- Suffix C1 - 20ct



Part #	Mfg #	Nom x OD	Finish	Price
158654	G2PS14XC	1/2" x 3/8"	CP	

1/4-Turn Ball Straight Stops

- PTFE Seats provide corrosion resistance and watertight seal
- Blow-out proof stem
- Plated stem
- 100% Leak tested
- Suffix after the space:
 - C is Chrome
- Suffix X before space is California lead-free

**G2 Straight Stop
(Cold Expansion Barb for PEX x Comp)**



Part #	Mfg #	Nom x OD	Finish	Price
107385	G2CEPX14XC	1/2" x 3/8"	CP	

Straight Stop (Comp x Comp)



Part #	Mfg #	Nom x OD	Finish	Price
050642	KTCR14XC	1/2" x 3/8"	CP	
059129	KTCR11FC	3/8" Fe x 3/8"	CP	

Multi-Turn Straight Stop Valves

- Suffix after the space:
 - CP = Chrome-plated
- Suffix X before space is California lead-free

Straight Stop (FIP x Comp)



Part #	Mfg #	Nom x OD	Finish	Price
019932	OR10X	3/8" x 3/8"	CP	
019933	OR12X	1/2" x 3/8"	CP	

Straight Stop (Comp x Comp)



Part #	Mfg #	Nom x OD	Finish	Price
002579	OCR11X	1/4" x 3/8"	CP	
161875	OCR14XC	1/2" x 3/8"	CP	
025026	OCR34XC	1/2" x 1/2"	CP	

Supplies & Fittings

Stops - Straight

PRO-Stop Supply Stops - Straight Pattern

PRO-Stop 7120 Straight Pattern 1/4-Turn Supply Stop (C x Comp)



Part #	Mfg #	Size	Price
128958	7120	1/2" C x 3/8" OD Comp	

PRO-Stop 7140 Straight Pattern 1/4-Turn Supply Stop



Part #	Mfg #	Size	Price
128955	ND60306	5/8" OD x 3/8" OD Comp	

PRO-Stop 7140A Straight Pattern 1/4-Turn Supply Stop (Comp x Comp)



Part #	Mfg #	Size	Price
129859	ND613H4	3/8" OD x 3/8" OD Comp	

PRO-Stop 7150 Straight Pattern 1/4-Turn Supply Stop



Part #	Mfg #	Size	Price
128956	ND60605	3/8" FIP x 3/8" OD Comp	

PRO-Stop 7150A Straight Pattern 1/4-Turn Supply Stop (FIP x Comp)

• Cold working pressure: 125 psi



Part #	Mfg #	Size	Price
128957	ND616H6	1/2" FIP x 3/8" OD Comp	

Supplies & Fittings



Stops - Straight

Straight Pattern Supply Valves

Straight Pattern 5/8" OD Compression x 3/8" OD Compression Valve

- 5/8" OD Compression fits 1/2" copper tubing
- Brass body and stem



Part #	Mfg #	Finish	Price
115946	581-ORB	Oil Rubbed Bronze	
115945	581-SN	Satin Nickel	

Stops - Straight

Straight Stops

180 Degree Straight Stop

- Chrome Plated
- Lead Free
- UPC Listed



Part #	Mfg #	Description	Price
162057	S10208	3/8x3/8 Straight Stop LF	

PlumBite Straight Supply Stop

- 1/4-Turn
- Chrome finish



Part #	Mfg #	Description	Price
133427	C76-570	1/2" PlumBite x 3/8" OD Straight	

Washing Machine Supply Hoses

Washing Machine Hose

- For hot or cold use
- Bagged with washers
- Standard female hose threads
- Bursting pressure: 800 psi
- 3/8" ID



Part #	Mfg #	Description	Price
085189	J04-005	Straight Female, 5' Filler Hose	

Water Heater Supply Hoses

Water Heater Supply Connectors

- Made of tough core covered with braided stainless steel wire
- Large inside diameter for higher flow capacity
- Won't kink or crease
- Heavy-duty brass hex nuts are easy to grip and nickel-plated for durability
- Exceeds all code requirements for flexible water connectors

Water Heater Connector (FIP x FIP)

- B Prefix: bulk packaging



Part #	Mfg #	Length	Fittings	Price
055640	B1H12	12"	3/4" x 3/4"	
055641	B1H18	18"	3/4" x 3/4"	
059321	B1H24	24"	3/4" x 3/4"	

Water Heater Connector (MIP x FIP)

- B Prefix: bulk packaging

Part #	Mfg #	Length	Fittings	Price
051579	B3H18	18"	3/4" x 3/4"	



Water Heater Supply Hoses

PEX Water Heater Fittings

Standard Water Heater Connector with Flexible FIP

- Full-flow, dielectric fitting - no flow restriction
- Brass FIP swivel nut includes gasket
- 3/4" FIP Branch for 2 gallon expansion tank
- Lead-free solder joint



Part #	Mfg #	Connection	Price
100810	634X418	(3/4") PEX x FIP Swivel	

Water Heater Supply Hose

Water Heater Hose Connectors

Water Heater Connector - Corrugated Copper Flex

- For use on water heaters and softeners
- Corrugated for easy flex
- Includes rubber washers



Part #	Mfg #	Size	Price
123802	J34-715	3/4" FPT x 15" Length	

Bidet's & Bidet Faucets

Horizontal Spray Bidet's

Amaretto® Horizontal Spray Bidet

- Vitreous china
- Drilled for fixture-mounted, single-hole, over-the-rim
- Included mounting hardware



Part #	Mfg #	Description	Rough-In	Color	Price
153702	K-4876-0	15-5/8"W x 24-3/8"L x 15"H	Above or Below the Floor	White	
139190	K-4876-47	15-5/8"W x 24-3/8"L x 15"H	Above or Below the Floor	Almond	
182459	K-4876-96	15-5/8"W x 24-3/8"L x 15"H	Above or Below the Floor	Biscuit	

Vertical Spray Bidet's

Memoirs® Vertical Spray Bidet

- Vitreous China
- Drilled for fixture-mounted bidet faucet with vacuum breaker



Part #	Mfg #	Description	Rough-In	Color	Price
076952	K-4886-0	15-1/4"W x 25-9/16"L x 15"H	Above or Below the Floor	White	
122901	K-4886-47	15-1/4"W x 25-9/16"L x 15"H	Above or Below the Floor	Almond	
075863	K-4886-96	15-1/4"W x 25-9/16"L x 15"H	Above or Below the Floor	Biscuit	
159665	K-4886-G9	15-1/4"W x 25-9/16"L x 15"H	Above or Below the Floor	Sandbar	

San Tropez® Vertical Spray Bidet

- Vitreous china
- Drilled for fixture-mount bidet faucet and vacuum breaker
- (4) Faucet holes
- Front fill and vertical spray



Part #	Mfg #	Description	Rough-In	Color	Price
057459	K-4854-0	15-1/2"W x 24-3/8"L x 15-1/2"H	Above or Below the Floor	White	
117708	K-4854-33	15-1/2"W x 24-3/8"L x 15-1/2"H	Above or Below the Floor	Mexican Sand	
104479	K-4854-47	15-1/2"W x 24-3/8"L x 15-1/2"H	Above or Below the Floor	Almond	
065592	K-4854-7	15-1/2"W x 24-3/8"L x 15-1/2"H	Above or Below the Floor	Black	
121286	K-4854-95	15-1/2"W x 24-3/8"L x 15-1/2"H	Above or Below the Floor	Ice Grey	
055764	K-4854-96	15-1/2"W x 24-3/8"L x 15-1/2"H	Above or Below the Floor	Biscuit	

*Vibrant Limited Lifetime Finish

www.plumbsupply.com • Serving our Customers Since 1946 • www.waterconcepts.net

Bidet's & Bidet Faucets

Bidet Faucets

Memoirs® Stately Vertical Spray Bidet Faucet

- Brass construction
- Fixture-mount transfer valve/vacuum breaker
- Pop-up drain with lift rod and tailpiece



Part #	Mfg #	Description	Finish
182456	K-470-4S-BN	Lever Handles, Vertical Spray	*Brushed Nickel
182457	K-470-4S-CP	Lever Handles, Vertical Spray	Polished Chrome

Oblo® Horizontal Bidet Faucet

- Solid brass construction
- One-piece, self-contained ceramic disc valve
- Single-hole mounting
- Pop-up drain with lift rod and tailpiece included
- Flow rate: 2.2 gpm



Part #	Mfg #	Description	Finish
153703	K-100889-CP	Oval Handles, Horizontal Spray	Polished Chrome

Purist® Vertical Spray Bidet Faucet

- Metal construction, brass valve bodies
- Fixture-mount transfer valve/vacuum breaker



Part #	Mfg #	Description	Finish
122759	K-14431-4-BN	Lever Handles, Vertical Spray	*Brushed Nickel
085045	K-14431-4-CP	Lever Handles, Vertical Spray	Polished Chrome

Refinia® Vertical Spray Bidet Faucet

- Metal construction
- Flexible connections
- Quarter-turn washerless ceramic disc valves
- Pop-up drain with lift rod and tailpiece



Part #	Mfg #	Description	Finish
183077	K-5329-4-BN	Lever Handles, Vertical Spray	*Brushed Nickel
149922	K-5329-4-CP	Lever Handles, Vertical Spray	Polished Chrome

*Vibrant Limited Lifetime Finish

www.waterconcepts.net • Serving our Customers Since 1946 • www.plumbsupply.com



Bolts & Caps

Toilet Repair Parts & Fasteners

E-Z Snap Toilet Bolt Set

- Set contains:
 - (2) Toilet flange bolts
 - (2) Open acorn hex nuts
 - (2) Heavy NP washers
 - (2) Plastic retainers



Part #	Mfg #	Description	Price
017665	51076	Plumb Label, 1/4" x 2-1/4"	
017663	51176	Plumb Label, 5/16" x 2-1/4"	

Flange Bolt and Screw Set

- Set contains:
 - (2) Brass toilet flange bolts
 - (4) Open-end acorn nuts
 - (4) Heavy plated washers



Part #	Mfg #	Description	Price
017664	53046	Plumb Label, 1/4" x 2-1/4"	
042343	053065N	1/4" x 2-1/4"	
017666	53196	Plumb Label, 5/16" x 2-1/4"	

Brass Toilet Flange Bolt Set

- Contains:
 - (2) Brass toilet flange bolts
 - (2) Open acorn hex nuts
 - (2) Heavy NP washers
 - (2) Plastic speed nuts (optional)



Part #	Mfg #	Description	Price
058808	053125-N	1/4" x 3-1/2"	
005564	53215	5/16" x 3-1/2"	

Brass Toilet Flange Screw Set

- Contains:
 - (2) Brass toilet flange screws
 - (2) Closed brass NP acorn hex nuts
 - (2) Heavy NP washers



Part #	Mfg #	Description	Price
005553	059045	1/4" x 2-1/2"	
005554	059205	5/16" x 2-1/2"	
040968	059225	5/16" x 3-1/2"	

Tank Bolt Kit

- Contains:
 - (2) 3" Brass tank bolts
 - (4) Rubber CI washers
 - (4) Heavy NP round washers
 - (4) Brass hex nuts OR
 - (2) Brass hex nuts and (2) wing nuts



Part #	Mfg #	Description	Price
033930	68022	Plumb Label Tank Bolt Kit	

Sponge Rubber Gasket & Bolt Kit

- 3-1/4" OD x 2-1/8" ID x 9/16"
- Fits most close-coupled toilets
- Includes sponge rubber gasket with bolt kit (068025) and fiber washer (70045)



Part #	Mfg #	Description	Price
033931	072020	Plumb Label Tank Bolt Kit	

Toilet Bolt Cap Set

- Cap snaps onto insert



Part #	Mfg #	Description	Price
005555	063065	White Plastic	



Bolts & Caps

Gerber Toilet Bolt Caps

Bolt Cap

Part #	Mfg #	Description	Price
004844	99-287	Bolt Caps & Washer for Toilet, White	

Toilets

*Physical Vapor Deposition (PVD) Limited Lifetime Finish

www.waterconcepts.net • Serving our Customers Since 1946 • www.plumbsupply.com

Bolts & Caps

Bolt Caps
Plastic Bolt Caps

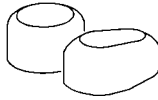

Part #	Mfg #	Size	Shape	Price
033750	917-PR	1/4-5/16"	Round Pair	

Toilets

Bolts & Caps

Toilet Parts

Plumb Perfect™ Closet Bolt

- Tensile strength exceeds 1,100 lbs per bolt
- Redesigned threads provide increased strength and smoother, faster threading
- 100% corrosion proof nylon bolts are available in convenient 2-1/2" and 3-1/2" lengths
- Improved adaptability – open end nut now fits 1/2" sockets and fits under most bolt caps. Bolt base loads into any flange
- Unique design allows for quick and hassle free installation
- Pyramid base design keeps bolt upright and does not allow bolt to spin in flange, eliminating need to double nut bolt



Part #	Mfg #	Size	Price
009974	425-PB	2-1/2"	
064562	427-PB	3-1/2"	

Solid Brass Closet Bolt

- Fastens a toilet bowl securely to the floor with a bolt, nut, and washer
- Available in 1/4" AND/or 5/16"
- Nickel-plated steel acorn nut and zinc-plated washer INCLUDED
- Acorn nuts and washers also available separately

Solid Brass Closet Bolt

Part #	Mfg #	Bolt Size	Price
009969	411-PB	1/4" x 20-3-1/2"	

Components

Part #	Mfg #	Description	Price
009971	417	1/4" x 20 -7/16" Hex, Nickel-Plated Steel Open End Nut	
009972	419	Closet Washer, Zinc Plated Steel, .042 Thick	

Smart Cap™ Closet Bolt Cover Cap

- Taller cap eliminates the need to cut bolts
- Base creates a tight seal that helps provide a continuous sanitary seal between base and toilet
- Cap threads onto base and is less likely to get lost or knocked off
- Available with or without PlumbPerfect™ nylon closet bolts
- Model (440-2W) includes (425-PB) closet bolts

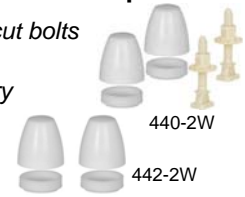

Part #	Mfg #	Color	Price
183409	440-2W	White	
121769	442-2W	White	

Closet Bolt Cover Cap

- Polypropylene
- Snap on washer included



Part #	Mfg #	Color	Price
111541	490-11240	White	

Standard Tank Bolt Set

- Standard bolt set has 23/32" heads
- Plated hex nuts and wing nuts
- Cloth inserted washers and plated washers



Part #	Mfg #	Material	Price
183410	452-PB	Solid Brass	

Wedge-It™ Multi-Purpose Stability Closet Wedge

- Corrosion proof
- Derivable stiff polypropylene
- Soft Rubber-Like PVC

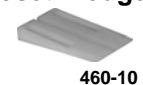

Part #	Mfg #	Material	Color	Price
029290	460-10	Polypro	Natural	
035407	460-20	PVC	White	

Tank-to-Bowl Kit

- Gasket with deluxe tank-to-bowl bolts —Sponge rubber gasket
- Replaces worn tank-to-bowl gaskets and bolts
- Manufactured to same specifications as original parts
- Prevents leaks between the tank and the bowl



Part #	Mfg #	Brand	# of Bolts	Gasket	Price
183422	490-10555	Universal	2	3/4"	



Bolts & Caps

Toilet Parts (Continued)

Tank-to-Bowl Kit

Part #	Mfg #	Brand	# of Bolts	Gasket	Price
152335	490-10572	Kohler	3	3/4"	

Bolts & Caps

Bolts

Brass Plated Closet Bolts

- 1/4" x 2-1/4"
- Packed with (4) acorn nuts and (4) washers
- Washer width: 7/8"
- Washer thickness: 1/16"
- Nut width: 9/16"
- Nut thickness: 3/8"



Part #	Mfg #	Description	Price
169653	C02-999	1/4" x 2-1/4" Brass Plated	

Enduro Closet Bolts

- 5/16" X2-1/2"
- Never Rusts
- Space age Composite
- Fits all Closet Flange styles
- Withstands over 1,000 PSI



Part #	Mfg #	Description	Price
166191	C02050	5/16"x 2-1/2" Closet Bolts	

Shims

Bulk Closet Wedge Shim

- Stackable
- Easily trimmed to desired height

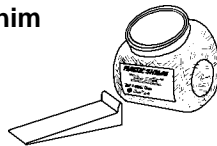

Part #	Mfg #	Description	Price
041992	S55-903	3/8"W x 1-3/8"L x 5/16"H (1,000) Counter Display	

Closet Bolt Caps

Closet Bolt Cap w/ Washer

- Bulk packed
- White Round
- Plastic



Part #	Mfg #	Description	Price
169953	C02105	1/4 & 5/16 Plastic Bolt Cap	

Toilets

Bowl Wax

PRO Series Bowl Wax Rings

- For floor outlet toilet bowls
- Fits 3" and 4" waste lines

PRO Bowl Wax Ring

Part #	Mfg #	Description	Price
145791	PRO700	Pro Series Wax Ring	

PRO Bowl Wax Ring with Flange



Part #	Mfg #	Description	Price
145792	PRO70F	Pro Series Wax Ring w/Flange	

Wax-Free™ Bowl Gasket

- Adapts to all types of flooring and drain pipes
- Eliminates the need for stacking multiple wax rings on new, raised flooring
- 10-Year warranty

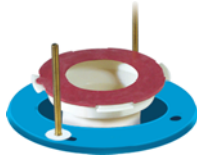

Part #	Mfg #	Description	Price
055498	7500	Fits 3" or 4" Drain Pipes	
055500	7504	4" Wax-Free™ Bowl Gasket	



Bowl Wax

Wax Toilet Bowl Gaskets

No-Seep No. 1 Wax Gasket

- With polyethylene flange
- Fits 3" and 4" lines
- For floor closet bowls only



Part #	Mfg #	Description	Price
017672	1122	Plumb Label #1 Wax Gasket	

No-Seep No. 2 Specialty Urethane Wax Gasket

- Fits all wall closet bowls and carriers
- 10-Year guarantee



Part #	Mfg #	Description	Price
002560	004005	#2 Urethane	

No-Seep No. 3 Specialty Urethane Wax Gasket

- Fits 3" and 4" lines
- For floor and most wall bowls
- 10-Year guarantee



Part #	Mfg #	Description	Price
002561	004305	#3 Urethane	

No-Seep No. 10 Extra Thick Wax Gasket

- With polyethylene flange
- Fits 3" and 4" lines
- 40% More wax for more positive seal



Part #	Mfg #	Description	Price
002559	00111524	#10 Extra Thick	

Bol-Wax No. 1 Standard Wax Gasket

- For floor closet bowls only



Part #	Mfg #	Description	Price
017762	7043	Plumb Label 1 Bowl Wax	

Bol-Wax No. 6 Specialty Urethane Wax Gasket

- Fits 2" outlet
- For urinals
- 10-Year guarantee



Part #	Mfg #	Description	Price
002562	011305	#6 Urinal Gasket	

Bol-Wax No. 10 Extra Thick Wax Gasket

- For floor closet bowls only



Part #	Mfg #	Description	Price
119053	007400	#10 Extra Thick	

Toilets

Bowl Wax

Wax Bowl Rings



Part #	Mfg #	Model	Description	Price
133296	82550	RWG1	Std Wax Gasket	

Toilets

Bowl Wax

Bowl Rings

Urinal Wax Ring

- Urethane sponge



Part #	Mfg #	Description	Price
121374	31187	Urinal Wax Ring	

Heavy Duty Wax Bowl Ring w/ Sleeve

- 100% pure petroleum wax gasket for setting any floor type closet bowl
- Provides a permanent seal impervious to vermin, odors, gases and acids
- Polyethylene sleeve



Part #	Mfg #	Size	Price
189168	31194	3" or 4"	



Closet Flanges, Spuds, & Flush Ells

Toilet Flanges

Stainless Steel Toilet Mount Ring

- *Replaces damaged toilet flange ring*
- *Fits all closet hubs*
- *Will not rust or corrode*



Part #	Mfg #	Description	Price
059700	014710	Toilet Mount Ring	

Toilets

Closet Flanges, Spuds, & Flush Ells

Closet Flanges

Closet Flange for Lead Flange



Part #	Mfg #	Size	Price
005875	CF-400	4" x 3"	

Closet Flanges, Spuds, & Flush Ells

Brass Closet Flush Elbows

- -1 Polished chrome



Part #	Mfg #	Size	Gauge	Price
003277	1032AD-1	2" x 5" x 7"	20ga	
003278	1033D-1	2" x 6" x 8"	20ga	

Toilets

Closet Flanges, Spuds, & Flush Ells

Closet Flanges

Easy Tap® Closet Flange

- With test cap
- 3" or 4" flange solvent welds inside of 4" or over 3" Schedule 40 DWV pipe
- Built-in catch teeth prevents the test cap from falling down into the DWV line
- Four mounting slots for closet bolts
- Four countersunk holes for secure attachment to the floor



Part #	Mfg #	Size	Price
197460	43613	3" or 4" PVC w/ SS Ring	

Offset Level-Fit Closet Flange with Metal Ring

- The metal ring provides added strength and cracking resistance to the flange and can be rotated to allow precise alignment of bolts and screws
- Solvent welds inside of 4" or over 3" Sch 40 DWV pipe
- 2" Offset allows a margin of error for drain pipe/flange alignment



Part #	Mfg #	Description	Price
015447	43501	3" or 4" PVC	

Level-Fit Closet Flange with Metal Ring

- The metal ring provides added strength and cracking resistance to the flange and can be rotated to allow precise alignment of bolts and screws
- Solvent welds inside of 4" or over 3" Sch 40 DWV pipe



Part #	Mfg #	Description	Price
015446	43513	3" or 4" PVC	
030381	43515	3" or 4" PVC with Test Cap Also	

Level-Fit Closet Flange

- 3" or 4" all plastic flange welds inside of 4" or over 3" Sch 40 DWV pipe
- 3" inside fit flange fits inside 3" Sch 40 DWV pipe
- (4) Mounting slots
- (4) Countersunk holes for secure attachment to the floor



Part #	Mfg #	Description	Price
015444	43503	3" or 4" PVC less Test Cap	
015445	43505	3" or 4" PVC with Test Cap	
192790	43507	3" PVC w/Plastic Ring & Test Cap	

Closet Flanges (Continued)

Level-Fit Closet Flange

Part #	Mfg #	Description	Price
030382	43509	3" PVC Inside Fit less Test Cap	

45° Swivel Closet Flange



Part #	Mfg #	Description	Price
049616	43816	4" x 3" PVC	

Twist-N-Set™ Closet Flange

- Replaces broken cast iron closet flanges
- Installs easily without tools
- No need to tear up existing floor
- Smooth unrestricted flow design
- Gasket expands to fit service weight, heavy weight and no hub



Part #	Mfg #	Description	Price
075704	43654	3" PVC	
029792	43651	4" PVC	
049551	43653	4" Cast Iron	

Closet Flange Replacement

- Slides inside of 4" cast iron or Sch 40 DWV plastic pipe
- 3" Stainless steel bolts are tightened from the finished floor
- Compression joint allows up to 3" of adjustment to the riser
- No tear out or caulking required



Part #	Mfg #	Description	Price
040577	43539	4" PVC	

Cast Iron Flange

- No caulking
- Use on plastic or heavy weight, no hub or service weight soil pipe
- Complete with body, brass ring, bolts and gasket



Part #	Mfg #	Description	Price
155787	42253	3" CI, w/o Test Cap	
149947	42255	4" CI, w/o Test Cap	

Toilets

Closet Flanges, Spuds, & Flush Ells

Closet Flange Spacer

- 1/4" Spacer builds up an existing closet flange when new flooring is installed
- Can be stacked to desired height



Part #	Mfg #	Description	Price
041344	43519	1/4" Flange Spacer for ABS or PVC Closet Flanges	

Moss Bay Replacement Flange

- Used for replacing rusted or corroded metal closet flange rings
- PVC or ABS closet flanges
- Includes closet bolts



Part #	Mfg #	Size	Price
173033	42777	PVC or ABS	

Toilets

Closet Flanges, Spuds, & Flush Ells

PVC Closet Flanges

PVC Closet Flange (Hub)



Part #	Size	Price
015261	4"	

PVC Closet Flange with KO Test Plug (Hub)

Part #	Size	Price
015272	4"	

PVC Adj Closet Flange with Metal Ring (Hub)



Part #	Size	Price
015271	4"	

PVC Fitting Closet Flange (Spgt)

Part #	Size	Price
015448	4" x 3"	

PVC Adj Ftg Closet Flange with Metal Ring (Spgt)

Part #	Size	Price
015449	4" x 3"	

Closet Flanges, Spuds, & Flush Ells

Closet Flanges

Closet Quick Ring

- Replaces any and all closet rings
- Unique screw tabs attach to wood or concrete
- Plastisol coat provides corrosion protection
- Slotted for 1/4" or 5/16" closet bolt

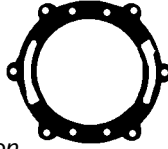

Part #	Mfg #	Description	Price
008019	21013	Quick Ring Closet Ring	

Closet Spuds

Closet Spud



Part #	Mfg #	Size	Locknut	Price
008121	959	1-1/2" x 1-1/2"	Brass	
008122	960	1-1/4" x 1-1/4"	Brass	

Urinal Spud



Part #	Mfg #	Size	Locknut	Price
008123	961	1" x 3/4"	Brass	

Toilets

Closet Flanges, Spuds, & Flush Ells

Closet Flanges

TKO™ Total Knockout Closet Flange

- Knockout will not break apart and cannot fall down drain pipe
- Strong, corrosion-resistant stainless steel ring eliminates cracked flanges
- Easier installation, no need to hold knockout while hammering
- Holds five floors (22 psi) for head test
- Model (883-PTM) includes 1-3/4" long tailpiece



884-ATM

One-Piece Plastic Ring

Part #	Mfg #	Hub/Inside	Flush to Floor	Price
030421	883-PT	3"	4"	
104313	886-PTS	(3" Spigot)		

Stainless Steel Swivel Ring

Part #	Mfg #	Hub/Inside	Flush to Floor	Price
035411	884-PTM	3"	4"	
105484	886-4PTM	4"	4"	
105483	886-PTMS	3" (Spigot)	4"	

Open Closet Flange

- **One-piece plastic ring**
—Solid PVC or ABS
- **Stainless steel swivel ring**
—Corrosion-resistant ring is engineered for maximum strength



887-PM



888-P

One-Piece Plastic Ring: PVC

Part #	Mfg #	Hub/Inside	Flush to Floor	Price
035412	888-P	3" (Inside Fit)		

Stainless Steel Swivel Ring

Part #	Mfg #	Hub/Inside	Flush to Floor	Price
030422	887-PM	3"	4"	

Push-Tite™ Gasketed Closet Flange

- Gasket seals inside DWV pipe
- Easy installation – simply push in and fasten to floor, perfect for replacement or new installations
- PushTite™ flanges have larger outlets than other gasketed closet flanges and smooth inner walls with no obstructions or ledges to cause clogs
- Swivel ring is stainless steel for durability



888-GPM



887-GPM



886-GP

Inside 3" DWV Pipe

Part #	Mfg #	Ring	Connection	Price
137027	888-GP	SS Swivel	4" Long Tailpiece	

Inside 4" DWV Pipe

Part #	Mfg #	Ring	Connection	Price
073909	887-GPM	SS Swivel	Flush to Floor	
101224	888-GPM	Plastic	4" Long Tailpiece	

QuickSpacer™ Closet Flange Spacer Ring

- Fits under most closet flanges
- Each ring raises the flange 3/4" off the floor
- Use multiple rings for additional height



Part #	Mfg #	Size	Price
064362	886-ER	3/4"	

Ringer™ Stainless Steel Closet Ring

- Strong corrosion-proof stainless steel
- Perfect for repairs - cups the damaged flange
- Mount around 3" or 4" pipe on concrete floors



Part #	Mfg #	Thickness	Price
078459	886-MR	Stainless Steel Closet Ring	

Raise-A-Ring™ Closet Flange Extension Ring

- Build up existing flange when added subfloor, etc. leaves flange at or below floor level
- Stack rings for additional height



886-R

Part #	Mfg #	Thickness	Price
034257	886-R	7/16"	
156865	886-RQ	1/4"	

Toilets

Closet Flanges, Spuds, & Flush Ells

FullFlush™ Offset Open Closet Flange

- Full-flow, 3" I.D. throat – no restriction
- Allows for 1½" offset in any direction for closet bowl setting
- Corrosion-resistant 430 stainless steel swivel ring is engineered for maximum strength



Part #	Mfg #	Hub/Inside	Flush to Floor	Price
083332	889-POM	3" PVC	4"	

Save-A-Flange™ Closet Flange Repair Kit

- 1/8" Stamped, zinc plated steel
- Kit Includes:
 - (1) Zinc-plated bar
 - (2) Plastic screw anchors
 - (2) 1-3/4" x 8" Phillips-head screws
 - (6) Poly spacer washers
 - (1) Instruction sheet



Part #	Mfg #	Description	Price
035408	490-11320	Save-A-Flange Repair Kit	

Closet Flange Spacer Repair Ring Kit

- Two-piece, "Moss Bay" design for replacing broken or rusted swivel rings without removing flange
- Includes two-piece galvanized ring, closet bolts, nuts and washers



Part #	Mfg #	Pieces	Per Card	Price
176277	886-MRM	2	1	

Spuds Spud Gasket

- Installs on flush valve spud
- Seals brass spud to china
- Natural rubber



Part #	Mfg #	Size	Type	Price
183434	490-11520	1-1/4"	Urinal	
183435	490-11522	1-1/2"	Closet	
183437	490-11530	1" x 3/4"	Urinal	

Gaskets

Closet Bowl Cushion—Sponge Rubber Ring Type

- Wax-free Toilet Seal
- Excessive plunging will not cause leaks
- Pre-drilled holes on wide flange model hold bolts upright, eliminating need to double nut

Part #	Mfg #	O.D.	I.D.	Height	Price
183419	490-10542	5-3/8"	3-1/2"	3/4"	

Universal Tank-to-Bowl Gaskets

- Molded rubber



Part #	Mfg #	O.D.	I.D.	Height	Price
183425	490-10656	3-5/8"	2-1/4"	3/4"	

American Standard/Mansfield Tank-to-Bowl Gaskets

- Sponge material



Part #	Mfg #	O.D.	I.D.	Height	Price
183428	490-10661	3-1/2"	2-1/8"	1-1/8"	

Gerber Tank-to-Bowl Gaskets

- Sponge material



Part #	Mfg #	O.D.	I.D.	Height	Price
183430	490-10666	3-1/4"	2-1/8"	1-3/16"	

Kohler Tank-to-Bowl Gaskets

- Sponge or molded rubber material
- 3/4" Height



Part #	Mfg #	O.D.	I.D.	Material	Price
183431	490-10671	3-3/4"	2-1/2"	Rubber	
183432	490-10673	3-1/4"	2"	Sponge	

Plactic Flush Valve

- Complete replacement plastic flush valve with flapper
- Blue vinyl chemical-resistant flapper
- Stainless steel chain

Part #	Mfg #	Description	Price
183433	490-11152	Gasket Only for 490-11150	

Toilets

Closet Flanges, Spuds, & Flush Ells

Closet Spuds

Brass Closet Spud

- Cast brass
- Includes spud washer and metal friction ring



Part #	Mfg #	Size	Price
084126	C27-125	1-1/4"	
084125	C27-150	1-1/2"	
084123	C27-200	2"	
084124	C27-202	2" x 1-1/2"	

Urinal Spuds



Part #	Mfg #	Size	Price
084127	C27-134	1" x 3/4"	
084128	C27-126	1-1/4" x 3/4"	
084129	C27-310	1-1/2" x 3/4"	

Plastic Closet Flanges

Plastic Two Finger Flange

- Pushes easily into cast iron or Sch 40 DWV pipe
- No tearout or caulking required
- ASTM C-564 Rubber gasket

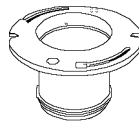

Part #	Mfg #	Size	Price
044895	C47-43P	4" x 3"	

Plastic Plumbfit Flush Closet Flange

- 3" x 4" Fits flush with floor
- 3" Fits inside 3" Sch 40 DWV pipe
- Extra-thick flange with short slots for extra strength
- (6) Screw holes
- Long shank
- Beveled 3" and 4" entrance



C50-340

Part #	Mfg #	Description	Price
041986	C50-340	3" x 4", PVC w/Knockout	
083976	C51-300	3", PVC less Knockout	
041987	C51-340	3" x 4", PVC less Knockout	

Spigot Fit Closet Flange

- Extra-thick flange with short slots for extra strength
- (6) Screw holes



Part #	Mfg #	Description	Price
068948	C51-350	3" less Knockout	

Plumbfit Closet Flange with Adjustable Ring

- Fits over 3" and inside 4" Sch 40 DWV pipe
- 6" Long shank
- Can be cut to desired length
- Swivel rings

Part #	Mfg #	Description	Price
113083	C53-700	Plastic Ring	

Plumb Fit Closet Flange

- Fits over 3" or Inside 4" SCH 40 DWV Pipe
- 2 Radial Slots & 2 grooved Slots for bolts
- (6) Screw holes



Part #	Mfg #	Description	Price
155751	C53-342	Swivel closet flange	

Plastic 2" Offset Closet Flange

- Fits over 3" or inside 4" Sch 40 DWV pipe
- Includes:
 - (4) Closet bolt slots
 - (2) mounting screw holes



Part #	Mfg #	Size	Price
041985	C54-340	3" x 4" PVC	

Closet Flange Ring

- Fits over 3" or 4" PVC
- Converts 3 & 4" PVC to toilet Ready



Part #	Mfg #	Description	Price
173375	C51-302	3" Closet Flange Ring	

Toilets

Closet Flanges, Spuds, & Flush Ells

Cast Iron Closet Flanges

Code Blue Cast Iron No Caulk Closet Flange

- (4) Stainless bolts and washers
- Neoprene gasket meets ASTM C564
- Ideal for repair and new construction
- Push over cast iron or plastic pipe, anchor to floor and tighten bolts
- Easy to install - reduces installation time by 80%



Part #	Mfg #	Size	Price
005876	C40-320	3" Pipe x 2" Depth	
005877	C40-420	4" Pipe x 2" Depth	
005878	C40-430	4" Pipe x 3" Depth	
005879	C40-440	4" Pipe x 4" Depth	

Cast Iron Closet Flange



Part #	Mfg #	Description	Price
181156	C45433	4" Inlet x 3" Outlet x 3" depth	

Cast Iron 2" Offset Closet Flange



Part #	Mfg #	Size	Connection	Price
124529	C43-441	4" x 4" x 2"	No-Hub	

Brass Closet Flanges

Brass Closet Flange



Part #	Mfg #	Description	Price
005872	C49-441	Deep Seal 1-1/8"	

Closet Flanges Accessories

Flange Support for Wood Floors

- Supports flange if floor has rotted or if rough-in hole is too large
- Easy to install
- Individually carded
- Complete kit includes screws



Part #	Mfg #	Description	Price
035889	C01-001	For Plastic 3", 4" or 3" x 4" Flange	

Gapper Flange

- Use to repair broken closet flanges



Part #	Mfg #	Description	Price
096656	C87-100	Repair Flange Carded	

Closet Flange Repair Ring

- Securely attaches to concrete or wood sub-floor
- Replaces most closet rings
- Corrosion resistant
- Mounting ears offset by 1/8" to allow closet bolts to be installed



Part #	Mfg #	Description	Price
054588	C85-000	Closet Repair Ring	

Plastic Closet Flange Extender

- For raising floor height when adding ceramic tile or hardwood
- Stackable to desired height



Part #	Mfg #	Size	Price
005873	C88-001	1/2"	

Complete Closet Flange Extension Kit

- Includes:
 - (2) 3-1/2" Closet bolts with washers and nuts
 - Anchors toilet bolts when closet ring is broken
 - Built-in gaskets
 - No caulking required
 - 1-1/4" & 1-1/2" Flanges

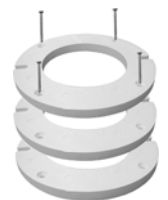

Part #	Mfg #	Description	Price
087357	C88-500	Extension Kit w/Gaskets	

Closet Flanges, Spuds, & Flush Ells

Plastic Closet Flange Extension Kit

- No mastic necessary between pieces as with stackable units
- Includes:
 - (2) 3-1/2" Closet bolts with washers and nuts
 - (1) 1/2" Flange

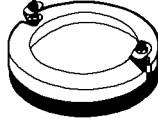

Part #	Mfg #	Description	Price
106771	C88-050	Extension Kit w/Hardware	

Closet Flange Spacers

Closet Flange Spacer Kit

- Reusable toilet seal gasket
- For repair or correction of problems resulting from installation errors or remodeling projects
- Includes:
 - (2) Gaskets
 - 1/2" Spacer
 - 1/4" x 3-1/2" Closet bolt kit
 - (2) Plastic shims



Part #	Mfg #	Description	Price
068945	C88-600	1" Repair Ring	



Commercial Closets

Commercial Spud Bowls Wall-Mount Top Spud Bowl

- Elongated bowl
- 1-1/2" Spud for flushometer valve
- Wall waste outlet
- Siphon-jet
- Flush valve sold separately



Part #	Mfg #	Description	Rough-In	Color	Price
016283	25-030	Elongated Bowl	5-1/4" - 7-1/4"(ADA)	White	

North Point™ Wall-Mount Spud Bowl

- Elongated bowl
- 1-1/2" spud for flushometer valve
- siphon jet
- Top spud
- 1.28/1.6 gpf/4.8/6.0 Lpf high



Part #	Mfg #	Description	Rough-In	Color	Price
185772	25-033	Elongated Bowl	5-1/4" - 7-1/4"	White	

Floor-Mount Top Spud Bowl

- Large trapway
- 1-1/2" Spud for flushometer valve
- Siphon-jet



Part #	Mfg #	Description	Rough-In	Color	Price
017712	25-830	Elongated Bowl	10"	White	
050466	25-870	Round Bowl, Eli Children's	10"	White	

Floor-Mount ErgoHeight™ Top Spud Bowl

- Large trapway
- 1-1/2" Spud for flushometer valve
- Siphon-jet



Part #	Mfg #	Description	Rough-In	Color	Price
004647	25-730	ADA Elongated Bowl	10"	White	

Toilets



Commercial Closets

Floor-Mount Elongated 1.6 Back Outlet Spud Bowl

- Elongated bowl
- 4-1/4" Vertical rough in
- Fully glazed trapway
- 1-1/2" Back spud for flushometer valve
- Back outlet
- Siphon jet
- Toilet seat not included



Part #	Mfg #	Description	Rough-In	Color	Price
167101	25-874	Back outlet bowl	4-1/4" Vertical	White	

Maxwell™ ErgoHeight Wall-Hung 2-Piece 1.28 Toilet

- 2" glazed trapway for efficient waste removal
- 3" flush valve for strong water flow and flushing power
- 4" Vertical rough-in
- Dual-fed siphon jet
- Pilot fill valve
- Seat sold separately



Part #	Mfg #	Description	Rough-In	Color	Price
150801	20-021	21-970 ADA Wall-Hung Bowl, 28-970 Tank	4"	White	

Commercial Closets

Commercial Toilets

Anglesey™ Floor-Mounted Wall-Outlet Commercial 1.6 gpf Flushometer Valve with Top Inlet

- 27-1/2" x 14-1/2" x 15"
- 1-1/2" top spud
—1-1/2" Rear spud (K-4396-0)
- 15" Elongated bowl
- 4-1/2" rough-in
- Seat sold separately
- (K-4388 Models include integral seat)



Part #	Mfg #	Description	Rough-In	Color	Price
060200	K-4386-0	Elongated Bowl, 1-1/2" Top Spud	4-1/2"	White	
222090	K-4388-0	Elongated Bowl with Seat, 1-1/2" Top Spud	4-1/2"	White	
061742	K-4396-0	Elongated Bowl, 1-1/2" Rear Spud	4-1/2"	White	

Anglesey™ Commercial Floor-Mounted 1.6 or 1.28 gpf Comfort Height® Bowl

- 31-1/2" x 14-7/8" x 17"
- Vitreous china
- Direct-fed siphon jet flushing
- Rear-outlet flushometer bowl
- 1-1/2" Top spud
- 4" Rough-in
- 2-1/8" Glazed trapway
- (-L) Bedpan lugs



Part #	Mfg #	Description	Rough-In	Color	Price
133057	K-4352-0	Elongated Bowl, 1-1/2" Top Spud	4"	White	
148226	K-4352-L-0	Elongated Bowl, 1-1/2" Top Spud	4"	White	

Barrington™ 2-Piece 1.0 gpf Toilet with Pressure Lite® Flushing Technology

- 31-1/2" L x 21-1/4" W x 31-1/4" H
- 4" Rough-in
- Includes left-hand trip lever
- Right-Hand Trip Lever (-RA)
- Rear outlet bowl



K-3578 Combination: K-4305 Elongated Bowl, K-4484 Tank

Part #	Mfg #	Description	Rough-In	Color	Price
138826	K-3578-0	ADA Elongated Complete, LH CP Trip	4"	White	
155830	K-3578-47	ADA Elongated Complete, LH CP Trip	4"	Almond	
174559	K-3578-RA-0	ADA Elongated Complete, RH CP Trip	4"	White	
225842	K-3652-0	Elongated Complete, LH Trip	4"	White	
165850	K-3652-7	Elongated Complete, LH Trip	4"	Black	

*Vibrant Limited Lifetime Finish

www.plumbsupply.com • Serving our Customers Since 1946 • www.waterconcepts.net

Commercial Closets

Barrington™ Elongated Toilet Bowl with Pressure Lite® Flushing Technology

- Vitreous China
- Seat not included
- Combines with K-4645 series tanks to create K-3554 series Barrington™ Pressure Lite® toilets

Part #	Mfg #	Description	Rough-In	Color	Price
063764	K-4327-0	Elongated Bowl	-	White	

Highcliff™ Comfort Height® Commercial 1.6 gpf Toilet Bowl with Top Inlet

- 26"L x 14-1/2"W x 17-1/2"H
- 10" or 12" Rough-in
- 1-1/2" Spud
- Seat sold separately



Part #	Mfg #	Description	Rough-In	Color	Price
053188	K-4368-0	ADA Elongated Bowl, 1-1/2" Top Spud	10" or 12"	White	
069992	K-4368-47	ADA Elongated Bowl, 1-1/2" Top Spud	10" or 12"	Almond	
075006	K-4368-7	ADA Elongated Bowl, 1-1/2" Top Spud	10" or 12"	Black	
059462	K-4368-96	ADA Elongated Bowl, 1-1/2" Top Spud	10" or 12"	Biscuit	
060506	K-4368-L-0	Elongated Bowl, 1-1/2" Top Spud with Bedpan Lugs	10" or 12"	White	

Highcliff™ Commercial 1.28 or 1.6 gpf Toilet Bowl with Rear Inlet

- 26"L x 14-1/2"W x 17-1/2"H
- 11" Rough-in
- 1-1/2" Spud
- Seat sold separately



Part #	Mfg #	Description	Rough-In	Color	Price
080177	K-4367-0	ADA Elongated Bowl, 1-1/2" Rear Spud	11"	White	

Highcrest™ Commercial 1.6 Toilet Bowl with Top Inlet

- Siphon jet flushing technology
- 16-1/2" High bowl is ADA compliant
- 10" or 12" Rough-in
- 1-1/2" Spud
- Seat sold separately



Part #	Mfg #	Description	Rough-In	Color	Price
055815	K-4302-0	ADA Elongated Bowl, 1-1/2" Top Spud	10" or 12"	White	
229070	K-4302-47	ADA Elongated Bowl, 1-1/2" Top Spud	10" or 12"	Almond	

*Vibrant Limited Lifetime Finish

www.waterconcepts.net • Serving our Customers Since 1946 • www.plumbsupply.com

Commercial Closets

HighCrest™ Commercial 1.28 or 1.6 gpf Toilet Bowl with Rear Inlet

- 26"L x 14-1/2"W x 16-1/2"H
- 11" Rough-in
- 1-1/2" Spud
- Seat sold separately



Part #	Mfg #	Description	Rough-In	Color	Price
083071	K-4301-0	ADA Elongated Bowl, 1-1/2" Rear Spud	11"	White	

Highline® 1.6 or 1.28 gpf Flushometer Valve Comfort Height® Commercial Toilet Bowl

- 10" or 12" Rough-in
- 17-1/28" High bowl is ADA compliant
- Seat sold separately
- Meets EPA WaterSense® criteria
- (-L) Bedpan lugs



Part #	Mfg #	Description	Rough-In	Color	Price
101366	K-4405-0	ADA Elongated Bowl, 1-1/2" Spud	10" or 12"	White	
156510	K-4405-7	ADA Elongated Bowl, 1-1/2" Spud	10" or 12"	Black	
115420	K-4405-96	ADA Elongated Bowl, 1-1/2" Spud	10" or 12"	Biscuit	
135780	K-4405-L-0	ADA Elongated Bowl, 1-1/2" Spud	10" or 12"	White	

Kingston™ Wall-Mounted 1.6 or 1.28 gpf Flushometer Valve Toilet Bowl with Top Inlet

- 17" - 19" High installation, floor to top of seat or installed with K-4679-CA toilet seat for ADA compliance
- Seat and flush valve sold separately
- -L Model includes bed pan plugs



Part #	Mfg #	Description	Color	Price
118238	K-4325-0	Elongated Bowl, Wall-Mount, 1-1/2" Rear Spud	- White	
146599	K-4325-96	Elongated Bowl, Wall-Mount, 1-1/2" Rear Spud	- Biscuit	
118238	K-4325-BA-0	Elongated Bowl, Wall-Mount, 1-1/2" Rear Spud	- White	
183057	K-4325-L-0	Elongated Bowl, Wall-Mount 1-1/2" Rear Spud	- White	

Kingston™ Wall-Mounted 1.6 or 1.28 gpf Flushometer Valve Toilet Bowl with Rear Inlet

- 17" - 19" High installation, floor to top of seat or installed with K-4679-CA toilet seat for ADA compliance
- Seat sold separately



Part #	Mfg #	Description	Color	Price
130311	K-4323-0	Elongated Bowl, Wall-Mount, 1-1/2" Rear Spud	- White	

*Vibrant Limited Lifetime Finish

www.plumbsupply.com • Serving our Customers Since 1946 • www.waterconcepts.net

Commercial Closets

Primary™ Commercial Flushometer 1.6 Toilet Bowl

- 1-1/2" Top spud
- 10" Rough-in
- Includes seat in choice of colors with scalloped handhold locations for children



Part #	Mfg #	Description	Rough-In	Color	Price
063608	K-4321-0	Elongated Bowl, 1-1/2" Top Spud	10"	White	

Primary™ 1.28 gpf Elongated Toilet Bowl with Seat

- 26-7/8"L x 12-7/8"W x 12"H
- 1-1/2" Top spud
- 10" Rough-in



Part #	Mfg #	Description	Rough-In	Color	Price
158984	K-4384-0	Elongated Bowl, 1-1/2" Top Spud	10"	White	

Stratton™ Wall-Mounted 3.5 gpf WaterGuard® Flushometer Valve Elongated Blow-Out Toilet Bowl

- 26" x 14" x 11-3/4"
- 1-1/2" Top spud
- Requires seat
- ADA-compliant when installed at required height of 17" - 19" from floor to top of seat



Part #	Mfg #	Description	Rough-In	Color	Price
62414	K-4450-C-0	Elongated Bowl, 1-1/2" Top Spud	-	White	

Wellcomme™ 1.6 or 1.28 gpf Flushometer Valve Toilet Bowl

- 14-3/4" High bowl
- Sweat extension nipple required for 12" rough-in
- Seat sold separately



K4350

With Rear Outlet

Part #	Mfg #	Description	Rough-In	Color	Price
055785	K-4349-0	Elongated Bowl, 1-1/2" Rear Spud	10" or 12"	White	

With Top Outlet

Part #	Mfg #	Description	Rough-In	Color	Price
053187	K-4350-0	Elongated Bowl, 1-1/2" Top Spud	10" or 12"	White	
171245	K-4350-L-0	Elongated Bowl, 1-1/2" Top Spud, Includes bed pan plugs	10" or 12"	White	

*Vibrant Limited Lifetime Finish

www.waterconcepts.net • Serving our Customers Since 1946 • www.plumbsupply.com

Commercial Closets

Wellworth® 1.6 or 1.28 gpf Flushometer Valve and Toilet Bowl with Top Inlet

- 15" High bowl
- 10" or 12" Rough-in
- High efficiency bowl
- Seat sold separately



Part #	Mfg #	Description	Rough-In	Color	Price
101367	K-4406-0	High Efficiency Elongated Bowl	10" or 12"	White	
156512	K-4406-7	High Efficiency Elongated Bowl	10" or 12"	Black	
183059	K-4406-L-0	High Efficiency Elongated Bowl, Includes bed pan plugs	10" or 12"	White	

Highline® Pressure Lite™ Comfort Height® 2-Piece Commercial 1.6 Toilet

- Sloan Flushmate™ system
- 17-1/2" High bowl is ADA compliant
- 12" Rough-in
- Seat and supply sold separately



K-3544 Combination: K-4324 Elongated Bowl, K-4404 Tank

Part #	Mfg #	Description	Rough-In	Color	Price
055421	K-4324-0	ADA Elongated Bowl	12"	White	

Wellworth® Two-Piece 1.6 gpf Toilet with Pressure-Lite® Flushing Technology

- Equipped with Sloan Flushmate™
- 15" High bowl with standard 12" rough-in
- Includes polished chrome trip lever
- Seat and supply sold separately



K-3505 Combination: K-4303 Elongated Bowl, K-4645 Tank

Part #	Mfg #	Description	Rough-In	Color	Price
086525	K-3505-0	Elongated Complete, LH CP Trip	12"	White	
086524	K-4303-0	Elongated Bowl Only	12"	White	

*Vibrant Limited Lifetime Finish

www.plumbsupply.com • Serving our Customers Since 1946 • www.waterconcepts.net

Closet Bowls

Vitreous China Elongated Toilet Bowls

Archer® Comfort Height® 2-Piece Toilet Bowl

- 16-1/2" High bowl with 12" standard rough-in
- 2-1/8" Glazed trapway
- Seat and supply sold separately



K-3551 Combination: K-4356 Elongated Bowl, K-4431 Tank

Part #	Mfg #	Description	Rough-In	Color	Price
144888	K-4356-0	ADA Elongated Bowl	12"	White	
144063	K-4356-95	ADA Elongated Bowl	12"	Ice Grey	
144567	K-4356-K4	ADA Elongated Bowl	12"	Cashmere	
152287	K-4356-NY	ADA Elongated Bowl	12"	Dune	

Bancroft® Comfort Height® 2-Piece Toilet Bowl

- 16-1/2" High bowl with 12" standard rough-in
- 2-1/8" Glazed trapway
- Seat and supply sold separately



K-3827 Combination: K-4067 Elongated Bowl, K-4383 Tank

Part #	Mfg #	Description	Rough-In	Color	Price
141789	K-4067-0	ADA Elongated Bowl	12"	White	
155565	K-4067-33	ADA Elongated Bowl	12"	Mexican Sand	
155566	K-4067-95	ADA Elongated Bowl	12"	Ice Grey	
141773	K-4067-96	ADA Elongated Bowl	12"	Biscuit	

Cimarron® Comfort Height® 2-Piece Toilet Bowl

- 16-1/2" High bowl with 12" standard rough-in
- Seat and supply sold separately



K-3589 Combination: K-4309 Elongated Bowl, K-4418 Tank

Part #	Mfg #	Description	Rough-In	Color	Price
116902	K-4309-0	ADA Elongated Bowl	12"	White	
117008	K-4309-47	ADA Elongated Bowl	12"	Almond	
125326	K-4309-7	ADA Elongated Bowl	12"	Black	
120793	K-4309-95	ADA Elongated Bowl	12"	Ice Grey	
116903	K-4309-96	ADA Elongated Bowl	12"	Biscuit	
129138	K-4309-G9	ADA Elongated Bowl	12"	Sandbar	

*Vibrant Limited Lifetime Finish

www.waterconcepts.net • Serving our Customers Since 1946 • www.plumbsupply.com

Closet Bowls

Devonshire® Comfort Height® 2-Piece Toilet Bowl

- 16-1/2" High bowl with 12" standard rough-in
- 2-1/8" Glazed trapway
- Seat and supply sold separately



K-3837 Combination: K-4397 Elongated Bowl, K-4438 Tank

Part #	Mfg #	Description	Rough-In	Color	Price
141574	K-4397-0	ADA Compact Elongated Bowl	12"	White	
141581	K-4397-47	ADA Compact Elongated Bowl	12"	Almond	
141578	K-4397-96	ADA Compact Elongated Bowl	12"	Biscuit	

Highline® Comfort Height® 2-Piece Toilet Bowl

- 16-1/2" High bowl with 12" standard rough-in and 3 bolt installation
- 2-1/8" Glazed trapway
- Seat and supply sold separately



K-3949 Combination: K-4199 Elongated Bowl, K-4841 Tank

Part #	Mfg #	Description	Rough-In	Color	Price
134972	K-4199-0	ADA Elongated Bowl	12"	White	
138352	K-4199-47	ADA Elongated Bowl	12"	Almond	
140396	K-4199-7	ADA Elongated Bowl	12"	Black	
137503	K-4199-96	ADA Elongated Bowl	12"	Biscuit	

Highline® Comfort Height® 2-Piece Toilet Bowl

- 16-1/2" High bowl with 10" standard rough-in and 3 bolt installation
- 2-1/8" Glazed trapway
- Seat and supply sold separately



K-3889 Combination: K-4373 Elongated Bowl, K-4467 Tank

Part #	Mfg #	Description	Rough-In	Color	Price
137504	K-4373-0	ADA Elongated Bowl	10"	White	
139803	K-4373-47	ADA Elongated Bowl	10"	Almnod	
137505	K-4373-96	ADA Elongated Bowl	10"	Biscuit	

*Vibrant Limited Lifetime Finish

www.plumbsupply.com • Serving our Customers Since 1946 • www.waterconcepts.net

Closet Bowls

Highline® Comfort Height® 2-Piece Toilet Bowl with Pressure Lite® Flushing Technology

- 17-1/8" High bowl with standard 12" rough-in
- Seat and supply sold separately



K-3493 Combination: K-4304 Elongated Bowl, K-4645 Tank

Part #	Mfg #	Description	Rough-In	Color	Price
086519	K-4304-0	ADA Elongated Bowl	12"	White	

Highline® Concealed Trapway Comfort Height® 2-Piece Elongated Toilet Bowl

- Clean Caps®
- 12" Rough-in and 3 bolt installation
- 2-1/8" Glazed trapway
- Seat and supply sold separately



K-76301 Combination: K-80020 Elongated Bowl, K-5311 Tank

Part #	Mfg #	Description	Rough-In	Color	Price
190440	K-80020-0	ADA Elongated Bowl	12"	White	

Kelston® Comfort Height® 2-Piece Toilet Bowl

- 16-1/2" High bowl with standard 12" rough-in
- 2-1/8" Glazed trapway
- Seat and supply sold separately



K-3754 Combination: K-4306 Elongated Bowl, K-4474 LH Tank

Part #	Mfg #	Description	Rough-In	Color	Price
128872	K-4306-0	ADA Elongated Bowl	12"	White	
134805	K-4306-95	ADA Elongated Bowl	12"	Ice Grey	
128873	K-4306-96	ADA Elongated Bowl	12"	Biscuit	
141836	K-4306-G9	ADA Elongated Bowl	12"	Sandbar	

Memoirs® Comfort Height® 2-Piece Toilet Bowl

- 16-1/2" High bowl with standard 12" rough-in
- 2-1/8" Glazed trapway
- Seat and supply sold separately



K-3816 Combination: K-4380 Elongated Bowl, K-4433 Tank

K-3817 Combination: K-4380 Elongated Bowl, K-4434 Tank

Part #	Mfg #	Description	Rough-In	Color	Price
138857	K-4380-0	ADA Elongated Bowl	12"	White	
143522	K-4380-47	ADA Elongated Bowl	12"	Almond	

*Vibrant Limited Lifetime Finish

www.waterconcepts.net • Serving our Customers Since 1946 • www.plumbsupply.com

Closet Bowls

Vitreous China Elongated Toilet Bowls (Continued)

Memoirs® Comfort Height® 2-Piece Toilet Bowl

Part #	Mfg #	Description	Rough-In	Color	Price
153529	K-4380-95	ADA Elongated Bowl	12"	Ice Grey	
142402	K-4380-96	ADA Elongated Bowl	12"	Biscuit	
144486	K-4380-G9	ADA Elongated Bowl	12"	Sandbar	
151843	K-4380-NY	ADA Elongated Bowl	12"	Dune	

Memoirs® Comfort Height® Elongated 2-Piece Toilet Bowl with Concealed Trapway

- 12" Rough-in
- 2-1/8" Glazed trapway
- Clean Caps low-profile bolt caps
- Seat and supply sold separately



K-6669 Combination: K-5626 Elongated Bowl, K-4434 Tank

K-6999 Combination: K-5626 Elongated Bowl, K-4433 Tank

Part #	Mfg #	Description	Rough-In	Color	Price
177488	K-5626-0	ADA Elongated Bowl	12"	White	

Persuade™ 2-Piece Toilet Bowl

- Skirted trapway
- Standard 12" rough-in and two bold installation
- Seat sold separately



K-3654 Combination: K-4322 Elongated Bowl, K-4419 Tank

Part #	Mfg #	Description	Rough-In	Color	Price
112447	K-4322-0	Elongated Bowl	12"	White	
131683	K-4322-47	Elongated Bowl	12"	Almond	

Persuade® Comfort Height® 2-Piece Toilet Bowl

- 16-1/2" High bowl with standard 12" rough-in and two bold installation
- Skirted trapway
- Seat sold separately



K-3723 Combination: K-4353 Elongated Bowl, K-4441 Tank

Part #	Mfg #	Description	Rough-In	Color	Price
130588	K-4353-0	ADA Elongated Bowl	12"	White	
139532	K-4353-47	ADA Elongated Bowl	12"	Almond	
131679	K-4353-96	ADA Elongated Bowl	12"	Biscuit	

*Vibrant Limited Lifetime Finish

www.plumbsupply.com • Serving our Customers Since 1946 • www.waterconcepts.net

Closet Bowls

Tresham™ Comfort Height® 2-Piece Toilet Bowl

- 16-1/2" High bowl with standard 12" rough-in
- 2-1/8" Glazed trapway
- Seat and water supply sold separately



K-3950 Combination: K-4799 Elongated Bowl, K-4899 Tank

Part #	Mfg #	Description	Rough-In	Color	Price
143741	K-4799-0	ADA Elongated Bowl	12"	White	
164680	K-4799-33	ADA Elongated Bowl	12"	Mexican Sand	
154995	K-4799-47	ADA Elongated Bowl	12"	Almond	
173771	K-4799-58	ADA Elongated Bowl	12"	Thunder Grey	
144848	K-4799-96	ADA Elongated Bowl	12"	Biscuit	
156436	K-4799-G9	ADA Elongated Bowl	12"	Sandbar	
154947	K-4799-K4	ADA Elongated Bowl	12"	Cashmere	
151846	K-4799-NY	ADA Elongated Bowl	12"	Dune	

Wellworth® 2-Piece Toilet Bowl

- 14-1/2" Bowl height with standard 12" rough-in and 3-bolt installation
- 2-1/8" Glazed trapway
- Seat and supply sold separately



K-3978 Combination: K-4198 Elongated Bowl, K-4468 Tank

Part #	Mfg #	Description	Rough-In	Color	Price
130222	K-4198-0	Elongated Bowl	12"	White	
139927	K-4198-47	Elongated Bowl	12"	Almond	
137506	K-4198-96	Elongated Bowl	12"	Biscuit	

Veil™ One-Piece Elongated Dual-Flush Wall-Hung Toilet with Reveal® Quiet-Close™ Seat

- Compact elongated bowl
- Mounting hardware is completely concealed, giving Veil™ a sleek, seamless look that is easy to clean
- Includes Grip Tight Reveal® Q3 seat



Requires: K-6284-NA or K-18829-NA In-Wall Tank and Carrier System

Part #	Mfg #	Description	Rough-In	Color	Price
160478	K-6299-0	Wall-Mount Elongated Bowl	-	White	
183605	K-6299-7	Wall-Mount Elongated Bowl	-	Black	

*Vibrant Limited Lifetime Finish

www.waterconcepts.net • Serving our Customers Since 1946 • www.plumbsupply.com

Closet Bowls

Vitreous China Round Toilet Bowls

Cimarron® Comfort Height® Round-Front 2-Piece Toilet Bowl

- 2-1/8" Glazed trapway and 12" standard rough-in
- 16-1/2" High bowl is ADA compliant
- Seat and supply sold separately



K-3887 Combination K-4347 Round Bowl, K-4166 Tank
K-3851 Combination K-4829 Round Bowl, K-4166 Tank

Part #	Mfg #	Description	Rough-In	Color	Price
142361	K-4347-0	ADA Round Bowl	12"	White	
145135	K-4347-47	ADA Round Bowl	12"	Almond	
142362	K-4347-96	ADA Round Bowl	12"	Biscuit	
167303	K-4347-NY	ADA Round Bowl	12"	Dune	
154822	K-4829-0	Round Bowl	10"	White	

Highline® Comfort Height® Round-Front Toilet Bowl

- 12" Rough-in
- Three-bolt installation
- 2-1/8" fully glazed trapway
- Combines with a K-4467/-RA or K-4436/-RA tank to create a complete K-5481/-RA or 5296/-RA toilet



Part #	Mfg #	Description	Rough-In	Color	Price
227420	K-5393-0	Round Bowl	12"	White	

Memoirs® Comfort Height® Round-Front Bowl

- Standard 12-inch rough-in
- Combines with the K-4433 or K-4434 tank to create a K-3986 Memoirs® Classic toilet or K-3933 Memoirs® Stately toilet
- Seat sold separately



Part #	Mfg #	Description	Rough-In	Color	Price
148308	K-4387-0	Round Bowl	12"	White	
148917	K-4387-96	Round Bowl	12"	Biscuit	

Wellworth® 2-Piece Toilet Bowl

- 14-1/2" Bowl height with 12" standard rough-in
- 2-1/8" Glazed trapway
- Seat and supply sold separately



K-3977 Combination: K-4197 Round Bowl, K-4468 Tank

Part #	Mfg #	Description	Rough-In	Color	Price
130224	K-4197-0	Round Bowl	12"	White	
139929	K-4197-47	Round Bowl	12"	Almond	

*Vibrant Limited Lifetime Finish

www.plumbsupply.com • Serving our Customers Since 1946 • www.waterconcepts.net

Closet Bowls

Vitreous China Round Toilet Bowls (Continued)

Wellworth® 2-Piece Toilet Bowl

Part #	Mfg #	Description	Rough-In	Color	Price
145938	K-4197-7	Round Bowl	12"	Black	
134924	K-4197-96	Round Bowl	12"	Biscuit	

*Vibrant Limited Lifetime Finish

www.waterconcepts.net • Serving our Customers Since 1946 • www.plumbsupply.com



Closet Bowls

Two-Piece Vitreous China Toilet Bowls

Allerton™ ErgoHeight™ Gravity Fed 2-Piece Toilet Bowl

- 17" Bowl height for accessible application
- 2" Glazed trapway
- Reverse trap
- Seat sold separately



HE-20-007 Combination: HE-21-577 Elongated Bowl, HE-28-580 Tank

HE-20-008 Combination: HE-21-577 Elongated Bowl, HE-28-585 Tank

Part #	Mfg #	Description	Rough-In	Color	Price
158265	HE-21-577	ADA Elongated Bowl	10"	White	

Avalanche™ 2-Piece Toilet Bowl

- 2" Fully-glazed trapway
- Seat sold separately



AV-21-800 Combination: AV-21-852 Round Bowl, AV-28-895 Tank

AV-21-804 Combination: AV-21-852 Round Bowl, AV-28-894 Tank

AV-21-810 Combination: AV-21-862 Elongated Bowl, AV-28-895 Tank

AV-21-814 Combination: AV-21-862 Elongated Bowl, AV-28-894 Tank

Part #	Mfg #	Description	Rough-In	Color	Price
161377	AV-21-852	Round Bowl	-	White	
161544	AV-21-852-09	Round Bowl	-	Biscuit	
161378	AV-21-862	Elongated Bowl	-	White	

Avalanche ErgoHeight™ Gravity Fed 2-Piece 1.6 Toilet Bowl

- 17" Bowl height for accessible application
- Glazed trapway
- Reverse trap
- Compatible with Slimline tank
- Seat sold separately
- 5-Year warranty



AV-21-818 Combination: AV-21-828 ADA Elongated Bowl, AV-28-890 Slimline Tank

AV-21-824 Combination: AV-21-828 ADA Elongated Bowl, AV-28-894 Tank

Part #	Mfg #	Description	Rough-In	Color	Price
161379	AV-21-828	ADA Elongated Bowl	-	White	
161546	AV-21-828-09	ADA Elongated Bowl	-	Biscuit	

Toilets



Closet Bowls

Avalanche High Efficiency ErgoHeight™ Gravity Fed 2-Piece Toilet Bowl

- 17" Bowl height for accessible application
- Glazed trapway
- Reverse trap
- (2) Bolt caps



WS-21-818 Combination: AV-21-828 Elongated Bowl, WS-21-890 Tank

Part #	Mfg #	Description	Rough-In	Color	Price
125896	HE-21-828	ADA Elongated Bowl	12"	White	
125902	HE-21-828-09	ADA Elongated Bowl	12"	Biscuit	

Logan Square™ 2-Piece Toilet Bowl

- Gerber® XP-3 technology
- Glazed trapway
- Reverse trap
- (2) Bolt caps included



HE-20-016 Combination: HE-21-532 Elongated Bowl, HE-28-530 Tank

Part #	Mfg #	Description	Rough-In	Color	Price
163568	HE-21-532	Elongated Bowl	12"	White	

Logan Square™ ErgoHeight™ 2-Piece 1.6 Toilet Bowl

- Gerber® XP-3 technology
- Glazed trapway
- Reverse trap
- (2) Bolt caps included



HE-20-018 Combination: HE-21-538 Elongated Bowl, HE-28-530 Tank

HE-20-019 Combination: HE-21-538 Elongated Bowl, HE-28-530 Tank

Part #	Mfg #	Description	Rough-In	Color	Price
153806	HE-21-538	ADA Elongated Bowl	12"	White	

Toilets



Closet Bowls

Maxwell™ Gravity Fed 2-Piece Toilet Bowl

- Glazed trapway
- Non-corrosive solid brass tank-to-bowl bolts
- Seat sold separately
- 5-Year warranty

21-900 Combination: 21-952 Round Bowl, 28-995 Tank
 21-902 Combination: 21-952 Round Bowl, 28-990 Tank
 21-904 Combination: 21-952 Round Bowl, 28-994 Tank
 21-910 Combination: 21-962 Round Bowl, 28-995 Tank
 21-912 Combination: 21-962 Round Bowl, 28-990 Tank
 21-914 Combination: 21-962 Round Bowl, 28-994 Tank



Part #	Mfg #	Description	Rough-In	Color	Price
138034	21-952	Round Bowl	-	White	
161412	21-952-09	Round Bowl	-	Biscuit	
138033	21-962	Elongated Bowl	-	White	
161424	21-962-09	Elongated Bowl	-	Biscuit	

Maxwell™ ErgoHeight™ Gravity Fed 2-Piece Toilet Bowl

- 17" Bowl height for accessible application
- Glazed trapway
- Non-corrosive solid brass tank-to-bowl bolts
- Seat sold separately
- 5-Year warranty

21-417 Combination: 21-728 Elongated Bowl, 28-495 Tank
 21-418 Combination: 21-728 Elongated Bowl, 28-490 Tank



Part #	Mfg #	Description	Rough-In	Color	Price
138032	21-928	ADA Elongated Bowl	-	White	
161431	21-928-09	ADA Elongated Bowl	-	Biscuit	

Maxwell® High Efficiency Compact ErgoHeight™ 2-Piece Toilet Bowl with Back Outlet

- Space saving compact design
- 2" Fully glazed trapway
- Seat sold separately

20-022 Combination: 21-975 Elongated Bowl, 28-980 Tank



Part #	Mfg #	Description	Rough-In	Color	Price
149993	21-975	ADA Elongated Bowl	4-1/4" Vertical	White	

Toilets



Closet Bowls

Ultra Flush™ Pressure Assist 2-Piece Toilet Bowl

- Trapway averages over 3"
- Seat sold separately
- 10-Year limited warranty

21-302 Combination: 21-342 Round Bowl, 28-380 Tank

21-311 Combination: 21-372 Elongated Bowl, 28-385 Tank

21-312 Combination: 21-372 Elongated Bowl, 28-280 Tank



21-302



21-312

Part #	Mfg #	Description	Rough-In	Color	Price
039791	21-342	Round Bowl	-	White	
039794	21-342-09	Round Bowl	-	Biscuit	
039795	21-372	Elongated Bowl	-	White	
039797	21-372-09	Elongated Bowl	-	Biscuit	
066554	21-374	Elongated Bowl, Back Outlet	4-1/4" Vertical	White	

* With bedpan rim

Ultra Flush™ ErgoHeight™ Pressure Assist 2-Piece Toilet Bowl

- 17" Bowl height for accessible application
- Trapway averages over 3"
- Seat sold separately
- 10-Year limited warranty



21-318

21-317 Combination: 21-377 Elongated Bowl, 28-385 Front Trip

21-318 Combination: 21-377 Elongated Bowl, 28-380 Front Trip

Part #	Mfg #	Description	Rough-In	Color	Price
039798	21-377	ADA Elongated Bowl	-	White	
039800	21-377-09	ADA Elongated Bowl	-	Biscuit	
050467	21-375	ADA Elongated Bowl, Back Outlet	4-1/4" Vertical	White	



Closet Bowls

Viper™ High Performance Gravity Fed 2-Piece Toilet Bowl

- Glazed 2" trapway
- Dual feed siphon-jet
- Reverse trap
- Compatible with Slimline tank
- Seat sold separately
- 5-Year warranty



VP-21-500 Combinations: VP-21-552 Round Bowl, VP-28-595 10" RITank
 VP-21-502 Combination: VP-21-552 Round Bowl, VP-28-590 12" RI Tank
 VP-21-504 Combination: VP-21-552 Round Bowl, VP-28-594 14" RITank
 VP-21-510 Combination: VP-21-562 Elongated Bowl, VP-28-595 10"RI Tank
 VP-21-512 Combination: VP-21-562 Elongated Bowl, VP-28-590 12" RI Tank
 VP-21-514 Combination: VP-21-562 Elongated Bowl, VP-28-594 14" RI Tank

Part #	Mfg #	Description	Rough-In	Color	Price
161339	VP-21-552	Round Bowl	-	White	
161494	VP-21-552-09	Round Bowl	-	Biscuit	
165705	VP-21-552-25	Round Bowl	-	Bone	
161340	VP-21-562	Elongated Bowl	-	White	
161506	VP-21-562-09	Elongated Bowl	-	Biscuit	

Viper™ ErgoHeight™ Gravity Fed 2-Piece Toilet Bowl

- 17" Bowl height for accessible application
- Glazed 2" trapway
- Dual feed siphon-jet
- Reverse trap
- Compatible with Slimline tank
- Seat sold separately
- 5-Year warranty



21-518

VP-21-517 Combination: VP-21-528 Elongated Bowl, VP-28-595 10" RI Tank
 VP-21-518 Combination: VP-21-528 Elongated Bowl, VP-28-590 12" RI Tank
 VP-21-524 Combination: VP-21-528 Elongated Bowl, VP-28-594 14" RI Tank

Part #	Mfg #	Description	Rough-In	Color	Price
161341	VP-21-528	ADA Elongated Bowl	-	White	
161517	VP-21-528-09	ADA Elongated Bowl	-	Biscuit	
166620	VP-21-528-25	ADA Elongated Bowl	-	Bone	

Toilets

Closet Bowls

Two-Piece Vitreous China Toilet Bowls

Karsten® Luxury Height® 2-Piece Toilet Bowl

- (2) Bolt installation
- 5-Year limited warranty

402087 Complete: 402086 Elongated Bowl, 402023 Tank



Part #	Mfg #	Description	Rough-In	Color	Price
135552	402086-0	Elongated Bowl	12"	White	
138448	402086-96	Elongated Bowl	12"	Biscuit	

Riverton™ High-Efficiency 2-Piece Toilet Bowl

- Completely code approved
- (3) Bolt installation
- 2" Glazed trapway
- 8" x 9" Water area
- Seat and supply sold separately
- 5-Year limited warranty

402083 Complete: 403015 Round Bowl, 404552 Tank

402084 Complete: 403215 Elongated Bowl, 404552 Tank



402083



402084

Part #	Mfg #	Description	Rough-In	Color	Price
134274	403015-0	Round Bowl	12"	White	
134275	403015-96	Round Bowl	12"	Biscuit	
136949	403215-0	Elongated Bowl	12"	White	

Windham™ Low Consumption 2-Piece Toilet Bowl

- Completely code approved
- (2) Bolt installation
- Seat sold separately
- 5-Year warranty

402014 Complete: 403015 Round Bowl, 404514 Tank

402015 Complete: 403015 Round Bowl, 404515 Tank

402210 Complete: 404210 Elongated Bowl, 404515 Tank



402015

Part #	Mfg #	Description	Rough-In	Color	Price
073992	404210-0	Elongated Bowl	10"	White	

Toilets

Closet Bowls

Windham™ Low Consumption Luxury Height® 2-Piece Toilet Bowl

- 16-1/2" Bowl heights meets ADA requirements
- 2" Glazed trapway
- Seat and supply sold separately
- 8" x 9" Water area
- (3) Bolt, quick-connect installation system
- Meets EPA WaterSense® criteria
- 5-Year limited warranty



403315-0



402082 Complete: 403315 Elongated Bowl, 404555 Tank

402082-RA Complete: 403315 Elongated Bowl, 404555-RA Tank

Part #	Mfg #	Description	Rough-In	Color	Price
135047	403315-0	ADA Elongated Bowl	12"	White	
131645	403315-96	ADA Elongated Bowl	12"	Biscuit	

Closet Bowls

Two-Piece Vitreous China Toilet Bowls
Stealth® Ultra High-Efficiency 2-Piece Toilet Bowl

- 8" x 6" Water surface area
- Seat sold separately
- 10-Year limited warranty



N7716R Complete: N7716B Round Bowl, N7714T Tank

Part #	Mfg #	Description	Rough-in	Color	Price
131373	N7716B	Round Bowl	12"	White	

Closet Tanks

Two-Piece Vitreous China Toilet Tanks

Archer® Comfort Height® 2-Piece 1.28 Toilet Tank with Chrome Trip Lever

- Class Five® flushing system
- Meets EPA WaterSense® criteria



K-3551 Combination: K-4356 Elongated Bowl, K-4431 Tank

Part #	Mfg #	Description	Rough-In	Color	Price
144889	K-4431-0	Tank, LH CP Trip	-	White	
144568	K-4431-K4	Tank, LH CP Trip	-	Cashmere	
152288	K-4431-NY	Tank, LH CP Trip	-	Dune	

Bancroft® Comfort Height® 2-Piece 1.28 Toilet Tank with Chrome Trip Lever

- High-efficiency for significant water savings
- Class Five® flushing system
- Meets EPA WaterSense® criteria



K-3827 Combination: K-4067 Elongated Bowl, K-4383 Tank

Part #	Mfg #	Description	Rough-In	Color	Price
141790	K-4383-0	Tank, LH CP Trip	-	White	
155567	K-4838-33	Tank, LH CP Trip	-	Mexican Sand	
155568	K-4838-95	Tank, LH CP Trip	-	Ice Grey	

Cimarron® Comfort Height® 2-Piece 1.28 Toilet Tank with Chrome Trip Lever

- AquaPiston® flush technology
- Meets EPA WaterSense® criteria



K-3887 Combination K-4347 Round Bowl, K-4166 Tank

Part #	Mfg #	Description	Rough-In	Color	Price
142359	K-4166-0	Tank, LH CP Trip	-	White	
142360	K-4166-96	Tank, LH CP Trip	-	Biscuit	
151716	K-4166-U-0	Tank with Insuliner®, LH CP Trim	-	White	

Cimarron® 1.28 gpf High Efficiency Toilet Tank with AquaPiston® Flush Technology & Left-Hand Trip Lever

- DryLock™ System
- Meets EPA WaterSense® criteria
- Supply line not included
- (-RA) right-hand trip lever
- (-U) Insuliner® tank liner
- (-UR) Insuliner® tank liner with right-hand trip lever



K-3609 Combination: K-4309 Elongated Bowl, K-4421 Tank

Part #	Mfg #	Description	Rough-In	Color	Price
118679	K-4421-0	Tank, LH CP Trip	-	White	

*Vibrant Limited Lifetime Finish

www.plumbsupply.com • Serving our Customers Since 1946 • www.waterconcepts.net

Closet Tanks

Two-Piece Vitreous China Toilet Tanks (Continued)

Cimarron® 1.28 gpf High Efficiency Toilet Tank with AquaPiston® Flush Technology & Left-Hand Trip Lever

Part #	Mfg #	Description	Rough-In	Color	Price
154388	K-4421-95	Tank, RH CP Trip	-	Ice Grey	
122222	K-4421-96	Tank, LH CP Trip	-	Biscuit	
151731	K-4421-RA-0	Tank, RH CP Trip	-	White	
155355	K-4421-U-0	Tank, LH CP Trip, with Insuliner®	-	White	
155818	K-4421-UR-0	Tank, RH CP Trip, with Insuliner®	-	White	

Cimarron® 1.6 gpf Toilet Tank with AquaPiston® Flush Technology with Chrome Left-Hand Trip Lever

- Supply line not included
- (-RA) Right-hand trip lever



K-3589 Combination: K-4309 Elongated Bowl, K-4418 Tank

Part #	Mfg #	Description	Rough-In	Color	Price
116904	K-4418-0	Tank, LH Trip	-	White	
119007	K-4418-47	Tank, LH Trip	-	Almond	
125325	K-4418-7	Tank, LH Trip	-	Black	
120794	K-4418-95	Tank, LH Trip	-	Ice Grey	
116905	K-4418-96	Tank, LH Trip	-	Biscuit	
129139	K-4418-G9	Tank, LH Trip	-	Sandbar	
127768	K-4418-RA-0	Tank, RH Trip	-	White	

Cimarron® 1.6 gpf Toilet Tank with Polished Chrome Left-Hand Trip Lever

- DryLock™ System
- Meets EPA WaterSense® criteria



K-3888 Combination: K-4347 Round Bowl, K-4167 Tank

Part #	Mfg #	Description	Rough-In	Color	Price
147234	K-4167-0	Tank, LH CP Trip	-	White	
146873	K-4167-47	Tank, LH CP Trip	-	Almond	
146264	K-4167-96	Tank, LH CP Trip	-	Biscuit	

Cimarron® 1.28 gpf Touchless Toilet Tank

- Powered by 4 AA batteries (included)
- Flush is activated by a no-touch sensor mounted inside the tank
- AquaPiston® canister
- Touchless has no impact on water usage
- Combines with the K-4309 bowl to create a complete K-6418 Cimarron® toilet



Part #	Mfg #	Description	Rough-In	Color	Price
167292	K-5692-0	Touchless Tank	-	White	
177070	K-5692-G9	Touchless Tank	-	Sandbar	

*Vibrant Limited Lifetime Finish

www.waterconcepts.net • Serving our Customers Since 1946 • www.plumbsupply.com

Closet Tanks

Devonshire® 1.28 gpf Toilet Tank with Class Five® Flushing Technology & Chrome Left-Hand Trip Lever

- Meets EPA WaterSense® criteria



K-3837 Combination: K-4397 Elongated Bowl, K-4438 Tank

Part #	Mfg #	Description	Rough-In	Color	Price
141573	K-4438-0	Tank, LH CP Trip	-	White	
141580	K-4438-47	Tank, LH CP Trip	-	Almond	
183570	K-4438-7	Tank, LH CP Trip	-	Black Black	
141577	K-4438-96	Tank, LH CP Trip	-	Biscuit	
183678	K-4438-G9	Tank, LH CP Trip	-	Sandbar	

Wellworth® 1.6 gpf Toilet Tank with Class Five® Flushing Technology & Chrome Trip Lever

- Canister flush valve
- Supply not included
- (-R) Right-hand trip lever
- (-T) Tank locks
- Combines with the K-4199 bowl to create a complete K-3979 Highline toilet, combines with the K-4198 bowl to create a complete K-3978 Wellworth toilet, and combines with the K-4197 bowl to create a complete K-3977 Wellworth toilet



K-3979 Combination: K-4199 Elongated Bowl, K-4468 Tank

Part #	Mfg #	Description	Rough-In	Color	Price
137507	K-4468-0	LH CP Trip	-	White	
140397	K-4468-7	LH CP Trip	-	Black Black	
138353	K-4468-47	LH CP Trip	-	Almond	
137508	K-4468-96	LH CP Trip	-	Biscuit	
142859	K-4468-RA-0	RH CP Trip	-	White	
141866	K-4468-RA-96	RH CP Trip	-	Biscuit	
149478	K-4468-T-0	LH CP Trip , with Tank Locks	-	White	
153821	K-4468-TR-0	RH CP Trip , with Tank Locks	-	White	

Wellworth® 1.28 gpf Toilet Tank for Concealed Trapway Bowl

- Standard left-hand trip lever included
- Class Five® flushing technology
- Supply not included
- Combines with the K-80020 bowl to create K-76301 Highline® concealed trapway toilet



Part #	Mfg #	Description	Rough-In	Color	Price
190438	5311-0	LH CP Trip	-	White	

*Vibrant Limited Lifetime Finish

www.plumbsupply.com • Serving our Customers Since 1946 • www.waterconcepts.net

Closet Tanks

Highline® Classic 2-Piece 1.6 gpf Toilet Tank

- Pressure Lite® flushing system
- (-R) right-hand trip lever
- (-T) Tank cover locks



K-3493 Combination: K-4304 Elongated Bowl, K-4645 Tank

Part #	Mfg #	Description	Rough-In	Color	Price
086518	K-4645-0	Tank, LH CP Trip	-	White	
088819	K-4645-47	Tank, LH CP Trip	-	Almond	
112018	K-4645-7	Tank, LH CP Trip	-	Black	
086521	K-4645-96	Tank, LH CP Trip	-	Biscuit	
090412	K-4645-RA-0	Tank, RH CP Trip	-	White	
162760	K-4645-RA-96	Tank, RH CP Trip	-	Biscuit	
090159	K-4645-T-0	Tank, LH CP Trip	-	White	
091896	K-4645-TR-0	Tank, RH CP Trip	-	White	

Highline® Classic 1.0 gpf Toilet Tank with Left Hand Trip Lever

- Vitreous China
- (-RA) Right-hand trip lever
- (-T) Tank cover locks
- Combine with K-4303 or K-4303-L to create K-3531 Wellworth® Pressure Lite® 1.0 gpf toilet
- Combine with K-4304 or K-4304-L to create Highline® Pressure Lite® 1.0 gpf toilet



Part #	Mfg #	Description	Rough-In	Color	Price
103327	K-4484-0	Tank, LH CP Trip	-	White	
133865	K-4484-T-0	Tank, LH CP Trip	-	White	
106012	K-4484-RA-0	Tank, RH CP Trip	-	White	

Kelston® 1.6 Toilet Tank with Left-Hand Trip Lever

- Class Five® flushing system



K-3754 Combination: K-4306 Elongated Bowl, K-4474 LH Tank

Part #	Mfg #	Description	Rough-In	Color	Price
128874	K-4474-0	Tank, LH CP Trip	-	White	
134804	K-4474-95	Tank, LH CP Trip	-	Ice Grey	
128875	K-4474-96	Tank, LH CP Trip	-	Biscuit	
141837	K-4474-G9	Tank, LH CP Trip	-	Sandbar	

*Vibrant Limited Lifetime Finish

www.waterconcepts.net • Serving our Customers Since 1946 • www.plumbsupply.com

Closet Tanks

Kelston® 1.28 Toilet Tank with Left-Hand Trip Lever

- Class Five® flushing system
- Combines with the K-4306 bowl to create a complete K-3755 Kelston toilet



Part #	Mfg #	Description	Rough-In	Color	Price
132321	K-4469-0	Tank, LH CP Trip	-	White	

Memoirs® 1.28 gpf Toilet Tank with Chrome Left-hand Trip Lever

- Class Five® flushing technology
- Meets EPA WaterSense® criteria
- Supply line not included
- (-RA) Right-hand trip lever



K-4433



K-4434



K-3816 Combination: K-4380 Elongated Bowl, K-4433 Tank

K-3817 Combination: K-4380 Elongated Bowl, K-4434 Tank

Part #	Mfg #	Description	Rough-In	Color	Price
142688	K-4433-0	Classic Tank, LH CP Trip	-	White	
149296	K-4433-47	Classic Tank, LH CP Trip	-	Almond	
153530	K-4433-95	Classic Tank, LH CP Trip	-	Ice Grey	
142689	K-4433-96	Classic Tank, LH CP Trip	-	Biscuit	
152497	K-4433-G9	Classic Tank, LH CP Trip	-	Sandbar	
165402	K-4433-NY	Classic Tank, LH CP Trip	-	Dune	
226264	K-4433-RA-0	Classic Tank, RH CP Trip	-	White	
138858	K-4434-0	Stately Tank, LH CP Trip	-	White	
143523	K-4434-47	Stately Tank, LH CP Trip	-	Almond	
142690	K-4434-96	Stately Tank, LH CP Trip	-	Biscuit	
160613	K-4434-G9	Stately Tank, LH CP Trip	-	Sandbar	
151844	K-4434-NY	Stately Tank, LH CP Trip	-	Dune	
154371	K-4434-RA-0	Stately Tank, RH CP Trip	-	White	

Memoirs® 1.6 gpf Toilet Tank with Chrome Left-Hand Trip Lever

- Class Five® flushing system
- Supply line not included



K-4641



K-4642

K-3818 Combination: K-4380 Elongated Bowl, K-4641 LH Trip Classic Tank

K-3819 Combination: K-4380 Elongated Bowl, K-4642 LH Trip Stately Tank

Part #	Mfg #	Description	Rough-In	Color	Price
142795	K-4641-0	Classic Tank, LH Trip	-	White	
154819	K-4641-47	Classic Tank, LH Trip	-	Almond	
183574	K-4641-7	Classic Tank, LH Trip	-	Black Black	
142403	K-4641-96	Classic Tank, LH Trip	-	Biscuit	
144631	K-4642-0	Stately Tank, LH Trip	-	White	
145321	K-4642-47	Stately Tank, LH Trip	-	Almond	

*Vibrant Limited Lifetime Finish

www.plumbsupply.com • Serving our Customers Since 1946 • www.waterconcepts.net

Closet Tanks

Two-Piece Vitreous China Toilet Tanks (Continued)
Memoirs® 1.6 gpf Toilet Tank with Chrome Left-Hand Trip Lever

Part #	Mfg #	Description	Rough-In	Color	Price
156880	K-4642-96	Stately Tank, LH Trip	-	Biscuit	

Persuade™ 2-Piece Dual Flush 1.6 or 0.8 gpf Toilet Tank

- Includes 2-button actuator that provides easy-to-use flushing options
- Meets EPA WaterSense® criteria



K-3654 Combination: K-4322 Elongated Bowl, K-4419 Tank

Part #	Mfg #	Description	Rough-In	Color	Price
112448	K-4419-0	Dual Flush Tank	-	White	
131684	K-4419-47	Dual Flush Tank	-	Almond	

Persuade® Curve Dual-Flush 1.6 or 1.0 gpf Toilet Tank

- Includes 2-button actuator that provides easy-to-use flushing options
- Meets EPA WaterSense® criteria



K-3723 Combination: K-4353 Elongated Bowl, K-4441 Tank

Part #	Mfg #	Description	Rough-In	Color	Price
130587	K-4441-0	Dual Flush Tank	-	White	
139998	K-4441-47	Dual Flush Tank	-	Almond	
144136	K-4441-7	Dual Flush Tank	-	Black	
131680	K-4441-96	Dual Flush Tank	-	Biscuit	

Wellworth® Classic 1.28 gpf Toilet Tank

- Class Five® flushing system
- Meets EPA WaterSense® criteria



Part #	Mfg #	Description	Rough-In	Color	Price
130221	K-4436-0	LH Chrome Trip	-	White	
150026	K-4436-47	LH Chrome Trip	-	Almond	
151969	K-4436-7	LH Chrome Trip	-	Black	
134923	K-4436-96	LH Chrome Trip	-	Biscuit	

*Vibrant Limited Lifetime Finish

www.waterconcepts.net • Serving our Customers Since 1946 • www.plumbsupply.com

Closet Tanks

Tresham™ 1.28 gpf Toilet Tank with Chrome Left-hand Trip Lever

- Class Five® flushing system
- Meets EPA WaterSense® criteria
- Supply line not included



K-3950 Combination: K-4799 Elongated Bowl, K-4899 Tank

Part #	Mfg #	Description	Rough-In	Color	Price
143742	K-4899-0	Tank, LH CP Trip	-	White	
164681	K-4899-33	Tank, LH CP Trip	-	Mexican Sand	
154994	K-4899-47	Tank, LH CP Trip	-	Almond	
173770	K-4899-58	Tank, LH CP Trip	-	Thunder Grey	
145962	K-4899-96	Tank, LH CP Trip	-	Biscuit	
156437	K-4899-G9	Tank, LH CP Trip	-	Sandbar	
154948	K-4899-K4	Tank, LH CP Trip	-	Cashmere	
151847	K-4899-NY	Tank, LH CP Trip	-	Dune	

Wellworth® 1.28 gpf Toilet Tank with Chrome-Plated Trip Lever & Class Five® Flush Technology

- Large 3-1/4" canister flush valve
- Qualifies as a HET (High-efficiency toilet)
- Meets EPA WaterSense® criteria
- (-R) right-hand trip lever
- (-U) Insuliner® tank liner
- (-T) Locks



K-3948 Combination: K-4198 Elongated Bowl, K-4841 Tank
K-3998 Combination: K-4198 Elongated Bowl, K-4467 Tank
K-3889 Combination: K-4373 Elongated Bowl, K-4467 Tank
K-3999 Combination: K-4199 Elongated Bowl, K-4467 Tank
K-3999-U Combination: K-4199 Elongated Bowl, K-4467-U Tank

Part #	Mfg #	Description	Rough-In	Color	Price
137509	K-4467-0	Tank, LH CP Trip	-	White	
139417	K-4467-47	Tank, LH CP Trip	-	Almond	
137510	K-4467-96	Tank, LH CP Trip	-	Biscuit	
153678	K-4467-RA-0	Tank, RH CP Trip	-	White	
146790	K-4467-RA-96	Tank, RH CP Trip	-	Biscuit	
149341	K-4467-T-0	Tank, LH CP Trip	-	White	
190453	K-4467-TR-0	Tank, RH CP Trip	-	White	
140988	K-4467-U-0	Tank, LH Trip Lever, with Insuliner®		White	
140989	K-4467-UR-0	Tank, RH Trip Lever, with Insuliner®		White	
137512	K-4841-0	Tank, LH CP Trip	14"	White	
137513	K-4841-96	Tank, LH CP Trip	14"	Biscuit	
181018	K-4841-U-O	Tank, LH CP Trip with Insuliner®	14"	White	
188274	K-4841-RA-0	Tank, RH CP Trip	14"	White	

*Vibrant Limited Lifetime Finish

www.plumbsupply.com • Serving our Customers Since 1946 • www.waterconcepts.net

Closet Tanks

Veil® In-Wall Tank and Carrier System

- Robust steel tub frame
- Insulated tank to prevent sweating
- Large flush actuator plate opening can be removed for easy access to the inner tank
- Adjustable height allowing the bowl to be set anywhere from 15-3/8" to 28-1/2" from floor
- Dual flush actuator offers a choice of 0.8 or 1.6 gpf



Combines with the K-6299 bowl to create a complete K-6303 Veil toilet or with a K-6300 bowl to create a complete K-6304

Part #	Mfg #	Description	Rough-In	Color	Price
160477	K-6284-NA	2"x6" In-Wall Tank and Carrier System	-	N/A	

In-Wall Tank and Carrier System

- Robust steel tube frame
- Insulated tank to prevent sweating
- Large flush actuator plate
- Adjustable height
- Dual flush actuator offers a choice of 0.8 or 1.6 gpf
- Dual flush technology
- Supply line not included
- Works with K-6299 bowl as well as K-4177 and K-8857 flush actuator plates to create a complete solution



Part #	Mfg #	Description	Rough-In	Color	Price
177776	K-18829-NA	2"x4" In-Wall Tank and Carrier System	-	N/A	



Closet Tanks

Two-Piece Vitreous China Toilet Tanks

Avalanche™ 2-Piece 1.6 Toilet Tank

- Fluidmaster® fill valve
- Dual-fed siphon jet
- Color-matched tank lever



- AV-21-800 Combination: AV-21-852 Round Bowl, AV-28-895 Tank
 AV-21-802 Combination: AV-21-852 Round Bowl, AV-28-890 Tank
 AV-21-804 Combination: AV-21-852 Round Bowl, AV-28-894 Tank
 AV-21-810 Combination: AV-21-862 Elongated Bowl, AV-28-895 Tank
 AV-21-814 Combination: AV-21-862 Elongated Bowl, AV-28-894 Tank

Part #	Mfg #	Description	Rough-In	Color	Price
161380	AV-28-895	Tank, Side Trip	10"	White	
161381	AV-28-890	Tank, Side Trip	12"	White	
161548	AV-28-890-09	Slimline Tank, Side Trip	12"	Biscuit	
161382	AV-28-894	Tank, Side Trip	14"	White	

Avalanche™ High Efficiency Gravity Fed 2-Piece 1.28 Toilet Tank

- 3" Flush valve
- Fluidmaster® fill valve
- Dual-feed jet
- Side tank lever
- Meets EPA WaterSense® criteria



- WS-21-802 Combination: WS-21-852 Round Bowl, WS-28-890 Tank
 WS-21-812 Combination: WS-21-862 Elongated Bowl, WS-28-890 Tank

Part #	Mfg #	Description	Rough-In	Color	Price
161394	WS-28-890	Tank, Side Trip	12"	White	
161565	WS-28-890-09	Tank, Side Trip	12"	Biscuit	

Logan Square™ 2-Piece 1.6 Toilet Tank

- Gerber® XP-3 technology
- 3" Flush valve
- Fluidmaster® fill valve
- Dual-feed jet
- Side tank lever



- 20-016 Combination: 21-532 Elongated Bowl, 28-530 Tank

Part #	Mfg #	Description	Rough-In	Color	Price
126922	28-530	Tank	12"	White	

Toilets



Closet Tanks

Logan Square™ ErgoHeight™ 2-Piece 1.6 Toilet Tank

- Gerber® XP-3 technology
- 3" Flush valve
- Fluidmaster® fill valve
- Dual-feed jet
- Side tank lever



20-018 Combination: 21-538 Elongated Bowl, 28-530 Tank

Part #	Mfg #	Description	Rough-In	Color	Price
119892	28-535	Tank	10"	White	

Maxwell™ Gravity Fed 2-Piece 1.6 Toilet Tank

- Non-corrosive solid brass tank-to-bowl bolts
- 5-Year warranty

MX-21-400 Combination: 21-952 Round Bowl, MX-28-995 Front Trip

MX-21-402 Combination: 21-952 Round Bowl, MX-28-990 Front Trip

MX-21-404 Combination: 21-952 Round Bowl, MX-28-994 Front Trip

MX-21-410 Combination: 21-962 Elongated Bowl, 28-995 Front Trip

MX-21-412 Combination: 21-962 Elongated Bowl, 28-990 Front Trip



21-402



21-412

ErgoHeight™ Combinations:

MX-21-417 Combination: 21-928 Elongated Bowl, 28-995 Tank

MX-21-418 Combination: 21-928 Elongated Bowl, 28-990 Tank

Part #	Mfg #	Description	Rough-In	Color	Price
161308	MX-28-990	Tank, LH Trip	12"	White	
161414	MX-28-990-09	Tank, LH Trip	12"	Biscuit	
170306	MX-28-990-25	Tank, LH Trip	12"	Bone	
167299	MX-28-990-97	Tank, RH Trip	12"	White	
161309	MX-28-994	Tank, LH Trip	14"	White	
161422	MX-28-994-09	Tank, LH Trip	14"	Biscuit	
161307	MX-28-995	Tank, LH Trip	10"	White	

Toilets



Closet Tanks

Maxwell® High Efficiency 2-Piece 1.28 Toilet Tank

- Dual-fed siphon jet
- Pilot fill valve
- 3" Flush valve
- Color-matched front tank lever

21-902 Combination: 21-952 Round Bowl, 28-990 Tank
 21-912 Combination: 21-962 Elongated Bowl, 28-990 Tank



ErgoHeight™ Combinations:

21-918 Combination: 21-928 Elongated Bowl, 28-990 Tank

Part #	Mfg #	Description	Rough-In	Color	Price
138035	28-990	Tank	12"	White	

Maxwell® High Efficiency Compact ErgoHeight™ 2-Piece 1.28 Toilet Tank

- 3" Flush valve
- Dual-fed siphon jet
- Pilot fill valve
- Color-matched front tank lever

20-022 Combination: 21-975 Elongated Bowl, 28-980 Tank



Part #	Mfg #	Description	Rough-In	Color	Price
150550	28-980	Tank	4-1/4" Vertical	White	

Maxwell® LX 2-Piece 1.6 Toilet Tank

- Front jet flushing action

21-102 Combination: 21-152 Round Bowl, 28-190 Tank

Part #	Mfg #	Description	Rough-In	Color	Price
004655	28-190	Tank	12"	White	



Closet Tanks

Ultra Flush™ Pressure Assist 2-Piece 1.6 Toilet Tank

- Sloan Flushmate pressure vessel
- Insulated non-sweating tank
- 10-Year limited warranty

21-302 Combination: 21-342 Round Bowl, 28-380 Tank

21-311 Combination: 21-372 Elongated Bowl, 28-385 Tank

21-312 Combination: 21-372 Elongated Bowl, 28-280 Tank



21-302

21-312

ErgoHeight™ Combinations:

21-317 Combination: 21-377 Elongated Bowl, 28-385 Front Trip

21-318 Combination: 21-377 Elongated Bowl, 28-380 Front Trip

Part #	Mfg #	Description	Rough-In	Color	Price
039785	28-380	Tank, LH Trip	12"	White	
039787	28-380-09	Tank, LH Trip	12"	Biscuit	
058856	28-380-97	Tank, RH Trip	12"	White	
039788	28-384	Tank, LH Trip	14"	White	
039789	28-384-25	Tank, LH Trip	14"	Bone	
039780	28-385	Tank, LH Trip	10"	White	

Ultra Flush™ Dual-Flush Pressure Assist 2-Piece 1.1/1.6 Toilet Tank

- HET High efficiency toilet
- Meets EPA WaterSense® criteria
- Non-corrosive solid brass tank-to-bowl bolts

DF-21-302 Combination: 21-342 Round Bowl, DF-28-380 Front Trip

DF-21-304 Combination: 21-342 Round Bowl, DF-28-384 Front Trip

DF-21-312 Combination: 21-372 Elongated Bowl, DF-28-380 Front Trip

DF-21-310 Combination: 21-374 Elongated Bowl, DF-28-380 Front Trip

DF-21-314 Combination: 21-372 Elongated Bowl, DF-28-384 Front Trip



21-302

21-312

21-310

ErgoHeight™ Combinations:

DF-21-318 Combination: 21-377 Elongated Bowl, DF-28-380 Front Trip

DF-21-324 Combination: 21-377 Elongated Bowl, DF-28-384 Tank

DF-21-325 Combination: 21-375 Elongated Bowl, DF-28-380 Tank



Part #	Mfg #	Description	Rough-In	Color	Price
091666	DF-28-380	Tank, LH Trip	12"	White	
118354	DF-28-380-97	Tank, RH Trip	12"	White	
091841	DF-28-384	Tank, LH Trip	14"	White	

Toilets



Closet Tanks

Ultra Flush™ ErgoHeight™ Pressure Assist High Efficiency 2-Piece 1.1 Toilet Tank

- 17" Bowl height for accessible application
- Non-corrosive solid brass tank-to-bowl bolts
- Meets EPA WaterSense® criteria



EF-21-318 Combination: 21-377 Elongated Bowl, EF-28-380 Front Trip

EF-21-325 Combination: 21-375 Elongated Bowl, EF-28-380 Front Trip

Part #	Mfg #	Description	Rough-In	Color	Price
136315	EF-28-380	Tank, LH Trip	12"	White	

Viper™ High Performance Gravity Fed 2-Piece 1.6 Toilet Tank

- HP2 Flushing technology
- Fluidmaster® fill valve
- Dual-feed siphon-jet
- 5-Year warranty



21-502



21-512

VP-21-502 Combination: VP-21-552 Round Bowl, VP-28-590 Tank

VP-21-504 Combination: VP-21-552 Round Bowl, VP-28-594 Tank

VP-21-512 Combination: VP-21-562 Elongated Bowl, VP-28-590 Tank

ErgoHeight™ Combinations:

VP-21-517 Combination: VP-21-528 Elongated Bowl, VP-28-595 Tank

VP-21-518 Combination: VP-21-528 Elongated Bowl, VP-28-590 Tank

VP_21-524 Combination: VP-21-528 Elongated Bowl, VP-28-594 Tank

Part #	Mfg #	Description	Rough-In	Color	Price
161335	VP-28-595	Tank, LH Trip	10"	White	
161495	VP-28-595-09	Tank, LH Trip	10"	Biscuit	
161336	VP-28-590	Tank, LH Trip	12"	White	
161500	VP-28-590-09	Tank, LH Trip	12"	Biscuit	
165706	VP-28-590-25	Tank, LH Trip	12"	Bone	
166182	VP-28-590-97	Tank, RH Trip	12"	White	
166185	VP-28-592	Insulated Tank, LH Trip, For 21-518 Series	12"	White	
161337	VP-28-594	Tank, LH Trip	14"	White	
161504	VP-28-594-09	Tank, LH Trip	14"	Biscuit	

Toilets

Closet Tanks

Two-Piece Vitreous China Toilet Tanks

Windham™ Low Consumption 2-Piece 1.6 Toilet Tank

- Completely code approved
- One flush performance limited guarantee
- Meets EPA WaterSense® criteria
- 5-Year warranty



402015 Complete: 403015 Round Bowl, 404515 Tank

402210 Complete: 404210 Elongated Bowl, 404515 Tank

402215 Complete: 403215 Elongated Bowl, 404515 Tank

Part #	Mfg #	Description	Rough-In	Color	Price
074000	404515-0	Tank with LH Trip, Lid & Trim	-	White	
074002	404515-96	Tank with LH Trip, Lid & Trim	-	Biscuit	

Closet Tanks

Two-Piece Vitreous China Toilet Tanks

Stealth® Ultra High-Efficiency 2-Piece 0.80 Toilet Tank

- Quiet siphonic flushing
- Patented flush chamber and air transfer system
- Polished chrome top-mount flush actuator
- 10-Year limited warranty
- Meets EPA WaterSense® criteria



N7716R Complete: N7716B Round Bowl, N7714T Tank

Part #	Mfg #	Description	Rough-in	Color	Price
131374	N7714T	Tank	12"	White	

Toilets

Elongated Closets

Two-Piece Vitreous China Toilets

Archer® Comfort Height® 2-Piece 1.28 gpf Toilet with AquaPiston® Flushing Technology

- 16-1/2" High bowl is ADA compliant
- 2-1/8" Glazed trapway
- Includes left-hand trip lever
- Seat and supply sold separately
- Meets EPA WaterSense® criteria



K-3551 Combination: K-4356 Elongated Bowl, K-4431 Tank

Part #	Mfg #	Description	Rough-In	Color	Price
144891	K-3551-0	ADA Elongated Complete	12"	White	
145613	K-3551-33	ADA Elongated Complete	12"	Mexican Sand	
175354	K-3551-47	ADA Elongated Complete	12"	Almond	
166339	K-3551-58	ADA Elongated Complete	12"	Thunder Grey	
174538	K-3551-7	ADA Elongated Complete	12"	Black	
144065	K-3551-95	ADA Elongated Complete	12"	Ice Grey	
148497	K-3551-96	ADA Elongated Complete	12"	Biscuit	
146027	K-3551-G9	ADA Elongated Complete	12"	Sandbar	
144569	K-3551-K4	ADA Elongated Complete	12"	Cashmere	
152289	K-3551-NY	ADA Elongated Complete	12"	Dune	

Bancroft® Comfort Height® 2-Piece 1.28 Toilet with AquaPiston® Flush Technology

- 2-1/8" Glazed trapway
- 16-1/2" High bowl is ADA compliant
- Includes left-hand polished chrome trip lever
- Seat and supply sold separately
- Meets EPA WaterSense® criteria



K-3827 Combination: K-4067 Elongated Bowl, K-4383 Tank

Part #	Mfg #	Description	Rough-In	Color	Price
141791	K-3827-0	ADA Elongated Complete, LH CP Trip	12"	White	
155569	K-3827-33	ADA Elongated Complete, LH CP Trip	12"	Mexican Sand	
147081	K-3827-47	ADA Elongated Complete, LH CP Trip	12"	Almond	
185234	K-3827-7	ADA Elongated Complete, LH CP Trip	12"	Black	
155570	K-3827-95	ADA Elongated Complete, LH CP Trip	12"	Ice Grey	
141774	K-3827-96	ADA Elongated Complete, LH CP Trip	12"	Biscuit	
144642	K-3827-G9	ADA Elongated Complete, LH CP Trip	12"	Sandbar	
146076	K-3827-K4	ADA Elongated Complete, LH CP Trip	12"	Cashmere	
148139	K-3827-NY	ADA Elongated Complete, LH CP Trip	12"	Dune	

*Vibrant Limited Lifetime Finish

www.waterconcepts.net • Serving our Customers Since 1946 • www.plumbsupply.com

Elongated Closets

Cimarron® Comfort Height® 2-Piece 1.6 Toilet with Left-Hand Trip Lever

- AquaPiston® flushing system
- 16-1/2" High bowl is ADA compliant
- Seat and supply sold separately
- (-RA) Right-hand trip lever



K-3589 Combination: K-4309 Elongated Bowl, K-4418 Tank

Part #	Mfg #	Description	Rough-In	Color	Price
116908	K-3589-0	ADA Elongated Complete	12"	White	
119008	K-3589-47	ADA Elongated Complete	12"	Almond	
125327	K-3589-7	ADA Elongated Complete	12"	Black	
120795	K-3589-95	ADA Elongated Complete	12"	Ice Grey	
116909	K-3589-96	ADA Elongated Complete	12"	Biscuit	
129140	K-3589-G9	ADA Elongated Complete	12"	Sandbar	
157442	K-3589-NY	ADA Elongated Complete	12"	Dune	
127769	K-3589-RA-0	ADA Elongated Complete, RH Trip	12"	White	
174416	K-3589-RA-96	ADA Elongated Complete, RH Trip	12"	Biscuit	

Cimarron® Comfort Height® 2-Piece 1.28 Toilet with AquaPiston® Flush Technology & Left-Hand Trip Lever

- 16-1/2" High bowl with 12" standard rough-in
- 2-1/8" Fully glazed trapway
- Seat and supply sold separately
- (-RA) Right-hand trip lever
- (-U) Insuliner® tank liner



K-3906 Combination: K-4309 Elongated Bowl, K-4421 Tank

Part #	Mfg #	Description	Rough-In	Color	Price
119584	K-3609-0	ADA Elongated Complete, LH CP Trip	12"	White	
134220	K-3609-47	ADA Elongated Complete, LH CP Trip	12"	Almond	
150307	K-3609-7	ADA Elongated Complete, LH CP Trip	12"	Black	
154389	K-3609-95	ADA Elongated Complete, LH CP Trip	12"	Ice Grey	
122223	K-3609-96	ADA Elongated Complete, LH CP Trip	12"	Biscuit	
149750	K-3609-G9	ADA Elongated Complete, LH CP Trip	12"	Sandbar	
171312	K-3609-RA-0	ADA Elongated Complete, RH CP Trip	12"	White	
156508	K-3609-U-0	ADA Elongated Complete with Tank Insuliner, LH CP Trip	12"	White	
150539	K-3609-U-96	ADA Elongated Complete with Tank Insuliner, LH CP Trip	12"	Biscuit	

*Vibrant Limited Lifetime Finish

www.plumbsupply.com • Serving our Customers Since 1946 • www.waterconcepts.net

Elongated Closets

Cimarron® Touchless Comfort Height® 2-Piece 1.28 Toilet with AquaPiston® Flushing Technology

- Flush is activated by a no-touch sensor mounted inside the tank
- Powered by (4) AA batteries (included)
- 16-1/2" High bowl with 12" standard rough-in
- 2-1/8" Fully glazed trapway
- Seat and supply sold separately



K-6418 Combination: K-4309 Elongated Bowl, K-5692 Tank

Part #	Mfg #	Description	Rough-In	Color	Price
169314	K-6418-0	Elongated Complete, No-Touch Flush	12"	White	
176504	K-6418-47	Elongated Complete, No-Touch Flush	12"	Almond	
190213	K-6418-95	Elongated Complete, No-Touch Flush	12"	Ice Grey	
168743	K-6418-96	Elongated Complete, No-Touch Flush	12"	Biscuit	
177069	K-6418-G9	Elongated Complete, No-Touch Flush	12"	Sandbar	
170167	K-6418-NY	Elongated Complete, No-Touch Flush	12"	Dune	

Devonshire® Comfort Height® 2-Piece 1.28 gpf Toilet with AquaPiston® Flushing Technology

- 16-1/2" High bowl is ADA compliant
- 2-1/8" Fully glazed trapway
- Includes left-hand trip lever
- Seat and supply sold separately



K-3837 Combination: K-4397 Elongated Bowl, K-4438 Tank

Part #	Mfg #	Description	Rough-In	Color	Price
141575	K-3837-0	ADA Elongated Complete, LH Trip	12"	White	
176285	K-3837-33	ADA Elongated Complete, LH Trip	12"	Mexican Sand	
141582	K-3837-47	ADA Elongated Complete, LH Trip	12"	Almond	
141369	K-3837-95	ADA Elongated Complete, LH Trip	12"	Ice Grey	
141579	K-3837-96	ADA Elongated Complete, LH Trip	12"	Biscuit	
177204	K-3837-K4	ADA Elongated Complete, LH Trip	12"	Cashmere	
154858	K-3837-NY	ADA Elongated Complete, LH Trip	12"	Dune	

Wellworth® 2-Piece 1.6 gpf Toilet with Class Five® Flush Technology and Left-Hand Trip Lever

- 16-1/2" High bowl
- 12" Standard rough-in and 3-bolt installation
- 2" Glazed trapway
- Seat and supply sold separately



K-3979 Combination: K-4199 ADA Bowl, K-4468 Tank

K-3978 Combination: K-4198 Elongated Bowl, K-4468 Tank

Part #	Mfg #	Description	Rough-In	Color	Price
137522	K-3978-0	Elongated Complete, LH CP Trip	12"	White	
139928	K-3978-47	Elongated Complete, LH CP Trip	12"	Almond	

*Vibrant Limited Lifetime Finish

www.waterconcepts.net • Serving our Customers Since 1946 • www.plumbsupply.com

Elongated Closets

Two-Piece Vitreous China Toilets (Continued)

Wellworth® 2-Piece 1.6 gpf Toilet with Class Five® Flush Technology and Left-Hand Trip Lever

Part #	Mfg #	Description	Rough-In	Color	Price
154865	K-3978-7	Elongated Complete, LH CP Trip	12"	Black	
137523	K-3978-96	Elongated Complete, LH CP Trip	12"	Biscuit	

Highline® Comfort Height® 2-Piece 1.6 gpf Toilet with Class Five® Flush Technology & Left-Hand Trip Lever

- 16-1/2" High bowl
- 2" Glazed trapway
- 12" Standard rough-in and 3-bolt installation
- Seat and supply sold separately
- (-RA) Right-hand trip lever
- (-T) Tank cover locks



K-3979 Combination: K-4199 ADA Bowl, K-4468 Tank

K-3978 Combination: K-4198 Elongated Bowl, K-4468 Tank

Part #	Mfg #	Description	Rough-In	Color	Price
137514	K-3979-0	ADA Elongated Complete, LH CP Trip	12"	White	
138354	K-3979-47	ADA Elongated Complete, LH CP Trip	12"	Almond	
140398	K-3979-7	ADA Elongated Complete, LH CP Trip	12"	Black	
137515	K-3979-96	ADA Elongated Complete, LH CP Trip	12"	Biscuit	
142860	K-3979-RA-0	ADA Elongated Complete, RH CP Trip	12"	White	
144720	K-3979-RA-47	ADA Elongated Complete, RH CP Trip	12"	Almond	
141867	K-3979-RA-96	ADA Elongated Complete, RH CP Trip	12"	Biscuit	
149479	K-3979-T-0	ADA Elongated Complete, LH CP Trip, with Locks	12"	White	

Highline® Comfort Height® 2-Piece 1.28 gpf Toilet with Class Five® flush technology & Left-Hand Trip Lever

- 16-1/2" High bowl is ADA compliant
- 2-1/8" Glazed trapway
- 3-bolt installation
- Seat and supply sold separately
- Meets EPA WaterSense® criteria
- (-RA) Right-hand trip lever
- (-U) Insuliner® tank liner



Part #	Mfg #	Description	Rough-In	Color	Price
137520	K-3889-0	ADA Elongated Complete, LH CP Trip Lever	10"	White	
139804	K-3889-47	ADA Elongated Complete, LH CP Trip Lever	10"	Almond	
142662	K-3889-7	ADA Elongated Complete, LH CP Trip Lever	10"	Black	
137521	K-3889-96	ADA Elongated Complete, LH CP Trip Lever	10"	Biscuit	
170050	K-3889-RA-0	ADA Elongated Complete, RH CP Trip Lever	10"	White	
151833	K-3889-U-96	ADA Elongated Complete with Insuliner® Tank, LH CP Trip	10"	Biscuit	
137516	K-3999-0	ADA Elongated Complete, LH CP Trip Lever	12"	White	
139453	K-3999-47	ADA Elongated Complete, LH CP Trip Lever	12"	Almond	
157547	K-3999-7	ADA Elongated Complete, LH CP Trip Lever	12"	Black	

*Vibrant Limited Lifetime Finish

www.plumbsupply.com • Serving our Customers Since 1946 • www.waterconcepts.net

Elongated Closets

Two-Piece Vitreous China Toilets (Continued)

Highline® Comfort Height® 2-Piece 1.28 gpf Toilet with Class Five® flush technology & Left-Hand Trip Lever

Part #	Mfg #	Description	Rough-In	Color	Price
137517	K-3999-96	ADA Elongated Complete, LH CP Trip Lever	12"	Biscuit	
159525	K-3999-RA-0	ADA Elongated Complete, RH CP Trip Lever	12"	White	
146791	K-3999-RA-96	ADA Elongated Complete, RH CP Trip Lever	12"	Biscuit	
140990	K-3999-U-0	ADA Elongated Complete, LH CP Trip Lever, w/Insuliner®	12"	White	
140991	K-3999-UR-0	ADA Elongated Complete, RH CP Trip Lever, w/Insuliner®	12"	White	
137518	K-3949-0	ADA Elongated Complete	14"	White	
137519	K-3949-96	ADA Elongated Complete	14"	Biscuit	

Highline® Concealed Trapway Comfort Height® 1.28 gpf 2-Piece Toilet with Class Five® flush technology

- 16-1/2" High bowl is ADA compliant
- 2-1/8" Glazed trapway
- Includes polished chrome left-hand trip lever
- Standard 12" Rough-in with 3-bolt installation
- Seat and supply sold separately
- Meets EPA WaterSense® criteria



Combination: K-80020 ADA Bowl, K-5311 Tank

Part #	Mfg #	Description	Rough-In	Color	Price
190442	K-76301-0	ADA Elongated Complete, LH CP Trip Lever, Concealed Trap	12"	White	
228161	K-76301-47	ADA Elongated Complete, LH CP Trip Lever, Concealed Trap	12"	Almond	
190443	K-76301-96	ADA Elongated Complete, LH CP Trip Lever, Concealed Trap	12"	Biscuit	

Highline® Classic Comfort Height® 1.28 gpf 2-Piece Toilet with Class Five® Flush & Left Hand Trip Lever

- 16-1/2" High bowl is ADA compliant
- 2-1/8" Fully glazed trapway
- Seat and supply sold separately
- Meets EPA Watersense® criteria
- (-RA) Right-hand trip lever



K-3658 Combination: K-4199 Elongated Bowl, K-4436 Tank

K-3713 Combination: K-4373 Elongated Bowl, K-4436 Tank

Part #	Mfg #	Description	Rough-In	Color	Price
134973	K-3658-0	ADA Elongated Complete, LH CP Trip	12"	White	
175505	K-3658-96	ADA Elongated Complete, LH CP Trip	12"	Biscuit	
139709	K-3658-RA-0	ADA Elongated Complete, RH CP Trip	12"	White	
138445	K-3713-0	ADA Elongated Complete, LH CP Trip	10"	White	
151970	K-3713-7	ADA Elongated Complete, LH CP Trip	10"	Black	
153309	K-3713-96	ADA Elongated Complete, LH CP Trip	10"	Biscuit	

*Vibrant Limited Lifetime Finish

www.waterconcepts.net • Serving our Customers Since 1946 • www.plumbsupply.com

Elongated Closets

Highline® Classic Comfort Height® 1.6 gpf 2-Piece Elongated Toilet with PressureLite® Flush Technology

- 30-1/8"L x 21-1/4"W x 31-1/4"H
- Seat and supply sold separately
- 12" Rough-in
- Includes left hand trip lever
—(-RA) Right-hand trip lever



K-3493 Combination: K-4304 Elongated Bowl, K-4645 Tank

Part #	Mfg #	Description	Rough-In	Color	Price
086520	K-3493-0	ADA Elongated Complete, LH Trip	12"	White	
088820	K-3493-47	ADA Elongated Complete, LH Trip	12"	Almond	
086523	K-3493-96	ADA Elongated Complete, LH Trip	12"	Biscuit	
090414	K-3493-RA-0	ADA Elongated Complete, RH Trip	12"	White	
180505	K-3493-RA-96	ADA Elongated Complete, RH Trip	12"	Biscuit	
090163	K-3493-T-0	ADA Elongated Complete, LH Trip and Tank Cover Locks	12"	White	
091897	K-3493-TR-0	ADA Elongated Complete, RH Trip and Tank Cover Locks	12"	White	

Highline® Classic Comfort Height® 1.0 gpf 2-Piece Elongated Toilet with PressureLite® Flush Technology

- Pressure assisted flushing system
- 17-1/8" High bowl is ADA compliant
- 2-1/4" Glazed trapway
- Seat and supply sold separately
- WaterSense® certified product
- Includes left hand trip lever
—(-RA) Right-hand trip lever



Part #	Mfg #	Description	Rough-In	Color	Price
103513	K-3519-0	ADA Elongated Complete, LH CP Trip	12"	White	
115015	K-3519-7	ADA Elongated Complete, LH CP Trip	12"	Black	
146024	K-3519-96	ADA Elongated Complete, LH CP Trip	12"	Biscuit	
106013	K-3519-RA-0	ADA Elongated Complete, RH CP Trip	12"	White	
143297	K-3519-T-0	ADA Elongated Complete, LH CP Trip with Tank Cover Locks	12"	White	
133866	K-3519-TR-0	ADA Elongated Complete, RH CP Trip with Tank Cover Locks	12"	White	

Kelston® Comfort Height® 1.6 gpf 2-Piece Elongated Toilet with AquaPiston® Flush & Left-Hand Trip Lever

- 16-1/2" High bowl is ADA compliant
- 2-1/8" Glazed trapway
- DryLock™ system
- Seat and supply sold separately



K-3754 Combination: K-4306 Elongated Bowl, K-4474 LH Tank

Part #	Mfg #	Description	Rough-In	Color	Price
128876	K-3754-0	ADA Elongated Complete, LH CP Trip	12"	White	
128944	K-3754-47	ADA Elongated Complete, LH CP Trip	12"	Almond	
132278	K-3754-7	ADA Elongated Complete, LH CP Trip	12"	Black	

*Vibrant Limited Lifetime Finish

www.plumbsupply.com • Serving our Customers Since 1946 • www.waterconcepts.net

Elongated Closets

Two-Piece Vitreous China Toilets (Continued)

Kelston® Comfort Height® 1.6 gpf 2-Piece Elongated Toilet with AquaPiston® Flush & Left-Hand Trip Lever

Part #	Mfg #	Description	Rough-In	Color	Price
128877	K-3754-96	ADA Elongated Complete, LH CP Trip	12"	Biscuit	
141838	K-3754-G9	ADA Elongated Complete, LH CP Trip	12"	Sandbar	
157917	K-3754-NY	ADA Elongated Complete, LH CP Trip	12"	Dune	

Keltson® Comfort Height® 2-Piece Elongated 1.28 gpf Toilet with AquaPiston® Flush & Left-Hand Trip Lever

- 16-1/2" High bowl is ADA compliant
- 2-1/8" Glazed trapway
- DryLock™ system
- Seat and supply sold separately



K-3755 Combination: K-4306 Elongated Bowl, K-4469 LH Tank

Part #	Mfg #	Description	Rough-In	Color	Price
132322	K-3755-0	ADA Elongated Complete	12"	White	
175621	K-3755-47	ADA Elongated Complete	12"	Almond	
226008	K-3755-95	ADA Elongated Complete	12"	Ice Grey	
172138	K-3755-G9	ADA Elongated Complete	12"	Sandbar	

Memoirs® Comfort Height® 2-Piece Elongated 1.6 gpf Toilet with AquaPiston® Flush Technology

- 16-1/2" High bowl is ADA compliant
- 12" Rough-in
- Includes left-hand polished chrome trip lever
- Seat and supply sold separately



Classic



Stately

K-3818 Combination: K-4380 Elongated Bowl, K-4641 LH Trip Classic Tank

K-3819 Combination: K-4380 Elongated Bowl, K-4642 LH Trip Stately Tank

Part #	Mfg #	Description	Rough-In	Color	Price
142797	K-3818-0	ADA Classic Elongated Complete	12"	White	
154820	K-3818-47	ADA Classic Elongated Complete	12"	Almond	
167047	K-3818-95	ADA Classic Elongated Complete	12"	Ice Grey	
142404	K-3818-96	ADA Classic Elongated Complete	12"	Biscuit	
144488	K-3818-G9	ADA Classic Elongated Complete	12"	Sandbar	
144633	K-3819-0	ADA Stately Elongated Complete	12"	White	
145322	K-3819-47	ADA Stately Elongated Complete	12"	Almond	
162018	K-3819-95	ADA Stately Elongated Complete	12"	Ice Grey	
156881	K-3819-96	ADA Stately Elongated Complete	12"	Biscuit	
153191	K-3819-G9	ADA Stately Elongated Complete	12"	Sandbar	

*Vibrant Limited Lifetime Finish

www.waterconcepts.net • Serving our Customers Since 1946 • www.plumbsupply.com

Elongated Closets

Memoirs® Comfort Height® 2-Piece Elongated 1.28 gpf Toilet with Left-Hand Trip Lever

- AquaPiston® flushing technology
- 16-1/2" High bowl is ADA compliant
- 2-1/8" Glazed trapway
- Seat and supply sold separately
- Meets EPA WaterSense® criteria



Classic



Stately



K-3816 Combination: K-4380 Elongated Bowl, K-4433 Tank

Part #	Mfg #	Description	Rough-In	Color	Price
143308	K-3816-0	ADA Classic Elongated Complete, LH Trip	12"	White	
153531	K-3816-95	ADA Classic Elongated Complete, LH Trip	12"	Ice Grey	
143143	K-3816-96	ADA Classic Elongated Complete, LH Trip	12"	Biscuit	
152496	K-3816-G9	ADA Classic Elongated Complete, LH Trip	12"	Sandbar	
165403	K-3816-NY	ADA Classic Elongated Complete, LH Trip	12"	Dune	
223613	K-3816-U-0	ADA Classic Elongated Complete, LH Trip & Tank Liner	12"	White	
138859	K-3817-0	ADA Stately Elongated Complete, LH Trip	12"	White	
230602	K-3817-7	ADA Stately Elongated Complete, LH Trip	12"	Black	
155040	K-3817-96	ADA Stately Elongated Complete, LH Trip	12"	Biscuit	
143524	K-3817-47	ADA Stately Elongated Complete, LH Trip	12"	Almond	
160614	K-3817-G9	ADA Stately Elongated Complete, LH Trip	12"	Sandbar	
151845	K-3817-NY	ADA Stately Elongated Complete, LH Trip	12"	Dune	

With Concealed Trapway and Clean Caps®

Part #	Mfg #	Description	Rough-In	Color	Price
177489	K-6669-0	ADA Stately Elongated Complete, LH Trp Concealed Trapway	12"	White	
184224	K-6669-47	ADA Stately Elongated Complete, LH Trp Concealed Trapway	12"	Almond	
185578	K-6669-95	ADA Stately Elongated Complete, LH Trp Concealed Trapway	12"	Ice Grey	
180836	K-6669-96	ADA Stately Elongated Complete, LH Trp Concealed Trapway	12"	Biscuit	
188480	K-6669-NY	ADA Stately Elongated Complete, LH Trp Concealed Trapway	12"	Dune	
186848	K-6999-0	ADA Stately Elongated Complete, LH Trp Concealed Trapway	12"	White	

Persuade® Skirted 2-Piece Elongated 1.0 or 1.6 gpf Dual Flush Toilet with Top Actuator

- 15-3/4" High elongated bowl
- 12" Rough-in and 2-bolt installation
- Seat sold separately
- Meets EPA WaterSense® criteria



K-3654 Combination: K-4322 Elongated Bowl, K-4419 Tank

Part #	Mfg #	Description	Rough-In	Color	Price
112449	K-3654-0	Elongated Complete with Supply	12"	White	
131685	K-3654-47	Elongated Complete with Supply	12"	Almond	

*Vibrant Limited Lifetime Finish

www.plumbsupply.com • Serving our Customers Since 1946 • www.waterconcepts.net

Elongated Closets

Persuade® Curv Comfort Height® 2-Piece Dual Flush 1.6/1.0 Toilet

- Includes 2-button actuator that provides easy-to-use flushing options
- Skirted trapway
- Supply line included
- 16-1/2" High bowl is ADA compliant
- Seat sold separately
- Meets EPA WaterSense® criteria



K-3723 Combination: K-4353 Elongated Bowl, K-4441 Tank

Part #	Mfg #	Description	Rough-In	Color	Price
130589	K-3723-0	ADA Elongated Complete	12"	White	
139999	K-3723-47	ADA Elongated Complete	12"	Almond	
131681	K-3723-96	ADA Elongated Complete	12"	Biscuit	
183314	K-3723-NY	ADA Elongated Complete	12"	Dune	

Persuade® Circ Comfort Height® 2-Piece Dual Flush 1.6/1.0 Toilet

- Includes top-mount dual flush trip lever
- Skirted trapway
- Supply line included
- 16-1/2" High bowl is ADA compliant



K-3753 Combination: K-4353 Elongated Bowl, K-4442 DF Tank

Part #	Mfg #	Description	Rough-In	Color	Price
139498	K-3753-0	ADA Elongated Complete	12"	White	
139536	K-3753-47	ADA Elongated Complete	12"	Almond	
164690	K-3753-7	ADA Elongated Complete	12"	Black	
165914	K-3753-95	ADA Elongated Complete	12"	Ice Grey	
139105	K-3753-96	ADA Elongated Complete	12"	Biscuit	

Tresham™ Comfort Height® 2-Piece Elongated 1.28 Toilet with AquaPiston® Flush Technology

- 16-1/2" High bowl is ADA compliant
- 2-1/8" Glazed trapway
- Includes left-hand polished chrome trip lever
- Seat and water supply sold separately
- Meets EPA WaterSense® criteria



K-3950 Combination: K-4799 Elongated Bowl, K-4899 Tank

Part #	Mfg #	Description	Rough-In	Color	Price
143743	K-3950-0	ADA Elongated Toilet Complete	12"	White	
164682	K-3950-33	ADA Elongated Toilet Complete	12"	Mexican Sand	
154996	K-3950-47	ADA Elongated Toilet Complete	12"	Almond	
173772	K-3950-58	ADA Elongated Toilet Complete	12"	Thunder Grey	

*Vibrant Limited Lifetime Finish

www.waterconcepts.net • Serving our Customers Since 1946 • www.plumbsupply.com

Elongated Closets

Two-Piece Vitreous China Toilets (Continued)

Tresham™ Comfort Height® 2-Piece Elongated 1.28 Toilet with AquaPiston® Flush Technology

Part #	Mfg #	Description	Rough-In	Color	Price
181231	K-3950-7	ADA Elongated Toilet Complete	12"	Black	
145963	K-3950-96	ADA Elongated Toilet Complete	12"	Biscuit	
156438	K-3950-G9	ADA Elongated Toilet Complete	12"	Sandbar	
154949	K-3950-K4	ADA Elongated Toilet Complete	12"	Cashmere	
151848	K-3950-NY	ADA Elongated Toilet Complete	12"	Dune	

Wellworth® Classic Elongated 2-Piece 1.6 Pressure Lite™ Toilet

- Pressure assist flushing technology
- Equipped with Sloan FLUSHMATE® - Sloan® Valve Company
- Polished Chrome Trip Lever
- Less seat and supply



Part #	Mfg #	Description	Rough-In	Color	Price
183050	K-3505-RA-0	ADA Elongated Toilet Complete, RH Trip Lever	12"	White	

Wellworth® Classic 2-Piece Elongated 1.28 Toilet with Class Five® Flush Technology & Left-Hand Trip Lever

- 2-1/8" Glazed trapway
- Large 3-1/4" canister flush valve
- Seat and supply sold separately
- Meets EPA WaterSense® criteria



Part #	Mfg #	Description	Rough-In	Color	Price
130223	K-3575-0	Elongated Complete	12"	White	
171499	K-3575-47	Elongated Complete	12"	Almond	

Wellworth® 2-Piece Elongated 1.28 gpf Toilet with Class Five® Flush Technology

- 2-1/8" Glazed trapway
- Large 3-1/4" canister flush valve
- Left-hand chrome-plated trip lever
- Seat and supply sold separately
- Meets EPA WaterSense® criteria



K-3948 Combination: K-4198 Elongated Bowl, K-4841 Tank

K-3998 Combination: K-4198 Elongated Bowl, K-4467 Tank

Part #	Mfg #	Description	Rough-In	Color	Price
137526	K-3948-0	Elongated Complete	14"	White	
171446	K-3948-47	Elongated Complete	14"	Almond	
137524	K-3998-0	Elongated Complete	12"	White	

*Vibrant Limited Lifetime Finish

www.plumbsupply.com • Serving our Customers Since 1946 • www.waterconcepts.net

Elongated Closets

Two-Piece Vitreous China Toilets (Continued)

Wellworth® 2-Piece Elongated 1.28 gpf Toilet with Class Five® Flush Technology

Part #	Mfg #	Description	Rough-In	Color	Price
137525	K-3998-96	Elongated Complete	12"	Biscuit	

Wellworth® 2-Piece Elongated Dual-Flush Toilet with Left-Hand Trip Lever

- Dual-flush offers 1.1 gpf or 1.6 gpf flush options
- 2-1/8" Glazed trapway
- 3-Bolt installation
- Seat and supply sold separately
- Meets EPA WaterSense® criteria



K-3988 Combination: K-4198 Elongated Bowl, K-4458 Tank

Part #	Mfg #	Description	Rough-In	Color	Price
159681	K-3988-0	Elongated Complete, LH Trip	12"	White	
171449	K-3988-47	Elongated Complete, LH Trip	12"	Almond	
188193	K-3988-96	Elongated Complete, LH Trip	12"	Biscuit	

Highline® Comfort Height® 2-Piece Elongated Dual-Flush Toilet with Class Five® Flush Technology

- Dual-flush offers 1.1 gpf or 1.6 gpf flush options
- 2-1/8" Glazed trapway
- 3-Bolt installation
- Includes left-hand trip lever
—(-RA) right-hand trip lever
- Seat and supply sold separately
- Meets EPA WaterSense® criteria



K-3989 Combination: K-4199 Elongated Bowl, K-4458 Tank
K-6393 Combination: K-4373 Elongated Bowl, K-4458-RA Tank

Part #	Mfg #	Description	Rough-In	Color	Price
160279	K-3989-0	ADA Elongated Complete, LH Trip	12"	White	
160281	K-3989-96	ADA Elongated Complete, LH Trip	12"	Biscuit	
185409	K-6393-0	ADA Elongated Complete, LH Trip	10"	White	
181254	K-6393-RA-0	ADA Elongated Complete, RH Trip	10"	White	

Toilets

*Vibrant Limited Lifetime Finish

www.waterconcepts.net • Serving our Customers Since 1946 • www.plumbsupply.com



Elongated Closets

Two-Piece Elongated Vitreous China Toilets

Avalanche™ 2-Piece 1.6gpf Toilet

- Fluidmaster® fill valve
- 2" Glazed trapway
- Side, color matched tank lever
- Seat sold separately



Elongated, Standard Height

Part #	Mfg #	Description	Rough-In	Color	Price
161386	AV-21-810	AV-21-862 Elong Bowl, AV-28-895 Tank	10"	White	
161556	AV-21-810-09	AV-21-862-09 Elong Bowl, AV-28-895-09 Tank	10"	Biscuit	
161387	AV-21-812	AV-21-862 Elong Bowl, AV-28-890 Tank	12"	White	
161557	AV-21-812-09	AV-21-862-09 Elong Bowl, AV-28-890-09 Tank	12"	Biscuit	
161389	AV-21-814	AV-21-862 Elong Bowl, AV-28-894 Tank	14"	White	
161559	AV-21-814-09	AV-21-862-09 Elong Bowl, AV-28-894-09 Tank	14"	Biscuit	

ErgoHeight (ADA)

Part #	Mfg #	Description	Rough-In	Color	Price
161390	AV-21-817	AV-21-828 ADA Bowl, AV-28-895 Tank	10"	White	
161561	AV-21-817-09	AV-21-828-09 ADA Bowl, AV-28-895-09 Tank	10"	Biscuit	
161391	AV-21-818	AV-21-828 ADA Bowl, AV-28-890 Tank	12"	White	
161562	AV-21-818-09	AV-21-828-09 ADA Bowl, AV-28-890-09 Tank	12"	Biscuit	
166257	AV-21-818-25	AV-21-828-25 ADA Bowl, AV-28-890-25 Tank	12"	Bone/Wheat	
161392	AV-21-824	AV-21-828 ADA Bowl, AV-28-894 Tank	14"	White	
161563	AV-21-824-09	AV-21-828-09 ADA Bowl, AV-28-89-094 Tank	14"	Biscuit	

Avalanche™ 2-Piece 1.28gpf Toilet

- Fluidmaster® fill valve
- 2" Glazed trapway
- Side, color matched tank lever
- Seat sold separately



Elongated, Standard Height

Part #	Mfg #	Description	Rough-In	Color	Price
161401	WS-21-810	AV-21-862 Elong Bowl, WS-28-895 Tank	10"	White	
161572	WS-21-810-09	AV-21-862-09 Elong Bowl, WS-28-895-09 Tank	10"	Biscuit	
161402	WS-21-812	AV-21-862 Elong Bowl, WS-28-890 Tank	12"	White	
161573	WS-21-812-09	AV-21-862-09 Elong Bowl, WS-28-890-09 Tank	12"	Biscuit	
161403	WS-21-814	AV-21-862 Elong Bowl, WS-28-894 Tank	14"	White	
161575	WS-21-814-09	AV-21-862-09 Elong Bowl, WS-28-894-09 Tank	14"	Biscuit	

Toilets



Elongated Closets

ErgoHeight (ADA)

Part #	Mfg #	Description	Rough-In	Color	Price
161404	WS-21-817	AV-21-828 ADA Bowl, WS-28-895 Tank	10"	White	
161576	WS-21-817-09	AV-21-828-09 ADA Bowl, WS-28-895-09 Tank	10"	Biscuit	
161405	WS-21-818	AV-21-828 ADA Bowl, WS-28-890 Tank	12"	White	
161577	WS-21-818-09	AV-21-828-09 ADA Bowl, WS-28-890-09 Tank	12"	Biscuit	
161407	WS-21-824	AV-21-828 ADA Bowl, WS-28-894 Tank	14"	White	
161578	WS-21-824-09	AV-21-828-09 ADA Bowl, WS-28-894-09 Tank	14"	Biscuit	

Avalanche™ 2-Piece 1.28gpf Toilet with Concealed Trapway

- Two piece toilet with concealed trapway for superior look
- Elongated bowl
- Single flush 1.28 HET provides for maximum performance at optimal water savings
- Fluidmaster Fill Valve
- 3" flush valve
- Color-matched cover plates included
- Toilet seat not included



Part #	Mfg #	Description	Rough-In	Color	Price
174323	20-832	21-832 ADA Bowl, 28-830 Tank	12"	White	

Blaze™ 2-Piece 1.28gpf Toilet

- 3" Flush valve
- Fluidmaster 400A fill valve
- Color-matched flush lever
- Double nut, multi-point tank-to-bowl mounting system for easy tool-free installation
- XL dual fed siphon jets increases the force of the flush, clearing the bowl effectively
- Large water surface to thoroughly rinse bowl with each flush
- Large, 2" fully glazed trapway for clog-free waste remover
- Toilet seat not included
- WaterSense® certified
- 10 Year warranty



Part #	Mfg #	Description	Rough-In	Color	Price
180963	20-023	21-187-09 ADA Bowl, 28-187-09 Tank	12"	White	
222328	20-023-09	21-187-09 ADA Bowl, 28-187-09 Tank	12"	Biscuit	

Toilets



Elongated Closets

Brianne™ Elongated Ergoheight™ 2-Piece 1.28gpf Toilet

- 3" flush valve with Fluidmaster® pilot valve for quiet fill
- Compact Elongated ErgoHeight™ bowl, ADA Compliant
- Dual-fed siphon jet action bowl (no splashing)
- 2" fully glazed trapway for effective waste removal
- Side tank lever
- 6 point tank to bowl connection for tank stability
- Color matched bolt caps included
- Toilet seat not included



Part #	Mfg #	Description	Rough-In	Color	Price
174706	HE-20-013	HE-21-183 ADA Bowl, HE-28-183 Tank	12"	White	

Logan Square ErgoHeight™ Elongated 1.28 gpf

- 3" Flush valve
- Dual fed siphon jet
- Fluidmaster fill valve
- 2" Glazed trapway
- Toilet seat not included



Part #	Mfg #	Description	Rough-In	Color	Price
153809	HE-20-018	HE-21-538 ADA Bowl, HE-28-530 Tank	12"	White	
156748	HE-20-018-09	HE-21-538 ADA Bowl, HE-28-530 Tank	12"	Biscuit	

Logan Square 2-Piece Dual Flush 1.1/1.6 gpf Toilet

- ErgoHeight® ADA Elongated Bowl
- Fully Glazed Trapway
- Top mounted, two-button actuator
- Syphonic flush action
- Toilet seat not included
- Color matched bolt caps included
- HET High Efficiency Toilet



Part #	Mfg #	Description	Rough-In	Color	Price
168716	DF-20-018	HE-21-538 ADA Bowl, DF-28-530 Dual Flush Tank	12"	White	

Toilets



Elongated Closets

Maxwell™ 2-Piece 1.6gpf Toilet

- 2" Flush valve
- 2" Glazed trapway
- Front, color matched tank lever
- Seat sold separately



Elongated, Standard Height

Part #	Mfg #	Description	Rough-In	Color	Price
161313	MX-21-410	21-962 Elong Bowl, MX-28-995 Tank	10"	White	
161427	MX-21-410-09	21-962-09 Elong Bowl, MX-28-995-09 Tank	10"	Biscuit	
161314	MX-21-412	21-962 Elong Bowl MX-28-990 Tank	12"	White	
161428	MX-21-412-09	21-962-09 Elong Bowl, MX-28-990-09 Tank	12"	Biscuit	
161315	MX-21-414	21-962 Elong Bowl, MX-28-994 Tank	14"	White	
161429	MX-21-414-09	21-962-09 Elong Bowl, MX-28-994-09 Tank	14"	Biscuit	

ErgoHeight (ADA)

Part #	Mfg #	Description	Rough-In	Color	Price
161316	MX-21-417	21-928 ADA Bowl, MX-28-995 Tank	10"	White	
161432	MX-21-417-09	21-928-09 ADA Bowl, MX-28-995-09 Tank	10"	Biscuit	
161317	MX-21-418	21-928 ADA Bowl, MX-28-990 Tank	12"	White	
161433	MX-21-418-09	21-928-09 ADA Bowl, MX-28-990-09 Tank	12"	Biscuit	
161318	MX-21-424	21-928 ADA Bowl, MX-28-994 Tank	14"	White	
161434	MX-21-424-09	21-928-09 ADA Bowl, MX-28-994-09 Tank	14"	Biscuit	

Maxwell™ 2-Piece 1.28gpf Toilet

- 2" Flush valve
- 2" Glazed trapway
- Front, color matched tank lever
- Seat sold separately



Elongated, Standard Height

Part #	Mfg #	Description	Rough-In	Color	Price
138037	21-912	21-962 Elong Bowl, 28-990 Tank	12"	White	

ErgoHeight (ADA)

Part #	Mfg #	Description	Rough-In	Color	Price
138038	21-918	21-928 ADA Bowl, 28-990 Tank	12'	White	

Toilets



Elongated Closets

Maxwell™ 2-Piece Dual Flush 1.1/1.6 gpf Toilet

- Front jet flushing action
- Glazed trapway
- Top button actuator
- Seat sold separately



Elongated, Standard Height

Part #	Mfg #	Description	Rough-In	Color	Price
161329	DF-21-910	21-962 Elong Bowl, DF-28-995 Tank	10"	White	
161330	DF-21-912	21-962 Elong Bowl, DF-28-990 Tank	12"	White	
161444	DF-21-912-09	21-962-09 Elong Bowl, DF-28-990-09 Tank	12"	Biscuit	
161331	DF-21-914	21-962 Elong Bowl, DF-28-994 Tank	14"	White	

ErgoHeight (ADA)

Part #	Mfg #	Description	Rough-In	Color	Price
161332	DF-21-917	21-928 ADA Bowl, DF-28-995 Tank	10"	White	
161333	DF-21-918	21-928 ADA Bowl, DF-28-990 Tank	12"	White	
161448	DF-21-918-09	21-928-09 ADA Bowl, DF-28-990-09 Tank	12"	Biscuit	
161334	DF-21-924	21-928 ADA Bowl, DF-28-994 Tank	14"	White	

Maxwell™ Compact Elongated ErgoHeight™ 2-Piece 1.28gpf Toilet with Back Outlet

- Space saving compact design
- 3" Flush valve
- Dual-fed siphon jet
- 2" Glazed trapway
- Front, color matched tank lever
- Seat sold separately



Part #	Mfg #	Description	Rough-In	Color	Price
149994	20-022	21-975 ADA Bowl, 28-980 Tank	4-1/4" Vertical	White	

Viper™ Gravity Fed 2-Piece 1.6 Toilet

- HP2 Flushing technology
- Fluidmaster® fill valve
- 2" Glazed trapway
- Dual feed siphon-jet
- Color matched tank lever for white, bone and biscuit
- Seat sold separately



Elongated, Standard Height

Part #	Mfg #	Description	Rough-In	Color	Price
161353	VP-21-510	VP-21-562 Elong Bowl, VP-28-595 Tank	10"	White	



Elongated Closets

Two-Piece Elongated Vitreous China Toilets (Continued)

Viper™ Gravity Fed 2-Piece 1.6 Toilet Elongated, Standard Height

Part #	Mfg #	Description	Rough-In	Color	Price
161509	VP-21-510-09	VP-21-562-09 Elong Bowl, VP-58-595-09 Tank	10"	Biscuit	
161354	VP-215-12	VP-21-562 Elong Bowl, VP-28-590 Tank	12"	White	
161512	VP-21-512-09	VP-21-562-09 Elong Bowl, VP-28-590-09 Tank	12"	Biscuit	
161355	VP-21-514	VP-21-562 Elong Bowl, VP-28-594 Tank	14"	White	
161515	VP-21-514-09	VP-21-592-09 Elong Bowl, VP-28-594-09 Tank	14"	Biscuit	

ErgoHeight (ADA)

Part #	Mfg #	Description	Rough-In	Color	Price
161356	VP-21-517	VP-21-528 ADA Bowl, VP-28-595 Tank	10"	White	
161519	VP-21-517-09	VP-21-528-09 ADA Bowl, VP-28-595-09 Tank	10"	Biscuit	
161358	VP-21-518	VP-21-528 ADA Bowl, VP-28-590 Tank	12"	White	
161520	VP-21-518-09	VP-21-528-09 ADA Bowl, VP-28-590-09 Tank	12"	Biscuit	
166621	VP-21-518-25	VP-21-528-25 ADA Bowl, VP-28-590-25 Tank	12"	Bone/Wheat	
161359	VP-21-524	VP-21-528 ADA Bowl, VP-28-594 Tank	14"	White	
161522	VP-21-524-09	VP-21-528-09 ADA Bowl, VP-28-594-09 Tank	14"	Biscuit	

Viper™ Gravity Fed 2-Piece 1.28gpf Toilet

- Fluidmaster® fill valve
- Dual-fed siphon jet
- 3" Flush valve
- 2" Glazed trapway
- Color matched front tank lever
- Seat sold separately



Elongated, Standard Height

Part #	Mfg #	Description	Rough-In	Color	Price
161371	WS-21-510	VP-21-562 Elong Bowl, WS-28-595 Tank	10"	White	
161536	WS-21-510-09	VP-21-562-09 Elong Bowl, WS-28-595-09 Tank	10"	Biscuit	
161372	WS-21-512	VP-21-562 Elong Bowl, WS-28-590 Tank	12"	White	
161538	WS-21-512-09	VP-21-562-09 Elong Bowl, WS-28-590-09 Tank	12"	Biscuit	
161373	WS-21-514	VP-21-562 Elong Bowl, WS-28-594 Tank	14"	White	
161539	WS-21-514-09	VP-21-562-09 Elong Bowl, WS-28-594-09 Tank	14"	Biscuit	

ErgoHeight (ADA)

Part #	Mfg #	Description	Rough-In	Color	Price
161374	WS-21-517	VP-21-528 ADA Bowl, WS-28-595 Tank	10"	White	
161540	WS-51-517-09	VP-21-528-09 ADA Bowl, WS-28-595-09 Tank	10"	Biscuit	
161375	WS-21-518	VP-21-528 ADA Bowl, WS-58-590 Tank	12"	White	
161542	WS-21-518-09	VP-21-528-09 ADA Bowl, WS-28-590-09 Tank	12"	Biscuit	
161376	WS-21-524	VP-21-528 ADA Bowl, WS-58-594 Tank	14"	White	
161543	WS-21-524-09	VP-21-528-09 ADA Bowl, WS-58-594-09 Tank	14"	Biscuit	

Toilets



Elongated Closets

Viper™ 2-Piece Compact ErgoHeight 1.6 Toilet

- Compact design fits in round front space
- 3" flush valve
- 2" glazed trapway
- Color matched tank lever
- 2 bolt caps



Part #	Mfg #	Description	Rough-In	Color	Price
175564	VP-21-519	HE-21-872 ADA Bowl, VP-28-595 Tank	12"	White	
177281	VP-21-519-25	HE-21-872-25 ADA Bowl, VP-28-595-25 Tank	12"	Bone	

Viper™ 2-Piece Compact ErgoHeight 1.28 Toilet

- Space saving compact elongated design
- Fluidmaster® fill valve
- Dual-fed siphon jet
- 3" Flush valve
- 2" Glazed trapway
- Color matched front tank lever
- Seat sold separately



Part #	Mfg #	Description	Rough-In	Color	Price
152425	HE-21-519	HE-21-872 Compact Elong Bowl, HE-28-570 Tank	12"	White	
156040	HE-21-519-09	HE-21-872-09 Compact Elong Bowl, HE-28-570-09 Tank	12"	Biscuit	
172163	HE-21-519-25	HE-21-872-25 Compact Elong Bowl, HE-28-570-25 Tank	12"	Bone/Wheat	
159343	HE-21-519-21	HE-21-872-21 Compact Elong Bowl, HE-28-570-21 Tank	12"	Bahama Pink	
156814	HE-21-519-29	HE-21-872-29 Compact Elong Bowl, HE-28-570-29 Tank	12"	Dawn Blue	

Ultra Flush™ Pressure Assist 2-Piece 1.6 Toilet

- Sloan flushmate pressure vessel
- Over 3" average trapway
- Insulated non-sweating tank
- Seat sold separately



Elongated, Standard Height

Part #	Mfg #	Description	Rough-In	Color	Price
039813	21-311	21-372 Elong Bowl, 28-385 Tank	10"	White	
072712	21-311-09	21-372-09 Elong Bowl, 28-385-09 Tank	10"	Biscuit	
039816	21-312	21-372 Elong Bowl, 28-380 Tank	12"	White	
039818	21-312-09	21-372-09 Elong Bowl, 28-380-09 Tank	12"	Biscuit	
039820	21-314	21-372 Elong Bowl, 28-384 Tank	14"	White	

Toilets



Elongated Closets

ErgoHeight (ADA)

Part #	Mfg #	Description	Rough-In	Color	Price
039822	21-317	21-377 ADA Bowl, 28-385 Tank	10"	White	
051978	21-317-09	21-377-09 ADA Bowl, 28-385-09 Tank	10"	Biscuit	
039825	21-318	21-377 ADA Bowl, 28-380 Tank	12"	White	
039827	21-318-09	21-377-09 ADA Bowl, 28-380-09 Tank	12"	Biscuit	
039828	21-324	21-377 ADA Bowl, 28-384 Tank	14"	White	
039830	21-324-09	21-377-09 ADA Bowl, 28-384-09 Tank	14"	Biscuit	

Ultra Flush™ Dual-Flush Pressure Assist 2-Piece 1.1/1.6 Toilet

- Dual flush pressure vessel
- Over 3" average trapway
- Insulated non-sweating tank
- Non-corrosive solid brass tank-to-bowl bolts
- Seat sold separately



Elongated, Standard Height

Part #	Mfg #	Description	Rough-In	Color	Price
091844	DF-21-312	21-372 Elong Bowl, DF-28-380 Tank	12"	White	
091845	DF-21-312-09	21-372-09 Elong Bowl, DF-28-380-09 Tank	12"	Biscuit	
091846	DF-21-314	21-372 Elong Bowl, DF-28-384 Tank	14"	White	
091847	DF-21-314-09	21-372-09 Elong Bowl, DF-28-384-09 Tank	14"	Biscuit	

ErgoHeight (ADA)

Part #	Mfg #	Description	Rough-In	Color	Price
091849	DF-21-318	21-377 ADA Bowl, DF-28-380 Tank	12"	White	
091851	DF-21-318-09	21-377-09 ADA Bowl, DF-28-380-09 Tank	12"	Biscuit	
091852	DF-21-324	21-377 ADA Bowl, DF-28-380 Tank	14"	White	
091853	DF-21-324-09	21-377-09 ADA Bowl, DF-28-380-09 Tank	14"	Biscuit	

Ultra Flush™ ErgoHeight™ Dual Flush Pressure Assist High Efficiency 2-Piece 1.1/1.6 Toilet with Back Outlet

- Dual flush pressure vessel
- Over 3" average trapway
- Insulated, non-sweating tank
- Seat sold separately



Elongated, Standard Height

Part #	Mfg #	Description	Rough-In	Color	Price
091854	DF-21-310	21-374 Back Outlet Bowl, DF-28-380 Tank	4-1/4" Vertical	White	
091856	DF-21-310-09	21-374-09 Back Outlet Bowl, DF-28-380-09 Tank	4-1/4" Vertical	Biscuit	

Toilets



Elongated Closets

ErgoHeight (ADA)

Part #	Mfg #	Description	Rough-In	Color	Price
091857	DF-21-325	21-375 Back Outlet Bowl, DF-28-380 Tank	4-1/4" Vertical	White	

Wicker Park™ 2-Piece 1.28 Toilet

- XP-3 Technology
- 3" Flush valve
- Fluidmaster® Fill valve
- Glazed trapway
- Dual feed jet
- Soft close toilet seat included
- Side tank lever



Part #	Mfg #	Description	Rough-In	Color	Price
151934	20-020	21-186 Bowl, 28-186 Tank	12"	White	

Elongated Closets

Two-Piece Elongated ADA Toilets

Karsten® Dual Force® Luxury Height® 2-Piece Toilet

- Dual Force® flushing system with choice of full flush 1.6 gallons or half flush 0.8 gallons
- One flush performance
- (2) Bolt installation
- Meets EPA WaterSense® criteria
- 5-Year limited warranty



402087 Complete: 402086 Elongated Bowl, 402023 Tank

Part #	Mfg #	Description	Rough-In	Color	Price
136928	402087-0	Elongated Complete	12"	White	
138449	402087-96	Elongated Complete	12"	Biscuit	

Rockton™ Dual Force® Luxury Height® 2-Piece Toilet

- Dual-Force® technology uses 1.6 gpf (6 lpf) flush for solid waste
- and .8 gpf (3 lpf) for liquid waste
- 2" Fully glazed trapway
- Two-button actuator
- 5-Year limited warranty



402088 Complete: 402086 Elongated Bowl, 402022 Tank

Part #	Mfg #	Description	Rough-In	Color	Price
137769	402088-0	ADA Elongated Complete	12"	White	
139566	402088-96	ADA Elongated Complete	12"	Biscuit	

Stinson® Pro Force® Luxury Height® 1.28 2-Piece Toilet

- Pro Force® flushing technology
- 2" Fully glazed trapway
- WaterSense® certified: 1.28 gpf
- 5-Year limited warranty



402077 Complete: 403370 ADA Elongated Bowl, 402091 Tank

Part #	Mfg #	Description	Rough-In	Color	Price
140017	402077-0	Elongated Complete	12"	White	
142137	402077-96	Elongated Complete	12"	Biscuit	

Toilets

Elongated Closets

Windham™ Luxury Height® 2-Piece 1.28 Toilet

- 16-1/2" Bowl heights meets ADA requirements
- 2" Glazed trapway
- One flush performance limited guarantee
- (3) Bolt, quick-connect installation system
- WaterSense® certified: 1.28 gpf
- 5-Year limited warranty



403082 Complete: 403315 ADA Elongated Bowl, 404551 Tank

Part #	Mfg #	Description	Rough-In	Color	Price
170955	403082-0	ADA Elongated Complete	12"	White	
170957	403082-96	ADA Elongated Complete	12"	Biscuit	

Windham™ Luxury Height® 2-Piece 1.6 Toilet

- 16-1/2" Bowl heights meets ADA requirements
- 2" Glazed trapway
- One flush performance limited guarantee
- (3) Bolt, quick-connect installation system
- Flow rate: 1.6 gpf
- 5-Year limited warranty



402315 Complete: 403315 ADA Elongated Bowl, 404515 Tank

Part #	Mfg #	Description	Rough-In	Color	Price
074008	402315-0	ADA Elongated Complete	12"	White	
074013	402315-96	ADA Elongated Complete	12"	Biscuit	

Two-Piece Standard Height Elongated Front Toilets

Windham™ 2-Piece 1.6 Toilet

- Completely code approved
- One flush performance limited guarantee
- (2) Bolt installation
- Seat sold separately
- Flow rate: 1.6 gpf
- 5-Year warranty



402210 Complete: 404210 Elongated Bowl, 404515 Tank

Part #	Mfg #	Description	Rough-In	Color	Price
074006	402210-0	Elongated Complete	10"	White	
074011	402210-96	Elongated Complete	10"	Biscuit	

Toilets

Elongated Closets

Two-Piece Standard Height Alto™ 2-Piece 1.6gpf Toilet

- Elongated front
- 1.6 Gpf / 6.0 Lpf
- 2 " Glazed trapway
- Anti-siphon ballcock provides efficient toilet tank operation at high or low water pressures
- Three-point cushioned tank-to-bowl connection assures perfect tank alignment and leak proof connections.



Part #	Mfg #	Description	Rough-In	Color	Price
194501	135125WH	Elongated Complete, Trip Lever	14"	White	
194503	135125BI	Elongated Complete, Trip Lever	14"	Biscuit	
194502	135125BN	Elongated Complete, Trip Lever	14"	Bone	
192308	135160WH	Elongated Complete, Trip Lever	12"	White	
192315	135160BI	Elongated Complete, Trip Lever	12"	Biscuit	
192307	135160BN	Elongated Complete, Trip Lever	12"	Bone	
194471	135180WH	Elongated Complete, Trip Lever	12"	White	
194473	135180BI	Elongated Complete, Trip Lever	12"	Biscuit	
194472	135180BN	Elongated Complete, Trip Lever	12"	Bone	

Quantum™ 2-Piece 1.6gpf Toilet

- 1.6 Gpf / 6.0 Lpf
- Elongated front
- Pressure-assist, Sloan Flushmate™ flushing system
- Water usage: 1.6 gpf / 6.0 lpf
- Trap diameter: 2-1/8" glazed



Part #	Mfg #	Description	Rough-In	Color	Price
214519	147123WH	Elongated Complete	12"	White	

Summit 2-Piece Dual Flush 1.1/1.6gpf Toilet

- Elongated front
- 2" Glazed trap
- Dual flush technology with 3" tower
- 1.1 Gpf / 1.6 Gpf (4.0 Lpf / 6.0 Lpf)
- Pilot operated anti-siphon fill valve
- SmartFasten 3-bolt tank-to-bowl connection
- PuraClean easy-to-clean glaze



Part #	Mfg #	Description	Rough-In	Color	Price
204262	3823386WH	Elongated Complete, CP Dual Flush Actuator	12"	White	
204263	3823386BI	Elongated Complete, CP Dual Flush Actuator	12"	White	

*Vibrant Limited Lifetime Finish

www.waterconcepts.net • Serving our Customers Since 1946 • www.plumbsupply.com

Elongated Closets

Summit EL 2-Piece 1.6gpf Toilet

- Elongated bowl
- 1.6 Gpf / 6.0 Lpf
- PuraClean easy-to-clean glaze
- Pilot operated anti-siphon fill valve
- 3? Flush valve
- SmartFasten 3-bolt tank-to-bowl connection
- Decorative metal trip lever



Part #	Mfg #	Description	Rough-In	Color	Price
198186	382386WH	Elongated Complete, Trip Lever	12"	White	
198185	382386BI	Elongated Complete, Trip Lever	12"	Biscuit	
198431	382386BN	Elongated Complete, Trip Lever	12"	Bone	

Two-Piece Comfort Height Toilets

Alto™ Smart Height® 2-Piece 1.6gpf Toilet

- 1.6 Gpf / 6.0 Lpf
- 2" Glazed trap
- Elongated front, SmartHeight bowl
- Chair height for maximum comfort
- Anti-siphon ballcock provides efficient toilet tank operation at high or low water pressures



Part #	Mfg #	Description	Rough-In	Color	Price
193490	137160RHHW	ADA Complete, RH Trip Lever	12"	White	
195143	139NS160WH	ADA Complete, No Seat	10"	White	
195144	139NS160BI	ADA Complete, No Seat	10"	White	
194504	137125WH	ADA Complete, Trip Lever	14"	White	
194506	137125BI	ADA Complete, Trip Lever	14"	Biscuit	
194505	137125BN	ADA Complete, Trip Lever	14"	Bone	
192310	137160WH	ADA Complete, Trip Lever	12"	White	
193636	137160BI	ADA Complete, Trip Lever	12"	Biscuit	
192311	137160BN	ADA Complete, Trip Lever	12"	Bone	
194536	137180WH	ADA Complete, Trip Lever	12"	White	

Barrett 2-Piece SmartHeight™ 1.6gpf Toilet

- Traditional style
- Elongated front, SmartHeight™ chair height for maximum comfort
- 1.6 Gpf / 6.0 Lpf
- Concealed trapway for easier cleaning
- High performance MagnaFlush™ flushing system with 3" flush valve virtually eliminates clogging



Part #	Mfg #	Description	Rough-In	Color	Price
197812	115106WH	ADA Complete, Trip Lever	14"	White	
197813	115106BI	ADA Complete, Trip Lever	14"	Biscuit	

*Vibrant Limited Lifetime Finish

www.plumbsupply.com • Serving our Customers Since 1946 • www.waterconcepts.net

Elongated Closets

Cascade™ SmartHeight 2-Piece 1.28gpf Toilet

- Unique rimless bowl design
- Elongated ADA front
- Gravity fed
- Strong swirling action
- 1.28 Gpf / 4.86 Lpf
- HET uses 20% less water than conventional toilets
- 3" Flush Valve
- Pilot operated fill valve
- Glazed trapway
- Chrome trip lever



Part #	Mfg #	Description	Rough-In	Color	Price
205819	48173816WH	ADA Complete, Trip Lever	12"	White	

Maverick SmartHeight™ 2-Piece 1.0gpf Toilet

- Elongated SmartHeight bowl
- Unique HET 3" flush valve virtually eliminates clogs
- Powerful direct-feed jet creates quick siphon action
- High efficiency 1.0 gpf / 3.8 lpf low water consumption
- Uses 38% less water than conventional toilets
- Pilot operated anti-siphon fill valve
- Chrome-plated, metal push button actuator



Part #	Mfg #	Description	Rough-In	Color	Price
213166	10143012WH	Elongated Complete, ADA	12"	White	

Quantum™ Smart Height® 2-Piece 1.6gpf Toilet

- Powerful "one flush" performance.
- Elongated front, SmartHeight™
- Chair height for maximum comfort
- Pressure-assist, Sloan Flushmate™ flushing system
- Colors: white and standard colors: biscuit and bone
- Water usage: 1.6 gpf / 6.0 lpf
- Trap diameter: 2-1/8" glazed
- Trap seal: 3"



Part #	Mfg #	Description	Rough-In	Color	Price
192304	148123-WH	Elongated Complete, ADA	12"	White	

*Vibrant Limited Lifetime Finish

www.waterconcepts.net • Serving our Customers Since 1946 • www.plumbsupply.com

Elongated Closets

Summit SmartHeight™ 2-Piece 1.1 1.6gpf Dual Flush Toilet

- Elongated front SmartHeight bowl
- Dual flush technology with 3" tower
- 1.1 Gpf / 1.6 Gpf (4.0 Lpf / 6.0 Lpf)
- Pilot operated anti-siphon fill valve
- SmartFasten 3-bolt tank-to-bowl connection
- PuraClean easy-to-clean glaze
- Chrome push button actuator



Part #	Mfg #	Description	Rough-In	Color	Price
204264	3843386WH	Elongated Complete, ADA, Trip Lever	12"	White	
204265	3843386BI	Elongated Complete, ADA, Trip Lever	12"	Biscuit	

Summit ADA Smartheight™ 2-Piece Toilet

- Elongated front SmartHeight bowl
- ADA compliant
- 1.6 Gpf / 6.0 Lpf
- PuraClean easy-to-clean glaze
- Pilot operated anti-siphon fill valve
- 3" Flush valve
- SmartFasten 3-bolt tank-to-bowl connection
- Decorative metal trip lever



Part #	Mfg #	Description	Rough-In	Color	Price
198184	384386WH	Elongated Complete, ADA	12"	White	
198183	384386BI	Elongated Complete, ADA	12"	Biscuit	
198430	384386BN	Elongated Complete, ADA	12"	Bone	
219824	385386WH	Elongated Complete, ADA	10"	White	
219825	385386BI	Elongated Complete, ADA	10"	Biscuit	

*Vibrant Limited Lifetime Finish

www.plumbsupply.com • Serving our Customers Since 1946 • www.waterconcepts.net



Gaskets

Toilet Bowl Fittings

Bolt & Gasket

- Durable solid brass bolts and universal gasket
- Sponge rubber gasket fits most close-coupled toilets with both round and hex-shaped flush valve nuts
- Includes bolts with washers and wing nuts



6106

Part #	Mfg #	Description	Price
073270	6102	(2) Closet Bolts & Gasket	
062252	6106	(3) Closet Bolts & Gasket	

Gaskets

Tank-to-Bowl Gaskets

Universal Fit-All Tank-to-Bowl Gasket

- Close coupled
- Beveled sponge rubber material



Part #	Mfg #	Size	Price
093647	C03-300	2-1/4" ID x 3-3/8" OD x 11/16"	

American Standard Cadet/Kohler/Crane/Borg Warner Tank-to-Bowl Gasket*

- Close coupled
- Beveled sponge rubber material

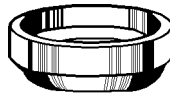

Part #	Mfg #	Size	Price
069315	C03-303	2-1/8" ID x 3-1/2" OD x 1-1/4"	

* Manufacturer's name used only to describe whose products the gaskets will fit

Crane* Tank-to-Bowl Gasket

- Close coupled
- Beveled sponge rubber material

Part #	Mfg #	Size	Price
093649	C03-304	2-1/8" ID x 3-1/4" OD x 1-1/16"	

* Manufacturer's name used only to describe whose products the gaskets will fit

Closet Spud Washer



Part #	Mfg #	Description	Price
151522	C27-301	1-1/4"	



Gaskets

Gerber Toilet Gaskets

Gasket



99-591

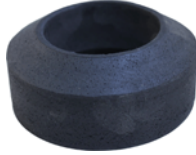

99-582

Part #	Mfg #	Description	Price
084274	99-591	Tank Bowl Gasket	
004852	99-582	Tank-to-Bowl Gasket, Black (28-190/196/290/590/790/794/795)	

*Physical Vapor Deposition (PVD) Limited Lifetime Finish

www.waterconcepts.net • Serving our Customers Since 1946 • www.plumbsupply.com



Gaskets

Toilet Gaskets

Double Thick Sponge Rubber Gasket

- Fits American Standard, Briggs®, Kilgore, Norris and Universal Rundle bowls
- 3-1/2" OD x 2-1/8" ID x 1-1/8" With hex recess
- Fits most close-coupled toilets



Part #	Mfg #	Description	Price
005557	070030	Bulk Packed	

Toilets

Gaskets

Toilet Repair

Tank-To-Bowl Kit for American Standard

- Kit includes:
 - (2) Tank bolts with washers and nuts
 - (1) Sponge rubber spud gasket
- Bolt size: 5/16" x 2-1/2"



Part #	Mfg #	Description	Price
097904	88191	Complete Kit for Plebe	

Tank-To-Bowl Kit for Mansfield

- Kit includes:
 - (3) Tank bolts with washers and nuts
 - (1) Sponge rubber spud gasket
- Bolt size: 5/16" x 2-1/2"

Part #	Mfg #	Description	Price
097905	88913	Complete Kit	

Tank-To-Bolt Kit for Crane

- Kit includes:
 - (2) Tank bolts with washers and nuts
 - (1) Sponge rubber spud gasket
- Bolt size: 5/16" x 3"

Part #	Mfg #	Description	Price
097906	81257	Complete Kit for Neuday	

Toilet Tank Repair

Toilet Repair Parts



Part #	Mfg #	Description	Price
101414	40008	Flush Unit Ball and Chain	

Gaskets

Spud Washers

Flanged Spud Washer

- Black synthetic rubber washer for closet spuds
- Box of 25 washers



Part #	Mfg #	Size	Trade Size	Price
006211	465	1-1/4" x 2" x 1/2"	1"	
006212	466	1-21/32" x 2-1/2" x 5/8"	1-1/4"	
006213	467	1-7/8" x 2-11/16" x 5/8"	1-1/2"	

Closet Bowl Cushion Rings



Part #	Mfg #	Description	Price
006207	456	Regular, Sponge Rubber 3-1/2" x 5-3/8" x 3/4"	

Gaskets

Close Coupled Tank Gasket

- Solid rubber



Part #	Mfg #	Description	Price
006208	459	Box of 25 Close Coupled Gaskets, 2-3/16" x 3-1/4" x 9/16"	

Tank to Bowl Gasket

- Sponge rubber



Part #	Mfg #	Description	Price
006209	460	Gerber Type, 1-3/16" Thick	
019048	462	2-1/8" x 3-31/64" x 1-1/4" Recessed Box of 10 Fits American Standard®	

Toilets



Gaskets

Toilet Parts Spud Washer

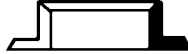

Part #	Mfg #	Description	Pkg Qty	Price
008894	W-302	1-1/2" Flanged	12	

Toilets



Gaskets

Carrier Systems Closet Carrier Parts



Part #	Mfg #	Description	Price
094174	Z-1210-57	4" Bonded "Neo-Seal" Closet Gasket Kit	

Macerating Toilet Systems

Macerating Toilet Systems

Macerating Toilets Work as a System and May be Purchased Separately

- *Systems require:*
 - 003 Round front back discharge bowl or 007 Elongated back discharge ADA bowl
 - 005 Toilet tank

Saniplus® Macerating Toilet System

- *Used to install a complete Residential bathroom up to 15' below the sewer line or even up to 150' away from a soil stack without breaking the concrete*
- *Discharge rate @ 15': 17 gpm*
- *Discharge pipe diameter: 3/4"*
- *Electrical: 115V, 60Hz, 4.5A*
- *Motor: 0.5 hp*
- *Includes:*
 - 10-5/8"H x 20"W x 7"D Macerating pump
 - Toilet tank
 - Toilet bowl



Part #	Mfg #	Description	Color	Price
139770	0235	Round Front System	White	
139772	0275	Elongated System	White	

Saniplus® Components



Part #	Mfg #	Description	Price
139771	002	Macerating Pump Only	

Sanibest® Pro Macerating Toilet System

- *Ideal for guest bathrooms, rental units or office buildings where you do not control usage*
- *Vertical pumping up to 25' and 150' horizontally*
- *Discharge rate @ 15': 19 gpm*
- *Discharge pipe diameter: 3/4"*
- *Electrical: 115V, 60Hz, 9.0A*
- *Motor: 0.5 hp*
- *Includes:*
 - 10-1/2"H x 20-5/16"W x 8"D Macerating pump
 - Toilet tank
 - Bowl



Part #	Mfg #	Description	Color	Price
139768	1335	Round Front	White	
139769	1375	Elongated	White	

Sanibest® Components



Part #	Mfg #	Description	Price
134502	013	Grinder Pump Only	

Sanicondens® Condensate Pump

- *Possible connections:*
 - Tankless water heater
 - Boiler
 - Air conditioning unit
- *Vertical and horizontal discharges*
 - 15 ft vertical
 - 150 ft horizontal



Part #	Mfg #	Description	Color	Price
224975	40	Pump Case Only		
224977	41	Sanicondens 'Best' Pump Case Only		
224978	42	Sanineutral w/ Starter Neutralizing agent		

System Components

Part #	Mfg #	Description	Price
134503	003	Round Front Toilet Bowl, White	
139759	007	ADA Elongated Front Toilet Bowl, White	
134505	005	Toilet Tank Only, White	

PVC Pipe

Part #	Mfg #	Description	Price
134506	030	4" x 16" PVC Extension Pipe with Flexible Rubber Seal & Bell Housing	

Accessories

Descaler

- *Specifically created for use with Saniflo products*
- *Laboratory formulated with phosphoric acid*
- *Concentrated solution for optimum cleaning and disinfecting*
- *Regular usage prolongs unit life and maintains efficiency*
- *Harmless to septic tank operation*

Part #	Mfg #	Description	Price
145660	052	1.5 gal Descaler Solution	

Toilets

One-Piece Closets

One-Piece Vitreous China Toilets

Adair® Comfort Height® 1-Piece 1.28 gpf Toilet with AquaPiston® Flush Technology & Left-Hand Trip Lever

- 2-1/8" Glazed trapway
- 16-1/2" High bowl is ADA compliant
- Supply sold separately
- (-RA) right-hand trip lever



Part #	Mfg #	Description	Rough-In	Color	Price
156087	K-3946-0	ADA Elongated Complete, LH CP Trip	12"	White	
224177	K-3946-33	ADA Elongated Complete, LH CP Trip	12"	Mexican Sand	
164679	K-3946-58	ADA Elongated Complete, LH CP Trip	12"	Thunder Grey	
181754	K-3946-7	ADA Elongated Complete, LH CP Trip	12"	Black	
169401	K-3946-95	ADA Elongated Complete, LH CP Trip	12"	Ice Grey	
164047	K-3946-96	ADA Elongated Complete, LH CP Trip	12"	Biscuit	
181753	K-3946-G9	ADA Elongated Complete, LH CP Trip	12"	Sandbar	
228816	K-3946-K4	ADA Elongated Complete, LH CP Trip	12"	Cashmere	
173588	K-3946-RA-0	ADA Elongated Complete, RH CP Trip	12"	White	

Adair® 1-Piece Elongated 1.28 gpf Toilet with AquaPiston® Flush Technology & Left-Hand Trip Lever

- 2-1/8" Glazed trapway
- 14-1/2" High bowl
- Supply sold separately



Part #	Mfg #	Description	Rough-In	Color	Price
174370	K-6925-0	Elongated Complete, LH CP Trip	12"	White	
183624	K-6925-47	Elongated Complete, LH CP Trip	12"	Almond	
183623	K-6925-NY	Elongated Complete, LH CP Trip	12"	Dune	

Archer® Elongated 1-Piece 1.28 gpf Toilet with AquaPiston® Flush Technology & Left-Hand Trip Lever

- 2-1/8" Glazed trapway
- 14-11/16" High bowl
- Includes seat and cover
- Supply sold separately



Part #	Mfg #	Description	Rough-In	Color	Price
128583	K-3639-0	Elongated Complete, LH CP Trip	12"	White	
133134	K-3639-47	Elongated Complete, LH CP Trip	12"	Almond	

*Vibrant Limited Lifetime Finish

www.plumbsupply.com • Serving our Customers Since 1946 • www.waterconcepts.net

One-Piece Closets

One-Piece Vitreous China Toilets (Continued)

Archer® Elongated 1-Piece 1.28 gpf Toilet with AquaPiston® Flush Technology & Left-Hand Trip Lever

Part #	Mfg #	Description	Rough-In	Color	Price
167300	K-3639-58	Elongated Complete, LH CP Trip	12"	Thunder Grey	
138435	K-3639-96	Elongated Complete, LH CP Trip	12"	Biscuit	

Cimarron® Comfort Height® 1-Piece 1.28 Toilet with AquaPiston® Flush Technology & Left-Hand Trip Lever

- 2-1/8" Glazed trapway
- 16-1/2" High bowl is ADA compliant
- Includes Reveal® Quiet-Close™ with Grip-Tight seat.
- Supply sold separately



With Concealed Trapway and Clean Caps®

Part #	Mfg #	Description	Rough-In	Color	Price
187224	K-3619-0	ADA Elongated Compete, LH CP Trip w/ Concealed Trapway	12"	White	
223712	K-3619-47	ADA Elongated Compete, LH CP Trip w/ Concealed Trapway	12"	Almond	
226789	K-3619-96	ADA Elongated Compete, LH CP Trip w/ Concealed Trapway	12"	Biscuit	

Without Concealed Trapway

Part #	Mfg #	Description	Rough-In	Color	Price
144849	K-3828-0	ADA Elongated Complete, LH CP Trip	12"	White	
149371	K-3828-33	ADA Elongated Complete, LH CP Trip	12"	Mexican Sand	
150479	K-3828-47	ADA Elongated Complete, LH CP Trip	12"	Almond	
154068	K-3828-58	ADA Elongated Complete, LH CP Trip	12"	Thunder Grey	
159679	K-3828-7	ADA Elongated Complete, LH CP Trip	12"	Black	
150000	K-3828-95	ADA Elongated Complete, LH CP Trip	12"	Ice Grey	
149842	K-3828-96	ADA Elongated Complete, LH CP Trip	12"	Biscuit	
153135	K-3828-G9	ADA Elongated Complete, LH CP Trip	12"	Sandbar	
151874	K-3828-K4	ADA Elongated Complete, LH CP Trip	12"	Cashmere	
175365	K-3828-NY	ADA Elongated Complete, LH CP Trip	12"	Dune	

Gabrielle™ Comfort Height® 1-Piece 1.28 Toilet with Class Five® Flush Technology & Left-Hand Trip Lever

- 16-1/4" High bowl is ADA compliant
- Includes Reveal® Quiet-Close™ with Grip-Tight seat
- Meets EPA WaterSense® criteria
- Supply line not included



Part #	Mfg #	Description	Rough-In	Color	Price
143733	K-3615-0	ADA Elongated Complete, LH Trip, Q3 Advantage Seat	12"	White	
146071	K-3615-47	ADA Elongated Complete, LH Trip, Q3 Advantage Seat	12"	Almond	
157662	K-3615-95	ADA Elongated Complete, LH Trip, Q3 Advantage Seat	12"	Ice Grey	

*Vibrant Limited Lifetime Finish

www.waterconcepts.net • Serving our Customers Since 1946 • www.plumbsupply.com

One-Piece Closets

One-Piece Vitreous China Toilets (Continued)

Gabrielle™ Comfort Height® 1-Piece 1.28 Toilet with Class Five® Flush Technology & Left-Hand Trip Lever

Part #	Mfg #	Description	Rough-In	Color	Price
148371	K-3615-96	ADA Elongated Complete, LH Trip, Q3 Advantage Seat	12"	Biscuit	
146066	K-3615-G9	ADA Elongated Complete, LH Trip, Q3 Advantage Seat	12"	Sandbar	
184228	K-3615-K4	ADA Elongated Complete, LH Trip, Q3 Advantage Seat	12"	Cashmere	
183563	K-3615-NY	ADA Elongated Complete, LH Trip, Q3 Advantage Seat	12"	Dune	

Karing™ Intelligent Skirted 1-Piece 1.28 Toilet

- Compact toilet with integrated bidet with self-cleaning wand, precision air dryer and deodorizer
- Sleek tankless design with skirted trapway
- Intuitive touch screen remote
- Motion-activated flush utilizing Poer Lite technology
- LED light illuminated bowl



Part #	Mfg #	Description	Rough-In	Color	Price
177490	K-4026-0	ADA Compact Elongated, Bidet Seat with Remote	12"	White	

Kathryn® Comfort Height® Compact 1-Piece 1.28 Toilet with AquaPiston® Flush Technology

- 16-3/8" High bowl is ADA compliant
- Includes left-hand trip lever
- Glenbury™ Quiet-Close™ seat with Quick-Release™
- Concealed trapway and Clean Caps®
- Supply line not included



Part #	Mfg #	Description	Rough-In	Color	Price
161812	K-3940-0	ADA Elongated Complete, LH Trip, Glenbury Seat	12"	White	
226151	K-3940-47	ADA Elongated Complete, LH Trip, Glenbury Seat	12"	Almond	
173488	K-3940-96	ADA Elongated Complete, LH Trip, Glenbury Seat	12"	Biscuit	
226392	K-3940-K4	ADA Elongated Complete, LH Trip, Glenbury Seat	12"	Cashmere	

*Vibrant Limited Lifetime Finish

www.plumbsupply.com • Serving our Customers Since 1946 • www.waterconcepts.net

One-Piece Closets

Memoirs® Classic Comfort Height® 1-Piece 1.28 Toilet with AquaPiston® Flush Technology

- 16-1/4" High bowl is ADA compliant
- Glenbury™ Quiet-Close™ with Grip-Tight seat
- 2-1/8" Fully glazed trapway
- Includes left-hand trip lever
- WaterSense® certified product: 1.28 gpf



K-3812

K-6424

Part #	Mfg #	Description	Rough-In	Color	Price
141727	K-3812-0	ADA Elongated Complete, LH Trip, Glenbury Seat	12"	White	
183054	K-3812-47	ADA Elongated Complete, LH Trip, Glenbury Seat	12"	Almond	
139345	K-3812-96	ADA Elongated Complete, LH Trip, Glenbury Seat	12"	Biscuit	
183053	K-3812-G9	ADA Elongated Complete, LH Trip, Glenbury Seat	12"	Sandbar	
227063	K-3812-K4	ADA Elongated Complete, LH Trip, Glenbury Seat	12"	Cashmere	
227991	K-6424-0	Skirted ADA Elongated Complete, LH Trip, Glenbury Seat	12"	White	

Memoirs® Stately Comfort Height® 1-Piece 1.28 Toilet with AquaPiston® Flush Technology

- 16-1/4" High bowl is ADA compliant
- Includes left-hand trip lever
—(-RA) right-hand trip lever
- 2-18" Glazed trapway
- Glenbury™ Quiet-Close™ with Grip-Tight seat
- Supply line not included



Part #	Mfg #	Description	Rough-In	Color	Price
145886	K-3813-0	ADA Elongated Complete, LH Trip, Glenbury Seat	12"	White	
146194	K-3813-47	ADA Elongated Complete, LH Trip, Glenbury Seat	12"	Almond	
150693	K-3813-58	ADA Elongated Complete, LH Trip, Glenbury Seat	12"	Thunder Grey	
159200	K-3813-96	ADA Elongated Complete, LH Trip, Glenbury Seat	12"	Biscuit	
183055	K-3813-K4	ADA Elongated Complete, LH Trip, Glenbury Seat	12"	Cashmere	
164395	K-3813-RA-0	ADA Elongated Complete, RH Trip, Glenbury Seat	12"	White	

Toilets

*Vibrant Limited Lifetime Finish

www.waterconcepts.net • Serving our Customers Since 1946 • www.plumbsupply.com

One-Piece Closets

Memoirs® Stately Comfort Height® 1-Piece 1.28 Toilet with Concealed Trap

- Compact elongated
- AquaPiston® flushing system
- 16-1/2" High bowl
- Includes seat and cover
- 2-1/8" Plastic trapway
- 9-5/8" Water area



Part #	Mfg #	Description	Rough-In	Color	Price
189749	K-6428-0	Compact Elongated, LH Trip, Glenbury Seat	12"	White	
223389	K-6428-7	Compact Elongated, LH Trip, Glenbury Seat	12"	Black	

Numi® Comfort Hight® 1-Piece 1.28 Toilet with Bidet Technology

- Dual flush
- 2-7/8" trapway with skirt
- 10" x 8-1/4" water area
- Requires a 120 V, 15 A minimum, 60 Hz receptacle projected by a GFCI or RCD
- Requires a supply stop with 1/2" OD compression outlet threads
- Heated seat and foot warmer
- Advanced bidet functionality with self-cleaning wand, precision air dryer, and deodorizing filter all in one
- Built-in speakers play pre-programmed custom Numi® song, FM radio, or your personalized music from a portable device via Bluetooth or axillary cable, or simply load a play list or welcome message to the SD card
- Ambient lighting with eight colors and three programming options
- Touch-screen remote with magnetic wall-docking station
- Emergency flush supports up to 100 flushes during power outage
- Includes complete toilet and seat, supply line, power cord, axillary music cord, and external FM antenna
- Requires K-7420 or K-7421 remote



Part #	Mfg #	Description	Rough-In	Color	Price
168853	K-3901-0	Elongated Complete, Bidet Functionality	12"	White	

Numi® Touch-Screen Premium Remote 4-1/16" x 6" x 2"

- User presets for up to six people recall individual preferences
- Remote language is adjustable to 12 different languages
- Includes magnetic wall-mount docking and charging station
- Includes lithium polymer rechargeable battery
- Required for the (K-3901) Numi toilet



Part #	Mfg #	Description	Rough-In	Color	Price
168854	K-7420-0	Required for K-3901 Numi, 4-1/16" x 6" x 2"	-	White	

*Vibrant Limited Lifetime Finish

www.plumbsupply.com • Serving our Customers Since 1946 • www.waterconcepts.net

One-Piece Closets

Portrait® Comfort Height® 1-Piece Compact 1.28 gpf Toilet with Concealed Trapway & Lift Knob Actuator

- 16-1/2" High bowl
- AquaPiston® flush technology
- Clean Caps®
- Glenbury™ Quiet-Close™ seat with Quick-Release™
- 2 1/8" glazed trapway
- Includes polished chrome lift knob
- WaterSense® certified product
- Supply line not included



Part #	Mfg #	Description	Rough-In	Color	Price
174458	K-3826-0	Compact Elongated, Lift Knob Actuator	12"	White	
181929	K-3826-96	Compact Elongated, Lift Knob Actuator	12"	Biscuit	
175102	K-3826-K4	Compact Elongated, Lift Knob Actuator	12"	Cashmere	

Saile® Skirted 1-Piece Dual-Flush Toilet with Top Actuator and Saile Quiet-Close® Seat with Quick-Release™

- High efficiency 1.6gpf or 0.8 gpf
- 2-1/8" Fully glazed trapway
- Supply line not included



Part #	Mfg #	Description	Rough-In	Color	Price
121016	K-3564-0	Compact Elongated, Skirted Trapway	12"	White	
183051	K-3564-47	Compact Elongated, Skirted Trapway	12"	Almond	
132139	K-3564-96	Compact Elongated, Skirted Trapway	12"	Biscuit	

San Raphael® 1-Piece Comfort Height® 1.0 gpf Toilet with Pressure Lite® Flush Technology

- 16-1/2" High bowl
- Seat and lid included
- Left-hand trip lever
- Supply line sold separately
- Sloan Flushmate® pressure vessel
- WaterSense® certified product: 1.0 gpf



Part #	Mfg #	Description	Rough-In	Color	Price
118243	K-3597-0	Elongated Complete, LH CP Trip	12"	White	
120087	K-3597-47	Elongated Complete, LH CP Trip	12"	Almond	
126040	K-3597-7	Elongated Complete, LH CP Trip	12"	Black	
165526	K-3597-95	Elongated Complete, LH CP Trip	12"	Ice Grey	
114809	K-3597-96	Elongated Complete, LH CP Trip	12"	Biscuit	
228300	K-3597-G9	Elongated Complete, LH CP Trip	12"	Sandbar	

*Vibrant Limited Lifetime Finish

www.waterconcepts.net • Serving our Customers Since 1946 • www.plumbsupply.com

One-Piece Closets

San Raphael® 1-Piece Comfort Height® 1.28 Toilet

- Elongated bowl
- Skirted trapway
- Includes seat, cover and left-hand polished chrome trip lever
- Single-flush gravity uses the force of gravity and a precision-engineered tank, bowl, and trapway to create a siphon during flushing
- Quiet-Close™ seat and lid included
- WaterSense® certified



Part #	Mfg #	Description	Rough-In	Color	Price
172613	K-3722-0	Elongated Complete, LH CP Trip	12"	White	

Santa Rosa™ Comfort Height® Compact 1-Piece 1.6 Toilet with AquaPiston® Flush Technology

- 16-1/2" High bowl is ADA compliant
- Seat and cover included
- Supply sold separately
- 2-1/8" glazed trapway
- Left-hand trip lever
- Includes Brevia™ with Quick-Release™ seat



Part #	Mfg #	Description	Rough-In	Color	Price
142214	K-3811-0	Elongated Complete, LH CP Trip	12"	White	
149680	K-3811-47	Elongated Complete, LH CP Trip	12"	Almond	
152734	K-3811-7	Elongated Complete, LH CP Trip	12"	Black	
150148	K-3811-95	Elongated Complete, LH CP Trip	12"	Ice Grey	
144409	K-3811-96	Elongated Complete, LH CP Trip	12"	Biscuit	
157648	K-3811-G9	Elongated Complete, LH CP Trip	12"	Sandbar	
166798	K-3811-K4	Elongated Complete, LH CP Trip	12"	Cashmere	
174335	K-3811-NY	Elongated Complete, LH CP Trip	12"	Dune	

Santa Rosa™ Comfort Height® 1-Piece Compact 1.28 Toilet with AquaPiston® Flush Technology

- 16-1/2" High bowl is ADA compliant
- 2-1/8" Glazed trapway
- Includes seat and cover
- Supply sold separately
- Standard left-hand trip lever
- Meets EPA WaterSense® criteria



Part #	Mfg #	Description	Rough-In	Color	Price
139879	K-3810-0	ADA Elongated Compact Complete, LH CP Trip	12"	White	
183052	K-3810-47	ADA Elongated Compact Complete, LH CP Trip	12"	Almond	
154293	K-3810-7	ADA Elongated Compact Complete, LH CP Trip	12"	Black	
142342	K-3810-95	ADA Elongated Compact Complete, LH CP Trip	12"	Ice Grey	
142327	K-3810-96	ADA Elongated Compact Complete, LH CP Trip	12"	Biscuit	
150223	K-3810-G9	ADA Elongated Compact Complete, LH CP Trip	12"	Sandbar	
176495	K-3810-NY	ADA Elongated Compact Complete, LH CP Trip	12"	Dune	

*Vibrant Limited Lifetime Finish

www.plumbsupply.com • Serving our Customers Since 1946 • www.waterconcepts.net

One-Piece Closets

San Souci® Comfort Height® 1-Piece Compact Elongated 1.28 gpf Touchless Toilet

- Low-profile design
- DryLock™ System
- 12" Rough-in
- AquaPiston® flushing system
- Powered by 4 AA batteries (included)
- Concealed trapway and Clean Caps®
- 2-1/8" Fully glazed trapway
- Includes K-4008 Reveal® Quiet-Close™ with Grip-Tight seat
- Supply line not included



Part #	Mfg #	Description	Rough-In	Color	Price
170468	K-4000-0	Elongated Front Complete, LH CP Trip	12"	White	
225958	K-4000-95	Elongated Front Complete, LH CP Trip	12"	Ice Grey	
185473	K-4000-96	Elongated Front Complete, LH CP Trip	12"	Biscuit	
183565	K-4000-NY	Elongated Front Complete, LH CP Trip	12"	Dune	

San Souci® 1-Piece Round-Front 1.28 gpf Toilet with AquaPiston® Flush Technology

- Low-profile design
- Includes standard left-hand trip lever
- Supply line not included
- **(K-4008)** Reveal® Quiet-Close™ with Grip-Tight seat included



Part #	Mfg #	Description	Rough-In	Color	Price
177855	K-4007-0	Round Front Complete, LH CP Trip	12"	White	
176792	K-4007-95	Round Front Complete, LH CP Trip	12"	Ice Grey	
224875	K-4007-G9	Round Front Complete, LH CP Trip	12"	Sandbar	

San Souci® Comfort Height® 1-Piece Compact Elongated 1.28 gpf Toilet w/ Concealed Trapway Clean Caps®

- Low-profile design
- 12" Rough-in
- Includes standard left-hand polished chrome trip lever
- AquaPiston® flushing system
- 2-1/8" Fully glazed trapway
- Includes K-4008 Reveal® Quiet-Close™ with Grip-Tight seat
- Supply line not included



Part #	Mfg #	Description	Rough-In	Color	Price
174349	K-5172-0	Compact Elongated Front, LH CP Trip	12"	White	
224695	K-5172-33	Compact Elongated Front, LH CP Trip	12"	Mexican Sand	
221796	K-5172-47	Compact Elongated Front, LH Trip	12"	Almond	
188443	K-5172-7	Compact Elongated Front, LH CP Trip	12"	Black Black	
226435	K-5172-95	Compact Elongated Front, LH CP Trip	12"	Ice Grey	
185421	K-5172-96	Compact Elongated Front, LH CP Trip	12"	Biscuit	
188542	K-5172-K4	Compact Elongated Front, LH CP Trip	12"	Cashmere	

*Vibrant Limited Lifetime Finish

www.waterconcepts.net • Serving our Customers Since 1946 • www.plumbsupply.com

One-Piece Closets

One-Piece Vitreous China Toilets (Continued)

San Souci® Comfort Height® 1-Piece Compact Elongated 1.28 gpf Toilet w/ Concealed Trapway Clean Caps®

Part #	Mfg #	Description	Rough-In	Color	Price
229086	K-5172-NY	Compact Elongated Front, LH Trip	12"	Dune	

San Souci™ Comfort Height® 1-Piece 1.28 Toilet

- AquaPiston® flushing technology
- Touchless with Purefresh™
- Concealed trapway and Clean Caps™
- 16-1/2" High bowl is ADA compliant
- 2-1/8" Fully glazed concealed trapway
- Includes K-5588 Purefresh™ toilet seat



Part #	Mfg #	Description	Rough-In	Color	Price
186897	K-8687-0	Compact Elongated Bowl, Touchless	12"	White	

Tresham™ Comfort Height Skirted 1-Piece 1.28 Toilet

- Compact elongated bowl
- AquaPiston® flushing system
- 16-1/2" High bowl is ADA compliant
- Includes Glenbury™ Q3 seat
- Skirted trapway
- 2-1/8" plastic trapway



Part #	Mfg #	Description	Rough-In	Color	Price
180164	K-3981-0	ADA Compact Elongated Complete, LH CP Trip	12"	White	
222408	K-3981-7	ADA Compact Elongated Complete, LH CP Trip	12"	Black	
221313	K-3981-NY	ADA Compact Elongated Complete, LH CP Trip	12"	Dune	

*Vibrant Limited Lifetime Finish

www.plumbsupply.com • Serving our Customers Since 1946 • www.waterconcepts.net

One-Piece Closets

Veil® Intelligent Skirted One-Piece Elongated Dual-Flush Toilet

- Compact, streamlined one-piece toilet with integrated cleansing
- Elongated bowl offers added room and comfort
- Tankless design with direct water supply
- Dual flush offers a choice of 0.8 or 1.28 gallon per flush (gpf).
- Stainless steel wand offers adjustable spray shape, position, water pressure, temperature, pulsate, and oscillate functions
- Front and rear wash modes provide warm water for cleansing
- Self-cleaning function uses UV light and electrolyzed water systems to sanitize the wand surfaces
- Warm-air drying system with adjustable temperature settings
- Automatic deodorization system
- Heated seat with adjustable temperature settings
- Motion-activated, hands-free opening/closing of seat and cover
- Quiet-Close™ lid closes slowly and quietly without slamming
- LED lighting illuminates the bowl to serve as a night-light
- English-language touchscreen LCD remote control
- Emergency flush feature for power outages



Part #	Mfg #	Description	Rough-In	Color	Price
222148	K-5401-0	ADA Skirted w/ Bidet Functionality Seat	12"	White	

Veil™ 1Pc Elongated Dual-Flush Wall-Hung Toilet

- Includes Reveal Q3 seat, wall-hung bowl, flush actuator, and in wall carrier
- Mounting hardware is completely concealed
- Dual-Flush actuator offers a choice of 0.8 or 1.6 gpf
- Durable steel frame for 2" x 6" installation
- Meets EPA WaterSense® criteria



Part #	Mfg #	Description	Rough-In	Color	Price
160479	K-6303-0	ADA Elongated Toilet Complete	-	White	
183606	K-6303-7	ADA Elongated Toilet Complete	-	Black	
173436	K-6303-96	ADA Elongated Toilet Complete	-	Biscuit	
181122	K-6304-0	ADA Elongated Toilet Complete, C3® Bidet Toilet Seat	-	White	

Toilets

*Vibrant Limited Lifetime Finish

www.waterconcepts.net • Serving our Customers Since 1946 • www.plumbsupply.com



One-Piece Closets

One-Piece Elongated Vitreous China Toilets

Avalanche™ One-Piece ErgoHeight™ 1.28 Toilet

- Elongated, ErgoHeight™ bowl
- Compact design fits in round front space
- Dual-fed siphon jet
- Fluidmaster™ fill valve
- 3" Flush valve with XP3 flushing technology
- 2" Glazed trapway
- Color matched side tank lever
- Toilet seat included



Part #	Mfg #	Description	Rough-In	Color	Price
135189	21-014	One-Piece, Seat Included	12"	White	

Avalanche™ One-Piece ErgoHeight™ 1.28 Toilet with Concealed Trapway

- Fluidmaster® Fill valve WDI 3" flush valve
- Front mount tank lever
- Soft-closing seat cover included
- Matching color ceramic floor bolt cover plates included



Part #	Mfg #	Description	Rough-In	Color	Price
168544	21-019	One-Piece w/ Concealed Trap, Seat Included	12"	White	

Round Front Closets

Two-Piece Round Vitreous China Toilets

Cimarron® Comfort Height® 2-Piece Round-Front 1.6 gpf Toilet with AquaPiston® Flush Technology

- 2-1/8" Glazed trapway
- 16-1/2" High bowl is ADA compliant
- DryLock™ System
- Seat and supply sold separately
- Left-hand polished chrome trip lever included
—(-RA) right-hand trip lever
- Meets EPA WaterSense® criteria



K-3888 Combination: K-4347 Round Bowl, K-4167 Tank

Part #	Mfg #	Description	Rough-In	Color	Price
147235	K-3888-0	Round Complete, Trapway less Supply, LH CP Trip	12"	White	
147651	K-3888-47	Round Complete, Trapway less Supply, LH CP Trip	12"	Almond	
157181	K-3888-7	Round Complete, Trapway less Supply, LH CP Trip	12"	Black	
145421	K-3888-95	Round Complete, Trapway less Supply, LH CP Trip	12"	Ice Grey	
146265	K-3888-96	Round Complete, Trapway less Supply, LH CP Trip	12"	Biscuit	
146333	K-3888-G9	Round Complete, Trapway less Supply, LH CP Trip	12"	Sandbar	
167305	K-3888-NY	Round Complete, Trapway less Supply, LH CP Trip	12"	Dune	
145596	K-3888-RA-0	Round Complete, Trapway less Supply, RH CP Trip	12"	White	
169277	K-3888-RA-47	Round Complete, Trapway less Supply, RH CP Trip	12"	Almond	

Cimarron® Comfort Height® 2-Piece Round-Front 1.28 gpf Toilet with AquaPiston® Flush Technology

- DryLock™ System
- 2-1/8" Glazed trapway
- Includes left-hand chrome trip lever
- 16-1/2" High bowl is ADA compliant
- Seat and supply sold separately
- Meets EPA WaterSense® criteria
- (-RA) right-hand trip lever
- (-U) Insuliner® tank liner



K-3887 Combination K-4347 Round Bowl, K-4166 Tank
K-3851 Combination K-4829 Round Bowl, K-4166 Tank

Part #	Mfg #	Description	Rough-In	Color	Price
154825	K-3851-0	Round Complete, LH CP Trip	10"	White	
171868	K-3851-47	Round Complete, LH CP Trip	10"	Almond	
176456	K-3851-96	Round Complete, LH CP Trip	10"	Biscuit	
142363	K-3887-0	Round Complete, LH CP Trip	12"	White	
145136	K-3887-47	Round Complete, LH CP Trip	12"	Almond	
176658	K-3887-7	Round Complete, LH CP Trip	12"	Black	
146660	K-3887-95	Round Complete, LH CP Trip	12"	Ice Grey	
142364	K-3887-96	Round Complete, LH CP Trip	12"	Biscuit	
145755	K-3887-G9	Round Complete, LH CP Trip	12"	Sandbar	
151717	K-3887-U-0	Round Complete with Insuliner® Tank, LH CP Trip	12"	White	
167103	K-3887-U-96	Round Complete with Insuliner® Tank, LH CP Trip	12"	Biscuit	

***Vibrant Limited Lifetime Finish**

www.waterconcepts.net • Serving our Customers Since 1946 • www.plumbsupply.com

Round Front Closets

Cimarron® Touchless Comfort Height® 2-Piece 1.28 Toilet

- Flush is activated by a no-touch sensor mounted inside the tank
- Powered by 4 (AA) batteries
- AquaPiston® flushing system
- 2-1/8" Glazed trapway
- 12" Rough-in
- 16-1/2" High bowl is ADA compliant
- Seat and supply sold separately
- WaterSense® certified product



Part #	Mfg #	Description	Rough-In	Color	Price
171393	K-6419-0	Round Complete, Touchless Flush	12"	White	
190204	K-6419-95	Round Complete, Touchless Flush	12"	Ice Grey	
174046	K-6419-96	Round Complete, Touchless Flush	12"	Biscuit	

Highline® Comfort Height® 2-Piece Round-Front 1.28 gpf Toilet with Class Five® Flush Technology

- 2-1/8" Fully glazed trapway
- Floor mount / Floor outlet
- Three-bolt installation
- Left-hand polished chrome trip lever included
- Seat and supply line not included
- WaterSense® certified product



Part #	Mfg #	Description	Rough-In	Color	Price
230301	5481-0	Round Complete, LH Trip	12"	White	

Memoirs® Comfort Height® 2-Piece Round-Front 1.28 gpf Toilet with AquaPiston® Flush Technology

- 2-1/8" Glazed trapway
- Includes chrome left-hand trip lever
- Seat and supply sold separately
- Meets EPA WaterSense® criteria
- (-RA) right-hand trip lever
- (-U) Insuliner® tank liner



Stately Design



Classic Design

Stately Design

Part #	Mfg #	Description	Rough-In	Color	Price
148309	K-3933-0	Round Complete, LH Trip	12"	White	
152441	K-3933-47	Round Complete, LH Trip	12"	Almond	
163125	K-3933-96	Round Complete, LH Trip	12"	Biscuit	
172235	K-3933-G9	Round Complete, LH Trip	12"	Sandbar	

Classic Design

Part #	Mfg #	Description	Rough-In	Color	Price
149039	K-3986-0	Round Complete, LH Trip	12"	White	
149299	K-3986-47	Round Complete, LH Trip	12"	Almond	

*Vibrant Limited Lifetime Finish

www.plumbsupply.com • Serving our Customers Since 1946 • www.waterconcepts.net

Round Front Closets

Two-Piece Round Vitreous China Toilets (Continued)

**Memoirs® Comfort Height® 2-Piece Round-Front 1.28 gpf Toilet with AquaPiston® Flush Technology
Classic Design**

Part #	Mfg #	Description	Rough-In	Color	Price
148918	K-3986-96	Round Complete, LH Trip	12"	Biscuit	
158602	K-3986-G9	Round Complete, LH Trip	12"	Sandbar	
226265	K-3986-RA-0	Round Complete, RH Trip	12"	White	
150837	K-3986-U-0	Round Complete, LH Trip w/ Insuliner® Tank	12"	White	

Wellworth® 2-Piece Round-Front 1.28 gpf Toilet with Class Five® Flush Technology & Left-Hand Trip Lever

- 2-1/8" Glazed trapway
- Large 3-1/4" canister flush valve
- Seat and supply sold separately
- Meets EPA WaterSense® criteria
- (-RA) right-hand trip lever



K-3947 Combination: K-4197 Round Bowl, K-4841 Tank

K-3997 Combination: K-4197 Round Bowl, K-4467 Tank

Part #	Mfg #	Description	Rough-In	Color	Price
137532	K-3947-0	Round Complete	14"	White	
137530	K-3997-0	Round Complete	12"	White	
137531	K-3997-96	Round Complete	12"	Biscuit	
160751	K-3997-RA-0	Round Complete, RH Trip	12"	White	

Wellworth® 2-Piece Round-Front 1.6 gpf Toilet with Class Five® Flush Technology & Left-Hand Trip Lever

- 14-1/2" Bowl height
- 2-1/8" Glazed trapway
- Seat and supply sold separately



K-3977 Combination: K-4197 Round Bowl, K-4468 Tank

Part #	Mfg #	Description	Rough-In	Color	Price
137528	K-3977-0	Round Complete, LH CP Trip	12"	White	
139930	K-3977-47	Round Complete, LH CP Trip	12"	Almond	
145939	K-3977-7	Round Complete, LH CP Trip	12"	Black	
137529	K-3977-96	Round Complete, LH CP Trip	12"	Biscuit	

Toilets

*Vibrant Limited Lifetime Finish

www.waterconcepts.net • Serving our Customers Since 1946 • www.plumbsupply.com

Round Front Closets

Wellworth® 2-Piece Dual-Flush Toilet with Class Five® Flushing Technology & Left-hand Trip Lever

- 14-1/2" Bowl height
- 2-1/8" Glazed trapway
- 12" Rough-in and 3-bolt installation
- Seat and supply sold separately
- 1.1 or 1.6 gpf



K-3987 Combination: K-4197 Round Bowl, K-4458 Tank

Part #	Mfg #	Description	Rough-In	Color	Price
166486	K-3987-0	Round Complete, LH CP Trip	12"	White	
171448	K-3987-47	Round Complete, LH CP Trip	12"	Almond	
168119	K-3987-7	Round Complete, LH CP Trip	12"	Black	

Wellworth® Classic 2-Piece 1.28 gpf Toilet Class Five® Flush Technology & Left-hand Trip Lever

- 2-1/8" Glazed trapway
- Left-hand polished chrome trip lever
- Seat and supply sold separately
- Meets EPA WaterSense® criteria



Part #	Mfg #	Description	Rough-In	Color	Price
130225	K-3577-0	Round Complete, LH CP Trip	12"	White	
167940	K-3577-47	Round Complete, LH CP Trip	12"	Almond	
165746	K-3577-7	Round Complete, LH CP Trip	12"	Black	
134925	K-3577-96	Round Complete, LH CP Trip	12"	Biscuit	

*Vibrant Limited Lifetime Finish

www.plumbsupply.com • Serving our Customers Since 1946 • www.waterconcepts.net

Round Front Closets

Two-Piece Round Vitreous China Toilets

Karsten® Dual-Force® 2-Piece 1.6/.8 gpf Toilet

- One flush cleansing performance
- (2) Bolt installation
- 2-1/2" Glazed trapway
- Dual Force® flushing system
- WaterSense® certified: 1.6 gpf/.08 gpf
- 5-Year warranty



402025 Complete: 402021 Round Bowl, 402023 Tank

Part #	Mfg #	Description	Rough-In	Color	Price
099377	402025-0	Round Complete	12"	White	
120969	402025-96	Round Complete	12"	Biscuit	

Rockton™ Dual Force® 2-Piece 1.6/.8 gpf Toilet

- One flush cleansing performance
- (2) Bolt installation
- 2-1/2" (64 mm) glazed trapway
- Dual Force® flushing system
- WaterSense® certified: 1.6gpf/.08gpf
- 5-Year warranty



402024 Complete: 402021 Round Bowl, 402022 Tank

Part #	Mfg #	Description	Rough-In	Color	Price
081316	402024-0	Round Complete	12"	White	
081320	402024-96	Round Complete	12"	Biscuit	

Windham™ Pro Force® 2-Piece 1.6gpf Toilet

- Completely code approved
- One flush performance limited guarantee
- (2) Bolt installation
- Seat sold separately
- 5-Year warranty



402015 Complete: 403015 Round Bowl, 404515 Tank

Part #	Mfg #	Description	Rough-In	Color	Price
137389	402015-0	Round Complete	12"	White	
074009	402015-96	Round Complete	12"	Biscuit	

Toilets

Round Front Closets

Two-Piece Vitreous China Toilets

Stealth® Ultra High-Efficiency 2-Piece 0.80 Toilet

- *Seat sold separately*
- *Quiet siphonic flushing*
- *Patented flush chamber and air transfer system*
- *28-7/8" x 18-3/4" x 31"*
- *8" x 6" Water surface area*
- *Polished chrome top-mount flush actuator*
- *10-Year limited warranty*



N7716R Complete: N7716B Round Bowl, N7714T Tank

Part #	Mfg #	Description	Rough-in	Color	Price
131375	N7716R	Round Complete	12"	White	

Toilets



Round Front Closets

Two-Piece Round Vitreous China Toilets

Allerton 2-Piece 1.28gpf Toilet

- Fluidmaster® fill valve
- Dual fed siphon jet
- 3" Flush valve
- 2" Glazed trapway
- Side tank lever
- Seat sold separately



Part #	Mfg #	Description	Rough-In	Color	Price
159209	HE-20-001	HE-21-542 Round Bowl, HE-28-580 Tank	12"	White	

Avalanche™ 2-Piece 1.28gpf Toilet

- Fluidmaster® fill valve
- Dual-fed siphon jet
- 3" Flush valve
- Glazed trapway
- Color matched, side tank lever
- Seat sold separately



Part #	Mfg #	Description	Rough-In	Color	Price
161398	WS-21-800	WS-21-852 Round Bowl, WS-21-895 Tank	10"	White	
161567	WS-21-800-09	WS-21-852-09 Round Bowl, WS-21-895-09 Tank	10"	Biscuit	
161399	WS-21-802	WS-21-852 Round Bowl, WS-21-890 Tank	12"	White	
161570	WS-21-802-09	WS-21-852-09 Round Bowl, WS-21-890-09 Tank	12"	Biscuit	
161400	WS-21-804	WS-21-852 Round Bowl, WS-28-894 Tank	14"	White	
161571	WS-21-804-09	WS-21-852-09 Round Bowl, WS-28-894-09 Tank	14"	Biscuit	

Avalanche™ 2-Piece 1.6gpf Toilet

- Fluidmaster® fill valve
- Dual-fed siphon jet
- 2" Fully-glazed trapway
- Color matched, side tank lever
- Seat sold separately



Part #	Mfg #	Description	Rough-In	Color	Price
161383	AV-21-800	AV-21-852 Round Bowl, AV-28-895 Tank	10"	White	
161550	AV-21-800-09	AV-21-852-09 Round Bowl, AV-28-895-09 Tank	10"	Biscuit	
161384	AV-21-802	AV-21-852 Round Bowl, AV-28-890 Tank	12"	White	
161552	AV-21-802-09	AV-21-852-09 Round Bowl, AV-28-890-09 Tank	12"	Biscuit	
165710	AV-21-802-25	AV-21-852-25 Round Bowl, AV-28-890-25 Tank	12"	Bone/Wheat	
161385	AV-21-804	AV-21-852 Round Bowl, AV-28-894 Tank	14"	White	
161554	AV-21-804-09	AV-21-852-09 Round Bowl, AV-28-894-09 Tank	14"	Biscuit	

Toilets



Round Front Closets

Maxwell™ 2-Piece 1.28gpf Toilet

- Pilot fill valve
- Dual-fed siphon jet
- 3" Flush valve
- 2" Glazed trapway
- Color matched front tank lever
- Seat sold separately



Part #	Mfg #	Description	Rough-In	Color	Price
138036	21-902	21-952 Round Bowl, 28-990 Tank	12"	White	

Maxwell™ 2-Piece 1.6gpf Toilet

- Siphon jet action
- 2" Glazed trapway
- 2" Flush valve
- Color matched front tank lever
- Seat sold separately



Part #	Mfg #	Description	Rough-In	Color	Price
161310	MX-21-400	21-952 Round Bowl, MX-28-995 Tank	10"	White	
161413	MX-21-400-09	21-952-09 Round Bowl, MX-28-995-09 Tank	10"	Biscuit	
161311	MX-21-402	21-952 Round Bowl, MX-28-990 Tank	12"	White	
161421	MX-21-402-09	21-952-09 Round Bowl, MX-28-990-09 Tank	12"	Biscuit	
170307	MX-21-402-25	21-952-25 Round Bowl, MX-28-990-25 Tank	12"	Bone/Wheat	
161312	MX-21-404	21-952 Round Bowl, MX-28-994 Tank	14"	White	
161423	MX-21-404-09	21-952-09 Round Bowl, MX-28-994-09 Tank	14"	Biscuit	

Maxwell™ 2-Piece Dual Flush 1.1/1.6gpf Toilet

- Front jet flushing action
- Glazed trapway
- Top button actuator
- Seat sold separately



Part #	Mfg #	Description	Rough-In	Color	Price
161326	DF-21-900	21-952 Round Bowl, DF-28-995 Tank	10"	White	
161327	DF-21-902	21-952 Round Bowl, DF-28-990 Tank	12"	White	
161438	DF-21-902-09	21-952-09 Round Bowl, DF-28-990-09 Tank	12"	Biscuit	
161328	DF-21-904	21-952 Round Bowl, DF-28-994 Tank	14"	White	

Toilets



Round Front Closets

Viper™ 2-Piece 1.28gpf Toilet

- Fluidmaster® fill valve
- Dual-fed siphon jet
- 3" Flush valve
- 2" Glazed trapway
- Color matched, side tank lever
- Seat sold separately



Part #	Mfg #	Description	Rough-In	Color	Price
161368	WS-21-500	VP-21-552 Round Bowl, WS-28-595 Tank	10"	White	
161527	WS-21-500-09	VP-21-552-09 Round Bowl, WS-28-595-09 Tank	10"	Biscuit	
161369	WS-21-502	VP-21-552 Round Bowl, WS-28-590 Tank	12"	White	
161533	WS-21-502-09	VP-21-552-09 Round Bowl, WS-28-590-09 Tank	12"	Biscuit	
161370	WS-21-504	VP-21-552 Round Bowl, WS-28-594 Tank	14"	White	
161535	WS-21-504-09	VP-21-552-09 Round Bowl, WS-28-594-09 Tank	14"	Biscuit	

Viper™ 2-Piece 1.6gpf Toilet

- HP2 Flushing technology
- Fluidmaster® fill valve
- Glazed 2" trapway
- Dual feed siphon-jet
- Color matched tank lever for white, bone and biscuit
- Seat sold separately

21-502



Part #	Mfg #	Description	Rough-In	Color	Price
161350	VP-21-500	VP-21-552 Round Bowl, VP-28-595 Tank	10"	White	
161497	VP-21-500-09	VP-21-552-09 Round Bowl, VP-28-595-09 Tank	14"	Biscuit	
161351	VP-21-502	VP-21-552 Round Bowl, VP-28-590 Tank	12"	White	
161503	VP-20-502-09	VP-21-552-09 Round Bowl, VP-28-590-09 Tank	12"	Biscuit	
161352	VP-21-504	VP-21-552 Round Bowl, VP-28-594 Tank	14"	White	
161505	VP-21-504-09	VP-21-552-09 Round Bowl, VP-28-594-09 Tank	14"	Biscuit	

Ultra Flush™ Dual-Flush Pressure Assist 2-Piece 1.1/1.6gpf Toilet

- HET High efficiency toilet
- 2-Piece toilet
- Meet EPA WaterSense® criteria
- Non-corrosive solid brass tank-to-bowl bolts
- Seat sold separately



Part #	Mfg #	Description	Rough-In	Color	Price
091838	DF-21-302	21-342 Round Bowl, DF-28-380 Tank	12"	White	
091839	DF-21-302-09	21-342-09 Round Bowl, DF-28-380-09 Tank	12"	Biscuit	
091840	DF-21-304	21-342 Round Bowl, DF-28-384 Tank	14"	White	
091843	DF-21-304-09	21-342-09 Round Bowl, DF-28-384-09 Tank	14"	Biscuit	

Toilets



Round Front Closets

Ultra Flush™ Pressure Assist 2-Piece 1.6gpf Toilet

- Sloan Flushmate pressure vessel
- Trapway averages over 3"
- Insulated non-sweating tank
- Seat sold separately



Part #	Mfg #	Description	Rough-In	Color	Price
039803	21-300	21-342 Round Bowl, 28-385 Tank	10"	White	
039808	21-302	21-342 Round Bowl, 28-380 Tank	12"	White	
039810	21-302-09	21-342-09 Round Bowl, 28-380-09 Tank	12"	Biscuit	
039811	21-304	21-342 Round Bowl, 28-384 Tank	14"	White	

PeeWee Children's Gravity Fed 2-Piece 1.28 Toilet

- Dimensions: 25"H x 16"W x 23-3/4"D
- Ready to install
- Siphon-jet
- Includes tank, toilet bowl, toilet seat, wax rings, and floor bolts



Part #	Mfg #	Description	Rough-In	Color	Price
189945	HE-20-601	Round Complete, Toilet-In-A-Box	10"	White	

Round Front Closets

Two-Piece Standard Height Alto™ 2-Piece 1.6gpf Toilet

- 1.6 Gpf / 6.0 Lpf
- Round front bowl
- 2" Glazed trapway
- Anti-siphon ballcock provides efficient toilet tank operation at high or low water pressures
- Three-point cushioned tank-to-bowl connection assures perfect tank alignment and leak proof connections.



Part #	Mfg #	Description	Rough-In	Color	Price
194498	130125WH	Round Complete	14"	White	
194500	130125BI	Round Complete	14"	Biscuit	
194499	130125BN	Round Complete	14"	Bone	
192306	130160WH	Round Complete	12"	White	
192314	130160BI	Round Complete	12"	Biscuit	
192305	130160BN	Round Complete	12"	Bone	
194468	13018WH	Round Complete	12"	White	
194469	130180BI	Round Complete	12"	Biscuit	
194470	130180BN	Round Complete	12"	Bone	
192312	131160WH	Round Complete	12"	White	
192313	131160BN	Round Complete	12"	Bone	

Cascade™ 2-Piece 1.28gpf Toilet

- Gravity fed
- Unique rimless bowl design
- 3" Flush valve
- Pilot operated fill valve
- Glazed trapway
- WaterSense Certified®: 1.28 gpf



4810-3816 Combination: 4810 Bowl, 3816 Tank

Part #	Mfg #	Description	Rough-In	Color	Price
205818	48103816	Round Complete, LH CP Trip	12"	White	

Summit™ 2-Piece Dual Flush 1.1/1.6gpf Toilet

- Round front
- Dual flush technology with 3" tower
- 1.1 Gpf / 1.6 Gpf (4.0 Lpf / 6.0 Lpf)
- Pilot operated anti-siphon fill valve
- SmartFasten 3-bolt tank-to-bowl connection
- PuraClean easy-to-clean glaze



Part #	Mfg #	Description	Rough-In	Color	Price
204260	3803386WH	Round Complete Dual Flush	12"	White	
204261	3803386BI	Round Complete Dual Flush	12"	Bone	

*Vibrant Limited Lifetime Finish

www.waterconcepts.net • Serving our Customers Since 1946 • www.plumbsupply.com

Round Front Closets

Summit™ 2-Piece 1.6gpf Toilet

- 1.6 Gpf / 6.0 Lpf
- PuraClean easy-to-clean glaze
- Pilot operated anti-siphon fill valve
- 3" Flush valve
- SmartFasten 3-bolt tank-to-bowl connection
- Decorative metal trip lever



Part #	Mfg #	Description	Rough-In	Color	Price
198188	380386WH	Round Complete	12"	White	
198187	380386BI	Round Complete	12"	Biscuit	
198432	380386BN	Round Complete	12"	Bone	

Two Piece Smartheight™ Summit™ 2-Piece 1.6gpf Smartheight™ Toilet

- Round front SmarHeight bowl
- ADA compliant
- 1.6 Gpf / 6.0 Lpf
- PuraClean easy-to-clean glaze
- Pilot operated anti-siphon fill valve
- 3" Flush valve
- SmartFasten 3-bolt tank-to-bowl connection
- Decorative metal trip lever



Part #	Mfg #	Description	Rough-In	Color	Price
210677	388386WH	Round Complete ADA Smarheight	ADA	12" White	
210678	388386BI	Round Complete ADA Smarheight	ADA	12" Biscuit	

Two Piece Elementary Elementary 2-Piece 1.28gpf Toilet

- Juvenile toilet (11-1/4" high bowl)
- Includes a SmartClose toilet seat
- Includes cover lock
- 1.28 gpf / 4.86 lpf low water consumption
- Round front bowl
- High efficiency toilet
- 2" Flapper flush valve
- Pilot operated anti-siphon fill valve
- Chrome-plated trip lever



Part #	Mfg #	Description	Rough-In	Color	Price
211489	53264320WH	Round Complete	Juvenile	12" White	

*Vibrant Limited Lifetime Finish

www.plumbsupply.com • Serving our Customers Since 1946 • www.waterconcepts.net

Tank Parts

Flush Kits

Touchless Toilet Flush Kit

- Retrofits a standard toilet to touchless flush
- Flush is activated by a non-touch sensor mounted inside the tank
- Powered by (4) AA batteries
- Works with most canister and flapper toilets
- Not compatible with dual-flush, top-mount flush, pressure-assist, or ballcock valve toilets
- Trip lever hole cover included



Part #	Mfg #	Description	Price
165485	K-1954-0	White	

Flush Actuators

Bevel® Flush Actuator Plate

- For 2"x4" in-wall tank and carrier system

For use with K-18829-NA



Part #	Mfg #	Description	Price
177777	K-8857-CP	Polished Chrome	

Portrait® Lift Knob Flush Actuator

- For K-3826 Toilet



Part #	Mfg #	Description	Price
175103	K-7677-BV	*Brushed Bronze	
183655	K-7677-SN	*Polished Nickel	
182407	K-7677-2BZ	Oil-Rubbed Bronze	

Persuade® Dual Flush Actuator

- Large top-mount buttons
- Spring-loaded buttons
- For use with k-3753 Persuade® Circ and Persuade® Curv toilets



Part #	Mfg #	Description	Price
189130	K-186-BN	*Brushed Nickel	
190296	K-186-BV	*Brushed Bronze	

Dual Flush Actuator

- Premium metal construction
- For use with Reve™, Saile®, Escalé®, Strela™ and Persuade® dual-flush toilets



Part #	Mfg #	Finish	Price
120856	K-9384-BN	*Brushed Nickel	
132498	K-9384-BV	*Brushed Bronze	
224589	K-9384-SN	*Polished Nickel	

Droplet® Flush Actuator Plate

- For use with k-18829 2"x4" in-wall tank and carrier system
- WaterSense® certified 0.8/1.6 gpf
- Plate can be removed for access to inner tank.



Part #	Mfg #	Description	Price
189339	K-4177-CP	Polished Chrome	

Veil® Flush Actuator Plate

- For 2"x6" in-wall tank and carrier system
- WaterSense® certified: 0.8/1.6 gpf
- Large flush actuator plate opening can be removed for easy access to inner tank



Part #	Mfg #	Description	Price
161708	K-6298-BN	*Brushed Nickel	
181616	K-6298-CP	Polished Chrome	
183604	K-6298-SN	*Polished Nickel	
183644	K-6298-0	White	
180079	K-6298-2BZ	Oil-Rubbed Bronze	
162487	K-6298-7	Black Black	

Veil® 2"x6" Wall-Hung Cast Iron Waste Pipe

- For use with K-6284 in-wall tank and carrier system



Part #	Mfg #	Description	Price
174219	K-6291-NA	Cast Iron, 2"x6"	

* Vibrant Limited Lifetime Warranty

www.waterconcepts.net • Serving our Customers Since 1946 • www.plumbsupply.com

Tank Parts

Trip Levers

Archer® Toilet Trip Lever



Part #	Mfg #	Finish	Price
105644	K-11069-BN	*Brushed Nickel	
107125	K-11069-BV	*Brushed Bronze	
108320	K-11069-G	Brushed Chrome	
130755	K-11069-PB	*Polished Brass	
137618	K-11069-SN	*Polished Nickel	
155674	K-11069-2BZ	Oil-Rubbed Bronze	

Bancroft™ Toilet Trip Lever



Part #	Mfg #	Finish	Price
089966	K-9475-BN	*Brushed Nickel	
111085	K-9475-BV	*Brushed Bronze	
095511	K-9475-G	Brushed Chrome	
102771	K-9475-PB	*Polished Brass	
122118	K-9475-SN	*Polished Nickel	
153291	K-9475-2BZ	Oil-Rubbed Bronze	

Cimarron™ Toilet Trip Lever

- K-9470 Blade style
- (L) left hand
- (R) right hand



Part #	Mfg #	Description	Price
086975	K-9466-L-AF	Left Hand, *French Gold	
189575	K-9466-L-BGD	Left Hand, *Moderne Br Gld	
077088	K-9466-L-BN	Left Hand, *Brushed Nickel	
080986	K-9466-L-BV	Left Hand, *Brushed Bronze	
079879	K-9466-L-G	Left Hand, Brushed Chrome	
078886	9466-L-PB	Left Hand, *Polished Brass	
147101	K-9466-L-2BZ	Left Hand, Oil-Rubbed Brnz	
106220	K-9470-L-CP	Left Hand, Pol Chrome	
082206	K-9470-L-BN	Left Hand, *Brushed Nickel	
100499	K-9470-L-BV	Left Hand, *Brushed Bronze	
173351	K-9470-L-SN	Left Hand, *Pol Nickel	
147103	K-9470-L-2BZ	Left Hand, Oil-Rubbed Brz	
166700	K-9470-R-BN	Right Hand, *Br Nickel	

Devonshire®/Memoirs® Toilet Trip Lever



Part #	Mfg #	Description	Price
060522	K-484-BN	*Brushed Nickel	
066973	K-484-CP	Polished Chrome	
170636	K-484-2BZ	Oil-Rubbed Bronze	

Dual-Flush Left Hand Trip Lever

For use with: K-3987, K-3988, and K-3989 Dual-Flush Toilets



Part #	Mfg #	Description	Price
161858	K-9237-BN	*Brushed Nickel	
173581	K-9237-CP	Polished Chrome	
170293	K-9237-2BZ	Oil-Rubbed Bronze	

Gabrielle™ Left Hand Toilet Trip Lever



Part #	Mfg #	Description	Price
078628	K-9464-L-BN	Left Hand, *Brushed Nickel	
079883	K-9464-L-BV	Left Hand, *Brushed Bronze	
176948	K-9464-L-2BZ	Left Hand, Oil-Rubbed Brz	

Memoirs® Toilet Trip Lever

- Solid-brass construction
- For use with Memoirs® one-piece toilets



Part #	Mfg #	Description	Price
137988	502-SN	*Polished Nickel	

Wellworth® Trip Lever

- Metal construction
- For use with the Wellworth® and Highline™ 2-piece toilets
- Can be used for left and right-hand tank configurations



Part #	Mfg #	Finish	Price
140290	K-9379-0	White	
140638	K-9379-96	Biscuit	
142043	K-9379-AF	*French Gold	
137744	K-9379-BN	*Brushed Nickel	
144797	K-9379-BV	*Brushed Bronze	
142519	K-9379-PB	*Polished Brass	

* Vibrant Limited Lifetime Warranty

www.plumbsupply.com • Serving our Customers Since 1946 • www.waterconcepts.net

Tank Parts

Trip Levers (Continued)
Wellworth® Trip Lever

Part #	Mfg #	Finish	Price
141421	K-9379-SN	*Polished Nickel	
152245	K-9379-2BZ	Oil-Rubbed Bronze	

Kathryn® Toilet Trip Lever



Part #	Mfg #	Finish	Price
067100	K-9451-BN	*Brushed Nickel	
075018	K-9451-BV	*Brushed Bronze	
057081	K-9451-CP	Polished Chrome	
147097	K-9451-2BZ	Oil Rubbed Bronze	

Kathryn® Vertical Trip Lever

- For K-3940 and K-3324



Part #	Mfg #	Description	Price
226152	K-9131-AF	*French Gold	
163165	K-9131-BN	*Brushed Nickel	
181437	K-9131-2BZ	Oil-Rubbed Bronze	

Kelston™ Left Hand Toilet Trip Lever



Part #	Mfg #	Description	Price
120945	K-9385-BN	Left Hand, *Brushed Nickel	
128947	K-9385-BV	Left Hand, *Brushed Bronze	
189125	K-9385-G	Left Hand, Brushed Chrome	
147092	K-9385-2BZ	Left Hand, Oil Rubbed Brz	

Toilet Trip Lever

- Metal construction
- Corrosion and tarnish resistant finish
- For use with the Memoirs® Comfort Height® toilet



Part #	Mfg #	Description	Price
183160	K-9167-L-AF	Left Hand, *French Gold	
142794	K-9167-L-BN	Left Hand, *Brushed Nickel	
147590	K-9167-L-BV	Left Hand, *Brushed Bronze	

Trip Levers (Continued)
Toilet Trip Lever

Part #	Mfg #	Description	Price
159522	K-9167-L-G	Left Hand, Brushed Chrome	
146195	K-9167-L-PB	Left Hand, *Polished Brass	
152150	K-9167-L-SN	Left Hand, *Polished Nickel	
223891	K-9167-L-VNT	Left Hand, Vintage Nickel	
143235	K-9167-L-2BZ	Left Hand, Oil Rubbed Brz	
154373	K-9167-R-BN	Right Hand, *Br Nickel	
164396	K-9167-R-PB	Right Hand, *Pol Brass	

Memoirs® Toilet Trip Lever

Part #	Mfg #	Description	Price
095314	K-9477-BN	*Brushed Nickel	

Tresham® Toilet Trip Lever

- Metal construction
- For use with K-3950 Tresham® two-piece toilet



Part #	Mfg #	Description	Price
163228	K-9375-AF	Left Hand, *French Gold	
149432	K-9375-BN	Left Hand, *Brushed Nickel	
153589	K-9375-BV	Left Hand, *Brushed Bronze	
172166	K-9375-SN	Left Hand, *Polished Nickel	
188090	K-9375-VNT	Left Hand, Vintage Nickel	
147077	K-9375-2BZ	Left Hand, Oil Rubbed Brz	

Santa Rosa™ Left Hand Toilet Trip Lever



Part #	Mfg #	Description	Price
144410	K-9169-L-BN	Left Hand, *Brushed Nickel	
146206	K-9169-L-BV	Left Hand, *Brushed Bronze	
171439	K-9169-L-PB	Left Hand, Polished Brass	
147332	K-9169-L-2BZ	Left Hand, Oil Rubbed Brz	

* Vibrant Limited Lifetime Warranty

www.waterconcepts.net • Serving our Customers Since 1946 • www.plumbsupply.com

Tank Parts

San Souci™ Left Hand Toilet Trip Lever

- For use with the K-5172 San Souci toilet



Part #	Mfg #	Description	Price
223735	K-9171-L-AF	*French Gold	
174481	K-9171-L-BN	*Brushed Nickel	
226939	K-9171-L-PB	Polished Brass	
229493	K-9171-L-SN	*Polished Nickel	
187038	K-9171-L-2BZ	Oil-Rubbed Bronze	

San Souci™ Toilet Trip Lever

- For use with the K-4007 San Souci toilet



Part #	Mfg #	Description	Price
224877	K-9176-2BZ	Left Hand, Oil-Rubbed Bronze	

Wellworth® Left-Hand Trip Lever

- Solid brass construction
- For use with K-3575 and K-3577 Wellworth® classic toilets



Part #	Mfg #	Description	Price
176656	K-9380-L-0	Left Hand, White	
152209	K-9380-L-BN	Left Hand, *Brushed Nickel	
144857	K-9380-L-BV	Left Hand, *Brushed Bronze	
147720	K-9380-L-PB	Left Hand, Polished Brass	
147090	K-9380-L-2BZ	Left Hand, Oil Rubbed Brz	

Wellworth®/Barrington™/Highline™ Pressure Lite Toilet Trip Lever

- Solid brass construction



Part #	Mfg #	Description	Price
097031	K-9481-L-BN	Left Hand, *Brushed Nickel	
094654	K-9481-L-G	Left Hand, Brushed Chrome	
147106	K-9481-L-2BZ	Left Hand, Oil Rubbed Brz	

Wellworth® Left Hand Trip Lever

- Solid brass construction
- For Wellworth® & Highline™ toilets



Part #	Mfg #	Description	Price
57230	K-9404-L-0	Left Hand, White	
056233	K-9404-L-BN	Left Hand, *Brushed Nickel	

Toilet Trip Lever and Nut

- For model K-3520



Part #	Mfg #	Description	Price
055299	GP30324-CP	Left Hand, Pol Chrome	

Flush Kits

Flush Valve Service Kit



Part #	Mfg #	Description	Price
105969	1013944	Flush Valve Service Kit	

Canister Valve Assembly for Single Flush Toilets

- Canister flapper for toilets
- Gaskets included



Part #	Mfg #	Description	Price
121408	1069722	Canister Flapper Assy Kit	
164476	1216610	Canister Valve Assy	
176536	1216614	Canister Valve Assy	
178033	GP1229656	Canister Repair Kit	

Flappers

Flapper



Part #	Mfg #	Description	Price
105337	GP1039444	Flapper for 1-Piece Toilets	
122919	GP1060740	Flapper for 1-Piece Toilets	
120115	GP1078440	Flapper for 1-Piece Toilets	
119016	GP1078441	Flapper for 2-Piece Toilets	
055313	GP84995	Flapper (Hinge)	
055291	GP85160	Flapper, Blue with Float	
055289	GP87449	Flapper, Blue less Float	
093108	GP89825	Flapper Assembly	

* Vibrant Limited Lifetime Warranty

www.plumbsupply.com • Serving our Customers Since 1946 • www.waterconcepts.net

Tank Parts

Trip Lever Service Kit



Part #	Mfg #	Description	Price
152893	30324-BRZ	Trip Lever & Nut	
55221	500189-CP	Trip Lever Assy	
160784	55335	Trip Lever	
182657	55615-CP	Trip Lever Assy, Chrome	
182658	55615-G	Trip Lever Assy, Br Chrome	
183340	55615-VF	Trip Lever Assy *Pol Brass	
160885	81609-CP	Trip Lever, Chrome	
182736	81610-CP	Trip Lever Kit, Chrome	
182936	81610-VF	Trip Lever Kit, *Pol Brass	
182937	81611-VF	Trip Lever Kit, *Pol Brass	
186800	84874-BN	Trip Lever Kit, *Br Nickel	
175334	84874-CP	Trip Lever Kit, Chrome	
183346	85084-BRZ	Trip Lever Assy, Oil-Rd Brz	
153353	85084-CP	Trip Lever Assy, Chrome	
182939	85085-BN	Trip Lever Assy, *Br Nickel	
166230	85085-CP	Trip Lever Assy, Pol Chr	
190208	85086-VF	Trip Lever Assy, Pol Brass	
186772	87115-BN	Trip Lever Assy, *Br Nickel	
101025	87115-CP	Trip Lever Assy, *Chrome	
183190	1034693-VF	Trip Lever Kit, *Pol Brass	
162928	1042212-CP	Trip Lever Kit, Chrome	
183202	1045276-BRZ	Trip Lever Kit, Oil-Rubd Brz	
167527	1069724-BN	Trip Lever Kit, *Br Nickel	
136836	1075394-BRZ	Trip Lever Kit, Oil-Rubd Brz	
161451	1075394-CP	Trip Lever Kit, Chrome	
183233	1089001-CP	Trip Lever Kit, Chrome	
183327	1126917-BV	Trip Lever, *Br Bronze	
170104	1126917-CP	Trip Lever Kit, Chrome	
150879	1133133-CP	Trip Lever Kit, Chrome	
150290	1142713-CP	Trip Lever Kit, Chrome	
183699	1160316-BRZ	Trip Lever Service Kit, ORB	
183701	1160316-CP	Trip Lever Service Kit, Chr	

Flush Valve Seal



Part #	Mfg #	Description	Price
055361	GP83888	Flush Valve Seal	
116169	GP1059291	Flush Valve Seal Kit	

Tank Cover

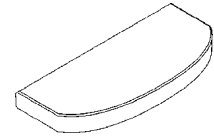

1086929

Part #	Mfg #	Description	Price
159633	1000401-BC	Bright Chrome	
167048	1046467-0	White, Kelston	
165618	1052861-96	Biscuit, Memoirs	
166880	1052862-0	White, Memoirs Stately	
167170	1055954-0	White, Tank Lid	
170793	1055954-96	Biscuit, Tank Lid	
156049	1070414-47	Almond	
170734	1086929-0	White, Close Coupled	
162684	1086929-7	Black, Black Close Coupled	
125084	1086929-96	Biscuit, Close Coupled	
153988	1138565-0	White	
169716	1138565-96	Biscuit	
166928	1145223-0	White	
182735	81509-33	Mexican Sand	
222951	84252-0	White	
081116	84591-0	White	
153399	84591-47	Almond	
183715	88497-NY	Dune	

Fill Valves

Fill Valve



Part #	Mfg #	Description	Price
136555	1043213	Fill Valve Assy	
108373	GP1068030	Fill Valve Assy	
177990	1069398	Fill Valve Assy	
183238	1097230	Fill Valve Kit	
134063	GP1138930	Float Valve Kit	

* Vibrant Limited Lifetime Warranty

www.waterconcepts.net • Serving our Customers Since 1946 • www.plumbsupply.com

Tank Parts

Valve



Part #	Mfg #	Description	Price
181498	83093	Flush Valve Kit	
160713	84996	Flush Valve Kit	
095560	85406	Flush Valve	
158343	87373	Flush Valve Kit	
182949	89827	Flush Valve Assy	
158795	1007489	Fill Valve Assy	
182878	1016123	Flush Valve Kit	
183189	1032640	Flush Valve Kit	
182849	1042499	Flush Valve Kit	
177989	1058776	Flush Valve Kit	
183219	1060862	Flush Valve Kit	
154341	1080961	Valve Assembly Kit	
183239	1097231	Flush Valve Kit	
175065	1132466	Flush Valve	
183332	1145275	Flush Valve	
153142	1145365	Flush Valve Kit	
168700	1151862	Flush Valve Kit	
160353	1152349	Valve Assembly	
158438	1188998	Flush Valve Kit	
183708	1188999	Flush Valve Kit	
183709	1189000	Flush Valve Kit	
158264	1189001	Flush Valve Kit	
163314	1216612	Canister Valve Assy	

Miscellaneous Tank Parts

Toilet Tank Gasket

- 2" Seal for drylock



Part #	Mfg #	Description	Price
155255	GP1112256	2" Seal for drylock	

* Vibrant Limited Lifetime Warranty

www.plumbsupply.com • Serving our Customers Since 1946 • www.waterconcepts.net

Tank Parts

Trip Levers

Addison™ Trip Lever



Part #	Mfg #	Description	Price
167409	79260	Chrome	
166033	79260-CZ	Champagne Bronze™	
164375	79260-RB	Venetian Bronze®	
160249	79260-SS	Stainless*	

Arzo™ Trip Lever



Part #	Mfg #	Description	Price
173887	77560	Chrome	
163956	77560-SS	Stainless*	

Cassidy™ Trip Lever



Part #	Mfg #	Description	Price
156849	79760	Chrome	
175411	79760-CZ	Champagne Bronze™	
161212	79760-PN	Polished Nickel	
165819	79760-SS	Stainless*	
150962	79760-RB	Venetian Bronze®	

Cassidy™ French Curve Trip Lever



Part #	Mfg #	Description	Price
173527	79860	Chrome	
154522	79860-CZ	Champagne Bronze™	
161717	79860-PN	Polished Nickel	
165130	79860-RB	Venetian Bronze®	
176750	79860-SS	Stainless*	

Compel Trip Lever



Part #	Mfg #	Description	Price
175419	77160	Chrome	
159647	77160-SS	Stainless*	

Dryden™ Trip Lever



Part #	Mfg #	Description	Price
178513	75160	Chrome	
163315	75160-CZ	Champagne Bronze™	
181349	75160-PN	Polished Nickel*	
162281	75160-RB	Venetian Bronze®	
159517	75160-SS	Stainless*	

Trinsic™ Trip Lever



Part #	Mfg #	Description	Price
179762	75960-CZ	Champagne Bronze™	
159098	75960-RB	Venetian Bronze®	
161610	75960-SS	Stainless*	

Victorian® T Trip Lever



Part #	Mfg #	Finish	Price
059730	75060	Chrome	
166041	75060-CZ	Champagne Bronze™	
095100	75060-PN	Polished Nickel*	
057187	75060-PB	Polished Brass*	
073502	75060-SS	Stainless*	
055721	75060-RB	Venetian Bronze®	

* Brilliance® Anti-Tarnish Lifetime Finishes

www.waterconcepts.net • Serving our Customers Since 1946 • www.plumbsupply.com

Tank Parts

Vero™ Trip Lever



Part #	Mfg #	Description	Price
175420	77760	Chrome	
167402	77760-RB	Venetian Bronze®	
166562	77760-SS	Stainless*	

RSVP® Trip Lever



Part #	Mfg #	Description	Price
114792	69960-BN	Brushed Nickel*	
173645	69960-PC	Chrome	

Brizo Trip Levers

Charlotte™ Front-Mount Trip Lever



Part #	Mfg #	Description	Price
180677	696085-BN	Brushed Nickel*	
190411	696085-PN	Polished Nickel*	

RSVP® Side-Mount Trip Lever



Part #	Mfg #	Description	Price
145031	69962-BN	Brushed Nickel*	
181896	69962-PC	Chrome	

Charlotte™ Side-Mount Trip Lever



Part #	Mfg #	Description	Price
163774	696285-PNC O	Cocoa Bronze & Pol Nickel	

Siderna® Trip Lever



Part #	Mfg #	Description	Price
188614	696080-BL	Matte Black	
171847	696080-PC	Chrome	

Odin Front-Mount Trip Lever



Part #	Mfg #	Description	Price
225075	696075-BN	Brushed Nickel*	
226107	696075-BL	Matte Black	

Siderna Side-Mount Trip Lever



Part #	Mfg #	Description	Price
178523	696280-BN	Brushed Nickel*	

Rook Universal Trip Lever



Part #	Mfg #	Description	Price
185806	696361-NK	Luxe Nickel*	

Sotria Trip Lever



Part #	Mfg #	Description	Price
181334	696050-NK	Luxe Nickel*	

* Brilliance® Anti-Tarnish Lifetime Finishes

www.plumbsupply.com • Serving our Customers Since 1946 • www.waterconcepts.net

Toilets

Tank Parts

Traditional Trip Lever

• Front mount



Part #	Mfg #	Description	Price
117007	69561-BZ	Brushed Bronze*	
144012	69561-PC	Chrome	
085403	69561-RB	Venetian Bronze®	

Virage® Trip Lever



Part #	Mfg #	Description	Price
138713	696230-BZ	Brushed Bronze*	
168462	696230-RB	Venetian Bronze®	

Vesi® Channel Trip Lever



Part #	Mfg #	Description	Price
162266	696340-BN	Brushed Nickel*	

Virage® Trip Lever



Part #	Mfg #	Description	Price
158970	696030-BN	Brushed Nickel*	
170232	696030-RB	Venetian Bronze®	

Toilets

* Brilliance® Anti-Tarnish Lifetime Finishes

www.waterconcepts.net • Serving our Customers Since 1946 • www.plumbsupply.com

Tank Parts

Tank Levers

Brantford™ Tank Lever



Part #	Mfg #	Finish	Price
102299	YB2201ORB	Oil Rubbed Bronze	
103429	YB2201BN	Brushed Nickel	

Eva™ Tank Lever



Part #	Mfg #	Finish	Price
097222	YB2801BN	Brushed Nickel	
109978	YB2801CH	Chrome	

Kingsley™ Tank Lever



Part #	Mfg #	Finish	Price
083456	YB5401ORB	Oil Rubbed Bronze	

Icon™ Tank Lever



Part #	Mfg #	Finish	Price
101731	YB5801CH	Chrome	

Voss™ Tank Lever



Part #	Mfg #	Finish	Price
153124	YB5101BN	Brushed Nickel	
157526	YB5101CH	Chrome	
162351	YB5101ORB	Oil Rubbed Bronze	

Waterhill® Tank Lever



Part #	Mfg #	Finish	Price
172077	YB9801NL	Polished Nickel	
123964	YB9801ORB	Oil Rubbed Bronze	

Weymouth® Tank Lever



Part #	Mfg #	Finish	Price
183891	YB8401CH	Chrome	
152843	YB8401NL	Polished Nickel	



Tank Parts

Gerber® Toilet Tank Parts

Flapper

Part #	Mfg #	Description	Price
063847	99-644	2" Rigid Flapper Assembly for Black Pedestal Flush Valve	
084363	99-647	1.6 gpm Flapper	
105004	99-770	1.6 gpm Flapper for 3" Flush Valves	

Tank Lid

Part #	Mfg #	Description	Price
018651	28-799	Tank Lid, White	
107949	TC-28-590	Tank Lid for Viper Toilets, White	
097776	TC-28-601	Tank Lid for PeeWee Children's Gravity Fed Toilets, White	

Trip Lever

Part #	Mfg #	Description	Price
028802	99-586	Tank Lever, All Gravity Tanks, White Plastic	
038088	99-571KT	Tank Lever, Chrome	
104778	99-588	Chrome, Metal Tank Lever for Aqua Saver™ & Maxwell®	
112219	99-685	Tank Lever for Gravity Fed Toilets, Chrome	
107950	99-656	LH Trip Lever for Viper Tank, Chrome	
109977	99-656-09	Tank Lever for Viper Gravity Fed Toilets, Biscuit	
110648	99-656WH	LH Trip Lever for Viper Tank, White	
060279	N9-571	Trip Lever for FMIII 2-Pc Units, Brushed Nickel	
076134	WH571	Metal Trip Lever for FM III 2-Pc Units, White	

Flush Valves

Part #	Mfg #	Description	Price
037484	99-403	Flush Valve Cartridge	
101980	99-648	Viper Flush Valve	

Washers

Part #	Mfg #	Description	Price
004790	90-940	Washer	
004795	91-150	Beveled Washer for Bath waste Head	
026026	91-260	Washer	

*Physical Vapor Deposition (PVD) Limited Lifetime Finish

www.waterconcepts.net • Serving our Customers Since 1946 • www.plumbsupply.com

Tank Parts

Toilet Tank Fill Valves

- Fits most toilet tanks
- Saves water
- Easy to install
- Replaces old-fashioned units
- Corrosion-resistant materials

PRO45 Fill Valve

- Ultra-quiet operation
- Minimal water hammer
- Code approved



Part #	Mfg #	Description	Price
096993	PRO45	Fill Valve	

PRO45U Universal Fill Valve

- For all two-piece toilets and most one-piece toilets
- Refill diverter inserts and roller clamp refill adjuster allow PRO45U to set toilet to factory specifications for bowl refill
- Ultra-quiet operation
- Minimal water hammer
- Code approved



Part #	Mfg #	Description	Price
145790	PRO45U	Universal Fill Valve	

Pro Series® Fill Valve

- Heavy-duty shank manages water flow, eliminating water hammer by 99% and delivering tank refill at half the noise level of other valves
- Adjustable height for a universal fit and a float screw for fine tuning
- Extremely durable



Part #	Mfg #	Description	Price
096995	PRO45B	Anti-Siphon Fill Valve w/Brass Shank	
097287	PRO45C	Anti-Siphon Fill Valve w/Adj Flapper	
096994	PRO45K	Complete Kit Includes Fill Valve, Flush Valve, Bowl Gasket, Bolts, and Tank Lever	

Fill Valve Repair Parts

Replacement Seal

- Easy repair, extends valve life



Part #	Mfg #	Description	Price
004376	242	For 200A & 400A Fill Valves	
004370	B212	Replacement Seal, Bulk	

Flush Valves

507AK Complete Toilet Bowl Gasket

- Saves water, stops leaks at the drain
- Includes proven Adjust-A-Flush™ flapper that dials to adjust water volume for a custom flush
- Fits most 2- and 3-bolt tanks, including 1.6 gallon models
- Easy to install
- Universal gasket fits most close-coupled toilets
- 5-Year warranty



Part #	Mfg #	Description	Price
062253	507AK	Flush Valve, Bolts & Gasket	

540AKR Complete 3" Toilet Flush Valve Kit

- Fixes leaks between tank and bowl
- Easy adjustable overflow tube
- Adjustable flapper to maximize water savings
- Chlorine resistant silicone flapper seal
- Includes:
 - Gasket
 - Bolts
 - Washers
 - Nuts



Part #	Mfg #	Description	Price
169180	540AKRP5	Universal Flush Valve, 3"	

Tank Parts

PRO57 Flush Valve

- Longer-life, kink-free stainless steel chain
- Corrosion-resistant materials withstand constant use
- Adjustable float controls water in tank for optimal flush
- Universal-fit, chlorine-resistant flapper that fits most toilets
- 5-Year warranty



Part #	Mfg #	Description	Price
096996	PRO57	Flush Valve	
097290	PRO57K	Flush Valve w/PRO55 Flapper	

Pro Series™ Ballcocks

- Solid brass arm
- 3-Year warranty



Part #	Mfg #	Description	Price
096991	PRO15	12" Ballcock less Flapper	
096992	PRO15C	12" Ballcock with PRO53 Flapper	

Flappers
PRO53 Flapper

- Professional grade material
- Kink-free heavy-duty metal chain
- Replaces most worn flapper or tank ball units



Part #	Mfg #	Description	Price
096997	PRO53	Heavy-Duty Flapper	

PRO54 Chemical-Resistant Flapper

- Universal fit flapper
- Fits flush valves with and without mounting ears and American Standard actuator units
- Strong, kink-free metal chain
- Durable material resists chemicals and hard water
- 5-Year warranty



Part #	Mfg #	Description	Price
096998	PRO54	Chemical-Resistant Flapper	

PRO55 Flapper

- Adjustable volume for optimal flushes every time
- Chlorine resistant
- Heavy-duty metal chain with float
- Fits most flapper or tank ball units



Part #	Mfg #	Description	Price
097288	PRO55	Flapper w/Adjustable Float	
097289	PRO55R	Flapper w/Adjustable Float, 3/Pk	

Pro Series Universal Adjustable Flapper

- Adjustable dial
- Chlorine and hard water resistant
- Solid frame for the best seal every time – no twisting
- Fits most 2" flush valves
- Built-in Microban®



Part #	Mfg #	Description	Price
165929	PRO56	1.28 to 3.5+ gpf	

Bull's Eye® Super Flapper

- Chlorine-resistant for harsh water regions
- Outlasts vinyl or rubber
- Ends leaks at the tank drain
- Rigid frame precisely aligns flapper on drain
- 5-Year warranty



Part #	Mfg #	Description	Price
035805	501	Fits Most Tanks	

3" Universal Water Saving Long Life Toilet Flapper

- Fits all 3" flapper toilets currently on the market
- Fits toilets in three easy adjustments
- Included guide tells you what settings you need for the most popular toilets
- Silicone seal lasts up to ten times longer than a regular flapper
- 10-Year warranty



Part #	Mfg #	Description	Price
120028	5403	3" Universal Flapper	

Toilets

Tank Parts

Five Minute Flush Valve Repair Kit

- True universal flapper
- Provides new drain seat for damaged flush valves
- Works on most toilets
- Chlorine-resistant, rigid frame flapper
- Adjustable timing cup for most efficient flush
- 5-Year warranty



Part #	Mfg #	Description	Price
004380	555CRP8	Fits Most Tanks	

Tank Levers

Sure-Fit® Tank Lever

- Trims/bends to fit most front, side and angle-mounted tanks
- No pre-measuring required
- Easy to install
- Self-tightening lock-nut won't loosen over time
- Durable, non-corroding plastic
- Fits most American Standard®, Eljer®, Kohler® Wellworth® brand toilets and more



Part #	Mfg #	Description	Price
004382	680	White	
004383	681	Chrome	

Sure-Fit® Metal-Arm Tank Lever

- Trims/bends to fit most front, side and angle-mounted tanks
- Easy to install
- Self-tightening lock-nut won't loosen over time
- Fits most American Standard®, Eljer®, Kohler® Wellworth® brand toilets and more



Part #	Mfg #	Description	Price
064603	683	White	
064606	686	Platinum	
117322	687	Oil Rubbed Bronze	

PRO61 Tank Lever

- Direct replacement tank lever
- Chrome finished handle
- Self-tightening lock nut
- Fits most Eljer®, American Standard®, Kohler® Wellworth®, and Mansfield® toilets



Part #	Mfg #	Description	Price
096999	PRO61	Tank Lever w/Chrome Handle	

PRO64 Tank Lever

- Direct replacement tank lever
- European style chrome finished handle
- Self-tightening lock nut (won't loosen over time)
- Fits most Eljer®, American Standard®, Kohler® Wellworth®, and Mansfield® toilets



Part #	Mfg #	Description	Price
097000	PRO64	Euro Style, Chrome	

Flush Valve-Related Products

American Standard™ Seat Disc

- Fits all American Standard actuator flush valves
- For snap-on or thread-type actuators
- Chlorine resistant



Part #	Mfg #	Description	Price
051580	5103	American Standard™ Seat Disc	

Dual Flush Kits

- Converts your existing toilet to dual flush technology
- Uses up to 45% less water
- Durable silicone seal lasts for years
- Fully adjustable full and half flush
- Retrofits to any 2" toilet
- Installs easily
- Includes high refill fill valve and tank lever
- 5-Year warranty



Part #	Mfg #	Description	Price
135370	S2DBL	Dual Flush Kit	

Toilets

Tank Parts

Closet Tank Parts
Douglas Flush Valve

- Rubber washer
- Solid ring guide
- Locknut
- Overflow tube



Part #	Mfg #	Description	Price
008025	1029	White Plastic Flush Valve, w/Flapper	

Anti-Siphon Ballcock

- Brass float rod
- Adjustment screw



Part #	Mfg #	Description	Price
008021	1015N	Diaphragm and Adjustable Screw	

Lift Wire - Brass



Part #	Mfg #	Description	Price
008111	856	9" Upper Lift Wire	



Tank Parts

Tank Replacement Parts Mansfield® Style Flush Valve



Part #	Mfg #	Description	Price
111990	090700	In Plastic Hanging Bag	

Replacement Seal

Part #	Mfg #	Description	Price
108423	090735	208/209, Black	

Tank Parts

Toilet Flappers

- *Guaranteed chemical resistant for 6 years*



Part #	Mfg #	Description	Price
076236	16BP	Korky 1.6 Adj Replacement Flapper	
006219	54BP	Korky® "Original" Universal	
006221	58BP	Kohler® Red Flush Ball	
006201	2001BP	Red Korky® Plus	
137329	2004BP	Korky® Plus Premium Adjustable For Kohler & American Standard 2-Piece Toilets	

Tank Parts

Toilet Tank Parts

Triple Seal® Tank Ball



B-251-12

B-252

Part #	Mfg #	Description	Price
008850	B-251-12	2-5/8" Standard, 12/Pk	
008851	B-252	3" Standard	

TITE-SEAL® Tank Ball

- *Designed to fit the curvature of all flush valves*



Part #	Mfg #	Description	Price
008852	B-254-12	Standard, 12/Pk	

Toilets

Tank Parts

Flush Valves

Douglas Flush Valve

- Includes locknut, beveled washer, and flapper tank ball



Part #	Mfg #	Description	Price
045714	C05-070	Plastic with SS Chain	

Mansfield Flush Valve #210

- Water saver
- 3.5 Gallon toilets
- Instant shut-offs
- Will not rust or corrode



Part #	Mfg #	Description	Price
093658	T02-066	Flush Valve	

Ballcocks

Eljer Tank Ball

- Black Plastic
- Sold in Carton Qty



Part #	Mfg #	Description	Price
180165	C04020	Tank Ball	

Mansfield Style Ballcock with Float Rod

Part #	Mfg #	Description	Price
148502	T03-008	Ballcock w/Float Rod #08	

Ballcock Repair Parts

For Mansfield*



T02064



T02065

Part #	Mfg #	Description	Price
071224	T02-064	208/209 Flush Valve Diaphragm	
093652	T02-065	210/211 Flush Valve Seal	

* Manufacturer's name used only to describe whose products item will fit

Tank Trip Levers



T01012

Part #	Mfg #	Description	Price
046599	T01-012	Chrome, Fits Kohler® Cast Brass Arm	
093641	T01-040	Chrome, Fits Mansfield Tank #8, #16, #35, #41, #51	

Tank Balls



C04-030

Part #	Mfg #	Description	Price
097909	C04-030	Tri-Seal Tank Ball (Boxed)	

Float Balls

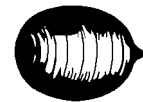

Part #	Mfg #	Description	Price
091568	C05-040	4" x 5" Plastic	

Flappers

Flapper



Part #	Mfg #	Description	Price
047201	C04-008	Vinyl Tank Ball/Flapper for Kohler	

Blue Vinyl Flapper

- Fits most plastic flush valves
- 9" Stainless steel chain and hook
- Easily installed - no collar to cut
- Chemical resistant
- 5-Year warranty on flapper life



Part #	Mfg #	Description	Price
043277	C04-014	Blue Vinyl Flapper	

Toilets

Tank Parts

Flapper Crane® Style

- 9" Chain with flex arms
- High grade vinyl construction
- Carton Quantities Only



Part #	Mfg #	Description	Price
227621	C04010	Crane® Style	

Brass Lift Wire Guide

- Carton Qty only
- standard splitting



Part #	Mfg #	Description	Price
152222	C05057	Lift Wire Guide	



Tank Parts

Toilet Trip Levers

Universal Trip Lever

- Fits most standard old style 2-piece toilets
- Front-mount



Part #	Mfg #	Finish	Price
147373	934-ORB	Oil Rubbed Bronze	

Commercial Toilet Seats

Commercial Toilet Seats

Lustra™ Commercial Open Front Seat

- Solid polypropylene plastic resistant to staining, fading, chipping peeling
- Open front with check hinge
- Without cover
- C = Check hinge
- SC = Self-sustaining check hinge
- A = Anti-microbial



Part #	Mfg #	Style	Color	Price
060424	K-4670-C-47	Elongated	Almond	
058174	K-4670-C-95	Elongated	Ice Grey™	
078340	K-4670-C-K4	Elongated	Cashmere	
065583	K-4670-CA-0	Elongated	White	
053392	K-4670-SC-0	Elongated	White	
060836	K-4679-CA-0	1" Bumpers	White	

Lustra™ Commercial Open Front Seat

- Solid polypropylene plastic
- Without cover
- Self-raising hinge
- Stainless steel mounting bolts



Part #	Mfg #	Style	Color	Price
154497	K-4672-0	Elongated	White	

Lustra™ Commercial Open Front Seat with Check Hinge

- Solid polypropylene plastic
- Without cover
- Stainless steel mounting bolts



Part #	Mfg #	Style	Color	Price
156564	K-4667-C-7	Elongated	Black	

Stronghold® Commercial Open Front Seat

- Solid polypropylene plastic resistant to staining, fading, chipping, peeling
- Integrated handle allows user to easily raise and lower the ring
- Check hinge stops seat from leaning back and applying pressure on tank/flushometer
- Cover sold separately
- C = Check hinge
- GC = Quiet-Close™ check hinge
- SC = Self-sustaining check hinge
- CA = Check hinge and Anti-Microbial



Part #	Mfg #	Style	Color	Price
103331	K-4731-C-0	Elongated	White	
156010	K-4731-C-47	Elongated	Almond	
118166	K-4731-C-7	Elongated	Black Black™	
133529	K-4731-C-96	Elongated	Biscuit	
129852	K-4731-GC-0	Elongated	White	
103329	K-4731-SC-0	Elongated	White	
183072	K-4731-CA-0	Elongated	White	

Triko™ Open Front Toilet Seat

- Molded wood
- Polished chrome hinges



Part #	Mfg #	Style	Color	Price
182458	K-4710-GS-0	Elongated	White	

*Vibrant Limited Lifetime Finish

www.plumbsupply.com • Serving our Customers Since 1946 • www.waterconcepts.net

Commercial Toilet Seats

Toilet Seats

Commercial Plastic Toilet Seats

9400SSCT Commercial Open Front Plastic Seat

- Heavyweight injection molded solid plastic
- Self-sustaining check hinges with non-corrosive 300 stainless steel posts and pintles
- Sta-Tite® commercial fastening system™
- Cover sold separately



Part #	Mfg #	Style	Color	Price
002394	9400SSCT-000	Elongated	White	

1655CT Commercial Open Front Plastic Seat

- Extra heavyweight contoured seat
- Sta-Tite® Commercial fastening System™
- External check hinges with 300 Series stainless steel posts and pintles that stop seat 11° beyond vertical
- Cover sold separately



Part #	Mfg #	Style	Color	Price
002354	1655SSCT	Elongated	White/SS	
118923	1655CT-000	Elongated	White	

1955SSC Commercial Open Front Plastic Seat

- Heavyweight
- Self-sustaining and external check hinge
- Cover sold separately



Part #	Mfg #	Style	Color	Price
002361	1955SSC-000	Elongated	White	
002362	1955SSC-047	Elongated	Black	

955CT/1955CT Commercial Open Front Plastic Seat

- Extra heavyweight contoured seat
- Sta-Tite® Commercial fastening System™
- External check hinges with 300 Series stainless steel posts and pintles that stop seat 11° beyond vertical
- Cover sold separately



1955CT

Part #	Mfg #	Style	Color	Price
002395	955CT-000	Round	White	
002359	1955CT-000	Elongated	White	
002360	1955CT-047	Elongated	Black	

955SSCT Commercial Open Front Plastic Seat

- Extra heavyweight contoured seat
- Sta-Tite® Commercial fastening System™
- External check hinges with 300 Series stainless steel posts and pintles that stop seat 11° beyond vertical
- Cover sold separately



Part #	Mfg #	Style	Color	Price
002397	955SSCT-000	Round	White	

BB955C Baby Bowl Commercial Open Front Plastic Seat

- External check hinge with stainless steel post
- Cover sold separately



Part #	Mfg #	Style	Color	Price
002323	BB955C-000	Round	White	

1900SS Commercial Plastic Seat with Cover

- Heavyweight
- Self-sustaining hinge
- Closed front
- 300 Series stainless steel hardware



Part #	Mfg #	Style	Color	Price
027186	1900SS-000	Elongated	White	

Commercial Toilet Seats

1950 Commercial Open Front Plastic Seat with Cover

- Commercial weight
- Top-Tite® hinge



Part #	Mfg #	Style	Color	Price
002356	1950-000	Elongated	White	
002358	1950SS	Elongated	White/SS	

3L2050T Open Front Plastic Seat with Cover

- STA-TITE® commercial fastening system
- DuraGuard® Antimicrobial
- 3" Lift hinges and bumpers



Part #	Mfg #	Style	Color	Price
169461	3L2050T	Elongated	White	

2155C Commercial Open Front Plastic Seat

- Duraguard® anti-microbial agent
- Heavyweight
- External check hinge with stainless steel post
- Cover sold separately
- Hinges:
 - 2155C - Check hinge
 - 2155SSC - Has self-sustaining hinge



Part #	Mfg #	Style	Color	Price
070728	2155C-000	Elongated	White	
030385	2155SSC-000	Elongated	White	

3155C Commercial Open Front Extra Heavy Plastic Seat

- Duraguard® anti-microbial agent
- Heavyweight
- External check hinge with stainless steel post
- Cover sold separately
- Hinges:
 - 3155C - Check hinge
 - 3155SSC - Has self-sustaining hinge



Part #	Mfg #	Style	Color	Price
030638	3155SSC-000	Elongated	White	

3155CT Commercial Open Front Extra Heavy Plastic Seat

- Duraguard® anti-microbial agent
- Heavyweight
- External check hinge with stainless steel post
- Cover sold separately



Part #	Mfg #	Style	Color	Price
118925	3155CT-000	Elongated	White	

Medic-Aid® Heavy Duty Commercial Plastic Toilet Seat

- STA-TITE® Commercial fastening system
- Heavy-Weight plastic
- 3" Lifts
- 300 Series Stainless steel posts and pintles



(3L2150T) - Includes Cover

Part #	Mfg #	Style	Color	Price
132585	3L2155T	Elongated	White	
147196	3L2150T	Elongated	White	



Commercial Toilet Seats

Toilet Seats

Commercial Plastic Toilet Seats

1580CT Commercial Open Front Plastic Seat

- Check Hinge
- STA-TITE® Commercial Fastening System™
- Designed to Fit Baby Bowls
- DuraGuard® Antimicrobial Built-In Seat Protection™



Part #	Mfg #	Style	Color	Price
192350	1580CT000	Toddler/Baby	White	

255 Commercial Open Front Plastic Seat

- Check Hinge
- Non-Corrosive Hardware



Part #	Mfg #	Style	Color	Price
203971	255	Elongated	White	

293SS Commercial Open Front with Cover Plastic Seat

- Metal Hinge
- 300 Series Stainless Hardware
- Self-Sustaining Hinge



Part #	Mfg #	Style	Color	Price
194036	293SS	Elongated	White	

295CT Commercial Open Front Plastic Seat

- Check Hinge
- Non-Corrosive 300 Series Stainless Steel Posts
- STA-TITE® Commercial Fastening System™



Part #	Mfg #	Style	Color	Price
218552	295CT	Elongated	White	

295SSCT Commercial Open Front Plastic Seat

- Check Hinge
- Self-Sustaining Hinge
- 300 Series Stainless Hardware
- STA-TITE®



Part #	Mfg #	Style	Color	Price
193197	295SSCT	Elongated	Black	
193196	295SSCT	Elongated	White	

397SSCT Commercial Open Front Plastic Seat

- Self-Sustaining Hinge
- 300 Series Stainless Hardware
- STA-TITE®
- STA-TITE® Commercial Fastening System™
- Non-Corrosive 300 Series Stainless Steel Posts



Part #	Mfg #	Style	Color	Price
193201	397SSCT	Round	White	

9500CT Commercial Open Front Plastic Seat

- Check Hinge
- Non-Corrosive 300 Series Stainless Steel Posts
- STA-TITE® Commercial Fastening System™



Part #	Mfg #	Style	Color	Price
221877	9500CT	Elongated	White	

9500SSCT Commercial Open Front Plastic Seat

- Check Hinge
- Self-Sustaining Hinge
- Non-Corrosive 300 Series Stainless Steel Posts
- STA-TITE®



Part #	Mfg #	Style	Color	Price
193205	9500SSCT	Elongated	White	



Commercial Toilet Seats

7650T Hospitality Open Front with Cover Plastic Seat

- Non-Corrosive 300 Series Stainless Steel Posts
- STA-TITE® Commercial Fastening System™



Part #	Mfg #	Style	Color	Price
193568	7650T	Elongated	White	

3L2150T Medic-Aid® Open Front with Cover Plastic Toilet Seat

- Non-Corrosive 300 Series Stainless Steel Posts
- STA-TITE® Commercial Fastening System™
- DuraGuard® Antimicrobial Built-In Seat Protection™
- 3" Lift Hinges and Bumpers



Part #	Mfg #	Style	Color	Price
202530	3L2150T	Elongated	White	

Toilet Seats

Plastic Toilet Seats

Toilet Seats

Residential Plastic Elongated Toilet Seats

Bancroft™ Residential Closed Front Plastic Seat with Cover

- Solid polypropylene plastic resistant to staining, fading, chipping peeling
- -CP - Polished chrome hinges
- -BN - *Brushed nickel hinges
- (K-4659-0) includes Quick-Release™ plastic hinges



K-4659



K-4685

Part #	Mfg #	Style	Color	Price
088742	K-4659-0	Elongated	White	
141034	K-4659-58	Elongated	Thunder Grey	
093745	K-4659-G9	Elongated	Sandbar	
087315	K-4685-CP-0	Elongated	White	
108566	K-4685-BN-47	Elongated	Almond	

Brevia™ Q2 Advantage™ Residential Closed Front Plastic Seat with Cover

- Quick-Attach™ hardware for a fast and secure installation
- Quick-Release™ hinges allow the seats to be easily removed for cleaning
- Fits one- and two-piece toilets
- Made of solid polypropylene plastic and is resistant to staining, fading, chipping and peeling
- Contoured seat for user comfort



Part #	Mfg #	Style	Color	Price
140965	K-4774-0	Elongated	White	
142394	K-4774-7	Elongated	Black Black	
141902	K-4774-47	Elongated	Almond	
140969	K-4774-95	Elongated	Ice Grey	
140966	K-4774-96	Elongated	Biscuit	
143937	K-4774-G9	Elongated	Sandbar	
185337	K-4774-NY	Elongated	Dune	

Cachet® Quick-Release™ Hinges with Grip-Tight Toilet Seat

- Quick-Attach® hardware
- Grip-tight bumpers



Part #	Mfg #	Style	Color	Price
185955	K-7315-0	Elongated	White	
224559	K-7315-96	Elongated	Biscuit	

Cachet® Nightlight Quiet-Close™ Residential Closed Front Seat with Cover

- Light intensity designed to provide enough light to see toilet w/o disrupting nighttime vision
- Dual LED lighting
- Illumination cycle with automatic 7-hour nightlight
- Battery-operated (4) AA
- Up to 6 months of battery life
- Grip-tight bumpers
- Quick-Release™ hinges
- Quick-Attach® hardware



Part #	Mfg #	Style	Color	Price
180697	K-75796-0	Elongated	White	
167629	K-75796-47	Elongated	Almond	
188957	K-75796-95	Elongated	Ice Grey	
179826	K-75796-96	Elongated	Biscuit	

Cachet® Quiet-Close™ Residential Closed Front Plastic Seat with Cover

- Solid polypropylene plastic
- Contoured seat for user comfort
- Quiet-Close™ lid and ring prevents slamming
- Quick-Release™ hinge caps snap open and seat pulls forward for removal
- Quick-Attach™ stainless steel fastener allows for top-mount screwdriver only install
- Slip resistant bumpers hold seat firmly in place
- Fits one- and two-piece toilets



Part #	Mfg #	Style	Color	Price
076739	K-4636-0	Elongated	White	
081986	K-4636-33	Elongated	Mexican Sand	
079973	K-4636-47	Elongated	Almond	
115339	K-4636-58	Elongated	Thunder Grey	

*Vibrant Limited Lifetime Finish

www.waterconcepts.net • Serving our Customers Since 1946 • www.plumbsupply.com

Plastic Toilet Seats

Residential Plastic Elongated Toilet Seats (Continued)

Cachet® Quiet-Close™ Residential Closed Front Plastic Seat with Cover

Part #	Mfg #	Style	Color	Price
083221	K-4636-7	Elongated	Black Black	
094218	K-4636-95	Elongated	Ice Grey	
076740	K-4636-96	Elongated	Biscuit	
079971	K-4636-G9	Elongated	Sandbar	
148140	K-4636-NY	Elongated	Dune	
083597	K-4636-K4	Elongated	Cashmere	

French Curve® Grip-Tight Residential Seat

- Solid polypropylene plastic
- Quiet-Close™ lid and ring prevents slamming
- Quick-Release™ hinges for easy removal for cleaning
- Quick-Attach® hardware for fast and secure installation



Part #	Mfg #	Style	Color	Price
097440	K-4713-0	Elongated	White	
183071	K-4713-33	Elongated	Mexican Sand	
095008	K-4713-47	Elongated	Almond	
150689	K-4713-58	Elongated	Thunder Grey	
126694	K-4713-7	Elongated	Black	
153532	K-4713-95	Elongated	Ice Grey	
099814	K-4713-96	Elongated	Biscuit	
101628	K-4713-G9	Elongated	Sandbar	
120212	K-4713-K4	Elongated	Cashmere	

Glenbury™ Quiet-Close™ Residential Grip-Tight Closed Front Plastic Seat with Cover

- Solid polypropylene plastic resistant to staining, fading, chipping peeling
- Ergonomically contoured seat and cover
- Bumpers molded in, seat will not detach



Part #	Mfg #	Style	Color	Price
103463	K-4733-0	Elongated	White	
108851	K-4733-33	Elongated	Mexican Sand	
104660	K-4733-47	Elongated	Almond	
183073	K-4733-58	Elongated	Thunder Grey	
108853	K-4733-95	Elongated	Ice Grey	
104661	K-4733-96	Elongated	Biscuit	
107025	K-4733-G9	Elongated	Sandbar	
175694	K-4733-NY	Elongated	Dune	

Lustra™ Open Front Plastic Seat with Cover

- Color-matched plastic hinges
- Stainless-steel mounting bolts



Part #	Mfg #	Style	Color	Price
056626	K-4650-0	Elongated	White	
154989	K-4650-33	Elongated	Mexican Sand	
080331	K-4650-47	Elongated	Almond	
124756	K-4650-7	Elongated	Black	
145224	K-4650-95	Elongated	Ice Grey	
064152	K-4650-96	Elongated	Biscuit	

Lustra™ Open Front Plastic Seat with Cover and Anti-Microbial Agent

- Color-matched plastic hinges
- Stainless-steel mounting bolts
- Includes an antimicrobial agent



Part #	Mfg #	Style	Color	Price
182453	K-4650-A-0	Elongated	White	

Lustra™ with Quick-Release™ Hinges

- Sturdy, chip-resistant polypropylene
- Finish will not stain or peel



Part #	Mfg #	Style	Color	Price
053380	K-4652-0	Elongated	White	
058912	K-4652-33	Elongated	Mexican Sand	
054874	K-4652-47	Elongated	Almond	
063230	K-4652-58	Elongated	Thunder Grey	
055922	K-4652-7	Elongated	Black	
056934	K-4652-95	Elongated	Ice Grey	
053383	K-4652-96	Elongated	Biscuit	
056735	K-4652-G9	Elongated	Sandbar	
089948	K-4652-K4	Elongated	Cashmere	
167790	K-4652-NY	Elongated	Dune	
082843	K-4652-W2	Elongated	Earthen White	

*Vibrant Limited Lifetime Finish

www.plumbsupply.com • Serving our Customers Since 1946 • www.waterconcepts.net

Plastic Toilet Seats

Toilet Seats

Lustra™ with Quick-Release™ Hinges

- Sturdy, chip-resistant polypropylene
- Finish will not stain or peel
- Stainless steel support arms
- Anti-microbial agent



Part #	Mfg #	Style	Color	Price
066940	K-4652-A-0	Elongated	White	

Lustra™ Residential Open Front Extra Heavy Plastic Seat

- Extra-heavy solid polypropylene plastic with check hinge
- -C - Check hinge
- -SC - Self-sustaining check hinge
- Cover sold separately



Part #	Mfg #	Style	Color	Price
077940	K-4666-C-0	Elongated	White	
084236	K-4666-SC-0	Elongated	White	

Purefresh™ Elongated Toilet Seat

- Contoured seat for user comfort
- Deodorizing system
- Dual LED night light
- Battery operated (2 D)



Part #	Mfg #	Style	Color	Price
172614	K-5588-0	Elongated	White	
185475	K-5588-96	Elongated	Biscuit	
183389	K-7729-NA	Garden Waterfall Refill Scent for K-5588 or K-5589		
183390	K-7774-NA	Carbon Filter Refill		

Puretide™ Manual Cleansing Toilet Seat

- Single wand
- Side handle adjusts water spray position and pressure
- Quiet-Close™
- Quick-Release™ hinges
- Quick-Attach® hardware
- Grip-tight bumpers



Part #	Mfg #	Style	Color	Price
188675	K-5724-0	Elongated	White	

Reveal® Quiet-Close™ Toilet Seat with Grip-Tight

- Quiet-close™ lid and ring prevents slamming
- Quick-Release™ hinge caps snap open and seat pulls forward for removal
- Quick-Attach™ stainless steel fastener allows for top-mount screwdriver only installation
- Grip-Tight bumpers



Part #	Mfg #	Style	Color	Price
156172	K-4008-0	Elongated	White	
188622	K-4008-33	Elongated	Mexican Sand	
164439	K-4008-47	Elongated	Almond	
162486	K-4008-58	Elongated	Thunder Grey	
177806	K-4008-95	Elongated	Ice Grey	
162265	K-4008-96	Elongated	Biscuit	
162183	K-4008-G9	Elongated	Sandbar	
171302	K-4008-K4	Elongated	Cashmere	

Reveal® Nightlight Quiet-Close™ with Grip-Tight Toilet Seat

- Light intensity designed to provide enough light to see the toilet without disrupting nighttime vision
- Dual LED lighting includes guiding light when lid is down
- Illumination cycle with automatic 7-hour nightlight
- Up to 6 months of battery life (4) AA
- Quick-Release™ hinges
- Quick-Attach® hardware



Part #	Mfg #	Style	Color	Price
181506	K-75792-0	Elongated	White	
176506	K-75792-47	Elongated	Almond	
168104	K-75792-96	Elongated	Biscuit	

Saile® Quiet-Close™ Residential Closed Front Plastic Seat with Cover

- Slow-closing lid and ring
- Hydraulic slow-closing device
- Ergonomically contoured seat
- Solid polypropylene plastic
- Quick-release hinges



Part #	Mfg #	Style	Color	Price
119902	K-4748-0	Elongated	White	
134913	K-4748-96	Elongated	Biscuit	

*Vibrant Limited Lifetime Finish

www.waterconcepts.net • Serving our Customers Since 1946 • www.plumbsupply.com

Plastic Toilet Seats

Transitions® Nightlight Quiet-Close™ Toilet Seat with Grip-Tight

- Made of solid polypropylene
- Quiet-close child ring and adult ring
- Quick-release hinges



Part #	Mfg #	Style	Color	Price
182488	K-2599-0	Elongated	White	
103670	K-2599-47	Elongated	Almond	
095396	K-2599-96	Elongated	Biscuit	

Residential Plastic Round Toilet Seats

Brevia™ Toilet Seat with Quick-Release™ Hinges

- Quick-Attach™ hardware for a fast and secure installation
- Fits one- and two-piece toilets
- Polypropylene
- Contoured seat for user comfort



Part #	Mfg #	Style	Color	Price
141901	K-4775-0	Round	White	
142951	K-4775-47	Round	Almond	
150793	K-4775-7	Round	Black	
145422	K-4775-95	Round	Ice Grey	
142518	K-4775-96	Round	Biscuit	
144632	K-4775-G9	Round	Sandbar	
159949	K-4775-NY	Round	Dune	

Cachet® Residential Closed Front Seat with Cover

- Quiet-close™ lid
- Grip-Tight bumpers
- Quick-Attach™ system



Part #	Mfg #	Style	Color	Price
179654	K-7673-0	Round	White	

Cachet® Quiet-Close™ Toilet Seat with Grip-Tight

- Solid polypropylene plastic
- Contoured seat for user comfort
- Quick-Release™ hinges
- Fits one- and two-piece toilets
- Quick-Attach™ stainless steel fastener
- Slip resistant bumpers hold seat firmly in place



Part #	Mfg #	Style	Color	Price
077571	K-4639-0	Round	White	
098229	K-4639-33	Round	Mexican Sand	
092023	K-4639-47	Round	Almond	
087785	K-4639-7	Round	Black	
100748	K-4639-95	Round	Ice Grey	
079212	K-4639-96	Round	Biscuit	
087783	K-4639-G9	Round	Sandbar	
152705	K-4639-K4	Round	Cashmere	
175530	K-4639-NY	Round	Dune	

Cachet® Quiet-Close™ with Grip-Tight and Nightlight Technology

- Dual LED lighting includes guiding light when lid is down and task light when lid is lifted
- Illumination cycle with automatic 7-Hour nightlight
- Battery-operated - no cords required
- (4) AA batteries, not included



Part #	Mfg #	Style	Color	Price
181507	K-75758-0	Round	White	

French Curve® with Quick-Release™ Hinges

- Quick-Attach® hardware
- Color-matched plastic hinges



Part #	Mfg #	Style	Color	Price
062923	K-4663-0	Round	White	

*Vibrant Limited Lifetime Finish

www.plumbsupply.com • Serving our Customers Since 1946 • www.waterconcepts.net

Plastic Toilet Seats

Toilet Seats

Lustra® with Quick-Release™ Hinges

- Quick-Attach® hardware
- Color-matched plastic hinges



Part #	Mfg #	Style	Color	Price
061925	K-4662-7	Round	Black	
054754	K-4662-95	Round	Ice Grey	

Purefresh™ Quiet-Close™ Front Toilet Seat

- Neutralizes odors continuously for up to 6 months
- Integrated freshener fills air with a light
- 8-Hour dual LED nightlight
- Battery-operated
- Grip-Tight bumpers
- Quick-Attach® hardware



Part #	Mfg #	Style	Color	Price
173391	K-5589-0	Round	White	

Reveal® Quiet-Close™ with Grip-Tight

- Quick-Release™ hinges
- Quick-Attach® hardware
- Color-matched plastic hinges



Part #	Mfg #	Style	Color	Price
180562	K-4009-0	Round	White	
167738	K-4009-33	Round	Mexican Sand	
231641	K-4009-47	Round	Almond	
162687	K-4009-7	Round	Black	
183566	K-4009-96	Round	Biscuit	

Reveal® Nightlight Quiet-Close™ with Grip-Tight round-front Toilet Seat

- Dual LED lighting includes guiding light when lid is down and task light when lid is lifted
- Illumination cycle with automatic 7-Hour nightlight
- (4) AA batteries, not included



Part #	Mfg #	Style	Color	Price
171195	K-75793-0	Round	White	
188510	K-75793-96	Round	Biscuit	

Bidet Toilet Seats

C3®-125 Elongated Cleansing Bidet Toilet Seat

- Tank heater
- Automatic LED lighting
- Automatic deodorization function
- Warm-air drying system
- Quiet-Close™
- Quick-Release™ hinges
- Grip-Tight bumpers
- Front and rear wash modes
- Side seat controls for convenient access
- Adjustable water temperature and water pressure.
- Heated seat with adjustable temperature settings.



Part #	Mfg #	Style	Color	Price
132513	K-4737-0	Elongated	White	
132037	K-4737-96	Elongated	Biscuit	

C3®-200 Elongated Cleansing Bidet Toilet Seat

- In-line heater
- Automatic LED lighting
- Automatic deodorization function
- Warm-air drying system
- Quiet-Close™
- Quick-Release™ hinges
- Grip-Tight bumpers
- Front and rear wash modes
- Adjustable water temperature and water pressure.
- Remote control with 2 programmable user presets
- Heated seat with five temperature settings.



Part #	Mfg #	Style	Color	Price
098585	K-4709-0	Elongated	White	

*Vibrant Limited Lifetime Finish

www.waterconcepts.net • Serving our Customers Since 1946 • www.plumbsupply.com

Plastic Toilet Seats

C3® 230 Elongated Bidet Toilet Seat

- In-line heater provides continuously heated water for consistent comfort.
- Anterior and posterior nozzles provide warm, aerated water for cleansing.
- Adjustable water temperature and water pressure.
- Choose oscillating or pulsating spray.
- Touchscreen remote control with two programmable user presets.
- Stainless steel wand with UV-light self-sanitization.
- Heated seat with five temperature settings.
- LED lighting illuminates the bowl to serve as a night-light.
- Warm-air drying system with adjustable air speed and temperature.
- Carbon filter for odor control.
- Quiet-Close™ lid closes slowly and quietly without slamming.
- Quick-Release™ hinges allow seat to be unlatched from toilet for easy removal and convenient cleaning; no tools required.



Toilet Seats

Part #	Mfg #	Style	Color	Price
171896	K-4108-0	Elongated	White	

*Vibrant Limited Lifetime Finish

www.plumbsupply.com • Serving our Customers Since 1946 • www.waterconcepts.net

Plastic Toilet Seats

Toilet Seats

Residential Plastic Elongated Toilet Seats

170 Closed Front Plastic Seat with Cover

- Standard weight
- Molded-in bumpers
- Color-matched Top-Tite® hinges with non-corrosive top-tightening bolts and wing nuts
- Ring thickness is 3/8"
- Height of seat with cover is 1-1/2"



Part #	Mfg #	Style	Color	Price
107973	170-000	Elongated	White	

Affinity™ Whisper-Close™ Residential Closed Front Plastic Seat with Cover

- Heavyweight solid plastic
- Easy-Clean and Change™ hinge
- Precision Seat Fit™



Part #	Mfg #	Style	Color	Price
190402	1200E3	Elongated	White	
190403	1200E3-346	Elongated	Biscuit	
072189	1200E3-146	Elongated	Almond	
228208	1200E3-006	Elongated	Bone	
170419	1200SLOWT-174	Elongated	Blue Mist	
170420	1200SLOWT-343	Elongated	Raspberry	

1800EC Easy-Clean and Change™ Closed Front Plastic Seat

- Lifts off for easy cleaning - twist hinge to unlock
- Color-matched Easy-Clean & Change™ hinges with stainless steel pintles
- Lift-Off™ top-tightening bolts, wing nuts, and no-slip washers



Part #	Mfg #	Style	Color	Price
103929	1800EC-000	Elongated	White	
131238	1800EC-346	Elongated	Biscuit	
127467	1800EC-006	Elongated	Bone	

NextStep® Built-In Potty Seat™

- Whisper-Close™
- Easy Clean & Change™ Hinges
- STA-TITE® Seat Fastening System



Part #	Mfg #	Style	Color	Price
180489	1483SLOW	Elongated	White	
186531	1483SLOW-346	Elongated	Biscuit	

Residential Plastic Round Toilet Seats

Plastic Toilet Seat

- Easy Clean & Change®
- Non-corrosive bolts and wing nuts
- Closed front, includes cover



Part #	Mfg #	Style	Color	Price
002331	100EC	Round	Elongated	

Affinity™ Whisper-Close™ Residential Closed Front Plastic Seat with Cover

- Heavy-weight solid plastic
- Easy-Clean and Change™ hinge



Part #	Mfg #	Style	Color	Price
190418	200E3	Round	White	
190419	200E3-346	Round	Biscuit	

800EC Easy-Clean and Change™ Closed Front Plastic Seat

- Lifts off for easy cleaning - twist hinge to unlock
- Color-matched Easy-Clean & Change™ hinges with stainless steel pintles
- Lift-Off™ top-tightening bolts, wing nuts, and no-slip washers



Part #	Mfg #	Style	Color	Price
105555	800EC-000	Round	White	
002391	800EC-006	Round	Bone	

Plastic Toilet Seats

200TCA Closed Front Plastic Seat with Cover

- Heavy-weight and injection molded of solid plastic
- Features large molded-in bumpers
- Color-matched Top-Tite® hinges
- Closed front, includes cover
- Non-corrosive top-tightening bolts and wing nuts



Part #	Mfg #	Style	Color	Price
002365	200TCA	Round	White	

NextStep® Built-In Potty Seat™

- Whisper-Close™
- Easy Clean & Change™ Hinges
- STA-TITE® Seat Fastening System



Part #	Mfg #	Style	Color	Price
139587	483SLOW	Round	White	

Plastic Toilet Seats

Toilet Seats

Residential Plastic Toilet Seats

130EC Residential Closed Front Plastic Seat

- Easy•Clean & Change®
- Non-Corrosive Hardware



Part #	Mfg #	Style	Color	Price
193204	130EC	Elongated	White	
194128	130EC	Elongated	Biscuit	
193514	130EC	Elongated	Bone	

300SLOWT Residential Closed Front Plastic Seat

- Closed front with cover, round, injection molded solid plastic toilet seat.
- Features four molded-in bumpers, color-matched Whisper•Close®
- Easy•Clean & Change® hinges with STA-TITE® Seat Fastening System



Part #	Mfg #	Style	Color	Price
228420	300E3	Round	White	
228426	300E3BN	Round	Bone	

380SLOWT Residential Closed Front Plastic Seat

- Closed front with cover, elongated, injection molded solid plastic toilet seat.
- Features four molded-in bumpers, color-matched Whisper•Close®
- Easy•Clean & Change® hinges with STA-TITE® Seat Fastening System™.



Part #	Mfg #	Style	Color	Price
227771	380E3	Elongated	White	
228429	380E3BI	Elongated	Biscuit	

380TCA Residential Closed Front Plastic Seat

- Top-Tite® Hinges
- Non-Corrosive Hex-Tite™ Bolts and Wing Nuts



Part #	Mfg #	Style	Color	Price
203128	380TCA	Elongated	White	

3EC Residential Closed Front Plastic Seat

- Easy•Clean & Change®
- Non-Corrosive Hardware



Part #	Mfg #	Style	Color	Price
193513	3EC	Round	White	

Wood Toilet Seats

Residential Elongated Wood Toilet Seats

Avantis® Quiet-Close™ with Grip-Tight

- Quick-Release™ brushed nickel hinges
- Solid wood



Part #	Mfg #	Style	Color	Price
183074	K-4761-BN-LAW	Elongated	Antique Walnut	

Kathryn® Elongated Seat

- Molded wood
- Exclusive seat for Kathryn K-3324 and K-4384 toilets
- -AF: Vibrant® french gold hinges
- -BN: Vibrant brushed nickel hinges
- -CP: polished chrome hinges



Part #	Mfg #	Style	Color	Price
179900	K-4701-AF-0	Elongated	White	
086170	K-4701-BN-0	Elongated	White	
182861	K-4701-CP-96	Elongated	Biscuit	

Ridgewood® Elongated Seat

- Made of compression molded wood
- Color matched polypropylene hinges



Part #	Mfg #	Style	Color	Price
111833	K-4694-0	Elongated	White	
131669	K-4694-96	Elongated	Biscuit	

Stonewood® Elongated Seat

- Made of compression molded wood
- Color matched plastic hinges



Part #	Mfg #	Style	Color	Price
108295	K-4647-0	Elongated	White	
099425	K-4647-47	Elongated	Almond	
108297	K-4647-96	Elongated	Biscuit	

Stonewood® Seat with Quick-Release Hinges

- Made of compression molded wood
- Quick-Attach® hardware



Part #	Mfg #	Style	Color	Price
183575	K-4814-0	Elongated	White	
156590	K-4814-47	Elongated	Almond	
189568	K-4814-96	Elongated	Biscuit	

Triko™ Elongated Seat with Chrome Hinges

- Molded wood



Part #	Mfg #	Style	Color	Price
127805	K-4722-T-0	Elongated	White	
156595	K-4722-T-47	Elongated	Almond	

Triko™ Elongated Seat

- Molded wood
- Color-matched plastic hinges



Part #	Mfg #	Style	Color	Price
053398	K-4712-T-0	Elongated	White	
111145	K-4712-T-33	Elongated	Mexican Sand	
053399	K-4712-T-47	Elongated	Almond	
104445	K-4712-T-95	Elongated	Ice Grey	
053400	K-4712-T-96	Elongated	Biscuit	
057599	K-4712-T-G9	Elongated	Sandbar	
182862	K-4712-T-K4	Elongated	Cashmere	

Residential Round Wood Toilet Seats

Ridgewood® Round Seat

- Compression molded wood
- Color matched plastic hinges



Part #	Mfg #	Style	Color	Price
166551	K-4695-47	Round	Almond	

*Vibrant Limited Lifetime Finish

www.plumbsupply.com • Serving our Customers Since 1946 • www.waterconcepts.net

Wood Toilet Seats

Toilet Seats

Stonewood® Round Seat

- Compression molded wood
- Color matched polypropylene hinges



Part #	Mfg #	Style	Color	Price
108298	K-4648-0	Round	White	
109682	K-4648-47	Round	Almond	
108299	K-4648-96	Round	Biscuit	

Stonewood® Toilet Seat with Quick-Release™ Color Matched Plastic Hinges

- Compression molded wood
- Quick-Attach® hardware



Part #	Mfg #	Style	Color	Price
157867	K-4816-0	Round	White	
222985	K-4816-47	Round	Almond	

Triko™ Round Seat

- Hardwood fibers molded with phenolic resins
- Durable baked enamel finish
- Plastic hinges



Part #	Mfg #	Style	Color	Price
053394	K-4716-T-0	Round	White	
057988	K-4716-T-33	Round	Mexican Sand	
053395	K-4716-T-47	Round	Almond	
058719	K-4716-T-95	Round	Ice Grey	
053396	K-4716-T-96	Round	Biscuit	
182863	K-4716-T-K4	Round	Cashmere	

Triko™ Round Seat with Chrome Hinges

- Molded wood
- Polished Chrome Hinges



Part #	Mfg #	Style	Color	Price
156594	K-4726-T-47	Round	Almond	

*Vibrant Limited Lifetime Finish

www.waterconcepts.net • Serving our Customers Since 1946 • www.plumbsupply.com

Wood Elongated Toilet Seats

Residential Wood Elongated Toilet Seats

1400 Molded Wood Toilet Seat

- Top-Tite® Hinges
- Non-Corrosive Hex-Tite™ bolts and wing nuts



Part #	Mfg #	Style	Color	Price
053633	1400TTA	Elongated	White	

1500EC Easy-Clean and Change™ Closed Front Molded Wood Seat

- Lifts off for easy cleaning - twist hinge to unlock
- Color-matched Easy-Clean & Change™ bumpers and hinges
- Lift-Off™ top-tightening bolts, wing nuts, and no-slip washers



Part #	Mfg #	Style	Color	Price
102035	1500EC	Elongated	White	
098010	1500EC-006	Elongated	Bone	
098014	1500EC-146	Elongated	Almond	
100455	1500EC-346	Elongated	Biscuit	

1600E2 Easy-Clean and Change™ Closed Front Molded Wood Seat with Cover

- Molded wood with multi-coat enamel finish
- Color-matched bumpers
- Whisper-Close® lid
- Easy-Clean & Change™ hinges
- Non-corrosive, top-tightening bolts and wing nuts



Part #	Mfg #	Style	Color	Price
101794	1600E3	Elongated	White	
145184	1600E3-346	Elongated	Biscuit	

1550PRO Proline™/Proseat™ Toilet Seat

- Open front with cover
- Plastic Top-Tite® hinges
- Non-Corrosive Hex-Tite™ bolts and wing nuts



Part #	Mfg #	Style	Color	Price
067665	1550PRO	Elongated	White	

High Density™ Whisper Close® Molded Wood Seat

- Whisper Close™
- Easy Clean & Change®
- STA-TITE® Seat Fastening System



Part #	Mfg #	Style	Color	Price
138297	19170CHSL	Elongated	White	

Residential Wood Round Toilet Seats

500EC Easy-Clean and Change™ Closed Front Molded Wood Seat

- Lifts off for easy cleaning - twist hinge to unlock
- Color-matched Easy Clean & Change™ bumpers and hinges
- Lift-Off™ top-tightening bolts, wing nuts, and no-slip washers



Part #	Mfg #	Style	Color	Price
102033	500EC	Round	White	
100501	500EC-006	Round	Bone	
100223	500EC-146	Round	Almond	
100454	500EC-346	Round	Biscuit	

Wood Elongated Toilet Seats

Toilet Seats

600E2 Closed Front Molded Wood Seat with Cover

- Molded wood with multi-coat enamel finish
- Color-matched bumpers
- Whisper-Close® lid
- Easy-Clean & Change™ hinges
- Non-corrosive, top-tightening bolts and wing nuts



Part #	Mfg #	Style	Color	Price
101796	600E3-000	Round	White	
172118	600E3-346	Round	Biscuit	

High Density™ Whisper Close® Molded Wood Seat

- Whisper Close™
- Easy Clean & Change®
- STA-TITE® Seat Fastening System



Part #	Mfg #	Style	Color	Price
179647	9170CHSL	Round	White	

Wood Toilet Seats

Residential Molded Wood Toilet Seats

540EC Residential Closed Front Molded Wood Seat

- Easy•Clean & Change®
- Non-Corrosive Hardware



Part #	Mfg #	Style	Color	Price
198066	540EC-000	Round	White	
198067	540EC-006	Round	Bone	
198068	540EC-346	Round	Biscuit	

540TTT Residential Closed Front Molded Wood Seat

- Non-Corrosive Hardware
- STA-TITE® Residential Fastening System™
- Adjustable Hinges



Part #	Mfg #	Style	Color	Price
212112	540TTT	Round	White	

585EC Residential Closed Front Molded Wood Seat

- Easy•Clean & Change®
- Non-Corrosive Hardware



Part #	Mfg #	Style	Color	Price
198069	585EC-000	Elongated	White	
198070	585EC-006	Elongated	Bone	
198071	585EC-346	Elongated	Biscuit	
213254	585EC-464	Elongated	Dresden Blue	

585TTT Residential Closed Front Molded Wood Seat

- Non-Corrosive Hardware
- STA-TITE® Residential Fastening System™
- Adjustable Hinges



Part #	Mfg #	Style	Color	Price
212111	585TTT	Elongated	White	

640E3 Residential Closed Front Molded Wood Seat

- Easy•Clean & Change®
- Whisper•Close®
- STA-TITE® Residential Fastening System™
- Adjustable Hinges



Part #	Mfg #	Style	Color	Price
202864	640E3-000	Round	White	

685E3 Residential Closed Front Molded Wood Seat

- Easy•Clean & Change®
- Whisper•Close®
- STA-TITE® Residential Fastening System™
- Adjustable Hinges



Part #	Mfg #	Style	Color	Price
205557	685E3-000	Elongated	White	
203428	685E3-346	Elongated	Biscuit	

NW209E10 Residential Closed Front Molded Wood Seat

- Adjustable Hinges
- Non-Corrosive Hardware
- Fits American Standard Norwall bowls



Part #	Mfg #	Style	Color	Price
209049	NW209E10-000	Round	White	



Wood Toilet Seats

1683SLOW Residential Nextstep® Closed Front Molded Wood Seat

- Oversized for Comfort
- Whisper•Close®
- STA-TITE® Residential Fastening System™
- Plastic Child Seat Secures Magnetically Into Cover When Not In Use
- Easy•Clean & Change®



Toilet Seats

Part #	Mfg #	Style	Color	Price
205113	1683SLOW	Toddler/Baby	White	

Drill Bits

Shockwave® Driver Bit Sets

Shockwave™ 12PC Impact Drive Guide Set

- **OPTIMIZED SHOCKZONE™** absorbs peak torque and prevents breaking
- **CUSTOM ALLOY76™ STEEL** maximizes resistance to wear and shock
- Expandable sleeve for fast, straight driving
- Functional storage case can be used to gauge, strip, and bend wire, as well as fasten screws
- Includes:
 - (1) ECX™ Bit 1" #1
 - (1) ECX™ Bit 1" #2
 - (2) Phillips Bit 1" P2
 - (1) Phillips Bit 1" P3
 - (1) Slotted Bit 1" SL 1/4"
 - (1) Slotted Bit 1" SL 3/16"
 - (1) Square Bit 1" SQ2
 - (1) TORX® Bit 1" T15
 - (1) TORX® Bit 1" T20
 - (1) TORX® Bit 1" T25
 - (1) SHOCKWAVE™ 3 Magnetic bit tip holder



18PC Shockwave™ Driver Bit Set

- Geometric design provides the shock absorption
- Proprietary steel and heat treated process for maximum strength and durability
- Forged tips for maximum grip
- Includes:
 - (1) Phillips bit 1" P1
 - (1) Phillips bit 1" P2
 - (1) Phillips bit 1" P3
 - (1) Slotted bit 1" SL 1/4"
 - (1) Slotted bit 1" SL 3/16"
 - (1) Square bit 1" SQ1
 - (1) Square bit 1" SQ2
 - (2) Phillips bit 2" P2
 - (1) Phillips bit 2" P3
 - (2) Square bit 2" SQ2
 - (1) Square bit 2" SQ3
 - (1) TORX® 2" T15
 - (1) TORX® bit 2" T20
 - (1) 3 1/2" Phillips #2
 - (1) 3 1/2" Square drive #2
 - (1) Case with bulk storage container
 - (1) SHOCKWAVE™ magnetic bit holder



Part #	Mfg #	Description	Price
164158	48-32-4507	Shockwave™ 12PC Impact Drive Guide Set	

Part #	Mfg #	Description	Price
161626	48-32-4403	18PC Shockwave Driver Bit Set	

Drill Bits

26-Piece Shockwave™ Drive and Fasten Set

- Forged tips for maximum grip
- Proprietary steel and heat treat process for maximum strength and durability
- Includes:
 - Phillips bits:
 - 1"-(1) P1, (1) P2, (3) P3
 - 2"-(1) P2
 - Square bits:
 - 1"-(1) SQ1, (2) SQ2, (1) SQ3
 - 2"-(1) SQ2
 - Torx® bits:
 - 1"-(2) T20, (2) T25, (1) T30
 - 2"-(1) T20, (1) T25
 - 1/4" Hex to 3/8" square adapter (1)
 - 1/4" Magnetic nut driver (1)
 - Slotted bit 1" SL 3/16" (1)
 - Drive Sockets:
 - (1)3/8" Drive: 1/2" Socket,
 - (1)3/8" Drive: 9/16" Socket
 - Magnetic nut drivers:
 - (1)3/8" Magnetic nut driver,
 - (1)5/16" Magnetic nut driver
 - (1) Shockwave™ compact magnetic bit holder



Part #	Mfg #	Description	Price
173708	48-32-4408	26-Pc Shockwave Drive and Fasten Set	

29-Piece Shockwave® Impact Duty™ Driver Bit Set

- Diameter: 1/4"
- Forged tip
- Includes:
 - Phillips bits:
 - 1" - (1) P1, (7) P2, (2) P3;
 - 2" Power - (2) P2, (1) P3
 - Square bits:
 - 1" - (1) SQ1, (4) SQ2, (1) SQ3
 - 2" Power - (2) SQ2
 - Torx® bits:
 - 1" - (1) T15, (1) T20, (1) T25
 - Magnetic nut drivers: (1) 1/4" red, (1) 5/16" amber, (1) 3/8" blue
 - (1) Magnetic bit holder
 - (1) Case with bulk storage container



Part #	Mfg #	Description	Price
137578	48-32-4401	29-Pc Shockwave Driver Bit Set	

32-Piece Shockwave™ Driver Bit Set

- Forged tips for maximum grip
- Geometric design provides the shock absorption
- Includes:
 - Magnetic nut driver:
 - (1) 1/4", (1) 5/16"
 - Phillips bits:
 - 1" (1) P1, (4) P2, (1) P3
 - 2" (2) P2
 - Phillips reduced 1" PR2 bit
 - Slotted:
 - 1" (1) #8, (1) #10
 - 2" (1) #10
 - Square bits:
 - 1" (1) SQ1, (3) SQ2, (1) SQ3
 - 2" (1) SQ2
 - Torx® bits:
 - 1" (1) T15, (2) T20, (2) T25, (1) T30
 - 2" (1) T20, (1) T25



Part #	Mfg #	Description	Price
173709	48-32-4004	32-Pc Shockwave Driver Bit Set	

35-Piece Shockwave® Impact Duty™ Driver Bit Set

- Forged tip
- Includes:
 - ECX™: 1" - (1) ECX1, (1) ECX2
 - Phillips bits:
 - 1" (1) Ps, (2) P2, (1) P3;
 - 2" Power: (1) P1, (1) P2
 - 3-1/2" Power: (1) P2
 - Square bits:
 - 1" (1) SQ1, (2) SQ2, (1) SQ3
 - 2" Power: (1) SQ1, (1) SQ2, (1) SQ3
 - 3-1/2" Power: (1) SQ2
 - Torx® bits:
 - 2" Power: (1) T15, (1) T20, (1) T25, (1) T30
 - Slotted bits:
 - 2" Power: (1) SL 1/8", (1) SL 3/16", (1) SL 1/4"
 - Magnetic nut drivers: (1) 1/4" red, (1) 5/16" amber, (1) 3/8" blue
 - Hex Shank Drill Bits:
 - 1/4" (1) 1/8", (1) 5/32", (1) 3/16", (1) 7/32", (1) 1/4"
 - Socket adapters: (1) 1/4" hex shank to 3/8" square
 - (1) 1/4" hex shank to 1/2" square
 - (1) Magnetic bit holder
 - (1) Case with bulk storage container



Part #	Mfg #	Description	Price
140584	48-32-4402	M/E Drill & Drive Set 35-Pc	

Drill Bits

36-Piece Shockwave™ Driver Bit Set

- Geometric design provides the shock absorption
- Forged tips for maximum grip
- Includes:
 - (1) 1/4" Insert magnetic nut driver
 - (1) 3/8" Socket adapter
 - (1) 5/16" Insert magnetic nut driver
 - (1) Shockwave™ 6" Magnetic bit tip holder
 - (1) Shockwave™ Compact magnetic bit holder
 - Hex bits:
 - 1" (1) 1/4", (1) 1/8", (1) 3/16", (1) 3/32", (1) 5/32", (1) 5/64", (1) 7/64", (1) 9/64"
 - Phillips bits:
 - 1" (1) P1, (3) P2, (1) P3
 - (1) Phillips reduced 1" PR2 bit
 - Slotted bits:
 - 1" (2) #10, (1) #12, (1) #8
 - Square bits:
 - 1" (1) SQ1, (1) SQ3
 - Torx® bits:
 - 1" (1) T10, (1) T15, (2) T20, (2) T25, (1) T27, (1) T30, (1) T40



Part #	Mfg #	Description	Price
173710	48-32-4005	36-Pc Shockwave Driver Bit Set	

40PC Shockwave™ Drill & Drive Set

- Geometric design provides the shock absorption
- Forged tips for maximum grip
- Includes:
 - (1) 1/2" Socket adapter
 - (1) 1/4" Magnetic nut driver
 - (1) 1/4" Shockwave Hex drive bit
 - (1) 1/8" Drill bit
 - (1) 3/16" Shockwave Hex drive bit
 - (1) 3/8" Magnetic nut driver
 - (1) 3/8" Socket adapter
 - (1) 5/16" Magnetic nut driver
 - (1) Shockwave™ Compact magnetic bit holder
 - Hex bits:
 - 1" (1) 1/4", (1) 1/8", (1) 3/16", (1) 5/32"
 - Phillips bits:
 - 1" (1) P1, (2) P2, (1) P3
 - 2" (4) P2, (1) P3
 - (1) Phillips reduced 1" PR2 bit
 - Slotted bits:
 - 1" (1) #10, (1) #8
 - 2" (1) #10
 - Square bits:
 - 1" (1) SQ1, (2) SQ2, (1) SQ3
 - 2" (1) SQ2, (1) SQ3
 - TORX® BITS:
 - 1" (1) T15, (1) T20, (2) T25
 - 2" (1) T20, (2) T25



Part #	Mfg #	Description	Price
173711	48-32-4006	40-Pc Shockwave Driver Bit Set	

SHOCKWAVE™ Impact Hex Drill Bit

- Extreme durability: Thicker web provides greater strength and longer life
- Fast, accurate drilling: 135° split point tip starts on contact to prevent walking, while the parabolic flute clears chips fast
- Corrosion resistant: Black Oxide coating provides lubricity and resists corrosion of the bit
- Reduced down time: 1/4" Hex power groove shank offers quick bit changes



Part #	Mfg #	Description	Price
164178	48-89-4401	1/16" SHOCKWAVE™ Impact Hex Drill Bit	
164187	48-89-4403	3/32" SHOCKWAVE™ Impact Hex Drill Bit	
164179	48-89-4405	1/8" SHOCKWAVE™ Impact Hex Drill Bit	
164188	48-89-4406	9/64" SHOCKWAVE™ Impact Hex Drill Bit	

Drill Bits

Shockwave® Driver Bit Sets (Continued)

SHOCKWAVE™ Impact Hex Drill Bit

Part #	Mfg #	Description	Price
164180	48-89-4407	5/32" SHOCKWAVE™ Impact Hex Drill Bit	
164181	48-89-4409	3/16" SHOCKWAVE™ Impact Hex Drill Bit	
164182	48-89-4411	7/32" SHOCKWAVE™ Impact Hex Drill Bit	
164183	48-89-4413	1/4" SHOCKWAVE™ Impact Hex Drill Bit	
164184	48-89-4414	5/16" SHOCKWAVE™ Impact Hex Drill Bit	
164185	48-89-4415	3/8" SHOCKWAVE™ Impact Hex Drill Bit	
164186	48-89-4417	1/2" SHOCKWAVE™ Impact Hex Drill Bit	

Thunderbolt® Bits

Thunderbolt® Drill Bit Set



Part #	Mfg #	Description	Price
137838	48-89-2803	15-Pc Black Oxide Bit Set	
154239	48-89-2801	21-Pc Black Oxide Bit Set	

Thunderbolt® Black Oxide Drill Bit

- Thunderbolt® web provides longer life and faster drill times 
- Parabolic flute clears chips faster
- 135° Split point, precision start no walking

Part #	Mfg #	Diameter	Price
137807	48-89-2710	1/16"	
137808	48-89-2711	5/64"	
137809	48-89-2712	3/32"	
137810	48-89-2713	7/64"	
137812	48-89-2714	1/8"	
137813	48-89-2715	9/64"	
137815	48-89-2716	5/32"	
137816	48-89-2717	11/64"	
137817	48-89-2718	3/16"	
137818	48-89-2719	13/64"	
137819	48-89-2720	7/32"	

Thunderbolt® Bits (Continued)

Thunderbolt® Black Oxide Drill Bit

Part #	Mfg #	Diameter	Price
137820	48-89-2721	15/64"	
137821	48-89-2722	1/4"	
137822	48-89-2723	17/64"	
137823	48-89-2724	9/32"	
137824	48-89-2725	19/64"	
137825	48-89-2726	5/16"	
137826	48-89-2727	21/64"	
137827	48-89-2728	11/32"	
137828	48-89-2729	23/64"	
137829	48-89-2730	3/8"	
137830	48-89-2731	25/64"	
137831	48-89-2732	13/32"	
137832	48-89-2733	27/64"	
137833	48-89-2734	7/16"	
137834	48-89-2735	29/64"	
137835	48-89-2736	15/32"	
137836	48-89-2737	31/64"	
137837	48-89-2738	1/2"	

Thunderbolt® Aircraft Length Black Oxide Drill Bit

- Thunderbolt® web provides longer life and faster drill times 
- Parabolic flute clears chips faster
- 135° Split point, precision start no walking

Part #	Mfg #	Diameter	Price
138278	48-89-2772	1/4" x 12"	

Flat Boring Bits & Accessories

Flat Boring Bit

- Fluted bit clears chips 
- Bores cleaner and faster
- Furnished with hole for use in wire pulling
- Flats for secure chuck grip
- Precision made of high carbon steel for durability and long life

Part #	Mfg #	Shank Dia	Overall Length	Price
006918	48-27-0371	3/8" x 6"	Flat Boring Bit	
170327	48-27-0621	5/8" x 6"	Flat Boring Bit	
170328	48-27-1121	1-1/8" x 6"	Flat Boring Bit	
170329	48-27-1251	1-1/4" x 6"	Flat Boring Bit	
170330	48-27-1371	1-3/8" x 6"	Flat Boring Bit	
170331	48-27-1501	1-1/2" x 6"	Flat Boring Bit	

Drill Bits

Flat Boring Bit Sets

8-Piece Universal Quik-Lok™ Flat Boring Bit Set

- Includes the Universal Quik-Lok™
- Double wing spurs
- 1/4" Quick change hex shank



Part #	Mfg #	Description	Price
137800	49-22-0175	8-Pc Flat Boring Bit Set with 6" Extension	

Flat Boring Bit Kit

- Contains (6) popular size flat boring bits in heavy protective plastic
- In pockets for orderly storage and easy size selection



Part #	Mfg #	Sizes Include:	Price
006980	49-22-0071	3/8", 1/2", 5/8", 3/4", 7/8" & 1"	

Speed Feed Wood Bit

- Efficient: up to 10x faster drilling than flat boring bits
- Fast chip removal: nonstick, polished and coated flutes eliminate costly cleaning time
- Clean holes: double wing spurs permit cleaner hole cutting
- Versatile: 1/4" power groove shank fits all 1/4" extensions



Part #	Mfg #	Description	Price
170321	48-13-0048	1/2" x 6" Speed Feed Wood Bit	
170322	48-13-0058	5/8" x 6" Speed Feed Wood Bit	
170323	48-13-0068	3/4" x 6" Speed Feed Wood Bit	
170324	48-13-0078	7/8" x 6" Speed Feed Wood Bit	
170325	48-13-0088	1" x 6" Speed Feed Wood Bit	
170326	48-13-0108	1-1/4" x 6" Speed Feed Wood Bit	

Bit Kits

Contractors' Bit Kit

- Assortment of self-feed bits for big hole drilling
- Includes impact resistant carrying case



Part #	Mfg #	Description	Price
006982	49-22-0135	1-3/8", 1-1/2", 2-1/8", 2-9/16"	

Plumbers' Bit Kit

- Complete assortment of the most commonly used Milwaukee® bits for big hole drilling
- Includes 5-1/2" 1-piece shank and coupling extension and carrying case
- Includes:
 - Self-feed bits: 1-3/4", 2-1/8" & 2-9/16"
 - Auger bits: 7/8", 1-1/8", 1-1/4" & 1-1/2"



Part #	Mfg #	Sizes Include:	Price
140832	49-22-0065	7/8", 1-1/8", 1-1/4", 1-1/2" Auger Bits & 1-3/4", 2-1/8" & 2-9/16" Dia Self-feed Bits	

Drill Accessories

Bellhanger Bit

- Aggressive tip geometry for faster drilling
- Coated flutes for fast chip removal
- Wire pulling hole
- 3-Flat shank



Part #	Mfg #	Dia	OAL	Price
138408	48-13-7125	1/4"	12"	
140014	48-13-7225	1/4"	18"	
138666	48-13-7325	1/4"	24"	
153612	48-13-7337	3/8"	24"	

Hole Saw Accessories

Rotary Hammer Bit

- SDS Shank



Part #	Mfg #	Size	Price
137647	48-20-7410	3/16" x 2" x 4"	
137648	48-20-7411	3/16" x 4" x 6"	
137649	48-20-7430	1/4" x 2" x 4"	
137650	48-20-7431	1/4" x 4" x 6"	
137651	48-20-7441	5/16" x 4" x 6"	
137652	48-20-7451	3/8" x 4" x 6"	

Drill Bits

Hole Saw Accessories (Continued)

Rotary Hammer Bit

Part #	Mfg #	Size	Price
137653	48-20-7471	1/2" x 4" x 6"	

Selffeed Bit

- *Faster, more accurate drilling: Center feed screw pilots the bit and allows the bit to pull through fast*
- *Clean holes: Inside cutting plane shaves the hole radius for clean, smooth holes without pressure*
- *Long-lasting performance: Bits are resharpenable and include two removable, replaceable feed screws*



Part #	Mfg #	Description	Price
169683	48-25-1502	Selffeed Bit 1-1/2"	
169684	48-25-2122	Selffeed Bit 2-1/8"	

For 1/2" D-Handle & Larger Model Drill



Part #	Mfg #	Dia	Shank Type	Price
006907	48-25-1371	1-3/8"	7/16" Hex	
006911	48-25-2121	2-1/8"	7/16" Hex	

For 1/2" D-Handle & Larger Model Drill Except 1001-1 & 1007-1

Part #	Mfg #	Dia	Shank Type	Price
006912	48-25-2561	2-9/16"	7/16" Hex	

Switchblade™ 5-Piece Plumbers' Kit

- *Aggressive feed screw design*
- *Blades made with hardened steel*
- *Size and model number engraved on each bit*
- *Includes:*
 - (4) Switchblade™ self-feed bit blades - 1-3/8", 1-1/2", 2-1/8" and 2-9/16"
 - (1) Universal Quik-Lok® extension - 5-1/2" x 7/16"
 - (1) Each replacement blades - 1-3/8", 1-1/2", 2-1/8", and 2-9/16"
 - (4) Feed screws
 - (4) Set screws
 - (1) Hex wrench
 - Removable storage case
 - Compact carrying case with handle



Part #	Mfg #	Description	Price
149390	49-22-5100	5-Pc Switchblade Plumbers Kit	

Replacement Feed Screw Kit

- *For Switchblade™ selffeed bits*
- *Up to 2-9/16"*
- *Faster, more accurate drilling*



Part #	Mfg #	Description	Price
150897	48255275	Replacement Feed Screw Kit	

Step Drill Bits

Step Drill Bit, Single Hole

- *JAM-FREE performance: Dual-flute design provides greater speed and control*
- *Up to 2X faster*
- *Rapid Strike™ Tip: creates fast, accurate starts and generates less heat*
- *Up to 4X longer bit life*
- *Up to 50% more holes per battery charge*
- *Laser-engraved reference marks*
- *3-Flat Secure-Grip™ shanks*



Part #	Mfg #	Description	Price
169382	48-89-9207	#7 Step Drill Bit, 7/8" Single Hole	

Drill Bits

High Speed Steel Step Drill Bit

- *Jam-Free performance: Dual flute design provides greater speed and control*
- *Up to 2X faster: Optimized for cordless drills in high speed*
- *Rapid Strike™ Tip: Creates fast, accurate starts and generates less heat*
- *Up to 4X longer bit life: Optimized geometry with Black Oxide coating to cut faster and produce less heat*
- *Up to 50% more holes per battery charge: Greater user productivity*
- *Laser-engraved reference marks: Easily stop on any hole size*
- *3-Flat Secure-Grip™ shanks: Reduces bit slippage in the chuck*



Part #	Mfg #	Size	# of Holes	Price
140835	48-89-8960	1/4" x 1-3/8" x 1/8"	10	
169191	48-89-9201	#1 Step Drill Bit, 1/8" - 1/2" by 1/32"		
169381	48-89-9202	#2 Step Drill Bit, 3/16" - 1/2" by 1/16"		
169186	48-89-9203	#3 Step Drill Bit, 1/4" - 3/4" by 1/16"		
169187	48-89-9204	#4 Step Drill Bit, 3/16" - 7/8" by 1/16"		
169188	48-89-9206	#6 Step Drill Bi, 3/8" & 1/2" by 1/16"		
169189	48-89-9208	#8 Step Drill Bit, 1/2" - 1" by 1/16"		
169190	48-89-9209	#9 Step Drill Bit, 7/8" & 1-1/8"		
169383	48-89-9211	#11 Step Drill Bit, 7/8" - 1-7/32"		
169384	48-89-9212	#12 Step Drill Bit, 7/8" - 1-3/8"		

2-Piece Step Drill Bit Set

- *Includes:*
 - (1) 13-Hole bit (48-89-9100)
 - (1) 9-Hole bit (48-89-9105)



Part #	Mfg #	Description	Price
145131	48-89-9050	2-Pc Step Drill Bit Set	

3-Piece Step Drill Bit Set

- *Includes:*
 - (1) 6-Hole bit (48-89-8955)
 - (1) 9-Hole bit (48-89-9105)
 - (1) 13-Hole bit (48-89-9100)



Part #	Mfg #	Description	Price
145130	48-89-8990	3-Pc Step Drill Bit Set	

SDS Bits and Accessories

SDS-Max Bit

- *SDS-Max shank*
- *4-Cutter head*
- *Highest quality carbide maximizes material pulverization*
- *Optimized flutes provide fastest debris extraction for faster drilling*



Part #	Mfg #	Description	Price
154017	48-20-3918	SDS-Max Bit 5/8" x 21"	

SDS-Plus 2CT Bit

- *Enhanced rebar guards provide increased durability*
- *Breaker points lead to faster drilling speeds*
- *Variable flute for 20% more holes per charge*
- *Centering tip for exact spot drilling*
- *Wear mark indicators to show end of life and when bit no longer meets ANSI requirement*
- *Reinforced flutes for minimized vibration and maximum durability*



Part #	Mfg #	Description	Price
170315	48-20-7432	SDS-Plus 2CT 1/4" x 6" x 8"	
170316	48-20-7452	SDS-Plus 2CT 3/8" x 6" x 8"	
167611	48-20-7459	SDS-Plus 2CT 3/8" x 22" x 24"	
170317	48-20-7474	SDS-Plus 2CT 1/2" x 10" x 12"	
170318	48-20-7481	SDS-Plus 2CT 9/16" x 4" x 6"	
170319	48-20-7601	SDS-Plus 2CT 5/8" x 4" x 6"	
170320	48-20-7604	SDS-Plus 2CT 5/8" x 10" x 12"	
170314	48-20-7065	SDS-Plus 2CT 3/4" x 10" x 12"	

Tools

Drill Bits

SDS-Plus 4CT MX4™ Bit

- Enhanced rebar guards provide increased durability
- Breaker points lead to faster drilling speeds
- Variable flute for up to 20% more holes per charge in rotary hammers
- Centering tip for exact spot drilling
- Wear mark indicators to show end of life and when bit no longer meets the ANSI requirement
- Reinforced flutes for minimized vibration and maximum durability



Part #	Mfg #	Description	Price
152697	48-20-7206	SDS-Plus 4CT MX4™ 5/8" x 16" x 18"	

SDS Bit Assortment

- Includes:
 - 3/16" x 4-1/2"
 - 1/4" x 6"
 - 5/16" x 6"
 - 3/8" x 6"
 - 1/2" x 6"
- SDS Shank
- Carbide



Part #	Mfg #	Description	Price
137655	48-20-7490	5-Pc SDS Bit Set	

SDS Bit - 44 Magnum™ Series

- 4-Fluted spiral shaft



Part #	Mfg #	Bit Dia	Overall Length	Drilling Depth	Price
137646	48-20-7401	5/32"	4"	6"	
137657	48-20-7602	5/8"	6"	8"	

SDS Bit with 1/4" Hex

- 2-Cutter head
- SDS Shank with hex shoulder for Tap-Con screw system



Part #	Mfg #	Bit Dia	Overall Length	Drilling Depth	Price
137644	48-20-7091	5/32"	7"	4"	
137645	48-20-7092	3/16"	7"	4"	

Stop Bit SDS-PLUS

- For use with drop-in anchors
- Stopping shoulder to drill accurate depths repeatedly
- Patented flute geometry to remove debris rapidly and maximize impact energy
- Centering tip to reduce bit walking and create exact spot drilling



Part #	Mfg #	Description	Price
171096	48-20-7651	3/8" x 1-1/16" Stop Bit SDS-PLUS	
171101	48-20-7653	1/2" x 1-11/16" Stop Bit SDS-PLUS	
171103	48-20-7655	5/8" x 2-1/16" Stop Bit SDS-PLUS	

Hammer Drill Bits

Carbide-Tip Hammer Drill Bit

Part #	Mfg #	Description	Price
137662	48-20-8810	1/4" x 2" x 4" with Hex Shank	

Three-Flat Secure-Grip™ Hammer Drill Bit

- Fast drilling, long life
- 3-Flat Secure-Grip™ prevents bit from slipping in the chuck



Part #	Mfg #	Size	Price
137665	48-20-8821	3/8" x 4" x 6"	
137658	48-20-8800	1/8" x 1-1/2" x 3"	
137663	48-20-8811	1/4" x 4" x 6"	
137659	48-20-8801	5/32" x 4" x 6"	
137660	48-20-8805	3/16" x 2" x 4"	
137661	48-20-8806	3/16" x 4" x 6"	
137664	48-20-8816	5/16" x 4" x 6"	
137666	48-20-8830	1/2" x 4" x 6"	

5-Piece, 3-Flat Secure-Grip™ Hammer-Drill Bit Set

- Comprehensive offering with diameters from 1/8" to 1" with lengths up to 18"



Part #	Mfg #	Description	Price
137667	48-20-8851	Bit Hammer-Drill Kit	

Tools

Drill Bits

Scraping Chisel

- Scraping chisel
- 3/4 inch Hex with 21/32 inch round shank
- 2 inch width x 12 inch overall length
- Made from forged high grade steel



Part #	Mfg #	Description	Price
172488	48-62-2065	2" Scraping Chisel	

SDSMAX DEMO FLAT CHISEL

- Cold chisel
- SDS-Max shank
- Made from forged high grade steel



Part #	Mfg #	Description	Price
167377	48-62-4079	SDSMAX Demo 12" Flat Chisel	

SHOCKWAVE™ 1/2" Deep Well Socket Set (9 PC)

- Chromoly steel and custom heat treatment for maximum durability in high torque applications
- Radius corners: drives on flats to reduce stripping and breakage
- Thin wall construction for impact strength in tight clearance applications
- Includes:
 - (1) 3/8" SHOCKWAVE impact socket
 - (1) 7/16" SHOCKWAVE impact socket
 - (1) 1/2" SHOCKWAVE impact socket
 - (1) 9/16" SHOCKWAVE impact socket
 - (1) 5/8" SHOCKWAVE impact socket
 - (1) 11/16" SHOCKWAVE impact socket
 - (1) 3/4" SHOCKWAVE impact socket
 - (1) 7/8" SHOCKWAVE impact socket
 - (1) 1/4" Hex to 1/2" square adapter



Part #	Mfg #	Description	Price
160302	49-66-4484	SHOCKWAVE™ 1/2" Deep Well Socket Set (9 PC)	

Tools

Drill Bits

Compact Benders

Compact Bender Kit

- Body and crossbar for:
1/4" to 7/8", 1/4", 5/16",
3/8", 1/2", 5/8", 3/4", and
7/8" mandrels
- One-handed operation



1839032

Part #	Mfg #	Description	Price
165774	1839032	CBK Compact Bend	
176360	1926598	CBK Compact Bend, With Reverse Bend Attachment	

Drill Bits

Drill Bits

Polished Double Enders Drill Bit

- *Punch style length*
- *Bit at each end*
- *135° Split point*
- *For use on sheet metal*



Part #	Mfg #	Bit Dia	O/A Length	Price
006385	DE1/8	1/8"	2"	
006384	DE1/4	1/4"	2-1/2"	

Drill Bits

Drill Bits

Straight Shank Drill Bit

- Jobbers length for high speed
- For wood or metal
- General purpose



Part #	Mfg #	Size	Price
052311	4714	1/2"	

Drill Bits

Bi-Metal Utility Bits

- Extreme durability; long life even in nail-embedded wood
- Optimized for cordless drilling extending battery life
- (3) Cutting edges enhance chip removal for a fast, clean hole
- 6" Length
- Resharpenable with Lenox® Diamond file No. 25312



Part #	Mfg #	Size	Shank	Price
108511	10947	5/8"	1/4"	
108512	10948	3/4"	1/2"	
108513	10949	7/8"	1/2"	
108514	10950	1"	1/2"	
108515	10951	1-1/8"	1/2"	
108516	10952	1-1/4"	1/2"	
108517	10953	1-3/8"	1/2"	

3-Piece Bi-metal Utility Bit Set

Part #	Mfg #	Description	Price
108518	10954	Includes 3/4", 7/8" & 1"	

5-Piece Bi-metal Utility Bit Set



Part #	Mfg #	Description	Price
108519	10955	Includes 3/4", 7/8", 1", 1-1/8" & 1-1/4"	

Vari-Bits®

Vari-Bit® Step Drill Bit

- High speed steel construction and steam oxide coating
- (2) Cutting flutes for clean burr-free holes



Part #	Mfg #	Number Hole Size	Hole Size	Elec Drill Size	Price
027647	30881-VB1	13	1/8 - 1/2	1/4"	
025886	30882-VB2	9	1/2 - 1	3/8"	

Vari-Bits® (Continued)

Vari-Bit® Step Drill Bit

Part #	Mfg #	Number Hole Size	Hole Size	Elec Drill Size	Price
006268	30883-VB3	9	1/4 - 3/4	3/8"	
053938	30912-VB12	5	7/8 - 1-3/8	3/8"	

Vari-Bit® Kit



Part #	Mfg #	Description	Price
025885	30927-VBKA6	6-Piece Vari-Bit Kit	

Wood Bits

Lenox® Leader® Automatic Feed Wood Bit

- Forged body design, strong construction
- Can be re-sharpened with file

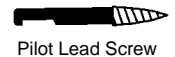

Pilot Lead Screw

Part #	Mfg #	Description	Price
037759	33901-34LS	#34 Leader Lead Screw Fits LL300-462	

Wood Boring Bit

- (2) Cutting edges, self-feeding, easy to sharpen
- Solid one-piece construction with black oxide rust inhibitor



Wood Boring Bit

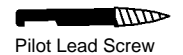

Pilot Lead Screw

Part #	Mfg #	Diameter	Price
006274	32150-WB150	1-1/2"	
006275	32175-WB175	1-3/4"	
006276	32200-WB200	2"	
006321	32900-WBPS	Pilot Lead Screws (Fits all sizes) 5/Pk	

Tools

Drill Bits

Bi-Metal Self-Feed Wood Drill Bit

- High speed steel cutting edit
- Chamfered edge, flutes remove excess wood chips
- Lead screw tip
- Shank cuts 4" x 4" without extension
- Quick change



Part #	Mfg #	Diameter	Price
028007	1787511	1"	
025197	1787512	1-1/8"	
025883	1787513	1-1/4"	
028008	1787515	1-3/8"	
006262	1787561	1-1/2"	
028009	1787562	1-3/4"	
006263	1787563	2"	
006264	1787564	2-1/8"	
028010	1787565	2-1/4"	
006265	1787566	2-9/16"	
025884	1787502	3"	

Bi-Metal Self-Feed Wood Drill Bit Accessories

Part #	Mfg #	Description	Price
022383	1787602	1" - 1-3/8" Lead Screws, 5/Pk	

Tools

Flaring Tools

Flaring Tools
Pro-Set® Flaring Tool



- For use on the following tube materials:
- Copper
- Aluminum
- Brass
- Thin-Wall Steel

Part #	Mfg #	Description	Price
134798	87-FT800FN	R-410A Imperial Block 3/16", 1/4", 5/16", 3/8", 1/2", 5/8", 3/4" with Ratchet	

Tools

Flaring Tools

Flaring Tools

Ratchet Flaring Tool

- Ratcheting feed screw handle
- Hardened steel flaring cone, eccentrically mounted in needle bearings



Part #	Mfg #	Model	Type	Sizes	Price
045766	83037	458R	45° SAE Flares	1/8", 3/16", 1/4", 5/16", 3/8", 1/2", 5/8", 3/4"	

Flaring Tool

- Precision designed tool for producing 45° flares in soft copper, brass, aluminum, and mild steel (JIC and Bundy) tubing
- A hardened, smooth cone provides fast, 45° flares either single or double lap
- A single clamp screw provides for easy clamping and removal of tubing



Part #	Mfg #	Model	Type	Sizes	Price
008721	23332	345	45° SAE Flares	3/16", 1/4", 5/16", 3/8", 7/16", 1/2", 5/8"	

Hammer-Type Flaring Tool

- Made of high-grade hardened steel
- Long nose guide that centers tools for smooth, 45° uniform flares



Part #	Mfg #	Model	Water Tube Size	Price
067998	41320	E-45	1/2"	
008618	41330	E-47	3/4"	
008625	41335	E-52	1"	
025807	41345	E-63	1-1/2"	
022441	41350	E-64	2"	

Tools

Flaring Tools

Flaring Tools

Flaring Tool

- *Makes smooth flare*
- *For OD sizes 3/16", 1/4", 5/16", 3/8", 1/2" and 5/8"*



Part #	Mfg #	Description	Price
041946	J40-080	Bar Flaring Tool	

Copper Swedge Tools

- *Heat-treated carbon steel*
- *Can be used on copper tube, oft copper, aluminum or any other thin-walled tubing*



Part #	Mfg #	Description	Price
064624	J40-369	5/8" to 1-1/8" Copper Swedge	

Flashlights

M12™ Lithium-Ion Cordless Work Lights

M12™ Work Light

- REDLITHIUM™ battery technology
- Compact design
- 90° rotating head
- Integrated magnet



Part #	Mfg #	Description	Price
164019	49-24-0145	M12™ Work Light	

M12™ TRUEVIEW™ LED Spotlight

- Up to 700 yard beam distance
- 3 Light output modes for distance, clarity, and safety
- High: 750 lumens
- Low: 400 lumens
- Strobe: 800 lumens
- Impact and moisture resistant



Part #	Mfg #	Description	Price
181689	2353-20	M12™ LED Spotlight	

M18™ ROCKET™ LED Tower Light

- 7ft Max extension
- Rotating and pivoting head is extendable from 4-7ft
- Compact 26" footprint w/ low center of gravity
- Three light output modes
 - High: 2,000 lumens
 - Medium: 1,300 lumens
 - Low: 850 lumens
- Impact resistant, reinforced legs



Part #	Mfg #	Description	Price
137576	49-24-0146	90° Pivoting Head	
181687	2130-20	18V, High Definition Output	

M18 Rocket™ LED Tower Light/Charger

- 5 Second setup, 7 foot extension
- 3,000 Lumens of multidirectional light
- Impact resistant, reinforced legs
- Built in M18™ charger
- Covered AC Plug-in
- 3 Independently pivoting light heads
- Protective guard to secure head and lens during transport and storage
- Compact footprint, low center of gravity
- Low battery indicator



Part #	Mfg #	Description	Price
226119	2135-20	M18 ROCKET™ LED Tower Light/Charger (Tool Only)	
226121	2135-21HD	M18 ROCKET™ LED Tower Light/Charger Kit	

M12™ LED Lantern/Flood Light

- TRUEVIEW™: High definition lighting technology
- 180° - 360° Adjustable beam
- 2.1A USB Charger
- Rugged design
- Four light settings: High, medium, low, strobe
- Two stainless steel hooks



Part #	Mfg #	Description	Price
171826	2362-20	M12™ LED Lantern/Flood Light	

M18™ Lithium-Ion Cordless Work Lights

M18™ Cordless Work Light

- Uses 18V compact or XC high capacity Lithium-Ion battery (sold separately)
- Xenon incandescent bulb
- Fold away utility hook



Part #	Mfg #	Description	Price
148143	49-24-0171	135° Rotating Head	

Flashlights

M18™ Cordless LED Work Light

- Sealed, aluminum head
- 160 Lumen LED
- Lasts up to 12 hours on one charge
- Integrated hook



Part #	Mfg #	Description	Price
137577	2735-20	135° Rotating Head	

M12™ LED Stick Light (Bare Tool)

- TRUEVIEW™ High definition lighting technology
- Powerful 3-LED design
- Multi-position stainless steel hook
- Over 4+ hours of run-time
- Bright, smooth, even beam pattern
- Impact resistant/replaceable lens



Part #	Mfg #	Description	Price
158985	2351-20	M12™ LED Stick Light (Bare Tool)	
158986	49-24-2351	M12™ LED Stick Light Accessory Magnet	

M18™ LED Flood Light

- Trueview: High definition lighting technology
- Up to 30% brighter than corded 250 halogen lights
- Up to 8 hours of run-time
- Limited lifetime LED warranty
- Innovative roll cage design
- Multiple hanging features: emt hanger, key hole hanger, cross bar hanger, handle hanger



Part #	Mfg #	Description	Price
161982	2361-20	M18™ LED Flood Light	

M18™ Rover™ LED Dual Power Flood Light

- Three light output modes
- Medium Mode: 1,500 lumens for up to 4 hours with M18™ XC 5.0 Pack
- High Mode: 3,000 lumens for up to 2 hours with M18™ XC 5.0 Pack
- Low Mode: 650 lumens for up to 8 hours with M18™ XC 5.0 Pack
- High Definition Output with true color, even beam, and natural light
- Dual Power Source: M18™ or Corded
- Light Head rotates 240° with positive stops
- (3) integrated keyholes for hanging horizontally or vertically
- Durable Roll Cage protects light head



Part #	Mfg #	Description	Price
181688	2360-20	M18™ LED Dual Power Flood Light	

M18™ LED Stick Light

- TRUEVIEW: High definition lighting technology
- Forward and backward pivoting head
- Rugged design: replaceable lens plate and chemical resistant body
- Two adjustable metal hooks
- Compact design



Part #	Mfg #	Description	Price
172034	2352-20	M18™ LED Stick Light	

M18™ LED Lantern/Flood Light

- TRUEVIEW: High definition lighting technology
- 180° - 360° Adjustable beam
- 2.1A USB Charger
- Rugged design
- Four light settings: High, medium, low, strobe
- Two stainless steel hooks



Part #	Mfg #	Description	Price
171827	2363-20	M18™ LED Lantern/Flood Light	

Flashlights

M18 RADIUS™ LED Compact Site Light w/ ONE-KEY™

- Set light remotely from 50ft
- Optimize brightness and runtime
- Program automatic schedule
- Lighting for task, area, and overhead
- 4,400 Lumens for maximum coverage
- High impact polycarbonate lens
- AC in and out: string up to 10 together
- Protected AC plugs self-centering hang hook
- Reinforced hang hole
- 180 and 360 electronic: light control
- Low battery indicator



Part #	Mfg #	Description	Price
222799	2146-20	M18 RADIUS™ LED Compact Site Light w/ ONE-KEY™	

Replacement Bulbs



49-81-0030



49-81-0090

Part #	Mfg #	Description	Price
141993	49-81-0030	Bulbs for 18V Work Light, 2/Pk	
138845	49-81-0090	LED Upgrade for M12™, M18™, V28® Work Lights	

Tools

Flashlights

LED Flashlights

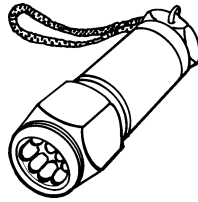

Part #	Mfg #	Description	Price
136007	R319350	Pocket LED Lightstick	

Tools

Flashlights

Rayovac Industrial Flashlights

- Yellow flashlight with ring hangers

RAYOVAC



Part #	Mfg #	Description	Price
052370	F20-001	(2) D Cell	

Batteries

Rayovac Heavy-Duty Alkaline Batteries

RAYOVAC



F20008



F20010



F20009



F20011



F20012

Part #	Mfg #	Description	Price
045080	F20-008	(8) AA Alkaline	
052368	F20-009	(6) 9 Volt Alkaline	
052369	F20-010	(6) C Alkaline	
045082	F20-011	(6) D Alkaline	
045081	F20-012	(8) AAA Alkaline	

Flashlights

Flashlights

LED Mini Pocket Flashlight

- 5mm Nichia white LED light
- 50,000 Hours of lamp life
- 9-Lumen tested light-output generates a strong concentrated beam
- Battery life: 130 hours
- Pushbutton on/off switch provides constant or momentary modes
- Polycarbonate body with o-ring sealed Xenoy® shroud
- Includes a breakaway lanyard and pocket clip
- Interchangeable clear, red and green colored discs



Part #	Mfg #	Description	Price
120393	X5	(4) LR44 Batteries	

Tools



Sensible Products



Sensible Products

Flashlights

Flashlights

Extendable Magnetic Flashlight

- Magnet on grip and at light
- Telescopes from 6.5" to 21"
- Flexible shaft
- (3) Super-bright LEDS with on/off button



EMF-1

Part #	Mfg #	Description	Price
134816	EMF-1	LED Telescopic Flashlight	

Batteries

Part #	Mfg #	Description	Price
134817	FB-1	(4) Batteries for EMF-1	

Magnetic Stick Light

- Pocket-sized floodlight
- Magnet in handle
- Molded clip keeps in pocket
- Rugged, water resistant
- (6) Super-bright LEDS
- 36 Lumen output
- Runs more than 10 hours



Part #	Mfg #	Description	Price
145098	MSL-1	Magnetic Stick Light	

Pocket Area LED Light

- Ratcheting hinge angles light as needed
- Hanging hook swivels 360°
- Powerful magnet attaches securely to a horizontal or vertical surface
- (18) Super-bright LEDS
- Runs more than 6 hours
- Easy on/off - open/close

Part #	Mfg #	Description	Price
145267	PAL-1	Pocket Area Light	

Tools

Hammers

Hammers

Sheet Metal Hammer - Riveting

- Polished finish



Part #	Mfg #	Size	Handle	Head Weight	Price
006477	RH4	4-7/8"	Leather	12 oz	

Sheet Metal Hammer - Setting

- Polished finish



Part #	Mfg #	Size	Handle	Head Weight	Price
006482	SH3	5-1/2"	Leather	18 oz	

Tools

Hammers

Hammers

Hammer



Ball Pein



Ripping Claw



Part #	Mfg #	Model	Description	Head Weight	Overall Length	Price
008654	52455	016	Ball Pein	16 oz	14"	
008705	52485	216	Ripping Claw	16 oz	13-1/4"	



Hand Sewer Machines

Flexicore® Closet Augers

Regular Head Closet Auger

- With Flexicore double layer wire rope center



3FL



T6FL

Part #	Mfg #	Description	Price
093674	3FL	3' Flexicore (6/Ctn)	
005064	T6FL	6' Teletube Flexicore	

Down Head Closet Auger

- Flexicore double layer wire rope center



3FL-DH



T6FL-DH

Part #	Mfg #	Description	Price
005068	3FL-DH	3' Flexicore	
005063	T6FL-DH	6' Teletube Flexicore	

Urinal Augers



Part #	Mfg #	Description	Price
038683	TU4	Telescoping Teletube® - 48" Spring (6/Ctn)	

Tools

Hand Sewer Machines

Petersen Drain Flushers

- Multi-flex™ multiple ply construction, high flow rate flushing
- Flexible for insertion around bends, internal stiffener for easy insertion
- 3/4" Water hose coupling

Petersen



R193400



R193600



R193700

Part #	Mfg #	Description	Price
008378	R193400	102-001 1-1/2" Drain Jet	
008380	R193600	102-003 3" Drain Jet	
008904	R193700	102-004 4" Drain Jet	

Suction Guns

Part #	Mfg #	Description	Price
080436	R441825	Last Drop Suction Gun	

Tools

Hand Sewer Machines

Plungers

Rubber Plunger

- Includes funnel-shaped cap that is retractable for use in flat sinks



Part #	Mfg #	Type	Handle	Price
183404	312-2	Funnel	20"	

Tools



Hand Sewer Machines

Clog Buster™ Drain Flushers



Part #	Mfg #	Size	Price
002966	303135	1-1/2" - 3"	

Tools



Hand Sewer Machines

Drain Cleaning & Tools

Mighty Mini Sink Plunger

- 4" Black rubber cup
- 8" Plastic handle
- Barcode label



Part #	Mfg #	Description	Price
053480	090288	Mighty Mini Sink Plunger	

All Angle Power Plunger

- Flexible black rubber cup with 21" yellow handle
- Fully assembled with header card



Part #	Mfg #	Description	Price
041779	090300	Power Plunger	

Tools



Hand Sewer Machines

Plungers



Part #	Mfg #	Description	Price
008174	93-8	Korky® Plunger	

Tools



Hand Sewer Machines

Snake-Oil™

- *Highly recommended for use with all types of cables*



Part #	Mfg #	Description	Price
010265	SOQ-12	1 qt, 12/Pk	

Hole Saws

Hole Cutter Kits

7-Piece Big Hawg® Hole Cutter Kit

- Designed for drilling large holes in rough wood
- Cuts up to 600 holes in wood without needing to be re-sharpened
- (3) Hardened steel teeth
- Deep gullet
- Includes:
 - (3) Hole cutters: 2-1/8", 2-9/16", 3-5/8"
 - Arbor with pilot bit
 - (2) Pilot bits
 - (1) Diamond file
 - (1) Hex wrench
- Impact-resistant case with additional storage space



Part #	Mfg #	Description	Price
137896	49-56-9075	7-Pc Big Hawg® Kit	

8-Piece Big Hawg® Hole Cutter Kit

- Includes:
 - (4) Hole saws - 2-1/8", 2-9/16", 3-5/8", 4-5/8"
 - Arbor with Big Hawg® pilot bit (49-56-9105)
 - (2) Big Hawg® Pilot bits (48-27-1401)
 - Diamond file
 - Hex wrench



Part #	Mfg #	Description	Price
138844	49-56-9080	8-Pc Big Hawg® Hole Cutter Kit	

Hole Saw Kits

8-Piece Ice Hardened™ Hole Saw Kit

- Ice Hardened™ for up to 50% longer life
- Includes:
 - (5) Hole saws: 3/4", 7/8", 1", 1-1/8", 1-1/2"
 - Twist-Release™ arbor with pilot bit: 49-56-7210
 - Additional pilot bit: 49-56-8010
 - 1/8" Hex Key
 - Adapter: 49-56-6560



Part #	Mfg #	Description	Price
150075	49-22-4005	8-Pc General Purpose Hole Saw Kit	

10-Piece Plumber's Ice Hardened™ Hole Saw Kit

- Includes:
 - (6) Hole saws: 3/4", 7/8", 1-1/8", 1-1/2", 1-3/4", 2-1/4"
 - (2) Arbors with pilot bits (49-56-7010 and 49-56-9100)
 - (2) Additional pilot bits (49-56-8010)
 - (1) Adapter (49-56-6560)
 - (1) Spacer (49-67-0120)



Part #	Mfg #	Description	Price
139022	49-22-4145	10-Pc Plumbers Ice Hardened™ Kit	

18-Piece Master Plumbers Ice Hardened™ Hole Saw Kit

- Cryogenically treated
- Optimized tooth form for up to 2 times faster cutting
- Wide, angled and offset slots
- Includes:
 - (13) Hole saws - 3/4", 7/8", 1-1/8", 1-3/8", 1-1/2", 1-3/4", 2-1/4", 2-5/8", 3", 3-1/2", 4", 4-1/4", and 4-1/2"
 - (2) Arbors with pilot bits (49-56-7010 and 49-56-9100)
 - (3) Additional pilot bits (49-56-6560)
 - (1) Spacer (49-67-0120)



Part #	Mfg #	Description	Price
139021	49-22-4155	18-Pc Master Plumber's Ice Hardened™ Hole Saw Kit	

28 PC All Purpose Professional Hole Dozer™ Hole Saw Kit

- Rip Guard™, the strongest tooth form in the industry
- Rip Guard™ limited lifetime tooth break warranty
- Plug Jack™, an all access slot design for fast plug removal
- Bi-metal construction with 8% cobalt for increased wear resistance



Part #	Mfg #	Description	Price
154644	49-22-4185	28 PC All Purpose professional Hole Dozer™ Hole Saw Kit	

Hole Saws

Hole Cutters

Big Hawg® Hole Cutter

- Designed for drilling large holes in rough wood
- Arbors and pilot bit sold separately
- Cuts up to 600 holes in wood without needing to be re-sharpened



Part #	Mfg #	Diameter	Price
137886	49-56-9000	2-1/8"	
137887	49-56-9005	2-1/4"	
137888	49-56-9010	2-9/16"	
137889	49-56-9020	3"	
137890	49-56-9030	3-5/8"	
137891	49-56-9045	4-1/4"	
137893	49-56-9050	4-5/8"	
168565	49-56-9055	5-1/4"	
137894	49-56-9065	6-1/4"	

Hole Saws

Carbide Tipped Hole Saw

- Provides longer life and faster cutting
- Designed for cutting ceramic tile, flakeboard, fiberboard, fiberglass and wood
- Not recommended for metal



49-56-0623

Part #	Mfg #	Hole Dia	Price
165182	49-56-0623	5/8"	
165183	49-56-0753	3/4"	
165184	49-56-0873	7/8"	
165185	49-56-1003	1"	
165186	49-56-1123	1-1/8"	
165188	49-56-1253	1-1/4"	
165187	49-56-1373	1-3/8"	
165189	49-56-1503	1-1/2"	
165190	49-56-1623	1-5/8"	
165191	49-56-1753	1-3/4"	
165192	49-56-2003	2"	
165193	49-56-2123	2-1/8"	
165195	49-56-2253	2-1/4"	
165196	49-56-2503	2-1/2"	
165202	49-56-2623	2-5/8"	
165203	49-56-2753	2-3/4"	
165204	49-56-2873	2-7/8"	
165205	49-56-3003	3"	
165206	49-56-3253	3-1/4"	
165207	49-56-3503	3-1/2"	
144973	49-56-3623	3-5/8"	

Hole Saws (Continued)

Carbide Tipped Hole Saw

Part #	Mfg #	Hole Dia	Price
165208	49-56-3753	3-3/4"	
154873	49-56-4003	4"	
144972	49-56-4253	4-1/4"	
165209	49-56-4503	4-1/2"	
165210	49-56-5003	5"	
165211	49-56-6003	6"	

Hole Dozer™ Hole Saw

- Rip Guard™, the strongest tooth form in the industry
- Plug Jack™, an all access slot design for fast plug removal
- Bi-metal construction for increased wear resistance



Part #	Mfg #	Description	Price
165164	49-56-0012	5/8"	
152110	49-56-0023	3/4"	
152111	49-56-0032	7/8"	
165165	49-56-0017	1 1/16"	
152112	49-56-0043	1"	
165166	49-56-0047	1-1/16"	
152113	49-56-0052	1-1/8"	
152114	49-56-0062	1-1/4"	
152115	49-56-0072	1-3/8"	
152116	49-56-0082	1-1/2"	
165167	49-56-0092	1-5/8"	
165178	49-56-0112	1-7/8"	
152117	49-56-0127	2-1/8"	
151231	49-56-9630	2-3/8"	
165168	49-56-0153	2-9/16"	
153383	49-56-0163	2-3/4"	
165170	49-56-0167	2-7/8"	
165171	49-56-0177	3-18"	
165172	49-56-0183	3-1/4"	
165173	49-56-0203	3-3/4"	
165174	49-56-0217	4-1/8"	
165175	49-56-0223	4-1/4"	
165176	49-56-0237	4-3/4"	
165177	49-56-0253	6"	

Hole Saws

Ice Hardened™ Hole Saw

- Ice Hardened™ for up to 50% longer life



Part #	Mfg #	Size	Price
143992	49-56-0102	1-3/4"	
144015	49-56-0117	2"	
144016	49-56-0147	2-1/2"	
150074	49-56-0158	2-5/8"	
144017	49-56-0173	3"	
148183	49-56-0193	3-1/2"	
144018	49-56-0197	3-5/8"	
144019	49-56-0233	4-1/2"	
142700	49-56-0243	5"	

Diamond Plus™ Hole Saw

- Diamond Plus™ greater durability and toughness delivers up to 10X longer life
- Higher grade diamonds and improved braze: Provides best-in class performance
- Large slug ejection slot
- Versatile: Ideal for cutting anchoring and clearance holes in all tile, stone and glass



Part #	Mfg #	Description	Price
173242	49-56-0505	1/4" Diamond Plus™ Hole Saw	
173243	49-56-0507	5/16" Diamond Plus™ Hole Saw	
173244	49-56-0515	3/4" Diamond Plus™ Hole Saw	
173245	49-56-0426	1-3/8" Carbide Grit Hole Saw	

Core Bit With Center Bit

- Long life: Abrasion-resistant carbide teeth increase cutter life and produce a cleaner cut
- Accurate cuts: Centering bit eliminates slipping for accurate hole placement and dimensions
- Versatile design: Use with 11" extension for extra-deep drilling applications
- Multipurpose SDS-MAX or spline shank: Interchangeable with a variety of drilling heads from 1-1/2" to 5"



Part #	Mfg #	Description	Price
166215	48-20-5092	2-1/8" Core Bit With Center Bit	

SDS-Max and SPLINE Thick Wall Carbide Tipped Core Bit

- Thick Wall Design
- Use with 12" or 18" SPLINE adapter shanks (48-00-3564, 48-03-3565) and 12" or 18" SDS-Max adapter shanks (48-03-3572, 48-03-3573)
- Use with 7-1/2" extension 48-95-6085
- Use with guide plate 48-20-5174 and centering pin 48-20-5199
- Includes core body with guide plate & centering pin



Part #	Mfg #	Description	Price
164477	48-20-5130	SDS-MAX and SPLINE Thick Wall Carbide Tipped Core Bit 1-3/4"	
159714	48-20-5140	SDS-MAX and SPLINE Thick Wall Carbide Tipped Core Bit 2-1/2"	
155357	48-20-5150	SDS-MAX and SPLINE Thick Wall Carbide Tipped Core Bit 3-1/2"	
162578	48-20-5155	SDS-MAX and SPLINE Thick Wall Carbide Tipped Core Bit 4"	

Hole Saws

SDS-PLUS Thin Wall Carbide Tipped Core Bit

- Thin wall design
- 2" Diameter
- Usable cutting depth 2-13/16"
- Use with 8" or 12" SDS PLUS adapter shanks (48-03-3555, 48-03-3561)
- Use with 7-1/2" extensions 48-95-6075
- Use with guide plate 48-20-6157 and centering pin 48-20-6155
- Includes core body with guide plate & centering pin



Part #	Mfg #	Description	Price
163505	48-20-5035	SDS-PLUS Thin Wall Carbide Tipped Core Bit 2"	
163506	48-20-5050	SDS-PLUS Thin Wall Carbide Tipped Core Bit 3-1/2"	

Diamond Core Bit Pre-Stress

- Maximum speed: Segment design allows coring at higher RPM
- High quality: Segments are silver-brazed for exceptional holding strength
- Versatile: Effectively cores pre-stressed and steel reinforce concrete, and asphalt



Part #	Mfg #	Description	Price
159936	48-16-6014	6" Diamond Core Bit Pre-Stress	

Thin Wall Hole Saw

- 1/4" Quick change hex shank for use with impact drivers
- Thin wall 8 TPI design for 40% faster cuts than standard bi-metal hole saws
- Stop shoulder design prevents over drilling and damaging components
- Ejection spring automatically removes slugs



Part #	Mfg #	Description	Price
169268	49-56-9805	3/4" Thin Wall Hole Saw	
169269	49-56-9810	7/8" Thin Wall Hole Saw	
169270	49-56-9815	1" Thin Wall Hole Saw	
169271	49-56-9820	1-1/8" Thin Wall Hole Saw	
169272	49-56-9825	1-1/4" Thin Wall Hole Saw	
169273	49-56-9830	1-3/8" Thin Wall Hole Saw	
169274	49-56-9835	1-1/2" Thin Wall Hole Saw	

Arbors

3/8" Small Arbor

- Durable hardened steel construction
- Fits all hole saws up to 1-3/16"
- Fits all drill chucks 3/8" and larger



Part #	Mfg #	Size Range	Shank Size	Price
144976	49-56-7010	Up to 1-3/16"	3/8"	

Big Hawg® Arbor

- Standard 5/8"-18 thread fits all hole saws or hole cutters 1-1/4" through 6-1/4"
- Includes:
 - (1) Flat boring pilot bit
 - (1) Big Hawg® Arbor
 - (1) 7/16" Quick change shank



Part #	Mfg #	Description	Price
137895	49-56-9105	Big Hawg® Arbor	

Large Quick Change Arbor

- Tool-free operation
- Universal, quick change with all brands of hole saws
- No adapters required
- Hardened steel construction
- Fits all hole saws 1-1/4" and larger
- Fits all drill chucks 3/8" and larger



Part #	Mfg #	Size Range	Shank Size	Price
144975	49-56-7250	1-1/4"+	3/8"	
149219	49-56-9100	1-1/4"+	7/16" No Wobble	

Pilot Drill Bits

Big Hawg® Hole Cutter Pilot Bit

- Machined cutting edge for increased cutting speed
- Exclusive bit geometry aids plug removal



Part #	Mfg #	Description	Price
137898	48-27-1401	Big Hawg® Center Spade Bit	



Hole Saws

Hole Saw Accessories

Universal Quik-Lok™ Extension

- Accepts all 7/16" shanks
- No tools required for bit change
- Impact rated



Part #	Mfg #	Size	Price
144978	48-28-1000	3" x 1/4"	
152998	48-28-1030	5-1/2" x 7/16"	

Hex Extension

Part#	Mfg #	Description	Price
138372	48-28-1010	6" Hex Extension	
138373	48-28-1020	12" Hex Extension	

Right Angle Attachment

- Rated up to 235 in/lbs torque
- Accepts standard 1/4" hex shank bits



Part #	Mfg #	Description	Price
149497	49-22-8510	Right Angle Attachment	

Files

Big Hawg® Diamond File

- Easy re-sharpening on job site



Part #	Mfg #	Description	Price
137897	48-95-5055	Big Hawg® Diamond File	

Tools

Hole Saws

Hole Saws

Bi-Metal Hole Saws

- TUFF TOOTH™ design is reinforced to cut stronger and last longer
- Patented VARI-TOOTH® design resists tooth stripping
- High speed steel teeth resist breaking and offer extended life



Use Arbor 1L, 1SL, 4L or 5L

- (1) Per box

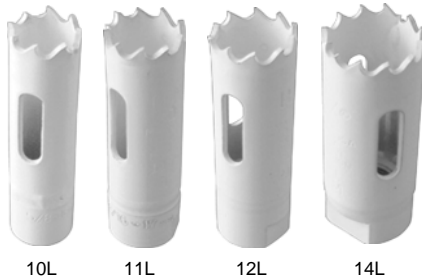

Part #	Mfg #	Dia	Pipe Tap	Pipe Entr	Price
089115	30010-10L	5/8"	-	-	
078170	30011-11L	11/16"	-	-	
006288	30012-12L	3/4"	1/2"	3/8"	
006294	30014-14L	7/8"	3/4"	1/2"	
006296	30016-16L	1"	-	-	
006298	30018-18L	1-1/8"	1"	3/4"	

Use Arbor 2L, 2SL, 3L or 6L

- (1) Per box

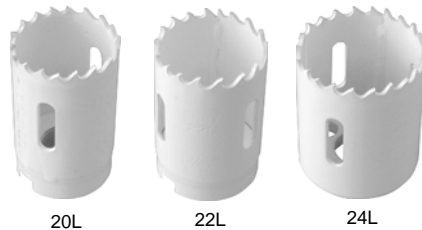

Part #	Mfg #	Dia	Pipe Tap	Pipe Entr	Price
006300	30020-20L	1-1/4"	-	-	
006304	30022-22L	1-3/8"	-	1"	
006307	30024-24L	1-1/2"	1-1/4"	-	

Use Arbor 2L, 2SL, 3L, 6L or 7L

- (1) Per box

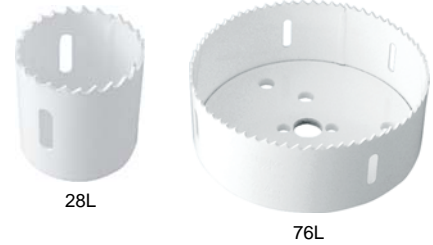

Part #	Mfg #	Dia	Pipe Tap	Pipe Entr	Price
006308	30026-26L	1-5/8"	-	-	
006309	30028-28L	1-3/4"	1-1/2"	1-1/4"	
006311	30030-30L	1-7/8"	-	-	
006318	30032-32L	2"	-	1-1/2"	
006324	30034-34L	2-1/8"	-	-	
006325	30036-36L	2-1/4"	2"	-	
080342	30038-38L	2-3/8"	-	-	
006329	30040-40L	2-1/2"	-	2"	
074661	30041-41L	2-9/16"	-	-	
006333	30042-42L	2-5/8"	2-1/2"	-	
006336	30044-44L	2-3/4"	-	-	
006337	30046-46L	2-7/8"	-	-	
006341	30052-52L	3-1/4"	3"	-	
006342	30056-56L	3-1/2"	-	-	
006344	30058-58L	3-5/8"	-	3"	
006346	30060-60L	3-3/4"	3-1/2"	-	
006355	30064-64L	4"	-	-	
006357	30066-66L	4-1/8"	-	3-1/2"	
006359	30068-68L	4-1/4"	4"	-	
006361	30072-72L	4-1/2"	-	-	
006362	30076-76L	4-3/4"	4-1/2"	-	
020254	30080-80L	5"	-	-	
045591	30096-96L	6"	-	-	

Carbide Tipped Hole Saw - Lenox® Blue

- Cuts abrasive materials, lasts up to 10 times longer than standard
- Uses standard arbors, recommend carbide tipped pilot drill

Use Arbor 1L, 1SL or 4L

- (1) Per box



Part #	Mfg #	Dia	Pipe Tap	Pipe Entr	Price
006297	30218-18CT	1-1/8"	1"	3/4"	

Hole Saws

Use Arbor 2L or 2SL

- (1) Per box

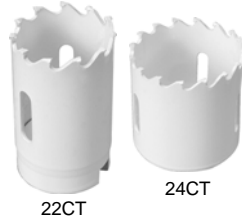

Part #	Mfg #	Dia	Pipe Tap	Pipe Entr	Price
045833	30220-20CT	1-1/4"	-	-	
006303	30222-22CT	1-3/8"	-	1"	
022412	30224-24CT	1-1/2"	1-1/4"	-	

Use Arbor 2L, 2SL or 7L

- (1) Per box

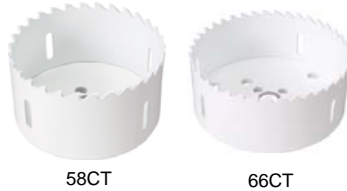

Part #	Mfg #	Dia	Pipe Tap	Pipe Entr	Price
006328	30240-40CT	2-1/2"	-	2"	
065796	30241-41CT	2-9/16"	-	-	
043574	30258-58CT	3-5/8"	-	3"	
099663	30264-64CT	4"	-	-	
033467	30266-66CT	4-1/8"	-	3-1/2"	

Diamond™ Hole Saw - 1-Piece

- For use on tile and stone
- Continuous brazed edge
- Over-sized slot in hole saw for easy plug removal
- No arbor required



Part #	Mfg #	Dia	Pipe Tap	Pipe Entr	Price
118297	121074DGDS	1/4"	-	-	
118303	1211416DGDS	1"	-	-	
118304	1211622DGDS	1-3/8"	-	1"	
118309	1211722DGDS	1-3/8"	-	-	
118310	1211824DGDS	1-1/2"	-	-	

Hole Saw Arbor

- 7L "Ejector Arbor" makes removal of material from inside of hole saw easier



Part #	Mfg #	Fits Hole Saws	Size	Shank	Price
006284	1779774	1L	9L-19L	1/2" Hex	
006299	1779801	2L	20L-96L	1/2" Hex	
006310	1779802	3L	20L-96L	1/2" Hex	
006327	1779803	4L	20L-96L	1/2" Solid/Hex	
006339	1779804	5L	9L-19L	3/8" Hex	
006345	1779805	6L	20L-96L	3/8" Hex	

Pilot Drill Bit



Part #	Mfg #	Fits Arbor #	Chuck Size	Pack	Price
058242	30297-123CT	1L,2L,4L,7L	1/4"	1	
006335	1779771	1L, 2L, 4L	1/4"	1	
006343	1779810	3L,5L,6L,7L	1/4"	25	

T-2 Technology Snap-Back™ Arbor

- Hex shank
- Faster and easier to engage/disengage hole saw
- Drives off pins, not threads
- No tools needed - prevents hole saw from locking on arbor
- Arbor threads directly into all hole saws



Part #	Mfg #	Fits Hole Saws	Thread Size	Price
125100	1779772	20L-96L	5/8"-18	
125101	1779669	9L-19L	1/2"-20	
125102	1779670	20L-96L	5/8"-18	

Tools

Hole Saws

One Tooth™ Wood Hole Cutter

- 3 Times faster than regular hole saws
- Safer/less torque than self feed bits
- Easy plug ejection
- Cuts wet, frozen, pressure treated and hard wood without binding
- Can be resharpened



Part #	Mfg #	Cutter Size	Price
061649	25434-34HC	2-1/8" for 1-1/2" Pipe, Lock Installation	
058041	25436-36HC	2-1/4" for 1-1/2" Pipe & 45°/90° Bend Couplings	
061648	25441-41HC	2-9/16" for 2" Pipe	
058043	25444-44HC	2-3/4" for 2" Pipe & 45°/90° Bend Couplings	
058044	25456-56HC	3-5/8" for 3" Pipe	
058045	25464-64HC	4" for 3" Pipe & Coupling, Dryer Vent	
058046	25474-74HC	4-5/8" for 4" Pipe	
058047	25480-80HC	5" for 4" Pipe & Coupling	
060636	25310-SB38	3/8" Stubby Spade Bit	
060634	25312-DIAF1	Diamond Sharpener File	

Bi-Metal Hole Saw Kit

- Designed for professional trades
- Plumbers Large Kit
- Includes:
 - (1) ea 3/4", 7/8", 1-1/8", 1-1/2", 1-3/4" and 2-1/4" Hole saws
 - (2) Arbors 2L and 5L
 - (1) 4321 Pilot drill
 - (1) Arbor adaptor
 - Plastic case



Part #	Mfg #	Description	Price
006347	30808-600P	10-Piece Large Hole Saw Kit	

Plumbers Medium 10-Piece Kit

- Includes:
 - (1) ea 3/4", 7/8", 1-1/8", 1-3/8", 2" and 2-1/2" Hole saws
 - (2) Arbors 2L and 5L
 - (1) 4321 Pilot drill
 - (1) Arbor adaptor
 - Plastic case



Part #	Mfg #	Description	Price
114142	30860-600CGP	10-Piece Plumbers Hole Saw Kit	

Electricians 10-Piece Hole Saw Kit

- Includes:
 - (1) ea 7/8", 1-1/8", 1-3/8", 1-3/4", 2" and 2-1/2" Hole saws
 - (2) Arbors: 2L and 5L
 - (1) 4321 Pilot drill
 - (1) Arbor adaptor
 - Plastic case



Part #	Mfg #	Description	Price
020550	30800-600L	Hole Saw Kit	

General Purpose - 26-Piece Kit

- Includes:
 - (1) ea 1-1/2", 1-3/4", 2", 2-1/8", 2-1/4", 2-1/2", 2-11/16", 3", 3-1/4", 3-3/8", 3-5/8", 3-3/4", 4-1/8", 4-1/2" and 4-3/4" Hole saws
 - (3) Arbors: 1L, 2L, 5L
 - (2) 4321 and (1) 56PD Pilot drills
 - Plastic case



Part #	Mfg #	Description	Price
059480	30804-2000G	Big Daddy™ Hole Saw Kit	

Carbide Tipped Hole Saw Kits

- Designed for professional trades
- 17-Piece Plumbers
- Includes:
 - (1) ea 3/4", 7/8", 1-1/8", 1-1/2", 1-3/4", 2-1/4", 2-9/16", 3", 3-1/2", 4", 4-1/4" and 4-1/2" Hole saws
 - (2) Arbors: 2L and 5L,
 - (2) 4321 and (1) 56 PD Pilot drill
 - Plastic case



Part #	Mfg #	Description	Price
062471	30801-1200P	Bi-Metal Hole Saw Kit	

Hole Saw Accessories

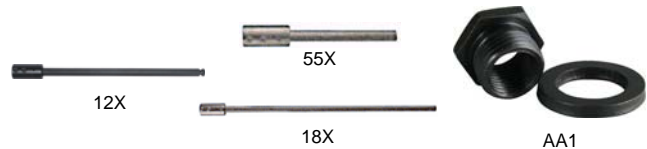

Part #	Mfg #	Description	Price
006312	30846-55X	5-1/2" Extension	
036486	30843-10X	10" Extension Fits 3/8" & Larger Drill Chucks For 5L or 6L Arbors	
006313	30847-12X	12" Extension	
006314	30848-18X	18" Extension	
006315	30857-AA1	Arbor Adaptor	

Tools

HVAC Testing Tools

Motor Testers

TECMate Pro ECM Motor Tester

- Analyze ECM motors independent of the HVAC system
- Operates in the basic HVAC settings of fan-only, heating, cooling and de-humidification
- Designed to detect and isolate motor failures from other HVAC system failures



Part #	Mfg #	Description	Price
153548	PD510009	TECMate Pro Motor Tester	

Safety Power Adapters

Zebra'Dapter Fused Power Tap Cord

- Lighted to show voltage level of plug
- Safe way to obtain 120V power to vacuum pumps, charging scales, drop lights, etc.



Part #	Mfg #	Description	Price
140729	ZD002	2' Lighted Female Cordset Blue	
140728	ZD001	2' Lighted Male Cordset Yellow	

Test Connector

Part #	Mfg #	Description	Price
031520	45-24318-01	Test Connector	

Circuit Protection Products

ZBreaker Circuit Breaker Set



Part #	Mfg #	Description	Price
141508	ZK005	5 Amp	

Short-Pro Tool™

- Finds 24 volt system shorts
- Automatically resets the breaker
- (2) 18" Leads



Part #	Mfg #	Description	Price
140758	ZSPRT	Short-Finder	

Smoke Detector & Accessories

SL-2000 Duct Smoke Detector

- Hi-Temp
- Low-Flow
- No Tools



ME A
approved



Part #	Mfg #	Description	Price
118470	SL-2000-N	4-Wire Ionization	

Sampling Tube for SL-2000 & RT-3000 Series



Part #	Mfg #	Description	Price
118471	STN-2.5	12" to 3.0'	

Meters

Thermo-Psychrometer

- Large storage area for probes
- TM350 Includes:
 - (1) TMX2A 15' Air probe
 - (1) TMX2G 15' General purpose
 - (1) TMX2S 15' Surface probe



Part #	Mfg #	Description	Price
143080	87-TM350	Four Remote Stations	

HVAC Testing Tools

Probe for TM350 Thermo-Psychrometer



TMX2S

Part #	Mfg #	Description	Price
143081	87-TMX2C	Clamp-On	
143082	87-TMX2P	Puncture	
143083	87-TMX2S	Surface	

Hardware

Alligator Clip

Part #	Mfg #	Description	Price
140494	455055	1" Black, 6/Pk	
140495	455056	1" Red, 6/Pk	
140496	455057	Alligator Clips with 18 AWG - 36" Test Leads	

Test Lead

Part #	Mfg #	Description	Price
140609	455150	10 AWG, 36" with 10A Clip	

Tools

HVAC Testing Tools

Voltage Detectors

Voltage Detector with LED

- Can detect between 50 and 1,000VAC
- Safety rating: CAT IV 1,000V
- Green power on indicator light
- Pocket clip
- Requires (2) AA batteries (included)



Part #	Mfg #	Description	Price
137565	2202-20	Voltage Detector w/LED	

Dual Range Voltage Detector

- Different colors identify voltage range
- Built-in LED work light
- Auto-off
- Pocket clip
- Blade-tip for checking outlets
- Constant power ON LED indicator



Part #	Mfg #	Description	Price
168492	2203-20	Dual Range Voltage Detector	

Test & Measurement Tools

Fork Meter for HVAC/R

- Heavy-duty True-RMS electrical tester for professional residential, commercial and industrial applications
- High contrast white-on-black display
- Five tools in one:
 - Current measurement
 - Temperature measurement
 - Voltage measurement
 - Voltage detection
 - Task lighting - LED work light
- Includes:
 - Fork clamp
 - Test leads
 - Dual banana thermocouple
 - (2) AA Batteries
 - Manual
- 5-Year warranty



Part #	Mfg #	Description	Price
137566	2206-20	Fork Meter Kit for HVAC/R	

Digital Multimeter

- Wide voltage range to 600VAC/DC
- Auto range to millivolts
- True-RMS for accurate measurement in all applications
- Lo-Z measurement to eliminate ghost voltage
- Frequency measurements from 10Hz to 50kHz
- Contact temperature measurement: -40° to 752°F
- Current measurement to 10AAC/DC
- High contrast white on black display with back light
- Rugged over-molding increases durability and user grip
- 5-Year warranty
- Includes:
 - Multimeter
 - Test leads
 - Dual banana thermocouple
 - (2) AA Batteries
 - Manual



Part #	Mfg #	Description	Price
136067	2217-20	Digital Multimeter Kit	

Clamp Meter for HVAC/R

- Electrical current tester for professional residential, commercial and industrial applications
- 1.3" Jaw opening to easily handle large conductors
- White-on-black display
- LED Work light
- Includes:
 - Clamp
 - Test leads
 - Dual banana thermocouple
 - (2) AA Batteries
 - Manual
- 5-Year warranty



Part #	Mfg #	Description	Price
137567	2236-20	Clamp Meter for HVAC/R	

HVAC Testing Tools

Meter Case

- Case constructed of rugged nylon
- Three sided zipper closure
- One inside pocket for a manual and one main compartment for a meter
- Strong nylon strap with snap closure for hanging from belt
- All the following Milwaukee meters fit in this case:
 - 2205-20 Fork meter
 - 2206-20 Fork meter for HVAC/R
 - 2216-20 Digital multimeter
 - 2217-20 Digital multimeter
 - 2235-20 400amp clamp meter
 - 2265-20 Laser temp-gun
 - 2266-20 Laser temp-gun



Part #	Mfg #	Description	Price
164509	48-55-0175	Meter Case	
164510	48-55-0180	Large Meter Case	

Tools

HVAC Testing Tools

Meters & Testers

Vane Anemometer

- Air humidity meter with temperature measurement
- Integrated measurement with 1.5 in. vane
- Timed mean value calculation
- Hold function and max./min. values
- Wind chill calculation for outside areas (perceived temperature)
- Back lit display
- Air humidity measurement with long-term stable Testo humidity sensor
- Incl. dewpoint calculation and wet bulb
- Includes:
 - Integrated humidity measurement and NTC air thermometer
 - Protective cap for safe storage
 - Wrist strap and belt clip
 - (2) Type AAA batteries, 60 hour life
 - Calibration certificate



Humidity and Temperature Meter

- Long-term, stable Testo humidity sensor
- +/-2.5 %RH Accuracy
- Hold function and max/min values
- Includes:
 - Protective cap for safe storage
 - Batteries
 - Calibration certificate



Part #	Mfg #	Description	Price
143079	875042	Dewpoint & Wet Bulb Meter	

Electrical

Part #	Mfg #	Description	Price
141560	86-22510	Test Leads	

Part #	Mfg #	Description	Price
143078	875043	Vane Anemometer with Integrated Humidity & NTC Air Thermometer	

Carbon Monoxide Stick Meter

- Detects presence of carbon monoxide in ambient air from gas furnaces, water heaters, and other appliances or equipment
- Visual and audio warnings, adjustable alarm threshold
- No zero phase, instrument can be used immediately
- CO Zeroing on-site
- Self test function



Part #	Mfg #	Description	Price
143084	875036	Includes Leather Holster w/Belt Strap, Earphone, Wrist Strap	

Tools

HVAC Testing Tools

Clamp-On Digital Multimeters

DL389 G2 Phoenix Pro+ Clamp-On Multimeter

- Dual display and low battery display lock
- Test lead storage and holder on clamp head
- Auto off
- Input jack lock
- Detachable clamp head
- Worklight
- Magnetic mount
- User temperature calibration
- EasyView high contrast backlight display
- Compatible with common industry accessories heads
- Safety compliance CAT III 600V, CAT II 1000V
- Includes:
 - Test leads
 - K-Type probe (no adapter required)
 - Zippered case
 - (2) AAA Batteries
- 3-Year limited warranty



Part #	Mfg #	Description	Price
128764	DL389	12 Functions Including TRUE-RMS (AC Volts & Amps)	

Thermometers

550B Digital Pocket Thermometer

- Water resistant
- Records minimum & maximum temperatures
- Protective boot
- Magnetic mount
- HOLD freezes the current temp reading
- Auto power off
- Ergonomic designed head
- 3-Year limited warranty



Part #	Mfg #	Description	Price
069651	550B	-58° to 572°F Range	

PDT550 Digital Pen Type Thermometer

- Waterproof
- Built-in magnetic mount
- Records minimum & maximum temperatures
- Data hold
- Auto power off
- Easy access battery compartment
- Enhanced accuracy of digital circuitry
- Includes battery & multipurpose probe
- 3-Year limited warranty



Part #	Mfg #	Description	Price
082376	PDT550	-58° to 572°F Range	

CO Detectors

CO71 "The CO Detective" Carbon Monoxide Monitor

- Tri-color LED indicates concentrations at 3 levels complying with residential and work place standards
- Audible alert triggers at 35 ppm indicating the threshold of dangerous concentration
- Backlight display
- Operating temperature: 32° to 104°F
- MAX Continually updates to provide recall of highest CO reading
- Auto zero activates upon turn on
- 9V Battery operated
- 3-Year limited warranty



Part #	Mfg #	Description	Price
051760	CO71	Displays 0 to 999 ppm CO Level in Ambient Air	

Leak Detectors

CD100A Combustible Gas Leak Detector

- Long 18" gooseneck for hard to reach areas
- Tip light in sensor cap illuminates search area
- Probe cage protects sensor
- Audio and visual tic rate fully adjustable
- Headphone jack
- Includes:
 - Sensor and cap
 - 9V Battery
- 1-Year limited warranty



Part #	Mfg #	Description	Price
038331	CD100A	50 ppm Minimum Detection	

Tools

HVAC Testing Tools

Manometers

EM151 Digital Electronic Manometer

- Single input measurement to ± 20 " wg
- Integral protective boot w/magnet
- Simple two-button operation
- Measures in inches water gauge and Mbar
- Automatic after 5 minutes of inactivity and manual power-off
- Includes:
 - (1) Pressure tubes with brass fitting connector
 - (1) Std 9V battery
 - Manual
- 1-Year limited warranty



Part #	Mfg #	Description	Price
126553	EM151	Single Input Electronic Manometer	

SSM1 Super Heat/Sub Cool Meter

- Measures:
 - Pressure from 0 - 500 psia
 - Temperature from -40° to 400°F
- Calculates:
 - Superheat for low side
 - Subcool for high side (TXV systems)
- Refrigerants included for calculations: R-22, R-134a, R-404A, and R-410A
- 1-Year limited warranty



Part #	Mfg #	Description	Price
133479	SSM1	Super Heat/Sub Cool Meter	

Electrical Testers

PET1 Pocket Electrical Tester

The PET1 features:

- Worklight
- Non-contact AC voltage test from 12-600VAC (with adjustable sensitivity)
- Detects high and low AC voltage
- Continuity check: 0-80 megohms
- Audible/visual indicators
- 3-Year limited warranty



Part #	Mfg #	Description	Price
083035	PET1	Volt Tester w/Light	

Tools

HVAC Testing Tools

Meters

Economy Auto-Ranging Clamp-On Meter

- Reads volts, amps and ohms
- Data hold and continuity buzzer
- CAT II
- Includes carrying case



Part #	Mfg #	Description	Price
111388	MA-600CF	Temp Range: -38° to 1,750°F	

Oil & Glycol Refractometer



Part #	Mfg #	Description	Price
111392	MA-REF401F	Glycol Fahrenheit Refractor	

Tools

HVAC Testing Tools

Electrical Testers

Non-Contact Voltage Tester

- High intensity, bright green LED indicator when on
- High intensity, bright red LED indicator when voltage is detected
- Package contains insert card with integrated owner's manual and (2) AAA 1.5V batteries



Part #	Mfg #	Description	Price
125141	NCVT-1	50 - 1000VAC	

Dual Range Non-Contact Voltage Tester

- Automatically detects and indicates:
 - Low voltage (12-48VAC)
 - Standard voltage (48-1000VAC)
- High intensity, bright green LED indicates the tester is operational and aids in illuminating the workspace
- Digitally controlled ON/OFF power button
- Auto power-off feature conserves and extends battery life
- Microprocessor controlled low-battery indicator
- CAT IV 1000V Rating
- Lightweight, durable polycarbonate plastic resin construction; convenient pocket clip



Part #	Mfg #	Description	Price
137459	NCVT-2	50 - 500Hz	

Clamp Meters

CL200 Professional Series Clamp Meter

- Worklights illuminate dark work spaces
- Backlit display
- Data hold captures measurements in any situation
- Diode and continuity tests
- Includes test leads, batteries, case and thermocouple
- Measures temperature, frequency and capacitance
- 8.2"H x 3"W x 1.4"D



Part #	Mfg #	Description	Price
140679	CL200	1" Jaw, 600A AC w/Thermocouple	

HVAC Testing Tools

Meters

TurboMeter™

Part #	Mfg #	Description	Price
106684	439103	Air Velocity Meter	

Differential Pressure Meter

- Includes protective cap, batteries and calibration certificate
- Display in Pascal optional over entire measurement range
- Temperature compensation
- Magnetic back permits free-hand work
- Accuracy: ± 0.01 "H₂O (0 to 0.12 "H₂O) / ± 0.02 "H₂O (0.13 to 0.4 "H₂O)
- Flow velocity measurement with Pilot tube (Pilot tube not included in delivery)
- Air density compensation
- Includes:
 - Protective cap for safe storage
 - (2) Type AAA Batteries, 50 hour life
 - Including wrist strap and belt clip



Part #	Mfg #	Description	Price
142784	875044	Digital Differential Pressure Meter	

Tools

Knives & Replacement Blades

Utility Knives

Lenox® Gold™ Quick Change Knife



20353



GOLD5C, GOLD50D



20354

Part #	Mfg #	Description	Price
084422	20353-SSRK1	Retractable Blade Knife with (3) Blades	

Blades

Part #	Mfg #	Description	Price
084423	20350-GOLD5C	Replacement Blades, 5/Pk	
089119	20351-GOLD50 D	Replacement Blades, 50/Pk	

Lenox® Gold™ Locking Tradesman Utility Knife

- Easy open and close secure locking mechanism
- Ergonomic, rubberized comfort grip
- Multi-use tool; bottle opener, screwdriver and pipe reamer
- Built-in wire stripper



Part #	Mfg #	Description	Price
105776	10771	Locking Tradesman Utility Knife	

Tools

Knives & Replacement Blades

Utility Knives and Knife Blades

Quick Open Utility Knife

- Retractable blade
- Integrated hinge



Part #	Mfg #	Description	Price
048168	9PK	3-Position	

Top Button Action Utility Knife

- Safe, easy to operate thumb action mechanism on top



Part #	Mfg #	Description	Price
006528	4PK	3-Position	

Mini-Knife®

- Precision cuts clean and sharp
- Includes retractable blade



Part #	Mfg #	Description	Price
006525	3PKM	Mini-Knife®	

Knives & Replacement Blades

Utility Knives

Sliding Utility Knife

- Side slide activated blade
- Rubber over mold hand grip
- On board blade storage
- Tool-free blade change
- Integrated gut hook and wire stripper



Part #	Mfg #	Description	Price
137585	48-22-1910	Sliding Utility Knife	

18mm Snap Off Knife

- Durable lock- up to 2x longer life
- Speed thread- 2x faster blade adjustment
- Microcarbide blade- up to 2x longer blade life
- Acetone resistant
- 8 Point blade



Part #	Mfg #	Description	Price
163299	48-22-1964	18mm Snap Off Knife	

Fastback™ Utility Knife

- One-handed blade opening
- Tool-free blade change
- Wire stripper
- Integrated gut hook
- Thin body design



Part #	Mfg #	Description	Price
137584	48-22-1901	FASTBACK™ Flip Utility Knife	
225380	48-22-1903	FASTBACK™ Flip Utility Knife with Blade Storage	

FASTBACK™ Smooth Folding Pocket Knife

- Press and flip operation: Permits one-handed opening
- Stainless steel drop-point blade: resharpenable edge for long lasting use
- Liner lock
- Slim, compact body: stores easily yet withstands job site abuse
- Piercing tip: allows controlled piercing and smooth cutting
- Lanyard hole
- Reversible wire-form belt clip



Part #	Mfg #	Description	Price
163301	48-22-1990	FASTBACK™ Smooth Folding Pocket Knife	

FASTBACK™ Spring Assisted Serrated Knife

- Spring-assisted opening: Permits one-handed operation
- Black oxide-coated stainless steel serrated blade: Maintains long-lasting sharp edge
- Liner lock
- Serrated blade: Ideal for tearing through material, Tanto tip: Ideal for piercing material
- Slim, compact body: Stores easily yet withstands job site abuse
- Reversible wire-form belt clip



Part #	Mfg #	Description	Price
162813	48-22-1995	FASTBACK™ Spring Assisted Serrated Knife	

FASTBACK™ Hawk Bill Folding Knife

- Press-and-flip operation: permits one handed opening
- Stainless steel curved blade
- Liner lock
- Slim, compact body
- Piercing tip: allows controlled piercing and smooth cutting
- Lanyard hole
- Reversible wire-form belt clip



Part #	Mfg #	Description	Price
170008	48-22-1985	FASTBACK™ Hawk Bill Folding Knife	

Knives & Replacement Blades

50 PC General Purpose Utility Blades w/ Dispenser

- *Micro carbide deposited metal delivers up to 3X longer life than standard carbon blades*
- *Precision grind process removes the burr from cutting edge for cleaner cuts*
- *Optimized grind angles deliver improved sharpness for less repeat cuts*
- *Made in the USA*



Part #	Mfg #	Description	Price
163303	48-22-1950	50 PC General Purpose Utility Blades w/ Dispenser	

Bottle Opener

- *Wire stripper- up to 12ga*
- *Chrome plated rust protection*
- *Hardened steel for durability*
- *Cushion grip handle*
- *Rear cap ID marking*



Part #	Mfg #	Description	Price
165227	48-22-2000	Bottle Opener	

Tools

Knives & Replacement Blades

Putty Knives



Part #	Mfg #	Size	Price
096245	K50-015	1-1/4"	

Knives & Replacement Blades

Knives

Lightweight Lockback Knife - Drop-Point Blade with Pocket/Belt Clip

- Blade is AUS8 stainless hardened to 58-59 Rc
- Anodized aluminum finish on handle is silver with stainless steel blade or black with black-chrome blade
- Reversible thumb stud



Part #	Mfg #	Blade Length	Color	Price
117588	44001-BLK	2-1/2"	Black	

Utility Knives

Utility Blades

- Heavy-duty razor edged reversible



Part #	Mfg #	Description	Price
125646	44101	(5) Blades	

Double-Locking Folding Utility Knife

- Blade locks in both open and closed position
- Pocket/belt clip



Part #	Mfg #	Closed Length	Overall Length	Price
125645	44108	3"	6-1/8"	

Pocket Knives

2-Blade Lockback Pocket Knife - Drop Point & Screwdriver Tip Blades

- Anodized aluminum handle
- Thumb stud
- Includes removable pocket/belt clip

Part #	Mfg #	Description	Price
117581	44008	Stainless Steel	

Tools



Knives & Replacement Blades

Utility Knives and Blades

#82 Safety Nose Retractable Blade Knife

Part #	Mfg #	Description	Price
036760	38205	Heavy-Duty Red	

Tools

Levels**Levels****Torpedo Level**

- Ideal for general use and work in tight places
- Three vials for plumb, level and 45° miter
- Full length strong magnetic edge
- V-Grooved edge for pipe and conduit work
- Large top read level vial



Part #	Mfg #	Model	Description	Price
051918	20233	395	9" Nightshade Level	

Tools

Levels

Levels

Torpedo Level

- Aluminum construction
- Professional quality



Part #	Mfg #	Description	Price
110080	J40-100	7-1/2" Length, Magnetic Sides	

Levels

Levels

Pocket Level



- Strong molded plastic frame with pocket clip
- Multi view vial reads top, bottom or side
- Ideal for leveling thermostats

Part #	Mfg #	Length	# of Vials	Price
006443	L5	5"	1	



Levels

Levels



Part #	Mfg #	Description	Price
008910	R148700	ML-24	

Levels

Torpedo Levels

Aluminum Level

- *Lightweight, precision made*
- *Acrylic plastic yellow vials*



Part #	Mfg #	Description	Price
110504	930-9	9" Level, Plumb & 45°	

Heavy-Duty Level with Magnet

- *Allows hands-free measurements on iron or steel surfaces*
- *Features Rare Earth magnets and vial frames with E-Z-See™ glow-in-the-dark-material*



Part #	Mfg #	Description	Price
111224	931-9RE	9" Level, Plumb & 45°	

Torpedo Level

- *Large, high visibility vials are easy-to-read*
- *Rare Earth magnet*
- *Vials set for measurements at 0°, 30°, 45° and 90°*
- *Machined billet aluminum design*
- *High contrast laser etched markings*



Part #	Mfg #	Description	Price
125146	932-9RE	9" Level, Plumb, 30°, & 45°	

Tools

Miscellaneous Tools

Maxstraps

The Original 1" Polypropylene Cam Tiedown

- Ideal for lumber, pipe, ladders, and outdoor gear
- Weather and sunlight resistant
- 750 lb Test
- Rustproof cam buckle
- Easy thumb release



Part #	Mfg #	Description	Price
053091	00216	2' Black	
053093	00411	4' Red	
053094	00612	6' Yellow	
053095	00813	8' Green	
053096	01014	10' Blue	

Miscellaneous Tools

Utility Strap

Rubber Tie Down Strap

- Stretches to double its length
- Extra heavy steel S-hooks on each end



Part #	Mfg #	Description	Price
002270	540-31	31" Rubber Strap	

Fin Tools

Fin Whisk

- Plastic handled whisk for cleaning condenser and evaporator fins



Part #	Mfg #	Description	Price
141528	B-26	Fin Whisk Brush	

Tools

Miscellaneous Tools

Refrigerant Tools

Fin Tool Kit



Part #	Mfg #	Description	Price
130934	875001	Fin Tool Kit - 8, 9, 10, 11, 12, 14 Fin Heads	

Tools

Miscellaneous Tools

Telescoping Tools

Reach-It

- Retracts to 5" long, extends to 26-3/4"
- Chrome-plated brass



Part #	Mfg #	Description	Price
002268	R-1	Reach-it Tool	

Telescopic Inspection Mirror

- American made
- Double ball joint links swivel mirrors for viewing to 360°



Part #	Mfg #	Description	Price
002322	M-5	1" x 2" Oval Extends 8-1/2"	

Tools

Miscellaneous Tools

Tools

Pro-Set® Inspection Mirror



Part #	Mfg #	Description	Price
098914	87-TLMIR3	3.5" x 2.12" Rectangular Telescoping Mirror	

Batteries

Batteries - Alkaline

- Batteries all alkaline
- Attractive retail-type packaging



Part #	Mfg #	Description	Price
180520	BV900243	AA - 18 PK	
180522	BV900244	AAA - 18 PK	
180521	BV900245	9V - 4PK	

Tools



Miscellaneous Tools

Caulking Guns

Deluxe Caulking Gun

- Zinc-plated with tip-cutter and seal punch



Part #	Mfg #	Description	Price
028237	040025	Deluxe	

Tools

Miscellaneous Tools

Flue and Boiler Tube Brushes

Fine-Wire Single Spiral Brush

- For small boilers, burners, nozzles and fans
- 3" Brush lengths

Part #	Mfg #	Description	Price
007444	01216	3/4" Dia, 24" OAL 4" Loop, Carbon Steel	

Tool Cases

Stackable Utility Case

- Tough, durable, double-lock catch, 12" x 6" x 6"
- Lifetime guarantee

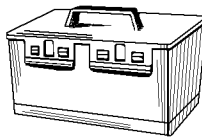

Part #	Mfg #	Description	Price
007462	75600	Tote Box - Carton	

Lock 'N Load Heavy-Duty Drybox

- Locks out moisture as well as dirt and grime
- (3) Compartments store and organize tools and accessories
- Easy access top compartment is ideal for small tools and parts
- Dimensions: 15" x 8" x 10"



Part #	Mfg #	Description	Price
061933	75605	Lock 'N Load Drybox, Carton	

Tube Cleaning Brushes

#6200 Series Power Tube Cleaning Brush

- Use for solder or brazed fittings
- Carded 1/4" hex-shank tube cleaning brushes
- Point-of-purchase display

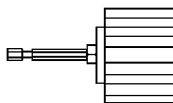

Part #	Mfg #	Description	Price
007454	62350	1/2" Bagged	
007455	62370	3/4" Bagged	

Miscellaneous Tools

Markers

Valve Action® Paint Marker

- Low chloride/low halogens paint formula
- All surface marking with durable, fade resistant, high visibility marks



Part #	Mfg #	Color	Price
057823	96801	Yellow Carded	
057825	96802	Red	
074113	96903	Black	

Tools



Miscellaneous Tools

Chemicals

Insecticide

Part #	Mfg #	Description	Price
140752	85-200	Bee/Wasp Spray	

Miscellaneous Tools

Cases & Carriers

Nipple Box

- Holds 1/2" CL through 6" nipples
- Fold away handle
- Epoxy coated steel

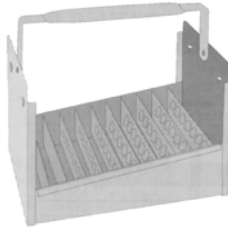

Part #	Mfg #	Size	Holds	Price
013210	3080	1/2"	77	

Tools

Miscellaneous Tools

Nipple Boxes



R317600

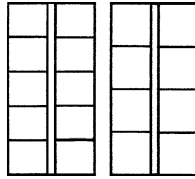

R318410

Part #	Mfg #	Description	Price
014776	R317600	E-51-R 3/4"	
094631	R318380	Ladder Mate	
080438	R318410	Galvanized Fitting Tray	

Miscellaneous Tools

Nipple Caddies

Steel Nipple Caddy Tray

- Steel construction
- Push away handles
- Baked epoxy finish
- Nipple storage range (close - 6")



Part #	Mfg #	Description	Capacity	Price
109306	N70-050	1/2" Nipple	77-Pc	
109307	N70-075	3/4" Nipple	66-Pc	
109308	N70-016	1" Nipple	50-Pc	

Internal Pipe Nipple & Screw Extractors

Internal Pipe Nipple Extractors

- Heat treated and cad plated



Part #	Mfg #	Size	Price
056472	J40-050	3/8"	
041956	J40-051	1/2"	
041957	J40-052	3/4"	

Nipple and Screw Extractor

- Left hand spiral
- Removes nipples, bolts, and screws w/o thread damage



Part #	Mfg #	Description	Price
186259	J41104	1/4" Pipe, 19/64" Drill, 3/8"-5/8" Bolt	
186926	J41106	1/2" Pipe, 17/32" Drill, 7/8"-1-1/8" Bolt	
186927	J41107	3/4" Pipe, 13/16" Drill, 1-1/8" - 1-3/8" Bolt	
186929	J41108	1" Pipe, 1-1/16" Drill, 1-3/8" - 2" Bolt	

PlumbBest Handi-Plug

- Combination test plug and stub-out for drop eared elbow
- No thread seal required
- Re-usable - long lasting
- Time and labor savings
- Smooth at thread end for easy plastering



Part #	Mfg #	Description	Price
073271	H54-050	1/2" MIP Handi-Plug	

Packing

Graphite Packing

- Non-asbestos material in resealable spools



Part #	Mfg #	Description	Price
045477	T60-005	1/8" Diameter x 12' Spool	

Utility Pry Bar



Part #	Mfg #	Description	Price
041929	S49-489	13" Utility Pry Bar	

Probing Rod

Steel Probing Rod

- Welded steel construction
- Stainless steel replaceable tip



Part #	Mfg #	Description	Price
043178	P27-004	4' Steel Probing Rod	

Caulk Guns

Drop-In Half-Barrel Type Caulk Gun

- Drop-in half barrel type
- Painted steel



Part #	Mfg #	Description	Price
021059	C35-090	9" Barrel Caulk Gun	

Caulking Tools

Inside Caulking Tool

- For finishing lead joint



Part #	Mfg #	Size	Price
053532	J41-009	5/8"W x 7"L	

Outside Caulking Tool

- For finishing lead joint



Part #	Mfg #	Size	Price
053533	J41-010	5/8"W x 7"L	

Miscellaneous Tools

Caution Tape

- Black print on safety yellow
- 3 mil Thickness



Part #	Mfg #	Size	Price
041971	J43-300	3" x 300'	

Knee Pads

Heavy Duty Foam Economy Knee Pads

- Lightweight and water-resistant
- Comfortable while kneeling, standing or walking
- Won't pinch or bind behind knee
- Soft, breathable inner lining for coolness and comfort
- Velcro closures on straps



Part #	Mfg #	Description	Price
224085	K01120	1 Per Pack	

Shop Towels

Terry Towels

- Cotton Terry Cloth



Part #	Mfg #	Description	Price
224076	B05-025	(3) Pack	

Cotton Plumbers Handy Towel

- Heavy-duty shop towels
- Washable, reusable and non-abrasive



Part #	Mfg #	Description	Price
069432	B05-004	(12) Towels per Bag	

Wypall® Teri® Towel

- Strong and durable, wet or dry
- Reusable
- Equivalent to 18 lbs of rags
- Reinforced HYDROKNIT® provides extra scrubbing power

Part #	Mfg #	Description	Price
107287	B05-003	(125) Sheets per Box	

Box of Rags

- Colored cotton sweatshirt material
- 100% Recycled
- Pull-out dispensing



Part #	Mfg #	Description	Price
041975	B05-001	5 lb Box of Rags	

Heavy Duty Big Wipes

- 80 Count
- 8" x 12" wipes
- Removes paint, glue, oil, sealants, grease, and grime
- Dermatologically tested, plus Vitamin E and Aloe Vera added
- Dual sided, scrubs and cleans



Part #	Mfg #	Description	Price
186715	B05050	80 Count tub	

Trash Bags

- 2'8"x 4'2"
- 20 bags per box
- 42 gal
- 3 mil



Part #	Mfg #	Description	Price
181931	G02042	42 Gallon Trash Bags	

Marking Paints

- Inverted tip
- Water base formula
- Fast-drying and non-clogging
- Color-coded paint:
 - White for general purposes
 - Red for electric and fire protection systems
 - Blue for water and irrigation
 - Orange for telephone, telegraph and cable TV systems



Part #	Mfg #	Color	Price
043622	J40-380	White	
041973	J40-381	Yellow	
041974	J40-382	Red	
043621	J40-383	Blue	
095800	J40-385	Orange	

Miscellaneous Tools

Sponges and Brushes

Commercial Grade Cellulose Sponge

- Deeply textures
- Made in USA

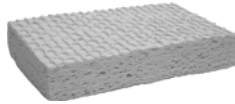

Part #	Mfg #	Description	Price
093645	S50-002	Large, 8" x 4-1/2" x 3/4"	

Show Handle Wire Brush w/ Scraper

- 4x16 rows
- Removes rust and corrosion from metals
- Oil tempered carbon steel wire tynes
- Smooth sanded hardwood block



Part #	Mfg #	Description	Price
190129	B29902	Show Handle, 4x16 rows	

Bucket Caddies



Part #	Mfg #	Description	Price
084476	T60-102	5 Gallon Bucket, (1) Large & (4) Small Trays	
126414	T60-105	Lid for 5 Gal Bucket	
129190	T60-106	5 Gallon Bucket	
229436	T60-111	5 Gallon Bucket, (3) Large Trays	

Miscellaneous Tools

Tool Holders

Tape Measure Holder - Powerline™ Series

- Holds most tape measures with belt clips
- Rust-resistant metal clip riveted for strength
- Tunnel belt connection up to 2-1/4" belt width
- 1000 Denier DuPont Cordura® nylon
- Washable

PowerLine™ Series



Part #	Mfg #	Overall Size	Price
110786	5707	4-1/8" x 3-3/4"	

Zipper Canvas Bag

- Constructed of No. 8 canvas



Part #	Mfg #	Description	Price
107648	5140	Set of 4, 7" x 12-1/2", Olive, Orange, Royal Blue, and Yellow	

Tool Bags

Tool Organizer

- Constructed of double-layered 600 x 300 denier polyester
- Water-resistant
- Interior pockets include:
 - (3) Tool sleeves
 - (1) Power tool/cord sleeve
 - (6) Universal pockets
- Exterior pockets include:
 - (9) Screwdriver/nut driver pockets
 - (11) Plier pockets
 - (11) Utility pockets
 - (2) Wire stripper pockets
 - (2) Velcro® closable pockets
- Heavy-duty webbing keeps pockets open for easy access to supplies and tools
- Tools are sold separately



Part #	Mfg #	Description	Price
106843	5777	Tool Organizer 45 Pockets	

Tools

Miscellaneous Tools

Carrying Cases and Bags

Organizer Bag



Part #	Mfg #	Use with:	Price
145691	49-17-0110	Contractor Parts Organizer	

Zipper Pouch

- Rugged metal zipper
- Water resistant stand-up base
- Hang loop
- Constructed of heavy duty No. 10 canvas



Part #	Mfg #	Description	Price
170552	48-22-8180	Zipper Pouch	

3 PK Zipper Pouches

- Rugged metal zipper
- Water resistant stand-up base
- Hang loop
- Constructed of heavy duty No. 10 canvas



Part #	Mfg #	Description	Price
170554	48-22-8193	3 Pk Zipper Pouches	

Jobsite Organizer

- Mountable Bins
- Full Access When Stacked
- 20% More capacity
- Weather Seal
- No-travel bins seals



Part #	Mfg #	Description	Price
176587	48-22-8030	14"x18"x5" Tool Organizer	

Job site Backpack

- 35 Pockets for organizing tools
- Impact resistant molded base
- 1680 Ballistic material
- Load-bearing harness- padded and breathable for all day comfort
- Laptop sleeve- holds laptops up to 15.6"
- Bulk pocket- quick access to bulk items such as fish tapes and power tools
- Attachment strap- allows bag to be easily and securely attached to vertical handles



Part #	Mfg #	Description	Price
170551	48-22-8200	Job site Backpack	

Contractor Work Belt w/ Suspension Rig

- 24 Pockets for organizing tools
- 1680D Nylon construction
- Riveted seams
- All metal hardware
- Integrated carry handles
- Puncture resistant pocket
- Padded work belt- Fits 30" to 53" waists
- Smart phone pocket



Part #	Mfg #	Description	Price
170550	48-22-8120	Contractor Work Belt w/ Suspension Rig	

Electricians Work Pouch w/ Quick Adjust Belt

- 15 Pockets for organizing tools
- 1680D Nylon construction
- Riveted seams
- All metal hardware
- Integrated carry handle
- Stable base- Allows pouch to stand upright on flat surfaces
- Puncture resistant pocket
- Tape measure clip
- Belt slot- fits up to a 3" work belt
- Quick adjust belt



Part #	Mfg #	Description	Price
170548	48-22-8100	Electricians Work Pouch w/ Quick Adjust Belt	

Miscellaneous Tools

Electricians Work Belt

- 29 Pockets for organizing tools
- 1680D nylon construction
- Riveted seams
- All metal hardware
- Integrated carry handles
- Stable base- Allows pouches to stand upright on flat surfaces
- Puncture resistant pocket
- Tape measure clip
- Belt slot- Fits up to a 3" work belt



Part #	Mfg #	Description	Price
170549	48-22-8110	Electricians Work Pouch w/ Quick Adjust Belt	

26" Job site Work Box

- Impact resistant construction
- Buttressed hinges
- Protected recessed latches
- Reinforced corners
- Integrated weather seal
- Clamping cut groove
- Over molded wide grip handle
- Pass through side grips
- Integrated screw mounting bosses
- Corner pocket storage
- Space for long and bulky tools
- Indexing square
- Made in USA



Part #	Mfg #	Description	Price
170622	48-22-8020	26" Job site Work Box	

M12™ Tool Holster

- Heavy duty nylon material
- Easy snap-on
- On board bit storage
- Compatible with most M12™ drilling and fastening tools



Part #	Mfg #	Description	Price
151175	2335-20	2335-20 M12 Tool Holster	

13" Job site Work Box

- Impact resistant construction
- Vertical tool storage tray
- 16" Seat height
- Cut groove
- Wide grip locking handle
- Drip ledge lid
- Indexing square
- Made in USA



Part #	Mfg #	Description	Price
170620	48-22-8010	13" Job site Work Box	

Milwaukee® Markers

INKZALL® Black Fine Point Marker

- Clog resistant marker tip
- Writes through dusty, wet and oily surfaces
- Durable marker tip for writing on concrete, OSB and rough surfaces
- Built-in hard hat storage clip
- Fine point
- Ink dries in seconds
- Lanyard hole
- Anti-roll body design
- Non-toxic ink



Part #	Mfg #	Description	Price
165641	48-22-3100	INKZALL® Black Fine Point Marker	

1PK Med. Chisel Black Marker

- Clog resistant chisel tip marker
- Writes through dusty, wet, and oily surfaces
- Durable marker tip for writing on concrete, OSB, and rough surfaces
- Built-in hard hat storage clip



Part #	Mfg #	Description	Price
171183	48-22-3103	1Pk Med. Chisel Black Marker	

Miscellaneous Tools

2 Pack Fine Point Black

- Clog resistant marker tip
- Writes through dusty, wet, and oily surfaces
- Durable marker tip for writing on concrete, OSB, and rough surfaces
- Built-in hard hat storage clip



Part #	Mfg #	Description	Price
171184	48-22-3105	2PK Fine Point Black Markers	

INKZALL® Stylus & Black Marker

- Conductive stylus tip
- Clog resistant marker tip
- Writes through dusty, wet and oily surfaces
- Durable marker tip for writing on concrete, OSB and rough surfaces
- Built-In hard hat storage clip
- Fine point
- Ink dries in seconds
- Lanyard hole
- Anti-roll body design
- Non-toxic ink



Part #	Mfg #	Description	Price
165228	48-22-3101	INKZALL® Stylus & Black Marker	

4PK Fine Point Colored Markers

- Clog resistant marker tip
- Writes through dusty, wet, and oily surfaces
- Durable marker tip for writing on concrete, OSB, and rough surfaces
- Built-in hard hat storage clip



Part #	Mfg #	Description	Price
171185	48-22-3106	4PK Fine Point Colored Markers	

Tape Measure

- Nylon bond blade protection
- 5-Point reinforced frame
- Finger stop- Protects finger during blade retraction
- Blueprint scale- Calculated 1/4" and 1/8" drawings
- Wire form belt clip- Reduces pocket tearing
- 2-Sided printing- Increases measurement readability
- Up to 9' stand out
- 360 Degree hook attachment



Part #	Mfg #	Description	Price
168290	48-22-5117	16' Tape Measure	
168291	48-22-5126	25' Tape Measure	
168292	48-22-5131	30' Tape Measure	
169837	48-22-5136	35' Tape Measure	

Magnetic Tape Measure

- Nylon bond blade protection
- 5-point reinforced frame
- Finger stop- protects finger during blade retraction
- Dual magnets- prevents roll off when measuring steel studs, EMT and threaded rod
- Blueprint scales- calculates 1/4" and 1/8" drawings
- Wire form belt clip- reduces pocket tearing
- 2 Sided printing- increases measurement readability
- 360 Degree hook attachment



Part #	Mfg #	Description	Price
159975	48-22-5116	16' Magnetic Tape Measure	
159976	48-22-5125	25' Magnetic Tape Measure	

Miscellaneous Tools

Bucket Organizers

- High-impact plastic pail
- Storage trays fit snugly inside
- Easy on/off lid



Part #	Mfg #	Bucket	Trays:	Price
008175	502	5 gal	2 Large & 2 Small	

Bucket Organizer Pail Lid

- Fits both 3.5 and 5 gallon pails

Part #	Mfg #	Description	Price
059482	001	Lid Only	

Miscellaneous Tools

Tie Downs

EPDM Tie-Down Strap

- Super-strong 100% EPDM material with 2-1/2" galvanized S hooks



Part #	Mfg #	Max Length	Length	Price
183405	319-15	22"	15"	
183406	319-20	30"	20"	
183407	319-31	45"	31"	

Extendable Inspection Mirror with Angle Ball Joint

- Pocket clasp included
- Powerful long life magnetic tip



Part #	Mfg #	Size	Extension	Price
156742	390-50115	1" x 2"	5-5/8"-18-3/4"	

Tools

Pipe Cutters - Copper

Tubing Cutters

Close Quarters Tubing Cutter

- Use in restricted spaces on small diameter, hard and soft copper, aluminum, brass and plastic tubing
- Large knurled feed screw knob



Part #	Mfg #	Model	Capacity	Description	Std Wheel	Price
008659	32975	103	1/8" - 5/8"	Cutter	E-3469	
008660	32985	104	3/16" - 15/16"	Cutter	E-3469	
067702	97787	117	3/16" - 15/16"	Quick-Feed Cutter	E-3469	
051432	86127	118	1/4" - 1-1/8"	Quick-Feed Cutter	E-3469	

Constant Swing Cutter with X-CEL

- Features an enclosed feed screw to eliminate clogging and jamming, grooved rolls for close-to-flare cuts, and a fold-away reamer
- Made from high-strength aluminum alloy



Part #	Mfg #	Model	Capacity	Description	Std Wheel	Price
008687	31622	150	1/8" - 1-1/8"	Feed Cutter	E-3469	
008688	31627	150	1/8" - 1-1/8"	Feed Cutter with HD Wheel(s)	E-4546	

Tubing and Conduit Cutter with X-CEL

- Clean, square cuts on copper, brass, aluminum, and thin-wall conduit



Part #	Mfg #	Model	Capacity	Description	Std Wheel	Price
008655	32910	10	1/8" - 1"	Screw Feed Cutter	F-158	
008648	32920	15	3/16" - 1-1/8"	Screw Feed Cutter, Fold-Away Reamer	F-158	
008703	32930	20	5/8" - 2-1/8"	Screw Feed Cutter, Fold-Away Reamer	F-158	
008713	32940	30	1" - 3-1/8"	Screw Feed Cutter f/Lg Dia Steel & SS Tube	F-158	

Quick-Acting Tubing Cutter with X-CEL

- I-Beam construction, hardened wear surfaces and bearing side assemblies for smooth operation
- Plastic cutters include spare cutting wheel for cutting copper



Part #	Mfg #	Model	Capacity	Description	Std Wheel	Price
008689	31632	151	1/4" - 1-5/8"	Quick-Acting, Fold-Away Reamer	E-3469	
008690	31642	152	1/4" - 2-5/8"	Quick-Acting, Fold-Away Reamer	E-3469	
008691	31652	154	1-7/8" - 4-1/2"	Quick-Acting Tubing Cutter	E-2558	

Pipe Cutters - Copper

Internal Tubing Cutter

- For trimming tubing below floor level for shower and floor drain installations, or above the ceiling for sprinkler head installations



Part #	Mfg #	Model	Capacity Nom / Depth	Description	Std Wheel	Price
018338	33005	106	2" - 3" / 1/4" - 2-5/8"	Internal, Steel & Aluminum Body	E-2558	

Tubing Cutter Wheel



Part #	Mfg #	Model	Blade Exp	Application	For Model	Price
008575	33165	E-1240	.162	Steel - SS	10, 15, 15-SI	
008596	33175	E-2191	.292	HD Steel Tubing	30, 40, 122, 122XL, 133, 154, 156	
008599	33170	E-2558	.220	Aluminum & Copper	30, 40, 108, 109P, 133, 154, 156	
023461	34695	E-3495	.290	Aluminum	151, 152, 153, 205	
008617	33190	E-4546	.162	Steel - SS	151, 152, 153, 205	
008606	33185	E-3469	.149	Copper, Aluminum, Brass & Plastic	101,103,104,117,118,150,151,152,153,205	
008636	33160	F-158	.149	Aluminum & Copper	10,15, 20	

Tubing Cutter Parts

Part #	Mfg #	Description	For Model	Price
129719	34620	Roll Housing Screw	20	
024438	42327	Retaining Ring	101, 103, 104, 117 & 118	

Tubing Tools

456 Tri-Bender

- Ideal for plumbing and HVAC applications
- 90° Start angle minimizes effort required to form a bend
- Handy reference marks indicate the angle for quick bends through 90°



Part #	Mfg #	Model	Capacity	Price
008738	44852	456	1/4", 5/16", 3/8"	

Spring-Type Tube Bender

- Fast, free-form bending of soft copper and aluminum tube



Part #	Mfg #	Model	Length	Tube OD	Price
008563	35255	D-1377	10"	3/8"	

Tools

Pipe Cutters - Copper

Tubing Cutters

Tubing Cutters Ergonomically Designed for Professional Performance

- Professional deburring
- Will not damage cutting wheel
- Easy to use - change out wheels with only a screwdriver



Part #	Mfg #	Tube Diameter Range	Price
077287	21010-TC11/8	1/8" - 1-1/8"	
077288	21011-TC13/8	1/8" - 1-3/8"	
077289	21012-TC13/4	1/8" - 1-3/4"	
077290	21013-TC25/8	1/4" - 2-5/8"	

TSK Tight Space Tubing Cutter Kit

- Shock-resistant steel
- Non-slip grooved cast body
- 1/2" Clearance to cut
- Stainless steel rollers



Part #	Mfg #	Description	Price
140248	14833-TSK	3 Piece Tight Space Tube Cutter Kit	

Cutter Wheel



Part #	Mfg #	Description	Price
147940	14829-TSB	Copper Wheel for TS Cutter, 2-Pk	
077291	21015-TCW158 SS	Stainless Steel Cutting Wheel, 6-Pk	
089118	21017-TCW158 C	Copper Cutting Wheel, 6-Pk	
087125	21192-TCW158 C2	Copper Cutting Wheel, 2-Pk	

Tools

Pipe Cutters - Copper

Copper Tubing Cutters Close Quarters Tubing Cutter

- Most compact
- Longest life
- Chrome rollers
- Weep holes
- Directional grip
- Replaceable blade



Part #	Mfg #	Description	Price
225206	48-22-4260	1/2" Close Quarters Tubing Cutter	
225207	48-22-4261	3/4" Close Quarters Tubing Cutter	
225208	48-22-4262	1" Close Quarters Tubing	

3pc Close Quarters Tubing Cutter Set

- Most compact
- Longest life
- Chrome rollers
- Weep holes
- Directional grip
- Replaceable blade
- Includes:
 - (1) 1/2" Close quarters tubing cutter (48-22-4260)
 - (1) 3/4" Close quarters tubing cutter (48-22-4261)
 - (1) 1" Close quarters tubing cutter (48-22-4262)



Part #	Mfg #	Description	Price
225209	48-22-4263	3pc Close Quarters Tubing Cutter Set	

2pc Close Quarters Cutter Replacement Blades

- Replacement cutter wheels
- Designed for use with Milwaukee® close quarters tubing cutters
- Two pack
- High carbon steel blades
- Precision machined
- Optimized for copper



Part #	Mfg #	Description	Price
225210	48-22-4266	2pc Close Quarters Cutter Replacement Blades	

Tools



Pipe Cutters - Copper

Autocut™ Copper Tubing Cutters



ATC



RH

Part #	Mfg #	Description	Price
031428	ATC12	For 1/2" Tubing	
031429	ATC34	For 3/4" Tubing	
073599	ATC100	For 1" Tubing	
031674	RH12	Ratchet Handle for ATC12	
031675	RH34	Ratchet Handle for ATC34	
031430	ATCW	Replacement Cutter Wheels	

Tools

Pipe Cutters - Copper

Tube Benders

Tri-Tube Bender

- Indicators on handle help identify tube sizes
- Color-coded to help spot the right tube size
- Indicators on side help measure the bend radius, up to 180°



Part #	Mfg #	Description	Price
167766	1839026	1/4", 5/16", 3/8"	
171454	1839027	1/4", 3/8", 1/2"	



Pipe Cutters - PEX

Tubing Cutters

ProPEX®/Tubing Cutter

- Replaceable blades
- Double ground steel V-shaped blade
- Metal core - indestructible frame
- Rework groove
- One-handed locking mechanism
- Rust protection



Part #	Mfg #	Description	Price
143343	48224200	Cuts up to 1" Tubing	

ProPEX®/Tubing Cutter Replacement Blade

- Double-Ground V-Shaped Blade (Patent Pending)
- Cleaner Cuts on 1" rubber and plastic tubing/PEX-a tubing
- Rust protection - stainless design for increased tool life and corrosion resistance



Fits 48-22-4200 and 48-22-4202 Milwaukee® Tubing Cutters

Part #	Mfg #	Description	Price
170838	48224203	Replacement Blade	

Tools

Pipe Cutters - Plastic

Plastic Tubing Cutters
Quick-Acting CSST Cutter

- I-Beam frame
- Cuts corrugated gas tubing 3/8" - 1"
- Two sets of split-floating guide wheels
- Ergonomic knob
- Full lifetime warranty



Part #	Mfg #	Model	Capacity	Description	Std Wheel	Price
122158	32078	151 CSST	3/8" - 1"	Quick-Acting CSST Cutter	33190	

Plastic Pipe Tubing Cutter

- Designed for quick, clean cuts through plastic pipe and tube



PC-1375



RC-1625



Part #	Mfg #	Model	Capacity	Description	Std Wheel	Price
104549	23493	PC-1375	1/8" - 1"	Single Stroke Plastic Pipe & Tubing Cutter	X-CEL™ PCB-1375	
108391	23498	RC-1625	1/2" - 1-5/8"	Ratchet Action Plastic Pipe & Tubing Cutter, Erg Grip	27858	
119754	30088	RC-2375	1/2" - 2-3/8"	Ratchet Action Plastic Pipe & Tubing Cutter, Erg Grip	30093	

P-TEC 2550 Tailpiece Extension Cutter

- For thin-wall plastic tube
- Undercounter specialty tool for polyethylene, polypropylene and thin-walled PVC disposer kits, tailpieces and wall tube
- Clean automatic deburring
- Automatic beveling



Part #	Mfg #	Model	Description	Price
132413	34943	P-TEC 2550	Tailpiece Extension Cutter	

Cutter Replacement Blade

Part #	Mfg #	Model	Description	Price
008706	22086	1493	Replacement Blade with Clip	
104550	25588	PCB-1375	X-CEL™ Replacement Blade	
132081	27858	RCB-1625	Replacement Blade for RC-1625	
123436	30093	RCB-2375	Replacement Blade for RC-2375	
008565	92170	138	Replacement Blade for 91125	

Plastic Tubing Cutter Wheel



Part #	Mfg #	Model	Blade Exp	Application	For Model	Price
008626	33195	E-5272	.290	PVC, ABS, Standard Wall	151-P, 152-P	
008627	33180	E-5299	.412	PVC, ABS, Standard Wall	30P - 133P, 106, 108, 109P, 154-P, 156-P	

Tools

Pipe Cutters - Plastic

Big Nipper™

- Cuts hose and tubing up to 2-1/2" ID, polyethylene up to 1-1/2" ID, and PVC up to 1-1/2" ID
- Excellent for cutting tubing insulation
- Replaceable stainless steel blade
- Clean cut - no burrs or sawdust replaceable blades



Part #	Mfg #	Description	Price
112016	16368	Big Nipper Cutter	

Li'l Nipper™

- Cuts up to 1-1/4" polyethylene, PVC, ABS, and rubber hose
- Cutters are light and can be handily carried in back pocket or tool pouch
- Strong nylon handle with replaceable blades
- Cutters do not distort pipe



Part #	Mfg #	Description	Price
002266	0125	Li'l Nipper™ Cutter	
026128	0127	2 Replacement Blades	

Tools

Pipe Cutters - Plastic

PVC Cutters

PVC Cutter

- *Makes clean burr-free cuts*
- *Reversible blade*
- *Handle latch keeps tool closed*



Part #	Mfg #	PVC Capacity	Flex Pipe Capacity	Price
125142	50506	3/4" Sch 40	1-3/8"	

PVC Cutter Replacement Blade



Part #	Mfg #	Description	Price
141615	50549	Blade for 50506	

Tools

Pipe Cutters - Plastic

Pipe/Tubing Cutters

Professional PVC Pipe Cutter

- Rustproof
- Non-electro nickel-plated blade
- Locking hook can be used to debur pipe
- Carded



Part #	Mfg #	Description	Price
054586	P70-018	1-1/4" PVC Pipe Cutter	

PVC Pipe Cutter

- High carbon steel blades
- Aluminum alloy handles
- Ratchet action



Part #	Mfg #	Description	Price
040773	P70-001	1" Pipe Cutter	
071043	P70-002	2" Pipe Cutter, Heavy-Duty	

PlumBest E-Z Shear Inside Pipe Cutter

- Cuts PVC and ABS pipe
- High speed steel blade with zinc-plated shaft



Part #	Mfg #	Description	Price
026324	J40-830	E-Z Shear Pipe Cutter	
026325	J40-831	(2) Replacement Blades	

Socket Saver

- Removes Sch 40 plastic pipe from plastic fittings
- Cuts ABS or PVC DWV pipe below slab
- Fits 1/2" variable speed power drill



Part #	Mfg #	Description	Price
082721	J44-075	3/4" Ram Bit Cutter	
054591	J44-150	1-1/2" Socket Saver	
054592	J44-200	2" Socket Saver	
054593	J44-300	3" Socket Saver	
054594	J44-400	4" Socket Saver	

Pipe Cutters - Plastic

Tube and Pipe Cutters

Inside Pipe Cutter

- Steel blade for plastic pipe
- Abrasive disc for plastic or steel pipe



390-50163

Part #	Mfg #	Steel Blade Size	Price
035402	390-50163	1-1/4"	
035403	390-50164	1-1/4" Hardened	

PowerPEX Crimp Tools (Complete Line of ASTM F1807 Options)

- Complete line of F1807 crimp tool options below:
- Steel or composite handles
- Composite handles are strong and durable, yet lightweight
- Compact tools allow one-hand crimping
- Combo tool for the most common crimp connections and added cost savings
- Free Go/No-Go gauge provided with every model
- Also work on PB 1380 tube and fittings



305-23CPK

Composite Handle

Part #	Mfg #	Description	Length	Price
183403	305-23CPK	1/2" Over-3/4" Combo	14"	

Plactic Tube and Hose Cutter

- Quickly cut PEX, PVC, CPVC and other poly pipe or non-metallic hose
- For 1 1/8" O.D. tube or smaller



304-08

Part #	Mfg #	Blade Length	Price
160228	304-08	2-1/4"	

Tools

Pipe Cutters - Copper

Plastic Tubing Cutters

S1 Plastic Tubing Cutter

- Serrated stainless steel blade requires less force to make a cut
- Rubberized handles
- Easy open and close
- Conveniently positioned locking latch allows for one-handed operation of spring-loaded cutter



Part #	Mfg #	Description	Price
121471	12121S1	1" Nom - 1-5/16" Max OD	
121472	12125S1B	S1 Replacement Blade	

Plastic Tubing Cutter Wheel



Part #	Mfg #	Description	Price
081771	21016-TCW158 P	Plastic Cutting Wheel, 6-Pk	

Tools

Pipe Cutters - Soil Pipe

Soil Pipe Cutters

- Provides 1-stroke cutting of 1-1/2" to 6" service weight, No-Hub® soil pipe, clay, asbestos and cement pipe



Part #	Mfg #	Model	Pipe Capacity	Description	Price
008709	32900	246	1-1/2" - 6"	Cuts Clay, Cast Iron, Cement Pipe, 4" Class 22 Water Main	

Tools

Pipe Cutters - Steel

Pipe Cutters

Heavy-Duty Pipe Cutter

- Fast, clean pipe cutting by hand or power
- Extra-long shank protects adjustment threads, while an extra-large handle is provided for quick, easy adjustment
- Can be converted to 3-wheel cutter by replacing rollers with cutter wheel



Part #	Mfg #	Model	Pipe Capacity	Description	Price
008701	32820	2-A	1/8" - 2"	Heavy-Duty Pipe Cutter	

Pipe Cutter Replacement Wheel



Part #	Mfg #	Model	Blade Exp	Application	For Model	Price
008732	44185	E-1032	.450	Steel & Ductile Iron	202, 360, 732, 820/364	
008641	33105	F-3	.312	Steel & Ductile Iron	1A, 2A, 42A, 202, 360, 732, 820/364	
008637	33125	F-229	.411	Steel & Ductile Iron	3S, 4S, 44S, 466C/S/HWS, 468C/S/HWS, 472C/S/HWS, 764	
008643	33100	F-514	.312	Steel & Ductile Iron	1A, 2A, 42A, 202, 360, 732, 820/364	

Pipe Cutter Parts

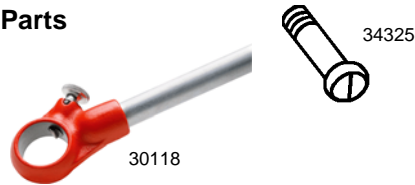

Part #	Mfg #	Model	Description	For Model	Price
008664	30118	E-3055X	Ratchet with Handle	12-R	
008720	32142		Wheel Pins with Clip, 5/Pk	151-P, 152, 152-P, 152-PVC, 153, 153-P	
008574	33970	E-1189X	Rings with Pin, 5/Pk	101, 103, 104	
008590	34325	E-1948	Screws, 10/Pk	10, 15, 15-SI	
008638	34805	F-255	Roller, 5/Pk	15	
129720	34825	F-266	Roller, 5/Pk	20	

Tools

Pipe Cutters - Plastic

Pipe Cutters Inside Pipe Cutter

- Cuts 2" and larger plastic pipe
- Fits electric drill

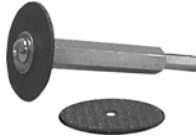

Part #	Mfg #	Description	Price
053717	P70-029	(3) Replacement Blades	

Tools

Pipe Taps

Machine Screw Tap - Plug Style



Part #	Mfg #	Description	Price
141468	R305100	WC10 1/4-20 N.C.	

Pipe Taps

Pipe Taps

Pipe Tap



Part #	Mfg #	Size	Price
056686	T41-001	1/8"	
056687	T41-002	1/4"	
041961	T41-004	1/2"	
041962	T41-005	3/4"	
050029	T41-006	1"	
056690	T41-008	2"	

Tools

Pipe Threaders

Pipe Tools
Pipe Reamer

- All reamers include handles



Part #	Mfg #	Model	Capacity	Description	Price
008702	34955	2-S	1/4" - 2"	Spiral Ratchet	

Inner-Outer Reamer

- Plastic construction with long-wearing alloy steel blades



Part #	Mfg #	Model	Description	Construction	Price
017583	34965	127	1/4" - 1-1/2" Nominal Water Tube	Plastic	

Hardened Steel Inner-Outer Reamer

- Hardened steel construction
- 46 Cutting edges on interior cone
- For fast, clean, inner reaming and outer deburring/beveling of 1/2"-2" copper and stainless steel tubing



Part #	Mfg #	Model	Description	Construction	Price
111700	29993	227S	1/2" - 2" Copper & SS Tubing	Hardened Steel	

Deburring Tool

- For plastic pipe and tubing
- Made of high-grade steel with long-lasting cutting edges
- Ideal for removing outside ridges and inside burrs on plastic pipe and tubing



Part #	Mfg #	Model	Capacity	Plastic Cap ID	Price
033796	64967	74	4"	--	

Individual Pipe Extractor

- Easily removes broken threaded ends of pipe, pipe plugs and fittings
- Each is plainly marked showing drill size used when solid ends of plugs and fittings must be drilled to receive extractor



Part #	Mfg #	Model	Pipe Size	Length Overall	Use Drill	Price
120553	35610	83	1/2"	3"	5/8"	

Tools

Pipe Threaders

Manual Threaders Manual Threader Die Head

• North American standards



Part #	Mfg #	Model	Description	Nominal Pipe Capacity	Price
008661	37040	11-R	Alloy RH	1/2"	
008672	37390	12-R	Alloy RH	1/2"	
008679	37395	12-R	Alloy RH	3/4"	
008666	37400	12-R	Alloy RH	1"	
008670	37405	12-R	Alloy RH	1-1/4"	
008668	37410	12-R	Alloy RH	1-1/2"	
008677	37415	12-R	Alloy RH	2"	

Pipe Die - National Pipe Taper NPT



Part #	Mfg #	Model	Description	Nominal Pipe Capacity	Price
008671	37825	12-R	Alloy RH	1/2" - 14	
008678	37830	12-R	Alloy RH	3/4" - 14	
008665	37835	12-R	Alloy RH	1" - 11-1/2	
008669	37840	12-R	Alloy RH	1-1/4" - 11-1/2	
008667	37845	12-R	Alloy RH	1-1/2" - 11-1/2	
008676	37850	12-R	Alloy RH	2" - 11-1/2	
008724	37920	12-R	High Speed SS RH	3/4" - 14	
008725	37925	12-R	High Speed SS RH	1" - 11-1/2	

Power Threading Equipment

Oil-Less Threading Machine Parts and Accessories

Part #	Mfg #	Model	Description	Price
032337	67822	120	Folding Stand	

Pipe Die for Machine Die Heads



Pipe Die for 504A, 711, 731, 811A, 815A and 842

Part #	Mfg #	Die Material or Type	(NPT) Nominal Pipe Size Threads Per Inch	Price
008747	47745	Alloy RH NPT	1/2"-3/4" - 14	
008748	47750	Alloy RH NPT	1"-2" - 11-1/2	

Tools



Pipe Threaders

Golden Tool™ Pipe Threaders Golden Pipe Shredder™ Kit



- 4 Shredder tools: 1-1/2", 2", 3", 4"
- 1/2" Arbor size

Part #	Mfg #	Size	Qty	Price
143396	98040	1-1/2"	4	
143394	98041	2"	4	

Tools

Pliers & Wire Strippers

Pliers

6-in-1 Long Nose Pliers

- Integrated reaming head to smooth-out rough edges of metal pipe
- High-leverage design
- (6) Applications:
 - Reaming
 - Wire stripping
 - Nail/wire cutting
 - Nail pulling
 - Pliers
 - Loop maker



Part #	Mfg #	Description	Price
150218	48-22-3068	Long Nose Pliers	

6-in-1 Combination Pliers

- Integrated reaming head to smooth-out rough edges of metal pipe
- High-leverage design
- (6) Applications:
 - Reaming
 - Wire stripping
 - Bolt cutter
 - Wire cutting
 - Pliers
 - Loop maker



Part #	Mfg #	Description	Price
149136	48-22-3069	Combination Pliers	

Tongue & Groove Pliers

- Reaming head design to smooth out rough edges of up to 2" pipe
- Forged alloy steel for maximum tool strength
- Induction hardened jaws
- Smooth transition grips minimize wear tear and improve punchability
- Rust protection increases tool life by reducing corrosion



Part #	Mfg #	Size	Price
143342	48-22-3210	10"	
150217	48-22-3212	12"	

10" Quick Adjust Reaming Pliers

- Exposed reaming handles - up to 1" conduit (Patent Pending)
- Reaming head design- smooths out rough edges of up to 2" pipe (Patent Pending)
- Quick adjust jaws- V-groove jaws create a more precise fit with up to 2" jaw capacity
- Forged alloy steel- for maximum tool strength
- Rust protection- increases tool life by reducing corrosion
- Smooth transition grips- minimize wear tear and improve pouchability



Part #	Mfg #	Description	Price
162647	48-22-3110	10"	

Hex-Jaw Pliers

- Hex-Jaw design- best fit for hex bolts (patent pending)
- All-metal quick adjust mechanism- 26 positions for precise fit
- REAM & PUNCH™ Handles (patent pending)- Deburr smooth pipe up to 2 3/4" and punch electrical knock outs
- Jaw capacity - up to 2 3/4" hex bolt hardened teeth - long gripping life
- Slim head design comfort grips - will not peel from jobsite conditions
- Rust resistant
- Forged design for added strength



Part #	Mfg #	Description	Price
175107	48-22-6212	12" Hex - Jaws Pliers	

TORQUE LOCK™ Curved Jaw Locking Pliers with Durable Grip

- TORQUE LOCK™ Faster setup and easy release
- Curved Jaw: Maximizes pressure points for any bolt, nut or locking tool application
- Hardened Jaws: Better grip force on job site material
- Rust Protection: Increases tool life by reducing corrosion
- Overmold Grips: Durable and comfortable



Part #	Mfg #	Description	Price
168835	48-22-3405	5" TORQUE LOCK™ Curved jaw locking pliers	
168834	48-22-3407	7" TORQUE LOCK™ Curved jaw locking pliers	

Pliers & Wire Strippers

Pliers (Continued)

TORQUE LOCK™ Curved Jaw Locking Pliers with Durable Grip

Part #	Mfg #	Description	Price
168827	48-22-3410	10" TORQUE LOCK™ Curved jaw locking pliers	

TORQUE LOCK™ Long Nose Locking Pliers With Durable Grip

- TORQUE LOCK™ Faster setup and easy release
- Curved Jaw: Maximizes pressure points for any bolt, nut or locking tool application
- Hardened Jaws: Better grip force on job site material
- Rust Protection: Increases tool life by reducing corrosion
- Overmold Grips: Durable and comfortable



Part #	Mfg #	Description	Price
168837	48-22-3409	9" TORQUE LOCK™ Long Nose Locking Pliers with Durable Grip	
168838	48-22-3406	6" TORQUE LOCK™ Long Nose Locking Pliers with Durable Grip	

TORQUE LOCK™ Straight Jaw Locking Pliers

- TORQUE LOCK™: Faster setup and easy release
- Straight Jaw: Maximizes contact points on job site work surfaces
- Hardened Jaws: Better grip force on job site material
- Forged Alloy Steel: For maximum tool strength and durability
- Rust Protection: Increases tool life by reducing corrosion



Part #	Mfg #	Description	Price
168826	48-22-3507	7" TORQUE LOCK™ Straight Jaw Locking Pliers	
168825	48-22-3510	10" TORQUE LOCK™ Straight Jaw Locking Pliers	

TORQUE LOCK™ Curved Jaw Locking Pliers

- TORQUE LOCK™: Faster setup and easy release
- Curved Jaw: Maximizes pressure points for any bolt, nut or locking tool application
- Hardened Jaws: Better grip force on job site material
- Forged Alloy Steel: For maximum tool strength and durability
- Rust Protection: Increases tool life by reducing corrosion



Part #	Mfg #	Description	Price
168824	48-22-3420	10" TORQUE LOCK™ Curved Jaw Locking Pliers	

6-in-1 Lineman's Pliers

- Integrated reaming head to smooth-out rough edges of metal pipe
- High-leverage design
- (6) Applications:
 - Reaming
 - Bolt cutter
 - Wire cutter
 - Nail pulling
 - Pliers
 - Fish tape puller



Part #	Mfg #	Description	Price
149137	48-22-3309	9" Lineman's Pliers	

7" 6 IN 1 Diagonal Pliers

- Reaming head design- smooth edges of metal pipe from 1/2" to 1" (Patent Pending)
- Bolt cutter - thread and cut #6 and #8 bolts to preferred length (Patent Pending)
- High leverage design
- Laser hardened cutting edges
- Offset head design - 15 degree offset head for easier and quicker prying and pulling (Patent Pending)
- Rust protection



Part #	Mfg #	Description	Price
175105	48-22-6107	7" 6 IN 1 Diagonal Pliers	

Pliers & Wire Strippers

Pliers
Water Pump Pliers

- *Hardened and tempered for durability*



Part #	Mfg #	Model	Description	Length	Price
008764	80475	734	2" Capacity	10"	

Tools

Pliers & Wire Strippers

Milled Jaw Slip-Joint Pliers

- Nickel-plated finish with plastic grips
- Angle-nose pliers have grip tight clip



306-10

Part #	Mfg #	Type	Size	Max Opening	Price
113964	306-10	10"	Angle Nose	1-1/2"	

Pliers & Wire Strippers

Pliers **CHANNEL LOCK**

- Undercut tongue and groove design won't slip
- Patented reinforcing edge minimizes stress breakage
- CHANNELLOCK BLUE® grips for comfort

Smooth Jaw Tongue & Groove Pliers

- Smooth jaws for non-marring surfaces (PVC pipe, chromes, etc)
- Smooth jaw for use on plated fixtures
- PermaLock® fastener eliminates nut and bolt failure



Part #	Mfg #	Length	Capacity	Price
026715	R116800	10"	2"	

Straight Jaw Tongue & Groove Pliers

- High-carbon C1080 steel for superior performance on the job and electronic coating for ultimate rust prevention
- Right-angle, laser-heat treated teeth grip better and last longer
- PermaLock® fastener eliminates nut and bolt failure



R117200



R117400



R117600



R117800



R117900

Part #	Mfg #	Length	Capacity	Price
076358	R117200	6-1/2"	7/8"	
008905	R117400	9-1/2"	1-1/2"	
008907	R117600	10"	2"	
008908	R117800	12"	2-1/4"	
109928	R117900	16-1/2"	4-1/4"	

V-Jaw Tongue & Groove Pliers

- High-carbon C1080 steel for superior performance on the job and electronic coating for ultimate rust prevention
- Right-angle, laser heat-treated teeth grip better and last longer
- V-Jaws give you more points of contact on round stock and tubing
- PermaLock® fastener eliminates nut and bolt failure



R118300



R118400

Part #	Mfg #	Length	Capacity	Price
008906	R118300	9-1/2"	1-1/2"	
139950	R118400	10"	2"	

Tools

Pliers & Wire Strippers

Standard Side-Cutting Pliers

NE-Type Side-Cutting Pliers

- Plastic dipped handles
- Sure-gripping, cross-hatched knurled jaws



Part #	Mfg #	Overall Length	Jaw Length	Jaw Width	Price
106804	D201-7NE	7-7/16"	1-9/32"	1-1/16"	

High Leverage Side-Cutting Pliers

NE-Type Side-Cutting Pliers - Streamlined Design

- Plastic dipped handles
- Streamlined design with sure-gripping, cross-hatched knurled jaws
- High leverage



Part #	Mfg #	Overall Length	Jaw Length	Jaw Width	Price
106803	D213-9NE	9-1/4"	1-19/32"	1-1/4"	

High Leverage Diagonal-Cutting Pliers

Diagonal Cutter Pliers

- Plastic dipped handles
- High leverage



Part #	Mfg #	Overall Length	Jaw Length	Jaw Width	Price
106806	D228-7	7-1/8"	13/16"	1-3/16"	

Diagonal Angled Head Cutter Pliers

- Plastic dipped handles
- High leverage



Part #	Mfg #	Overall Length	Jaw Length	Jaw Width	Price
106805	D248-8 *	8-1/16"	13/16"	1-3/16"	

* Semi-flush cuts Cherry Barrel rivets - for use on non-ferrous wire only

Journeyman™ Diagonal Angled Head Cutter Pliers

- Dual material handles
- High leverage



Part #	Mfg #	Overall Length	Jaw Length	Jaw Width	Price
112637	J248-8	8-1/8"	13/16"	1-3/16"	

Needle-Nose Pliers

Standard Long-Nose Side-Cutting Pliers

- Plastic dipped handles
- Induction hardened, long-lasting cutting knives
- Knurled jaws for sure wrapping and looping



Part #	Mfg #	Overall Length	Jaw Length	Jaw Width	Price
106807	D203-6	6-5/8"	1-7/8"	11/16"	

Heavy-Duty Side-Cutting Long-Nose Pliers - Wire Stripping & Crimping

- Plastic dipped extended handles
- Cleanly strips 12 AWG wire
- Crimps connectors, lugs, and terminals
- Induction hardened cutting knives



Part #	Mfg #	Overall Length	Jaw Length	Jaw Width	Price
106808	D203-8NCR	8-5/8"	2-5/16"	1"	

Slip-Joint Pliers

Slip-Joint Pliers - Plastic Dipped Handles

- (2) Versatile jaw positions
- Serrated jaws
- Nickel-chrome plated



Part #	Mfg #	Overall Length	Jaw Length	Jaw Width	Price
112647	D511-6	6-1/2"	1-3/16"	1-3/16"	

Pump Pliers

Pump Pliers - Plastic Dipped Handles

- Secure tongue and groove design for non-slip grip
- Wide range of versatile jaw positions



Part #	Mfg #	Length	Max	Price
111629	D502-6	6-1/2"	7/8"	
106809	D502-10	10"	1-3/4"	
106810	D502-12	12-1/4"	2-3/8"	

Tools

Pliers & Wire Strippers

Wire Stripping & Cutting Tools

TripSaver® Combination Multi-Tool

- High-carbon, rust-resistant stainless steel
- Lightweight, compact, sturdy
- Locking "L" handle snaps into "L" channel
- Includes:
 - Needle-nose pliers
 - Beveled wire cutter
 - Toothed pipe grippers
 - Files (coarse and fine)
 - 5-Slot wire stripper (10-18 AWG)
 - Wire-looping hole
 - Scraper
 - Awl/reamer
 - Serrated sheepfoot knife
 - Clip-point knife
 - Standard/metric ruler
 - Drywall saw
 - Locking "L" handle
 - #1 and #2 Phillips hex bits
 - (1) Small- and (2) large-slotted hex bits
 - 1/4" Socket adapter
 - Lanyard hole and nylon pouch



Part #	Mfg #	Description	Price
111226	1016	5-3/4" Long, TripSaver Multi-Tool	

Long-Nose Multi-Purpose Tool

- Crimps insulated and non-insulated terminals and 7 to 8mm ignition terminals
- Long, curved cutting blade
- Cleanly shears bolts
- Plastic covered cushioned handles



Part #	Mfg #	Strips & Cuts	Price
107642	1010	10 - 22 AWG	

Klein-Kurve™ Wire Stripper/Cutter

- Precision shear-type blades
- Clean cuts on solid and stranded copper wire
- Markings on both sides
- Curved handles
- Wire looping and bending holes
- Coil spring provides fast self-opening action
- Precision-ground stripping holes
- Strong-gripping serrated nose
- Screw-shearing holes
- Handy closure lock for convenient storage
- Double dipped comfort grips



Part #	Mfg #	Strips & Cuts	Price
106811	11055	10-18 Solid, 12-20 Stranded	

Tools

Pliers & Wire Strippers

Pliers

Tongue and Groove Pliers

- Right angle teeth
- Comfort grips
- Undercut tongue and groove - won't slip

CHANNEL LOCK



Part #	Mfg #	Description	Price
187740	J40-401	6-1/2" Long, 7/8" Capacity	
187741	J40-402	9-1/2" Long, 1-1/2" Capacity	
041942	J40-403	10" Long, 2" Capacity	
041943	J40-404	12" Long, 2-1/4" Capacity	

Tongue and Groove Pliers with Smooth Jaw

- Smooth jaws for non-marring surfaces (PVC, chromes, etc)
- Undercut tongue and groove
Comfort grips



Part #	Mfg #	Description	Price
187742	J40-406	10" Channel Lock. 2" Capacity	

Pliers & Wire Strippers

Wire Strippers

7" Wire Stripper

- Comfortable grip
- Quick ID with easy-to-read size markings



Part #	Mfg #	Description	Price
174618	1885426	7" Wire Strippers	

Pliers

Quick-Adjusting Tongue & Groove Pliers

- Comfortable grip
- Push button allows for quick adjustments while multiple grooves guarantee precise positioning
- Machined jaws increase grip on the material



Part #	Mfg #	Description	Price
174615	1890996	8" Pliers	
174616	1890997	10" Pliers	

Tools



Power Sewer Machines

Ken-Way Junior Drain Cleaner

- Cleans 1" to 4" drain and process lines
- All steel construction
- Can handle cable sizes 1/4" to 1/2"
- Three drum size options
- Chuckless design speeds cable feeding
- Air powered foot switch
- Heavy-duty 1/4 hp motor
- Dimensions: 14"H x 17-1/2"W x 11"D
- Weight without cable: 24 lbs



Part #	Mfg #	Description	Price
110571	J045	Ken-Way Jr. Drain Cleaner w/Regular Drum & 3/8" x 50' Blade End Cable & Blades	



Power Sewer Machines

Super-Vee™ Drain Cleaners

Super-Vee™ Drain Cleaner Kit

- Includes:
 - Basic unit (side action chuck, variable speed motor with reversing switch)
 - Case
 - HECS Cutter set
 - (1) Additional cartridge

Part #	Mfg #	Description	Price
019540	SV-C-WC	1/4" x 50' (50HE1) & 3/8" x 35' (35HE2) Cables	

Mini-Router™ Drain Cleaners

Mini-Router™ Drain Cleaner Kit

- Includes:
 - Basic unit (MR-200 drum, 1/3 hp motor with reverse switch, 10' power cord, ground fault interrupter, waterproof air foot switch, leather gloves and cable)
 - MRCS Cutter set (AH arrow head, BG boring gimlet, 1-1/2" U & 1-1/2" U-cutter, 2" SCB side cutter blade)

Part #	Mfg #	Description	Price
005054	MR-B	75' x 3/8" (75EM2) Cable & MRCS Cutter Set	

Mini-Router™ Drainer Cleaner Accessories



Part #	Mfg #	Description	Price
028942	MR-W	Mini-Router™ Dolly	

Flexicore Cables

- With male and female connectors

Part #	Mfg #	Size	Price
005072	50EM2	3/8" x 50'	
027735	100EM5	3/4" x 100'	

Replacement Cables



Basin Plug Head

Part #	Mfg #	Description	Price
020328	25HE1	1/4" x 25' w/EI Basin Plug Head	
005073	50HE1	1/4" x 50' w/EI Basin Plug Head	

Cutters

Cutters for 3/8" Cable

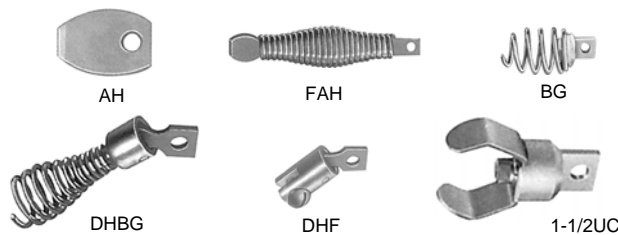

Part #	Mfg #	Description	Price
005048	AH	Arrow Head	
018911	FAH	Flex Arrow Head	
005049	BG	Boring Gimlet	
005051	DHBG	Down Head Boring Gimlet	
005052	DHF	Down Head Fitting	
005065	1-1/2UC	1-1/2" U-Cutter	

Cutters for 5/8" & 3/4" Cable

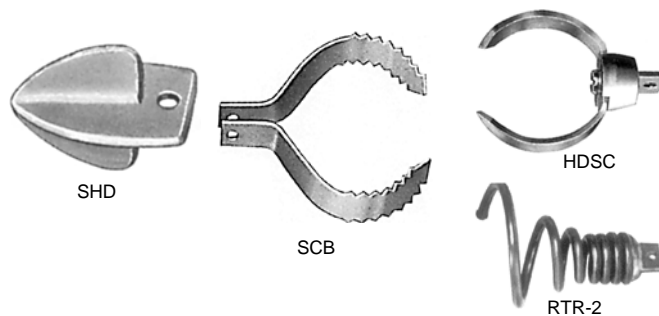

Part #	Mfg #	Description	Price
019877	SHD	Spear Head Starting Drill	
005069	3SCB	3" Side Cutter Blade - 2-Pc	
005071	4SCB	4" Side Cutter Blade - 2-Pc	
017789	3HDSC	3" Heavy-Duty Side Cutter	
019876	RTR-2	Corkscrew Retrieving Tool	

Connectors

Basic Connector

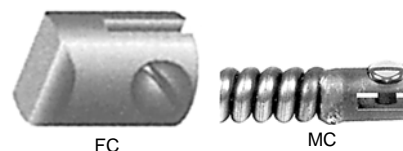

Part #	Mfg #	Description	Price
019868	5/8FC	5/8" Female, Butt Weld	
019870	3/4FC	3/4" Female, Butt Weld	
005070	3/8E-FC	3/8" Female, For 3/8" EM Cable	
019865	3/8MC	3/8" Male	

Tools



Power Sewer Machines

Connectors (Continued)

Basic Connector

Part #	Mfg #	Description	Price
019867	1/2MC	1/2" Male	
019869	5/8MC	5/8" Male, Butt Weld	
019975	3/4MC	3/4" Male, Butt Weld	

Quick Fix Connector

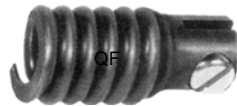

Part #	Mfg #	Description	Price
019860	1/2QF	1/2" Quick Fix	
019862	5/8QF	5/8" Quick Fix	
017788	3/4QF	3/4" Quick Fix	

Connector Screw

Part #	Mfg #	Description	Price
019864	5/8CS	5/8", 5-Pack, For Butt Weld	
005050	3/4CS	3/4", 5-Pack, For Butt Weld	

D-25 Handy™ Drain Cleaner Heads

D-25 Handy™ Drain Cleaner Head - Down Head (DH)

- Flexicore™ cable units
- Can be attached to a drill



Part #	Mfg #	Description	Price
095198	D-25-2	1/4" x 25'	

No. 25 Handy Drain Cleaner Heads

Down Head (DH) Handy



Part #	Mfg #	Description	Price
092130	25-8	5/16" x 25'	

Flexicore® Wire Rope Center Drain Augers

Regular Head less Handle

- Includes rotary handle
- Hand wire only



Part #	Mfg #	Description	Price
043667	L-25FL1	1/4" x 25'	

Down Head less Handle

- Includes rotary handle
- Hand wire only



Part #	Mfg #	Description	Price
097172	L-25FL1-DH	1/4" x 25'	

Flat Sewer Rods

- Oil tempered - rust ban coated
- Quick-Grip handle
- Roller head



Flat Sewer Rod for 4" - 6" Pipe

Part #	Mfg #	Size	Lgth	Price
032705	100D	3/4" x 1/8"	100'	

Power Tools

M12™ Lithium-Ion Cordless Tools

M12™ Cordless 3/8" Right Angle Drill Driver Kit

- No load speed: 0 to 800 rpm
- Clutch settings: 11+ Drill
- Chuck type: 3/8" single sleeve
- Head length/weight: 3-3/4"/2.4 lbs
- Includes:
 - M12™ 3/8" Right angle drill driver
 - M12™ Lithium-Ion battery
 - 30-Minute charger
 - Soft carrying case
- 5-Year warranty



Part #	Mfg #	Description	Price
160481	2415-20	M12™ Cordless 3/8" Right Angle Drill/Driver (Bare Tool)	
137547	2415-21	Drill Driver Kit, Cordless 3/8" Right Angle 100in-lbs Torque	

M12™ Cordless 3/8" Drill Driver

- All metal locking chuck
- 2-Speed all metal gear box
- No load speed: 0 to 400/0 to 1,500 rpm
- Clutch settings: 11+ drill
- Chuck type: 3/8" single sleeve
- Torque: 275 in-lbs
- Kit includes:
 - M12™ Drill driver (2410-20)
 - (2) 12V Lithium-Ion batteries
 - 30-Minute charger
 - Soft carrying case
- 5-Year warranty



Part #	Mfg #	Description	Price
137548	2410-22	Drill Driver Kit	

M12™ Cordless 3/8" Hammer Drill Driver

- 7-5/8" Length, 2.8 lbs
- 2-Speed metal gear box: 0 to 400/0 to 1,500 rpm
- 3/8" Metal single sleeve ratcheting chuck
- On-board fuel gauge
- Built-in LED light
- Torque: 275 in-lbs
- Kit includes:
 - M12™ 3/8" Hammer drill driver (2411-20)
 - (2) M12™ REDLITHIUM™ Batteries
 - 30-Minute charger
 - Carrying case



Part #	Mfg #	Description	Price
137549	2411-22	Hammer Drill Driver Kit	

M12™ 3/8" Hammer Drill/Driver Kit

- Delivers up to 275 in lbs of Torque
- On-board battery fuel gauge displays remaining run time
- New ergonomic handle design for increased comfort
- Metal ratcheting chuck for maximum durability
- Includes:
 - (1) M12™ 3/8" Hammer drill/driver (Bare Tool) (2408-20)
 - (2) M12™ REDLITHIUM™ battery (48-11-2401)
 - (1) M12™ Lithium-ion battery charger (48-59-2401)
 - (1) Belt clip
 - (1) Carrying case



Part #	Mfg #	Description	Price
162002	2408-20	M12™ 3/8" Hammer Drill/Driver (Bare Tool)	
161649	2408-22	M12™ 3/8" Hammer Drill/Driver Kit	

Tools

Power Tools

M12 FUEL™ 1/2" Drill/Driver Kit

- **POWERSTATE™ Brushless motor:** Delivers up to 350 in-lbs of peak torque with maximum sustained torque to complete a variety of applications
- **REDLITHIUM™ Battery technology:** Superior pack construction, electronics, and performance deliver more work per charge and more work over pack life than any battery on the market
- **REDLINK Plus™ Intelligence:** The most advanced system of cordless power tool electronics. Provides optimized performance and overload protection using total system communication between tool, battery and charger
- Includes:
 - (1) M12 FUEL™ 1/2" Drill/Driver (bare tool) (2403-20)
 - (1) M12 REDLITHIUM™ 2.0 Compact battery pack (48-11-2420)
 - (1) M12™ REDLITHIUM™ XC 4.0 Extended capacity battery pack (48-11-2440)
 - (1) M12™ Lithium-ion battery charger (48-59-2401)
 - (1) Belt clip
 - (1) Carrying case



Part #	Mfg #	Description	Price
165720	2403-22	M12 FUEL™ 1/2" Drill/Driver Kit	

M12™ Cordless Rotary Tool

- Includes:
 - M12™ Rotary tool (2460-20)
 - (1) REDLITHIUM™ Battery (48-11-2401)
 - (5) Cutting wheels, mandrel
 - Wrench
 - 30-Minute charger



Part #	Mfg #	Description	Price
162782	2460-20	M12™ Cordless Rotary Tool (Bare Tool)	
144497	2460-21	12V	

M12™ 1/4" Hex 2-Speed Screwdriver Kit

- Delivers up to 275 in-lbs of torque
- On-board battery fuel gauge displays remaining run time
- New ergonomic handle design for increased comfort
- 1/4" Hex quick change chuck for one-handed bit changes
- Includes:
 - (1) M12™ 1/4" Hex 2-speed screwdriver (2406-20)
 - (2) M12™ REDLITHIUM™ battery (48-11-2401)
 - (1) M12™ Lithium-ion battery charger (48-59-2401)
 - (1) Belt clip
 - (1) Carrying case



Part #	Mfg #	Description	Price
162004	2406-20	M12™ 1/4" Hex 2-Speed Screwdriver Tool Only	
162003	2406-22	M12™ 1/4" Hex 2-Speed Screwdriver Kit	

M12 FUEL™ 1/4" Hex 2-Speed Screwdriver Kit

- **POWERSTATE™ Brushless motor:** Delivers up to 325 in-lbs of peak torque with maximum sustained torque to complete a variety of applications
- **REDLITHIUM™ Battery technology:** Superior pack construction, electronics, and performance deliver more work per charge and more work over pack life than any battery on the market
- **REDLINK Plus™ Intelligence:** The most advanced system of cordless power tool electronics. Provides optimized performance and overload protection using total system communication between tool, battery and charger



Part #	Mfg #	Description	Price
165722	2402-22	M12 FUEL™ 1/4" Hex 2-Speed Screwdriver Kit	

M12™ Cordless Screwdriver

- Quick one-handed bit-loading
- Variable speed trigger
- No load speed: 0 to 500 rpm
- Includes:
 - M12™ Screwdriver (2401-20)
 - (2) 12V Lithium-Ion batteries
 - 12V Charger
 - Compact driver storage bag
- 5-Year warranty



Part #	Mfg #	Description	Price
137546	2401-22	100 in-lbs Torque	

Power Tools

M12™ 3/8" Drill/Driver Kit

- Delivers up to 275 in-lbs of torque
- On-board battery fuel gauge displays remaining run time
- Metal ratcheting chuck for maximum durability
- Includes:
 - (1) M12™ 3/8" Drill/Driver (bare tool) (2407-20)
 - (1) M12™ REDLITHIUM Battery (48-11-2401)
 - (1) M12™ Lithium-ion battery charger (48-59-2401)
 - (1) Belt clip
 - (1) Carrying case



Part #	Mfg #	Description	Price
162001	2407-20	3/8" Drill/Driver Tool Only	
162000	2407-22	3/8" Drill/Driver Kit	

M12™ Cordless 1/4" Hex Impact Driver

- Battery fuel gauge displays remaining run-time
- Built-in LED light illuminates work surface
- Tool weight: 2.3 lbs
- No load speed: 0 to 2,000 rpm
- Torque: 850 in-lbs
- Kit includes:
 - M12™ 1/4" Hex impact driver (2450-20)
 - (2) Lithium-Ion batteries
 - 12V Charger
 - Carrying case
- 5-Year warranty



Part #	Mfg #	Description	Price
137551	2450-22	Impact Driver Kit	

M12™ 1/4" Hex Impact Driver Kit

- Milwaukee impact mechanism delivers 1,000 in-lbs of torque
- 0-2,500 RPM for increased fastening speed
- On-board battery fuel gauge displays remaining run time
- Includes:
 - (1) M12™ 1/4" Hex impact driver (2462-20)
 - (1) M12™ REDLITHIUM™ battery (48-11-2401)
 - (1) M12™ Lithium-ion battery charger (48-59-2401)
 - (1) Belt clip
 - (1) Carrying case



Part #	Mfg #	Description	Price
160215	2462-20	1/4" Impact Driver Tool Only	
160216	2462-22	1/4" Impact Driver Kit	

M12™ 1/4" Impact Wrench Kit

- Lightweight, compact design allows for fastening in tight space
- New ergonomic handle design for increased comfort
- On-board battery fuel gauge displays remaining run time
- 1/4" anvil with friction ring for fast and easy socket changes
- Includes:
 - (1) M12™ 1/4" Impact wrench (2461-20)
 - (2) M12™ REDLITHIUM™ battery (48-11-2401)
 - (1) M12™ Lithium-ion battery charger (48-59-2401)
 - (1) Belt clip
 - (1) Carrying case



Part #	Mfg #	Description	Price
162010	2461-20	1/4" Impact Wrench Tool Only	
162009	2461-22	1/4" Impact Wrench Kit	

Power Tools

M12 FUEL™ 1/4" Impact Wrench Kit

- **POWERSTATE™** Brushless motor: Delivers up to 500 in-lbs of peak torque with maximum sustained torque to complete a variety of applications
- **REDLITHIUM™** 2.0 Battery technology: Superior pack construction, electronics, and performance deliver more work per charge and more work over pack life than any battery on the market
- **REDLINK Plus™** Intelligence: The most advanced system of cordless power tool electronics. Provides optimized performance and overload protection using total system communication between tool, battery and charger
- **DRIVE CONTROL™**: Two fastening modes provide variable power and speed for precision work and heavy duty applications
- Includes:
 - (1) M12 FUEL™ 1/4" Impact wrench (bare tool) (2452-20)
 - (2) M12 REDLITHIUM™ 2.0 Compact battery pack (48-11-2420)
 - (1) M12™ Lithium-ion battery charger (48-59-2401)
 - (1) Belt clip
 - (1) Carrying case



Part #	Mfg #	Description	Price
165719	2452-22	M12 FUEL™ 1/4" Impact Wrench Kit	

M12 FUEL™ 3/8" Impact Wrench Kit

- **POWERSTATE™** Brushless motor: delivers up to 1,400 in-lbs of peak torque with maximum sustained torque to complete a variety of applications
- **REDLITHIUM™** 2.0 Battery technology: superior pack construction, electronics, and performance deliver more work per charge and more work over pack life than any battery on the market
- **REDLINK Plus™** Intelligence: the most advanced system of cordless power tool electronics. Provides optimized performance and overload protection using total system communication between tool, battery and charger
- **DRIVE CONTROL™**: two fastening modes provide variable power and speed for precision work and heavy duty applications



Part #	Mfg #	Description	Price
165718	2454-22	M12 FUEL™ 3/8" Impact Wrench Kit	

M12™ 3/8" Impact Wrench Kit

- Milwaukee impact mechanism delivers 1,200 in-lbs of torque
- New ergonomic handle design for increased comfort
- On-board battery fuel gauge displays remaining run time
- 3/8" anvil with friction ring for fast and easy socket changes
- Includes:
 - (1) M12™ 3/8" Impact wrench (2463-20)
 - (2) M12™ REDLITHIUM™ battery (48-11-2401)
 - (1) M12™ Lithium-ion battery charger (48-59-2401)
 - (1) Belt clip
 - (1) Carrying case



Part #	Mfg #	Description	Price
162008	2463-20	3/8" Impact Wrench Only	
162006	2463-22	3/8" Impact Wrench Kit	

M12 FUEL™ 5/8" SDS Plus Rotary Hammer Kit

- **REDLINK™** Intelligence: Provides optimized performance and overload protection using total system communication between tool, battery and charger
- **REDLITHIUM™** Battery technology: Superior pack construction, electronics, and performance deliver more work per charge and more work over pack life than any battery on the market
- **Electro pneumatic mechanism**: Drills up to 5/8" holes in poured concrete and masonry
- **Powerful 12-volt motor**: Delivers 0-900 RPM and 0-6,200 BPM for superior performance
- **Compact, lightweight design**: Allows you to work comfortably in tight spaces and all day
- **2-Mode operation**: Choose rotary hammer or rotation only for maximum versatility
- **LED light**: Illuminates the work surface



Part #	Mfg #	Description	Price
165721	2416-22XC	M12 FUEL™ 5/8" SDS Plus Rotary Hammer Kit	

Power Tools

M12™ Cordless 1/4" Ratchet

- Torque: 30 ft-lbs
- Speed: 250 rpm
- Anvil: 1/4" ball detent
- Kit includes:
 - M12™ 1/4" Ratchet (2456-20)
 - (1) M12™ REDLITHIUM™ battery
 - 30-Minute charger
 - Carrying case



Part #	Mfg #	Description	Price
143703	2456-21	Ratchet Kit	

M12™ Cordless 3/8" Ratchet

- Torque: 35 ft-lbs
- Speed: 250 rpm
- Anvil: 3/8" ball detent
- Kit includes:
 - M12™ 3/8" Ratchet (2457-20)
 - M12™ REDLITHIUM™ Battery
 - 3/8" to 1/4" Adapter
 - 30-Minute charger
 - Carrying case



Part #	Mfg #	Description	Price
143706	2457-20	Ratchet Tool Only	

M12™ 102 X77 Infrared Camera

- 7,854 (102 x 77) pixel resolution captures highest resolution image in it's class
- DUAL SENSE™ pixels are ultra-responsive, adjusting individually to eliminate blurring of hot and cold details
- take measurements from long range or down to the detail with 83:1 distance-to-spot performance
- Measure surface temperatures 14°F to 626°F degrees for images spanning wide ranges
- 2-Stage trigger activates lasers for easy scanning or quickly captures images
- Dual lasers frame on-screen temperature area
- Multiple color palettes available: rainbow, grayscale and ironbow
- Automatically locates highest and lowest temperatures
- Fully compatible with Milwaukee® thermal imager reporting software available at MilwaukeeTool.com
- Compatible with over 70+ M12™ tools



Part #	Mfg #	Description	Price
185579	2258-21	M12™ 102 X 77 Infrared Camera	

M12™ M-Spector 360™ Rotating Inspection Scope

- Rotating display allows user to orient the image without having to fight the cable
- 640 x 480 Digital image sensor
- (4) LED lights
- Display: 2.7" LCD
- 9mm Aluminum head
- 3' Cable
- Includes:
 - M-Spector 360™ console
 - M12™ REDLITHIUM™ battery
 - 30 Minute charger
 - Hook, magnet and mirror attachments
 - Carrying case



Part #	Mfg #	Description	Price
148602	2313-21	Inspection Scope	
155645	2314-21	M-Spector 360™ ft Kit	

SUB-SCANNER™ M12™ Detection Tool

- Measures depth and location of Rebar up to 6" through concrete
- Detects location of wood and metal studs
- Differentiates between steel and copper or aluminum metals
- Intuitive user interface displays stud centers and edges
- High contrast white on black display and back light for easy reading
- Rugged over-molding improves durability and user grip
- One button calibration for all surfaces



Part #	Mfg #	Description	Price
153058	2291-20	SUBSCANNER™ M12™ Detection Tool	

Power Tools

M12™ Lithium-Ion Cordless Press Tools

M12™ Cordless ProPEX® Expansion Tool Kit

- Speed: 60 SPM
- Head rotation: built-in auto-rotator
- Head compatibility: 3/8" to 1" M12™/Uponor®
- LED Light
- Includes:
 - (2) Lithium-Ion batteries
 - 1/2" Expansion head
 - 3/4" Expansion head
 - 1" Expansion head
 - Grease
 - Carrying case
- 5-Year warranty



Part #	Mfg #	Description	Price
135837	2432-22	3/8" - 1" Capacity	

M12™ Force Logic™ Press Tool Kit

- Interchangeable jaw for quick adjustment from 1/2" to 1-1/4"
- Suitable for one-hand use
- 5-Second cycle time
- Press force: 5,400 lbs
- 32,000 Cycles between calibrations
- Includes:
 - M12™ Force Logic™ press tool (2473-20)
 - (2) M12™ REDLITHIUM™ batteries
 - 30-Minute charger
 - Hard carrying case
- 5-Year warranty on tool
- 2-Year warranty on jaws



Part #	Mfg #	Description	Price
150846	2473-20	Press Tool Kit	
150847	2473-22	Press Tool Kit w/1/2", 3/4" & 1" Jaws	

M12™ Force Logic™ Press Tool Jaw

- One-handed pressing solution for up to 1-1/4" pipe



Part #	Mfg #	Description	Price
150863	49-16-2450	1/2" Jaw	
150864	49-16-2451	3/4" Jaw	
150865	49-16-2452	1" Jaw	

M12™ Lithium-Ion Cordless Press Tools (Continued)

M12™ Force Logic™ Press Tool Jaw

Part #	Mfg #	Description	Price
150867	49-16-2453	1-1/4" Jaw	

M12™ Hackzall™ Cordless Reciprocating Saw

- 11" Long and 2.6 lbs for cutting in tight spaces
- 1/2" Stroke, 0 to 3,000 strokes per minute
- Keyless QUIK-LOK™ blade clamp allows for quick and easy blade changes
- All-metal gear case
- Variable speed trigger
- Battery fuel gauge displays remaining run-time
- Accepts both Hackzall™ and Sawzall® style blades
- Built-in LED light illuminates work surface
- 21 & 22 Suffixes include:
 - Hackzall™ (2420-20)
 - 30-Minute charger
 - (2) Hackzall™ blades
 - Carrying case
- 5-Year warranty



Part #	Mfg #	Description	Price
146874	2420-20	Saw Only	
137550	2420-21	Includes (1) M12™ Battery	

Power Tools

M12™ Cordless PVC Shear Kit

- Ultra sharp blade with pierce point
- Offset blade cuts PVC/PEX in-wall, in-ground, or close to wall
- Quick return blade
- All metal planetary drive
- Stainless steel blade and aluminum jaw
- Impact, water and rust resistant
- Variable speed trigger
- On board fuel gauge - displays remaining run-time
- Torque: 1,900 in-lbs
- Includes:
 - M12™ Cordless PVC shear (2470-20)
 - (1) Lithium-Ion battery
 - 30-Minute charger
 - Carrying case
- 5-Year warranty



Part #	Mfg #	Description	Price
152547	2470-20	M12™ Plastic Pipe Shear (Bare Tool)	
137552	2470-21	2" PVC Capacity	

M12™ AC/DC Wall Vehicle Charger

- 2-In-1 Design
- Charge time: 40 minutes
- Lithium-Ion battery (not included)
- 5-Year warranty



Part #	Mfg #	Description	Price
138274	2510-20	M12™ AC/DC Wall & Vehicle Charger	

M12™ Cordless Grease Gun

- Maximum operating pressure: 8,000 psi
- Grease capacity: 14 oz cartridge/16 oz bulk
- Includes:
 - M12™ Grease gun (2446-20)
 - M12™ XC REDLITHIUM™ battery
 - 60-Minute charger
 - 36" High pressure flex hose with spring guard
 - Grease coupler
 - Carrying case



Part #	Mfg #	Description	Price
141426	2446-21XC	M12™ Grease Gun	

M12™ Cordless LITHIUM-ION Multi-Tool

- Cuts, grinds, sands and scrapes
- Variable speed dial
- On board fuel gauge displays run time
- Runs 5,000 to 20,000 OPM
- Kit includes:
 - Cordless multi-tool
 - Accessory adapter
 - Wood cutting blade
 - (1) REDLITHIUM™ battery
 - 30-Minute charger
 - Contractor bag



Part #	Mfg #	Description	Price
143165	2426-21	M12™ LITHIUM-ION Multi-Tool Kit	

M12™ Cordless Copper Tubing Cutter

- Close quarter rotating cutting head cuts pipe in confined spaces
- Automatic adjustment from 3/8" to 1" tubing
- Auto locking mechanism delivers up to 200 cuts per charge
- Water resistant sealed metal cutter head
- Battery fuel gauge displays remaining run time
- Built-in LED light illuminates line of cut
- 14" Long, 3.2 lbs tool weight
- No load speed: 500 rpm
- Capacity: 1/2" to 1-1/8" OD
- Kit includes:
 - Tubing cutter (2471-20)
 - (2) 12V Lithium-Ion battery (2471-21 is single battery kit)
 - 30-Minute charger
 - Carrying case
- 5-Year warranty



Part #	Mfg #	Description	Price
148546	2471-20	Tubing Cutter Only	
137554	2471-21	Tubing Cutter Kit	

Copper Cutter Wheels

- Hardened steel with black oxide
- Convex blade design
- For use with Milwaukee® 12V copper tubing cutter model 2471



Part #	Mfg #	Description	Price
138792	48-38-0010	Copper Cutter Replacement Blades 2/Pk	

Power Tools

M12™ Cordless Multi-Tool

- Cuts, grinds, sands and scrapes
- Variable speed dial
- On board fuel gauge displays run time
- Runs 5,000 to 20,000 OPM
- Includes:
 - Cordless multi-tool
 - Accessory adapter
 - Wood cutting blade
 - Sanding pad
 - (5) Assorted sanding sheets
 - (2) REDLITHIUM™ batteries
 - 30-Minute charger
 - Contractor bag



Part #	Mfg #	Description	Price
139011	2426-22	M12™ Multi-Tool Kit	

M12™ Cordless 2-Tool Combo Kit

- 1/4" Hex screwdriver delivers 150 in-lbs of torque, 15 position clutch, and 0 to 500 rpm
- Hackzall™ reciprocating saw delivers 0 to 3000 spm
- Includes:
 - Screwdriver (2401-20)
 - Hackzall™ Reciprocating saw (2420-20)
 - (2) M12™ Lithium-Ion batteries
 - 30-Minute charger
 - (2) Hackzall™ blades
 - Contractor bag
- 5-Year warranty



Part #	Mfg #	Description	Price
137556	2490-22	150 in-lbs Torque	

M12™ Cordless LITHIUM-ION 2-Tool Combo Kit



Part #	Mfg #	Description	Price
163696	2497-22	M12™ Cordless LITHIUM-ION 2-Tool Combo Kit	

M12™ Cordless 4-Tool Combo Kit

- Hackzall™ reciprocating saw delivers 0 to 3000 spm
- Copper tubing cutter automatically adjusts to cut 3/8" to 1" copper tube
- Work light illuminates large work area with 90° rotating head and integrated magnet
- Includes:
 - Screwdriver (2401-20)
 - Hackzall™ reciprocating saw (2420-20)
 - Copper tubing cutter (2471-20)
 - Work light (49-24-0145)
 - (2) 12V Lithium-Ion battery packs
 - 30-Minute charger
 - (2) Hackzall™ blades
 - Contractor bag



Part #	Mfg #	Description	Price
138377	2490-24	150 in-lbs Torque	

M12™ Cordless 2-Tool Combo Kit (1)

- Includes:
 - 1/4" Hex Impact driver (2450-20)
 - Hackzall™ Reciprocating saw (2420-20)
 - (2) Lithium-Ion batteries
 - 30-Minute charger
 - Contractor bag
- 5-Year warranty



Part #	Mfg #	Description	Price
139268	2491-22	12V	

M12™ Cordless 2-Tool Combo Kit

- Includes:
 - 3/8" Drill driver (2410-20)
 - 1/4" Hex impact driver (2450-20)
 - (2) M12™ REDLITHIUM™ Batteries (48-11-2401)
 - 30-Minute charger (48-59-2401)
 - Contractor bag
- 5-Year warranty



Part #	Mfg #	Description	Price
137558	2494-22	12V	

Power Tools

M12 Fuel™ Cordless Tools

M12 FUEL™ 1/2" Hammer Drill/Driver Kit

- POWERSTATE™ Brushless motor
- REDLINK Plus™ Intelligence
- REDLITHIUM™ Battery technology
- Includes:
 - (1) M12 FUEL™ 1/2" hammer drill/driver (2404-20)
 - (1) M12 REDLITHIUM™ 2.0 compact battery pack (48-11-2420)
 - (1) M12™ REDLITHIUM™ XC 4.0 extended capacity battery pack (48-11-2440)
 - (1) M12™ Lithium-ion battery charger (48-59-2401)
 - (1) Belt clip
 - (1) Carrying case



Part #	Mfg #	Description	Price
154724	2404-22	M12 FUEL™ 1/2" Hammer Drill/Driver Kit	

M12 FUEL™ 1/4" Hex Impact Driver

- POWERSTATE™ Brushless motor: Delivers 1,200 in-lbs of peak torque with maximum sustained torque to complete a variety of applications
- REDLITHIUM™ 2.0 Battery technology: Superior pack construction, electronics, and performance deliver more work per charge and more work over pack life than any battery on the market
- REDLINK Plus™ Intelligence: The most advanced system of cordless power tool electronics. Provides optimized performance and overload protection using total system communication between tool, battery and charger
- DRIVE CONTROL™: Two fastening modes provide variable power and speed for precision work and heavy duty applications
- Includes:
 - (1) M12 FUEL™ 1/4" hex impact driver (2453-20)
 - (2) M12 REDLITHIUM™ 2.0 compact battery pack (48-11-2420)
 - (1) M12™ Lithium-ion battery charger (48-59-2401)
 - (1) Belt clip
 - (1) Carrying case



Part #	Mfg #	Description	Price
159974	2453-20	M12 Fuel™ 1/4" Hex Impact Driver Tool Only	
154725	2453-22	M12 FUEL™ 1/4" Hex Impact Driver Kit	

M12 FUEL™ 2-Tool Combo Kit



Part #	Mfg #	Description	Price
164845	2597-22	M12 FUEL™ 2-Tool Combo Kit	

M12 FUEL™ HACKZALL® Recip Saw Kit

- One-handed design provides superior control & versatility over a standard recip saw
- Compact size allows for cutting in tight spaces, and light weight makes overhead work easier
- POWERSTATE™ brushless motor supplies constant power for faster cuts and reduced heat for extended life
- REDLINK PLUS™ Intelligence provides optimized performance and overload protection using total system communication between tool, battery and charger
- REDLITHIUM™ XC 4.0 Battery pack provides superior pack construction, more work per charge and more work over the life of the pack than competitive batteries



Part #	Mfg #	Description	Price
166203	2520-20	M12 FUEL™ HACKZALL® Recip Saw (Bare Tool)	
166202	2520-21XC	M12 FUEL™ HACKZALL® Recip Saw Kit	

M12™ Cordless LITHIUM-ION 4-Tool Combo Kit

- Includes:
 - (1) M12™ 3/8" Drill/Driver (bare tool) (2407-20)
 - (1) M12™ HACKZALL® Recip saw (bare tool) (2420-20)
 - (1) M12™ 1/4" Hex impact driver (bare tool) (2462-20)
 - (2) M12™ REDLITHIUM™ Battery (48-11-2401)
 - (1) M12™ Lithium-ion battery charger (48-59-2401)
 - (1) M12™ Work light (49-24-0145)
 - (1) Contractor bag



Part #	Mfg #	Description	Price
159666	2498-24	M12™ Cordless LITHIUM-ION 4-Tool Combo Kit	

Power Tools

M12 Fuel™ Miscellaneous Tools

M-Spector™ Inspection Scope Kit

- 2.7" LCD display
- Four surround LED lights
- 3 ft enhanced cable
- Includes:
 - (1) M-Spector™ Scope Kit
 - (1) Pipe guide attachment
 - (1) 9V Battery
 - (1) Carrying case



Part #	Mfg #	Description	Price
229565	2309-20	M12™ M-Spector™	

M12™ Job site Radio

- Digital reception with signal processor
- 1/8" Stereo jack auxiliary input
- Includes:
 - Job site radio
 - Auxiliary input cord
 - AC Adapter
 - (2) AAA Batteries for memory backup
- Battery and charger sold separately
- 3.6 lbs



Part #	Mfg #	Size	Price
139355	2590-20	10-1/2" x 7" x 4"	

M18™ Lithium-Ion Cordless Drills

M18™ Cordless Right Angle Drill

- No load speed: 0 to 1550 rpm
- Torque: 125 in-lbs
- Chuck type: 3/8" single sleeve ratcheting
- Includes:
 - M18™ Right angle drill (2615-20)
 - M18™ REDLITHIUM™ XC High capacity battery
 - 1-Hour charger
 - Carrying case



Part #	Mfg #	Description	Price
162304	2615-20	M18™ Cordless Right Angle Drill (Bare Tool)	
142940	2615-21	Right Angle Drill Kit	

M18™ 1/2" High Performance Hammer/Drill Driver

- 4-Pole frameless motor
- 1/2" Single-sleeve ratcheting metal chuck with carbide jaws
- Battery fuel gauge displays remaining run-time
- Built-in LED light illuminates work surface
- Variable speed trigger
- No load speed: 0 to 1,800 rpm
- No load BPM: 0 to 28,000 BPM
- Includes:
 - (2) M18™ 18V XC Lithium-Ion batteries
 - 18V Charger
 - Side handle
 - Carrying case
- 5-Year warranty



Part #	Mfg #	Description	Price
139122	2611-24	650 in-lbs Torque	

M18™ Compact Drill Driver

- Built-in LED light
- 18V DC
- No load speed: 350 to 1,400 rpm
- Torque: 425 in-lbs
- Kit includes:
 - M18™ Compact drill driver (2601-20)
 - (2) 18V Lithium-Ion batteries
 - 18V Lithium-Ion charger
 - 1/2" 3-Jaw keyless chuck
- 5-Year warranty



Part #	Mfg #	Description	Price
137559	2601-22	Drill Driver Kit	

M18™ FUEL™ 1/2" Drill/Driver Kit

- Torque: 725 in-lbs
- 2-Speed
- Includes:
 - M18™ FUEL™ 1/2" Drill/driver (2603-20)
 - (2) M18™ REDLITHIUM™ XC High capacity batteries
 - Multi-voltage charger
 - Carrying case



Part #	Mfg #	Description	Price
155163	2603-20	M18™ 1/2" Drill/Driver (Bare Tool)	
148728	2603-22	FUEL Drill/Driver Kit	

Power Tools

M18™ Compact Hammer Drill Driver

- 4-Pole frameless motor
- 1/2" Single-sleeve ratcheting metal chuck
- Variable speed trigger
- No load speed: 0 to 1,700 rpm
- No load BPM: 0 to 29,000 BPM
- Torque: 550 in-lbs
- Kit includes:
 - M18™ Hammer-drill driver (2602-22)
 - (2) 18V XC Lithium-Ion batteries
 - 1-Hour 18V charger
 - Carrying case
- 5-Year warranty



Part #	Mfg #	Description	Price
143056	2602-20	Hammer Drill Driver Only	
137560	2602-22	Hammer Drill Driver Kit	

M18™ FUEL™ 1/2" Hammer Drill/Driver Kit

- 2-Speed Powerstate™ brushless motor
- Redlink PLUS™ Intelligence system communications with overload protection
- No load speed: 0 to 500/0 to 1850 rpm
- Includes:
 - 1/2" Drill/driver (2603-20)
 - (2) 18V Compact REDLITHIUM™ batteries
 - Multi-voltage charger
 - Locking chuck
 - LED Light
- 5-Year warranty



Part #	Mfg #	Description	Price
157955	2604-20	M18 FUEL™ 1/2" Hammer Drill/Driver (Bare Tool)	
148727	2604-22	725 in-lbs Torque with Cushion Grip	

M18™ 1/4" Hex Compact Impact Driver

- 1/4" Hex quick change chuck
- 4-Pole frameless motor
- Battery fuel gauge displays remaining run-time
- No load speed: 0 to 2,200 rpm
- No load IPM: 0 to 3,200 IPM
- Variable speed trigger
- Built-in LED light illuminates work surface
- 18V
- Includes:
 - M18™ Impact driver (2650-20)
 - (2) M18™ REDLITHIUM™ XC high capacity batteries
 - Battery charger
 - Belt clip
 - Carrying case
- 5-Year warranty



Part #	Mfg #	Description	Price
144367	2650-20	Impact Driver Only	
137562	2650-22	Impact Driver Kit	

Tools

Power Tools

M18 2-Speed 1/4" Hex Impact Driver Kit

- Milwaukee® 4-Pole frameless motor: features a robust design for longer life, more power and more runtime than any brushed competitor
- Milwaukee® designed impact mechanism: Delivers maximum power and application speed for greater efficiency on the job
- REDLINK™ Intelligence: Provides optimized performance and overload protection using total system communication between tool, battery and charger
- Proprietary 2-Mode DRIVE CONTROL™ Two speed/torque modes allow class-leading control for greater application versatility
- 1/4" Hex quick-connect chuck
- REDLITHIUM™ Battery technology: superior pack construction, electronics, and performance deliver more work per charge and more work over pack life than any battery on the market
- Includes:
 - (1) M18 2-Speed 1/4" hex impact driver (Bare tool) (2657-20)
 - (2) M18™ Compact REDLITHIUM™ battery (48-11-1815)
 - (1) M18™ & M12™ Multi-voltage charger (48-59-1812)
 - (1) Belt clip
 - (1) Carrying case



Part #	Mfg #	Description	Price
164016	2657-20	M18™ 2-Speed 1/4" Hex Impact Driver Kit	

M18 FUEL™ 1/4" Hex Impact Driver Kit

- 1/4" Hex quick change chuck
- 4-Pole frameless motor
- Battery fuel gauge displays remaining run-time
- Torque: 1,600 in-lbs
- No load speed: 0 to 3,600 rpm
- No load IPM: 0 to 2,900
- Variable speed trigger
- Built-in LED light illuminates work surface
- Includes:
 - Impact driver (2653-20)
 - (2) 18V REDLITHIUM™ XC High capacity batteries
 - 30-Minute multi-voltage charger
 - Belt clip
 - Carrying case
- 5-Year warranty



Part #	Mfg #	Description	Price
163681	2653-20	M18 FUEL™ 1/4" Hex Impact Driver (Bare Tool)	
148691	2653-22	Impact Driver Kit	

M18™ 3/8" Compact Impact Wrench with Friction Ring Kit

- Milwaukee® 4-Pole frameless motor
- Milwaukee® engineered impact mechanism
- REDLITHIUM™ battery technology
- REDLINK™ Intelligence
- Includes:
 - (1) M18™ 3/8" compact impact wrench with friction ring (2651-20)
 - (2) M18™ REDLITHIUM™ XC extended capacity battery (48-11-1828)
 - (1) M18™ & M12™ multi-voltage charger (48-59-1812)
 - (1) Carrying case



Part #	Mfg #	Description	Price
152299	2651-22	M18™ 3/8" Compact Impact Wrench with Friction Ring Kit	

Power Tools

M18™ 3/8" Impact Wrench Kit with Friction Ring

- Milwaukee® 4-Pole frameless motor: features a robust design for longer life, more power and more runtime than any brushed competitor
- Milwaukee® designed impact mechanism: delivers maximum power and application speed for greater efficiency on the job
- REDLINK™ Intelligence: provides optimized performance and overload protection using total system communication between tool, battery and charger
- REDLITHIUM™ Battery technology: superior pack construction, electronics, and performance deliver more work per charge and more work over pack life than any battery on the market
- 3/8" Anvil with friction ring
- Includes:
 - (1) M18™ 3/8" Impact wrench with friction ring (bare tool) (2658-20)
 - (2) M18™ REDLITHIUM™ XC Extended capacity battery (48-11-1828)
 - (1) M18™ & M12™ Multi-voltage charger (48-59-1812)
 - (1) Belt clip
 - (1) Carrying case



Part #	Mfg #	Description	Price
166198	2658-22	M18™ 3/8" Impact Wrench Kit with Friction Ring	

M18 FUEL™ 1/2" High Torque Impact Wrench with Friction Ring Kit

- Superior performance: delivers up to 700 ft-lbs of maximum fastening torque, up to 1,100 ft-lbs of nut-busting torque and up to 2X more runtime
- POWERSTATE™ brushless motor: outpowers competitors yet runs cooler with no wearable components
- REDLINK PLUS™ intelligence: allows the operator to choose between 2 fastening modes with Milwaukee's proprietary DRIVE CONTROL™ feature. Mode 1 delivers up to 100 ft-lbs of maximum fastening torque, and Mode 2 up to 700 ft-lbs of maximum fastening torque
- REDLITHIUM™ XC 5.0 battery pack: provides superior pack construction, electronics and performance to deliver 2X more runtime
- 1/2" Anvil with friction ring for fast, easy socket changes
- Includes:
 - (1) M18 FUEL™ 1/2" High torque impact wrench with friction ring (bare tool) (2763-20)
 - (1) M18™ & M12™ Multi-voltage charger (48-59-1812)
 - (2) M18™ REDLITHIUM™ XC5.0 Extended capacity battery pack (48-11-1850)
 - (1) Carrying case



Part #	Mfg #	Description	Price
165987	2763-22	M18 FUEL™ 1/2" High Torque Impact Wrench with Friction Ring Kit	

Power Tools

M18™ 1/2" Compact Impact Wrench with Pin Detent Kit

- Milwaukee® 4-Pole frameless motor: Features a robust design combined with rare-earth magnets for longer life, more power and more runtime than any brushed competitor
- Milwaukee® engineered impact mechanism: delivers maximum application speed for greater efficiency on the job
- REDLITHIUM™ Battery technology: superior pack construction, electronics, and performance deliver more work per charge and more work over pack life than any battery on the market.
- REDLINK™ Intelligence: provides optimized performance and overload protection using total system communication between tool, battery, and charger
- Includes:
 - (1) M18™ 1/2" Compact impact wrench with pin detent (bare tool) (2652-20)
 - (1) M18™ REDLITHIUM™ XC Extended capacity battery (48-11-1828)
 - (1) M18™ REDLITHIUM™ XC Extended capacity battery (48-11-1828)
 - (1) M18™ & M12™ Multi-voltage charger (48-59-1812)
 - (1) Carrying case



Part #	Mfg #	Description	Price
159510	2652-22	M18™ 1/2" Compact Impact Wrench with Pin Detent Kit	

M18™ 1/2" High-Torque Impact Wrench with Friction Ring Kit

- Milwaukee® 4-pole frameless motor
- REDLITHIUM™ battery technology
- REDLINK™ intelligence
- Includes:
 - (1) M18™ 1/2" high-torque impact wrench with friction ring (2663-20)
 - (2) M18™ REDLITHIUM™ XC extended capacity battery (48-11-1828)
 - (1) M18™ & M12™ Multi-voltage charger (48-59-1812)
 - (1) Carrying case



Part #	Mfg #	Description	Price
152298	2663-22	1/2" High-Torque Impact Wrench with Friction Ring Kit	

M18™ Cordless 5/8" SDS Plus Rotary Hammer Kit

- REDLITHIUM™ battery technology: superior pack construction, electronics, and performance deliver more work per charge and more work over pack life than any battery on the market
- Powerful 18-volt motor: delivers 0-1,300 RPM and 0-7,000 BPM
- 2-Mode operation: choose rotary hammer or rotation only for added versatility
- LED light: illuminates dark work spaces



Part #	Mfg #	Description	Price
166128	2612-21	M18™ Cordless 5/8" SDS Plus Rotary Hammer Kit	

M18™ Cordless Lithium-Ion 7/8" SDS-Plus Rotary Hammer Kit

- REDLITHIUM™ Battery technology: Superior pack construction, electronics, and performance deliver more work per charge and more work over pack life than any battery on the market
- Powerful 18-volt motor: Delivers 0-1,400 RPM, 0-4,800 BPM and up to 40% more runtime than the competition
- 1.4 Ft-lbs of torque: Provides 10% faster drilling and up to 35% harder hitting
- 3-Mode operation: Choose rotary hammer, hammer only and rotation only for added versatility
- Mechanical clutch: Protects the motor when the bit binds
- Variable position chisel stop: Allows steel to be adjusted, regardless of orientation
- AVS Anti-vibration system: Minimizes vibration for maximum comfort
- Digital power management: Prevents damage to the tool in harsh jobsite condition



Part #	Mfg #	Description	Price
159511	2605-22	M18™ Cordless Lithium-Ion 7/8" SDS-Plus Rotary Hammer Kit	

Power Tools

M18 Fuel™ Cordless Drills

M18™ FUEL™ 1/2" Hammer Drill/Driver

- POWERSTATE™ brushless motor
- REDLINK PLUS™ Intelligence prevents damage
- No load RPM: 0-550/0-2,000
BPM: 32,000
- Includes:
 - 1/2" 18V Hammer Drill/Driver
 - Side handle
 - Belt clip
- 5-Year warranty



Part #	Mfg #	Description	Price
179573	2704-20	Tool Only, 1,200 in-lbs Torque	

M18 FUEL™ 3/8" Impac Wrench Kit with Friction Ring

- Delivers a best-in class 200 ft-lbs and 2,400 in-lbs of torque in a compact design
- The Milwaukee® POWERSTATE™ brushless motor provides increased efficiency, lasts longer and delivers maximum power
- REDLINK PLUS™ electronic intelligence allows the operator to choose between 3 fastening modes with Milwaukee's proprietary DRIVE CONTROL™ feature
- The Milwaukee® REDLITHIUM™ battery pack is the most durable pack on the market and provides up to 50% more run time
- Utilizes a friction ring design for fast, easy socket changes
- Includes:
 - (1) M18 FUEL™ 3/8" Impact wrench with friction ring (2654-20)
 - (2) M18™ REDLITHIUM™ XC 4.0 Extended capacity battery pack (48-11-1840)
 - (1) M18 & M12™ multi-voltage charger (48-59-1812)
 - (1) Belt clip
 - (1) Carrying case



Part #	Mfg #	Description	Price
158102	2654-22	M18 Fuel™ 3/8" Impact Wrench Kit with Friction Ring	

M18 FUEL™ 1/2" Impact Wrench Kit with Pin Detent

- Delivers a best-in-class 210 ft-lbs and 2,520 in-lbs of torque in a compact design
- The Milwaukee® POWERSTATE™ Brushless Motor provides increased efficiency, lasts longer and delivers maximum power
- REDLITHIUM™ XC 4.0 Battery pack is the most durable pack on the market and provides up to 2X more run time
- REDLINK PLUS™ electronic intelligence allows the operator to choose between 3 fastening modes with Milwaukee's proprietary DRIVE CONTROL™ feature
- Utilizes a pin detent design for maximum socket retention
- Includes:
 - (1) M18 FUEL™ 1/2" Impact wrench with pin detent (bare tool) (2655-20)
 - (2) M18™ REDLITHIUM™ XC 4.0 extended capacity battery pack (48-11-1840)
 - (1) M18™ & M12™ multi-voltage charger (48-59-1812)
 - (1) Belt clip
 - (1) Carrying case



Part #	Mfg #	Description	Price
158103	2655-22	M18 FUEL™ 1/2" Impact Wrench Kit with Pin Detent	

M18™ Cordless Saws

M18™ Sawzall® Reciprocating Saw Kit

- Gear-protecting clutch
- Lever action Quik-Lok™ blade clamp
- Battery fuel gauge displays remaining run-time
- Variable speed trigger
- Includes:
 - Sawzall® 1" Reciprocating saw (2620-20)
 - (1) 1-Hour charger
 - (1) Sawzall® blade
 - Carrying case
- 5-Year warranty



Part #	Mfg #	Description	Price
142639	2620-20	Sawzall® Saw Tool Only	
138283	2620-21	Sawzall® with (1) 18V XC High Capacity Lithium-Ion Batteries	

Power Tools

M18™ HACKZALL® Cordless One-Handed Reciprocating Saw

- Speed: 0 to 3,000 spm
- Stroke length: 3/4"
- Blade clamp: QUIK-LOK™ universal



- Kit includes:
 - M18™ HACKZALL® Reciprocating saw (2625-20)
 - M18™ REDLITHIUM™ XC High capacity battery
 - 10-Hour charger
 - SAWZALL® Blade
 - Contractor bag

Part #	Mfg #	Description	Price
144657	2625-20	Reciprocating Saw Only	
138662	2625-21	Reciprocating Saw Kit	

M18™ Cordless Band Saw

- 3-1/4" Cut capacity
- Tool-free adjustable material shoe
- LED Work light
- Blade ejection system
- Drop resistant pulley guard
- Cast aluminum gear case



- Kit includes:
 - M18™ Band saw
 - (2) M18™ REDLITHIUM™ XC High capacity batteries
 - 1-Hour charger
 - Blade
 - Case
- 5-Year warranty

Part #	Mfg #	Description	Price
143146	2629-22	Band Saw Kit	

M18™ HACKZALL® Recip Saw Kit

- One-handed design provides superior control & versatility
- Compact size allows for cutting in tight spaces, and light weight makes overhead work easier
- Built-in LED light



- Includes:
 - (1) M18™ HACKZALL® Recip Saw (2625-20)
 - (1) M18™ Compact REDLITHIUM Battery (48-11-1815)
 - (1) M18™ & M12™ Multi-Voltage Charger (48-59-1812)
 - (1) Contractor Bag

Part #	Mfg #	Description	Price
150993	2625-21CT	Reciprocating Saw Kit	

M18 FUEL™ 6-1/2" Circular Saw Kit

- POWERSTATE™ Brushless motor: Outpowers all other 18-volt cordless circular saws and provides up to 3X longer tool life
- REDLINK PLUS™ Intelligence: The most advanced electronic system on the market maximizes performance
- REDLITHIUM™ XC 4.0 Battery pack: Offers up to 4X more runtime, 20% more power and up to 2X more recharges than competitive batteries



- Includes:
 - (1) M18 FUEL™ 6-1/2" Circular saw (bare tool) (2730-20)
 - (1) M18™ REDLITHIUM™ XC 4.0 Extender capacity battery pack (48-11-1840)
 - (1) M18™ & M12™ Multi-voltage charger (48-59-1812)
 - (1) Blade
 - (1) Blade wrench
 - (1) Contractor bag

Part #	Mfg #	Description	Price
162303	2730-20	M18 FUEL™ 6-1/2" Circular Saw (Bare Tool)	
161702	2730-22	M18 FUEL™ 6-1/2" Circular Saw Kit	

Tools

Power Tools

M18™ Cordless 6-1/2" Circular Saw

- Speed: 3,500 rpm
- Capacity: 2-1/8" @90° and 1-9/16" @45°
- Arbor: 5/8"
- Blade: 6-1/2" 24T carbide tipped
- Kit includes:
 - M18™ Circular saw (2630-20)
 - (2) M18™ REDLITHIUM™ XC High capacity batteries
 - 1-Hour charger
 - Contractor bag



Part #	Mfg #	Description	Price
138753	2630-22	Circular Saw Kit	

M18™ Cordless Jig Saw

- Speed: 0 to 2,700 SPM
- Stroke length: 1"
- Bevel capacity: 45°
- Kit includes:
 - M18™ Jig saw (2645-20)
 - (2) M18™ REDLITHIUM™ XC High capacity batteries
 - 1-Hour charger
 - Jig saw blade
 - Non-marring shoe
 - Carrying case



Part #	Mfg #	Description	Price
138656	2645-22	Jig Saw Kit	

M18™ Cordless 5-3/8" Metal Saw

- 4-Pole frameless motor
- Speed: 3,600 rpm
- Cut capacity: 1/8" to 2"
- Blade: 5-3/8" 30T carbide-tipped
- Includes:
 - M18™ 5-3/8" Metal saw
 - (2) M18™ REDLITHIUM™ XC High capacity batteries
 - 1-Hour charger
 - 30T Metal Tech™ carbide-tipped blade
 - Blade wrench
 - Contractor bag



Part #	Mfg #	Description	Price
141828	2682-22	Metal Saw Kit	

M18™ Fuel Cordless Saws

M18 Fuel™ Sawzall® Reciprocating Saw Kit

- Delivers faster than corded cutting speed and the durability of a corded saw
- POWERSTATE™ Brushless motor
- REDLINK PLUS™ Intelligence
- REDLITHIUM™ XC 4.0 Battery pack
- 2720-22, 2720-21 Kit Includes:
 - (1) M18 FUEL™ SAWZALL® reciprocating saw (2720-20)
 - (1) M18™ REDLITHIUM™ XC 4.0 extended capacity battery pack (48-11-1840)
 - (1) M18™ & M12™ Multi-voltage charger (48-59-1812)
 - (1) Blade
 - (1) Carrying case



Part #	Mfg #	Description	Price
161655	2720-20	M18 FUEL™ SAWZALL® Reciprocating Saw (Bare Tool)	
161658	2720-21	M18 Fuel™ SAWZALL® Reciprocating Saw Kit	
161581	2720-22	M18 Fuel™ SAWZALL® Reciprocating Saw Kit	

M18™ Lithium-Ion Cordless Press Tools

M18™ ProPEX™ Expansion Tool Kit

- Built-in Auto Rotate Head
- Led Work Light
- Quick Cam Mechanism Delivers Precise Continuous Expansion for 3/8"-1-1/2" ProPEX™
- D-Handle Design and Integrated Magnesium Frame Provides Job site Durability
- Includes:
 - (1) M18™ Cordless LITHIUM-ION ProPEX® Expansion Tool (2632-20)
 - (2) M18™ REDLITHIUM™ XC Extended Capacity Battery (48-11-1828)
 - (1) M18™ & M12™ Multi-Voltage Charger (48-59-1812)
 - (1) ProPEX Expander Cone Grease (49-08-2400)
 - (1) 1" M18™ ProPEX® Expansion Head
 - (1) 1-1/4" M18™ ProPEX® Expansion Head
 - (1) 1-1/2" M18™ ProPEX® Expansion Head



Part #	Mfg #	Description	Price
173693	2632-22XC	2632-22XC M18 Propex EXP Kit XC	

Power Tools

M18™ FORCE LOGIC™ 2"-3" ProPEX® Expansion Tool Kit

- Expands 2", 2-1/2" and 3" Uponor® large diameter PEX pipe
- Auto-rotate mechanism expands Uponor® PEX pipe quickly & evenly
- Auto-cycle: Rotates, expands and resets automatically simplifying installation process
- Intelligent design delivers optimum balance for overhead connections, and flips over for extended use on table-top
- LED light delivers better visibility in lower-lit areas
- Includes:
 - (1) 2-1/2" ProPEX® Expansion head (49-16-2616)
 - (1) 2" ProPEX® Expansion head (49-16-2614)
 - (3) 3" ProPEX® Expansion head (49-16-2618)
 - (2) M18™ REDLITHIUM™ XC 4.0 extended capacity Battery Pack (48-11-1840)
 - (1) M18™ & M12™ Multi-voltage charger (48-59-1812)
 - (1) 150g ProPEX® Expander cone grease (49-08-2401)
 - (1) Carrying case
 - (1) Side handle



Part #	Mfg #	Description	Price
182828	2633-22	M18™ FORCE LOGIC™ 2"-3" ProPEX® Expansion Tool Kit	

M18™ Force Logic™ Press Tool Kit

- Interchangeable jaw for quick adjustment from 1/2" to 2"
- Suitable for 1-hand use
- 5-Second cycle time
- Press force: 7,200 lbs
- 40,000 Cycles between calibrations
- Kit includes:
 - M18™ Force Logic™ press tool (2673-20)
 - (2) M18™ REDLITHIUM™ batteries
 - (6) Jaws - 1/2", 3/4", 1", 1-1/4", 1-1/2" and 2"
 - 30-Minute charger
 - Hard carrying case
- 5-Year warranty on tool
- 2-Year warranty on jaws



Part #	Mfg #	Description	Price
150848	2673-20	Press Tool Only	
150849	2673-22	Press Tool Kit	

M18™ FORCE LOGIC™ Press Tool Kit with 1/2"-2" Jaws

- Lightest, In-line design for unrivaled access
- Auto-cycle ensures full press every time
- Longest calibration interval in the industry at 50,000 cycles
- Industry's first brushless press tool
- In-line design optimized for one-handed presses
- Includes:
 - (1) M18™ FORCE LOGIC™ Press Tool (2773-20)
 - (2) M18™ REDLITHIUM™ 2.0 Compact battery pack (48-11-1820)
 - (1) M18™ & M12™ Multi-voltage charger (48-59-1812)
 - (1) M18™ 1/2" Jaw (49-16-2650)
 - (1) M18™ 3/4" Jaw (49-16-2651)
 - (1) M18™ 1" Jaw (49-16-2652)
 - (1) M18™ 1 1/4" Jaw (49-16-2653)
 - (1) M18™ 1 1/2" Jaw (49-16-2654)
 - (1) M18™ 2" Jaw (49-16-2655)



Part #	Mfg #	Description	Price
229336	2773-20	M18™ Force Logic™ Tool Only	
226110	2773-22	M18™ FORCE LOGIC™ Press Tool Kit with 1/2"-2" Jaws	

M18™ Force Logic Press Tool Jaw



Part #	Mfg #	Jaw Size	Price
150851	49-16-2650	1/2"	
150852	49-16-2651	3/4"	
150853	49-16-2652	1"	
150854	49-16-2653	1-1/4"	
150855	49-16-2654	1-1/2"	
150857	49-16-2655	2"	
150859	49-16-2656	2-1/2"	

Power Tools

M18™ Force Logic Press Tool Ring

- Presses 2-1/2" to 4" pipes



Part #	Mfg #	Ring Size	Price
150860	49-16-2657	3"	
150861	49-16-2658	4"	

M18™ Force Logic Press Tool Ring Jaw 1

- For use with M18™ Force Logic™ standard rings



Part #	Mfg #	Description	Price
150862	49-16-2659	Ring Jaw 1	

M18™ Black Iron Press Ring

- Designed for use on Viega® MegaPress® fittings
- Dual pivot design provides superior close quarter access and uniform pressing force
- Up to 30% lighter than the leading competitor
- Compatible with M18™ force logic press tool. Use with ring jaw 1



Part #	Mfg #	Description	Price
226139	49-16-2655B	M18™ 2" Black Iron Press Ring	

M18™ Short Throw Press Tool Kit w/ Viega PureFlow™ Jaws

- Designed for one handed use
- Auto cycle ensures full press every time
- 40% Faster press
- No calibration interval
- Optimized for residential installs



- Includes
 - (2) M18™ REDLITHIUM™ 2.0 Compact battery pack (48-11-1820)
 - (1) M18™ & M12™ Multi-voltage charger (48-59-1812)
 - (1) M18™ 1/2" Viega PureFlow™ jaw for M18™ short throw press tool (49-16-2631P)
 - (1) M18™ 3/4" Viega PureFlow™ jaw for M18™ short throw press tool (49-16-2633P)
 - (1) M18™ 1" Viega PureFlow™ jaw for M18™ short throw press tool (49-16-2634P)
 - (1) Carrying case

Part #	Mfg #	Description	Price
228433	2674-22P	M18™ Short Throw Press Tool Kit w/ Viega PureFlow™ Jaws	

Power Tools

M18™ Knockout Tools

FORCELOGIC™ M18™ 10 Ton Knockout Tool 1/2" to 2" Kit

- Includes:
- (2) M18™ REDLITHIUM™ XC Extended Capacity Battery (48-11-1828)
- (1) M18™ & M12™ Multi-voltage charger (48-59-1812)
- (1) Exact™ 1/2" Stainless steel die (49-16-2660S)
- (1) Exact™ 1/2" Stainless steel punch (49-16-2661S)
- (1) Exact™ 3/4" Die (49-16-2662)
- (1) Exact™ 3/4" Punch (49-16-2663)
- (1) Exact™ 1" Die (49-16-2664)
- (1) Exact™ 1" Punch (49-16-2665)
- (1) Exact™ 1-1/4" Die (49-16-2666)
- (1) Exact™ 1-1/4" Punch (49-16-2667)
- (1) Exact™ 1-1/2" Die (49-16-2668)
- (1) Exact™ 1-1/2" Punch (49-16-2669)
- (1) Exact™ 2" Die (49-16-2670)
- (1) Exact™ 2" Punch (49-16-2671)
- (1) 7/16" Draw Stud (49-16-2680)
- (1) 3/4" Draw Stud (49-16-2681)
- (1) Ball Stud
- (1) Coupler
- (1) Quick connect collar
- (1) Carrying case



Part #	Mfg #	Description	Price
167335	2676-22	FORCELOGIC™ M18™ 10 Ton Knockout Tool 1/2" to 2" Kit	

FORCELOGIC™ M18™ 10 Ton Knockout Tool 1/2" to 4" Kit

- Includes:
- (1) 1-1/8" Draw Stud
- (2) M18™ REDLITHIUM™ XC extended capacity battery (48-11-1828)
- (1) M18™ & M12™ Multi-voltage charger (48-59-1812)
- (1) EXACT™ 1/2" Stainless steel die (49-16-2660S)
- (1) EXACT™ 1/2" Stainless steel punch (49-16-2661S)
- (1) EXACT™ 3/4" Die (49-16-2662)
- (1) EXACT™ 3/4" Punch (49-16-2663)
- (1) EXACT™ 1" Die (49-16-2664)
- (1) EXACT™ 1" Punch (49-16-2665)
- (1) EXACT™ 1-1/4" Die (49-16-2666)
- (1) EXACT™ 1-1/4" Punch (49-16-2667)
- (1) EXACT™ 1-1/2" Die (49-16-2668)
- (1) EXACT™ 2" Die (49-16-2670)
- (1) EXACT™ 2" Punch (49-16-2672)
- (1) EXACT™ 2-1/2" Die (49-16-2672)
- (1) EXACT™ 2-1/2" Punch (49-16-2673)
- (1) EXACT™ 3" Die (49-16-2674)
- (1) EXACT™ 3" Punch (49-16-2675)
- (1) EXACT™ 3-1/2" Die (49-16-2676)
- (1) EXACT™ 3-1/2" Punch (49-16-2677)
- (1) EXACT™ 4" Die (49-16-2678)
- (1) EXACT™ 4" Punch (49-16-2679)
- (1) 7/16" Draw stud (49-16-2680)
- (1) 3/4" Draw stud (49-16-2681)
- (1) Ball stud
- (1) Coupler
- (1) Quick connect collar
- (2) Carrying case



Part #	Mfg #	Description	Price
167336	2676-23	FORCELOGIC™ M18™ 10 Ton Knockout Tool 1/2" to 4" Kit	

Tools

Power Tools

M18™ Miscellaneous Tools

M18 FUEL™ 4-1/2"/5" Grinder, Paddle Switch No-Lock Kit

- **POWERSTATE™** Brushless motor: delivers maximum power and up to 10X longer motor life
- **REDLINK PLUS™** Intelligence provides optimized performance, electronic clutch, and overload protection using total system communication between tool, battery, and charger
- **REDLITHIUM™** XC 4.0 Battery pack provides superior pack construction, electronics, and performance to deliver 2X more run-time and more work over pack life
- **Power TO GRIND:** World's first cordless grinder with corded performance
- **DURABILITY:** Same metal housing & gearing system as legendary high performance corded grinders
- **100% tool free:** Make all accessory changes and guard adjustments without a wrench for increased productivity
- **Paddle-switch design:** provides increased comfort and ease-of-use when operating in various positions
- **Includes:**
 - (1) M18 FUEL™ 4-1/2"/5" Grinder, paddle switch no-lock (bare tool) (2780-20)
 - (2) M18™ REDLITHIUM™ XC5.0 Extended capacity battery pack (48-11-1850)
 - (1) M18™ & M12™ Multi-voltage charger (48-59-1812)
 - (1) Carrying case
 - (1) Flange nut
 - (1) Spanner wrench
 - (1) Wheel guard



Part #	Mfg #	Description	Price
162116	2780-20	M18 FUEL™ 4-1/2"/5" Grinder, Paddle, Switch No-Lock (Bare Tool)	
164099	2780-22	M18 FUEL™ 4-1/2"/5" Grinder, Paddle Switch No-Lock Kit	

M18™ Tool Box Style Wet/Dry Vacuum

- On-board accessory and hose storage
- HEPA Rated high efficiency filter
- **Includes:**
 - Wet/dry vacuum
 - Filter assembly
 - Crevice tool
 - Wide utility nozzle
 - Wireless vinyl hose
- Battery and charger not included



Part #	Mfg #	Description	Price
136036	0880-20	2 gal, 18V	

M18™ Compact Vacuum

- High performance motor
- Adapts from handheld to stationary
- 40 CFM
- Removable HEPA filter
- Clear view and easy to empty canister
- Canister volume: 36oz
- Inlet diameter: 1 1/4"
- **Includes:**
 - (1) M18™ Compact vacuum (0882-20)
 - (1) Crevice tool
 - (2) Extension
 - (1) HEPA filter



Part #	Mfg #	Description	Price
228972	0882-20	M18™ Compact Vacuum	

M18™ Cordless 2-Speed Grease Gun Kit

- Industry leading 10,000 PSI max operating pressure
- Industry leading max flow-rate of up to 10oz / minute
- New to world precision through Pre-set grease counter dial
- 48" flexible hose offers greater access to difficult to reach fittings
- Air bleeder valve for quick priming
- M18™ REDLITHIUM™ System
- Lock-on/ Lock-off trigger delivers added user convenience
- **Includes:**
 - (1) M18™ Cordless 2-speed grease gun (2646-20)
 - (1) 48" Flex hose w/spring guard
 - (2) M18™ Compact REDLITHIUM™ battery (48-11-1815)
 - (1) M18™ & M12™ Multi-voltage charger (48-59-1812)
 - (1) High pressure grease coupler
 - (1) Hard carrying case
 - (1) Shoulder strap



Part #	Mfg #	Description	Price
160459	2646-20	M18™ Cordless 2-Speed Grease Gun (Bare Tool)	
160923	2646-22CT	M18™ Cordless 2-Speed Grease Gun Kit	

Power Tools

M18™ Cordless 18g Double Cut Shear

- 360° Tool-free rotating head
- Ergonomic body design
- Variable speed trigger
- Belt clip
- 5-Year warranty



Part #	Mfg #	Description	Price
180620	2635-20	M18™ Cut Shear - Tool Only	

M18™ Jobsite Radio

- Digital AM/FM tuner w/ 10 station presets
- Customizeable EQ (Equalizer)
- 2.1A USB Charger for all portable electronic devices
- 3.5mm Aux In Port for wired playback (cable included)
- Powered by all M18™ Batteries or A/C outlet (battery not included)
- Up to 12hrs run time with an M18™ 5.0Ah battery
- Weather sealed auxillary compartment



Part #	Mfg #	Description	Price
185219	2890-20	M18™ Job Site Radio	

M18™ Job site Radio/Charger

- Built-In charger: Quick, convenient charging of all M18™ batteries
- Exclusive digital Bluetooth® receiver
- USB power port
- Premium speakers and 40-watt amplifier
- Customizable equalizer and 10-station preset
- Reinforced roll cage and metal handles
- Weather-sealed compartment: offers on-board protection for small belongings and a smart phone
- On-board bottle opener
- Includes:
 - (1) M18™ Job site radio/charger (2792-20)
 - (1) 16" Auxiliary input cord
 - (2) AAA batteries



Part #	Mfg #	Description	Price
163377	2792-20	M18™ Job Site Radio/Charger	

M18™ Compact Blower (Bare Tool)

- 3-Speed electronic switch and variable speed trigger allow for versatile clearing power
- Lock-on switch reduces user fatigue
- Extension nozzle clears dust and debris easily from the ground or overhead without having to lean over or stretch
- Universal inflator/deflator for easy set-up and take-down of most inflatable products
- Shock-absorbing polymer and reinforced handle resists drops
- Nozzle made from soft plastic to resist crushing or cracking



Part #	Mfg #	Description	Price
163737	0884-20	M18™ Compact Blower (Bare Tool)	

M18™ Jobsite Fan

- Powerful airflow system: Circulates air over 40 feet
- Provides up to 17 hours of runtime on an REDLITHIUM™ XC5.0 battery
- Adjustable head: 120° adjustable head, and 9 stopping positions, provide best control of airflow direction
- AC adaptor included for extended run-time
- Four keyhole hangers and two hanging holes allow for multiple hanging orientations
- Compatible with all M18™ REDLITHIUM™ batteries



Part #	Mfg #	Description	Price
176814	0886-20	M18™ Jobsite Fan	

Power Tools

M18™ Tool Combo Kits

M18 FUEL™ 2 Tool Combo Kit

- Includes:
 - (1) M18 FUEL™ 1/2" Hammer drill/driver (bare tool) (2604-20)
 - (1) M18 FUEL™ SAWZALL® reciprocating saw (bare tool) (2720-20)
 - (2) M18™ REDLITHIUM™ XC 4.0 Extended capacity battery pack (48-11-1840)
 - (1) M18™ & M12™ Multi-voltage charger (48-59-1812)
 - (1) Contractor bag
 - (1) 6" 10 TPI thin kerf SAWZALL® blade



Part #	Mfg #	Description	Price
166501	2794-22	M18 FUEL™ 2 Tool Combo Kit	

M18™ Cordless 2-Tool Combo Kit with DPM™

- Digital power management protection prevents damage to the tool and battery in abusive situations
- Includes:
 - 1/2" Hammer-Drill driver (2602-20)
 - 1/4" Hex impact driver (2650-20)
 - (2) REDLITHIUM™ High capacity batteries
 - 1-Hour charger
 - Contractor bag
 - 5-Year warranty



Part #	Mfg #	Description	Price
139154	2697-22	18V	

M18™ Cordless LITHIUM-ION 2-Tool Combo Kit

- Includes:
 - (1) M18™ Compact 1/2" drill driver (bare tool) (2606-20)
 - (1) M18™ 1/4" Hex impact driver (bare tool) (2656-20)
 - (2) M18™ Compact REDLITHIUM™ battery (48-11-1815)
 - (1) M18™ & M12™ Multi-voltage charger (48-59-1812)
 - (1) Contractor bag



Part #	Mfg #	Description	Price
153676	2691-22	M18™ Cordless LITHIUM-ION 2-Tool Combo Kit	

M18™ Cordless LITHIUM-ION 2-Tool Combo Kit

- Includes:
 - (1) M18™ Compact 1/2" Hammer drill/driver (bare tool) (2607-20)
 - (1) M18™ SAWZALL® Recip saw (bare tool) (2620-20)
 - (1) M18™ REDLITHIUM™ XC Extended capacity battery (48-11-1828)
 - (1) M18™ & M12™ Multi-Voltage charger (48-59-1812)
 - (1) Contractor bag



Part #	Mfg #	Description	Price
155644	2694-22	M18™ Cordless LITHIUM-ION 2-Tool Combo Kit	

M18™ Cordless 4-Tool Combo Kit (1)

- Includes:
 - 1/2" Hammer drill driver (2602-20)
 - Sawzall® reciprocating saw (2620-20)
 - 6-1/2" Circular saw (2630-20)
 - Work light (49-24-0171)
 - (2) REDLITHIUM™ XC High capacity batteries
 - 1-Hour charger
 - (1) Sawzall® blade
 - Contractor bag



Part #	Mfg #	Description	Price
137564	2694-24	18V	

M18™ Cordless 4-Tool Combo Kit (2)

- Includes:
 - M18™ 1/2" Hammer drill driver (2602-20)
 - M18™ HACKZALL® Reciprocating saw (2625-20)
 - M18™ 1/4" Hex Impact driver (2650-20)
 - M18™ Work light (49-24-0171)
 - (2) M18™ REDLITHIUM™ XC High capacity batteries (48-11-1828)
 - 1-Hour charger (48-59-1801)
 - General purpose Sawzall® blade
 - Contractor bag



Part #	Mfg #	Description	Price
138971	2695-24	18V	

Power Tools

M18™ Cordless 4-Tool Combo Kit (3)

Includes:

- 1/2" Hammer drill driver (2602-20)
- 1/4" Hex impact driver (2650-20)
- Sawzall® M18™ reciprocating saw (2620-20)
- Work light (49-24-0171)
- (2) REDLITHIUM™ XC High capacity batteries
- 1-Hour charger
- General purpose Sawzall® blade
- Contractor bag



Part #	Mfg #	Description	Price
138527	2696-24	18V	

M18 FUEL™ LITHIUM-ION 4-Tool Combo Kit

Includes:

- (1) M18 FUEL™ 1/2" Hammer Drill/Driver (bare tool) (2604-20)
- (1) M18 FUEL™ 1/4" Hex impact driver (bare tool) (2653-20)
- (1) M18 FUEL™ SAWZALL® Reciprocating saw (bare tool) (2720-20)
- (1) M18™ LED Work light (2735-20)
- (1) M18™ REDLITHIUM™ XC 4.0 Extended capacity battery pack (48-11-1840)
- (1) M18™ & M12™ Multi-voltage charger (48-59-1812)
- (1) Belt clip
- (1) Contractor bag
- (1) Reciprocating blade



Part #	Mfg #	Description	Price
164933	2796-24	M18 FUEL™ LITHIUM-ION 4-Tool Combo Kit	

M18 FUEL™ LITHIUM-ION 6-Tool Combo Kit

Includes:

- (1) M18 FUEL™ 1/2" Hammer Drill/Driver (bare tool) (2604-20)
- (1) M18 FUEL™ 1/4" Hex impact driver (bare tool) (2653-20)
- (1) M18 FUEL™ SAWZALL® Reciprocating saw (bare tool) (2720-20)
- (1) M18 FUEL™ 6-1/2" Circular saw (bare tool) (2730-20)
- (1) M18™ LED work light (2735-20)
- (1) M18 FUEL™ 4-1/2"/5" Grinder, paddle switch no-lock (bare tool) (2780-20)
- (2) M18™ REDLITHIUM™ XC 4.0 Extended capacity battery pack (48-11-1840)
- (1) M18™ & M12™ Multi-voltage charger (48-59-1812)
- (1) Belt clip
- (1) Circular saw blade
- (2) Contractor bag
- (1) Reciprocating blade
- (1) Spanner wrench



Part #	Mfg #	Description	Price
164934	2796-26	M18 FUEL™ LITHIUM-ION 6-Tool Combo Kit	

M18™ Cordless LITHIUM-ION 9-Tool Combo Kit

Includes:

- (1) M18™ Cordless 1/2" hammer drill/driver (2602-20)
- (1) M18™ Cordless right angle drill (2615-20)
- (1) M18™ SAWZALL® Recip saw (2620-20)
- (1) M18™ Cordless LITHIUM-ION 6 -1/2" circular saw (2630-20)
- (1) M18™ Cordless LITHIUM-ION jig saw (2645-20)
- (1) M18™ 1/4" Hex compact impact driver (2650-20)
- (1) M18™ 1/2" High-torque impact wrench with friction ring (2663-20)
- (1) M18™ Cordless LITHIUM-ION 4-1/2" cut-off/grinder (2680-20)
- (2) M18™ REDLITHIUM™ XC Extended capacity battery (48-11-1828)
- (1) M18™ & M12™ Multi-voltage charger (48-59-1812)
- (1) M18™ Work light (49-24-0171)



Part #	Mfg #	Description	Price
156090	2696-29	M18™ Cordless LITHIUM-ION 9-Tool Combo Kit	

Tools

Power Tools

Drills

3/8" Pistol Drill

- 8 Amp motor
- 120VAC Only
- Keyless, metal chuck type
- All metal gear case
- Soft grip handle and 2-finger trigger
- 8' Cord
- Includes:
 - 3/8" Drill
 - Side handle



Part #	Mfg #	No Load RPM	Price
139060	0240-20	0 - 2,800	

5/8" SDS Plus Rotary Hammer Kit

- Powerful 5.5 amp motor: Delivers 0-3,700 RPM, 0-4 400 BPM and 1.5 ft-lbs of torque, providing up to 65% faster drilling speeds
- Lightweight 4.6-lb design: Reduces fatigue when you drill overhead and in horizontal applications
- Compact 10.9" profile: Lets you work more efficiently in tight spaces
- 2-Mode operation: Choose rotary hammer or rotation only for added versatility
- AVS Anti-Vibration System: Minimizes vibration for maximum comfort
- Mechanical clutch: Protects the motor when the bit binds



Part #	Mfg #	Description	Price
164855	5263-21	5/8" SDS Plus Rotary Hammer Kit	

1-9/16" Spline Rotary Hammer

- Powerful 10.5 amp motor: Delivers 450RPM and 3,000 BPM
- Powerful hammer mechanism: Delivers 5.5 ft-lbs of impact energy for drilling in hard aggregate
- CPT™- Constant power technology: Delivers consistent performance in tough applications
- Mechanical clutch: Protects the tool when the bit binds up
- 2-Mode operation: Rotary hammer and hammer only for maximum versatility
- 12-Position chipping adjustment: Allows the user to maintain the desired hammer position while chipping in any orientation



Part #	Mfg #	Description	Price
153749	5316-21	1-9/16" Spline Rotary Hammer	

1-9/16" SDS Max Rotary Hammer

- Powerful 10.5 Amp motor: Delivers 450 RPM and 3,000BPM
- Powerful hammer mechanism: Delivers 5.5 ft-lbs of impact energy for drilling in hard aggregate
- CPT™- Constant power technology: Deliver consistent performance in tough applications
- Mechanical clutch: Protects the tool when the bit binds up
- 2-mode operation: Rotary hammer and hammer only for maximum versatility
- 12-Position chipping adjustment: Allows the user to maintain the desired hammer position while chipping in any orientation



Part #	Mfg #	Description	Price
159786	5317-21	1-9/16" SDS Max Rotary Hammer	

Power Tools

1/2" Hole Hawg® Drill 900 RPM

- Powerful 7.5-amp motor: Delivers 900 RPM with reverse
- Selffeed bit capacity: Handles up to a 2-9/16"
- Reinforced nylon resin casing: Provides durability and a reduced weight with greater heat dissipation and resistance to chemicals
- Includes:
 - (1) 1/2" Hole Hawg® Drill 900RPM (1670-1)
 - (1) Pipe handle



Part #	Mfg #	Description	Price
224919	1670-1	1/2" Hole Hawg® Drill 900 RPM	

3/4" Large Drill, 350 RPM

- Powerful 10.0-amp motor. Delivers up to 350RPM with reverse
- Torque: Offers 3/4" capacity in steel
- Heat-treated gears: Helical-cut for quiet performance
- 8-ft fixed rubber cord: Durable construction
- Includes:
 - (1) 3/4" Large Drill (1854-1)
 - (1) Pipe Handle



Part #	Mfg #	Description	Price
151479	1854-1	1854-1 3/4" 120V 350RP Drill	

1/2" Magnum® Drill

- Motor: 120VAC 8A
- 360° Locking side handle
- Chuck key with holder
- 8' Cord



Part #	Mfg #	No Load RPM	Price
139067	0299-20	0 - 850	
184121	0300-20	1/2" Magnum® Drill, 0-850 RPM	

Right Angle Drill Kits

1/2" Reversing Right Angle Drill Kit

- 120VAC, 7.0A R.A.D.
- 1/2" Trigger speed control reversing
- All ball and roller bearings
- Helical cut, heat treated gears
- Durable, glass reinforced nylon handles
- Use with up to 4-5/8" self-feed bits
- Steel hardened shafts
- Head and handle swivel 360°
- Locks tight in any position
- Allow 5-1/2" for right angle drill head and chuck
- Quadruple gear train
- Includes:
 - Chuck key and rubber flex key holder
 - Right angle drive
 - 9/16" Open end wrench
 - 3/16" Socket wrench
 - Chuck remover bar
 - Side handle
 - Steel carrying case
 - 8' 3-Wire Quik-Lok® cord set



Part #	Mfg #	Kit Type	Drill RPM	Amps	Price
137799	3107-6	Variable	0-500	7.0	

Super Hawg™ Drills

M18™ FUEL™ Super Hawg™ 1/2" Right Angle Drill Kit

- POWERSTATE™ brushless motor
- REDLINK™ PLUS intelligence ensures optimal performance and overload protection
- Includes:
 - M18™ FUEL™ 1/2" Right Angle Drill
 - M18™ REDLITHIUM™ battery pack
 - M18™&M12™ rapid charger
 - Chuck key
 - Side handle
 - Contractor bag
- 5-Year warranty



Part #	Mfg #	Description	Price
181107	2709-22	M18™ FUEL™ Super Hawg Kit	

Power Tools

Super Hawg™ 1/2" Drill

- Clutch in low speed
- High operating speeds for maximum productivity
- 90° Left-right, Roto-Lok® handle
- Comfort grip switch handle and gear case with front T-bar handle
- Includes side handle
- 1680-21 Includes carrying case
- 5-Year warranty



Part #	Mfg #	No Load RPM	Steel Capacity	Price
148643	1680-20	450/1,750	1/2"	
137572	1680-21	450/1,750	1/2"	

Hole-Hawg® Hole-Hawg® Drill

- 120VAC, 7.5A
- Compact design for drilling between studs and joists
- Heat treated gears
- All ball and roller bearings
- Triple reduction gearing
- 2-Position pipe handle
- 3-Position spade handle
- 2-Speed gear shift
- External brush caps
- Includes steel carrying case



Part #	Mfg #	No Load RPM	Price
144516	1676-6	300/1,200	

Circular Saws

TILT-LOK™ 7-1/4" Circular Saw with Case

- New exclusive TILT-LOK™ main handle adjusts to the work or most comfortable work position
- 10.4 pounds net weight
- 15 amp, 3.25 peak horsepower
- Wide, clear sight line
- Includes:
 - (1) TILT-LOK™ 7-1/4" Circular Saw with case (6390-21)
 - (1) Blade wrench
 - (1) Carrying case
 - (1) Circular saw blade



Part #	Mfg #	Description	Price
154578	6390-21	TILT-LOK™ 7-1/4" Circular Saw with Case	

8" Metal Cutting Saw Kit

- Dry-cut technology provides faster, cleaner, more affordable metal cutting
- Durable blade shields with integral chiptank deflects/collects hot chips and sparks
- Plunge lever for fast, effective plunge cuts
- Exclusive quick-release shield latch for fast waste disposal and blade changes
- 2-9/16 in cut depth for one-pass cuts through most common materials
- Powerful 13.0 amp, 3,700 rpm motor
- Premium cermet-tipped blades cut faster, cleaner, and longer than other carbide-tipped or friction blades



Part #	Mfg #	Description	Price
161013	6370-21	8" Metal Cutting Saw Kit	

Sawzall® Reciprocating Saws

13 Amp Orbital Super Sawzall® with Case

- Orbital cutting action
- Variable speed trigger
- Quik-Lok™ blade clamp
- 8' Cord
- 5-Year warranty



Part #	Mfg #	Length of Stroke	Strokes Per Minute	Price
148168	6536-21	1-1/4"	0 - 3,000	

Tools

Power Tools

12 Amp Sawzall® Reciprocating Saw

- Quik-Lok™ blade clamp
- Gear protecting clutch
- Counter weighted mechanism
- Includes:
 - (1) Sawzall® blade
 - Carrying case
- 5-Year warranty



Part #	Mfg #	Length of Stroke	Strokes Per Minute	Price
137571	6509-31	3/4"	0 - 3,000	

360° Rotating Handle Orbital Super Sawzall® Recip Saw

- 360° Rotating handle
- 13 Amp Milwaukee built motor
- Orbital cutting action
- Variable speed trigger, 0-3000 SPM
- 1-1/4in stroke
- Counter balanced/gear protection systems
- Speed dial
- QUIK-LOK™ blade clamp
- QUIK-LOK® cord
- Includes:
 - (1) 360° Rotating handle orbital super Sawzall® recip saw (6523-21)
 - (1) Carrying case



Part #	Mfg #	Description	Price
154278	6523-21	360° Rotating Handle Orbital Super Sawzall® Recip Saw	

Band Saws

Compact Band Saw

- 120VAC
- 7.0A Motor, 3-wire, 8' cord
- LED Work light
- Blade ejection system
- Drop-resistant pulley guard
- Cast aluminum gear case
- Adjustable material guide
- Maximum rectangular capacity: 3-1/4" x 3-1/4"
- Maximum round capacity: 3-1/4"
- Includes:
 - Band saw
 - Case
- 5-Year warranty



Part #	Mfg #	No Load SFPM	Price
142295	6242-6	200 - 300	

Abrasive Cut-Off Machines

14" Abrasive Cut-Off Machine

- Cuts up to 5" pipe
- Oversized wheel guards
- Miter capacity: 45° with adjustable fence
- Large spindle lock button
- Includes:
 - Vise
 - Abrasive wheel
 - Hex wrench
- 5-Year warranty



Part #	Mfg #	Description	Price
142284	6177-20	120VAC/DC, 15 Amps	

Tools

Power Tools

14" Hand Held Cut-Off Machine

- *Powerful 15-amp, 4.8 maximum horsepower motor: Delivers maximum cutting performance for heavy-duty concrete and metal cutting*
- *20-amp overload protection switch: Trips the tool, not a remote breaker, for greater convenience and minimal downtime*
- *Downward cutting rotation: Pulls the tool through the work to minimize jamming and kickback while providing a clear sight-line*
- *Externally accessible brushes and brush cutoff feature: Protect the epoxy-coated armature as the brushes wear down*



Part #	Mfg #	Description	Price
161844	6185-20	14" Hand Held Cut-off Machine	

Sanders

5" Random Orbit Palm Sander

- *3.0A Motor*
- *Permanent magnet motor*
- *Variable speed dial*
- *Integrated Vacuum ports: 1-1/4" & 2-1/4"*
- *Includes:*
 - *Carrying case*
 - *Dust bag*
 - *PSA Pad*
 - *Hook and loop pad*
 - *(2) Sheets 80 grit 8-hole sandpaper*



Part #	Mfg #	Speed RPM	Disc Dia	Price
139047	6021-21	12,000	5"	

Grinders

11 AMP 4-1/2" Small Angle Grinder Paddle, Lock-On

- *Powerful 11 AMP, 11,000 RPM motor*
- *Overload Protection*
- *Electronic Clutch*
- *Tool-Free accessory change*
- *Tool-Free adjustable guard*
- *Advanced airflow system*
- *Debris baffles*
- *Includes:*
 - (1) 11 Amp 4-1/2" small angle grinder paddle, lock-on (6146-30)
 - (1) Contractor bag
 - (1) Flange
 - (1) Grinding wheel
 - (1) Side handle
 - (1) Spanner wrench
 - (1) Type 27 guard



Part #	Mfg #	Description	Price
158930	6146-30	11 Amp 4-1/2" Small Angle Grinder Paddle, Lock-On	

Misc. Tools

1-Stage Wet/Dry Vacuum Cleaner

- *10 gal, 1-1/8 bu. recovery capacity, 8.0 amp motor*
- *Positive water shut-off*
- *Can be used as a blower*
- *One-stage bypass motor for wet/dry operation*



Part #	Mfg #	Description	Price
176821	8955	1-Stage Wet/Dry Vacuum Cleaner	

Power Tools

14 Gauge Shear

- 5 amps, 4,000 SPM
- Clear unobstructed visibility
- Cuts close curves either left or right
- Blade design eliminates jamming



Part #	Mfg #	Description	Price
176044	6815	14 Gauge Shear	

10 Gauge Nibbler

- 4.0 amp, 1,000 SPM
- Cuts up to 8.75ft per minute
- 1.65 in. starting hole required
- AC-DC toggle switch allows for two-handed operation



Part #	Mfg #	Description	Price
176046	6880	10 Gauge Nibbler	

Temperature Guns

Infrared Laser TEMP-GUN™ Thermometer Kit

- Basic accuracy: 1.50%
- Distance to spot: 12 to 1
- Includes:
 - Laser TEMP-GUN™ thermometer
 - (3) AA Alkaline batteries
 - K-Type thermocouple
 - Slide rail system
- 5-Year warranty



Part #	Mfg #	Temperature Range	Price
137568	2266-20	-20° to 932°F	

Heat Guns

Dual Temperature Heat Gun

- Dual temperature 570 and 1000 degrees F, 11.6 amp motor
- Unique impact resistant heating element
- Three position rock switch - off, high and low



Part #	Mfg #	Description	Price
161906	8975-6	Dual Temperature Heat Gun	

Cordless Batteries and Accessories

12V Lithium-Ion Battery

- Over 65% lighter than "compact" NiCd batteries
- For use with Milwaukee® 12V cordless tools
- 2-Year warranty



Part #	Mfg #	Description	Price
137574	48-11-2401	12V Lithium-Ion Battery	

M12 REDLITHIUM™ Compact Battery Two Pack

- 1.5 Amp hour
- Lightweight - Over 65% lighter vs "compact NiCd batteries"
- Compact - Over 50% smaller vs "compact NiCd batteries"
- LITHIUM-ION battery delivers long life and run time with fade-free power
- Battery fuel gauge displays charge status on tool
- For use with Milwaukee M12 cordless tools



Part #	Mfg #	Description	Price
154721	48-11-2411	M12 REDLITHIUM™ Compact Battery Two Pack	

M12 REDLITHIUM™ XC Battery Two Pack

- 3.0 Amp hour
- High current discharge
- Sturdy base- Allows M12™ tools to easily stand
- LITHIUM-ION battery delivers long life and run time with fade-free power
- Battery fuel gauge displays charge status on tools
- M12™ Compatibility



Part #	Mfg #	Description	Price
171802	48-11-2412	M12 REDLITHIUM™ XC Battery Two Pack	

M18™ REDLITHIUM™ 2.0 Compact Battery Pack

- REDLINK™ Intelligence
- Best-in-class construction
- Fuel gauge onboard
- All-weather performance



Part #	Mfg #	Description	Price
154722	48-11-1820	M18™ REDLITHIUM™ 2.0 Compact Battery Pack	

Power Tools

M18™ REDLITHIUM™ XC 4.0 Extended Capacity Battery Pack

- REDLINK™ Intelligence
- Best-in-class construction
- Fuel gauge onboard
- All-weather performance
- Versatility: Powers more than 40 Milwaukee M18™ cordless power tools



Part #	Mfg #	Description	Price
158199	48-11-1840	M18™ REDLITHIUM XC 4.0 Extended Capacity Battery Pack	

M18™ REDLITHIUM™ XC5.0 Extended Capacity Battery Pack

- REDLINK™ Intelligence: Provides optimized performance and overload protection using total system communication between tool, battery and charger
- Best-in-class construction
- Fuel gauge onboard
- All-weather performance
- Versatility- Powers more than 60 Milwaukee® M18™ cordless power tools



Part #	Mfg #	Description	Price
173430	48-11-1850	M18™ REDLITHIUM™ XC5.0 Extended Capacity Battery Pack	

M18 REDLITHIUM™ High Capacity Battery Two Pack

- 3.0 Amp hour
- LITHIUM-ION battery delivers long life and run time with fade-free
- Battery fuel gauge
- Overload protection
- Temperature management system
- Individual cell monitoring
- Discharge protection
- Best in class construction
- Integrated weld frame
- Cell separator
- Impact and vibration protective rubber



Part #	Mfg #	Description	Price
154296	48-11-1822	M18 REDLITHIUM™ High Capacity Battery Two Pack	

18V Ni-Cd Battery

- Works with all 18V NiCd and V18 tools excluding:
 - 1108
 - 3108
 - 5364
 - 6516



Part #	Mfg #	Description	Price
139148	48-11-2230	Easy Release Latch	

28V Lithium-Ion Battery

- Overload protection
- Temperature management system
- Individual cell voltage monitoring
- Discharge protection
- Battery fuel gauge
- 3-Year warranty



Part #	Mfg #	Description	Price
142696	48-11-2830	28V Lithium-Ion Battery	

M12™ Power Source

- 2.1 amp powered USB port charges all portable electronic devices, including tablets
- On-board fuel gauge
- Compatible with all M12™ battery packs
- Compatible with all M12™ heated gear



Part #	Mfg #	Description	Price
161648	49-24-2310	M12™ Power Source	

M12™ Lithium-Ion Battery Charger

- 30-Minute charge time
- 5-Year warranty



Part #	Mfg #	Description	Price
137575	48-59-2401	12V Lithium-Ion Battery Charger	

Power Tools

M12™ Four Bay Sequential Charger

- Accepts up to 4 M12™ Battery Packs
- Sequentially charges batteries
- Compact design with wall mount
- REDLINK™ Intelligence: charger communication with the battery pack to ensure optimum performance and extend life



Part #	Mfg #	Description	Price
173929	48-59-1204	M12™ Four Bay Sequential Charger	

M28™ 3-Bay Universal Charger

- Single-unit simplicity: Milwaukee M28™ lithium-ion, V18 Lithium-ion and NiCd batteries
- Durable construction: Withstands tough job site conditions
- 9-ft. Pass-through plug
- High-visibility LED light: Displays charge status from across the room



Part #	Mfg #	Description	Price
164783	48-59-0280	M28™ 3-Bay Universal Charger	

M18™ Six Pack Sequential Charger

- Charges up to six batteries sequentially
- Convenient carrying handle
- Pass through plug
- Compact size



Part #	Mfg #	Description	Price
154534	48-59-1806	M18™ Six Pack Sequential Charger	

M18™ and M12™ Multi-Voltage Battery Charger

- 12V and 18V
- 5-Year warranty



Part #	Mfg #	Description	Price
148692	48-59-1812	M18™ and M12™ Battery Charger	

M18™ Lithium-Ion AC/DC Wall & Vehicle Charger

- AC Wall charger and DC vehicle charger
- Charges all M18™ batteries
- Charge times:
 - 48-11-1815: 30-Minute
 - 48-11-1828: 1-Hour
 - 48-11-1820: 45-Minute
 - 48-11-1840: 90-Minute



Part #	Mfg #	Description	Price
138273	2710-20	18V	

Cut-Off Machine Accessories

.045" x 7/8" Cut-Off Wheel

- For general purpose to specialized high performance applications
- Consistent performance from wheel to wheel
- Tested for balance, resulting in smooth, vibration free grinding and cutting



Part #	Mfg #	Size	Type	Price
138407	49-94-4500	4-1/2"	1	
162159	49-94-4520	4-1/2"	1/4"	

3/32" x 1" Cut-Off Wheel

- For general purpose to specialized high performance applications
- Consistent performance from wheel to wheel
- Tested for balance, resulting in smooth, vibration free grinding and cutting

Part #	Mfg #	Size	Type	Price
140073	49-94-1405	14"	1	

Milwaukee® Parts

Bit Holder

Part #	Mfg #	Description	Price
150713	43-72-0550	Bit Holder	

Screws, Nuts & Bolts

Part #	Mfg #	Description	Price
150710	06-82-5275	6-32" x 5/16" Torx Head Screw	

Power Tools

Pipe Inspecting and Locating

SeeSnake® micro™ Inspection Camera

- Allows you to easily perform visual inspections in hard to reach areas
- Lightweight, hand-held design can be carried anywhere
- 3' Cable reach expandable to 30' with optional extensions
- Includes batteries, mirror, hook and magnet



Part #	Mfg #	Display	Diameter	Lighting	Power Source	Price
141173	36738	3.5" Color LCD	17mm	(4) Adj LEDs	(4) AA Batteries	

Tools

Refrigeration Tools

Refrigerant Piping and Components

Rotary Vane Deep Vacuum Pump

- Internal check valve stops oil blowout in case of accidental power loss
- Gas ballast valve helps prevent oil contamination caused by high moisture
- Manifold valve isolates pump from system when testing for leaks
- Center oil fill port is accessible from front & sides
- Durable light weight die cast aluminum housing
- Delrin vanes for quieter, longer-lasting performance
- 2-Stage for lower pumping pressure
- Oil drain valve at bottom of oil reservoir
- 25 Microns ultimate vacuum
- Electrical Specs: 120V/60Hz (2-Stage_



Part #	Mfg #	Free Air Displace	Motor	Nom Pump Speed	Price
150637	90066-2V-110	6 CFM	1/3 hp	3440 rpm	

ACCU-Charge II Electronic Refrigerant Scale

- Functions:
 - Charge programming
 - Pause/charge
 - Tank capacity programming (empty/full)
 - Repeat
- Capacity: 240 lbs
- Auto off: 3 hours
- Operating temperature: 32° to 120°F
- Battery life approximately 40 hours (9 VDC)



Part #	Mfg #	Description	Price
140934	98210-A	9" x 9" Platform	

Pro-Set® Cyclone Refrigerant Recovery Machine

- Fastest overall ARI certified recovery rates in its class in all temperature environments
- Automatic low pressure shut-off feature turns unit off when recovery is completed
- Rugged high density double walled plastic housing with easy view top mounted controls
- R-410A Ready with 550 psi high pressure shut-off switch
- Ergonomic well balanced design for easy transport including shoulder strap, weighs 36 lbs
- Built-in suction filter located under suction port



Part #	Mfg #	Description	Price
112428	87-CR700	1 hp Oil-Less Cyclone	

Tools

Refrigeration Tools

Electronic Digital Vacuum Gauge

- Large 5 digit LCD display
- Measurement units are selectable for microns, in/hg, mBar, Torr. Advanced field
- Cleanable sensor can withstand 400 psi positive pressure
- Operates 30 hours on standard 9V alkaline battery



Part #	Mfg #	Description	Price
113610	87-VG200	Digital Gauge, Carry Hook, Tee, 9V Battery & Case	

Brass Access Tee - Sweat

- One valve core included for each tee
- All male flare fittings are internally threaded to accept installation of valve core
- Includes brass cap for use with core wrench



Part #	Mfg #	Fitting 1	Fitting 2	Branch Fitting	Body	Price
092124	83-CC8414-2Pk	1/4" Sweat ODF	1/4" Sweat ODF	1/4" SAE Flare	Copper	
080959	83-CC8438-2Pk	3/8" Sweat ODF	3/8" Sweat ODF	1/4" SAE Flare	Copper	
080956	83-CC8412-2Pk	1/2" Sweat ODF	1/2" Sweat ODF	1/4" SAE Flare	Copper	

Brass Access Tee - Threaded

- One valve core included for each tee
- All male flare fittings are internally threaded to accept installation of valve core



Part #	Mfg #	Fitting 1	Fitting 2	Branch Fitting	Body	Price
103852	83-CD9601-2PK	1/4" SAE Flare (F)	1/4" SAE Flare (M)	1/4" SAE Flare (M)	Copper	

Valves

Pro-Set® Ball Valve

- Add existing hose to eliminate refrigerant loss to comply with EPA regulations
- 1/4-Turn operation, color-coded handles



Part #	Mfg #	Description	Price
119736	87-BV3-3PK	1/4" Female, 1/4" Male, SAE, 3/Pk	

Microseal™ Anti-Blowback Valve

- Automated sealing eliminates refrigerant loss and blowback
- Non-restrictive porting for maximum refrigerant flow
- SAE Male x SAE Female



Part #	Mfg #	Description	Price
098447	87-AB3-3PK	1/4" Female, 1/4" Male, SAE, 3/Pk	

Tools

Refrigeration Tools

Valve Core



Part #	Mfg #	Description	Price
140745	83-CD4460-6PK	Valve Core, 6/Pk	

Refrigerant Wrenches

6-in-1 Metric Torque Wrench

- Ideal for installing mini-split systems
- Includes (6) interchangeable heads: 12, 22, 24, 26, 27 & 29mm jaw sizes



Part #	Mfg #	Description	Price
150265	TLTWSM	Metric 6-in-1 Metric Torque Wrench	

Chemicals

Acid Test Kit

- Use to determine the acid level in mineral and alkybenzene lubricants typically used with HCFC refrigerants such as R-22 and R-401A (not for use with POE oil)
- One test per kit
- Easy to use, no complicated charts, results in seconds
- Simply add oil, shake, and observe color change (turns yellow if acidic)



Part #	Mfg #	Description	Price
031600	85-25140-01	Ref Oil Acid Test Kit	

Tools

Refrigeration Tools

Refrigeration Oil Test Kits

Phase III® Refrigeration Oil Test Kit

- For use on POE's, minerals oils, and alkylbenzene
- Tests acid level in refrigeration oil



Part #	Mfg #	Description	Price
140753	4320-W8	Phase III Oil Test Kit	

Tools

Refrigeration Tools

Charging Hoses

- Strong 6-sided crimp
- Coupler nuts are deeply knurled
- Fittings are 1/4" FFL x 1/4" FFL

1/4" Enviro-Guard™ Hose with Ball Valve

- In-line ball valves control refrigerant flow, open and close in 1/4-turn



Part #	Mfg #	Description	Price
028021	65060	(3) 60" Envir-Guard Hose Set	

Flexible Adapter

- Brass fittings
- Durable 6" long neoprene coated hose



Part #	Mfg #	Description	Price
064120	40083	1/4" Hose Gaskets	

Tools



Refrigeration Tools

Refrigerant Parts

Gasket

Part #	Mfg #	Description	Price
144859	87-HXG	Hose Gasket, 10/Pack, Fits 1/4"SAE, 1/2" Acme or 1/2" 20 UNF	

Hose - Refrigerant

Part #	Mfg #	Description	Price
140755	40360	5' Blue, Red, Yellow Refrigerant Hose Set	
140756	41601	5' Blue Refrigerant Hose	
140757	41602	5' Yellow Refrigerant Hose	
126840	41603	5' Red Refrigerant Hose	
096037	45360	5' Blue, Red, & Yellow Refrigerant Hose Set with Anti-Blowback Fittings	
148224	87-HP5BA	5' Blue Refrigerant Hose with Anti-Blowback Fittings	
148223	87-HP5RA	5' Red Refrigerant Hose with Anti-Blowback Fittings	
148222	87-HP5YA	5' Yellow Refrigerant Hose with Anti-Blowback Fittings	
148221	87-HS3A	3' Refrigerant Hose Set with Anti-Blowback Fittings	

Manifold

Part #	Mfg #	Description	Price
132142	57161	Aluminum 2-Way Manifold Gauge Set with 5' Hoses	
105054	87-MBHP5	Manifold with Hose(R-410A-R22)	

Vacuum Pump Oil

Part #	Mfg #	Description	Price
148101	85-2600	1 qt	
092114	85-2601	1 gal	

Tools, Gauges & Solder

Injector

Part #	Mfg #	Description	Price
097336	87-INJ001	System Injector	

Valve Core Tool

Part #	Mfg #	Description	Price
104588	91490	Protech Universal Valve Core Tool	
140984	91496	Valve Core Remover	
140743	83-CD3813-1PK	Valve Core Container/Wrench	
104515	83-CD3800-1PK	Valve Core Wrench	

Tools

Refrigeration Tools

Manifolds

4-Valve Aluminum Manifold

- Forged aluminum body
- Replaceable ss valve seats
- SAE styel o-ring
- Large sight glass
- 3/8" bore throughout
- Comfort grip
- Glows in the dark
- R22-404A-410A



Part #	Mfg #	Description	Price
167725	1839130	60" Hoses, Low Loss Ball-Valve Adapters	

4-Valve Aluminum Manifold Set

- Forged aluminum body
- Replaceable ss valve seats
- SAE styel o-ring
- Large sight glass
- 3/8" bore throughout
- Comfort grip
- Includes:
 - Valve
 - Dual Readout Thermometer
 - 60" Refrigeration hoses w/ ball valve adapters
- R22-404A-410A



Part #	Mfg #	Description	Price
168342	1839131	60" Hoses, Ball-Valve Adapters	

2-Valve Aluminum Manifold

- Forged aluminum body
- Replaceable ss valve seats
- SAE style o-ring
- Large sight glass
- Comfort grip
- Glows in the dark
- Built-in pressure reminder



Part #	Mfg #	Description	Price
166823	1839134	-30" Hg to 300 - 500 psi	

Flaring Tools

Orbital Flare

- Off-center mounted cone spins on an axis to effectively produce quality flares
- Clutch mechanism stops the flaring when the job is done
- Spring-loaded block grips tube securely
- A tube-stop arrow slides to set correct height and positioning, while ball detents allow for easy flaring cone alignment
- Tube Sizes (O.D.) - 3/16", 1/4", 5/16", 3/8", 1/2", 5/8", 3/4"



Part #	Mfg #	Description	Price
167767	1838952	45° Flare Type	

Swaging Tools

Compact Swage Tool

- The power to swage 1-5/8" tubing and the control to swage 5/16" without splitting the tube
- Compact design
- One-handed operation



Kit Includes: 3/8", 1/2", 5/8", 3/4", 7/8", expander heads, body, deburrer, kit box

Part #	Mfg #	Description	Price
165773	1839015	Tube sizes (O.D.) 3/8", 1/2", 5/8", 3/4", 7/8"	

Electronic Tools

Dual Readout Thermometer

- Manifold-compatible compact thermometer
- Use it on any gauge set, or remove it and use it independently
- Two easy-to-use, K-style tube clamp thermocouples



Part #	Mfg #	Description	Price
167727	1839106	0° C to +50°C	

Refrigeration Tools

Service Tools

Deburrers

- *Steel blades*



Part #	Mfg #	Description	Price
168257	1891258	1/4" to 1-5/8"	

Hoses

Refrigeration Hoses

- *Extra abrasion-resistant layer*
- *Rated for 800 PSI working pressure*
- *60" Length*



Part #	Mfg #	Description	Price
168252	1839153	Set of 3 (Red, Blue, Yellow)	

Tools



Refrigeration Tools

Vacuum Gauges

Gas Test Pressure Gauge Assembly (with Clamshell)

- 2" diameter steel case



Part #	Mfg #	Gas Test Fitting	Conn.	Price
183408	355-05PK2	Air Valve Only	3/4" FIP	

Rulers & Tape Measures

Power Return Tapes

- *Ultraviolet curing extends blade life*
- *Impact-resistant cases*

Magnetic Tip Tape Measure

- *Reinforced end hook*
- *Nylon coated blade*
- *Yellow blade*



Part #	Mfg #	Size	Price
080609	T425M	1" x 25'	



Rulers & Tape Measures

Tape Measures

Part #	Description	Price
035970	1" x 25' Plumb Tape Measure	

Tools

Rulers & Tape Measures

Steel Tapes

Power Return Tape - Double-Sided

- Baked-on epoxy coating to resist scratches, rust, and abrasions
- Thick rubber grip; blue case
- Oversized bold black number on first 11" 16" & 19" Red stud marks



Part #	Mfg #	Length	Width	Price
135034	908-25	25'	1"	

Magnetic Double End-Hook Tape

- Nylon-coated hardened steel blade
- Built-in shock absorber to protect blade tip
- True zero feature for accurate inside and outside measuring
- Durable steel belt clip for convenience
- Multi-riveted end hook with bottom blade protector reinforces the blade tip and provides maximum pull-out strength
- Rare earth magnetic double end hook
- First 11" (279mm) has oversized, bold numbers
- Easy-read fractional scale
- Double-sided rule for measurement while using against wall, ceiling or conduit
- Horizontal and vertical standout for easy one person measurements
- Shock and impact resistant case



Part #	Mfg #	Description	Price
145377	93225	25' With Magnetic Tip	

Folding Wood Rules

Standard Rule

- 6' Long hardwood rules with clear abrasion resistant coating
- Black markings on yellow, with red stud center markings every 16 inches
- Measurements are marked on both sides and both edges, graduated to 1/16th inch
- Engraved graduations on both sides



Part #	Mfg #	Reading	Length	Price
112668	900-6	Inside	6'	

Tools

Rulers & Tape Measures

Rulers

Fiberglass Folding Ruler

- Precision made of flexible heavy-duty fiberglass
- With embedded easy-to-read boldface figures and graduations with red 16" stud marks and positive locking joints
- 6" Inside flat reading



Part #	Mfg #	Model	Width	Length	Price
008692	73370	1619F	5/8"	6'	

Saws & Blades

Hand Hacksaw Frames
HT50 High Tension Frame

- Unique I-beam construction
- Rubberized handle
- 50,000 psi
- Handle stores up to (5) extra blades
- Frame includes (1) 12" 24 TPI blade



Part #	Mfg #	Description	Price
129562	12132-HT50	High Tension Metal Cutting	

Hand Saws

Compact Hacksaw

- Heavy-duty aluminum handle
- Allows for flush cutting applications



Part #	Mfg #	Description	Price
006368	20975-975	Multi-Purpose	

Close Quarter® Saw

- Reaches into tight spaces where standard won't fit



Part #	Mfg #	Description	Price
006366	20908-908	Close Quarter Saw	
022382	20906-906	6"L x 1/4"W, 32 TPI Blade	

Tri-Fold® Saw

- Complete with reciprocating blade
- Locks into three different positions for cutting anything from wood to drywall, to stainless steel at any angle
- Uses any reciprocating blade with 1/2" tang



Part #	Mfg #	Description	Price
113553	20997-TFHS618	(2) Blade, Plaster, Wood, & Metal Cutting (635R/636RP) 636	

PVC/ABS Plastic Pipe Hand Saw

- Wide rigid carbon steel blade with hardened teeth
- Cut any size diameter plastic pipe, wood and nail-embedded wood
- Heavy-duty lightweight aluminum handle



Part #	Mfg #	Description	Price
006260	20985-HSF12	12" Blade & Rubberized Handle	
006261	20980-HSF18	18" Blade & Rubberized Handle	
006258	20982-HSB12	12" Replacement Blade	
006259	20981-HSB18	18" Replacement Blade	

Tools

Saws & Blades

Bi-Metal Hacksaw Blades

- Bi-metal construction allows blades to bend and flex without breaking
- TUFF TOOTH™ design eliminates tooth strippage



Part #	Mfg #	TPI	Length x Width	Pkg Qty	Applications	Price
006302	20116-218HE	18	12" x 1/2"	100	Heavy Metal	
096100	20141-V024HE	24	10" x 1/2"	10	Medium Metal	
006282	20111-024HE	24	10" x 1/2"	100	Medium Metal	
006305	20117-224HE	24	12" x 1/2"	100	Medium Metal	
006283	20112-032HE	32	10" x 1/2"	100	Non-ferrous Metals	
006306	20118-232HE	32	12" x 1/2"	100	Non-ferrous Metals	

Reciprocating Saw Blades

Lenox® Gold™ Reciprocating Blade

- Longest lasting blade ever™
- Reinforced tooth design and precision applied titanium coating dissipate heat
- Titanium coating makes teeth more wear resistant so they stay sharp for quicker cuts
- Bi-metal design stands up to the most demanding applications

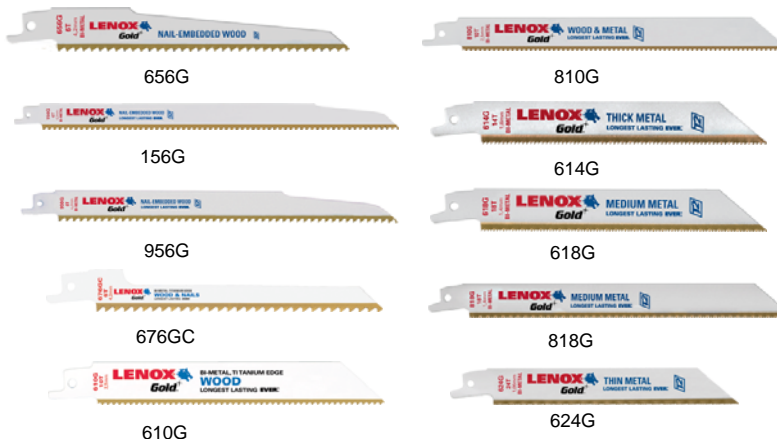

Part #	Mfg #	TPI	L x W x Thick	Pkg Qty	Applications	Price
089084	21060-656G	6	6" x 3/4" x .050"	5	Wood, Drywall & Plaster	
089095	21061-156G	6	12" x 3/4" x .050"	5	Wood, Drywall & Plaster	
089094	21062-956G	6	9" x 3/4" x .050"	5	Wood, Drywall & Plaster	
089085	21063-676GC	6	6" x 7/16" x .050"	5	Scroll Cutting, Wood	
089086	21064-610G	10	6" x 3/4" x .035"	5	Wood & Thick Metal (1/8" - 1/2")	
089090	21065-810G	10	8" x 3/4" x .050"	5	Wood & Thick Metal (1/8" - 1/2")	
089087	21067-614G	14	6" x 3/4" x .035"	5	Thick to Medium Metal (3/32" - 1/2")	
089088	21069-618G	18	6" x 3/4" x .035"	5	Medium Metal (3/32" - 5/16")	
089091	21070-818G	18	8" x 3/4" x .035"	5	Medium Metal (3/32" - 5/16")	
089089	21072-624G	24	6" x 3/4" x .035"	5	Thin Metal (1/8" & Less)	

Tools

Saws & Blades

Demolition Blade

- Engineered to rip through a wide array of materials with ease including structural steel, lumber, pipe and nail embedded wood
- Wider and thicker to stand up to the brutal conditions in demolition applications
- Shatter-resistant, bi-metal design provides the flexibility and durability single-metal blades can't



Part #	Mfg #	TPI	L x W x Thick	Pkg Qty	Applications	Price
020402	20598-966R	6	9" x 7/8" x .062"	2	Demolition, Drywall & Plaster	
089079	20500-106R	6	12" x 7/8" x .062"	2	Demolition, Drywall & Plaster	
020401	20597-960R	10	9" x 7/8" x .062"	2	Demolition	

Lazer™ Reciprocating Saw Blade

- Best for extreme metal cutting
- Reinforced tooth design ensures higher performance in the most demanding jobs
- A wider, thicker body than conventional blades delivers whip-free cuts that stay straight and smooth
- Lasts up to 45% longer than competitors blades
- Shatter-resistant, bi-metal design provides the flexibility and durability single-metal blades can't

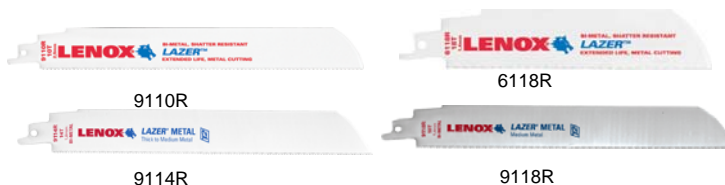

Part #	Mfg #	TPI	L x W x Thick	Pkg Qty	Applications	Price
102718	20176-9110R	10	9" x 1" x .042"	5	Structural Steels & All Metals	
089080	20178-9114R	14	9" x 1" x .042"	5	Structural Steels & All Metals	
077700	20174-6118R	18	6" x 1" x .042"	5	Structural Steels & All Metals	
110795	20180-9118R	18	9" x 1" x .042"	5	Structural Steels & All Metals	

Lenox Lazer Gold™ Reciprocating Saw Blade

- Titanium edge
- Bi-metal technology
- Designed for heavy metal cutting
- Shatter-resistant

Part #	Mfg #	TPI	L x W x Thick	Pkg Qty	Applications	Price
089101	21090-966GR	6	9" x 7/8" x .062"	5	Demolition & Wood	
089106	91091-106GR	6	12" x 7/8" x .062"	5	Demolition, Cast Iron, Wood	
089102	21089-960GR	10	9" x 7/8" x .062"	5	Demolition, Cast Iron, Wood	
089103	21097-9110GR	10	9" x 1" x .042"	5	Heavy Metals	
089107	21100-12110GR	10	12" x 1" x .042"	5	Heavy Metals	
089099	21094-6114G	14	6" x 1" x .042"	5	Medium Metals & Heavy Metals	
089104	21098-9114G	14	9" x 1" x .042"	5	Medium Metals & Heavy Metals	
089100	21095-6118GR	18	6" x 1" x .042"	5	Medium Metals	
089105	21099-9118GR	18	9" x 1" x .042"	5	Medium Metals	

Tools

Saws & Blades

Diamond™ Reciprocating Saw Blade

- Lasts three times longer than convention carbide grit
- Narrow kerf design enables thinner, faster cuts



Part #	Mfg #	Grit	L x W x Thick	Pkg Qty	Applications	Price
102459	10833	Diamond	8" x 3/4" x .040	1	Cast Iron, Tile, Brick & Stone	

Master-Grit® Reciprocating Saw Blade

- Cuts through materials that resist chip-forming
- Uniformly applied, durable carbide grit particles on a flexible blade provide fast cuts without snagging or binding



800RG

Part #	Mfg #	Grit	L x W x Thick	Pkg Qty	Applications	Price
006363	20576-800RG	Medium	8" x 3/4" x .040"	2	Fiberglass, Ceramic Tile, Clays, Brick	

Bi-Metal™ Reciprocating Saw Blade

- Patented TUFF TOOTH™ design provides long blade life
- Optimized for specific applications
- Shatter-resistant, bi-metal design provides the flexibility and durability single-metal blades can't



650R



618R

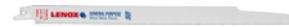

110R



818R



634R



810R



314RC

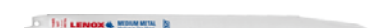

118R



456R



956R



414R



424R



636RP

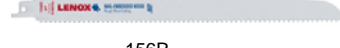

156R



318RC



624R



656R



610R



418R



676RC



614R

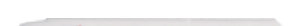

624R

Part #	Mfg #	TPI	L x W x Thick	Pkg Qty	Applications	Price
006353	20575-634R	4	6" x 3/4" x .050"	5	Wood	
089082	20449-456RP	6	4" x 3/4" x .050"	5	Drywall & Plaster	
044001	20497-B636RP	6	6" x 3/4" x .050"	25	Drywall & Plaster	
006356	20572-656R	6	6" x 3/4" x .050"	5	Wood & Nail-Embedded Wood	
025881	20530-B656R	6	6" x 3/4" x .050"	25	Wood & Nail-Embedded Wood	
006358	20556-676RC	6	6" x 7/16" x .050"	25	Wood, Metal, Plastics & Composites	
006364	20580-810R	10	8" x 3/4" x .050"	5	Wood, Metal, Plastics & Composites	
057892	20590-B810R	10	8" x 3/4" x .050"	25	Wood, Thick Metal, Plastics & Composites	
006367	20582-956R	6	9" x 3/4" x .050"	5	Wood & Nail-Embedded Wood	
006295	20585-156R	6	12" x 3/4" x .050"	5	Wood & Nail-Embedded Wood	
025882	20493-B610R	10	6" x 3/4" x .035"	25	Wood, Metal, Plastics & Composites	
006349	20562-610R	10	6" x 3/4" x .035"	5	Wood, Metal, Plastics & Composites	
006350	20564-614R	14	6"x3/4 x.035"	5	Non-ferrous & Medium Metal	
024968	20592-650R	10/14	6" x 3/4" x .050"	1	Demolition	
006286	20583-110R	10/14	12" x 3/4" x .050"	5	Wood & Medium Metal (3/32" - 5/16")	

Saws & Blades

Reciprocating Saw Blades (Continued)

Bi-Metal™ Reciprocating Saw Blade

Part #	Mfg #	TPI	L x W x Thick	Pkg Qty	Applications	Price
006316	20520-314RC	14	3-5/8" x 5/16" x .035"	5	Wood & Medium Metal	
006331	20550-414R	14	4"x3/4"x.035"	5	Non-ferrous & Medium Metal (3/32"-5/16")	
006317	20521-318RC	18	3"x1/4"x.032"	5	Pressure-Treated Wood & Medium Metal	
006332	20552-418R	18	4" x 3/4" x .035"	5	Non-ferrous & Thin Metal (1/8" & Less)	
006351	20566-618R	18	6" x 3/4" x .035"	5	Non-ferrous & Thin Metal (1/8" & Less)	
033466	20529-B618R	18	6" x 3/4" x .035"	25	Non-ferrous & Thin Metal (1/8" & Less)	
028034	20578-818R	18	8" x 3/4" x .035"	5	Non-ferrous & Thin Metal (1/8" & Less)	
089077	21510-118R	18	12" x 3/4" x .035"	5	Non-ferrous & Thin Metal (1/8" & Less)	
006334	20554-424R	24	4" x 3/4" x .035"	5	Thin Metal (1/8" & Less)	
006352	20568-624R	24	6" x 3/4" x .035"	5	Thin Metal (1/8" & Less)	

Band Saw Blades

Wolf-Band® Portable Band Saw Blade

- Long lasting high speed steel teeth
- Shatter-resistant



Part #	Mfg #	TPI	Pk Qty	Price
094920	38428	10/14	1	

Tools

Saws & Blades

Abrasive Saw

- Heavy-duty cast iron base with non-slip rubber feet
- D-Handle grip ergonomic handle
- Die cast aluminum motor housing with externally accessible brushes
- Tool-less fence adjustment
- Arbor lock and arbor wrench included
- Miter cut to 45°



Replacement Saw Blade

Part #	Mfg #	Description	Price
067703	46956	14" Abrasive Disks for Steel, 10/Pk	

Pipe Saws
PVC/ABS Pipe Saw



Part #	Mfg #	Model	Description	Price
108804	50532	1205-2	18" Replacement Blade	

Tools

Saws & Blades

Hand Saws

Compact Hack Saw

- Tool-free blade change
- Adjustable blade length
- Rubber over mold grip



Part #	Mfg #	Description	Price
137579	48-22-0012	Includes (1) 10" Blade	

Rasping Jab Saw

- Rasping holes along the side of the blade to rapidly expand holes or smooth rough edges of sheet rock
- Rubber over mold grip
- 6" Plaster/dry wall blade



Part #	Mfg #	Description	Price
137581	48-22-0304	6" Rasping Jab Saw	

Folding Jab Saw

- Folds for easy storage
- Uses standard Sawzall® blades
- Includes:
 - (1) Folding jab saw
 - (3) Reciprocating blades (metal, wood, multi-purpose)



Part #	Mfg #	Description	Price
137583	48-22-0305	6" Folding Jab Saw	

Sawzall® Blades

- Matrix II high speed steel teeth with 8% cobalt, tough bi-metal design; 1/2" universal tang

SAWZALL® Blades

- NAIL GUARD™ Ordinary teeth deliver either speed or durability. NAIL GUARD™ solves this trade-off with an aggressive 5 TPI pattern for faster cuts and a unique design that protects against tooth fracture
- FANG TIP™ Ordinary tips bounce or skate on the work piece. FANG TIP™ bites into the wood on first contact.
- Matrix II bi-metal teeth for greater durability



(5 Pk)

Part #	Mfg #	Description	Price
164267	48-00-5091	6" 8/12 TPI SAWZALL® Blades (5 Pk)	
164207	48-00-5092	6" 10 TPI SAWZALL® Blades (5 Pk)	

Sawzall® Blades (Continued)

SAWZALL® Blades

(5 Pk)

Part #	Mfg #	Description	Price
164210	48-00-5182	6" 14 TPI SAWZALL® Blades (5 Pk)	
164211	48-00-5184	6" 18 TPI SAWZALL® Blades (5 Pk)	
164212	48-00-5186	6" 24 TPI SAWZALL® Blades (5 Pk)	
164279	48-00-5093	8" 8/12 TPI SAWZALL® Blades (5 Pk)	
164202	48-00-5036	9" 5 TPI SAWZALL® Blades (5 Pk)	
164203	48-00-5016	9" 6 TPI SAWZALL® Blades (5 Pk)	
164273	48-00-5187	9" 14 TPI SAWZALL® Blades (5 Pk)	
164274	48-00-5188	9" 18 TPI SAWZALL® Blades (5 Pk)	
164200	48-00-5037	12" 5 TPI SAWZALL® Blades (5 Pk)	
169673	48-00-5094	12" 8/12 TPI SAWZALL® Blades (5 Pk)	
167949	48-00-5194	12" 10/14 TPI SAWZALL® Blades (5 Pk)	

(25 Pk)

Part #	Mfg #	Description	Price
168482	48-01-2035	6" 5 TPI Sawzall® Blade (25 Pk)	
168483	48-01-2036	9" 5 TPI Sawzall® Blade (25 Pk)	

(50 Pk)

Part #	Mfg #	Description	Price
152610	48-01-6035	6" 5 TPI Sawzall® Blades (50 Pk)	

Tools

Saws & Blades

Thin Kerf SAWZALL® Blades

- Optimized tooth design providing 2X more life than our previous generation SAWZALL® blades
- Tough Neck™ ribs strengthen the blade tang and minimize breakage
- Grid Iron™ honeycomb pattern increases blade rigidity to resist blade buckling



(5 Pk)

Part #	Mfg #	Description	Price
167946	48-00-5181	4" 14 TPI Thin Kerf SAWZALL® Blades	

(25 Pk)

Part #	Mfg #	Description	Price
168363	48-01-2184	6" 18 TPI Thin Kerf SAWZALL® Blades (25 Pk)	
168364	48-01-2188	9" 18 TPI Thin Kerf SAWZALL® Blades (25 Pk)	

(100 Pk)

Part #	Mfg #	Description	Price
167948	48-01-7184	6" 18 TPI Thin Kerf SAWZALL® Blades (Bulk 100 Pk)	

Thin Kerf Ice Hardened™ SAWZALL® Blades

- Optimized tooth design providing 2X more life than our previous generation SAWZALL® blades
- Tough Neck™ ribs strengthen the blade tang and minimize breakage
- Grid Iron™ honeycomb pattern increases blade rigidity to resist blade buckling



(5 Pk)

Part #	Mfg #	Description	Price
169667	48-00-4182	6" 14 TPI Thin Kerf Ice Hardened™ SAWZALL® Blades	
167951	48-00-4189	12" 18 TPI Thin Kerf Ice Hardened™ SAWZALL® Blades (5 Pk)	

(50 Pk)

Part #	Mfg #	Description	Price
152609	48-01-8184	6" 18TPI Thin Kerf Ice Hardened™ SAWZALL® Blades (50Pk)	

The Torch™ SAWZALL® Blades

- Optimized tooth design providing 2X more life than our previous generation
- SAWZALL® blades Tough Neck™ ribs strengthen the blade tang and minimize breakage
- Grid Iron™ honeycomb pattern increases blade rigidity to resist blade buckling



(5 Pk)

Part #	Mfg #	Description	Price
152136	48-00-5712	6" 10 TPI The Torch™ SAWZALL® Blades (5 Pk)	
152137	48-00-5782	6" 14 TPI The Torch™ SAWZALL® Blades (5 Pk)	
152139	48-00-5784	6" 18 TPI The Torch™ SAWZALL® Blades (5 Pk)	
164297	48-00-5786	6" 24 TPI The Torch™ SAWZALL® Blades (5 Pk)	
152129	48-00-5713	9" 10 TPI The Torch™ SAWZALL® Blades (5 Pk)	
152130	48-00-5787	9" 14 TPI The Torch™ SAWZALL® Blades (5 Pk)	
152131	48-00-5788	9" 18 TPI The Torch™ SAWZALL® Blades (5 Pk)	
164298	48-00-5790	9" 24 TPI The Torch™ SAWZALL® Blades (5 Pk)	
152132	48-00-5714	12" 10 TPI The Torch™ SAWZALL® Blades (5 Pk)	
152133	48-00-5794	12" 14 TPI The Torch™ SAWZALL® Blades (5 Pk)	
152134	48-00-5789	12" 18 TPI The Torch™ SAWZALL® Blades (5 Pk)	
169669	48-00-5791	12" 24 TPI The Torch™ SAWZALL® Blades (5 Pk)	

(25 Pk)

Part #	Mfg #	Description	Price
161705	48-01-2713	9" 10 TPI The Torch™ SAWZALL® Blades (25 Pk)	
168987	48-00-8787	9" 14 TPI The Torch™ SAWZALL® Blades (25 Pk)	

Saws & Blades

The Torch™ Ice Hardened™ SAWZALL® Blades

- Optimized tooth design providing 2X more life than our previous generation SAWZALL® blades
- Tough Neck™ ribs strengthen the blade tang and minimize breakage
- Grid Iron™ honeycomb pattern increases blade rigidity to resist blade buckling



(5 Pk)

Part #	Mfg #	Description	Price
169668	48-00-4784	6" 18 TPI The Torch™ Ice Hardened™ SAWZALL® Blades	
229537	48-00-4712	6" 10 TPI The Torch™ Ice	
229539	48-00-4713	9" 10 TPI The Torch™ Ice	
229538	48-00-4782	6" 14 TPI The Torch™ Ice	
229540	48-00-4788	9" 18 TPI The Torch™ Ice	

The Ax™ SAWZALL® Blades

- NAIL GUARD™ Ordinary teeth deliver either speed or durability. Nail Guard™ solves this trade-off with an aggressive 5 TPI pattern for faster cuts and a unique design that protects against tooth fracture
- FANG TIP™ Ordinary tips bounce or skate on the work piece. FANG TIP™ bites into the wood on first contact
- The 1" tall blade body reduces blade twisting for straighter, more accurate cuts
- Matrix II bi-metal teeth for greater durability



(5 Pk)

Part #	Mfg #	Description	Price
152529	48-00-5021	6" 5 TPI The Ax™ SAWZALL® Blades (5 Pk)	
152530	48-00-5026	9" 5 TPI The Ax™ SAWZALL® Blades (5 Pk)	
152531	48-00-5027	12" 5 TPI The Ax™ SAWZALL® Blades (5 Pk)	

(100 Pk)

Part #	Mfg #	Description	Price
167947	48-01-7021	6" 5 TPI The Ax™ SAWZALL® Blade (100 Pk)	

The Wrecker™ SAWZALL® Blades

- A precise manufacturing process creates a sharper cutting edge on each tooth for a faster cutting blade
- A complete, unset raker tooth on the blade tip allows for easier, faster plunging by minimizing walking and bouncing
- A thicker, more rigid blade body resists fracturing and bending for maximum durability
- The 1" tall blade body reduces blade twisting for straighter, more accurate cuts



(5 Pk)

Part #	Mfg #	Description	Price
152135	48-00-5701	6" 8 TPI The Wrecker™ SAWZALL® Blades (5 Pk)	
152128	48-00-5706	9" 8 TPI The Wrecker™ SAWZALL® Blades (5 Pk)	
152127	48-00-5711	12" 8 TPI The Wrecker™ SAWZALL® Blades (5 Pk)	

Fleam Ground SAWZALL® Blades

- Deep gullet design cuts up to 25% faster than standard wood blades
- Fleam ground process creates super sharp teeth for clean cuts
- Matrix II bi-metal teeth for greater durability



(5 Pk)

Part #	Mfg #	Description	Price
169671	48-00-5015	6" 6 TPI Fleam Ground SAWZALL® Blades (5 Pk)	

Carbide Grit SAWZALL® Blade

- Tungsten carbide for long life
- Coarse grit for fast cutting



Part #	Mfg #	Description	Price
169674	48-00-1420	6" Carbide Grit SAWZALL® Blade (3 Pk)	
159451	48-00-1430	9" Carbide Grit SAWZALL® Blade (3 Pk)	

Saws & Blades

Diamond Grit THE TORCH™ SAWZALL® Blade

- Diamond Grit delivers up to 30x longer life than standard carbide grit blades
- The precisely controlled size and placement of the diamond grit allow these blades to cut up to 2x faster than standard carbide grit blades
- The 1" tall blade body reduces blade twisting for straighter, more accurate cuts



Part #	Mfg #	Description	Price
152141	48-00-1440	6" Diamond Grit THE TORCH™ SAWZALL® Blade	
151654	48-00-1450	9" Diamond Grit The TORCH™ SAWZALL® Blade	

Wood Cutting Sawzall® Blade

- For cutting stock 3/8" and above
- Recommended for very fast cutting, nail-embedded wood, general roughing-in



Part #	Mfg #	TPI	Blade Size	Pkg Qty	Price
141058	48-00-8036	6	9" x 3/4"	25/Pk	

Sawzall® Flush Cut Blade

- Floor guard shields teeth from floor contact during bottom plate cut-outs
- Double truss design guides blade for straight window cut-outs
- Nail Guard™ unique design protects against tooth fracture when cutting nails between studs and joists
- Fang Tip™ delivers fast plunge cutting for window cut-outs



Part #	Mfg #	TPI	Blade Size	Pkg Qty	Price
140976	48-00-1600	5	12" x 2-1/8"	1Pk	

Sawzall® Rough-In Blade

- Low blade profile cuts 2-1/8" diameter holes for 1-1/2" PVC pipe
- Can cut holes through double top plates
- NAIL GUARD™ Unique design protects against tooth fracture when cutting through holes in nail embedded wood
- FANG TIP™ fast plunge cutting through bottom plates and subfloors



Part #	Mfg #	TPI	Blade Size	Pkg Qty	Price
140978	48-00-1610	5	7-3/8" x 1/2"	5/Pk	

SUPER SAWZALL® Blade

- Double relief angle reduces tooth stress for long life
- Precision forming process creates sharper teeth for fast cutting
- Matrix II bi-metal teeth for greater durability



Part #	Mfg #	Description	Price
170458	48-00-5161	3-5/8" 10 TPI SUPER SAWZALL® Blade (5 Pk)	

Ductwork SAWZALL® Blade

- Pierce point tip geometry for quick plunging in ductwork with on tool
- Low blade profile for tight radius cuts
- Optimized tooth form designed specifically for cutting ductwork



Part #	Mfg #	Description	Price
169675	48-00-1630	Ductwork SAWZALL® Blade (5 Pk)	

Drywall Access SAWZALL® Blade

- Ideal for servicing plumbing and electrical
- Optimized length to minimize damage to pipe and wire
- Cut all directions
- Fast plunge



Part #	Mfg #	Description	Price
156089	48-00-1640	Drywall Access SAWZALL® Blade	

Pruning Sawzall® Blade



Part #	Mfg #	TPI	Blade Size	Pkg Qty	Price
142581	48-00-1303	5	12" x 3/4"	5/Pk	

High-Carbon Steel Jig Saw Blade

- Heavy duty: Advanced construction for long life in tough professional applications
- Fast cuts; Tooth shape and sharpness permit clean scroll cutting in wood
- Versatile: Fits any jig saw that accepts a T-shank blade

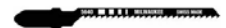

Part #	Mfg #	Description	Price
162387	48-42-5640	3" 12 TPI High-Carbon Steel Jig Saw Blade (5 Pk)	

Saws & Blades

Sawzall® Blade Sets

12-Piece Assortment General Purpose Sawzall® Blade Kit

- Includes:
 - (4) 6" 18 TPI The Torch blades
 - (2) 6" 8 TPI The Wrecker blades
 - (2) 6" 5 TPI The Ax blades
 - (2) 9" 5 TPI The Ax blades
 - (2) 9" 14 TPI The Torch blades
 - (1) Storage container



Part #	Mfg #	Description	Price
143952	49-22-1129	12-Pc General Purpose Blade Kit	

Hackzall™ Blades

M12 Hackzall™ Blade



Part #	Mfg #	TPI	Length	For	Pkg Qty	Price
144141	49-00-5310	10	3-1/2"	Wood	5/Pk	
144142	49-00-5324	24	3-1/2"	Metal	5/Pk	
144143	49-00-5461	6	4"	Plaster	5/Pk	

M12 Hackzall™ Blade 10-Pc Set

- Includes:
 - (2) Wood blades
 - (3) EMT Blades
 - (2) Duct Blades
 - (3) PVC Blades
 - Storage pouch



Part #	Mfg #	Description	Price
143951	49-22-0220	M12™ Hackzall™ 10-Pc Set	

Sawzall® & Hackzall® Accessories

Scraper Blade

- Fits all Sawzall® and Hackzall® reciprocating saws
- Induction hardened blade edge
- Corrosion resistant coating
- Chambered corners prevent digging into work material
- Resharpenable blade



Part #	Mfg #	Description	Price
148390	49-00-5463	1-1/2" Scraper Blade	
148391	49-00-5456	3" Scraper Blade	
159007	49-00-5455	5" Scraper Blade	

Grout Removal Tool

- Fits all SAWZALL® and HACKZALL™ recip saws
- Curved cutting edge for maximum accuracy
- Coarse carbide grit for fast grout removal
- Corrosion resistant coating for longer life



Part #	Mfg #	Description	Price
159006	49-00-5450	Grout Removal Tool	

Shear & Nibbler Accessories

PVC Shear Blade

- Compatible only with the M12™ PVC Shear Tool
- Reinforced cutting edge
- Pierce point design
- Designed to cut PVC, CPVC, PEX, non-metallic conduit and rubber hose
- Blade dimensions: 4" x 2.5" x 0.149"
- High strength stainless steel
- Bowtie connection



Part #	Mfg #	Description	Price
140717	48-44-0400	(1) Shear Replacement Blade	

Saws & Blades

Band Saw Blades

Bi-Metal Band Saw Blade

- 44-7/8" x 1/2" x 0.020"
- Matrix II high speed steel teeth with 8% cobalt
- For the fastest cutting, longest life blade life available

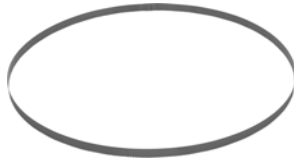

Part #	Mfg #	TPI	Dia or Wall Thickness	Pkg Qty	Price
169677	48-39-0500	10 TPI	Standard Deep Cut		
Portable Band Saw Blade					
138593	48-39-0511	14 TPI	Standard Deep Cut		
Portable Saw Blade					
169676	48-39-0520	18 TPI	Standard Deep Cut		
Portable Band Saw Blade					
160569	48-39-0531	24 TPI	Standard Deep Cut		
Portable Band Saw Blade					

Compact Portable Band Saw Blade

- Matrix II high speed steel teeth
- Alloy backing steel
- Precision formed teeth
- For cutting common materials 3/16" - 5/16" thick and very hard materials 5/16" to 1/2" thick



Part #	Mfg #	TPI	Blade Dimensions	Pkg Qty	Price
163508	48-39-0518	14 TPI	Compact Portable		
Band Saw Blade					
149985	48-39-0519	14	35-3/8" x 1/2"	3	
152649	48-39-0529	18 TPI	Compact Portable		
Band Saw Blade					
163509	48-39-0538	24 TPI	Compact Portable		
Band Saw Blade					
160570	48-39-0539	24 TPI	Compact Portable		
Band Saw Blade					

Circular Saw Blade

Circular Saw Blade 6-1/2" 24 Carbide Teeth (1 per pack)

- 6-1/2 in. diameter, 24 carbide teeth
- 5/8 in. arbor
- Thin kerf for faster cutting
- Framing and ripping blade
- Anti-kickback shoulder
- Precision ground carbide
- Expansion slots for truer cuts under heavy use



Part #	Mfg #	Description	Price
151837	48-40-4108	Circular Saw Blade 6-1/2" 24 Carbide Teeth (1 per pack)	

Circular Saw Blade 6-1/2" 48 Carbide Teeth (1 per pack)

- 6-1/2 in. diameter, 48 carbide teeth
- 5/8 in. arbor
- Anti-kickback design
- Cuts ferrous metals



Part #	Mfg #	Description	Price
151836	48-40-4015	Circular Saw Blade 6-1/2" 48 Carbide Teeth (1 per pack)	

7-1/4" 16 Carbide Teeth Circular Saw Blade

- 7-1/4 in. diameter, 16 carbide teeth
- 5/8 in. arbor with diamond knockout
- Thin kerf for faster cutting
- Framing and ripping blade
- Anti-kickback shoulder
- Precision ground carbide
- Expansion slots for truer cuts under heavy use



Part #	Mfg #	Description	Price
155049	48-40-4116	7-1/4" 16 Carbide Teeth Circular Saw Blade	

Saws & Blades

7-1/4" 40 Carbide Teeth Circular Saw Blade

- 7-1/4 in diameter, 40 carbide teeth
- 5/8 in arbor with diamond knockout
- Thin kerf for faster cutting
- Trim and finish blade
- Anti-Kickback shoulder
- Precision ground carbide
- Expansion slots for truer cuts under heavy use



Part #	Mfg #	Description	Price
154493	48-40-4126	7-1/4" 40 Carbide Teeth Circular Saw Blade	

Tools

Saws & Blades

Hand Saws

Mini Hacksaw—Pistol Grip & Standard

- Separate screw sets the 6" blade tension
- Good for fine work in small areas.
- Six inch steel blade cuts copper and brass tube, bolts, steel, wood and plaster
- Pistol Grip is easier to hold and grasp



301-062

Part #	Mfg #	Type	Blade	Price
031884	301-062	Deluxe Pistol Grip	6"	
183402	301-065	Standard D-Type	6"	

SawHorse™ Multi-Purpose Saw

- High-quality, hardened-steel blade remains sharp through thousands of cuts
- Teeth are on the nose for notching in tight areas and starting cuts in the middle of floor or wall
- Perfect for plastic pipe, wood and many other materials
- 20" model has 10 teeth/inch for faster cutting
- 12" model has 13 teeth/inch for fine cutting.
- Both include plastic teeth protector



300-20

Part #	Mfg #	Blade Size	Price
049442	300-12	20"	
183400	300-20	12"	

Replacement Blades

For: SawHorse™ Multi-Purpose Saws

Part #	Mfg #	For Model:	Price
051535	300-12B	300-12	

For: Mini Hacksaw—Pistol Grip & Standard

- 32 Teeth/Inch
- Pin ends

Part #	Mfg #	Material	Blade	Price
031885	301-061	Carbon Steel	6"	

Tools

Saws & Blades

Saws

PlumBest Plastic Pipe Saw

- Die cast aluminum handle
- Large comfortable grip
- Flame hardened blade
- Quickly cuts PVC, ABS, wood, sheetrock, etc.
- 18" Blade has 10 TPI



Part #	Mfg #	Description	Price
054589	S49-001	18" Blade & Handle	

E-Z Stroke Pipe Saw

- Tri-edge teeth are borazon wheel ground
- For smooth, fast, accurate cutting
- Pull-stroke cutting action
- Cuts plastic pipe and wood
- Replaceable blade



S49-005



S49-006

Part #	Mfg #	Description	Price
044951	S49-005	8" E-Z Stroke Pipe Saw	
045193	S49-006	8" Replacement Blade	
044963	S49-008	12" E-Z Stroke Pipe Saw	
045192	S49-007	12" Replacement Blade	

Drywall Saw

- High quality carbon steel blade
- Great for sheetrock, wallboard, gypsum, plywood, wood and plastic pipe
- 6" to 8 TPI Aggressive tooth design ensures super sharp, fast and easy cut
- Comfortable grip with thumb stop for greater leverage
- Handy wrist strap



Part #	Mfg #	Description	Price
055539	S49-012	Drywall Saw	

Close Quarters Hacksaw

- Nickel-plated steel frame
- Cuts wood, plastic, brass, aluminum and steel



S50-060



S50-062

Part #	Mfg #	Description	Price
005881	S50-060	6" Hacksaw	
111480	S50-062	6" Adjustable Hacksaw	
005882	S50-061	Blades 32 Per Inch	

Saws (Continued)

Close Quarters Hacksaw

Part #	Mfg #	Description	Price
111479	S50-063	Mini Hacksaw Blades (Wholes for S50-062)	

Saws & Blades

Jab Saw

- Cuts drywall, wallboard, plywood, and plastic
- Triple ground teeth for a fast cut
- Blade cuts in both directions (push and pull)
- Hardened, carbon steel blade for durability
- Hardened, beveled blade point for scoring and plunge cuts
- Comfort cushion grip with thumb groove
- Handle structure designed for strength and durability
- Flat end grip for palming or punching through drywall



Part #	Mfg #	Blade Length	Overall Length	Price
106821	725	6"	12"	



Saws & Blades

Hole Saws Replacement Blade

Part #	Mfg #	Diameter	Price
072037	RBW68	4-1/4"	

Saws & Blades

Saws

PVC Cable Saw

- *Cuts plumbing or electrical PVC faster than hacksaw*
- *Ideal for tight spots and in-ground repairs*

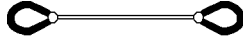

Part #	Mfg #	Description	Price
002737	70390	26" Cable Saw - Std	

Screwdrivers & Bits

All-In-One Screwdrivers



23931



23932

Part #	Mfg #	Description	Price
096916	23931	6-In-1	
094730	23932	9-In-1	

Tools

Screwdrivers & Bits

Screwdrivers

Regular Grip Screwdriver - Electrical Style



Part #	Mfg #	Blade Dia	Blade Length	Price
006380	C22M	1/8"	2"	

Nut Drivers

CONNEXT™ Pre-Assembled Magnetic Hex Driver - Long Lengths



- CONNEXT™ Quick change handles
- Magnetic hex chuck driver shaft components
- Use with Zip-In® and "A" hex head screws

Part #	Mfg #	Hex Dia	Shaft Length	Grips	Price
006416	HHD1	1/4"	6-7/8"	Red	
006417	HHD2	5/16"	6-7/8"	Yellow	

CONNEXT™ Pre-Assembled Magnetic Hex Driver - Standard Lengths



- CONNEXT™ Quick change handles
- Magnetic hex chuck driver shaft components
- Use with Zip-In® and "A" hex head screws

Part #	Mfg #	Hex Dia	Shaft Length	Grips	Price
132792	HHD1S	1/4"	3"	Red	

CONNEXT™ Pre-Assembled Magnetic Hex Driver - Stubby



- CONNEXT™ Quick change handle
- Magnetic hex chuck driver shaft components
- Use with Zip-In® and "A" hex head screws

Part #	Mfg #	Hex Dia	Shaft Length	Grips	Price
132795	HHD2T	5/16"	2-1/4"	Yellow	

Power Bits

Phillips Power Bit

- 1/4" Shank diameter



Part #	Mfg #	Point Size	O/A Length	Price
006444	MBLP3	2	1-15/16"	

Magnetic Hex Driver Bit



- 1/4" Shank diameter

Part #	Mfg #	Hex Opening	Nose Diameter	Price
006447	MSH1/4	1/4"	7/16"	
006449	MSH5/16	5/16"	1/2"	
006448	MSH3/8	3/8"	9/16"	

Long Style Hex Driver Bit



- 1/4" Shank diameter

Part #	Mfg #	Hex Opening	Nose Dia	Qty	Price
006446	MSHL1/4	1/4"	7/16"	1	
025655	MSHL5/16	5/16"	1/2"	1	

Extra Long Style Hex Driver Bit



- 1/4" Shank diameter

Part #	Mfg #	Hex Opening	O/A Length	Price
025042	MSHML1/4	1/4"	4"	
023240	MSHXL1/4	1/4"	6"	
096867	MSHXL5/16	5/16"	6"	

Power Bit Extension

- Ball bearing on holder provides a positive lock on 1/4" hex
- Tempered steel
- Black finish
- 9/16" Nose diameter



Part #	Mfg #	Hex Opening	O/A Length	Price
006378	BHE6	1/4"	6"	
006377	BHE10	1/4"	10"	

Power Driver Hex Adapters

Quick Change Hex Adapter



Part #	Mfg #	Hex Dia	Shank Dia	O/A Length	Price
006407	HAD1	1/4"	3/4"	1-3/4"	

Screwdrivers & Bits

Screwdrivers

#1 Philips - 3" Screwdriver

- Wrench ready HEX shanks deliver additional leverage
- Forged tool shanks deliver more durability and longer life
- Wire bending hole- bend up to 12 gauge wire
- Wire stripper (Patent Pending)- strip up to 12 gauge wire
- Visible ID markings allows for quick tool identification on job site

Part #	Mfg #	Description	Price
169658	48-22-2011	#1 Philips - 3" Screwdriver	

#2 Philips- 4" Screwdriver

- Wrench ready HEX shanks deliver additional leverage
- Forged tool shanks deliver more durability and longer life
- Wire bending hole - bend up to 12 gauge wire
- Wire stripper (Patent Pending) - strip up to 12 gauge wire
- Visible ID markings allow for quick tool identification on job site

Part #	Mfg #	Description	Price
169659	48-22-2012	#2 Philips - 4" Screwdriver	

#3 Philips - 6" Screwdriver

- Wrench ready HEX shanks deliver additional leverage
- Forged tool shanks deliver more durability and longer life
- Wire bending hole - bend up to 12 gauge wire
- Wire stripper (Patent Pending) - strip up to 12 gauge wire
- Visible ID markings allows for quick tool identification on job site

Part #	Mfg #	Description	Price
169660	48-22-2013	#3 Philips - 6" Screwdriver	

5/16" Slotted- 6" Demolition Screwdriver

- Wrench ready HEX shanks deliver additional leverage
- High impact steel cap
- Forged tool shanks deliver more durability and longer life
- Visible ID markings allows for quick tool identification on jobsite

Part #	Mfg #	Description	Price
162649	48-22-2022	5/16" Slotted- 6" Demolition Screwdriver	

3/8" Slotted - 8" Demolition Screwdriver

- Wrench ready HEX shanks deliver additional leverage
- High impact steel cap
- Forged tool shanks deliver more durability and longer life
- Visible ID markings allows for quick tool identification on jobsite

Part #	Mfg #	Description	Price
162625	48-22-2023	3/8" Slotted- 8" Demolition Screwdriver	

Multi-Tip 11-in-1 Screwdriver

- Features ECX™ bits and hardened tips
 - Includes:
 - (9) Bits and nut drivers
 - Integrated gut hook
 - Integrated wire stripper
 - Wire bending hole - bends up to 12 gauge wire
-

Part #	Mfg #	Description	Price
137586	48-22-2113	Screwdriver/Nut Driver	

11 IN 1 Screwdriver w/Square Drive

- Wire stripper (patent pending) strip up to 12ga wire
 - Wire bending hole- bend up to 12ga wire
 - 7 bit types
-

Part #	Mfg #	Description	Price
162648	48-22-2114	11 IN 1 Screwdriver w/ Square Drive	

Tools

Screwdrivers & Bits

10IN1 SAE HEX Key Driver

- Milwaukee® SAE Hex key driver offers improved functionality vs. traditional folding keys
- 3-1/2" Power groove bits for power tool compatibility
- Revolver style bit storage and selection
- Up to 10ga wire stripper and loop maker for additional job site functionality
- Chrome plated bits
- Magnetic bit retention delivers consistent driving performance
- Wrench ready HEX shanks deliver additional leverage
- Includes:
 - (1) 10IN1 Handle
 - (1) 3 1/2" HEX x 1/4"
 - (1) 3 1/2" HEX x 1/8"
 - (1) 3 1/2" HEX x 3/16"
 - (1) 3 1/2" HEX x 5/32"
 - (1) 3 1/2" HEX x 7/32"
 - (1) 3 1/2" HEX x 7/64"
 - (1) 3 1/2" HEX x 9/64"



Part #	Mfg #	Description	Price
163154	48-22-2104	10IN1 SAE HEX Key Driver	

10IN1 TORX® Key Driver

- Milwaukee® TORX® Key Driver offers improved functionality vs. traditional folding keys
- 3-1/2" Power groove bits for power tool compatibility
- Revolver style bit storage and selection
- Up to 10ga wire stripper and loop maker for additional job site functionality
- Chrome plated bits
- Magnetic bit retention delivers consistent driving performance
- Wrench ready HEX shanks deliver additional leverage
- Includes:
 - (1) 10IN1 Handle
 - (1) 3 1/2" TORX® T8
 - (1) 3 1/2" TORX® T10
 - (1) 3 1/2" TORX® T15
 - (1) 3 1/2" TORX® T20
 - (1) 3 1/2" TORX® T25
 - (1) 3 1/2" TORX® T27
 - (1) 3 1/2" TORX® T30



Part #	Mfg #	Description	Price
162804	48-22-2103	10IN1 TORX® Key Driver	

10IN1 Metric HEX Key Driver

- Milwaukee® Metric HEX key driver offers improved functionality vs. traditional folding keys
- 3-1/2" Power groove bits for power tool compatibility
- Revolver style bit storage and selection
- Up to 10ga wire stripper and loop maker for additional job site functionality
- Chrome plated bits
- Magnetic bit retention delivers consistent driving performance
- Wrench ready HEX shanks deliver additional leverage
- Includes:
 - (1) 10IN1 Handle
 - (1) 3 1/2" HEX x 1.5mm
 - (1) 3 1/2" HEX x 2mm
 - (1) 3 1/2" HEX x 2.5mm
 - (1) 3 1/2" HEX x 3mm
 - (1) 3 1/2" HEX x 4mm
 - (1) 3 1/2" HEX x 5mm
 - (1) 3 1/2" HEX x 6mm



Part #	Mfg #	Description	Price
163155	48-22-2106	10IN1 Metric HEX Key Driver	

10IN1 Square Drive Multi Bit Driver

- 3-1/2" Power groove bits for power tool compatibility
- Revolver style bit storage and selection
- Up to 10ga wire stripper and loop maker for additional job site functionality
- Chrome plated bits
- Magnetic bit retention delivers consistent driving performance
- Wrench ready™ HEX shanks deliver additional leverage
- Includes:
 - (1) 10IN1 Handle
 - (1) 3-1/2" Phillips #1
 - (1) 3-1/2" Phillips #2
 - (1) 3-1/2" Slotted 1/4"
 - (1) 3-1/2" Slotted 3/16"
 - (1) 3-1/2" Square drive #1
 - (1) 3-1/2" Square drive #2
 - (1) 3-1/2" Square drive #3



Part #	Mfg #	Description	Price
170691	48-22-2102	10IN1 Square Drive Multi Bit Driver	

Screwdrivers & Bits

10IN1 ECX™ Multi Bit Driver

- 3-1/2" Power groove bits for power tool compatibility
- Revolver style bit storage and selection
- Up to 10ga wire stripper and loop maker for additional jobsite functionality
- Chrome plated bits
- Magnetic bit retention delivers consistent driving performance
- Wrench ready™ HEX shanks deliver additional leverage
- Includes:
 - (1) 10IN1 Handle
 - (1) 3-1/2" ECX™ #1
 - (1) 3-1/2" ECX™ #2
 - (1) 3-1/2" Phillips #1
 - (1) 3-1/2" Phillips #2
 - (1) 3-1/2" Slotted 1/4"
 - (1) 3-1/2" Slotted 3/16"
 - (1) 3-1/2" Square Drive #2



Part #	Mfg #	Description	Price
161629	48-22-2101	10IN1 ECX Multi Bit Driver	

Compact 8IN1 Ratchet Multi Bit Driver

- All metal ratchet: durable high torque ratchet for 2x driving speed and maximum control
- Power groove bits for power tool compatibility and job site versatility
- Precision machined bit tips: durable driving tips for sector figment
- Wrench ready: hex shanks for additional leverage
- Chrome plated bits
- Includes:
 - (1) Compact 8IN1 Ratchet handle
 - (1) 1-1/2" Phillips #1 power groove bit
 - (1) 1-1/2" Phillips #2 power groove bit
 - (1) 1-1/2" Slotted 1/16" power groove bit
 - (1) 1-1/2" Slotted 3/32" power groove bit
 - (1) 1-1/2" Square recess #1 power groove bit
 - (1) 1-1/2" Square recess #2 power groove bit
 - (1) 1-1/2" TORX® 15 power groove bit



Part #	Mfg #	Description	Price
171804	48-22-2320	Compact 8IN1 Ratchet Multi Bit Driver	

10 IN 1 Square Drive Ratcheting Multi Bit Driver

- All metal high torque ratchet delivers more durability and 2X driving speed
- 3 1/2" Power groove bits for power tool compatibility
- Revolver style bit storage and selection
- Up to 10ga wire stripper and loop maker
- Chrome plated bits
- Magnetic bit retention delivers consistent driving performance
- Includes:
 - (1) 10in1 Ratchet handle
 - (1) 3 1/2" Phillips #1
 - (1) 3 1/2" Phillips #2
 - (1) 3 1/2" Slotted 1/4"
 - (1) 3 1/2" Slotted 3/16"
 - (1) 3 1/2" Square drive #1
 - (1) 3 1/2" Square drive #2
 - (1) 3 1/2" Square drive #3



Part #	Mfg #	Description	Price
169218	48-22-2302	10 IN 1 Square Drive Ratcheting Multi Bit Driver	

10IN1 ECX™ Ratcheting Multi Bit Driver

- All metal high torque ratchet delivers more durability and 2X driving speed
- 3 1/2" Power groove bits for power tool compatibility
- Revolver style bit storage and selection
- Up to 10ga wire stripper and loop maker
- Chrome plated bits
- Magnetic bit retention delivers consistent driving performance
- Includes:
 - (1) 10IN1 Ratchet handle
 - (1) 3 1/2" ECX™ #1
 - (1) 3 1/2" ECX™ #2
 - (1) 3 1/2" Phillips #1
 - (1) 3 1/2" Phillips #2
 - (1) 3 1/2" Slotted 1/4"
 - (1) 3 1/2" Slotted 3/16"
 - (1) 3 1/2" Square Drive #2



Part #	Mfg #	Description	Price
162815	48-22-2301	10IN1 ECX™ Ratcheting Multi Bit Driver	

Screwdrivers & Bits

8-Piece Screwdriver Set

- Includes:
 - 4" #1 & #2 ECX™
 - 3" & 4" #1 & #2 Phillips
 - 4" & 6" 1/4" & 5/16" Slotted
 - 3" & 6" 3/16" Cabinet



Part #	Mfg #	Description	Price
137587	48-22-2008	Steel Cap	

4 PC Precision Screwdriver Set

- All metal cores: up to 4x stronger
- Precision machined driving tips
- Longer shanks for improved visibility and extended reach
- 360-degree rotating back caps
- Color coded markings for easy identification
- Chrome plated shanks increase tool life by reducing corrosion
- Includes:
 - (1) Phillip #1 -4" Precision screwdriver
 - (1) Slotted 1/16" - 2 1/2" Precision screwdriver
 - (1) Slotted 3/32" - 2 1/2" Precision screwdriver
 - (1) Slotted 1/8" 3 1/2" Slotted precision screwdriver



Part #	Mfg #	Description	Price
171805	48-22-2604	4 PC Precision Screwdriver Set	

Shockwave® Impact Duty™ Bits

- Steel heat treated to control hardness
- Forged tip for maximum grip
- Geometric design provides the shock absorption zone

Shockwave® Reduced Diameter Dry wall Phillips Insert Bit



Part #	Mfg #	Dia	Lgth	Pkg Qty	Phillips	Price
141257	48-32-4444	1/4"	1"	2	#2	

Shockwave® Impact Duty™ Phillips Insert Bit



48-32-4411

Part #	Mfg #	Dia	Lgth	Pkg Qty	Phillips	Price
141251	48-32-4411	1/4"	1"	2	#1	
141255	48-32-4601	1/4"	1"	5	#2	
141256	48-32-4413	1/4"	1"	2	#3	

Shockwave® Impact Duty™ Phillips Power Bit



Part #	Mfg #	Dia	Lgth	Pkg Qty	Phillips	Price
141259	48-32-4602	1/4"	2"	5	#2	

SHOCKWAVE™ 2" Impact Phillips #1 Power Bit

- OPTIMIZED SHOCKZONE™ absorbs peak torque and prevents breaking
- PRECISE FIT CUSTOM MACHINED TIP™ prevents stripping and reduces wobble
- CUSTOM ALLOY76™ STEEL maximizes resistance to wear and shock



Part #	Mfg #	Description	Price
164161	48-32-4461	SHOCKWAVE™ 2" Impact Phillips #1 Power Bit	

SHOCKWAVE™ 3-1/2" Impact Phillips Power Bit

- OPTIMIZED SHOCKZONE™ Absorbs peak torque and prevents breaking
- PRECISE FIT CUSTOM MACHINED TIP™ prevents stripping and reduces wobble
- CUSTOM ALLOY76™ STEEL maximizes resistance to wear and shock



Part #	Mfg #	Description	Price
164164	48-32-4563	SHOCKWAVE™ 3-1/2" Impact Phillips #3 Power bit	

SHOCKWAVE™ 3-1/2" Impact Phillips #2 Power Bits (5PK)

- OPTIMIZED SHOCKZONE™ absorbs peak torque and prevents breaking
- PRECISE FIT CUSTOM MACHINED TIP™ prevents stripping and reduces wobble
- CUSTOM ALLOY76™ STEEL maximizes resistance to wear and shock



Part #	Mfg #	Description	Price
164174	48-32-4564	SHOCKWAVE™ 3-1/2" Impact Phillips #2 Power Bits (5PK)	

Screwdrivers & Bits

SHOCKWAVE™ Impact Phillips #2 Insert Bits (Contractor Pack)



Part #	Mfg #	Description	Price
164171	48-32-4604	Impact Phillips #2 Insert Bits - Contractor Pack (25QTY)	

Shockwave® Impact Duty™ Square Recess Insert Bit



48-32-4421



48-32-4471

Part #	Mfg #	Dia	Lgth	Pkg Qty	Phillips	Price
141262	48-32-4421	1/4"	1"	2	#1	
141266	48-32-4471	1/4"	2"	1	#1	
141263	48-32-4422	1/4"	1"	2	#2	
141265	48-32-4605	1/4"	1"	5	#2	
141268	48-32-4606	1/4"	2"	5	#2	
141264	48-32-4423	1/4"	1"	2	#3	
141269	48-32-4473	1/4"	2"	1	#3	
141270	48-32-4572	1/4"	3-1/2"	1	#2	

SHOCKWAVE™ 3-1/2" Impact Square Recss Power Bit

- OPTIMIZED SHOCKZONE™ absorbs peak torque and prevents breaking
- PRECISE FIT CUSTOM MACHINED TIP™ prevents stripping and reduces wobble
- CUSTOM ALLOY76™ STEEL maximizes resistance to wear and shock



Part #	Mfg #	Description	Price
164165	48-32-4573	SHOCKWAVE™ 3-1/2" Impact Square Recss #3 Power Bit	

Shockwave® Torx® Power Bit



Part #	Mfg #	Dia	Lgth	Pkg Qty	Torx	Price
164162	48-32-4482	1/4"	2"	T10		

Shockwave® Impact Duty™ Bits (Continued)

Shockwave® Torx® Power Bit

Part #	Mfg #	Dia	Lgth	Pkg Qty	Torx	Price
141271	48-32-4483	1/4"	2"	1	T15	
164163	48-32-4486	1/4"	2"	T27		
141274	48-32-4487	1/4"	2"	1	T30	

Shockwave® Bit Sets

22-Piece Shockwave® Puck Bit Dispenser

- Includes:
 - Magnetic bit holder
 - Phillips: (1) #1, (3) #2, (2) #
 - Square recess: (1) #1, (3) #2, (1) #3
 - Torx: (1) T10, (1) T15, (1) T20, (1) T25, (1) T27, (1) T30
 - Slotted: (1) 1/8", (1) 3/16", (1) 1/4", (1) 9/32"



Part #	Mfg #	Description	Price
143668	48-32-4011	22-Piece Shockwave® Puck Bit Dispenser	

Right Angle Drive Unit

- For use with Milwaukee 1/2" d-handle drills
- Provides 2 additional drilling speeds
- Includes coupling No. 42-90-0175 for 0234-6 and 0244-1
- For 50% more torque or 50% more speed



Part #	Mfg #	Description	Price
162598	48-06-2871	Right Angle Drive Unit	

11-Piece Shockwave® Impact Duty™ 30° Knuckle™ Pivoting Bit Holder Bit Set

- Locks at 0° or 30° angle
- Designed for use with Shockwave® Impact Duty™ 1/4" hex accessories
- Maximum torque: 2,000 in-lbs
- Includes:
 - Phillips bits: 1" P Shockwave® 30° Knuckle™ pivoting bit holder 1, P2 & P3
 - Square bits: 1" SQ1 & SQ2
 - Slotted bits: 1" SL1/8", SL 3/16", SL1/4", SL9/32"
 - Torx® bits: 1" T25



Part #	Mfg #	Description	Price
146101	48-32-2301	11-Pc Shockwave Bit Set & Knuckle Bit Holder	

Tools

Screwdrivers & Bits

Shockwave® Impact Duty™ Nut Driver

Shockwave® Impact Duty™ Magnetic Nut Driver

- Steel heat treated to control hardness
- Color-coded rings for size identification
- Chamfered edge



Part #	Mfg #	Size	Pkg Qty	Price
141231	49-66-4502	1/4" x 1-7/8"	1	
140360	49-66-4503	5/16" x 1-7/8"	1	
164177	49-66-4537	1/2" x 2-9/16"	1	
141245	49-66-4525	3/8" x 1-7/8"	3	
141246	49-66-4526	7/16" x 1-7/8"	3	

SHOCKWAVE™ 1/4" Hex Adapter SQ 3/8"

- Proprietary steel and heat treat process for maximum strength and durability
- Heavy duty construction for fastening capabilities in all impacts



Part #	Mfg #	Description	Price
153737	48-03-4405	SHOCKWAVE™ 1/4" Hex Adapter SQ 3/8"	

SHOCKWAVE™ Square Socket Adapter

- Proprietary steel and heat treat process for maximum strength and durability
- Heavy duty construction for fastening capabilities in all impacts



Part #	Mfg #	Description	Price
164155	48-32-5030	SHOCKWAVE™ 1/4" Hex to 1/4" Square Socket Adapter	
154029	48-32-5031	SHOCKWAVE™ 1/4" Hex to 3/8" Square Socket	
164157	48-32-5032	SHOCKWAVE™ 1/4" Hex to 1/2" Square Socket Adapter	

SHOCKWAVE™ 1/2" Square to 1/4" Hex Adapter

- Proprietary steel and heat treat process for maximum strength and durability
- Heavy duty construction for fastening capabilities in all impacts



Part #	Mfg #	Description	Price
164154	48-03-4410	SHOCKWAVE™ 1/2" Square to 1/4" Hex Adapter	

Bit Sets

38-Piece Universal Quik-Lok™ Drill & Drive Set

- Universal Quik-Lok™ locks-in double ended, insert, and power groove drill bits
- Made of premium grade S2 tool steel
- Titanium hex shank bits
- Magnetic nut drivers



Part #	Mfg #	Description	Price
138409	48-32-1500	38-Pc Quick-Lok™ Drill & Drive Set	

4-Piece Replacement Bit Set

- Universal fit
- Includes:
 - ECX Bit #1 & #2
 - Phillips #1 & #2
 - Slotted 3/16" & 1/4"
 - Square #1 & #2



Part #	Mfg #	Description	Price
142609	48-22-2110	4-Pc Replacement Bit Set	

Screwdrivers & Bits

Nut Drivers

Hollow Shaft Nut Driver

- Universal driver head fits 4X more fasteners
- Removes rusted and stripped bolts
- 3" Hollow shaft depth
- Wrench ready HEX shanks deliver additional leverage
- Chrome plated - marine grade rust protection
- Forged steel shanks provide longer life and more durability
- Deep well sockets
- Multiple ID markings allow for quick tool identification on job site



Part #	Mfg #	Description	Price
163305	48-22-2421	1/4" HollowCore Driver	
163306	48-22-2422	5/16" HollowCore Driver	

HollowCore™ Magnetic Nut Driver

- HollowCore™ unlimited depth
- Magnetic drivers
- Universal driver head fits 4X more fasteners
- Removes rusted and stripped bolts
- Color coded ID markings allow for quick tool identification on job site
- Wrench ready HEX shanks deliver additional leverage
- Chrome plated- marine grade rust protection
- Forged steel shanks provide longer life and more durability
- Deep well sockets



Part #	Mfg #	Description	Price
162644	48-22-2521	1/4" HollowCore™ Magnetic Nut Driver	
162645	48-22-2522	5/16" HollowCore™ Magnetic Nut Driver	
162646	48-22-2524	3/8" HollowCore™ Magnetic Nut Driver	
162817	48-22-2525	7/16" HollowCore™ Magnetic Driver	
162818	48-22-2526	1/2" HollowCore™ Magnetic Driver	
162819	48-22-2527	9/16" HollowCore™ Magnetic Driver	
162816	48-22-2523	11/32" HollowCore™ Magnetic Driver	

2PC SAE Hollow Shaft Nut Driver Set

- Universal driver head fits 4X more fasteners
- Removes rusted and stripped bolts
- 3" Hollow shaft depth
- Wrench ready HEX shanks deliver additional leverage
- Chrome Plated- marine grade rust protection
- Multiple ID markings allow for quick tool identification on job site



Part #	Mfg #	Description	Price
163307	48-22-2402	2PC HollowCore Driver	

2 PC SAE HollowCore™ Magnetic Nut Driver Set

- HollowCore™ Unlimited depth- Ideal for long bolts or threaded rod application
- Magnetic drivers- Secure fitment in fastening applications
- Universal driver head fits 4X more fasteners
- Removes rusted and stripped bolts
- Color coded ID markings allow for quick tool identification on jobsite
- Wrench ready HEX shanks deliver additional leverage
- Chrome plated- Marine grade rust protection
- Forged steel shanks provide longer life and more durability
- Deep well sockets- drive multiple fasteners



Part #	Mfg #	Description	Price
162394	48-22-2502	2PC SAE HollowCore™ Magnetic Nut Driver Set	



Screwdrivers & Bits

7 PC Magnetic HollowCore™ SAE Nut Driver Set

- *HollowCore™ unlimited depth- ideal for long bolts or threaded rod applications*
- *Magnetic drivers- Secure fitment in fastening applications*
- *Universal driver head fits 4X more fasteners*
- *Removes rusted and stripped bolts*
- *Color coded ID markings allow for quick tool identification on jobsite*
- *Wrench ready HEX shanks deliver additional leverage*
- *Chrome plated- marine grade rust protection*
- *Forged steel shanks provide longer life and more durability*
- *Deep well sockets- Drive multiple fasteners*
- *Includes 9/16" driver*



Part #	Mfg #	Description	Price
161964	48-22-2507	7 PC Magnetic HollowCore™ SAE Nut Driver Set	

Tools



Screwdrivers & Bits

Screwdrivers

4-In-One Pocket Mini Screwdriver

- Includes:
 - 3/32" & 1/16" Slotted bit
 - #0 & #000 Phillips bit



Part #	Mfg #	Color	Price
136199	24008	Black/Yellow	

6-In-One Screwdriver

- Includes:
 - 1/4" & 3/16" Slotted bit
 - #1 & #2 Phillips bit
 - 1/4" & 5/16" Hex nut driver



Part #	Mfg #	Color	Price
028106	24006	Red	

Screwdrivers & Bits

Cushion Grip Screwdrivers

Stubby Heavy-Duty Square Shank Screwdriver - Keystone Tip



Part #	Mfg #	Shank Tip	Shank Length	Overall Length	Price
111152	600-1	1/4"	1-1/2"	3-7/16"	

Heavy-Duty Square Shank Screwdriver - Keystone Tip



Part #	Mfg #	Shank Tip	Shank Length	Overall Length	Price
107644	600-4	1/4"	4"	8-11/32"	

Round Shank Screwdriver - Cabinet Tip



Part #	Mfg #	Shank Tip	Shank Length	Overall Length	Price
107645	601-6	3/16"	6"	9-3/4"	
115682	601-10	3/16"	10"	13-3/4"	

Heavy-Duty Round Shank Screwdriver - Keystone Tip



Part #	Mfg #	Shank Tip	Shank Length	Overall Length	Price
107646	602-6	5/16"	6"	10-15/16"	

Miniature Cushion Grip Screwdriver - Phillips Tip



Part #	Mfg #	Tip Size	Shank Length	Overall Length	Price
120232	604-3	#0	3"	5-3/4"	

Miniature Cushion Grip Screwdriver - Cabinet Tip



Part #	Mfg #	Tip Size	Shank Length	Overall Length	Price
121303	607-3	3/32"	3"	5-3/4"	
121432	608-4	1/8"	4"	6-3/4"	

Stubby Round Shank Screwdriver - Profilated® Phillips Tip



Part #	Mfg #	Point Size	Shank Length	Overall Length	Price
111153	603-1	#2	1-1/2"	3-7/16"	

Round Shank Screwdriver - Profilated® Phillips Tip

- B - Wire bending



Part #	Mfg #	Point Size	Shank Length	Overall Length	Price
106813	603-4	#2	4"	8-5/16"	
114527	603-6	#3	6"	11"	
115681	603-10	#2	10"	14-5/16"	

Cushion Grip Screwdriver Sets

4-Piece Mini Cushion Grip Screwdriver Set

- Includes:
 - 604-3 Phillips tip #0
 - 606-2 Keystone tip 1/16"
 - 607-3 Cabinet tip 3/32"
 - 608-3 Cabinet tip 1/8"



Part #	Mfg #	Description	Price
106815	85484	4-Piece Mini Driver Set	

Tools

Screwdrivers & Bits

8-Piece Cushion Grip Screwdriver Set

- Includes (1) cabinet-tip, (3) keystone-tip, (4) Phillips-tip screwdrivers in styles:
 - 600-1
 - 601-3
 - 600-4
 - 602-6
 - 603-1
 - 603-3
 - 603-4
 - 603-6



Part #	Mfg #	Description	Price
113764	85078	8-Piece Set	

Screw-Holding Screwdrivers

Slotted Screw-Holding Screwdriver



Part #	Mfg #	Shank Tip	Shank Length	Overall Length	Price
106814	K36	1/4"	6"	9-3/4"	

Cushion Grip Nut Drivers

Stubby Nut Driver - 1-1/2" Hollow Shank

- Full hollow shank for long bolts or studs
- Meets or exceeds applicable AMSE/ANSI specifications



Part #	Mfg #	Size	Price
106819	610-1/4	1/4"	
106820	610-5/16	5/16"	

Magnetic Tip Stubby Nut Driver - 1-1/2" Hollow Shank

- Rare Earth magnetic tip
- Full hollow shank for long bolts or studs
- Meets or exceeds applicable AMSE/ANSI specifications



Part #	Mfg #	Size	Price
109254	610-1/4M	1/4"	
109255	610-5/16M	5/16"	

Magnetic Tip Nut Driver - 3" Hollow Shank

- Rare Earth magnetic tip
- Handle end is color-coded for easy identification
- Chrome-plated



Part #	Mfg #	Size	Price
109256	630-1/4M	1/4"	
109257	630-5/16M	5/16"	

Nut Driver - 3" Hollow Shank

- Standard length for most applications
- Fits over long bolts and studs



Part #	Mfg #	Size	Price
106818	630-1/4	1/4"	
106817	630-5/16	5/16"	
111184	630-3/8	3/8"	
111185	630-7/16	7/16"	
111183	630-1/2	1/2"	
111154	630-5/8	5/8"	

Magnetic Tip Nut Driver - 6" Hollow Shank

- Rare Earth magnetic tip
- Handle end is color-coded for easy identification
- Chrome-plated



Part #	Mfg #	Hex Size	Shaft Lgth	Price
110347	646-1/4M	1/4"	6"	
110346	646-5/16M	5/16"	6"	
112223	618-5/16M	5/16"	18"	

Cushion Grip Nut Driver Sets

Magnetic Tip Stubby Nut Driver Set - 1-1/2" Hollow Shank

- Full hollow shank for long bolts or studs
- Meets or exceeds applicable AMSE / ANSI specifications



Part #	Mfg #	Description	Price
125143	610M	1/4" & 5/16"	

Tools

Screwdrivers & Bits

Magnetic Tip Nut Driver Set - 3" Hollow Shank

- Rare Earth magnetic tip
- Cushion grip handle
- Color-coded handle end
- Internal flanges provide solid, twist-resistant shaft anchor
- Chrome-plated shaft helps prevent corrosion



Part #	Mfg #	Description	Price
125644	630M	1/4" & 5/16"	

Magnetic Tip Nut Driver Set - 6" Hollow Shank

- Rare Earth magnetic tip
- Handle end is color-coded for easy identification
- Chrome-plated



Part #	Mfg #	Description	Price
106816	646M	1/4" & 5/16"	

4-Piece Nut Driver Set - 3" Hollow Shank

- Color-coded handle end
- Cushion grip handle
- Chrome-plated
- Internal flanges provide solid, twist-resistant shaft anchor



Part #	Mfg #	Description	Price
141334	633	1/4", 5/16", 3/8" & 9/16"	

7-Piece Magnetic Tip Cushion Grip Nut Driver Set



Part #	Mfg #	Description	Price
111285	631M	3" Shank	

Screwdriver/Nut Driver Combinations

10-in-1 Screwdriver/Nut Driver

- End of handle is marked to quickly identify tool
- Includes:
 - 5/16" & 1/4" Nut drivers
 - #1 & #2 Phillips
 - 1/4" & 3/16" Slotted
 - #10 & #15 TORX®
 - #1 & #2 Square-recess
- Cushion grip handle



Part #	Mfg #	Description	Price
107643	32477	10-in-1 Screwdriver/Nut Driver	

11-in-1 Screwdriver/Nut Driver

- End of handle is marked to quickly identify tool
- Includes:
 - 3/8", 5/16" & 1/4" Nut drivers
 - #1 & #2 Phillips
 - 1/4" & 3/16" Slotted
 - #10 & #15 TORX®
 - #1 & #2 Square-recess
- Cushion grip handle



Part #	Mfg #	Description	Price
113299	32500	11-in-1 Screwdriver/Nut Driver	

10-Fold™ 10-in-1 Screwdriver/Nut Driver

- Folding pocket-style 10-in-1 tool with interchangeable bits - (8) screwdriver sizes and (2) nut drivers
- Unfolds and locks at a 180° angle to provide a straight screwdriver
- Blast finish steel bits provide a firm hold to the fastener to reduce cam-out
- Contains:
 - 5/16" & 1/4" Nut drivers
 - #1 & #2 Phillips
 - 1/4" & 3/16" Slotted
 - T10 & T15 TORX
 - #1 & #2 Square-recess



Part #	Mfg #	Description	Price
130688	32535	10-Blade Folding Screwdriver	

Tools

Screwdrivers & Bits

11-in-1 Screwdriver/Nut Driver with Valve Removal/ Installation Bit

- Includes a TR-4 Schrader® valve core installation/ removal and core extractor bit
- End of handle is marked to quickly identify tool
- Includes:
 - 3/8", 5/16" & 1/4" Nut drivers
 - #1 & #2 Phillips
 - 1/4" & 3/16" Slotted
 - #1 & #2 Square
 - Schrader valve core removal/ installation - extractor
- Cushion grip handle



Part #	Mfg #	Description	Price
130822	32527	11-in-1 Screwdriver/Nut Driver w/Schrader Valve Core Tool	

Magnetic Screwdriver with 32-Piece Bit Set

- Non-ratcheting screwdriver
- Tamperproof bit set in block includes:
 - TORX® - T7, T8, T10, T15, T20, T25, T27, T30, and T40
 - Fraction hex - 3/32", 7/64", 1/8", 9/64", 5/32", and 3/16"
 - Metric hex - 2mm, 2.5mm, 3mm, 4mm, and 5mm
 - Spanner - 4, 6, 8, and 10
 - Tri-Wing® - 1, 2, 3, and 4
 - TORQ-SET® - 6, 8, and 10
 - 1/4" Square to 1/4" hex adapter to drive sockets
- Cushion grip handle



Part #	Mfg #	Description	Price
114766	32510	Screwdriver w/32-Pc Bit Set	

Drill Bits

32-Piece Standard Tip Bit Set

- Chrome-plated
- Internal flanges
- Heat-treated shaft
- Precision-machined tip
- Patented Tip-Ident® quickly identifies the screwdriver type and tip orientation
- PVC Black block for storage
- Block slides over most screwdriver shafts for easy bit access and installation
- Industrial strength, heat-treated bits
- Includes:
 - Hex bits: 5/64", 3/32", 7/64", 1/8", 9/64", 5/32" and 3/16"
 - Phillips bits: #0, #1, #2, and #3
 - Square recess bits: #1, #2 and #3
 - TORX® bits: T6, T7, T8, T10, T15, T20 and T25
 - Slotted bits: 3-4, 5-6, 6-8, 8-10, 10-12, and 12-14
 - Clutch bits: 5/32" and 3/16"
 - 1/4" Square to 1/4" hex adapter to drive sockets

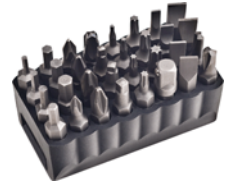

Part #	Mfg #	Description	Price
114768	32526	32-Piece Bit Set	

Tools



Sensible Products



Sensible Products

Screwdrivers & Bits

Slide Drivers

Slide Driver

- 1/4" Driver and 5/16" driver-in-one tool
- Magnetized



Part #	Mfg #	Description	Price
136605	SD-10	10" Length	

Bit Driver Slide Driver

- Fits into your drill
- Magnetized
- Thumb nut safety lock for slide driver
- 1/4" Driver and 5/16" driver-in-one tool

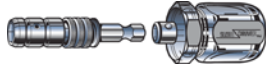

Part #	Mfg #	Description	Price
137282	SDBD-1	3" Length	

Tools

Screwdrivers & Bits

Power Bits

Phillips Bit



Part #	Mfg #	Description	Price
041954	S41-306	#2 Point, 1/4" Hex, 1" Long	

Tools

Screwdrivers & Bits

Screwdrivers & Bits

9 in 1 Multi-Tool

- Slip-resistant grip
- Thick-walled shaft
- Included:
 - Bits
 - Valve core remover
 - Square #2
 - 1/2" Hex
 - 5/16" Hex
 - 3/8" Hex
 - Phillips #1 & #2
 - 3/16" and 1/4" slotted



Part #	Mfg #	Description	Price
165766	1839053	9-in-1 Multi-Tool	

Precision Screwdriver Set

- Comfortable grips
- Maximum precision
 - Rotating head allows for precise adjustments
- Quick identification with easy-to-read tips
- Pouch included for storage
- Includes:
 - #0x3" Phillips, 1/16"x2", 3/32"x3", 1/8"x4", 1/8"x6" Slotted



Part #	Mfg #	Description	Price
174627	1891089	5-Pc Set	

3" Shaft Magnetic Nut Drivers

- Secure hold
- Color-coded for quick identification
- Slip-resistant grip
- Hollowed shaft allows for use on long bolts
- Chrome-vanadium steel construction



Part #	Mfg #	Description	Price
171359	1839059	Red, 1/4" x 3"	
171360	1839060	Yellow, 5/16" x 3"	

6" Shaft Magnetic Nut Drivers

- Secure hold
- Color-coded for quick identification
- Slip-resistant grip
- Hollowed shaft allows for use on long bolts
- Chrome-vanadium steel construction



Part #	Mfg #	Description	Price
171362	1839068	Red, 1/4" x 6"	
171363	1839069	Yellow, 5/16" x 6"	
171364	1839074	Set of 2, 1/4" & 5/16"	

Tools

Sheet Metal Tools

Snips for Metal and Vinyl

Max2000™ Aviation Snips

- An adjustable crossover disk assures an optimal length of cut that remains smooth and accurate
- Machined serrations on outside face of cutting edge
- Thicker, stronger steel handle resists abuse and will not collapse under normal use
- Length: 10-3/4"



M2001



M2002



M2003

Part #	Mfg #	Description	Price
032962	M2001	Cuts Left, Red Ergonomic Grip	
032963	M2002	Cuts Right, Green Ergonomic Grip	
032964	M2003	Combination, Yellow Ergonomic Grip	

Max2000™ Bulldog Aviation Snips

- Designed for notching and trimming
- Ideal for cutting multiple layers or "S" cleats



Part #	Mfg #	Description	Price
032965	M2005	Red Ergonomic Grip	

Max2000™ Offset Aviation Snips

- Cuts straight line and 5" diameter circles



M2006



M2007

Part #	Mfg #	Description	Price
036461	M2006	Cuts Offset Left, Red Ergonomic Grip	
036462	M2007	Cuts Offset Right, Green Ergonomic Grip	

Andy™ Classic Snips

- Suitable for mild curve cuts, straight shearing, or cutting multiple layers of sheet metal
- Lightweight aluminum handle
- 3" Cutting length



Part #	Mfg #	Description	Price
006451	M12A	12" Length	

Andy™ Pattern Snips

- Ground blade edge
- Suitable for mild curve cuts, straight shearing, or cutting multiple layers of sheet metal
- Lightweight aluminum handle
- Larger handle loops
- Extended blade tips
- 3-1/4" Cutting length



Part #	Mfg #	Description	Price
057978	M14N	14" Length	

Sheet Metal Tools

Awls

Scratch Awl

- High carbon alloy tool steel blade polished to resist rust
- May be re sharpened many times
- Easy-to-spot orange handles are shock and shatter resistant

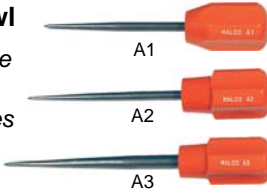

Part #	Mfg #	Blade Dia	Nom Length	Price
006370	A1	7/32"	5-3/4"	
006371	A2	1/4"	6-1/4"	
006373	A3	3/8"	7-1/2"	

Scribers

Pocket Size Sheet Metal Scriber

- Five teeth produce 10 scribing depths
- Compact scribe stores in pocket, pouch or tool box
- Use hang hole or magnet to keep handy on the job



Part #	Mfg #	Min/Max Adjustments	Price
038068	A40	1/8" - 1" Depths	

Adjustable Sheet Metal Scriber

- Measure, mark and scribe in one easy operation
- Depth up to 12-1/2"
- Compact design
- Durable construction
- Constructed of rust resistant nickel plated steel
- Knob assembly with hardened steel bolt insert will not strip out
- Uses Zip-In® sheet metal screw making point replacement easy



Part #	Mfg #	Min/Max Adjustments	Price
006376	A60	1/4" - 12-1/2" Depths	

Dividers

- Length: 11"
- Scratch awl points are easily re sharpened or replaced
- Nickel-plated steel body



Part #	Mfg #	Description	Price
006515	#18	32" Max Circle Diameter	
006522	#24	42" Max Circle Diameter	

Dividers (Continued)

Part #	Mfg #	Description	Price
021655	RP2	Divider Points for #18 and #27	

Folding Tools

- Folding seams are formed from two steel halves, permanently joined together



Part #	Mfg #	Width	Folding Depths	Price
006512	12F	12"	3/8" and 1"	
006516	18F	18"	3/8" and 1"	

Duct Tools and Accessories

Duct Stretcher

- Wheels can be changed to other side of tool for applications where side of duct is close to wall or obstruction



Part #	Mfg #	Description	Price
006386	DS1	16"	
006388	DS2	16" Offset Handle	
025654	DS3	12" Locking	

TurboShear™ Drills

TurboShear™

- Attaches to the chuck of a 1200 rpm, 12V cordless or an A/C electric drill
- Makes fast cuts in sheet metal
- Capable of making precise 6" x 6" square hole cuts
- 20 Gauge capacity in spiral duct
- 18 Gauge capacity in galvanized steel
- Material must be pre-set or held by an assistant
- Shear cuts to the left
- Use TSDC drill clamp for 1-hand operation



Part #	Mfg #	Description	Price
067222	TS1	TurboShear™ Sheet Metal Cutter	

Sheet Metal Tools

Hole Cutters

"Gold Standard" Hole Cutter

- Cuts holes up to 12" diameter in 20 gauge sheet metal
- Use with any standard 1/4" electric drill
- Cast aluminum body
- All wearing parts made of special heat-treated steel



Part #	Mfg #	Hole Diameter	Price
006408	HC1	2" - 12"	

REDLINE™ Hand Tools

5-Blade Pipe Crimper

- One-hand operation latch
- Soft-touch, non-slip handle insert
- Ergonomically contoured handles



Part #	Mfg #	Throat Depth	Price
131064	C5R	1-5/8"	

Hand Notcher

- One-hand operation latch
- Soft-touch, non-slip handle insert
- Ergonomically contoured handles
- Opening maximizes handle leverage



Part #	Mfg #	Throat Depth	Price
132797	N1R	13/16"	
132798	N2R	1"	

Hand Seamer with Forged Steel Jaw

- One-hand operation latch
- Soft-touch, non-slip handle insert
- Ergonomically contoured handles
- Opening maximizes handle leverage



Part #	Mfg #	Jaw Depth	Jaw Width	Price
132799	S2R	1-1/4"	3-1/4"	
132801	S6R	1-1/4"	6"	

Offset Hand Seamer with Forged Steel Jaw

- One-hand operation latch
- Soft-touch, non-slip handle insert
- Ergonomically contoured handles
- Opening maximizes handle leverage



Part #	Mfg #	Jaw Depth	Jaw Width	Price
132800	S3R	1-1/4"	3-1/4"	

Snap Lock Punch for Siding

- One-hand operation
- Ergonomic handles
- Opening maximizes handle leverage



Part #	Mfg #	Length	Throat Depth	Price
006483	SL1R	8"	3/8"	

Sheet Metal Tools

Crimpers

Single Crimper with Red Grip

- Fast, easy to use and lightweight
- Handy lock makes tool pocket sized
- Length: 8"



Part #	Mfg #	Throat Depth	Price
020268	SC1	1-1/4"	

Riveting Tools

2-in-1 Hand Riveter

- Adjustment features a single long stroke and a short ratchet action



Part #	Mfg #	Capacity	Price
006518	2-IN-1	1/8"-3/16" Rivet w/Steel Mandrel, 3/32- 5/32" Rivet w/SS Mandrel 8"Long	

Fiberglass Flex Duct Tools

Tensioning Tool

- Hardened steel stampings with weather resistant nickel chrome finish
- Vinyl grips with hand stops
- Tensioning adjustment knob and auto cut-off mechanism



Part #	Mfg #	Description	Price
006499	TY6	High Leverage Tie Tool, Auto Cut-Off	

Tie Tool

- Action tie tools feature long wearing, serviceable parts
- Comfortable handles reduce the pinch point area
- Works on all ties including thin designs



Part #	Mfg #	Description	Price
006498	TY4	Manual Cut-Off	

Flex Duct Cutter and Shear

- Double edged knife blade
- Thumb operated latch
- Easily resharpenable
- Handles feature non-slip vinyl grips



Part #	Mfg #	Description	Price
006389	FDC1	Flex Duct Cutter	

Tools

Sheet Metal Tools

Snips

Aviation Snips

- One handed locking
- Flush bolt design
- Forged alloy steel blades
- Hard chrome-plated blades reduces corrosion and protects against rust
- Serrated jaws
- Ergonomic handles



48-22-4010



48-22-4020



48-22-4030

Part #	Mfg #	Description	Price
150222	48-22-4010	Left Cutting	
150224	48-22-4020	Right Cutting	
150220	48-22-4030	Straight Cutting	

Offset Snips

- 45 Degree offset
- One handed locking - Ease of use/quick open & close
- Flush bolt design
- Forged alloy steel blades
- Rust protection - hard chrome plated blades increases tool life by reducing corrosion
- Serrated jaws - cuts: up to 18ga CRS (Cold rolled steel); 22ga SS (Stainless steel)
- Ergonomic handles



Part #	Mfg #	Description	Price
163181	48-22-4012	Left Cutting Offset Snips	
163182	48-22-4022	Right Cutting Offset Snips	
163183	48-22-4032	Straight Cutting Offset Snips	

Bulldog Snips

- One handed locking - ease of use quick open & close
- Flush bolt design
- Forged alloy steel blades
- Rust protection
- Serrated jaws - cuts up to 16ga CRS (Cold rolled steel); 18ga SS (Stainless steel)
- Ergonomic handles



Part #	Mfg #	Description	Price
163647	48-22-4000	Bulldog Snips	

Right Angle Snips

- One handed locking - ease of use/quick open & close
- Flush bolt design
- Forged alloy steel blades
- Rust protection - hard chrome plated blades increases tool life by reducing corrosion
- Serrated jaws - Cuts up to 24ga cold rolled steel; 28ga stainless steel
- Ergonomic handles



Part #	Mfg #	Description	Price
163488	48-22-4011	Left Cutting Right Angle Snips	
162739	48-22-4021	Right Cutting Right Angle Snips	

3-Piece Aviation Snips Set

- One-handed locking
- Flush bolt design
- Forged alloy steel blades
- Rust protection
- Serrated jaws cuts up to 18 gauge cold rolled steel and 22 gauge stainless steel
- Ergonomic handles
- Includes:
 - Straight cutting snips (48-22-4030)
 - Right cutting snips (48-22-4020)
 - Left cutting snips (48-22-4010)



Part #	Mfg #	Description	Price
147911	48-22-4033	3-Pc Aviation Snips Set	

Job site Straight Scissors

- Iron carbide edge blades
- Smooth blades for burr-free cuts
- All metal core
- Bolt lock technology
- Rust protection
- Large handle loops
- Ruler markings on blade
- Index finger groove



Part #	Mfg #	Description	Price
168966	48-22-4041	Job site Straight Scissors	

Tools



Sheet Metal Tools

Job site Offset Scissors

- Iron carbide edge blades
- Micro-Serrated blades for grip while cutting
- All metal core
- Bolt lock technology
- Rust protection
- Large handle loops
- Ruler markings on blade
- Index finger groove



Part #	Mfg #	Description	Price
168964	48-22-4040	Job site Offset Scissors	

Sheet Metal Tools

Sheet Metal Tools

5-Blade Crimper

- All steel construction and nickel-plating
- Produces indentations in stove pipe and round duct
- Crimps 24 gauge CRSM and 24 gauge SSSM



Part #	Mfg #	Handle Color	Length	Price
106830	86550	Blue	9"	

Hand Notcher

- Creates 30° "V"-shaped cuts in sheet metal
- Forged, high impact steel jaw with 13/16" maximum throat depth
- All steel construction with nickel-plated and black-oxide finish



Part #	Mfg #	Handle Color	Length	Price
106831	86551	Blue	8-1/2"	

Straight Hand Seamer - 3-1/4" Jaw

- For bending and flattening sheet and non-ferrous metals
- 3-1/4" Wide forged, high impact steel jaws are marked in 1/4" increments
- All steel construction and nickel-plated



Part #	Mfg #	Handle Color	Length	Price
106828	86553	Blue	8-3/8"	

Offset Hand Seamer

- Compound-leverage mechanism easily bends, seams and flattens sheet metal
- For use in overhead and confined areas
- Broader jaw model for forming wider folds
- Folds 22 gauge CRSM and 24 gauge SSSM
- Jaw marked in 1/4" (6 mm) increments for precise bending measurements
- Heavy-duty jaw/handle linkage for durability and easy operation
- All steel construction and nickel-chrome plated hardware
- Vinyl grips with handle stops



Part #	Mfg #	Handle Color	Length	Price
106829	86552	Blue	8"	

Offset Seamer Tong

- Hot drop-forged
- Bending depth indicators marked in 1/4" increments
- Bends 22 gauge CRSM
- Cushioned handles



Part #	Mfg #	Handle Color	Length	Price
108257	86554	Red	9-3/4"	

Folding Tool

- (2) Folding depths:
 - 3/8" (10mm)
 - 1" (925mm)
- Handy sight gauges
- Made of heavy-duty 16 gauge steel



Part #	Mfg #	Description	Price
108249	88980	12" Long	
108250	88981	18" Long	
108252	88982	24" Long	

Duct Stretcher

- Aligns and pulls ductwork together, easing installation of drive cleats
- Offset handle protects hand



Part #	Mfg #	OAL	Price
108255	89565	16"	

Tools

Sheet Metal Tools

Cutting and Notching Tools

Tinner Snips

- 6" Angled, hollow-ground cutting edge for cutting full 3-1/2" (89 mm) straight cuts and wide curves
- Easily replaceable cutting blades made of high-carbon steel
- Cutting capacity:
 - 22 Gauge cold-rolled sheet metal
 - 26 Gauge stainless steel sheet metal
- Not for use on hardened wire, nails, or any other rounded surface
- Lightweight magnesium handles



Part #	Mfg #	Handle Color	Length	Price
108246	3100	Gray	13"	

Snap Lock Punch

- Compound-leverage mechanism for greater control and easy operation
- Drop-forged steel jaw easily punches 3/8" (9.5mm) wide impressions on metal edges to easily join pieces of sheet metal, duct, or pipe
- All-steel construction and nickel-chrome plated hardware provide long life and durability
- Vinyl grips with handle stops for added comfort and easy operation



Part #	Mfg #	Handle Color	Length	Price
108254	86560	Blue	8"	

Cutting and Notching Snips

Journeyman Offset Snips

- Soft touch grips
- Klein Kurve® handles



J2100L



J2102S



J2101R



J2106S

Part #	Mfg #	Overall Length	Cutting Pattern	Color Code	Price
130818	J2100L	9-1/2"	Left/Str	Red/Blk	
130819	J2101R	9-1/2"	Right/Str	Grn/Blk	
130820	J2102S	9-1/2"	Straight	Yel/Blk	
130821	J2106S	10-1/2"	Straight Long Blade	Yel/Blk	

Aviation Snips



1100L



1101R



1102S



2100L



2101R



2102S



2103

Part #	Mfg #	Overall Length	Cutting Pattern	Color Code	Price
106833	1100L	9-3/4"	Left	Red	
106832	1101R	9-3/4"	Right	Green	
108247	1102S	10-1/8"	Straight	Yellow	
106835	2100L	9-1/2"	Offset Left	Red	
106836	2101R	9-1/2"	Offset Right	Green	
108248	2102S	9-1/2"	Offset Str	Yellow	
106834	2103	9-1/4"	Notch	Yellow	

Tools

Sheet Metal Tools

Snips

Aviation Snips

- Long blade life
- Ultimate spring durability
- Quick identification



22102



22101



22103

Part #	Mfg #	Description	Price
102088	22101	Cuts Left	
104542	22102	Cuts Right	
103683	22103	Straight	

Offset Snips

- Long blade life
- Ultimate spring durability
- Quick identification



22206



22207

Part #	Mfg #	Description	Price
103680	22206	Cuts Left	
103681	22207	Cust Right	

Tools

Sheet Metal Tools

General Purpose Tools

Offset Snips

- 1-1/2" Cut length



796



797



Part #	Mfg #	Model	Description	Length	Price
017927	16202	796	Cuts Right	10-1/2"	
017926	16207	797	Cuts Left	10-1/2"	

Sheet Metal Tools

Sheet Metal Tools

Aviation Snips

- Comfortable grip
- High-carbon steel blades with reinforce chrome silicon spring
- Color-coded handle inserts and splines



Part #	Mfg #	Description	Price
177210	1891133	Aviation Snips Left Cut	
177211	1891134	Aviation Snip Right Cut	

Hand Seamers

- Comfortable grip
- High-carbon steel blades with reinforced chrome silicon spring
- Quick notification with 1/4" depth marks on blades



Part #	Mfg #	Description	Price
174605	1891183	3" Offset Hand Seamer	
174604	1891185	3" Hand Seamer	

Folding Tools

- Built for both 3/8" (10mm) and 1" (25mm) folds
- Equipped with sight holes for proper depth alignment



Part #	Mfg #	Description	Price
174607	1891146	12" Folding Tool	
174608	1890985	18" Folding Tool	
174610	1890986	24" Folding Tool	

Hole Cutters

- Lightweight aluminum frame, with a milled bit
- Inch and metric scales
- Fits into any corded or cordless drill with a 1/4" or larger chuck



Part #	Mfg #	Description	Price
175060	1891191	2" to 12" Hole Cutter	

Tools

Shovels

Shovels



Round Point Shovel with Long Handle

- 14 Gauge steel head and ferrule
- Shovel blades and shanks are 1-piece rustproof, taper-formed, then heat treated
- Handle length: 47"



Part #	Mfg #	Model	Blade Size	Price
008693	52300	170	8-5/8" x 11-1/2"	

Shovels

Heavy-Duty Commercial Shovels

Round Point Shovel with Long Fiberglass Handle

- 12 Gauge steel head and ferrule
- Closed back
- Wood reinforced fiberglass handle
- Handle length: 48-1/2"
- Overall length: 59-1/4"
- 100% American made



Part #	Mfg #	Description	Price
136120	92515	12ga Round Point Shovel	

Spades

Drain Spade D-Grip with Fiberglass Handle

- 12 Gauge steel head and ferrule
- Closed back
- Wood reinforced fiberglass handle
- Handle length: 32"
- Overall length: 40"
- 100% American made



Part #	Mfg #	Description	Price
136121	92535	12ga Drain Spade, Closed	

Floral & Speciality Shovels

Mud Shovel with Long Fiberglass Handle

- 14 Gauge steel head and ferrule
- Closed back
- Wood reinforced fiberglass handle
- Handle length: 48-1/2"
- Overall length: 59"
- 100% American made



Part #	Mfg #	Description	Price
136122	92705	14ga Mud Shovel, Closed	

Trunk Shovel with D-Grip Steel Handle

- 14 Gauge steel head and ferrule
- Closed back
- Steel handle
- Handle length: 24-1/2"
- Overall length: 32-3/4"
- 100% American made



Part #	Mfg #	Description	Price
147666	92712	14ga Trunk Shovel, Steel	

Tools

Trouble Lights/Extension Cords

Extension Cords

Orange Extension Cord

- 12/3 SJT
- Super heavy duty
- Outdoor/ Grounded
- Safety orange color



Part #	Mfg #	Description	Price
224081	E25005	12/3 SJT, 25 ft.	
224082	E25006	12/3 SJT, 50 ft.	

Shop Heater

- Fan forced wire element
- Three settings: 750/1500 watts
- Adjustable thermostat
- Wide stable base and adjustable tilt
- All metal body
- Long 6 ft. cord
- Padded carry handle
- Box: 10" x 7" x 11.5"



Part #	Mfg #	Description	Price
224080	H90101	Portable Shop Heater	

Work Lights

Trouble Light with Metal Cage

- Industrial quality
- 25 ft. cord
- 16/3 SJT
- 3-Prong side outlets
- Metal cage



Part #	Mfg #	Description	Price
224083	E25021	16/3 SJT, 25 ft.	

Portable Halogen Work Light

- 500 Watt
- 6 ft. Grounded
- Power cord
- Adjustable frame



Part #	Mfg #	Description	Price
190131	E25250	6 ft Grounded, 500 Watt	



Trouble Lights/Extension Cords

Work Lights

Fluorescent Trouble/Work Light

Part #	Mfg #	Description	Price
140727	D12812025	6' Orange Trouble Light with Grounded Outlet	

Trouble Lights/Extension Cords

Light Bulbs

Rough Service Light Bulb

- *Multi-support filament*
- *Lasts twice as long as a standard bulb*
- *Frosted to reduce glare*



Part #	Mfg #	Description	Price
002314	8502	100 Watt Frosted	

Wrenches

Wrenches

Heavy-Duty Straight Pipe Wrench

- Sturdy, cast iron housing and I-beam hand with full floating forged hook jaw, nonstick adjustment nut and replaceable hook and heel jaws



Part #	Mfg #	Model	Nom Size	Pipe Capacity	Price
008714	31010	10	10"	1-1/2"	
008686	31020	14	14"	2"	
008695	31025	18	18"	2-1/2"	
029928	31030	24	24"	3"	

Aluminum Handle Straight Pipe Wrench

- Nearly 40% lighter than comparable cast iron models of the same size
- Jaws and all other parts identical to RIDGID heavy-duty wrenches



Part #	Mfg #	Model	Nom Size	Pipe Capacity	Price
008768	31090	810	10"	1-1/2"	
054899	47057	812	12"	2"	
008770	31095	814	14"	2"	
008772	31100	818	18"	2-1/2"	
008774	31105	824	24"	3"	
026610	31115	848	48"	6"	

Aluminum Handle Offset Pipe Wrench

- Nearly 50% lighter than comparable cast iron models of the same size
- Features a jaw opening parallel to the handle and narrower hook jaw head which provides easy entry into tight spots



Part #	Mfg #	Model	Nom Size	Pipe Capacity	Price
022973	31125	18	18"	2-1/2"	

Strap Wrench

- Best for any polished pipe
- Strong, woven nylon strap gives tight grip
- Polyurethane-coated strap prevents scratching
- Replacement straps available



Part #	Mfg #	Model	Handle Length	Strap Length	Strap Width	Pipe Capacity	OD Tube Capacity	Price
008700	31340	2	11-3/4"	17"	1-1/8"	2"	3-1/2"	

Hex Wrench

- Gives multi-sided, secure grip on all hex nuts, square nuts, unions, and valve packing nuts



Part #	Mfg #	Model	Description	Nom Size	Pipe Capacity	Price
008571	31305	E110	Offset Hex	9-1/2"	1-1/8" - 2-5/8"	

Tools

Wrenches

Spud Wrench

- *Narrow jaws to fit into tight places*
- *Smooth, toothless jaws ideal for square or rectangular stock*



Part #	Mfg #	Size	Pipe Capacity	Price
008717	31400	12"	3/8" - 2-5/8"	

Adjustable Wrench

- *High strength forged, precision broached superior strength*
- *Wider and deeper jaws increased bite and grip surface*
- *Nickel plated superior corrosion resistance*
- *Acid etched scales English and metric readings*



Part #	Mfg #	Model	Nom Size	Pipe Capacity	Price
050314	86902	756	6"	3/4"	
050315	86907	758	8"	7/8"	
050323	86912	760	10"	1-1/8"	
050320	86917	762	12"	1-5/16"	

Basin Wrench

- *Spring-loaded jaws of forged alloy steel*
- *Tension plug holds head in any position up to 90° angle*



Part #	Mfg #	Model	Description	Nom Size	Pipe Capacity	Price
008658	31175	1017	Telescoping Basin	10" - 17"	3/8" - 1-1/4"	
022327	31180	1019	Telescoping Basin	10" - 17"	1-1/4" - 2-1/2"	

Faucet and Sink Installer (Plastic Nut Basin Wrench)

- *Designed to reach and turn plastic mounting nuts on faucets, sprayers and ballcocks*
- *Used to fasten and remove plastic basin nuts, supply line nuts, and 7/8" and 1" hex nuts*
- *Notched ends are designed to self-center on 2, 3, 4 and 6 tab nuts and to fit on metal hex nuts*
- *Strainer basket attachment holds drain unit in place while tightening strainer nut*
- *High strength plastic with aluminum inserts*



Part #	Mfg #	Model	Length	Price
034146	66807	2006	10-1/4"	

OneStop™ Wrench

- *(2) Tools in one*
- *Provides exact size surface wrenches needed for angle stop and compression coupling installation*



Part #	Mfg #	Model	Description	Price
065524	27023	2002	OneStop™ Wrench	

Tools

Wrenches

Wrench Parts



Part #	Mfg #	Description	For Model	Price
008614	31675	Heel Jaw & Pin Assembly	18, 818, E-18, S4A	

Tools

Wrenches

Wrenches

Aluminum Pipe Wrench



Part #	Mfg #	Size	Price
089135	23820-10ALPW	10"	
089136	23821-12ALPW	12"	
089137	23822-14ALPW	14"	
089138	23823-18ALPW	18"	
089139	23824-24ALPW	24"	

Heavy-Duty Cast Iron Pipe Wrench



Part #	Mfg #	Size	Price
096094	23813-10HDPW	10"	
096096	23814-12HDPW	12"	
096917	23815-14HDPW	14"	

Tools

Wrenches

Wrenches

Chrome Adjustable Wrench

- Longer jaws grip better, avoiding slippage or nut round off
- Measurement scales are handy for sizing nuts, pipe and tube diameters
- Greater jaw capacity supports larger nuts and bolts
- Thinner jaws for greater access in tight spaces
- Precise jaw design grips tight the first time
- Four thread knurl and non-protruding jaws provide greater capacity
- Minimal head width improves performance in confined spaces
- Chrome vanadium steel construction



Part #	Mfg #	Length	Capacity	Price
058194	R114800	4-1/2"	1/2"	
058195	R114900	6-1/4"	15/16"	
058196	R115000	8"	1-3/16"	
058197	R115100	10"	1-3/8"	
058198	R115200	12"	1-1/2"	

Code Blue® Adjustable Wrench

- Longer jaws grip better, avoiding slippage or nut round off
- Measurement scales are handy for sizing nuts, pipe and tube diameters
- Greater jaw capacity supports larger nuts and bolts
- Thinner jaws for greater access in tight spaces
- Precise jaw design grips tight the first time
- Four thread knurl and non-protruding jaws provide greater capacity
- Minimal head width improves performance in confined spaces
- Code Blue® grips are designed for durability and comfort



Part #	Mfg #	Length	Capacity	Price
117996	R115560	8"	1-1/2"	

Radiator Nipple Wrench

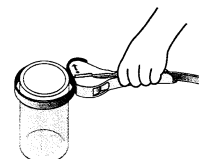

Part #	Mfg #	Description	Price
029136	R126145	Rubber Strap Wrench, 3/8" to 5-1/2"	

Drain Wrench

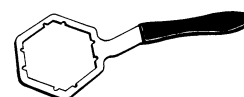

Part #	Mfg #	Description	Price
032867	R124710	Drain Wrench	

Tools

Wrenches

Adjustable Wrenches

Standard-Jaw Design Adjustable Wrench - Plastic Dipped Handles

- Plastic dipped handles
- Forged heat treated alloy steel for maximum strength and lightweight
- High polish chrome finish



Part #	Mfg #	Length	Capacity	Price
111292	D506-4	4-1/2"	1/2"	

Adjustable Wrench - Extra Capacity Plastic Handle

- Excellent in confined spaces
- High polish chrome finish



Part #	Mfg #	Length	Capacity	Price
112170	D507-6	6-3/8"	15/16"	
107650	D507-8	8-3/8"	1-1/8"	
106824	D507-10	10-3/8"	1-5/16"	
123781	D507-12	12-3/8"	1-1/2"	

Ratcheting Box Wrenches

Fully Reversible Ratcheting Refrigeration Wrench

- Fully reversible ratchet wrenches designed for refrigeration packing gland nuts and valve stem sockets
- Also designed for beam clamp installation
- Wrenches are compact in size, with clearly marked sockets for four nut sizes
- Chrome finish



Part #	Mfg #	Socket Sizes	Price
113965	68310	3/16" & 5/16" Square x 1/4" & 3/8" Square	

Ratcheting Box Wrench Sets

3-Piece Fully Reversible Ratcheting Offset Box Wrench Set

- Includes:
 - 68234 1/4" x 5/16"
 - 68236 3/8" x 7/16"
 - 68238 1/2" x 9/16"



Part #	Mfg #	Socket Sizes	Price
106827	68244	3-Piece Set	

L-Style Hex Keys Sets

- Long side for accessing hard-to-reach places
- Short side for higher torque situations and low clearances

12-Piece L-Style Hex Ball-End Caddy Set - Inch

- Includes:
 - BL2 .050"
 - BL4 1/16"
 - BL5 5/64"
 - BL6 3/32"
 - BL7 7/64"
 - BL8 1/8"
 - BL9 9/64"
 - BL10 5/23"
 - BL12 3/16"
 - BL14 7/32"
 - BL16 1/4"
 - BL20 5/16"



Part #	Mfg #	Description	Price
112667	BLK12	12-Piece Set - Inch	

Folding Hex Key Sets

9-Key Hex Set

- Sizes:
 - 5/64"
 - 3/32"
 - 7/64"
 - 1/8"
 - 9/64"
 - 5/32"
 - 3/16"
 - 7/32"
 - 1/4"



Part #	Mfg #	Description	Price
106826	70591	4-1/4" Length	

Wrenches

Ratchet Wrenches

Ratchet Wrench



- For installing or servicing heating, air conditioning or refrigeration units

Part #	Mfg #	Square	Hex	Price
006478	RRW3	3/16", 1/4", 5/16", 3/8"	-	

Hex Key Wrench Insert



Part #	Mfg #	Square	Hex	Price
006479	RRW3/16	1/4"	3/16"	

Hex Keys

Folding Hex Key Set

- Professional quality
- Produced from tough alloy steel



Part #	Mfg #	Description	Price
006503	W29	(9) Keys, Deluxe Pocket	

Tools

Wrenches

Razorback™ Wrench

- Remove shower and sink drains from top or bottom with just one hand
- T-Handle rotates 180°



Part #	Mfg #	Description	Price
093510	73055	Razorback™ Wrench	

Wrenches

Tools

Smart Dumbell®

- *Installs or removes drains without cross-bars (Kohler, American Standard)*
- *Heavy duty die-cast aluminum*
- *Prevents scratching of decorative finishes*
- *Use crescent wrench or large Phillips screwdriver to turn the tool*



Part #	Mfg #	Length	Price
008104	4554	6"	

Basin Wrenches

Eureka Cleanout Plug Wrench

- *Fits slotted or square countersunk cleanout plugs*
- *Strong, malleable iron*



Part #	Mfg #	Description	Price
083108	4567	Cleanout Plug Wrench	

Tools

Wrenches

Golden Tool™ Tools

Golden Grip® Internal Pipe Wrench

- *Installs or extracts pipe nipples from the inside*



Part #	Mfg #	Description	Price
080112	97250	Single 1/2"	

Golden Extractor™ Tub Drain Tool

- *Standard 3/8" drive ratchet to extract or install tub drains*



Part #	Mfg #	Description	Price
083657	97258	Universal Size	

Wrenches

Faucet Nut Splitter

- Splits old or new zinc or brass nuts in seconds
- Fits over all 1/2" faucet shanks
- Aluminum with a chisel tip of hardened tool steel



Part #	Mfg #	Description	Price
120323	NS-1	Faucet Nut Splitter	

Plumber's T-Handle Torque Tools

- Unique locking collar
- Slips internally when proper torque achieved



Part #	Mfg #	Socket	Type	in-lbs	Price
022114	2-SH	5/16"	Std No-Hub	60	

Tools

Wrenches

Plumbing Specialty Tools

4-Way Key

- For valves, faucets and sillcocks
- Plated steel



Part #	Mfg #	Sizes	Price
041932	J40-005	1/4", 9/32", 5/16" & 11/32"	

Extract-A-Drain Tub Drain Removal Tool

- Removes old or rusty drains
- Prevents damage to your tub's finish



Part #	Mfg #	Description	Price
057806	J40-018	Fits Both 1-1/4" & 1-1/2" Tub Drains	

Compression Sleeve Puller

- Removes leaking compression sleeves without damaging walls
- For 5/8" compression units



Part #	Mfg #	Description	Price
054587	J40-021	Comp Sleeve Puller, Carded	

Faucet Handle Puller

- Removes faucet and valve handles
- Plated steel



Part #	Mfg #	Description	Price
054584	J40-010	Standard Unit	

Wrenches

Element Wrench

- For removing heater elements
- Zinc-plated steel
- Individually bagged



Part #	Mfg #	Description	Price
041934	J36-101	Heavy-Duty	

No-Hub Torque Wrench

- Automatically releases at 60 in/lb
- Ratchets one way
- Built-in reversing lever
- Chrome vanadium socket



Part #	Mfg #	Description	Price
041933	T60-060	Domestic	

Basin Wrench

- 1-1/4" Jaw capacity



Part #	Mfg #	Description	Price
041935	B11-010	10" - 17" Telescoping	
227750	B11-012	9-1/2" - 16-1/2" Telescoping	

Radiator Spud Wrench

- For use as spud key and wrench



Part #	Mfg #	Description	Price
041936	J40-030	Plated Malleable Iron Wrench	

4-Way Plug Wrench



Part #	Mfg #	Description	Price
021060	J40-040	Countersunk Plug Wrench	

4-Way P.O. Plug Wrench

- For installing or removing basket strainers, tub drains and P.O. plugs



Part #	Mfg #	Description	Price
041937	J40-026	Wrench	

Wrenches

Moen® Stem & Cartridge Wrench

- Removes Moen® stems and cartridges
- Works on plastic/brass faucet/shower valves



Part #	Mfg #	Description	Price
054583	J45-015	Stem & Cartridge Wrench (Carded)	

Spanner/Strainer Wrench

- Used for basket strainer jam nuts



Part #	Mfg #	Description	Price
041941	J40-024	Plated Malleable Iron Wrench	

Do All Plumber's Wrench

- Longer, more comfortable handle
- Fits most standard size basket strainers including Opella, Duo, Twist Lock and PB Duo and any strainer which uses a standard 3-3/8" locknut
- Fits most shower stall drains

Part #	Mfg #	Description	Price
054595	J40-019	Do All Plumber's Wrench (Carded)	

Universal Drain Wrench

- Die cast aluminum
- Installs and removes tub drains and closet spuds
- Use crescent wrench or screwdriver to turn tool



Part #	Mfg #	Description	Price
050424	J45010	6" Long	



Sensible Products



Sensible Products

Wrenches

Fan Blade & Blower Wheel Pullers

- Removes fan blades/blower wheels that are frozen to a motor shaft
- Can be used to apply pushing or pulling force
- Includes (4) pulling hooks and (3) set screws
- Accommodates 5/8" belt drive and 1/2" or less direct drive motor shafts



Part #	Mfg #	Description	Price
136604	UP-1	"The Ultimate Puller"	

Tools

Fiberglass Tub Showers

Tub & Showers

2603SG Everyday 1-Piece Tub & Shower

- Smooth wall finish
- Ergonomic backrest
- Installed acrylic grab bar
- Molded toiletry shelves
- Slip resistant textured bottom



Part #	Mfg #	Finished Dimensions	Drain	Color	Price
029540	2603SG-L-WH	60" x 32" x 72"	LH	White	
029542	2603SG-R-WH	60" x 32" x 72"	RH	White	
029562	2603SGM-L-WH	60" x 32" x 74"	LH	White	
030431	2603SGM-L-BI	60" x 32" x 74"	LH	Biscuit	
029564	2603SGM-R-WH	60" x 32" x 74"	RH	White	
033105	2603SGM-R-BI	60" x 32" x 74"	RH	Biscuit	
029987	2603SGT-L-WH	60" x 32" x 78-1/4"	LH	White	
029989	2603SGT-R-WH	60" x 32" x 78-1/4"	RH	White	

2603TRIO Remodeline Sectional 3-Piece Tub & Shower

- Smooth wall finish
- Molded toiletry shelves
- Installed acrylic grab bar
- Gelcoat surface



Part #	Mfg #	Finished Dimensions	Drain	Color	Price
029536	2603TRIO-L-WH	60" x 30" x 72"	LH	White	
029538	2603TRIO-R-WH	60" x 30" x 72"	RH	White	

26032P Remodeline Sectional 2-Piece Tub & Shower

- Smooth wall finish
- Installed acrylic grab bar
- Molded toiletry shelves
- Slip resistant, textured bottom



Part #	Mfg #	Finished Dimensions	Drain	Color	Price
029572	26032P-R-WH	60" x 30" x 72"	RH	White	

Fiberglass Tub Showers

Fiberglass Tub & Shower Combinations

- Sanitary grade polyester gelcoat surface
- 2" Diameter drain, right-hand or left-hand
- 2-1/2" Diameter overflow
- Textured floor pattern
- Balsa wood core floor structure

TS-6032 Vursa 1-Pc Fiberglass Tub & Shower Module

- Rough-in dimensions: 73-3/4" x 60" x 33-1/4" with 16" apron
- Multi-level back wall shelving
- Accessory shelf with wash cloth rod
- Textured floor pattern



Part #	Mfg #	Description	Drain	Finish	Price
145785	TS-6032L-WHT	72-1/2" x 60" x 32" with 16" Apron	LH	White	
145788	TS-6032R-WHT	72-1/2" x 60" x 32" with 16" Apron	RH	White	
145787	TS-6032L-BSC	72-1/2" x 60" x 32" with 16" Apron	LH	Biscuit	
145789	TS-6032R-BSC	72-1/2" x 60" x 32" with 16" Apron	RH	Biscuit	

TS-6032 ABF Vursa 1-Pc Fiberglass Tub & Shower Module

- Rough-in dimensions: 73-3/4" x 60" x 33-1/4" with 16" apron
- Multi-level back wall shelving
- Accessory shelf with wash cloth rod
- Textured floor pattern
- ABF = Above floor rough-in provides 3" drain clearance



Part #	Mfg #	Description	Drain	Finish	Price
126944	TS-6032-ABFL	72-1/2" x 60" x 32" with 17-1/4" Apron	LH	White	
126908	TS-6032-ABFR	72-1/2" x 60" x 32" with 17-1/4" Apron	RH	White	
135338	TS-6032-ABFLBI	72-1/2" x 60" x 32" with 17-1/4" Apron	LH	Biscuit	
135225	TS-6032-ABFRBI	72-1/2" x 60" x 32" with 17-1/4" Apron	RH	Biscuit	

Fiberglass Tub Showers

TS-6034 Vursa 1-Pc Fiberglass Tub & Shower Module

- *Rough-in dimensions: 79-1/4" x 60" x 35-1/4" with 16" apron*
- *Multi-level back wall shelving*
- *Accessory shelf with wash cloth rod*
- *Textured floor pattern*



Part #	Mfg #	Description	Drain	Finish	Price
146309	TS-6034L-WHT	78" x 60" x 34" with 16" Apron	LH	White	
149096	TS-6034R-WHT	78" x 60" x 34" with 16" Apron	RH	White	
149097	TS-6034L-BSC	78" x 60" x 34" with 16" Apron	LH	Biscuit	
149098	TS-6034R-BSC	78" x 60" x 34" with 16" Apron	RH	Biscuit	
164858	TS-6034L-BN	78" x 60" x 34" with 16" Apron	LH	Bone	
164860	TS-6034R-BN	78" x 60" x 34" with 16" Apron	RH	Bone	

TS-6034 ABF Vursa 1-Pc Fiberglass Tub & Shower Module

- *Rough-in dimensions: 79-1/4" x 60" x 35-1/4" with 16" apron*
- *Multi-level back wall shelving*
- *Accessory shelf with wash cloth rod*
- *Textured floor pattern*
- *ABF = Above floor rough-in provides 3" drain clearance*



Part #	Mfg #	Description	Drain	Finish	Price
155091	TS-6034-ABFL	78" x 60" x 34" with 20" Apron	LH	White	
155093	TS-6034-ABFR	78" x 60" x 34" with 20" Apron	RH	White	
155092	TS-6034-ABFL-BSC	78" x 60" x 34" with 20" Apron	LH	Biscuit	

TS-6036 Vursa 1-Pc Fiberglass Tub & Shower Module

- *Rough-in dimensions: 79-1/4" x 60" x 37-1/4" with 18-1/4" apron*
- *Multi-level back wall shelving*
- *Accessory shelf with wash cloth rod*
- *Textured floor pattern*



Part #	Mfg #	Description	Drain	Finish	Price
149092	TS-6036L-WHT	78" x 60" x 36" with 18-1/4" Apron	LH	White	
149093	TS-6036R-WHT	78" x 60" x 36" with 18-1/4" Apron	RH	White	
149094	TS-6036L-BSC	78" x 60" x 36" with 18-1/4" Apron	LH	Biscuit	
149095	TS-6036R-BSC	78" x 60" x 36" with 18-1/4" Apron	RH	Biscuit	

Fiberglass Tub Showers

TS-6036 ABF Vursa 1-Pc Fiberglass Tub & Shower Module

- *Rough-in dimensions: 79-1/4" x 60" x 37-1/4" with 18-1/4" apron*
- *Multi-level back wall shelving*
- *Accessory shelf with wash cloth rod*
- *Textured floor pattern*
- *ABF = Above floor rough-in provides 3" drain clearance*



Part #	Mfg #	Description	Drain	Finish	Price
147914	TS-6036ABFL	78" x 60" x 36" with 20" Apron	LH	White	
147913	TS-6036-ABFR	78" x 60" x 36" with 20" Apron	RH	White	
149009	TS-6036L ABF-BSC	78" x 60" x 36" with 20" Apron	LH	Biscuit	
149010	TS-6036R ABF-BSC	78" x 60" x 36" with 20" Apron	RH	Biscuit	

TS3P-6032 Vursa 3-Pc Fiberglass Tub & Shower Module

- *Rough-in dimensions: 77-1/2" x 60" x 33-1/4" with 16" apron*
- *Multi-level back wall shelving*
- *Accessory shelf with wash cloth rod*
- *Textured floor pattern*



Part #	Mfg #	Description	Drain	Finish	Price
149157	TS3P-6032L-WHT	76-1/4" x 60" x 32" with 16" Apron	LH	White	
149158	TS3P-6032R-WHT	76-1/4" x 60" x 32" with 16" Apron	RH	White	

TS3P-6032 ABF Vursa 3-Pc Fiberglass Tub & Shower Module

- *Rough-in dimensions: 78-3/4" x 60" x 33-1/4" with 17-1/4" apron*
- *Multi-level back wall shelving*
- *Accessory shelf with wash cloth rod*
- *Textured floor pattern*
- *ABF = Above floor rough-in provides 3" drain clearance*



Part #	Mfg #	Description	Drain	Finish	Price
136663	TS3P-6032L ABF-WHT	77-1/2" x 60" x 32" with 17-1/4" Apron	LH	White	
136664	TS3P-6032R ABF-WHT	77-1/2" x 60" x 32" with 17-1/4" Apron	RH	White	
136665	TS3P-6032R ABF-BSC	77-1/2" x 60" x 32" with 17-1/4" Apron	RH	Biscuit	

Tub Showers

Fiberglass Tub Showers

TS-R-45ABF 1-Pc Fiberglass Tub & Shower Module

- *Rough-in dimensions: 76" x 60" x 34-1/2"*
- *Elevated back wall shelf*
- *Lower level soap tray with acrylic rod*
- *ABF = Above floor rough-in provides 3" drain clearance*



Part #	Mfg #	Description	Drain	Finish	Price
092408	TS-R-45RS ABF-WHT	74-3/4" x 60" x 33-1/4"	RH	White	

Tub Shower Doors

Framed Tub & Shower Sliding Doors

Deluxe Framed Sliding Tub Door

- Bypass stop keeps the inside panel on the same side as the shower head
- Distinctive towel bars on the interior and exterior of the door
- Sta-Kleen track prevents dirt buildup
- Roller assembly is slotted so that out-of-square wall conditions can be adjusted up to 3/8"

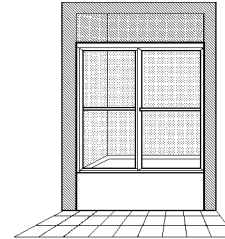

Part #	Mfg #	Fits Openings Between	Height	Glass	Frame	Price
043266	6150-52	50" - 52"	58-1/2"	Obscure	Silver	
043113	6150-56	54" - 56"	58-1/2"	Obscure	Silver	
100067	6150-56S-BN	54" - 56"	56"	Obscure	Brushed Nickel	
084232	6150-58EN	57-11/16"	55"	Obscure	Silver	
043272	6150-60	56" - 60"	58-1/2"	Obscure	Silver	
043496	6150-60S	56" - 60"	56"	Obscure	Silver	

Deluxe Framed Sliding Shower Door

- Bypass stop keeps the inside panel on the same side as the shower head
- Distinctive towel bars on the interior and exterior of the door
- Sta-Kleen track's gentle slope and rounded front keep water in the shower and off the floor
- Roller assembly is slotted so that out-of-square wall conditions can be adjusted up to 3/8"



Part #	Mfg #	Fits Openings Between	Height	Glass	Frame	Price
043318	7150-42	40" - 42"	71-1/2"	Obscure	Silver	
043324	7150-44OC	42" - 44"	71-1/2"	Obscure	Silver	
045052	7150-44T	42" - 44"	68"	Obscure	Silver	
143045	7150-45TAC	44-1/2"	68"	AquaGlideXP Clear	Silver	
100302	7150-46	44" - 46"	71-1/2"	Obscure	Silver	
085380	7150-46T	44" - 46"	68"	Obscure	Silver	
044229	7150-52	49" - 52"	71-1/2"	Obscure	Silver	
067032	7150-54T	52" - 54"	68"	Obscure	Silver	
043332	7150-56OC	54" - 56"	-	Obscure	Silver	
143047	7150-57TAC	60" for Sterling 72290100	68"	AquaGlideXP Clear	Silver	
043405	7150-60	56" - 60"	71-1/2"	Obscure	Silver	
045435	7150-60T	56" - 60"	68"	Obscure	Silver	

Tub Showers

Tub Shower Doors

Frameless Tub & Shower Sliding Doors

3400-3500 Classic Frameless Sliding Tub Door

- *Sta-Kleen tract prevents dirt buildup*
- *(2) Bumpers on each wall jamb to ensure there is no glass-to-metal contact*
- *Frameless roller assembly keeps door in place*
- *Towel bar with acrylic brackets and matching aluminum sleeves*

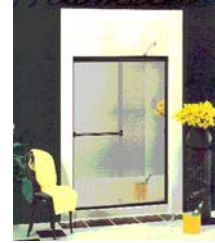

Part #	Mfg #	Fits Openings Between	Height	Glass	Frame	Price
043110	3400-56	52" - 56"	57"	Obscure	Silver	
043263	3400-56S	52" - 56"	56"	Obscure	Silver	
105231	3400-56SOR	52" - 56"	56"	Obscure	Oil Rubbed Bronze	
043176	3400-60	56" - 60"	57"	Obscure	Silver	
043301	3500-44	40" - 44"	70"	Obscure	Silver	
088853	3500-44BN	40" - 44"	70"	Obscure	Brushed Nickel	
095040	3500-45EN	44-5/8"	70"	Obscure	Silver	
043305	3500-48	44" - 48"	70"	Obscure	Silver	
102364	3500-48BN	44" - 48"	70"	Obscure	Brushed Nickel	
046075	3500-56	52" - 56"	70"	Obscure	Silver	
045609	3500-60	56" - 60"	70"	Obscure	Silver	
112578	3500-60BN	56" - 60"	70"	Obscure	Brushed Nickel	

Vikrell - Sterling Tub Showers

Vikrell® Tub & Shower Module



- Solid Vikrell® material for strength and durability
- High-gloss finish

7115 Accord® 32" Tub & Shower Module

- 4-Piece wall set
- No caulking required in the seams
- Bath only installation not recommended
- Molded in shelving on back wall
- Complete unit rough-in dimensions including flanges: 75-1/2" x 60-1/4" x 33-1/4"
- Complete AFD unit rough-in dimensions including flanges: 77-1/2" x 60-1/4" x 33-1/4"



Part #	Mfg #	Description	Drain	Finished Dimensions	Color	Price
122721	71150110-0	Tub & Shower Complete	LH	74-1/4" x 60" x 32"	White	
125865	71150120-0	Tub & Shower Complete	RH	74-1/4" x 60" x 32"	White	
122718	71151110-0	Tub Only, 18" Apron	RH	18" x 60" x 32"	White	
125867	71151120-0	Tub Only, 18" Apron	LH	18" x 60" x 32"	White	
125868	71151120-96	Tub Only, 18" Apron	LH	18" x 60" x 32"	Biscuit	
143833	71151122-0	Tub Only, 18" Apron, AFD	RH	22" x 60" x 32"	White	

7116 Accord® 36" Tub & Shower Module

- Geometric back wall design
- 4-Piece wall set
- No caulking required in the seams
- Abundant, recessed storage
- Complete unit rough-in dimensions: 77-1/2" x 60-1/4" x 37-1/4"



Complete Wall Set

Part #	Mfg #	Description	Drain	Finished Dimensions	Color	Price
137779	71160120-0	Tub & Shower Complete	RH	76-1/4" x 60" x 36"	White	
126606	71161110-0	Tub Only, 20" Apron	LH	23" x 60" x 36"	White	
137778	71161120-0	Tub Only, 20" Apron	RH	23" x 60" x 36"	White	

7114 Accord® 30" Tile Tub & Shower Module

- 4-Piece wall set
- Realistic tile look
- No caulking required in the seams
- Bath only installation not recommended
- Molded in shelving on back wall
- Complete unit rough-in dimensions: 73-1/4" x 60-1/4" x 31-1/4"
- AFD = Above Floor Drain



Left-Hand Drain



Right-Hand Drain



Complete Wall Set

Part #	Mfg #	Description	Drain	Finished Dimensions	Color	Price
102170	71140120-0	Tub & Shower Complete	RH	72" x 60" x 30"	White	
102166	71141110-0	Tub Only, 15" Apron	LH	15" x 60" x 30"	White	
102176	71141110-96	Tub Only, 15" Apron	LH	15" x 60" x 30"	Biscuit	
102674	71141112-0	Tub Only, 15" Apron, AFD	LH	17-1/4" x 60" x 30"	White	

Tub Showers

Vikrell - Sterling Tub Showers

Vikrell® Tub & Shower Module (Continued)

7114 Accord® 30" Tile Tub & Shower Module

Part #	Mfg #	Description	Drain	Finished Dimensions	Color	Price
102168	71141120-0	Tub Only, 17" Apron	RH	17" x 60" x 30"	White	
102179	71141120-96	Tub Only, 17" Apron	RH	17" x 60" x 30"	Biscuit	
113385	71141122-0	Tub Only, 15" Apron, AFD	RH	20-1/4" x 60" x 30"	White	
226243	71141122-96	Tub Only, 15" Apron, AFD	RH	20-1/4" x 60" x 30"	Biscuit	

7124 Accord® 30" Smooth Tub & Shower Module

- 4-Piece wall set
- No caulking required in the seams
- Four integrated and recessed corner shelves
- Complete unit rough-in dimensions: 73-1/4" x 60-1/4" x 31-1/4"
- Complete AFD unit rough-in dimensions: 75-1/2" x 60-1/4" x 31-1/4"
- AFD - Above floor drain



Part #	Mfg #	Description	Drain	Finished Dimensions	Color	Price
107536	71240110-0	Tub & Shower Complete	LH	72" x 60" x 30"	White	
107537	71240110-96	Tub & Shower Complete	LH	72" x 60" x 30"	Biscuit	
138737	71240112-0	Tub & Shower Complete, AFD	LH	74-1/4" x 60" x 30"	White	
107538	71240120-0	Tub & Shower Complete	RH	72" x 60" x 30"	White	
138736	71240122-0	Tub & Shower Complete, AFD	RH	74-1/4" x 60" x 30"	White	
226246	71240122-96	Tub & Shower Complete, AFD	RH	74-1/4" x 60" x 30"	Biscuit	

6103 Advantage™ 30" Tub & Shower Module

- Lightly textured swirl-gloss finish hides scratches from use
- 3-Piece wall set
- Tongue and groove interlocking joints
- Bath only installation not recommended
- (2) Shelves and 18" towel bar on back wall
- Complete unit rough-in dimensions including flanges: 73-1/4" x 60-1/4" x 31-1/4"



Part #	Mfg #	Description	Drain	Finished Dimensions	Color	Price
007817	61030110-0	Tub & Shower Complete	LH	72" x 60" x 30"	White	
007818	61030120-0	Tub & Shower Complete	RH	72" x 60" x 30"	White	
007821	61031110-0	Tub Only, 15" Apron	LH	15" x 60" x 30"	White	
007846	61031120-0	Tub Only, 15" Apron	RH	15" x 60" x 30"	White	

Tub Showers

Vikrell - Sterling Tub Showers

7112 Ensemble™ 32" Tile Tub & Shower Module

- 2" Wainscot on tub allows tile installation above bath deck
- Order back wall and end walls separately
- Tongue and groove interlocking joints
- Shelving on back wall
- Complete unit rough-in dimensions including flanges: 75-1/4" x 60-1/4" x 33-1/4"
- Complete AFD unit rough-in dimensions including flanges: 77-1/4" x 60-1/4" x 33-1/4"
- AFD = Above floor drain



71120110-0

Part #	Mfg #	Description	Drain	Finished Dimensions	Color	Price
079338	71120110-0	Tub & Shower Complete	LH	74" x 60" x 32"	White	
077132	71120120-0	Tub & Shower Complete	RH	74" x 60" x 32"	White	
098105	71120122-0	Tub & Shower Complete, AFD	RH	76" x 60" x 32"	White	
077770	71121110-0	Tub Only, 18" Apron	LH	20" x 60" x 32"	White	
077592	71121110-96	Tub Only, 18" Apron	LH	20" x 60" x 32"	Biscuit	
082991	71121112-0	Tub Only, 20" Apron, AFD	LH	20" x 60" x 32-1/8"	White	
077133	71121120-0	Tub Only, 18" Apron	RH	20" x 60" x 32"	White	
077963	71121120-96	Tub Only, 18" Apron	RH	20" x 60" x 32"	Biscuit	
093803	71121122-0	Tub Only, 20" Apron, AFD	RH	20" x 60" x 32-1/8"	White	

7110 Ensemble™ 36" Tile Oval Tub & Shower Module

- 3" Wainscot allows tile installation above bath deck
- Optional 3-piece wall set
- Realistic tile look
- Tongue and groove interlocking joints
- Shelving on back wall
- Complete unit rough-in dimensions including flanges: 73-1/4" x 60-1/4" x 37-1/2"
- Complete AFD unit rough-in dimensions including flanges: 75-1/2" x 60-1/4" x 37-1/2"
- AFD = Above Floor Drain



71120110-0

Part #	Mfg #	Description	Drain	Finished Dimensions	Color	Price
061465	71101110-0	Tub Only, 19" Apron	LH	19" x 60" x 36"	White	
054343	71101120-0	Tub Only, 19" Apron	RH	19" x 60" x 36"	White	

7111 Ensemble™ 42" Tile Oval Tub & Shower Module

- 3" Wainscot allows tile installation above bath deck
- Optional 3-piece wall set
- Realistic tile look
- Tongue and groove interlocking joints
- Shelving on back wall
- Complete unit rough-in dimensions including flanges: 73-1/4" x 60-1/4" x 43-1/2"
- Complete AFD unit rough-in dimensions including flanges: 75-1/2" x 60-1/4" x 43-1/2"
- AFD = Above Floor Drain



Part #	Mfg #	Description	Drain	Finished Dimensions	Color	Price
136157	71111122-0	Tub Only, 18-1/4" Apron, AFD	RH	19" x 60" x 42"	White	

Tub Showers

Vikrell - Sterling Tub Showers

7122 Ensemble™ 32" Curve Tub & Shower Module

- 2" Wainscot on tub allows tile installation above bath deck
- Optional 3-piece wall set
- Curve wall with smooth contemporary look
- Tongue and groove interlocking joints
- Shelving on back wall
- Complete unit rough-in dimensions including flanges: 75-1/4" x 60-1/4" x 33-1/4"
- Complete AFD unit rough-in dimensions including flanges: 77-1/4" x 60-1/4" x 33-1/4"
- AFD - Above floor drain



Part #	Mfg #	Description	Drain	Finished Dimensions	Color	Price
111759	71220110-0	Tub & Shower Complete	LH	74" x 60" x 32"	White	
111760	71220112-0	Tub & Shower Complete, AFD	LH	76" x 60" x 32"	White	

7132 and 7137 Ensemble™ Medley™ Tub & Shower Module

- Modular design allows it to be moved around corners and through doorways with ease
- Durable high gloss finish
- Innovative Dry-Block™ seal and channeled water containment system form watertight seams
- Clean, contemporary design with ample shelving
- 2" (51 mm) wainscot/tile ledge



Part #	Mfg #	Description	Drain	Finished Dimensions	Color	Price
225479	71320116-0	Tub & Shower Complete w/ Backer Boards	LH	75" x 60" x 32"	White	
223606	71320126-0	Tub & Shower Complete w/ Backer Boards	RH	75" x 60" x 32"	White	
226844	71370116-0	Tub & Shower Complete w/ Backer Boards	LH	73" x 60" x 30"	White	

7104 Performa™ 29" Tub & Shower Module

- Lightly pebbled bottom surface for sure footing
- Optional 3-piece wall set
- Caulk required in both vertical and horizontal wall seams to finish installation
- Convenient shelving and acrylic towel bar located on the back wall provide generous storage for toiletries, soap, and accessories
- Sloping backrest provides better lumbar support
- Tub liner included to protect the tub during installation
- Complete unit rough-in dimensions including flanges: 76-3/4" x 60-1/4" x 30"
- Complete AFD unit rough-in dimensions including flanges: 79" x 60-1/4" x 30-1/4"
- AFD = Above Floor Drain



Part #	Mfg #	Description	Drain	Finished Dimensions	Color	Price
007900	71040110-0	Tub & Shower Complete	LH	75-3/4" x 60" x 29"	White	
188893	71040126-0	Tub & Shower Complete w/ Backer Boards	RH	75-1/2" x 60" x 29"	White	
007869	71041110-0	Tub Only, 15" Apron	LH	15" x 60" x 29"	White	
111259	71041112-96	Tub Only, 17-1/4" Apron, AFD	LH	18" x 60" x 29"	Biscuit	
007872	71041120-0	Tub Only, 15" Apron	RH	15" x 60" x 29"	White	
148252	71041122-96	Tub Only, 17-1/4" Apron, AFD	RH	18" x 60" x 29"	Biscuit	

Tub Showers

Airbaths

Alcove Bubble Massage™ Baths
Archer® Alcove BubbleMassage™ Bath

- Acrylic
- (120) BubbleMassage™ airjets
- Integral apron (-A) with removable access panel
- Integral tile flange and lumbar support
- Blower motor with 300 W heater, and electronic user control
- Slotted overflow for maximum bathing depth
- (-W) Bask™ heated surface
- (-H) Built-in heater
- (-L) left-hand drain
- (-R) right-hand drain



Requires K-7172 or K-7171 slotted overflow

Part #	Mfg #	Description	Jets	Color	Price
106114	K-1122-GLA-0	60" x 32" x 19", LH Drain	120	White	
186650	K-1122-GLA-47	60" x 32" x 19", LH Drain	120	Almond	
111754	K-1122-GLA-96	60" x 32" x 19", LH Drain	120	Biscuit	
143995	K-1122-GLA-G9	60" x 32" x 19", LH Drain	120	Sandbar	
223668	K-1122-GLAW-7	60" x 32" x 20-1/4", LH Drain w/Bask™ & Apron	120	Black	
183453	K-1122-GLAW-96	60" x 32" x 20-1/4", LH Drain w/Bask™ & Apron	120	Biscuit	
113847	K-1122-GRA-0	60" x 32" x 19", RH Drain	120	White	
126777	K-1122-GRA-96	60" x 32" x 19", RH Drain	120	Biscuit	
148247	K-1122-GRA-G9	60" x 32" x 19", RH Drain	120	Sandbar	
183454	K-1122-GRAW-0	60"x32"x20-1/4", RH Drain w/Bask™ & Comfort Depth®	120	White	
125922	K-1124-GLA-0	72" x 36" x 20-1/4", LH Drain	120	White	
166827	K-1124-GLAW-0	72" x 36" x 20-1/4", LH Drain w/Bask™ & Apron	120	White	
131240	K-1124-GRA-0	72" x 36" x 20-1/4", RH Drain	120	White	
122450	K-1124-H-0	72" x 36" x 20-1/4", Reversible Drain, Heater	120	White	
179993	K-1947-GLA-0	60" x 30" x 19", LH Drain, ExoCrylic	120	White	
226731	K-1947-GLA-96	60" x 30" x 19", LH Drain, ExoCrylic	120	Biscuit	
166785	K-1947-GRA-0	60" x 30" x 19", RH Drain, ExoCrylic	120	White	
228108	K-1949-GRA-96	60" x 30" x 19", RH Drain, ExoCrylic	120	Biscuit	
181727	K-1947-GRAW-0	60" x 30" x 19", RH Drain w/Bask™ Heated Surface	120	White	
170220	K-1949-GLA-0	66" x 32" x 19", LH Drain, ExoCrylic	120	White	

Tubs

Airbaths

Bancroft® Alcove BubbleMassage™ Bath

- Acrylic
- (120) BubbleMassage™ airjets
- Integral apron (-A) with removable access panel
- Integral tile flange and lumbar support
- Variable-speed blower lets you adjust massage intensity to 18 levels
- Electronic keypad
- Textured bottom surface
- (-W) Bask™ heated surface
- (-L) left-hand drain
- (-R) right-hand drain



Tubs

Part #	Mfg #	Description	Jets	Color	Price
106612	K-1151-GLA-0	60" x 32" x 21-1/4", LH Drain	120	White	
111755	K-1151-GLA-96	60" x 32" x 21-1/4", LH Drain	120	Biscuit	
161691	K-1151-GLAW-0	60" x 32" x 21-1/4", LH Drain w/ Bask™	120	White	
094941	K-1151-GRA-0	60" x 32" x 21-1/4", RH Drain	120	White	
111179	K-1151-GRA-47	60" x 32" x 21-1/4", RH Drain	120	Almond	
099632	K-1151-GRA-96	60" x 32" x 21-1/4", RH Drain	120	Biscuit	
112328	K-1151-GRA-G9	60" x 32" x 21-1/4", RH Drain	120	Sandbar	

Devonshire® Alcove BubbleMassage™ Bath

- Acrylic
- (120) BubbleMassage™ airjets
- Integral apron
- Integral tile flange and lumbar support
- Variable-speed blower lets you adjust massage intensity to 18 levels
- Molded lumbar support and armrests offer extra comfort while bathing
- Textured bottom surface
- Drain sold separately
- (-W) Bask™ heated surface
- (-L) left-hand drain
- (-R) right-hand drain



Part #	Mfg #	Description	Jets	Color	Price
089315	K-1357-GLA-0	60" x 32" x 20", LH Drain	120	White	
125617	K-1357-GLA-47	60" x 32" x 20", LH Drain	120	Almond	
100399	K-1357-GLA-96	60" x 32" x 20", LH Drain	120	Biscuit	
148946	K-1357-GLA-G9	60" x 32" x 20", LH Drain	120	Sandbar	
171855	K-1357-GLAW-0	60" x 32" x 20", LH Drain w/ Bask™ Heated Surface	120	White	
084185	K-1357-GRA-0	60" x 32" x 20", RH Drain	120	White	
084808	K-1357-GRA-96	60" x 32" x 20", RH Drain	120	Biscuit	

Airbaths

Elevance® Rising Wall Alcove BubbleMassage™ ADA Bath

- Acrylic
- (59) BubbleMassage™ airjets
- Blower motor with 300 W heater and electrical user control, with a grounding-type plug-in cord
- Rising side wall is easy to lift, requiring less than five pounds of force
- (-W) Bask™ heated surface
- (-L) left-hand drain
- (-R) right-hand drain

- (GL/RB Models) Factory-installed grab bar and bath drain in polished chrome



Part #	Mfg #	Description	Jets	Color	Price
138129	K-1914-GLB-0	60" x 34" x 39-1/4", LH Drain	59	White	
158864	K-1914-GLBW-0	60" x 34" x 39-1/4", LH Drain w/ Bask™	59	White	
161689	K-1914-GLW-0	60" x 34" x 39-1/4", LH Drain w/ Bask™	59	White	
137992	K-1914-GRB-0	60" x 34" x 39-1/4", RH Drain	59	White	
164639	K-1914-GRW-0	60" x 34" x 39-1/4", RH Drain w/ Bask™	59	White	

Mariposa® Alcove BubbleMassage™ Bath

- Acrylic
- (120) BubbleMassage™ airjets
- Variable-speed blower lets you adjust massage intensity to 18 levels
- Electronic keypad
- Textured bottom surface
- Integral apron with removable access panel
- Integral tile flange
- Drain sold separately
- Immediate and manual purge cycles remove residual water from air channels after use
- (-W) Bask™ heated surface
- (-L) left-hand drain
- (-R) right-hand drain
- (-F) Flange only, does not include apron



Part #	Mfg #	Description	Jets	Color	Price
168426	K-1224-GLA-0	66" x 36" x 20", LH Drain	120	White	
231582	K-1224-GLAW-47	66" x 36" x 20", LH Drain, w/ Bask™ Heated Surface	120	Almond	
159122	K-1224-GRA-0	66" x 36" x 20", RH Drain	120	White	
173768	K-1224-GRA-47	66" x 36" x 20", RH Drain	120	Almond	
223873	K-1224-GRA-96	66" x 36" x 20", RH Drain	120	Biscuit	
168262	K-1239-GLA-0	60" x 36" x 20", LH Drain	120	White	
223446	K-1239-GLA-96	60" x 36" x 20", LH Drain	120	Biscuit	
163094	K-1239-GLA-G9	60" x 36" x 20", LH Drain	120	Sandbar	
228054	K-1239-GRA-0	60" x 36" x 20", RH Drain	120	White	
087341	K-1257-GLA-0	72" x 36" x 20", LH Drain	120	White	
111739	K-1257-GLA-96	72" x 36" x 20", LH Drain	120	Biscuit	
116126	K-1257-GLF-0	72" x 36" x 20", LH Drain	120	White	
090733	K-1257-GRA-0	72" x 36" x 20", RH Drain	120	White	
110522	K-1257-GRA-96	72" x 36" x 20", RH Drain	120	Biscuit	

Airbaths

Alcove Bubble Massage™ Baths (Continued)

Mariposa® Alcove BubbleMassage™ Bath

Part #	Mfg #	Description	Jets	Color	Price
118033	K-1257-GRA-G9	72" x 36" x 20", RH Drain	120	Sandbar	
188575	K-1257-GRW-0	72" x 36" x 22", RH Drain w/ Bask™ Heated Surface	120	White	

Winward® Alcove BubbleMassage™ Bath

- Acrylic
- (120) BubbleMassage™ airjets
- Blower motor is supplied with a grounding-type plug-in cord
- Integral apron with removable access panel
- Integral tile flange
- Molded lumbar supports and armrests
- Overflow drain sold separately
- (-F) internal flange less apron
- (-W) Bask™ heated surface
- (-L) left-hand drain
- (-R) right-hand drain



Tubs

Part #	Mfg #	Description	Jets	Color	Price
142810	K-1112-GLA-96	60" x 42" x 22-1/4", LH Drain	120	Biscuit	
166240	K-1112-GRA-0	60" x 42" x 22-1/4", RH Drain	120	White	
158133	K-1114-GLA-0	72" x 42" x 22-1/4", LH Drain	120	White	
158257	K-1114-GLA-96	72" x 42" x 22-1/4", LH Drain	120	Biscuit	
182991	K-1114-GLF-0	72" x 42" x 22-1/4", LH Drain Less Apron	120	White	
228117	K-1114-GLF-96	72" x 42" x 22-1/4", LH Drain Less Apron	120	Biscuit	
182854	K-1114-GRF-0	72" x 42" x 22-1/4", RH Drain Less Apron	120	White	

Drop-In BubbleMassage™ Baths

Archer™ BubbleMassage™ Bath

- (120) Factory installed color-matched ProFlex® BubbleMassage™ airjets
- Blower motor with 300W heater (-G only) and electronic user control
- Low threshold height
- Slotted overflow for maximum bathing depth
- Armrests and integral lumbar support
- Drop-in installation, 120V electrical service with grounding-type plug-in cord
- Textured bottom surface
- Drain sold separately
- (-W) Bask™ heated surface
- Reversible drain



Part #	Mfg #	Description	Jets	Color	Price
111525	K-1122-G-0	60" x 32" x 19"	120	White	
125534	K-1122-G-47	60" x 32" x 19"	120	Almond	
113956	K-1122-G-96	60" x 32" x 19"	120	Biscuit	
172494	K-1122-GW-96	60" x 32" x 19", Bask™ Heated Surface, ADA	120	Biscuit	

Airbaths

Drop-In BubbleMassage™ Baths (Continued)

Archer™ BubbleMassage™ Bath

Part #	Mfg #	Description	Jets	Color	Price
188404	K-1949-G-0	60" x 32" x 19" Reversible Drain	120	White	
110495	K-1124-G-0	72" x 36" x 19"	120	White	
129415	K-1124-G-47	72" x 36" x 19"	120	Almond	
113182	K-1124-G-96	72" x 36" x 19"	120	Biscuit	
177051	K-1124-GW-0	72" x 36" x 19", Bask™ Heated Surface	120	White	

Devonshire® BubbleMassage™ Bath

- Acrylic
- (120) Factory installed airjets
- Molded lumbar support and armrests offer extra comfort while bathing
- Variable-speed blower lets you adjust massage intensity to 18 levels
- Textured bottom surface
- Reversible end drain



Part #	Mfg #	Description	Jets	Color	Price
085755	K-1357-G-0	60" x 32" x 20"	120	White	
183006	K-1357-G-47	60" x 32" x 20"	120	Almond	
083748	K-1357-G-96	60" x 32" x 20"	120	Biscuit	
093628	K-1357-G-G9	60" x 32" x 20"	120	Sandbar	

Mariposa® Drop-In BubbleMassage™ Bath with Reversible Drain

- Acrylic
- (120) BubbleMassage™ airjets
- Variable-speed blower lets you adjust massage intensity to 18 levels
- Electronic keypad
- Textured bottom surface
- Immediate and manual purge cycles remove residual water from air channels after use
- (-W) Bask™ heated surface



Part #	Mfg #	Description	Jets	Color	Price
162955	K-1224-G-0	66" x 36" x 20"	120	White	
174480	K-1224-G-47	66" x 36" x 20"	120	Almond	
159362	K-1224-G-96	66" x 36" x 20"	120	Biscuit	
175701	K-1224-G-NY	66" x 36" x 20"	120	Dune	
229409	K-1224-GW-0	66" x 36" x 20", w/ Bask™ Heated Surface	120	White	
156463	K-1239-G-0	60" x 36" x 20"	120	White	
172840	K-1239-GW-0	60" x 36" x 20", w/ Bask™ Heated Surface	120	White	
086774	K-1257-G-0	72" x 36" x 20"	120	White	
100958	K-1257-G-47	72" x 36" x 20"	120	Almond	
084479	K-1257-G-96	72" x 36" x 20"	120	Biscuit	
100749	K-1257-G-G9	72" x 36" x 20"	120	Sandbar	
188980	K-1257-GW-0	72" x 36" x 20", w/ Bask™ Heated Surface	120	White	

Airbaths

Memoirs® Drop-In BubbleMassage™ Bath

- Acrylic
- (122) BubbleMassage™ airjets
- Variable-speed blower adjusts to 18 levels
- Lighted keypad
- Molded lumbar support
- Immediate and manual purge cycles remove residual water from air channels after use
- (-W) Bask™ heated surface



Part #	Mfg #	Description	Jets	Color	Price
080855	K-1418-G-0	72" x 42" x 22"	122	White	
126206	K-1418-G-47	72" x 42" x 22"	122	Almond	
076835	K-1418-G-96	72" x 42" x 22"	122	Biscuit	
086204	K-1418-G-G9	72" x 42" x 22"	122	Sandbar	
181201	K-1418-GW-96	72" x 42" x 22", w/ Bask™ Heated Surface	122	Biscuit	

Portrait® BubbleMassage™ Drop-In Air Bath with Center Drain

- Acrylic
- Built-in 300 W heater
- Lighted keypad control
- Molded lumbar support and armrests
- (122) BubbleMassage® airjets, 18 levels of massage intensity
- Zones of Control feature allows you to target massage to back, midsection, or feet
- Automatic purge cycles remove residual water from air channels after use



Part #	Mfg #	Description	Jets	Color	Price
084968	K-1457-G-96	67" x 42" x 22"	122	Biscuit	

Purist® Drop-In BubbleMassage™ 6' Air Bath

- Acrylic
- Drop-in or under-mount
- (122) BubbleMassage™ airjets, 18 levels of massage intensity
- Built-in 300 W heater
- Lighted keypad control
- Overflow channel for deep soak
- Zones of Control feature allows you to target massage to back, midsection, or feet
- K-7273 End drain required
- K-589 Under-mount installation kit required



Part #	Mfg #	Description	Jets	Color	Price
094266	K-1110-G-0	72" x 46" x 25-11/16"	White		

Airbaths

Reve® Dual-Mount BubbleMassage™ Bath with Center Drain

- Cast iron
- (44) BubbleMassage™ airjets, 18 levels of massage intensity
- Zones of control feature allows you to target massage to back, midsection, or feet
- Automatic purge cycles remove residual water from air channels after use
- Built-in 300W heater
- Lighted keypad control



Requires: K-7271 or K-7272 Slotted Overflow Drain

Part #	Mfg #	Description	Jets	Color	Price
183154	K-820-G0-0	67" x 32" x 19", Center Drain	44	White	

Serif® Drop-In BubbleMassage™ Air Bath with End Drain

- Acrylic
- 120 BubbleMassage™ airjets, 18 levels of massage intensity
- Integral lumbar support
- Textured bottom surface
- Built-in 300 W heater
- Lighted electronic keypad control
- Automatic purge cycles remove residual water from air channels after use
- Zones of Control feature allows you to target massage to back, midsection, or feet



Part #	Mfg #	Description	Jets	Color	Price
085802	K-1337-G-0	60" x 42" x 21", End Drain	120	White	
085895	K-1337-G-96	60" x 42" x 21", End Drain	120	Biscuit	

Sunward® BubbleMassage™ Bath

- (120) BubbleMassage™ airjets
- Blower motor with 300 W heater and electronic user control
- Molded lumbar support and armrests
- Textured bottom surface
- End drain
- (-W) Bask™ heated surface
- (-S1) ExoCrylic™ material



Part #	Mfg #	Description	Jets	Color	Price
113992	K-1162-G-0	60" x 42" x 20" Acrylic	120	White	
115499	K-1162-G-47	60" x 42" x 20" Acrylic	120	Almond	
119068	K-1162-G-96	60" x 42" x 20" Acrylic	120	Biscuit	
183457	K-1162-S1G-0	60" x 42" x 20" ExoCrylic™	120	White	
168153	K-1162-S1G-96	60" x 42" x 20" Exocrylic™	120	Biscuit	
169184	K-1162-S1GW-0	60" x 42" x 20" Exocrylic™ w/ Bask™ Heated Surface	120	White	
117142	K-1164-G-0	72" x 42" x 20" Acrylic	120	White	
114883	K-1164-G-96	72" x 42" x 20" Acrylic	120	Biscuit	
118857	K-1164-G-G9	72" x 42" x 20" Acrylic	120	Sandbar	
174496	K-1164-S1GW-0	72" x 42" x 20" Exocrylic™ w/Bask™ Heated Surface	120	White	

Airbaths

Drop-In BubbleMassage™ Baths (Continued)

Sunward® BubbleMassage™ Bath

Part #	Mfg #	Description	Jets	Color	Price
168294	K-1164-S1G-0	72" x 42" x 20" Exocrylic™	120	White	
168602	K-1164-S1G-96	72" x 42" x 20" Exocrylic™	120	Biscuit	

Tea-for-Two® Dual-Mount BubbleMassage™ Bath with White Airjet Color

- Cast iron with Safeguard® finish
- Blower motor with 300 W heater and electronic back-lit user control
- 18 Levels of airflow adjustability with zones of control
- Automatic purge cycles remove residual water from air channels after use
- (44) BubbleMassage™ airjets
- Drain sold separately



Tubs

Part #	Mfg #	Description	Jets	Color	Price
183155	K-852-G0-0	60" x 32" x 18-1/4", End Drain	44	White	
183156	K-856-G0-0	66" x 36" x 24", End Drain	44	White	

Tercet® BubbleMassage™ Corner Bath

- 120 BubbleMassage™ airjets
- Blower motor is supplied with a grounding-type plug-in cord
- Molded lumbar supports and has armrests
- Blower motor with 300 W heater and electronic user control
- Drop-in rim style or tile flange, right-hand blower
- Drain sold separately
- (-F) 3T tile flange
- (-A) Apron
- (-L) Left hand drain



Part #	Mfg #	Description	Jets	Color	Price
117557	K-1160-G-0	60" x 60" 21"	120	White	
151937	K-1160-G-96	60" x 60" 21"	120	Biscuit	
107707	K-1160-GF-0	60" x 60" 21" 3T Tile Flange	120	White	
145916	K-1160-GF-96	60" x 60" 21" 3T Tile Flange	120	Biscuit	
120391	K-1160-GLA-0	60" x 60" 21" 3T Tile Flange & Apron	120	White	

Windward® BubbleMassage™ Bath

- (120) BubbleMassage™ airjets
- Blower motor is supplied with a grounding-type plug-in cord
- Molded lumbar supports and has armrests
- Blower motor with 300 W heater and electronic user control



Part #	Mfg #	Description	Jets	Color	Price
111427	K-1114-G-0	72" x 42" x 21"	120	White	

Airbaths

Drop-In BubbleMassage™ Baths (Continued)

Windward® BubbleMassage™ Bath

Part #	Mfg #	Description	Jets	Color	Price
152434	K-1114-G-96	72" x 42" x 21"	120	Biscuit	

Underscore® BubbleMassage™ Air Bath

- Acrylic
- (122) BubbleMassage™ airjets
- Zones of Control™ feature
- Lighted keypad
- Drop-in or under-mount installation
- Slotted overflow allows for deep soaking
- Blower motor with 300 W heater and electronic back-lit user control
- Immediate and manual purge cycles remove residual water from air channels after use
- (-W) Bask™ heated surface
- (-C) Chromatherapy
- (-V) VibrAcoustic®



Requires Overflow Drain: K-7271 or K-7272

Part #	Mfg #	Description	Jets	Color	Price
232137	K-1167-G-0	60" x 30" x 19"	122	White	
134575	K-1173-GCR-0	66" x 36" x 22", w/ Chromatherapy	122	White	
168301	K-1173-GVBCW-47	66" x 36" x 22", w/ Chromatherapy, Bask™, VibrAcoustic Almond		122	
167837	K-1173-GVBCW-96	66" x 36" x 22", w/ Chromatherapy, Bask™, VibrAcoustic		122	Biscuit
185582	K-1173-GW-0	66" x 36" x 22", w/ Bask™ Heated Surface	122	White	
130918	K-1174-G-0	72" x 42" x 23"	122	White	
121689	K-1174-G-47	72" x 42" x 23"	122	Almond	
133053	K-1174-G-96	72" x 42" x 23"	122	Biscuit	
156731	K-1174-GCR-0	72" x 42" x 23", w/ Chromatherapy	122	White	
163868	K-1174-GW-0	72" x 42" x 23", with Bask™ Heated Surface	122	Biscuit	
174441	K-1174-GVBCW-0	72" x 42" x 23",w/ Chromatherapy, Bask, VibrAcoustic	122	White	
170341	K-1174-VBW-0	72" x 42" x 23". w/ Bask™, VibrAcoustic	122	White	
179346	K-1822-G-0	66" x 32" x 22"	122	White	
183477	K-1835-G-96	72" x 36" 23", Center drain	122	Biscuit	
164468	K-1835-GCR-0	72" x 36" x 23", w/ Chromatherapy	122	White	
183478	K-1835-GCR-G9	72" x 36" x 23", w/ Chromatherapy	122	Sandbar	
163869	K-1835-GW-0	72" x 36" x 23", w/ Bask™	122	White	
155001	K-1849-G-0	60" x 36" x 21"	122	White	
174958	K-1849-G-96	60" x 36" x 21"	122	White	

Tubs

Airbaths

Freestanding Bubble Massage Baths Archer® Freestanding BubbleMassage™ Bath

- ExoCrylic™
- (118-122) BubbleMassage™ airjets
- End drain



Part #	Mfg #	Description	Jets	Color	Price
185938	K-2595-G2M-0	68" x 32" x 22" End Drain, ExoCrylic™ with Music	118-122	White	

Escale® Freestanding BubbleMassage™ Bath

- Acrylic
- (120) BubbleMassage™ airjets
- Center drain (sold separately)



Part #	Mfg #	Description	Jets	Color	Price
166481	K-14037-G-0	72" x 36" x 24-1/8"	120	White	
176665	K-14037-G-47	72" x 36" x 24-1/8"	120	Almond	

Sunstruck® Freestanding BubbleMassage™ Air Bath with Bask® Heated Surface & Fluted Shroud

- Acrylic
- 118 to 122 BubbleMassage™ airjets, 18 levels of massage intensity
- Center drain
- Three heat settings
- 16-inch depth
- Integral lumbar support
- Textured bottom surface
- Wide ledge on one side is ideal for deck-mount faucet and/or handshower
- PureFlo™ drains are not recommended for a deck-mount faucet installation



Part #	Mfg #	Description	Jets	Color	Price
229849	K-1967-GW-96	66" x 36" x 25"	118-122	Almond	

Airbaths

Tubs

Sunstruck™ BubbleMassage™ Freestanding Air Bath

- Acrylic
- Straight shroud
- Bask® heated surface
- 16" soaking depth
- (118-122) ProFlex® hydro-massage airjets, 18 levels of massage intensity
- Three heat settings
- Integral lumbar support
- Wide ledge along one side
- Textured bottom surface
- Center drain



Part #	Mfg #	Description	Jets	Color	Price
231711	K-1966-GW-0	66" x 36" x 25", Straight Shroud	White		

Underscore® Freestanding Bubble Massage™ Bath

- ExoCrylic™
- (122) BubbleMassage™ airjets
- Variable-speed blower adjusts massage intensity to 18 levels
- Lighted keypad
- Dual lumbar supports
- Wide ledge on one side is ideal for deck-mount faucet
- Slotted overflow
- Automatic purge cycles
- Center drain
- Bask™ heated surface



Requires K-7271 or K-7272 Clearflo slotted overflow bath drain (sold separately)

Part #	Mfg #	Description	Jets	Color	Price
222253	K-5702-GW-96	60" x 36" x 24-3/8" Center Drain, Bask Heated Surface	122	Biscuit	

BubbleMassage™ Accessories

ProFlex® BubbleMassage™ Remote Installation Kit

- For installation of blower motors away from the bath
- For use with ProFlex® BubbleMassage™ baths



Part #	Mfg #	Description	Jets	Color	Price
088874	K-1446-NA	Blower Motor Remote Installation Kit	-	-	

Soaking Tubs

Alcove Bathtubs - Cast Iron

Bellwether® Alcove Bathtub

- Cast iron
- Safeguard® slip-resistant surface on bath floor
- Integral apron and (3) sided tile flange
- Drain sold separately
- Wide ledges for extra storage space
- Available in (3) sizes 60"x30", 60"x32", & 66"x32"



Tubs

Part #	Mfg #	Description	Color	Price
152203	K-837-0	60" x 30" x 14", Left Hand Drain	White	
160755	K-837-96	60" x 30" x 14", Left Hand Drain	Biscuit	
183656	K-837-NY	60" x 30" x 14", Left Hand drain	Dune	
155888	K-837-G9	60" x 30" x 14", Left Hand Drain	Sandbar	
149346	K-838-0	60" x 30" x 14", Right Hand Drain	White	
163712	K-838-96	60" x 30" x 14", Right Hand Drain	Biscuit	
163394	K-847-0	66" x 32" x 17", Left Hand Drain	White	
183657	K-847-47	66" x 32" x 17", Left Hand Drain	Almond	
165973	K-848-0	66" x 32" x 17", Right Hand Drain	White	
124196	K-875-0	60" x 32" x 15-1/2", Left Hand Drain	White	
140856	K-875-47	60" x 32" x 15-1/2", Left Hand Drain	Almond	
132780	K-875-96	60" x 32" x 15-1/2", Left Hand Drain	Biscuit	
168233	K-875-G9	60" x 32" x 15-1/2", Left Hand Drain	Sandbar	
137198	K-876-0	60" x 32" x 15-1/2", Right Hand Drain	White	
183157	K-876-47	60" x 32" x 15-1/2", Right Hand Drain	Almond	
136420	K-876-96	60" x 32" x 15-1/2", Right Hand Drain	Biscuit	
157587	K-876-G9	60" x 32" x 15-1/2", Right Hand Drain	Sandbar	

Dynametric® Alcove Bathtub with Left-Hand Drain

- Integral apron for quick installation
- Integral lumbar support
- Integral flange
- Safeguard® slip-resistant finish
- Bath with raised bottom allows use of horizontal drain from outlet to wall



Part #	Mfg #	Description	Color	Price
062224	K-519-0	60" x 32" x 16-1/4", Left Hand Drain	White	

Mendota® Alcove Bathtub

- Cast iron
- Safeguard® slip-resistant surface on bath floor
- Integral apron and (3) sided tile flange
- Drain sold separately



Part #	Mfg #	Description	Color	Price
060616	K-505-0	60" x 32" x 16-1/4", Left Hand Drain	White	

Soaking Tubs

Alcove Bathtubs - Cast Iron (Continued)

Mendota® Alcove Bathtub

Part #	Mfg #	Description	Color	Price
182460	K-505-47	60" x 32" x 16-1/4", Left Hand Drain	Almond	
074805	K-505-96	60" x 32" x 16-1/4", Left Hand Drain	Biscuit	
056882	K-506-0	60" x 32" x 16-1/4", Right Hand Drain	White	
115394	K-506-47	60" x 32" x 16-1/4", Right Hand Drain	Almond	
089619	K-506-96	60" x 32" x 16-1/4", Right Hand Drain	Biscuit	

Memoirs® Alcove Bathtub

- Cast iron
- Safeguard® slip-resistant surface on bath floor
- Integral apron and (3) sided tile flange
- Drain sold separately



Part #	Mfg #	Description	Color	Price
076962	K-721-0	60" x 34" x 17-7/16", Left Hand Drain	White	
073515	K-721-47	60" x 34" x 17-7/16", Left Hand Drain	Almond	
059156	K-721-96	60" x 34" x 17-7/16", Left Hand Drain	Biscuit	
058776	K-722-0	60" x 34" x 17-7/16", Right Hand Drain	White	
095196	K-722-47	60" x 34" x 17-7/16", Right Hand Drain	Almond	
058235	K-722-96	60" x 34" x 17-7/16", Right Hand Drain	Biscuit	

Seaforth™ Alcove Bathtub

- Cast iron
- Safeguard® slip-resistant surface on bath floor
- Integral apron and (3) sided tile flange
- Drain sold separately



Part #	Mfg #	Description	Color	Price
096807	K-745-0	54" x 30-1/4" x 14", Left Hand Drain	White	
091520	K-745-47	54" x 30-1/4" x 14", Left Hand Drain	Almond	
088817	K-745-96	54" x 30-1/4" x 14", Left Hand Drain	Biscuit	
076446	K-746-0	54" x 30-1/4" x 14", Right Hand Drain	White	
084041	K-746-96	54" x 30-1/4" x 14", Right Hand Drain	Biscuit	

Soaking Tubs

Villager™ Alcove Bathtub with 4" Ledge

- Cast iron
- Safeguard® slip-resistant surface on bath floor
- Integral apron and (3) sided tile flange
- Drain sold separately
- Left (K-713) or right (K-714) hand drains
- 4" Ledge provides extra room for bath supplies



Tubs

Part #	Mfg #	Description	Color	Price
061593	K-713-0	60" x 34-1/4" x 14", Left Hand Drain	White	
118496	K-713-47	60" x 34-1/4" x 14", Left Hand Drain	Almond	
060896	K-713-96	60" x 34-1/4" x 14", Left Hand Drain	Biscuit	
059569	K-714-0	60" x 34-1/4" x 14", Right Hand Drain	White	
067087	K-714-47	60" x 34-1/4" x 14", Right Hand Drain	Almond	
053941	K-714-96	60" x 34-1/4" x 14", Right Hand Drain	Biscuit	

Villager™ Alcove Bathtub

- Cast iron
- Safeguard® slip-resistant surface on bath floor
- Integral apron and (3) sided tile flange
- Drain sold separately
- Left (K-715) or right (K-716) hand drains



Part #	Mfg #	Description	Color	Price
053196	K-715-0	60" x 30-1/4" x 14", Left Hand Drain	White	
053198	K-715-47	60" x 30-1/4" x 14", Left Hand Drain	Almond	
053199	K-715-96	60" x 30-1/4" x 14", Left Hand Drain	Biscuit	
053197	K-716-0	60" x 30-1/4" x 14", Right Hand Drain	White	
053200	K-716-47	60" x 30-1/4" x 14", Right Hand Drain	Almond	
053206	K-716-96	60" x 30-1/4" x 14", Right Hand Drain	Biscuit	

Drop-In Bathtubs - Cast Iron

Maestro™ Drop-In Bathtub

- Cast iron
- Safeguard® slip-resistant surface on floor
- Drilled for grab bar (required); sold separately



Requires: K-9621 Grab Bars

Part #	Mfg #	Description	Color	Price
158207	K-839-0	66" x 32" x 18-1/4", End Drain	White	

Soaking Tubs

Reve® Drop-In Bathtub

- Cast iron
- Safeguard® slip-resistant surface on bath floor
- Sloped lumbar support on both ends
- Center toe tap drain (sold separately)



Part #	Mfg #	Description	Color	Price
181965	K-817-0	67" x 32" x 19-1/16", Center Drain	White	
164884	K-892-0	67" x 36" x 19-1/16", Center Drain	White	

Soissons® Drop-In Bathtub

- Cast iron
- Safeguard® slip-resistant surface on floor
- Reversible drain



Part #	Mfg #	Description	Color	Price
180434	K-941-0	59"x27-1/2"x16-3/4", Reversible End Drain	White	

Claw Feet for Soissons® Cast Iron Baths

- Set of four feet
- Designed for above-the-floor bath installation
- Can be adjusted from 3-13/16" to 6-3/16"
- For use with Soissons® cast-iron baths
- Installation hardware included



Part #	Mfg #	Description	Color	Price
183492	K-18416-NA	Claw Feet, for Soissons Bath		

Tea-for-Two® Drop-in Bathtub

- Cast iron with Safeguard® finish
- Reversible end drain
- Integral lumbar support
- Drop-in, three-wall alcove or undermount installation



Part #	Mfg #	Description	Color	Price
063951	K-850-0	60" x 32" x 18-1/4", Reversible End Drain	White	

Tubs

Soaking Tubs

Alcove Bathtubs - Acrylic Winward® Three-Wall Alcove Bathtub

- Acrylic
- Integral apron and (3) sided tile flange
- Drain sold separately
- Molded lumbar support



Tubs

Part #	Mfg #	Description	Color	Price
182989	K-1113-LA-0	60" x 42" x 22-1/4", Left Hand Drain	White	
182990	K-1113-RA-0	60" x 42" x 22-1/4", Right Hand Drain	White	
154195	K-1113-RA-47	60" x 42" x 22-1/4", Right Hand Drain	Almond	
121847	K-1115-LA-0	72" x 42" x 22-1/4", Left Hand Drain	White	
108657	K-1115-RA-0	72" x 42" x 22-1/4", Right Hand Drain	White	
156934	K-1115-RA-96	72" x 42" x 22-1/4", Right Hand Drain	Biscuit	

Archer® Alcove Bathtub

- Acrylic
- (-A) Integral apron and (3) sided tile flange
- Slotted overflow
- Textured bottom surface
- Requires drain K-7271 or K-7272 (sold separately)
- (-LA) left hand drain or (-RA) right hand drain



Part #	Mfg #	Description	Color	Price
110348	K-1123-LA-0	60" x 32" x 19", Left Hand Drain	White	
133130	K-1123-LA-47	60" x 32" x 19", Left Hand Drain	Almond	
189638	K-1123-LA-58	60" x 32" x 19", Left Hand Drain	Thunder Grey	
146691	K-1123-LA-7	60" x 32" x 19", Left Hand Drain	Black	
161847	K-1123-LA-95	60" x 32" x 19", Left Hand Drain	Ice Grey	
111316	K-1123-LA-96	60" x 32" x 19", Left Hand Drain	Biscuit	
123481	K-1123-LA-G9	60" x 32" x 19", Left Hand Drain	Sandbar	
162695	K-1123-LA-K4	60" x 32" x 19", Left Hand Drain	Cashmere	
174336	K-1123-LA-NY	60" x 32" x 19", Left Hand Drain	Dune	
106070	K-1123-RA-0	60" x 32" x 19", Right Hand Drain	White	
148794	K-1123-RA-47	60" x 32" x 19", Right Hand Drain	Almond	
179677	K-1123-RA-95	60" x 32" x 19", Left Hand Drain	Ice Grey	
118998	K-1123-RA-96	60" x 32" x 19", Right Hand Drain	Biscuit	
223216	K-1123-RA-G9	60" x 32" x 19", Right Hand Drain	Sandbar	
157630	K-1123-RA-K4	60" x 32" x 19", Right Hand Drain	Cashmere	
125004	K-1125-LA-0	72" x 36" x 19", Left Hand Drain	White	
154656	K-1125-LA-7	72" x 36" x 19", Left Hand Drain	Black	
122225	K-1125-LA-96	72" x 36" x 19", Left Hand Drain	Biscuit	
116361	K-1125-RA-0	72" x 36" x 19", Right Hand Drain	White	
131703	K-1125-RA-47	72" x 36" x 19", Right Hand Drain	Almond	
135418	K-1125-RA-96	72" x 36" x 19", Right Hand Drain	Biscuit	
186494	K-1946-L-0	60" x 30" x 21", Left Hand Drain	White	

Soaking Tubs

Alcove Bathtubs - Acrylic (Continued)

Archer® Alcove Bathtub

Part #	Mfg #	Description	Color	Price
229760	K-1946-L-NY	60" x 30" x 21", Left Hand Drain	Dune	
158766	K-1946-LA-0	60" x 30" x 19", Left Hand Drain	White	
175572	K-1946-LA-96	60" x 30" x 19", Left Hand Drain	Biscuit	
225554	K-1946-LA-NY	60" x 30" x 19", Left Hand Drain	Dune	
159069	K-1946-RA-0	60" x 30" x 19", Right Hand Drain	White	
175918	K-1946-RA-96	60" x 30" x 19", Right Hand Drain	Biscuit	
227204	K-1946-RA-K4	60" x 30" x 19", Right Hand Drain	Cashmere	
171150	K-1948-LA-0	66" x 32" x 19", Left Hand Drain	White	
173956	K-1948-RA-0	66" x 32" x 19", Right Hand Drain	White	
168178	K-1948-RA-96	66" x 32" x 19", Right Hand Drain	Biscuit	

Archer® Alcove Bath Less Apron

- ExoCrylic
- Textured bottom surface
- Molded lumbar support
- Slotted overflow drain (sold separately)
- 3 Sided tiling flange



Part #	Mfg #	Description	Color	Price
175936	K-1946-L-58	60" x 30" x 20-1/4", Left Hand Drain, 3T	Thunder Grey	
170259	K-1946-L-96	60" x 30" x 20-1/4", Left Hand Drain, 3T	Biscuit	
175117	K-1946-R-0	60" x 30" x 20-1/4", Right Hand Drain, 3T	White	

Elevance® Rising Wall Alcove Bath

- Acrylic
- Integral flange
- Chair-height bathing seat makes bath easy to enter and exit
- 14" Soaking depth at seat area
- Rising side wall is easy to lift, requiring less than 5 lbs of force
- Inflatable seal
- Bath fills within 4 minutes when using 3/4" supply valve piping
- Dual-drain system allows bath to empty in less than two minutes
- Integrated ledge
- Includes grab bar and drain: Polished chrome
- Integral lumbar support



Part #	Mfg #	Description	Color	Price
166126	K-1913-LB-0	60" x 32" x 38", Left Hand Drain	White	

Soaking Tubs

Mariposa® Alcove Bathtub

- Acrylic
- (-A) Integral apron and (3) sided tile flange
- Drain sold separately
- (-LA) left hand drain or (-RA) right hand drain
- (-W) Bask™ heated surface



Tubs

Part #	Mfg #	Description	Color	Price
103292	K-1229-LA-0	66" x 36" x 20", Left Hand Drain	White	
183387	K-1229-LA-47	66" x 36" x 20", Left Hand Drain	Almond	
153247	K-1229-LA-96	66" x 36" x 20", Left Hand Drain	Biscuit	
231675	K-1229-LAW-0	66" x 36" x 20", Left Hand Drain, Bask™	White	
117897	K-1229-RA-0	66" x 36" x 20", Right Hand Drain	White	
109559	K-1229-RA-47	66" x 36" x 20", Right Hand Drain	Almond	
154616	K-1229-RA-G9	66" x 36" x 20", Right Hand Drain	Sandbar	
081171	K-1242-L-0	60" x 36" x 21-1/4", Left Hand Drain Less Apron	White	
097406	K-1242-L-47	60" x 36" x 21-1/4", Left Hand Drain Less Apron	Almond	
103097	K-1242-L-96	60" x 36" x 21-1/4", Left Hand Drain Less Apron	Biscuit	
080708	K-1242-LA-0	60" x 36" x 21-1/4", Left Hand Drain	White	
086056	K-1242-LA-96	60" x 36" x 21-1/4", Left Hand Drain	Biscuit	
148445	K-1242-LA-G9	60" x 36" x 21-1/4", Left Hand Drain	Sandbar	
110052	K-1242-R-0	60" x 36" x 21-1/4", Right Hand Drain Less Apron	White	
066519	K-1242-RA-0	60" x 36" x 21-1/4", Right Hand Drain	White	
117302	K-1242-RA-47	60" x 36" x 21-1/4", Right Hand Drain	Almond	
105782	K-1242-RA-96	60" x 36" x 21-1/4", Right Hand Drain	Biscuit	
144099	K-1242-RA-G9	60" x 36" x 21-1/4", Right Hand Drain	Sandbar	
087401	K-1259-0	72" x 36" x 20", End Drain Less Apron	White	
124469	K-1259-L-0	72" x 36" x 20", Left Hand Drain Less Apron	White	
148998	K-1259-L-96	72" x 36" x 20", Left Hand Drain Less Apron	Biscuit	
057729	K-1259-LA-0	72" x 36" x 20", Left Hand Drain	White	
113159	K-1259-LA-96	72" x 36" x 20", Left Hand Drain	Biscuit	
097409	K-1259-R-0	72" x 36" x 20", Right Hand Drain Less Apron	White	
102360	K-1259-R-96	72" x 36" x 20", Right Hand Drain Less Apron	Biscuit	
099537	K-1259-R-G9	72" x 36" x 20", Right Hand Drain Less Apron	Sandbar	
077814	K-1259-RA-0	72" x 36" x 20", Right Hand Drain	White	
167828	K-1259-RA-96	72" x 36" x 20", Right Hand Drain	Biscuit	
118034	K-1259-RA-G9	72" x 36" x 20", Right Hand Drain	Sandbar	
228767	K-1259-RA-NY	72" x 36" x 20", Right Hand Drain	Dune	
167516	K-1259-RAW-0	72" x 36" x 20", Right Hand Drain, Bask™ Heated Surface	White	

Soaking Tubs

Tubs

Bancroft™ Alcove Bathtub

- Acrylic
- Molded lumbar support
- Integral apron and (3) sided tile flange
- Drain sold separately



Part #	Mfg #	Description	Color	Price
090952	K-1150-LA-0	60" x 32" x 20", Left Hand Drain	White	
108950	K-1150-LA-47	60" x 32" x 20", Left Hand Drain	Almond	
103074	K-1150-LA-96	60" x 32" x 20", Left Hand Drain	Biscuit	
101064	K-1150-LA-G9	60" x 32" x 20", Left Hand Drain	Sandbar	
183455	K-1150-LAW-0	60" x 32" x 22", Left Hand Drain with Bask™ Heated Surface	White	
089591	K-1150-RA-0	60" x 32" x 20", Right Hand Drain	White	
114589	K-1150-RA-47	60" x 32" x 20", Right Hand Drain	Almond	
101727	K-1150-RA-96	60" x 32" x 20", Right Hand Drain	Biscuit	
160117	K-1150-RA-G9	60" x 32" x 20", Right Hand Drain	Sandbar	

Devonshire® Alcove Bathtub

- Acrylic
- Integral arm rests and lumbar support
- Textured bottom surface
- Integral apron and (3) sided tile flange
- (-LA) left hand drain or (-RA) right hand drain



Part #	Mfg #	Description	Color	Price
070405	K-1184-LA-0	60" x 32" x 21-1/4", Left Hand Drain	White	
077568	K-1184-LA-47	60" x 32" x 21-1/4", Left Hand Drain	Almond	
064514	K-1184-LA-96	60" x 32" x 21-1/4", Left Hand Drain	Biscuit	
122422	K-1184-LA-G9	60" x 32" x 21-1/4", Left Hand Drain	Sandbar	
172783	K-1184-LA-NY	60" x 32" x 21-1/4", Left Hand Drain	Dune	
076275	K-1184-RA-0	60" x 32" x 21-1/4", Right Hand Drain	White	
096283	K-1184-RA-47	60" x 32" x 21-1/4", Right Hand Drain	Almond	
086476	K-1184-RA-96	60" x 32" x 21-1/4", Right Hand Drain	Biscuit	
126836	K-1184-RA-G9	60" x 32" x 21-1/4", Right Hand Drain	Sandbar	

Expanse® Alcove Bathtub

- Acrylic
- Textured bottom surface
- Integral apron and (3) sided tile flange
- Curved basin and integral apron create spacious bathing experience



Part #	Mfg #	Description	Color	Price
149364	K-1100-LA-0	60" x 38" x 18-1/4", Left Hand Drain	White	
176343	K-1100-LA-96	60" x 38" x 18-1/4", Left Hand Drain	Biscuit	
140701	K-1100-RA-0	60" x 38" x 18-1/4", Right Hand Drain	White	

Soaking Tubs

Alcove Bathtubs - Acrylic (Continued) Expanse® Alcove Bathtub

Part #	Mfg #	Description	Color	Price
154429	K-1100-RA-96	60" x 38" x 18-1/4", Right Hand Drain	Biscuit	
155269	K-1118-LA-0	60" x 36" x 18-1/4", Left Hand Drain	White	
162020	K-1118-RA-0	60" x 36" x 18-1/4", Right Hand Drain	White	
165949	K-1118-RA-47	60" x 36" x 18-1/4", Right Hand Drain	Almond	

Portrait® Alcove Bathtub

- Acrylic
- Molded lumbar support and arm rests offer extra comfort
- Integral apron and (3) sided tile flange
- Drain sold separately



Part #	Mfg #	Description	Color	Price
072036	K-1108-LA-0	60" x 32" x 20", Left Hand Drain	White	
093724	K-1108-LA-96	60" x 32" x 20", Left Hand Drain	Biscuit	
076958	K-1108-RA-0	60" x 32" x 20", Right Hand Drain	White	
083772	K-1108-RA-47	60" x 32" x 20", Right Hand Drain	Almond	
095755	K-1108-RA-96	60" x 32" x 20", Right Hand Drain	Biscuit	

Hourglass® Alcove Bathtub

- Acrylic
- Textured bottom surface
- Integral apron and (3) sided tile flange
- Drain sold separately



Part #	Mfg #	Description	Color	Price
096990	K-1219-LA-0	60" x 32" x 20", Left Hand Drain	White	
142969	K-1219-LA-96	60" x 32" x 20", Left Hand Drain	Biscuit	
075974	K-1219-RA-0	60" x 32" x 20", Right Hand Drain	White	
181846	K-1219-RA-96	60" x 32" x 20", Right Hand Drain	Biscuit	

Tercet® Corner Tub

- Acrylic
- Molded lumbar support and arm rests offer extra comfort
- Integral apron and (3) sided tile flange
- Drain sold separately
- (-F) Less apron



Part #	Mfg #	Description	Color	Price
094741	K-1161-0	60" x 60" x 21", Center Drain	White	

Soaking Tubs

Alcove Bathtubs - Acrylic (Continued)

Tercet® Corner Tub

Part #	Mfg #	Description	Color	Price
110342	K-1161-96	60" x 60" x 21", Center Drain	Biscuit	
090039	K-1161-LA-0	60" x 60" x 21", Center Drain	White	
094684	K-1161-LA-47	60" x 60" x 21", Center Drain	Almond	
135897	K-1161-LA-96	60" x 60" x 21", Center Drain	Biscuit	
133895	K-1161-F-0	60" x 60" x 21", Center Drain Less Apron	White	

Underscore® Alcove Bathtub

- Acrylic
- Molded lumbar support
- (3) Sided tile flange
- (-W) Bask™ heated surface
- (-L) left hand drain or (-R) right hand drain



Requires slotted overflow drain K-7271 or K-7272

Part #	Mfg #	Description	Color	Price
153431	K-1121-L-0	60" x 30" x 19", Left Hand Drain	White	
155889	K-1121-R-0	60" x 30" x 19", Right Hand Drain	White	
188599	K-1121-R-96	60" x 30" x 19", Right Hand Drain	Biscuit	
152910	K-1121-RW-0	60" 30" x 19", Right Hand Drain with Bask™ Heated Surface	White	

Drop-In Bathtubs - Acrylic

5454 Drop-In Bathtub

- ExoCrylic
- Center drain
- Integral faucet deck
- Molded lumbar support and armrests
- (-F) Integral flange



Part #	Mfg #	Description	Color	Price
078248	K-1155-0	54" x 54" x 20", Center Drain	White	
142010	K-1155-F-0	54" x 54" x 20", Center Drain	White	

6036 Drop-In Bathtub

- Exocrylic
- Molded lumbar support and armrests
- Reversible end drain
- (-L) Three-sided tile flange



Part #	Mfg #	Description	Color	Price
080120	K-1142-0	60" x 36" x 18-1/8", End Drain	White	
091279	K-1142-L-0	60" x 36" x 18-1/8", (3) Sided Tile Flange LH Drain	White	

Soaking Tubs

6040 Drop-In Bathtub

- Exocrylic
- Molded lumbar support and armrests
- End drain



Part #	Mfg #	Description	Color	Price
078056	K-1147-0	60" x 40" x 17-5/8", End Drain	White	

7236 Drop-In Bathtub

- Exocrylic
- Molded lumbar support and armrests
- Reversible end drain



Part #	Mfg #	Description	Color	Price
088870	K-1159-0	72" x 36" x 20-1/8", End Drain	White	
097239	K-1159-47	72" x 36" x 20-1/8", End Drain	Almond	
063711	K-1159-96	72" x 36" x 20-1/8", End Drain	Biscuit	

7242 Drop-In Bathtub

- Exocrylic
- Molded lumbar support and armrests
- Reversible drain



Part #	Mfg #	Description	Color	Price
053842	K-1132-0	72" x 42" x 20-1/8"	White	
079262	K-1149-96	72" x 43" x 19-3/4"	Biscuit	

Archer™ Drop-In Bathtub with End Drain

- Acrylic
- Comfort Depth™ design
- Integral arm rests and lumbar support
- Slotted overflow for deeper bathing depth
- Drain sold separately
- (-W) Bask™ heated surface
- (K-194(6)(8))ExoCrylic™ material



K-1123

Requires K-7271 or K-7272 Clearflo slotted bath drain (sold separately)

Part #	Mfg #	Description	Color	Price
110360	K-1123-0	60" x 32" x 19", End Drain	White	
178521	K-1123-95	60" x 32" x 19", End Drain	Ice Grey	
112625	K-1123-96	60" x 32" x 19", End Drain	Biscuit	
182992	K-1123-G9	60" x 32" x 19", End Drain	Sandbar	

Soaking Tubs

Drop-In Bathtubs - Acrylic (Continued)

Archer™ Drop-In Bathtub with End Drain

Part #	Mfg #	Description	Color	Price
160775	K-1123-RAW-0	60" x 32" x 19", End Drain w/ Bask™ Heated Surface	White	
115189	K-1125-0	72" x 36" x 19", End Drain	White	
132165	K-1125-47	72" x 36" x 19", End Drain	Almond	
162483	K-1125-58	72" x 36" x 19", End Drain	Thunder Grey	
113185	K-1125-96	72" x 36" x 19", End Drain	Biscuit	
152278	K-1125-NY	72" x 36" x 19", End Drain	Dune	
179829	K-1946-0	60" x 30" x 19", End Drain, ExoCrylic	White	
228132	K-1946-W1-0	60" x 30" x 19", End Drain, ExoCrylic w/ Bask™ Heated Surface	White	
170676	K-1948-0	66" x 32" x 19", End Drain, ExoCrylic	White	

Bancroft® Drop-in 5' Bathtub with End Drain

- Acrylic
- Integral lumbar support



Part #	Mfg #	Description	Color	Price
089590	K-1156-0	65-7/8" x 41-1/4" x 22", End Drain	White	

Devonshire® Drop-In Bathtub

- Acrylic
- Integral lumbar support and armrests
- Textured bottom surface
- Reversible end drain



Part #	Mfg #	Description	Color	Price
067768	K-1184-0	60" x 32" x 20", End Drain	White	
081217	K-1184-47	60" x 32" x 20", End Drain	Almond	
091507	K-1184-96	60" x 32" x 20", End Drain	Biscuit	

Escale® Drop-In Bathtub

- Acrylic
- Sloped lumbar support
- Center drain



Part #	Mfg #	Description	Color	Price
182993	K-11343-47	72" x 36" x 24-1/8", Center Drain	Almond	

Soaking Tubs

Hourglass® Drop-In Bathtub

- Acrylic
- Textured bottom surface
- End drain



Part #	Mfg #	Description	Color	Price
062621	K-1219-0	60" x 32" x 20", End Drain	White	
182404	K-1219-96	60" x 32" x 20", End Drain	Biscuit	

Mariposa® Drop-In Bathtub

- Acrylic
- Textured bottom surface
- End drain
- (-W) Bask™ heated surface



Part #	Mfg #	Description	Color	Price
072415	K-1242-0	60" x 36" x 20", End Drain	White	
160106	K-1242-47	60" x 36" x 20", End Drain	Almond	
062568	K-1242-96	60" x 36" x 20", End Drain	Biscuit	
101387	K-1242-G9	60" x 36" x 20", End Drain	Sandbar	
083990	K-1229-0	66" x 36" x 20", End Drain	White	
104235	K-1229-47	66" x 36" x 20", End Drain	Almond	
097371	K-1229-96	66" x 36" x 20", End Drain	Biscuit	
177256	K-1229-W1-0	66" x 36" x 20", Bask™ Heated Surface, End Drain	White	

Portrait® Drop-In Bathtub

- Acrylic
- Molded lumbar support and armrests



K-1454-0
Center Drain



K-1013-0
End Drain

Part #	Mfg #	Description	Color	Price
079699	K-1013-0	60" x 32" x 20", End Drain	White	
063930	K-1454-0	67" x 42" x 22", Center Drain	White	

Serif® Drop-In Bathtub

- Acrylic
- End drain
- Integral lumbar support
- Textured bottom surface



Part #	Mfg #	Description	Color	Price
075872	K-1183-0	60" x 43" x 21", End Drain	White	

Soaking Tubs

Sunward® Drop-In Bathtub with End Drain

- Acrylic
- Molded lumbar support and armrests
- Textured bottom surface
- Under-mountable
- (-S1) ExoCrylic™ material
- (-W) Bask® heated surface



Part #	Mfg #	Description	Color	Price
187527	K-1162-S1-0	60" x 42" x 20" End Drain, ExoCrylic™	White	
095214	K-1163-0	60" x 42" x 20", End Drain	White	
104449	K-1163-96	60" x 42" x 20", End Drain	Biscuit	
095162	K-1163-G9	60" x 42" x 20", End Drain	Sandbar	
163156	K-1163-S1-0	60" x 42" x 20", End Drain ,ExoCrylic™	White	
230092	K-1163-S1W-0	60" x 42" x 20", End Drain ,ExoCrylic™, Bask®	White	
107959	K-1165-0	72" x 42" x 21", End Drain	White	
111335	K-1165-47	72" x 42" x 21", End Drain	Almond	
105938	K-1165-96	72" x 42" x 21", End Drain	Biscuit	
168098	K-1165-S1-0	72" x 42" x 21", End Drain ,ExoCrylic™	White	
170075	K-1165-S1-96	72" x 42" x 21", End Drain ,ExoCrylic™	Biscuit	

Underscore® Drop-In Bathtub

- Acrylic
- Under-mountable
- Molded lumbar support
- Slotted overflow allows for deep soaking
- End drain or center drain for (1834 & 1137) models
- (-W) Bask™ heated surface



Requires K-7271 or K-7272 Clearflo slotted bath drain (sold separately)

Part #	Mfg #	Description	Color	Price
148325	K-1121-0	60" x 30" x 19", End Drain	White	
154992	K-1121-47	60" x 30" x 19", End Drain	Almond	
152864	K-1130-0	60" x 32" x 21", End Drain	White	
156589	K-1130-47	60" x 32" x 21", End Drain	Almond	
140376	K-1130-96	60" x 32" x 21", End Drain	Biscuit	
128681	K-1136-0	66" x 36" x 22", End Drain	White	
148169	K-1136-47	66" x 36" x 22", End Drain	Almond	
123927	K-1136-96	66" x 36" x 22", End Drain	Biscuit	
133131	K-1136-G9	66" x 36" x 22", End Drain	Sandbar	
133691	K-1137-0	72" x 42" x 23", Center Drain	White	
121938	K-1137-96	72" x 42" x 23", Center Drain	Biscuit	
148326	K-1821-0	66" x 32" x 22", End Drain	White	
189704	K-1821-47	66" x 32" x 22", End Drain	Almond	
183473	K-1821-W1-0	66" x 32" x 22", End Drain w. Bask™	White	
169414	K-1834-0	72" x 36" x 23", Center Drain	White	

Soaking Tubs

Drop-In Bathtubs - Acrylic (Continued)

Underscore® Drop-In Bathtub

Part #	Mfg #	Description	Color	Price
183476	K-1834-96	72" x 36" x 23", Center Drain	Biscuit	
152670	K-1848-0	60" x 36" x 21", End Drain	White	
183493	K-1848-96	60" x 36" x 21", End Drain	Biscuit	
185911	K-1848-W1-96	60" x 36" x 21" End Drain with Bask™	Biscuit	

Windward® Drop-In Bathtub

- Acrylic
- Molded lumbar support and armrests
- End drain



Part #	Mfg #	Description	Color	Price
177419	K-1113-0	60" x 42" x 21", End Drain	White	
133800	K-1115-0	72" x 42" x 21", End Drain	White	
169648	K-1115-96	72" x 42" x 21", End Drain	Biscuit	

Freestanding Bathtubs

Aliento® Freestanding Bathtub

- Lithocast™
- Integral slotted overflow allows for deep soaking
- Center toe-tap drain with Lithocast™ cover



Part #	Mfg #	Description	Color	Price
153263	K-1805-HW1	66" x 36" x 25-3/16", Center Drain	Honed White	

Archer® Freestanding Bathtub

- ExoCrylic™
- Slotted overflow allows for deep soaking
- End drain



Part #	Mfg #	Description	Color	Price
183498	K-2594-0	68" x 32" x 22", End Drain	White	
223700	K-2594-96	68" x 32" x 22", End Drain	Biscuit	

Soaking Tubs

Tubs

Archer® Freestanding Bathtub

- *ExoCrylic™*
- *Two-piece design*
- *Molded lumbar support offers extra comfort*
- *Textured bottom surface*
- *End drain*
- *Slotted overflow allows for deep soaking (K-7271 or K7272 overflow drain required)*



Part #	Mfg #	Description	Color	Price
177430	K-2592-0	62" x 32" x 22", End Drain	White	

Askew® Freestanding Bathtub

- *Lithocast™*
- *Slotted overflow allows for deep soaking*
- *Center toe-tap drain with Lithocast™ cover*



Part #	Mfg #	Description	Color	Price
185809	K-1801-HW1	72" x 35" x 25", Center Toe-Tap Drain	Honed White	

Birthday Bath® Freestanding Bathtub with End Drain

- *Cast iron*
- *Brass claw feet in a choice of finishes (sold separately)*

Requires K-102 ball and claw legs



Part #	Mfg #	Description	Color	Price
087574	K-100-0	72" x 37-1/2" x 27", End Drain	White	

Antique® Ball and Claw Legs for K-100 Birthday Bath®

- *Solid brass construction*
- *Installation hardware included*
- *coordinates with Antique® faucets and accessories=*



Part #	Mfg #	Description	Color	Price
087576	K-102-BV	For K-100 Birthday Bath, *Brushed Bronze		
090629	K-102-CP	For K-100 Birthday Bath, Polished Chrome		

Soaking Tubs

Escale® Freestanding Bathtub with End Drain

- Acrylic
- Two-piece design
- Drain sold separately



Part #	Mfg #	Description	Color	Price
143003	K-14037-0	72" x 36" x 24-1/8", Center Drain	White	
151956	K-14037-96	72" x 36" x 24-1/8", Center Drain	Biscuit	

Escale® Freestanding Bathtub with Hole Drilling for Symbol® Roman Bath Filler

- Acrylic
- 6-foot length
- Sloped lumbar support
- Center drain
- Two-piece design
- Drain sold separately



Part #	Mfg #	Description	Color	Price
107029	K-11344-0	72" x 36" x 24-1/8", Center Drain	White	

Iron Works® Historic Freestanding Bathtub with Feet and Reversible End Drain

- Cast iron
- Molded lumbar support
- Safeguard® slip-resistant surface on floor
- (-A) Almond exterior
- (-W) White exterior
- Requires K-1103 ball-and-claw feet



Part #	Mfg #	Description	Color	Price
166380	K-710-A-47	66" x 36" x 24 1/2" with Feet, End Drain	Almond	
057709	K-710-W-0	66" x 36" x 24 1/2" with Feet, End Drain	White	

Iron Works® Historic Ball-and-Claw Feet

- Cast iron
- Required for use with the K-710 Iron Works Historic 5.5-foot bath



Part #	Mfg #	Color	Price
126850	K-1103-0	White	
057710	K-1103-P5	Iron Black	

Soaking Tubs

Tubs

Reve® 67" x 36" x 22" Freestanding Bathtub with Center Toe-Tap Drain

- Cast Iron
- Sloped lumbar support on both ends
- Safeguard® slip-resistant surface on floor
- Slotted overflow allows for deep soaking



Requires slotted overflow drain K-7271 or K-7272

Part #	Mfg #	Description	Color	Price
144897	K-894-F62-0	67" x 36" x 22", Center Drain	White with Brilliant Blanc Base	
157500	K-894-F63-0	67" x 36" x 22", Center Drain	White with Brilliant Ash Base	

Stargaze™ Freestanding Bathtub with Center Drain

- Acrylic
- Sloped lumbar support on both ends
- 17" Bathing depth
- Textured bottom surface



Part #	Mfg #	Description	Color	Price
165542	K-6366-0	72" x 36" x 25-3/4", Straight Shroud	White	
159758	K-6367-0	72" x 36" x 25-3/4", Fluted Shroud	White	
169000	K-6367-96	72" x 36" x 25-3/4", Fluted Shroud	Biscuit	

Sunstruck™ Freestanding Bathtub

- Acrylic
- Oval shaped basin with sloped lumbar support on both ends
- Wide deck along one side
- Textured bottom surface
- Center drain



Part #	Mfg #	Description	Color	Price
162063	K-6368-0	66" x 36" x 25-3/4", Straight Shroud	White	
161011	K-6369-0	66" x 36" x 25-3/4", Fluted Shroud	White	
163692	K-6369-96	66" x 36" x 25-3/4", Fluted Shroud	Biscuit	

Underscore® Freestanding Bathtub

- Kohler® ExoCrylic®
- Dual lumbar support accommodates two-person bathing
- Wide ledge on one side is ideal for deck-mount faucet
- Slotted overflow allows for deep soaking
- Center drain



Requires K-7271 or K-7272 slotted overflow bath drain (sold separately)

Part #	Mfg #	Description	Color	Price
177787	K-5701-0	60" x 35-3/4" x 24-3/8", Center Drain	White	
224297	K-5701-96	60" x 35-3/4" x 24-3/8", Center Drain	Biscuit	

Soaking Tubs

Vintage® Freestanding Bathtub with Center Drain

- Heritage design
- Integral lumbar support
- Cast iron with Safeguard® finish
- Drop-in or freestanding (with required base)
- Requires K-709 ceramic base or K-705 wooden base (sold separately)
- Installation with K-709 ceramic base requires caulking in vertical base seams



Part #	Mfg #	Description	Color	Price
067083	K-700-0	72" x 42" x 21-3/16", Center Drain	White	

Vintage® Adjustable Feet for use on Vintage®, Maestro®, and Tea-for-Two® 5' Baths

- Set of four feet
- Above-floor bath installation
- Installation hardware included
- Vintage® bath: K-700
- Maestro® baths: K-839, K840
- Maestro® whirlpool bath: K-845-H
- Tea-for-Two® bath: K-850



Part #	Mfg #	Description	Color	Price
061144	K-1172-NA	Set of 4 Feet	NA	

Vintage® Bath Base for Freestanding Vintage® Bath Only

- L 51-3/8", H 4-1/2", W 31-15/16"
- Durable ceramic construction
- For use with the K-700 Vintage® freestanding bath



Part #	Mfg #	Description	Color	Price
067084	K-709-0	51-3/8" x 31-15/16"	White	

VibrAcoustic® Bathtubs

Archer® VibrAcoustic® Drop-In Bathtub

- Acrylic
- Slotted overflow drain
- User-friendly high-resolution color touch screen
- (6) Transducers and control amplifier create a 3-D surround sound experience
- Reversible drain
- Textured bottom surface
- Molded lumbar support and armrests for comfort



Part #	Mfg #	Description	Color	Price
167679	K-1124-VB-0	72" x 36" x 19", End Drain	White	

Soaking Tubs

Tubs

Underscore® VibrAcoustic® Drop-In Bathtub

- Acrylic
- Slotted overflow drain
- User-friendly high-resolution color touch screen
- (6) Concealed speakers
- (4) Original instrumental compositions
- Functions as a hydrotherapy bath when full of water and a stereo system when empty
- Center drain
- Includes 25 feet of wiring and amplifier



Part #	Mfg #	Description	Color	Price
183479	K-1835-VB-0	72" x 36" x 23", VibrAcoustic®, Center Drain	White	

Underscore® VibrAcoustic® Dual-Mount Bathtub

- Acrylic
- Slotted overflow drain
- Intuitive high-clarity color touch-screen chrome user interface
- (6) Transducers and control amplifier create 3-D surround sound experience
- Under-mount/drop-in style installation
- Chromatherapy model (-VBC) is equipped with 4 lights
- (-W) Bask™ heated surface



Requires Overflow Drain: K-7271 or K-7272

Part #	Mfg #	Description	Color	Price
183288	K-1173-VB-0	66" x 36" x 22", VibrAcoustic®, End Drain	White	
155216	K-1173-VBC-0	66" x 36" x 22", w/ Chromatherapy, End Drain	White	
173163	K-1173-VBW-0	66" x 36" x 22", w/ Bask™ Heated Surface, End Drain	White	
183459	K-1174-VB-0	72" x 42" x 23" VibrAcoustic®, Center Drain	White	
183458	K-1174-VB-NY	72" x 42" x 23" VibrAcoustic®, Center Drain	Dune	
156127	K-1174-VBC-0	72" x 42" x 23". w/ Chromatherapy & Center Drain	White	
160418	K-1822-VB-0	66" x 32" x 22", VibrAcoustic®, End Drain	White	
173171	K-1849-VB-0	60" x 36" x 21", VibrAcoustic®, End Drain	White	

Tea-for-Two® Under-Mount Installation Kit

- Template and instructions included
- (K-582) For use with the K-865-H1 Tea-for-Two® whirlpool and K-863 Tea-for-Two® bath
- (K-586) For use with the K-852-H Tea-for-Two® whirlpool and K-850 Tea-for-Two® bath



Part #	Mfg #	Size of Bath & Whirlpool	Price
083639	K-582-NA	6'	
069037	K-586-NA	5'	

Soaking Tubs

Underscore® Under-Mount Installation Kit

- For use with K-1121 and K-1167 Underscore® baths, whirlpools, BubbleMassage™ air baths, and VibrAcoustic® baths



Part #	Mfg #	Description	Price
149426	K-531-NA	Under-Mount Installation Kit	

Tiling-In Bead

- Vinyl construction
- For use with drop-in baths
- Includes vinyl bead and corresponding pressure-sensitive sealing tape



Part #	Mfg #	Length	Price
057193	K-1177-NA	144"	

Fiberglass Tub

Drop-In Soaking Bathtubs

- Pre-leveled block base system
- 2-1/2" Diameter overflow
- Balsa wood core floor structure
- Textured floor pattern

Futura 4260 Oval Acrylic Soaking Bathtub

- Self-rimming
- 2" Drain



Part #	Mfg #	Description	Drain	Finish	Price
092501	OV-B-310/0ND-WHT	20-3/4" x 60" x 42"	Universal	White	

Geneva 3660 Acrylic Soaking Bathtub

- Self-rimming
- Vacuum formed acrylic
- 2" Drain
- Twin, contoured arm rests



Part #	Mfg #	Description	Drain	Finish	Price
092482	TR-B-240/0ND-WHT	21" x 60" x 32"	Universal	White	
092484	TR-B-240/0ND-BSC	21" x 60" x 32"	Universal	Biscuit	

Geneva 3672 Acrylic Soaking Bathtub

- Self-rimming
- Vacuum formed acrylic
- 2" Drain
- Twin, contoured arm rests



Part #	Mfg #	Description	Drain	Finish	Price
092495	TR-B-270/0ND-WHT	21" x 72" x 36-1/4"	Universal	White	
092497	TR-B-270/0ND-BSC	21" x 72" x 36-1/4"	Universal	Biscuit	

Alcove Soaking Bathtubs

- Pre-leveled block base system
- 2-1/2" Diameter overflow
- Balsa wood core floor structure
- Textured floor pattern

BA-R-41/BA-R-51 Fiberglass Bathtub - Integral Apron

- BA-R-41 Rough-in dimensions: 18-1/2" x 60" x 30-1/2"
- BA-R-51 Rough-in dimensions: 18-1/2" x 60" x 33-1/4"
- Gel coat surface
- 2" Drain



Part #	Mfg #	Description	Drain	Finish	Price
140665	BA-R-41L-WHT	17-1/4" x 60" x 29-1/4"	LH	White	



Fiberglass Tubs

Alcove Soaking Bathtubs (Continued) BA-R-41/BA-R-51 Fiberglass Bathtub - Integral Apron

Part #	Mfg #	Description	Drain	Finish	Price
145093	BA-R-41R-WHT	17-1/4" x 60" x 29-1/4"	RH	White	
149064	BA-R-51L-WHT	17-1/4" x 60" x 32"	LH	White	
108397	BA-R-51R-WHT	17-1/4" x 60" x 32"	RH	White	

Tubs

Fiberglass Tubs

Bathtubs

260030 Builders' Choice Everyday Bathtub

- Integral armrests
- Integral tiling flange (3T) and skirt
- Slip resistant textured bottom



Part #	Mfg #	Finished Dimensions	Drain	Finish	Price
029530	260030-L-WH	60" x 30" x 15"	LH	White	
029532	260030-R-WH	60" x 30" x 15"	RH	White	

Montrose II Builders' Choice Soaker Tub

- Acrylic grab bars
- Sculpted armrests
- Slip resistant bottom
- Lucite cast acrylic surface



Part #	Mfg #	Finished Dimensions	Drain	Finish	Price
049782	4272620	72" x 36" x 21-3/4"	Universal	White	

Tubs

Soaking Tubs

Soaker Tub - Acrylic

3660 Pro-Fit Bathtub

- Rectangular bathtub with integral armrests
- Optional removable apron provides easy access to the motor and plumbing



Part #	Mfg #	Description	Dimensions	Color	Price
229854	MAN-6518-WH	6518 36 x 60 Soaker Tub White	59-3/4" x 35-3/4" x 21-1/4"	White	

3672 Pro-Fit Bathtub

- Rectangular drop-in bathtub with integral armrest
- Optional removable apron provides easy access to the motor and plumbing



Part #	Mfg #	Description	Dimensions	Color	Price
229857	MAN-6521-WH	6521 36 x 72 SoakerTub White	71-1/2" x 35-1/2" x 20"	White	

4260 Pro-Fit Bathtub

- Rectangular alcove with integral skirt. Saves time and money on installation.
- Spacious oval bathing well with integral armrests
- Optional removable apron provides easy access to the motor and plumbing



Part #	Mfg #	Description	Dimensions	Color	Price
229856	MAN-6524-WH	6524 42 x 60 Soaker Tub White	60" x 42" x 20-1/4"	White	

Soaking Tubs

4272 Pro-Fit Bathtub

- Rectangular shaped bathtub with oval bathing well
- Optional removable apron provides easy access to the motor and plumbing



Tubs

Part #	Mfg #	Description	Dimensions	Color	Price
229858	MAN-6527-WH	6527 42 x 72 Soaker Tub White	71-1/2" x 42" x 19-3/4"	White	

Tub Walls

Bathtub Wall Panels

RM-58 Swan High-Gloss 3-Panel Bathtub Wall System

- Designed to fit 29" - 30" x 60" or smaller bathtub
- Ultra-bright, glossy surface from durable, baked-on finish
- Includes:
 - (1) Back panel with molded-in soap dish
 - (2) End panels
 - (1) Roll of pressure sensitive tape
 - (3) Tubes of adhesive
 - (1) Tube of caulk
 - Complete installation instructions
- Will not mold or mildew, no grout to clean
- Limited lifetime warranty



Tubs

Part #	Mfg #	Width	Depth	Height	Color	Price
010242	RM-58-010	60"	29"	58"	White	

TW-32 Swan High-Gloss 5-Panel Bathtub Wall System

- Designed to fit 29" - 32" x 57" - 62" bathtub
- Ultra-bright, glossy surface from durable, baked-on finish
- Includes:
 - (1) Back panel with molded-in soap dish
 - (2) Right angle corner panels with molded-in shampoo shelves
 - (2) Flat side panels
 - (2) Apron strips
 - (1) Roll of pressure sensitive tape
 - (3) Tubes of adhesive
 - (1) Tube of caulk
 - Complete installation instructions
- Will not mold or mildew, no grout to clean
- Limited lifetime warranty



Part #	Mfg #	Width	Depth	Height	Color	Price
010255	TW-32-010	57" - 62"	29" - 32"	58"	White	

Veritek™ 5-Panel Bathtub Wall System

- Designed to fit 28" - 30" x 58" - 60" bathtubs
- Made of Veritek™ with no surface coating to chip or crack
- Includes:
 - (1) Back panel
 - (2) Corner panels with (4) molded-in soap & bottle shelves
 - (2) Side panels
 - (1) Roll of pressure sensitive tape
 - (3) Tubes of adhesive
 - (1) Tube of caulk
 - Complete installation instructions
- Will not mold or mildew
- Limited lifetime warranty



Part #	Mfg #	Width	Depth	Height	Color	Price
021018	TF-57-010	58" - 60"	28" - 30"	57"	White	

Tub Walls

Tubs

Durawall® Bathtub Walls

Durawall® Deluxe Thermoplastic Bathtub Wall

- Hi-impact panels adhesive-mounted to drywall and like surfaces
- Fits bathtub alcoves up to 30" deep and 60" wide
- (4) Molded-in, self-draining shelves
- Can be trimmed for out-of-plumb alcoves or window kits
- Smooth, glossy, colorfast finish

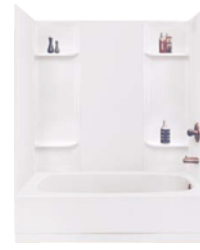

Part #	Mfg #	Pieces	Color	Price
007537	53WHT	5	White	

DuraTrim® Window Trim Kits

DuraTrim® Thermoplastic Window Trim Kit

- Consists of (3) 36" x 8" panels
- Prevents water damage to window sill and side moldings
- Scuff resistant
- Adjustable

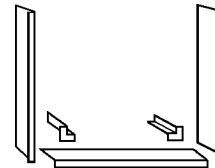

Part #	Mfg #	Pieces	Color	Price
028430	52.600W	3	White	

Bath Wastes

Plastic Tubular Bath Waste & Overflow Assemblies

Push eN Lift Stopper Assembly

- 2-Hole overflow plate
- With pipe and tee
- 1-1/2" PVC



Part #	Mfg #	Description	Price
145541	1506	Pol Chrome	

Turn Top Stopper Assembly

- 2-Hole overflow plate
- With pipe and tee
- 1-1/2" PVC



Part #	Mfg #	Description	Price
145540	1495CP	Pol Chrome	

Schedule 40 Bath Waste & Overflow Full Kits

Push eN Lift Stopper Full Kit

- 1-Hole overflow plate
- With pipe and tee
- 1-1/2" PVC



Part #	Mfg #	Description	Price
145546	911	Pol Chrome	

Heavy-Duty "Classic" Waste & Overflow with Test Kit

Standard Length with Turn Top Stopper

- 1-1/2" PVC

Part #	Mfg #	Description	Price
146502	4051	Chrome	
146503	4054SN	Satin Nickel	

Classic Schedule 40 Bath Waste & Overflow Half Kits

PVC with Push eN Lift Stopper Half Kit

- Less pipe and tee

Part #	Mfg #	Description	Price
145547	2218	Pol Chrome	
145549	2222SN	Satin Nickel	
147936	2222W	White	
145548	2222SC	Satin Chrome	
145550	2222VB	Venetian Bronze	

PVC with Turn Top Stopper Half Kit

Part #	Mfg #	Description	Price
145553	2251CP	Chrome	
148953	2255SN	Satin Nickel	

Schedule 40 1-Hole Bath Waste & Overflow Half Kits

- Less pipe and tee

Push eN Lift Stopper Assembly Half Kit

- 1- or 2-Hole overflow plate
- Less pipe and tee
- 1-1/2" PVC



Part #	Mfg #	Description	Price
145542	956	1-Hole, Pol Chrome	
145543	960ORB	1-Hole, Oil Rubbed Bronze	
145554	960SN	1-Hole, Satin Nickel	
147422	960VB	1-Hole, Venetian Bronze	

PVC with Push eN Lift Stopper Assembly Half Kit



Part #	Mfg #	Description	Price
159114	976	2-Hole, Pol Chrome	

Tubular, Strainers, Bathwastes & Drains

Bath Wastes

PVC with Turn Top Stopper



Part #	Mfg #	Description	Price
161870	1335-CP	2-Hole, Pol Chrome	

Trim Kits

Brass Push eN Lift Bathtub Finish Kit

- Includes:
 - 1-3/8"-16 Fine thread strainer
 - Bushing to 1-1/2"-11-1/2"
 - Push eN Lift stopper
 - 1-Hole overflow plate with converter bar
 - Screw



Part #	Mfg #	Description	Price
145555	1658	Pol Chrome, Bulk Pack	
145537	1662SN	Satin Nickel, Bulk Pack	
145538	1662VB	Venetian Bronze, Bulk Pack	

Tubular, Strainers, Bathwastes & Drains

Bath Wastes

Brass Bath Wastes

Trip Lever Brass Bath Waste for 14" & 16" Tubs

- 3 Unfinished

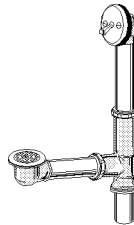

Part #	Mfg #	Size	Gauge	Price
003303	226-3	1-1/2"	20ga	

Uni-Lift 20 Gauge Brass Bath Waste for 14" & 16" Tubs

- 1-1/2" Waste shoe
- 3 Unfinished



Part #	Mfg #	Size	Gauge	Price
003305	227-3	1-1/2" Hi-Tee	20ga	
003302	227S-3	1-1/2" Side Drain	17ga	

Brass Uni-Lift Direct Drain

- 1-1/2"
- 3 Unfinished
- Full kit



Part #	Mfg #	Size	Gauge	Price
003306	227D-3	1-1/2"	17ga	

Chain & Stopper Brass Bath Waste

- 1 Polished chrome
- Includes:
 - 20ga Brass tubing rough-in
 - Cast brass slip tee joint
 - 2-Hole cast brass top ell
 - 2-Hole faceplate
 - Black rubber washer
 - 15" Heavy-duty chain with 1-3/4" rubber stopper
 - Blue top ell washer
 - 1-1/4" Drain seat
 - 1-3/8" Reducing tailpiece for 16" leg tubs
 - (2) Nuts
 - (2) Rubber slip joint washers
 - Bottom ell washer
 - 1-1/4" Cast brass waste shoe



Part #	Mfg #	Description	Price
003298	202-1	Chrome-Plated Tubing & Trim	

Bath Waste Trim Kits

Uni-Lift Drain Trim Kit

- 1-1/2" Spud



Part #	Mfg #	Description	Price
077053	K25TB	Less Spud, Chrome	
077259	K75TRB	Rubbed Bronze	
084848	K75TSN	UltraShine™ PVD Satin Nickel	

Rough-In Kit Touch Toe Stopper

- Trim kit for Sch40
- Chrome finish



Part #	Mfg #	Size	Gauge	Price
153090	K24TB	Touch-Toe Stopper		

Tubular, Strainers, Bathwastes & Drains

Bath Wastes

Plastic Bath Wastes

Plastic Trip Lever Bath Waste with 1-1/4" Waste Shoe

- Includes:
 - Tubing rough-in and slip joint tee
 - 2-Hole top ell
 - Trip lever faceplate with linkage
 - Retaining clip
 - Blue top ell washer
 - Strainer
 - Stainless steel strainer cover and cover screw
 - (2) Wing nuts
 - (2) Poly washers
 - Bottom ell washer
 - 1-1/4" Waste shoe
- Boxed



Part #	Mfg #	Description	Price
003259	P9226	PVC Tee, White Poly Tubes, Plastic Strainer, CP Trim	

Uni-Lift Plastic Bath Wastes

Uni-Lift Full Kit Plastic Bath Wastes with 1-1/2" Waste Shoe

- Includes:
 - Wing nuts
 - Tubing rough-in and slip joint tee
 - 2-Hole top ell
 - Uni-lift faceplate
 - Retaining clip
 - Blue top ell washer
 - 1-1/2" Uni-lift drain unit with o-ring seal
 - (2) Wing nuts
 - (2) Poly washers
 - Bottom ell washer
 - 1-1/2" Waste shoe



Part #	Mfg #	Description	Price
003261	P8227	White PVC, Chrome Trim	

Uni-Lift Plastic Tubular Full Kits with Direct Drain

- Includes:
 - 1-1/2" Drain shoe
 - 1-1/2" Drain spud
 - Brass Uni-lift stopper



Part #	Mfg #	Description	Price
048742	P8227D	Chrome Finish w/Black Stopper	

Full Kit Plastic Bath Wastes with White Cable Stopper

- Chrome finish trim



Part #	Mfg #	Size	Gauge	Price
157790	P8220	Chrome Finish, Plastic Tubular		

Uni-Lift Sch 40 Half Kit Bath Wastes 1-Hole Faceplate

- 1-1/2" Uni-lift drain trim
- Half-Kit Includes all parts required for rough-in, testing, & finish installation
- Less pipes & tee



Part #	Mfg #	Description	Price
076177	P7225B	PVC, Chrome	

Touch-Toe Plastic Bath Wastes

Touch-Toe Plastic Bath Waste, 2-Hole Faceplate

- Includes:
 - Wing Nuts
 - 1-1/2" Waste Shoe
- Boxed



Part #	Mfg #	Description	Price
030625	P9228	Chrome, PVC, White PP	

Tap-Tap Sch 40 1/2 Kit

- Includes:
 - Sch 40 PVC ell, Sch 40 top ell and faceplate
 - Blue top ell washer
 - 1-1/2" Tap-Tap drain unit with o-ring seal
 - Bottom ell washer
 - 1-1/2" Waste shoe
 - Less tubes & tee



Part #	Mfg #	Description	Price
003255	P7224B	PVC, 1-Hole Faceplate, CP Trim	

Tubular, Strainers, Bathwastes & Drains

Bath Wastes

Plastic Push-N-Lock Bath Wastes

**Push-N-Lock Sch 40 Bath Wastes
Rough-In Kit**

- For Touch-Toe & Uni-Lift Drains
- Includes:
 - Waste & overflow elbows
 - Spud
 - Test caps
 - Gaskets
 - Cross-bar & screws



Part #	Mfg #	Description	Price
081508	P7223RK	PVC, Test System	

Decorator/Conversion Kits

Trip-Lever Conversion Kit



Part #	Mfg #	Finish	Price
120253	K26RB	Rubbed Bronze	
091296	K26BN	Brushed Nickel	
087198	K26SN	UltraShine® Satin Nickel	

Uni-Lift 1-1/4" 2-Hole Conversion Kit

- Includes:
 - 1-1/4" Uni-Lift drain unit with o-ring seal
 - Bottom ell washer
 - Faceplate and screws
 - 1-1/4" x 1-1/2" Threaded adapter



Part #	Mfg #	Finish	Price
003241	K27	Chrome Finish Trim	
078040	K27BN	Brushed Nickel Trim	
003242	K27PB	UltraShine® Pol Brass Trim	
084456	K27RB	Rubbed Bronze Trim	
085025	K27SN	Satin Nickel	

Tubular, Strainers, Bathwastes & Drains

Bath Wastes

Bath Waste & Overflow

- Teflon® coated stainless steel cable
- No internal linkage or moving parts in the pipe to adjust
- Installation tools included

TurnControl™ Cable-Operated Rough-In Drain

- 1-1/2" Tubular polypropylene
- For Euro or traditional TurnControl™ trim kits
- ASME A112.18.2/CSA B125.2 Compliant
- Trim sold separately



Part #	Mfg #	Finish	Tub Depth	Price
114930	151.504.00.1	Chrome	17" - 24"	

TurnControl™ Trim Kit - Molded Plastic



Part #	Mfg #	Finish	
114907	151.550.21.1	Chrome	
114906	151.550.CL.1	Bright Brass	
114926	151.550.DY.1	White	
114927	151.550.FF.1	Biscuit	

TurnControl™ Trim Kit - Metal Trim



Part #	Mfg #	Finish	
116135	151.551.21.1	Chrome	
114922	151.551.ID.1	Brushed Nickel	
114911	151.551.HM.1	Oil Rubbed Bronze	

Tubular, Strainers, Bathwastes & Drains



Bath Wastes

Drains

Pop-Up Brass Drain

- Pre-adjustable linkage
- Fits most tubs 14" to 16"
- Roman fits most tubs 24"



Part #	Mfg #	Description	Price
004699	41-806	Fit-All Drain in Shoe, 20ga, Brass-Plated Zinc Nuts, Chrome	
021533	41-807	Fit-All Side Outlet, 20ga, Brass-Plated Zinc Nuts, Chrome	

Trip Lever Brass Drain

- Pre-adjustable linkage
- Fits most tubs 14" to 16"
- Roman fits most tubs 24"



Part #	Mfg #	Description	Price
068557	N1-812	Roman, 18" O.F., 9" Shoe, 17ga, Brass Nuts, *Brushed Nickel	
004700	41-813	Roman, 18" O.F., 9" Shoe, 17ga, Brass Nuts, Chrome	
004701	41-818	All-Tub Drain in Tee, 20ga, Brass-Plated Zinc Nuts, Chrome	
112590	86-863-RB	Trim Kit For G41-818 Drain, Oil Rubbed Bronze	
052596	N1-813	Roman, 18" O.F., 9" Shoe, 17ga, Brass Nuts, *Brushed Nickel	

Auto Trip Brass Drain

- Fits most tubs 14" to 16"
- Roman fits most tubs 24"



Part #	Mfg #	Description	Price
004702	41-848	All-Tub Drain in Tee, 20ga, Brass-Plated Zinc Nuts, Chrome	

Lift & Turn Brass Drain

- Fits most tubs 14" to 16"
- Roman fits most tubs 24"

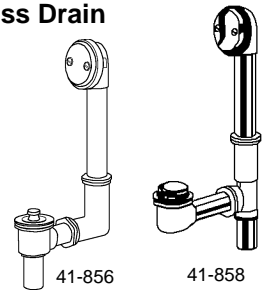

Part #	Mfg #	Description	Price
004705	41-856	Fit-All Drain in Shoe, 20gab, Brass-Plated Nuts, Chrome	
004706	41-858	All-Tub Drain in Tee, 20ga, Brass-Plated Zinc Nuts, Chrome	

Lift & Turn Brass Bath Drains with Tubing & Tee

- Fits most tubs 14" to 16" high
- 1-1/2" Sch 40 plastic tubing in PVC
- Adjustable self-retaining rubber head gasket
- Cast brass shoe plug



Part #	Mfg #	Description	Price
042189	41-562	PVC Lift & Turn, Chrome	

PVC & ABS Drains

Trip Lever PVC/ABS Drain

- Pre-adjustable linkage
- Fits most tubs 14" to 16"



Part #	Mfg #	Description	Price
004697	41-510	All-Tub Drain-In-Tee, PVC, Chrome	

*Physical Vapor Deposition (PVD) Limited Lifetime Finish

www.plumbsupply.com • Serving our Customers Since 1946 • www.waterconcepts.net



Bath Wastes

Roman Trip Lever PVC/ABS Drain

- Fits most tubs 24"



Part #	Mfg #	Description	Price
026439	41-513	All-Tub Drain-In-Tee, PVC Chrome	

Auto Trip PVC/ABS Drain

- Fits most tubs 14" to 16"



Part #	Mfg #	Description	Price
134396	41-540	Fit-All Drain-In-Tee, PVC Chrome	

Lift & Turn PVC Tub Drain

- Fits most tubs 14" to 16"
- 1-1/2" Plastic tubing in PVC
- Adjustable self-retaining rubber head gasket
- Cast brass shoe plug



Part #	Mfg #	Description	Price
023421	41-550	PVC, Chrome	

Schedule 40 Drains

- Includes tubing and tee

Auto Trip Sch 40 Drain



Part #	Mfg #	Description	Price
078520	41-532	PVC, Chrome	

Lift & Turn Sch 40 Drain Trim Kit

- Less tubing and tee



Part #	Mfg #	Description	Price
004698	41-552	PVC, Self-Retaining Gasket, Chrome	

Drain Exposed Parts Trim Kits

Trip Lever Trim Kit

- Includes:
 - Lever/faceplate
 - (2) 2-1/4" Faceplate screws
 - Strainer with screw



Part #	Mfg #	Finish	Price
004457	A6-861	Biscuit	
052896	N6-863	*Brushed Nickel	

Lift & Turn Trim Kit

- Includes:
 - Faceplate
 - (2) 2-1/4" Faceplate screws
 - Lift & turn stopper
 - Shoe plug



Part #	Mfg #	Finish	Price
021370	W6-881	White	

*Physical Vapor Deposition (PVD) Limited Lifetime Finish

www.waterconcepts.net • Serving our Customers Since 1946 • www.plumbsupply.com

Bath Wastes

Basin & Tub Drain Stoppers

Flip-It Tub Stopper

- No tools needed for installation
- Open or close with flip of the toe
- Fits most popular tub drains (assorted o-rings included)
- 1-Piece construction of Delrin and ABS

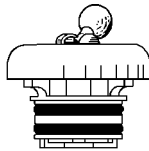

Part #	Mfg #	Finish	Price
109042	P35-070	Chrome-Plated	

Bath Drain Waste & Overflow Kits

Sch 40 Bath Waste Kit - Standard Full Kit

- Includes pipe or tee
- Bolt holes on top elbow are pre-threaded
- All drains 3/8" thread size for testing



Part #	Mfg #	Description	Price
097784	B07-132	2-Hole Faceplate, PVC Drain, CP Trim, Pop up	
227739	B07-18BN	2-Hole Faceplate, PVC Drain, Brushed Nickel, Toe Touch	

Trip Lever Waste and Overflow Kit

- Includes Pipe and Tee
- 2 Hole faceplate
- Satin Nickel



Part #	Mfg #	Description	Price
173823	P37511	PVC Drain, 2 Hole Faceplate, SN Trim	

Lift & Turn Waste and Overflow Kit

- Lift and Turn Drain
- 2 Hole Face plate
- Tee and Pipe included



Part #	Mfg #	Description	Price
166504	P3750BS	PVC Drain, 2 Hole Faceplate, BS Trim	

Bath Drain Trim Kits Only

Trip Lever Trim Only

- Clamshell Packing
- Inc, Faceplate, Screws & Strainer
- Polished Brass



Part #	Mfg #	Description	Price
172671	B51-14PB	Polished Brass Trip Lever	
159456	B51-14WB	Old world Bronze Trip Lever	
161344	B51-14BN	Brushed Nickel Trip Lever	

Lift & Turn Trim Kit Only

- 1-3/8" drain with bushing, screw and faceplate
- Clamshell packaging
- 2-hole faceplate



Part #	Mfg #	Description	Price
094757	B51-55BN	Brushed Nickel	
107379	B51-55WB	Old World Bronze	

Overflow Faceplate

- 2" Screws



Part #	Mfg #	Description	Price
186534	T05013	Chrome-Plated	

Tubular, Strainers, Bathwastes & Drains

Bath Wastes

Friction Lift Tub Drain

- Solid brass
- 1-1/2" drain
- Course thread



Part #	Mfg #	Description	Price
225857	P3561BL	Lift, Black	



Bath Wastes

Bath Drains

Single-Hole Lift & Turn Drain Strainer

- Complete with single-hole faceplate and faceplate screw
- Brass body

Part #	Mfg #	Finish	Price
115875	540-AB	Antique Brass	
115878	540-BU	Bronze Umber	
170478	540-CB	Caramel Bronze	
125717	540-MBK	Matte Black	
115876	540-ORB	Oil Rubbed Bronze	
125757	540-PB	Polished Brass	
115873	540-PCH	Polished Chrome	
115877	540-PEW	Pewter	
173164	540-PN	Polished Nickel	
115874	540-SN	Satin Nickel	
176299	540-VB	Vintage Bronze	

Two-Hole Lift & Turn Drain Strainer

- Complete with two-hole faceplate and (2) faceplate screws
- Brass body



Part #	Mfg #	Finish	Price
125766	542-AB	Antique Brass	
125759	542-BU	Bronze Umber	
125761	542-MBK	Matte Black	
125762	542-ORB	Oil Rubbed Bronze	
125758	542-PB	Polished Brass	
125760	542-PCH	Polished Chrome	
125764	542-PEW	Pewter	
153340	542-PN	Polished Nickel	
128713	542-SC	Satin Chrome	
125765	542-SN	Satin Nickel	
175380	542-VB	Vintage Bronze	
149054	542-WH	White	

Trip Lever Drain Kit

- Contains trip lever, faceplate and grid strainer
- Fits Gerber®, Jaclo®, and most other manufacturers



Part #	Mfg #	Finish	Price
154190	519-AB	Antique Brass	
134019	519-ACU	Antique Copper	
125772	519-BU	Bronze Umber	
125777	519-MBK	Matte Black	
125773	519-ORB	Oil Rubbed Bronze	

Bath Drains (Continued)

Trip Lever Drain Kit

Part #	Mfg #	Finish	Price
154030	519-PB	Polished Brass	
125779	519-PCH	Polished Chrome	
125774	519-PEW	Pewter	
135066	519-PN	Polished Nickel	
128550	519-SC	Satin Chrome	
155804	519-SG	Satin Gold	
125778	519-SN	Satin Nickel	

Cable Drain Trim

- All brass construction
- Universal design to fit most manufacturers' cable drains



Part #	Mfg #	Finish	Price
117687	508-BKN	Black Nickel	
117688	508-BU	Bronze Umber	
117689	508-MBK	Matte Black	
117690	508-ORB	Oil-Rubbed Bronze	
117692	508-PCH	Polished Chrome	
117691	508-PEW	Pewter	
117685	508-SC	Satin Chrome	
117686	508-SN	Satin Nickel	

Tubular, Strainers, Bathwastes & Drains

Bath Wastes

Tub & Shower Wastes

Clearflo Adjustable Pop-Up Bath Drain

- Above-the-floor drain
- 1-1/2", 17" to 24" deep baths



Part #	Mfg #	Description	Price
068367	K-7161-AF-AF	*French Gold	
105386	K-7161-AF-BKB	Brushed Black	
054831	K-7161-AF-BN	*Brushed Nickel	
075013	K-7161-AF-BV	*Brushed Bronze	
053732	K-7161-AF-CP	Polished Chrome	
059178	K-7161-AF-G	Brushed Chrome	
055642	K-7161-AF-PB	*Polished Brass	
074489	K-7161-AF-SN	*Polished Nickel	
176269	K-7161-AF-2BZ	Oil-Rubbed Bronze	

Clearflo Adjustable Pop-Up Drain

- Through-the-floor
- 1-1/2", 14" to 16" deep baths



Part #	Mfg #	Description	Price
101228	K-7160-TF-AF	*French Gold	
158249	K-7160-TF-BKB	Brushed Black	
058979	K-7160-TF-BN	*Brushed Nickel	
069491	K-7160-TF-BV	*Brushed Bronze	
056883	K-7160-TF-CP	Polished Chrome	
056165	K-7160-TF-G	Brushed Chrome	
097297	K-7160-TF-PB	*Polished Brass	
173111	K-7160-TF-SN	*Polished Nickel	

Clearflo Decorative Adjustable Pop-Up Drain

- Above- or through-the-floor
- 1-1/2"
- For use with Iron Works Tellieur® and Historic™ baths



Part #	Mfg #	Description	Price
190095	K-7178-BN	*Brushed Nickel	
181583	K-7178-CP	Polished Chrome	

Clearflo Adjustable Pop-Up Bath Drain with High Volume and Tailpiece

- Above- or through-the-floor
- 2" NPT connection
- 23" to 25" Deep baths



Part #	Mfg #	Description	Price
074946	K-7167-BN	*Brushed Nickel	
069019	K-7167-CP	Polished Chrome	
154101	K-7167-2BZ	Oil-Rubbed Bronze	

Clearflo Brass Toe Tap Bath Drain

- Above- or through-the-floor
- Solid brass construction
- K-7259
-14" to 20" Deep baths
- K-7265
-20" to 26" Deep baths



Part #	Mfg #	Description	Price
182832	K-7259-AF	*French Gold	
226953	K-7259-BGD	*Moderne Brushed Gold	
134191	K-7259-BN	*Brushed Nickel	
144750	K-7259-BV	*Brushed Bronze	
151871	K-7259-CP	Polished Chrome	
175801	K-7259-SN	*Polished Nickel	
147068	K-7259-2BZ	Oil-Rubbed Bronze	
173950	K-7265-AF	*French Gold	

* Vibrant Limited Lifetime Warranty

www.waterconcepts.net • Serving our Customers Since 1946 • www.plumbsupply.com

Bath Wastes

Tub & Shower Wastes (Continued)

Clearflo Brass Toe Tap Bath Drain

Part #	Mfg #	Description	Price
133753	K-7265-BN	*Brushed Nickel	
181870	K-7265-BV	*Brushed Bronze	
138263	K-7265-CP	Polished Chrome	
138244	K-7265-G	Brushed Bronze	
147069	K-7265-2BZ	Oil-Rubbed Bronze	

Clearflo Closing Overflow

- Cable-activated drain
- Closing overflow allows for extra-deep water level
- Includes copper corrugated neck
- For use with 14- to 22-inch deep baths



Part #	Mfg #	Description	Price
159733	K-7116-2BZ	Oil-Rubbed Bronze	

Clearflo Cable Bath Drain - Through-the-Floor Installation

- With PVC tubing and 27" cable
- Metal construction control handle and stopper
- For use with 14" to 21" deep baths or whirlpools



Part #	Mfg #	Finish	Price
116540	K-7213-BN	*Brushed Nickel	
117965	K-7213-BV	*Brushed Bronze	
166438	K-7213-CP	Polished Chrome	
183138	K-7213-SN	*Polished Nickel	
147065	K-7213-2BZ	Oil-Rubbed Bronze	

Clearflo Cable Bath Drain - Through-the-Floor Installation

- Less PVC tubing
- Includes 27" cable
- Metal construction control handle and stopper
- For use with 14" to 21" deep baths or whirlpools



Part #	Mfg #	Finish	Price
104733	K-7214-BN	*Brushed Nickel	
101633	K-7214-BV	*Brushed Bronze	

Tub & Shower Wastes (Continued)

Clearflo Cable Bath Drain - Through-the-Floor Installation

Part #	Mfg #	Finish	Price
109948	K-7214-CP	Polished Chrome	
115379	K-7214-G	Brushed Chrome	
173263	K-7214-SN	*Polished Nickel	
147066	K-7214-2BZ	Oil Rubbed Bronze	

Clearflo Horizontal Overflow Bath Drain Through-the-Floor Installation

- 17-Gauge brass construction
- 1-1/2" OD connection
- Cable operated
- Includes brass tee & pipe & template
- For use with Fountainhead™ and Purist® baths



Part #	Mfg #	Description	Price
188519	K-7273-BN	*Brushed Nickel	

Clearflo Slotted Overflow Brass Bath Drain - Above-/Through-the-Floor Installation

- Brass construction
- Toe-activated closing
- Swivel-ball joint construction
- Includes a tee, drain ell, and overflow ell



Part #	Mfg #	Finish	Price
130986	K-7271-BN	*Brushed Nickel	
183139	K-7271-BV	*Brushed Bronze	
147542	K-7271-CP	Polished Chrome	
147070	K-7271-2BZ	Oil-Rubbed Bronze	

Tubular, Strainers, Bathwastes & Drains

* Vibrant Limited Lifetime Warranty

www.plumbsupply.com • Serving our Customers Since 1946 • www.waterconcepts.net

Bath Wastes

Clearflo Slotted Overflow Bath Drain - Above-/Through-the-Floor Installation

- Brass construction
- Toe-activated closing



Part #	Mfg #	Finish	Price
118967	K-7272-AF	*French Gold	
109672	K-7272-BN	*Brushed Nickel	
116856	K-7272-BV	*Brushed Bronze	
110361	K-7272-CP	Polished Chrome	
106101	K-7272-G	Brushed Chrome	
168145	K-7272-SN	*Polished Nickel	
121197	K-7272-PB	*Polished Brass	
223569	K-7272-VNT	Vintage Nickel	
147071	K-7272-2BZ	Oil Rubbed Bronze	

Iron Works® Exposed Bath Drain

- Above-the-floor
- For use with Iron Works Tellieur and Historic™ freestanding baths



Part #	Mfg #	Description	Price
090353	K-7104-BN	*Brushed Nickel	
086603	K-7104-BV	*Brushed Bronze	
057706	K-7104-CP	Polished Chrome	
168642	K-7104-2BZ	Oil-Rubbed Bronze	

PureFlo™ Rough-In Cable Drain

- Above- or through-the-floor
- Flexible overflow neck for easy installation to fit various bath angles
- Includes: tee, drain, ell, and overflow ell
- 37386-NA, 37380-NA
-Fits baths 14" - 21" deep
- 37382-NA
-Fits baths 21" - 26" deep



Required: PureFlo™ trim (sold separately)

Part #	Mfg #	Description	Price
156158	K-37380-NA	30" Cable, with Brass Tubing	
170466	K-37382-NA	45" Cable, with Brass Tubing	
149703	K-37383-NA	30" Cable, with Tubing	
150612	K-37385-NA	45" Cable, Without Tubing	
153265	K-37386-NA	30" Cable, Without Tubing	

PureFlo™ Rotary Turn Bath Drain Trim



Part #	Mfg #	Description	Price
149704	K-T37391-BN	Rotary Turn, *Br Nickel	
179639	K-T37391-BV	Rotary Turn, *Br Bronze	
153268	K-T37391-CP	Rotary Turn, Pol Chrome	
162354	K-T37391-SN	Rotary Turn, *Pol Nickel	
153280	K-T37391-2BZ	Rotary Turn, Oil-Rbd Brz	

PureFlo™ Contemporary Bath Drain Trim



Part #	Mfg #	Description	Price
153269	K-T37392-CP	Rotary Turn, Pol Chrome	
153274	K-T37392-BN	Rotary Turn, *Br Nickel	
170479	K-T37392-SN	Rotary Turn, *Pol Nickel	

* Vibrant Limited Lifetime Warranty

www.waterconcepts.net • Serving our Customers Since 1946 • www.plumbsupply.com

Bath Wastes

Tub & Shower Wastes (Continued)

PureFlo™ Contemporary Bath Drain Trim

Part #	Mfg #	Description	Price
150614	K-T37395-CP	Push Button, Pol Chrome	
153275	K-T37395-BN	Push Button, *Br Nickel	

PureFlo™ Traditional Bath Drain Trim



Part #	Mfg #	Description	Price
153276	K-T37393-BN	Rotary Turn, *Br Nickel	
183394	K-T37393-BV	Rotary Turn, *Br Bronze	
153270	K-T37393-CP	Rotary Turn, Pol Chrome	
153281	K-T37393-2BZ	Rotary Turn, *Pol Nickel	
182833	K-T37396-AF	Push Button, *French Gold	
149848	K-T37396-BN	Push Button, *Br Nickel	
153271	K-T37396-CP	Push Button, Pol Chrome	
153282	K-T37396-2BZ	Push Button, Oil-Rbd Brz	

PureFlo™ Cable Drain Trim Victorian Rotary



Part #	Mfg #	Description	Price
153277	K-T37394-BN	Rotary Turn, *Br Nickel	
153272	K-T37394-CP	Rotary Turn, Pol Chrome	
168883	K-T37394-SN	Rotary Turn, *Pol Nickel	
153283	K-T37394-2BZ	Rotary Turn, Oil-Rbd Brz	
153278	K-T37397-BN	Push Button, *Br Nickel	
153273	K-T37397-CP	Push Button, Pol Chrome	
153192	K-T37397-2BZ	Push Button, Oil-Rbd Brz	

PureFlo™ ABS Adapter Kit

- Use to join together PVC and ABS fittings
- Includes ABS & PVC fittings with O-ring seal



Part #	Mfg #	Description	Price
157527	K-37388-NA	ABS Adapter Kit	

Swiftflo™ 1-1/2" Adjustable Pop-Up Bath Drain

- 17 Gauge brass
- For 14"-16" baths
- Through-the-floor installation



Part #	Mfg #	Description	Price
053730	K-11660-CP	Polished Chrome	

Vintage® Pop-Up Bath Drain

- Solid brass construction
- For above-the-floor and free-standing installations
- Includes brass, tee, pipe, and pop-up drain
- For use with Vintage freestanding baths



Part #	Mfg #	Description	Price
182509	K-7159-SN	*Polished Nickel	
183634	K-7159-2BZ	Oil-Rubbed Bronze	

Underscore® Cube Cable Drain Trim Kit

- Solid-brass construction

For sue with K-8150 cable drain



Part #	Mfg #	Description	Price
155729	K-8134-BN	*Brushed Nickel	
142446	K-8134-CP	Polished Chrome	

* Vibrant Limited Lifetime Warranty

www.plumbsupply.com • Serving our Customers Since 1946 • www.waterconcepts.net

Bath Wastes

Schedule 40 Bath Waste Kits

600 Series Bath Waste

- Coarse thread
- 1-1/2" Solvent weld assembly
- 1-1/4" Deep metal strainer body
- Fits most tubs up to 16" deep
- Theft-resistant stopper



Half Bath Waste Kit - Lift and Turn

Part #	Mfg #	Piping	Finish	Price
094109	601-LT-PVC-CP	PVC	Chrome-Plated	

Tubular Plastic Bath Waste Kits

500 Series Plastic Bath Waste

- Coarse thread
- For 14" to 16" high tubs
- Slip joint assembly
- Metal strainer body
- 1-1/2" Pipe
- Theft-resistant metal stopper
- Retainer plate



Complete Bath Waste Kit - Push Pull®

Part #	Mfg #	Piping	Finish	Price
046494	500-PP-PVC-CP	PVC	Chrome-Plated	

Complete Bath Waste Kit - Trip Lever

Part #	Mfg #	Piping	Finish	Price
097994	500-TL-PVC-CP	PVC	Chrome-Plated	

Push Pull®

Model 615-PP Hub Adapter



Part #	Mfg #	Piping	Finish	Price
079542	615-PP-PVC-CP	PVC	Chrome-Plated	

Trim Kits

NuFit® Innovator® Trim Kit

- Converts conventional overflow and drain to Innovator snap-on overflow plate and NuFit strainer body
- Includes:
 - (1) #11121 Star retainer ring
 - (1) #11641 Adapter bar
 - (1) Innovator overflow plate
 - (1) NuFit body
 - (1) Stopper assembly
 - (1) Silicone adhesive
- For Presflo tubs

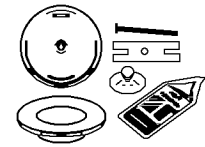

Part #	Mfg #	Closure	Finish	Price
094440	48100CP	PresFlo	Chrome-Plated	

Push Pull® 1.6" x 16 Trim Kit with Bushing

- Theft-resistant, brass stopper
- Metal strainer body, 1.25" deep
- Metal overflow plate, 3.375" wide
- Designed for heavy-duty use in hotels, motels, and rental property
- Replaceable, drip-proof Buna-N-Seal
- Adapter bar for changing from two-hole to one-hole overflow plate
- Push to close, pull to open, no stopper rotation required



Part #	Mfg #	Finish	Price
077223	38190CP	Chrome-Plated	
062066	38190BN	Brushed Nickel	
072128	38190BZ	Oil-Rubbed Bronze	
062060	38190PB	Polished Brass	

Flexible Bath Wastes

WatcoFlex® Innovator® Complete Bath Waste Lift and Turn Tub Closure

- For lengths 14-1/2" and longer
- Includes 11575 test plug with all Flex bath wastes



Part #	Mfg #	Piping	Finish	Price
098029	FLEX150-LT-PV C-CP	PVC	Chrome-Plated	

*PVD Lifetime Finish

www.waterconcepts.net • Serving our Customers Since 1946 • www.plumbsupply.com



Bath Wastes

Innovator® 900 and 901 Series Schedule 40 Bath Wastes

- 1.5" PVC or ABS Solvent weld assembly
- Built-in testing and snap-on overflow plate
- Threads on strainer body and drain elbow are 1-1/2" to 11-1/2" NPSM (Coarse thread); 11.5 threads per inch

901 Half Bath Waste Push Pull® Tub Closure

- Fits most tubs 14" to 16" high
- IAPMO, SBCCI, CSA
- Conforms to ANSI/ASTM F 409-88

Part #	Mfg #	Piping	Finish	Price
110233	901-PP-PVC-AP	PVC	Aged Pewter	
062058	901-PP-PVC-BN	PVC	Brushed Nickel	
072231	901-PP-PVC-BZ	PVC	Oil-Rubbed Brz	
081131	901-PP-PVC-CB	PVC	Chrome Brushed	

Quick Trim™ Kits

- Install chrome on the rough-in and easily upgrade to a special finish without removing the strainer body
- Sturdy stainless steel
- No reduction in flow rate
- Uses an o-ring for a tight, snug fit

Push Pull® 1-Hole Overflow Quick Trim™ Kit

Part #	Mfg #	Finish	Price
115402	39290-BN	Brushed Nickel	

Tubular, Strainers, Bathwastes & Drains

*PVD Lifetime Finish

www.plumbsupply.com • Serving our Customers Since 1946 • www.waterconcepts.net



Bath Waste

Part #	Mfg #	Description	Price
--------	-------	-------------	-------

*Tubular, Strainers, Bathwastes
& Drains*



Disposer Flanges

Disposer Drains

Garbage Disposal Flange Strainer

- Fits ISE (including Evolution Series®), Kenmore®, KitchenAid® and Maytag®
- Positive seal stopper
- Brass construction



Part #	Mfg #	Finish	Price
115914	2827-ORB	Oil Rubbed Bronze	
115913	2827-SN	Satin Nickel	

Garbage Disposal Flange with Stopper

- Designed to fit ISE (including Evolution Series®), Kenmore® and Kitchen Aid®
- Easy installation
- Brass construction
- Positive seal stopper



Part #	Mfg #	Finish	Price
115517	2815-MBK	Matte Black	
115909	2815-ORB	Oil Rubbed Bronze	
115908	2815SN	Satin Nickel	

Tubular, Strainers, Bathwastes & Drains

Disposer Flanges

Waste Disposer Parts & Trim

Waste Disposer Trim

- With disposer stopper/strainer unit
- For disposers with 3-3/8" ID
- Fits ISE (including Evolution Series®), Kenmore®, Maytag®, Ace®, KitchenAid®, and Whirlpool® models



Part #	Mfg #	Finish	Price
117816	MT200EV/BRN	Brushed Nickel	
117817	MT200EV/BRS	Brushed Stainless	
117818	MT200EV/ORB	Oil Rubbed Bronze	
117821	MT200EV/VB	Venetian Bronze™	

Waste Disposer Trim with Metal Flange

- Compatible with continuous feed waste disposers
- Fits Mountain Perfect Grind®, select Waste King® Gourmet series, select Whirlaway® and Franke models



Part #	Mfg #	Finish	Price
080661	MT201/BRS	Brushed Stainless	

Universal Flange with Removable Deluxe Strainer

- Fits ISE Evolution Disposer Series®
- Installed into existing flange
- Does not hold disposer



Part #	Mfg #	Finish	Price
086072	BWDUF/BL	Black	
130401	BWDUF/BN	Bone	
077065	BWDUF/BT	Biscuit	
136410	BWDUF/ORB	Oil Rubbed Bronze	
086071	BWDUF/PW	Polar White	
135610	BWDUFG/MLB	Matte Lava Black	

*PVD Finish

www.waterconcepts.net • Serving our Customers Since 1946 • www.plumbsupply.com

Disposer Flanges

Disposal Flanges**Artesso™ Disposal Flange Stopper**

Part #	Mfg #	Description	Price
222293	69070-BZ	Brushed Bronze*	
222292	69070-PC	Chrome	
222294	69070-PN	Polished Nickel*	
222295	69070-SS	Stainless*	

Solna® Disposal Flange with Stopper

Part #	Mfg #	Description	Price
091735	72030	Chrome	
155591	72030-AR	Arctic Stainless	
110264	72030-BZ	Brushed Bronze*	
160783	72030-CZ	Champagne Bronze™	
165747	72030-PN	Polished Nickel*	
078097	72030-SS	Stainless*	

* Brilliance® Anti-Tarnish Lifetime Finishes

www.plumbsupply.com • Serving our Customers Since 1946 • www.waterconcepts.net

Disposer Flanges

Garbage Disposer Flanges

Disposal Assembly for In-Sink-Erator*

- All stainless steel construction
- Positive stopper
- Fits all In-Sink-Erator*



Part #	Mfg #	Finish	Price
089790	B03-406	Oil Rubbed Bronze	
106383	B03-407	Old World Bronze	
183829	B03-408	Brushed Nickel	

* Manufacturer's name used only to describe whose products item will fit

Disposer Kits

C to E Brass Disposer Kits

- -1 Polished chrome



Part #	Mfg #	Size	Gauge	Price
003276	100201	1-1/2" x 13"	20ga	

Plastic Disposer Kits

End Outlet Kit for In-Sink-Erator

- B - Bagged



Part #	Mfg #	Size	Description	Price
003250	P9100	1-1/2" x 13"	PVC	

Telescopic For In-Sink-Erator or GE

- B - Bagged



Part #	Mfg #	Size	Description	Price
061663	P9100T	1-1/2"	PVC	
055444	P9100TB-12	1-1/2"	PVC	

Disposal Repair Parts

Dishwasher Disposal Connection

Part #	Mfg #	Description	Price
137161	HD2672C	1-3/4" Gasket for In-Sink-Erator	

Disposer Flanges

Disposer Strainers

In-Sink-Erator® Plastic Finish Disposer Waste

- Also for similar brands
- 3-1/2" Celcon® plastic finish



Part #	Mfg #	Description	Price
101357	JBC120E	Black	

In-Sink-Erator® Celcon Evolution Disposal Trim

- Remove factory splash guard and snap this trim and splash guard into your existing Evolution disposal flange
- Splash guard is included to replace factory splash guard



Part #	Mfg #	Description	Price
100674	JBC119E	White, Clamshell	
100675	JBC121E	Biscuit, Clamshell	
100676	JBC130E	Oil Rubbed Bronze, Clamshell	

In-Sink-Erator® Metal Disposal Flange

- Replaces factory flange on disposal



Part #	Mfg #	Description	Price
111111	JBC129	Brushed Nickel, Clamshell	

Tubular, Strainers, Bathwastes & Drains

Extension Tubes & Elbows

Brass Extension Tubes

Slip-Joint Extension Tube

- -1 Polished chrome



Part #	Mfg #	Size	Gauge	Price
003371	790-1	1-1/4" x 6"	Budget	
003372	790A-1	1-1/4" x 8"	Budget	
003373	790A-17-1	1-1/4" x 8"	17ga	
003374	791A-1	1-1/4" x 12"	Budget	
003375	791A-17-1	1-1/4" x 12"	17ga	
003378	792-1	1-1/2" x 6"	Budget	
003379	792A-1	1-1/2" x 8"	Budget	
003380	793A-1	1-1/2" x 12"	Budget	

Threaded Extension Tubes

- -1 Polished chrome



Part #	Mfg #	Size	Gauge	Price
003404	820A-1	1-1/4" x 8"	20ga	
003405	822-1	1-1/4" x 12"	20ga	
003408	825A-1	1-1/2" x 8"	20ga	
003409	827-1	1-1/2" x 12"	20ga	
003406	822A-1	1-1/4" x 12"	17ga	
003407	824-1	1-3/8" x 12"	17ga	

Flanged Strainer Tailpieces

- Chrome-plated finish
- Tubular flanged design
- 100°F Max working temp

Part #	Mfg #	Size	Gauge	Price
003387	796-1	1-1/2" x 1-1/4" x 8"	20ga	
003388	798-1	1-1/2" x 1-1/4" x 12"	20ga	

Brass Double Slip Trap Offsets

- BN - Brass nuts
- -1 Polished chrome



Part #	Mfg #	Size	Gauge	Price
003280	10461	1-1/4"	20ga	
003281	1046A-1	1-1/2"	20ga	

Brass Slip-Joint Connections

Brass Double Slip-Joint Connection

- -1 Polished chrome



Part #	Mfg #	Size	Gauge	Price
003376	791B-1	1-1/4" x 12"	22ga	
003377	791BD1	1-1/4" x 16"	22ga	
003382	793B-1	1-1/2" x 12"	22ga	
003383	793BD-1	1-1/2" x 16"	22ga	
003384	793C-1	1-1/4" x 2"	20ga	
003385	793D-1	1-1/2" x 2"	20ga	

Brass 45° Slip-Joint Connector



Part #	Mfg #	Size	Gauge	Price
062579	8477	1-1/4"	20ga	
062580	8478	1-1/2"	20ga	

Brass 90° Slip-Joint Connector

Part #	Mfg #	Size	Gauge	Price
062577	8482	1-1/4"	20ga	
062578	8483	1-1/2"	20ga	

Tubular, Strainers, Bathwastes & Drains

Extension Tubes & Elbows

Brass Tee Slip-Joint Connector



Part #	Mfg #	Size	Gauge	Price
117403	8480	1-1/4"	20ga	
125125	8481	1-1/2"	20ga	

Slip-Joint 45° Elbow

Part #	Mfg #	Size	Gauge	Price
064663	P9665	1-1/2"	PVC	

Double Slip Connector



Part #	Mfg #	Size	Description	Price
137162	P9793D	1-1/2" x 2"	PVC	

Plastic Extension Tubes
Solvent Weld Extension Tube



Part #	Mfg #	Size Description	Price
003268	P9787E	1-1/2" x 16" PVC	

Slip-Joint Extension Tube



Part #	Mfg #	Size	Description	Price
107027	P9790	1-1/4" x 6"	PVC	
107028	P9791A	1-1/4" x 12"	PVC	
072056	P9791E	1-1/4" x 6"	PVC Dbl Connect	
228687	P9792	1-1/2" x 6"	PVC	
228710	P9792A	1-1/2" x 8"	PVC	
003269	P9793A	1-1/2" x 12"	PVC	
003270	P9793E	1-1/2" x 16"	PVC Dbl Connect	
228711	P9793EC	1-1/2" x 16"	PVC Dbl Connect	

Plastic Elbows & Connectors

Slip-Joint 90° Elbow



Part #	Mfg #	Size Description	Price
137160	P9675	1-1/2" PVC	

Tubular, Strainers, Bathwastes & Drains



Extension Tubes & Elbows

Tubular Extension Tube

- Threaded at both ends
- Replaces 1-1/4" tube in basin drain to change length up to 12"



Part #	Mfg #	Finish	Price
143985	4237-SN	Satin Nickel	

Grid Drains & PO Plug Drains

Wrot Plugs

Two-Piece Wrot Plug with Chain & Stopper

- -1 Polished chrome
- K - Less overflow

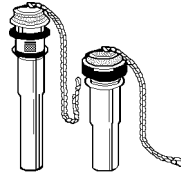

Part #	Mfg #	Size	Gauge	Price
003361	763-1	1-1/4" x 5"	20ga	
003362	763K-1	1-1/4" x 5"	20ga	
003363	764A-1	1-1/4" x 8"	Budget	

Commercial Plugs

Commercial Cast Grid Pop-Up Plug

- W - Wheelchair
- -1 Polished chrome



760-1



760W-1

Part #	Mfg #	Size	Gauge	Price
003359	7601	1-1/4" x 6"	17ga	
003360	760W-1	1-1/4"	17ga	

Tubular, Strainers, Bathwastes & Drains

Grid Drains & PO Plug Drains

Drains

20-Hole Grid Brass Decorative Lavatory Drain

- For vessel, glass, lavatory, and bar sinks
- Without overflow
- Fast flow angle top



Part #	Mfg #	Description	Price
110158	MT735/BRN	8", Brushed Nickel	
110159	MT735/CPB	8", Polished Chrome	
110157	MT735/VB	8", Venetian Bronze™	

Soft Touch Lavatory Decorative Drain with Overflow

- For vessel, glass, lavatory, and bar sinks
- Soft touch, push-in dome to seal water
- All exposed parts are plated
- 1-1/2" Drain opening



Part #	Mfg #	Description	Price
097376	MT741/CPB	8", Polished Chrome	

Soft Touch Lavatory Decorative Drain

- For vessel, glass, lavatory, and bar sinks
- Without overflow
- Soft touch, push-in dome to seal water
- All exposed parts are plated
- 1-1/2" Drain opening



Part #	Mfg #	Description	Price
099928	MT742/BRN	8", Brushed Nickel	
118895	MT742/CPB	8", Polished Chrome	
099958	MT742/ORB	8", Oil Rubbed Bronze	

Dome Style Lavatory Decorative Drain

- For vessel, glass, lavatory, and bar sinks
- Without overflow
- Fully plated one-piece brass drain body and tailpiece
- Soft touch, push-in dome to seal water
- All exposed parts are plated
- 1-1/2" Drain opening



Part #	Mfg #	Description	Price
083042	MT745-2/BRN	8", Brushed Nickel	
083044	MT745-2/VB	8", Venetian Bronze™	

*PVD Finish

www.plumbsupply.com • Serving our Customers Since 1946 • www.waterconcepts.net

Grid Drains & PO Plug Drains

Lavatory Drains

Lavatory Grid Drain Without Overflow

- Brass construction
- 1-1/4" Connection
- Decorative trim caps
- Flower design



Part #	Mfg #	Description	Price
178646	K-7107-AF	*French Gold	
107927	K-7107-CP	Polished Chrome	
147050	K-7107-2BZ	Oil-Rubbed Bronze	

Lavatory Grid Drain

- Brass construction
- 1-1/4" Connection
- (A)-Includes overflow drain



Part #	Mfg #	Description	Price
153920	K-7129-AF	*French Gold	
110634	K-7129-BN	*Brushed Nickel	
110633	K-7129-BV	*Brushed Bronze	
111814	K-7129-CP	Polished Chrome	
125490	K-7129-SN	Polished Nickel	
183137	K-7129-VS	*Stainless	
147057	K-7129-2BZ	Oil-Rubbed Bronze	
123335	K-7129-A-BN	*Brushed Nickel	
139372	K-7129-A-BV	*Brushed Bronze	
110035	K-7129-A-CP	Polished Chrome	
118399	K-7129-A-G	Brushed Chrome	
188864	K-7129-A-PB	*Polished Brass	
182942	k-7129-A-SN	*Polished Nickel	
161695	K-7129-A-VS	*Stainless	
147059	K-7129-A-2BZ	Oil-Rubbed Bronze	

Lavatory Pop-Up Clicker Drain with 1-1/4" Tailpiece

- Solid brass construction
- 1-1/4" Connection
- (A)-Includes overflow drain



Part #	Mfg #	Description	Price
153918	K-7124-AF	*French Gold	
112209	K-7124-BN	*Brushed Nickel	
114461	K-7124-CP	Polished Chrome	

Lavatory Drains (Continued)

Lavatory Pop-Up Clicker Drain with 1-1/4" Tailpiece

Part #	Mfg #	Description	Price
165362	K-7124-PB	Polished Brass	
155364	K-7124-SN	Polished Nickel	
146786	K-7124-2BZ	Oil-Rubbed Bronze	
111520	K-7124-A-BN	*Brushed Nickel	
121239	K-7124-A-BV	Brushed Bronze	
115149	K-7124-A-CP	Polished Chrome	
114587	K-7124-A-G	Brushed Chrome	
183174	K-7124-A-PB	Polished Brass	
183135	K-7124-A-SN	Polished Nickel	
147054	K-7124-A-2BZ	Oil-Rubbed Bronze	

Lavatory Drain with 1-1/4" Connection

- Brass construction
- Available with non-removable metal stopper
- For use with Spun Glass™ vessels lavatory
- (A)-Includes overflow drain



Part #	Mfg #	Description	Price
153201	K-7127-BN	Less Overflow, *Brushed Nickel	
110409	K-7127-CP	Less Overflow, Pol Chrome	
147055	K-7127-2BZ	Less Overflow, Oil-Rubbed Bronze	
146341	K-7127-A-BN	With Overflow, *Brushed Nickel	
125368	K-7127-A-CP	With Overflow, Pol Chrome	
147056	K-7127-A-2BZ	With Overflow, Oil-Rubbed Bronze	

Standard Non-Exposed Pop-Up Drain with Lift Rod

- For use with overflow sinks.
- Solid-brass construction.
- Pop-up drain with external button.
- 3-inch rough
- Includes 1-1/4-inch tailpiece



Part #	Mfg #	Description	Price
138784	K-7126-CP	Polished Chrome	

* Vibrant Limited Lifetime Warranty

www.waterconcepts.net • Serving our Customers Since 1946 • www.plumbsupply.com

Grid Drains & PO Plug Drains

Offset Drain With Open Strainer and Overflow

- Brass construction
- 6" Offset



Part #	Mfg #	Description	Price
169202	K-7131-A-CP	Polished Chrome	

* Vibrant Limited Lifetime Warranty

www.plumbsupply.com • Serving our Customers Since 1946 • www.waterconcepts.net

Grid Drains & PO Plug Drains

Lavatory Pop-Up Drains Push Pop-Up Assembly



Part #	Mfg #	Description	Price
130292	72172	Less Overflow, Chrome	
137798	72172CZ	Less Overflow, Champagne Bronze	
126838	72172RB	Less Overflow, Venetian Bronze®	
126637	72172SS	Less Overflow, Stainless*	
138293	72173	Overflow, Chrome	
154300	72173CZ	Overflow, Champagne Bronze™	
188079	72173PN	Overflow, Polished Nickel*	
128864	72173RB	Overflow, Venetian Bronze®	
131231	72173SS	Overflow, Stainless*	

Square Push Pop-Up Assembly



Part #	Mfg #	Description	Price
188199	72175SS	Overflow, Stainless*	
224480	72174	Less Overflow, Chrome	
185563	72174SS	Less overflow, Stainless*	

Lavatory Grid Strainer



Part #	Mfg #	Description	Price
120486	RP47648	Less Overflow, Chrome	
143949	RP47648CZ	Less Overflow, Champagne Bronze	
175058	RP47648PN	Less Overflow, Pol Nickel*	
098653	RP47648RB	Less Overflow, Ven Bronze®	
106068	RP47648SS	Less Overflow, Stainless*	
185751	RP72412BL	Overflow, Matte Black	
223317	RP72412BN	Overflow, Brushed Nickel*	
225764	RP72412NK	Overflow, Luxe Nickel*	
150941	RP72412RB	Overflow, Ven Bronze®	

Brizo® Button Push-Up Assembly



Part #	Mfg #	Description	Price
176987	RP72413BL	Less Overflow, Matte Black	
223448	RP72413NK	Less Overflow, Luxe Nickel*	
160853	RP72413PC	Less Overflow, Chrome	
165537	RP72413PN	Less Overflow, Pol Nickel*	
176988	RP72414BL	Overflow, Matte Black	
164707	RP72414BN	Overflow, Brushed Nickel*	
164784	RP72414PC	Overflow, Chrome	
227790	RP72414NK	Overflow, Luxe Nickel*	
169115	RP72414RB	Overflow, Ven Bronze*	

Vessel Bowl Grid Strainer



Part #	Mfg #	Description	Price
003716	RP6346	With Overflow, Chrome	
150942	RP6346SS	With Overflow, Stainless*	
158018	RP6346RB	With Overflow, Ven Brz®	

* Brilliance® Anti-Tarnish Lifetime Finishes

www.waterconcepts.net • Serving our Customers Since 1946 • www.plumbsupply.com

Grid Drains & PO Plug Drains

Complete Pop-Up Assembly



Part #	Mfg #	Description	Price
178537	RP28653BN	Brushed Nickel*	

RP26533 Lavatory Drain Assembly

- Less lift rod



Part #	Mfg #	Description	Price
121279	RP26533	Chrome	
226831	RP26533OB	Oil Rubbed Bronze	
075179	RP26533RB	Venetian Bronze®	
092017	RP26533SS	Stainless*	

Commercial Drains
Open Grid Strainer Wastes



Part #	Mfg #	Description	Price
060000	33T260	1-1/4" Inline open Grid Strainer	
185405	33T2901	1-1/4" Offset Open Grid Strainer w/ 5" Fixed Centers	

Tubular, Strainers, Bathwastes & Drains

* Brilliance® Anti-Tarnish Lifetime Finishes

www.plumbsupply.com • Serving our Customers Since 1946 • www.waterconcepts.net



Grid Drains & PO Plug Drains

Drains

Umbrella Drain less Overflow

- Patented drain channels, increase overall outflow of water while draining
- Push button closing mechanism
- Solid brass construction
- Threads are 3" long



Part #	Mfg #	Finish	Price
090809	9298-CP	Pol Chrome	
103269	9298-SN	Satin Nickel	

Constantly Open Grid Drain

- Designed to work with lavatories that do not require an overflow
- Constantly open
- Solid brass construction
- Threads are 3" long



Part #	Mfg #	Finish	Price
096515	9296-CP	Pol Chrome	
109386	9296-DB	Deco Bronze	
102440	9296-SN	Satin Nickel	

Tubular, Strainers, Bathwastes & Drains

Grid Drains & PO Plug Drains

Lavatory Drains

Lavatory Grid Drain

- 18 gauge
- 4" Drain Body
- 8" Brass Tailpiece
- Decorative finish covers all metal parts including tailpiece and lock nut
- Tailpiece opening – 1-1/4" OD
- Fits sinks with 1-1/2" drain hole
- Silicone washers
- Bodies threaded completely to the top



Part #	Mfg #	Description	Price
189532	D7021RB	Oil-Rubbed Bronze, w/ Overflow	

Lavatory Lift and Turn Drain

- For vessel sinks
- Less overflow



Part #	Mfg #	Description	Price
187474	P3500WB	Old World Bronze w/o Overflow	

Brass Pop-Up Assembly

- All metal construction
- Tool free locknut and ball rod nut
- 1-1/4" Tubular



Part #	Mfg #	Finish	Price
042864	P35-001	CP Brass	



Grid Drains & PO Plug Drains

Lavatory Drains

C.O. Plug Finger Touch Drain less Overflow Holes

- Complete with (2) rubber Mack washers to ensure secure fit
- Use with sinks and vessels not containing overflow hole
- Fits 1-1/2" opening



Part #	Mfg #	Finish	Price
122029	814-ORB	Oil-Rubbed Bronze	
117834	814-PCH	Polished Chrome	
140019	814-SN	Satin Nickel	

C.O. Style Round Top Extra Long Thread Finger Touch Drain (without overflow holes)

- Complete with (2) rubber Mack washers to ensure secure fit
- Use with thick counters
- Fits 1-1/2" opening



Part #	Mfg #	Finish	Price
115860	832-AB	Antique Brass	
115863	832-BU	Bronze Umber	
125703	832-MBK	Matte Black	
115861	832-ORB	Oil-Rubbed Bronze	
115858	832-PCH	Polished Chrome	
115862	832-PEW	Pewter	
115859	832-SN	Satin Nickel	
153137	832-VB	Vintage Bronze	

C.O. Style Stationary Round Top Extra Long Thread (Without Overflow)

- Complete with (2) rubber Mack washers to ensure secure fit
- Use with thin wall vessels and stainless steel basins not containing overflow hole
- Fits 1-1/2" opening



Part #	Mfg #	Finish	Price
151411	833-VB	Vintage Bronze	

Tubular, Strainers, Bathwastes & Drains

J-Bends

Brass J-Bends

Brass J-Bend less Cleanout

- -1 Polished chrome



Part #	Mfg #	Size	Gauge	Price
003341	650-1	1-1/4"	20ga	
003342	651-1	1-1/2"	20ga	

Tubular, Strainers, Bathwastes
& Drains

P-Traps

Brass P-Traps

P-Traps less Cleanout

- A - 3" Longer
- DF - Deep Flange
- -1 Polished chrome



Part #	Mfg #	Size	Gauge	Price
003345	7001	1-1/4"	20ga	
186600	700DF1	1-1/4"	20 ga	
003349	7021	1-1/2"	20ga	
003347	7011	1-1/4"	17ga	
003348	701A1	1-1/4"	17ga	
003352	7041	1-1/2"	17ga	
003351	704A1	1-1/2"	17ga	
228670	2702-1	1-1/2"	Budget	

Brass P-Traps with Cleanout

- -1 Polished chrome



Part #	Mfg #	Size	Gauge	Price
003354	7071	1-1/4"	17ga	
003355	7101	1-1/2"	17ga	

Brass Repair Trap

- -1 Polished chrome



Part #	Mfg #	Size	Gauge	Price
003346	700R1	1-1/4"	20ga	

Brass Low Inlet Tube P-Trap

- A - 3" Longer
- -1 Polished chrome



Part #	Mfg #	Size	Gauge	Price
029270	711A1	1-1/4"	17ga	
188482	714A1	1-1/2"	17 ga	

Commercial Products

Commercial Semi-Cast P-Trap with Cleanout

- Deep flange
- Brass nuts
- -1 Polished chrome



Part #	Mfg #	Size	Gauge	Price
003339	5071	1-1/4" x 12"	17ga	
003340	5101	1-1/2" x 12"	17ga	
223966	5510A1	1-1/2" x 15"	17ga	

Plastic P-Traps

PVC P-Traps

- BG - Bagged



P9701

Part #	Mfg #	Description	Price
003262	P9700	1-1/4" Choked Throat Outlet, 1-1/2" Inlet	
003263	P9701BG	1-1/4", Less Flange	

PVC P-Trap with Threaded Adapter

- Includes (3) nuts
- DF - Deep flange
- BG - Bagged



Part #	Mfg #	Size	Adapter	Price
003264	P9704	1-1/2"	PVC	
003265	P9704BG	1-1/2"	PVC	
035856	P9704DFB	1-1/2"	PVC	

PVC P-Trap with Threaded Adapter and Reversible J-Bend

- Super nuts feature full sized wings and longer threads
- Includes marvel connector
- DF - Deep flange
- BG - Bagged
- W - True Blue Washer

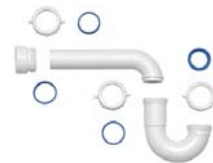

Part #	Mfg #	Size	Gauge	Price
163755	P9703WBG	1-1/2"	PVC	
157580	P9703BG	1-1/2"	PVC	

Tubular, Strainers, Bathwastes & Drains

P-Traps

Metal P-Traps

Metal P-Trap With Cleanout

- 17-Gauge brass with chrome plated finish
- For connection to a wall-connected sink drain system
- Compatible with copper pipes
- Slip joint connections



Part #	Mfg #	Size	Gauge	Price
168439	707DF1	1-1/4"	Brass	

Tubular, Strainers, Bathwastes
& Drains



Sink Wastes

Lavatory Traps

P-Trap with Round Box Escutcheon - 1-1/4"

- 17 Gauge
- Contains round box high escutcheon
- All solid brass nuts with washers



Part #	Mfg #	Finish	Price
115864	251-PCH	Pol Chrome	
115867	251-ORB	Oil Rubbed Bronze	
115865	251-SN	Satin Nickel	

Tubular, Strainers, Bathwastes
& Drains

P-Traps

Tubular Plastic

Chrome-Plated PVC P-Trap

- Complete with nuts, washers and escutcheon
- P36103 Includes reducing washer



Part #	Mfg #	Size	Price
091501	P36-102	1-1/4"	
091502	P36-103	1-1/2"	

P-Trap with Box Escutcheon

- 17 gauge
- Brass slip joint nut and rubber washers



Part #	Mfg #	Size	Price
187579	P3450RB	1-1/4"	

P-Traps

Plastic P-Traps

- Includes reducing washer



Part #	Mfg #	Description	Price
100186	802PVCBG	1-1/2" White w/Marvel Adapter, Bagged	

S-Traps

Brass S-Traps

- -1 Polished chrome



Part #	Mfg #	Size	Gauge	Price
003356	718-1	1-1/4"	20ga	
003357	720-1	1-1/2"	20ga	

Plastic S-Traps

Plastic S-Trap with PVC S-Bend & Solvent Weld Adapter

- BG - Bagged



Part #	Mfg #	Size	Description	Price
053462	P9718	1-1/4"	PVC	
003266	P9720	1-1/2"	PVC	
003267	P9722	1-1/2"	PVC	



Shower Drains

Shower Drains

Complete Square Shower Drain

- 4-1/4" Square drain plate
- 2-5/8" Center-to-center screw holes
- Fits 2" or 3" PVC
- Clamping ring design allows for water tight seal on shower pan membrane



Part #	Mfg #	Finish	Price
127688	86564-ORB	Oil Rubbed Bronze	
130086	86564-PCH	Pol Chrome	
130258	86564-SN	Satin Nickel	

Square Shower Drain Plate

- 4-1/4" Square
- Fits plumbing product drains
- Complete with screws



Part #	Mfg #	Finish	Price
151449	6264-AB	Antique Brass	
135491	6264-ORB	Oil Rubbed Bronze	
153373	6264-PCH	Pol Chrome	
135490	6264-SN	Satin Nickel	

4-1/4" Diameter Round Shower Drain Plate

- Snap-in



6236



6245

Part #	Mfg #	Finish	Price
115879	6236-PCH	Pol Chrome	
118338	6236-BU	Bronze Umber	
118341	6236-ORB	Oil Rubbed Bronze	
141695	6236-SG	Satin Gold	
115880	6236-SN	Satin Nickel	
175381	6236-VB	Vintage Bronze	
115890	6245-ORB	Oil Rubbed Bronze	
115892	6245-PEW	Pewter	
146180	6245-SG	Satin Gold	
115888	6245-SN	Satin Nickel	

Tubular, Strainers, Bathwastes & Drains

Shower Drains

Decorative Strainers

4-1/4" Stamped Strainer

- For D50-001 tile shower drains

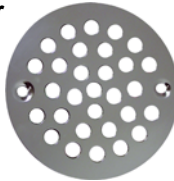

Part #	Mfg #	Finish	Price
085988	C60-89BN	Brushed Nickel	
111326	C60-89RB	Oil Rubbed Bronze	

Cast Brass Heavy-Duty Strainer

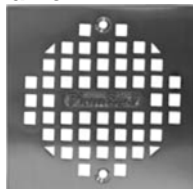

Part #	Mfg #	Description	Price
095059	C60-83BN	4-1/4" Square, Brushed Nickel	
106782	C60-83RB	4-1/4" Square, Oil Rubbed Brz	

Snap-In Strainer

- For no-caulk fiberglass shower stalls
- Fits D40-101 and D40-140



Part #	Mfg #	Finish	Price
098189	D40-05BN	Brushed Nickel	
107093	D40-05WB	Old World Bronze	
098188	D40-05RB	Oil Rubbed Bronze	

Strainer with Screws for Fiberglass Shower Stall

- 4-1/4" Diameter
- Fits D41-001 and D41-600
- Tapping screws included



Part #	Mfg #	Finish	Price
144817	D41-10BN	Brushed Nickel	
097147	D41-10RB	Oil Rubbed Bronze	

Drain Cleanout Spuds

2" Metal Spud with 4-1/4" Round Strainer

- All brass
- Works with shower drain base D50001



Part #	Mfg #	Finish	Price
110421	D60-98BN	Brushed Nickel	

2" Brass Spud with 4" Square Strainer

- All brass spud and strainer
- Grout ring
- Works with shower drain base D50001



Part #	Mfg #	Finish	Price
136508	D60-94BN	Brushed Nickel	
136511	D60-94RB	Oil Rubbed Bronze	

Replacement Parts for Drain Spuds

Strainer

- For plastic spuds



Part #	Mfg #	Description	Price
041999	D54-010	4" PB Fits Inside Plastic Ring	

General Purpose Drains

2" x 3" Fits Over 2" or Inside 3" Sch 40 DWV Pipe - Plastic

- Coverall top



Part #	Mfg #	Description	Price
042002	D54-001	PVC Drain w/SS Strainer	

Tubular, Strainers, Bathwastes & Drains

Shower Drains

3" x 4" Fits Over 3" or Inside 4" DWV Pipe - Plastic

- Coverall top
- Brass inserts
- NSF Approved



Part #	Mfg #	Description	Price
042003	D54-100	PVC Drain w/SS Strainer	
068951	D54-113	PVC Drain w/NB Strainer	

Brass Shower Drain w/ Square Strainer

- All brass spud and strainer
- Grout ring



Part #	Mfg #	Description	Price
184319	D50942	2" x 3" , Chrome-Plated	
184320	D50942BN	2" x 3" , Brushed Nickel	
184321	D50942WB	2" x 3" , Old World Bronze	

Snap-In Drains

All Plastic Snap-In Drain

- Fits into Sch 40 DWV pipe



Part #	Mfg #	Description	Price
042006	D42-002	2" PVC	

Shower Stall Drains

INO-Caulk Shower Stall Drain - Coverall Top

- Fits over 2" Schedule 40 DWV pipe
- Snap-in strainer
- Includes wrench
- For 2" CTS order gasket separately



Part #	Mfg #	Description	Price
041995	D40-140	SS Strainer (140NC) with Brass Body	

Shower/Floor Drains

Plastic Body Fits Over 2" or Inside 3" Sch 40 DWV Pipe

- Low profile
- Beveled edge
- Reversible clamping ring for additional 1/2" height adjustment
- Dual weep holes
- Recessed sump area for added drainage



Part #	Mfg #	Description	Price
041993	D50-001	PVC, 4" SS Strainer	
078551	D50-134	PVC, 4" CP Cast Square Strainer	

Decorative Finish Shower Drain Strainer

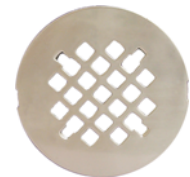

Part #	Mfg #	Description	Price
063938	D40-010	4-1/4" Satin Nickel Snap-In Strainer, Carded	

Plastic Body Receptor Base Shower Stall Drain

- Fits over 2" Sch 40 DWV pipe
- Allows for secondary drainage



Part #	Mfg #	Description	Price
041997	D41-001	2" PVC, SS Strainer	
089184	D41-600	PVC w/2" Offset, SS Strainer	

Cast Iron Shower & Floor Drain

- 2" IPS Brass spud - 6-1/2" pan
- Tongue and groove cast iron bolt down clamping ring
- Weep holes on both top and bottom for secondary draining
- Brass spud and 7" diameter pan
- Inside caulk unit can be used with gasket to make unit no-caulk



Part #	Mfg #	Description	Price
005886	D60-203	2" IPS Drain, 4" CP Brass Strainer	

Shower Drains

Drop-In Shower Stall Drain

- Fits over 2" Schedule 40 DWV pipe
- Drain body drops through shower base
- Locknut tightens from underside
- Snap-in strainer



Part #	Mfg #	Description	Price
047140	D41-007	2" PVC Solvent Outlet w/SS Strainer	

Shower Drains

Shower Wastes

Tile-In Shower Drain with Removable Grid Plate

- Brass and PVC construction
- Through-the-floor tile-in installation
- Reversible collar to for a variety of tile thickness
- Inside tailpiece for 2" drains/outside tailpiece 3" drains



K-9135-BN



K-9136-CP

Part #	Mfg #	Description	Price
127378	K-9135-AF	Round, *French Gold	
222087	K-9135-BGD	Round, *Brushed Gold	
165150	K-9135-BN	Round, *Brushed Nickel	
116821	K-9135-BV	Round, *Brushed Bronze	
184872	K-9135-G	Round, Brushed Chrome	
144808	K-9135-SN	Round, *Polished Nickel	
147075	K-9135-2BZ	Round, Oil-Rubbed Bronze	
122885	K-9136-AF	Square, *French Gold	
122884	K-9136-BN	Square, *Brushed Nickel	
119833	K-9136-BV	Square, *Brushed Bronze	
121687	K-9136-CP	Square, Polished Chrome	
167078	K-9136-G	Square, Brushed Chrome	
165545	K-9136-SN	Square, *Polished Nickel	
147076	K-9136-2BZ	Square, Oil Rubbed Bronze	

Round Shower Drain for use with Plastic Pipe

- 4-3/8" Width
- Gasket included
- Solid brass construction
- Prefoprated strainer
- Includes 2" plastic pipe gasket/bushing
- For acrylic, fiberglass, cast iron, vikrell receptors



Part #	Mfg #	Description	Price
069126	K-9132-AF	Round, *French Gold	
061212	K-9132-BN	Round, *Brushed Nickel	
077066	K-9132-BV	Round, *Brushed Bronze	
064284	K-9132-CP	Round, Polished Chrome	
086878	K-9132-G	Round, Brushed Chrome	
062968	K-9132-PB	Round, *Polished Brass	
066952	K-9132-SN	Round, *Polished Nickel	
147074	K-9132-2BZ	Round, Oil-Rubbed Bronze	

* Vibrant Limited Lifetime Warranty

www.waterconcepts.net • Serving our Customers Since 1946 • www.plumbsupply.com

Shower Drains

Shower Drain Grids

MT236 - Shower Grid

- All brass grid
- Snaps into place
- 4-1/4" Diameter, 4-1/4"OD,
2-7/8" prong to prong



Part #	Mfg #	Finish	Price
086063	MT236/BRN	Brushed Nickel	
086066	MT236/ORB	Oil Rubbed Bronze	
086068	MT236/PVDBB	PVD Brushed Bronze™	
086067	MT236/VB	Venetian Bronze™	

MT238 - Shower Grid

- All brass 4" diameter grid
- Fits "Plastic Oddities" shower drains
- Includes screws



Part #	Mfg #	Finish	Price
086369	MT238/BRN	Brushed Nickel	
095631	MT238/ORB	Oil Rubbed Bronze	
087911	MT238/VB	Venetian Bronze™	

MT245 - Shower Grid

- 4-1/4" Diameter brass
- Fits "Plastic Oddities" shower drains
- Includes screws



Part #	Mfg #	Finish	Price
098854	MT245/BRN	Brushed Nickel	
098855	MT245/ORB	Oil Rubbed Bronze	
098857	MT245/VB	Venetian Bronze™	

Tubular, Strainers, Bathwastes & Drains

*PVD Finish

www.plumbsupply.com • Serving our Customers Since 1946 • www.waterconcepts.net

Shower Drains

Residential Shower Drains

Solvent Weld Shower Module Drain (Screw-On 430 Stainless Steel Strainer)

- 1½" hub connection is also 2" spigot
- Do not use putty with plastic shower drains
- Available with brass inserts in top for machine screws or pilot holes for standard screws



Part #	Mfg #	Sch. 40 Hub	Size	Price
097548	825-2P	2"	4-1/4" x 2-5/8"	

No-Caulk Shower Module Drain with (Snap-In 430 Stainless Steel Strainer)

- **Brass Body**
—Body and locknut with elastomer no-caulk gasket
- **PVC Body**
—Body and locknut with elastomer no-caulk gasket
—Do not use putty with plastic shower drains



Cast Brass Body Drain

Part #	Mfg #	Sch. 40 Hub	Size	Price
030425	827-2B	2"	4-1/4" x 2-1/8"	

JackRabbit™ Jacking Bolt Shower Drain

- Perfect for replacement applications when workspace is restricted
- Brass body, locknut and pressure plate washer with elastomer no-caulk gasket



Part #	Mfg #	Sch. 40 Hub	Size	Price
089875	827-2J	2"	4-1/4" x 2-1/8"	

StreamLine™ Linear Shower Pan Drain with Slotted Strainer (2" Sch. 40 Hub Connection)

- Designed for use in "thin-bed" tile applications with a bonded waterproof membrane (ANSI A118.10)
- Provides a unique, contemporary appearance and functional design for shower areas
- Allows for the use of larger, floor-size tiles
- Perfect for use in residential applications for barrier-free or ADA showers, or along thresholds for overflow control
- All StreamLine™ drains include installation hardware, sealant and an illustrated instruction sheet
- Seamless, internally sloped, PVC body
- Clamping collar: stainless steel
- Strainer: stainless steel, brushed finish

Streamline™ Drain — Slotted Strainer

Part #	Mfg #	Length	Conn. Offset	Thickness	Price
183877	823-40PSS	40"	23-3/4"	1-1/2"	
183878	823-60PSS	60"	33-3/4"	1-1/2"	

Full Mortar Bed Kit — Slotted Strainer Only

Part #	Mfg #	Length	Price
183879	823-FK40	40"	
183880	823-FK60	60"	

Tubular Specialties

End Outlet Waste

- Telescopic 12" to 16" with baffle tee
- Universal slip joint with two direct connect adapters
- Wye "Y" branch connection - 1/2" or 3/4"



Part #	Mfg #	Connection	Color	Price
162117	253-550	Direct	White	

Tubular Strainers, Bathwastes & Drains

Shower Drains

Residential Drains

No-Calk® Shower Base Drain

- The original Caspers No-Calk® shower drain
- Designed for use with preformed shower bases; fiberglass, acrylic, nylon or metal
- Mechanically attaches over 2" Sch 40 DWV pipe
- The drain is fixed to the drain pipe from above the shower base
- Ideal for slab construction
- 4-1/4" Snap-in strainer
- Fiber and rubber gasket provides a tight seal to the base



Part #	Mfg #	Description	Price
015993	42150	2" NC Brass with SS Strainer	
015992	42099	2" NC PVC with SS Strainer	

101PS Series Solvent Weld Shower Base Drain

- Designed for use with preformed shower bases; fiberglass, acrylic, nylon or metal
- Solvent welds over 2" Sch 40 DWV pipe
- 4-1/4" Snap-in strainer
- Fiber and rubber gasket provides a tight seal to the base



Part #	Mfg #	Description	Price
092438	42097	2" PVC SW with SS Strainer	

101 Series Brass Drain

- Drain body is sealed to shower base with rubber gasket and fiber slip washer
- Universal 4-1/4" Snap-Tite strainer



Part #	Mfg #	Description	Price
097356	42073	2" NPT IPS w/Stainless Steel Strainer	

Drain Strainers

4-1/4" Square Snap-Tite Strainer

- For 130 series shower drains with square strainers

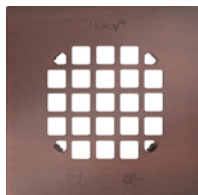

Part #	Mfg #	Description	Price
143009	46267	4-1/4" Rubbed Bronze, Carded	

4-1/4" Round Snap-Tite Strainer

- For 101BR, 101PNC, 101NPT, 101PS, 102, 103, 130, 131 and 140 NC series shower drains with round strainers
- UltraShine® PVD lifetime finish where noted



Part #	Mfg #	Description	Price
017048	42136	4-1/4" White Plastic	
016134	42137	4-1/4" PVD Pol Brass	
016135	42138	4-1/4" Stainless Steel	

Cleanouts

Snap-In Cleanout Assembly

- 4" PVC Snap-In



Part #	Mfg #	Size	Price
159789	43733	4" PVC Snap-In Cleanout	

No-Calk® Shower Drain Accessories

No-Calk® Drain Rubber Caulking Gasket

- For use with No-Calk® shower drains



Part #	Mfg #	Description	Price
031743	42156	2" Sch 40 Cast Iron Gasket	
189718	42163	1-1/2" Sch40 DWV Rubber Gasket	

No-Calk® Shower Drain Wrench

- Carded



Part #	Mfg #	Size	Price
171106	42239	Shower Drain Wrench	

Tubular, Strainers, Bathwastes & Drains

Sink Strainers

Decorator Parts

Decorator Plastic Strainer Assembly

- 3-1/2" Bowl



Part #	Mfg #	Color	Price
035834	9BC	Biscuit, Clamshell	
003410	9BNE	Bone, Clamshell	

Strainers

Threaded Body Sink Strainer

- Extra thick washer
- Extra wide locknut
- Heavy Duty SS strainer body and basket
- Metal post
- Body is chrome-plated



Part #	Mfg #	Description	Price
228628	10	Threaded Body	
003283	11	Rubber Stopper w/Chrome Plastic Post	
003292	16	Heavy Locknut. Rubber Stopper	
003295	17	Spin-N-Lock w/ Screw in Basket	

Locking Cup Sink Strainer

- Body is chrome-plated stainless steel
- Basket contains stainless steel stick post
- Locking cup included
- Neoprene rubber stopper



Part #	Mfg #	Description	Price
003290	14	2-3/4"L Snap-In Shallow Basket. Fits Deep Cast Iron Sinks	
228618	14T	Same as 14 w/ 4" Chrome Tailpiece	
003296	18	3-3/4"L Deep Locking Cup	

Lucky 7 Sink Basket Strainer

- Stainless Steel 4-prong basket
- Chrome plated brass body
- Metal post
- Rubber stopper
- Heavy locknut
- Extra thick washer
- Machine cut threads



Part #	Mfg #	Description	Price
003246	L7	Pro-Brite Strainer 3-1/2"	

Metal Bar Sink Strainer

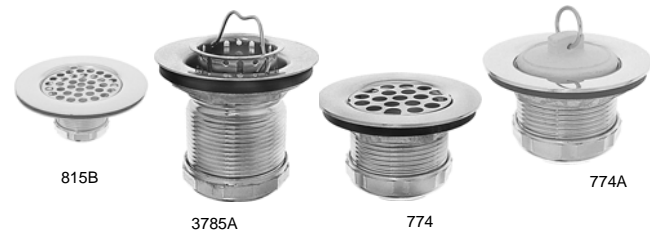

Part #	Mfg #	Description	Price
003402	815B	Flat Top Bar Strainer for 4" Opening, Brass Body/SS Strainer, 1-7/8"L	
003316	3785A	Standard Bar Sink Strainer, Brass Body/SS Cup, 2-1/8"L	
003364	774	Duplex Bar Strainer, Brass Body/Flat SS Strainer for 2-1/2" Opening	
051560	774A	Tray Plug Bar Strainer, Brass Body/Rubber Stopper for 2-1/2"	

Easy Mount Strainer

- Body and basket are stainless steel
- Brass nut included
- Triangular mounting flange



Part #	Mfg #	Size	Gauge	Price
228616	3BN	Thumbscrew Strainer w/ Brass Nuts		

Replacement Basket Strainer

- -3 Unfinished



Part #	Mfg #	Description	Price
032365	4201-3-3	Basket for 6, 10 & 16 Strainers	
003317	4201-17-3	Basket for 17 Strainer	
066336	4204-18-3	Basket for 18 Strainer	
016786	4201-L7-3	Basket for L7 Strainer	

Sink Strainers

Sink Strainers Drain & Strainer

- For 3-1/2" drain openings
- Conical strainer basket with rubber seal
- 1-1/2" O.D. x 4" tailpiece
-(LK35) has chrome plated tailpiece
- Stainless steel body with metal stem



LK-35

Part #	Mfg #	Description	Price
006119	LK35	Polished Finish	
051107	LK35B	Polished Finish	
006127	LK99	3-1/2"SS Drain Fitting w/ Conical Strainer, Push&Lock Metal Stem, Rubber Washer, Tailpiece	

Grid Sink Strainer

- Fits 3-1/2" opening
- Perforated 3" grid strainer
- 1-1/2" O.D. x4" tailpiece
- Polished finish



Part #	Mfg #	Description	Price
006111	LK18	Nickel Plated, Tailpiece	
160685	LKVR18	Nickel Plated, Tailpiece	
105236	LKVR18B	Stainless Steel, Tailpiece	

Sink Basket Strainers

- Polymer

Part #	Mfg #	Description	Price
172164	LKS35AS	Antique Steel	
148931	LKS35BK	Black	
156290	LKS35BQ	Bisque	
130522	LKS35MC	Mocha	
158338	LKS35WH	White	

Drain with Offset Tailpiece

- Brass tailpiece
- Strainer basket & rubber stopper
- ADA compliant



Part #	Mfg #	Description	Price
064418	LKAD35	Stainless Steel	

Stainless Steel Grid Sink Strainer with Lever Arm

- Chrome plated brass tailpiece
- Perforated grid and lever arm
- 4-1/8" O.D. top stainless steel flange with brass body



Part #	Mfg #	Description	Price
036219	LK24RT	Stainless Steel	

Lever Operated Sink Strainer

- Fits 3-1/2" opening
- 4-1/2" O.D. Stainless Steel flange with brass body
- Conical stainless steel strainer basket with flex stem and rubber stopper
- 1-1/2" O.D. x 4" chrome plated brass tailpiece



Part #	Mfg #	Description	Price
115555	LK27	Polished Finish, Tailpiece	

Adjustable P-Trap

- For 3-1/2" drain openings
- Cast iron
- 3" Iron pipe outlet with bronze cleanoutplug and floor support flange with adjustable nipple
- Chrome plated metal perforated grid strainer



Part #	Mfg #	Description	Price
087324	LK173	Polished Chrome	

Disposal Flanges

- Polymer
- Fits 3-1/2" drain opening



Part #	Mfg #	Description	Price
189175	LKD35AC	Antique Copper	
173269	LKD35AS	Antique Steel	
156286	LKD35BK	Black	
156288	LKD35BQ	Bisque	
145980	LKD35MC	Mocha	
158339	LKD35WH	White	

Tubular, Strainers, Bathwastes & Drains

Sink Strainers

Perfect Drain

Part #	Mfg #	Description	Price
169763	LKDS35	Fits Perfect Drain or InSinkErator®	
169762	LKPD1	Includes Tailpiece	

InSinkErator® Drain

Part #	Mfg #	Description	Price
171221	LKDS99	Chrome	

Lavatory Strainers

Lavatory Grid Strainer

- For 1-1/2" — 1-3/4" drain fittings
- Perforated drain
- 1-1/4" O.D. x 6" chrome plated brass tailpiece



Part #	Mfg #	Description	Price
095044	LK174LO	Chrome	
006110	LK174	Chrome	

Tubular, Strainers, Bathwastes & Drains

Sink Strainers

Strainers

Metal Finish Plastic Basket Strainer

- *Fit standard 3-1/2" sink drains*
- *Manufactured from Celcon®*



Part #	Mfg #	Description	Price
101358	JBC102	Black, Clamshell	



Sink Strainers

Sink Drains

Brass Duo Strainer

- Heavy duty forged brass construction
- 3-1/2" Diameter complete strainer
- Fits most kitchen sink brands
- Brass basket insert strainer included



Part #	Mfg #	Finish	Price
115897	2806-AB	Antique Brass	
115900	2806-BU	Bronze Umber	
115518	2806-MBK	Matte Black	
115898	2806-ORB	Oil Rubbed Bronze	
115895	2806-PCH	Polished Chrome	
115899	2806-PEW	Pewter	
133425	2806-PN	Polished Nickel	
126927	2806-SC	Satin Chrome	
141691	2806-SDB	Sedona Beige	
115896	2806-SN	Satin Nickel	
150102	2806-VB	Vintage Bronze	
145175	2806-WH	White	

Deep Cup Bar Sink Strainer

- 2-7/8" Diameter
- Brass strainer basket lifts out for easy cleaning
- Heavy-duty brass body
- Fits standard 2" drain opening



Part #	Mfg #	Finish	Price
115903	2826-AB	Antique Brass	
117563	2826-BKN	Black Nickel	
115906	2826-BU	Bronze Umber	
117564	2826-MBK	Matte Black	
115904	2826-ORB	Oil Rubbed Bronze	
115901	2826-PCH	Polished Chrome	
115905	2826-PEW	Pewter	
117566	2826-PN	Polished Nickel	
117562	2826-SC	Satin Chrome	
115902	2826-SN	Satin Nickel	
157722	2826-VB	Vintage Bronze	

Tubular, Strainers, Bathwastes & Drains

Sink Strainers

Kitchen Strainers

Duo Strainer

- Cast brass



Part #	Mfg #	Description	Price
183828	S1407BN	Brushed Nickel	
163090	S407WB	Old World Bronze	

Basket Strainer - Stainless Steel Flange & Basket

- Positive seal



Part #	Mfg #	Finish	Price
089789	B02-406	Oil Rubbed Bronze	
106384	B02-407	Old World Bronze	

Replacement Basket Strainer

- Fits part #B02401



Part #	Mfg #	Description	Price
190349	B0240BS	Brushed Stainless	

Bar Strainers

Deep Junior Duo Basket Strainer

- For 2" and 2-1/2" deep outlets
and bar sinks



Part #	Mfg #	Description	Price
189178	B02-102	Chrome Plated	

Sink Strainers

Sink Strainers

3-in-1 Basket Strainer

- Fits 3-1/2" drain opening
- Comes with lid to hold water in sink



Part #	Mfg #	Finish	Price
156487	441231	Stainless Steel	

Decorative Basket Waste Strainer

- Fits 3-1/2" inside diameter only



Part #	Mfg #	Finish	Price
132817	441091	White	
125840	441090	Anthracite	
125841	441092	Biscuit	
138426	441321	Biscotti	
125679	441094	Cafe Brown	
138425	441322	Truffle	
156803	441481	Cinder	

Decorative Sink Waste Flange

- Fits 3-1/2" drain opening
- Fits Insinkerator® disposals



Part #	Mfg #	Finish	Price
147699	441098	Satin Nickel	
132818	441096	White	
125842	441095	Anthracite	
125843	441097	Biscuit	
138428	441323	Biscotti	
125680	441099	Cafe Brown	
138427	441324	Truffle	
156804	441482	Cinder	

Decorative Basket Strainer

- Improved material
- Fits 3-1/2" inside diameter only
- Boxed packaging



Part #	Mfg #	Finish	Price
144843	441093	Satin Nickel	

Capflow

- Fits 3-1/2" drain
- Brushed finish
- Allows water to flow beneath when installed



Part #	Mfg #	Finish	Price
171572	517666	Brushed Finish	

3-in-1 Disposal Flange

- Fits 3-1/2" drain opening
- Comes with lid to hold water in sink



Part #	Mfg #	Finish	Price
150298	441232	Stainless Steel	

Tubular, Strainers, Bathwastes & Drains

Sink Strainers

Sink Strainers

Bar Sink Strainer for 2" Outlets with 4" Tailpiece

- Solid brass construction
- Duostrainer body with 1-1/2" connection

Part #	Mfg #	Description	Price
075781	K-8820-CP	Polished Chrome	

Duostrainer® Sink Strainer

- For sinks with 3-1/2" or 4" outlets
- 1-1/2" x 4" Tailpiece



Part #	Mfg #	Description	Price
054178	K-8801-BN	*Brushed Nickel	
075004	K-8801-BV	*Brushed Bronze	
053681	K-8801-CP	Polished Chrome	
056711	K-8801-G	Brushed Chrome	
053682	K-8801-PB	*Polished Brass	
053897	K-8801-SN	*Polished Nickel	
093259	K-8801-VS	*Stainless	
147015	K-8801-2BZ	Oil-Rubbed Bronze	

Duostrainer® Manual Sink Strainer Less Tailpiece

- For sinks with 3-1/2" or 4" outlets



Part #	Mfg #	Description	Price
228061	K-8799-CP	Polished Chrome	
064858	K-8799-BN	*Brushed Nickel	
156300	K-8799-VS	*Stainless	
143413	K-8799-PB	*Polished Brass	
093198	K-8799-BV	*Brushed Bronze	
147014	K-8799-2BZ	Oil-Rubbed Bronze	

Duostrainer® Manual Sink Basket Strainer



Part #	Mfg #	Description	Price
053683	K-8803-0	White	
113547	K-8803-47	Almond	
054835	K-8803-7	Black	
054181	K-8803-CP	Polished Chrome	

Sink Strainers (Continued)

Duostrainer® Manual Sink Basket Strainer

Part #	Mfg #	Description	Price
129123	K-8803-VS	*Stainless	
147017	K-8803-2BZ	Oil-Rubbed Bronze	

Duostrainer® Manual Body with Tailpiece

- For sinks with 3-1/2" or 4" outlet
- 1-1/2" connection and 4" tailpiece



Part #	Mfg #	Description	Price
053684	K-8804-0	White	
147018	K-8804-2BZ	Oil-Rubbed Bronze	
113565	K-8804-47	Almond	
054836	K-8804-7	Black	
054182	K-8804-CP	Polished Chrome	

Service Sink Strainer with Removable Grid Strainer

- Brass construction
- Tapped for 2" NPT connection



Part #	Mfg #	Description	Price
185548	K-9142-CP	Polished Chrome	

Sink Strainer with 4" Tailpiece

- Brass construction
- Fits sinks with standard 3-1/2" to 4" outlet
- Duostrainer body with 1-1/2-inch connection

Part #	Mfg #	Description	Price
163331	K-8807-BV	*Brushed Bronze	

Disposal Flanges

- Fits standard garbage disposal units (4-1/2" diameter., 1-5/8" depth)
- Includes disposal flange and stopper



Part #	Mfg #	Description	Price
085107	K-11352-BN	*Brushed Nickel	
117831	K-11352-BS	Brushed Stainless	
083621	K-11352-BV	*Brushed Bronze	
091715	K-11352-CP	Polished Chrome	

* Vibrant Limited Lifetime Warranty

www.plumbsupply.com • Serving our Customers Since 1946 • www.waterconcepts.net

Sink Strainers

Disposal Flanges (Continued)

Part #	Mfg #	Description	Price
103207	K-11352-PB	*Polished Brass	
147004	K-11352-2BZ	Oil-Rubbed Bronze	

Tubular, Strainers, Bathwastes
& Drains

* Vibrant Limited Lifetime Warranty

www.waterconcepts.net • Serving our Customers Since 1946 • www.plumbsupply.com

Sink Strainers

Kitchen Sink Strainers

Deluxe Plastic Basket Strainer

- Xenoy plastic molded
- 3-1/2" Strainer with spring loaded center post
- EZ Install from above the sink



Part #	Mfg #	Finish	Price
086070	BWSTU/BL	Black	
077064	BWSTU/BT	Biscuit	
136409	BWSTU/ORB	Oil Rubbed Bronze	
086069	BWSTU/PW	Polar White	
135611	BWSTUG/MLB	Matte Lava Black	

Deluxe Basket Strainer with Metal Finish

- Stainless steel and ABS strainer
- 3-1/2" Strainer with spring loaded center post
- EZ Install from above the sink



Part #	Mfg #	Finish	Price
083059	MT300/BRN	Brushed Nickel	
065288	MT300/ORB	Oil Rubbed Bronze	
083058	MT300/BRS	Brushed Stainless	
083061	MT300/VB	Venetian Bronze™	
090813	MT300/PVDBB	PVD Brushed Bronze™	

*PVD Finish

www.plumbsupply.com • Serving our Customers Since 1946 • www.waterconcepts.net

Sink Strainers

Sink Strainers

Artesso™ Kitchen Sink Flange & Strainer

- Polypropylene drain housing
- Brass strainer and basket
- Top-mount flange installation for 3.5" sink openings
- 4-1/2" diameter brass flange
- 1-1/2" x 11-1/2" NPSM threads



Part #	Mfg #	Description	Price
222284	69050-BZ	Brushed Bronze*	
222283	69050-PC	Chrome	
222285	69050-PN	Polished Nickel*	
222286	69050-SS	Stainless*	

Artesso™ Bar Sink Flange & Strainer

- Brass strainer and basket
- Drop-in basket with lift handle
- 2-7/8" Diameter brass flange
- 1-1/2" x 11-1/2" NPSM threads



Part #	Mfg #	Description	Price
222287	69051-PC	Chrome	
222288	69051-SS	Stainless*	

Solna® Kitchen Sink Flange & Strainer

- Polypropylene drain housing
- Brass strainer and basket
- Top-mount flange installation for 3" sink openings
- 4-1/2" diameter brass flange



Part #	Mfg #	Finish	Price
091734	72010	Chrome	
155139	72010-AR	Arctic Stainless	
160782	72010-CZ	Champagne Bronze™	
165748	72010-PN	Polished Nickel*	
078096	72010-SS	Stainless*	

Tubular, Strainers, Bathwastes & Drains

* Brilliance® Anti-Tarnish Lifetime Finishes

www.waterconcepts.net • Serving our Customers Since 1946 • www.plumbsupply.com



Sink Strainers

Sink Strainers

Strainer



Part #	Mfg #	Description	Price
004800	91-292	Strainer, Chrome	

Tubular, Strainers, Bathwastes
& Drains

*Physical Vapor Deposition (PVD) Limited Lifetime Finish

www.plumbsupply.com • Serving our Customers Since 1946 • www.waterconcepts.net

Sink Strainers

Strainers

Metal Kitchen Strainer

- Two-piece strainer with metal trim and a plastic base



Part #	Mfg #	Description	Price
111112	JBC111	Brushed Nickel, Clamshell	

Celcon Kitchen Strainer

- Two-piece strainer with Celcon trim and a plastic base
- Resistant to chipping, scratching and peeling



Part #	Mfg #	Description	Price
101239	JBC101	White, Clamshell	
101240	JBC103	Biscuit, Clamshell	

Matte Celcon Kitchen Strainer

- Two-piece strainer with Celcon trim and a plastic base
- Resistant to chipping, scratching and peeling
- Fits 3-1/2" openings



Part #	Mfg #	Description	Price
101241	JBC112	Matte Oil Rubbed Bronze, Clamshell	

Tubular, Strainers, Bathwastes & Drains

Sink Strainers

Sink Strainers
EZ ON Basket Strainer



Part #	Mfg #	Description	Price
137003	21901	Satin SS Finish	

*Tubular, Strainers, Bathwastes
& Drains*

Sink Wastes

Brass Center Outlet Wastes

Hi-Line Center Outlet Waste

- -1 Polished chrome



Part #	Mfg #	Size	Gauge	Price
003287	123A-1	1-1/2" x 16"	20ga	

Brass Waste Arms

Hi-Line Waste Arm

- -1 Polished chrome



Part #	Mfg #	Size	Gauge	For	Price
003289	138C-1	1-1/2" x 15"	20ga	16" EO	

Slip-Joint Waste Arm

- -1 Polished chrome



Part #	Mfg #	Size	Gauge	For	Price
003288	137C-1	1-1/2" x 15"	20ga	16" EO	

Brass End Outlet Wastes

Slip-Joint End Outlet Waste

- -1 Polished chrome



Part #	Mfg #	Size	Gauge	Price
003282	108A-1	1-1/2" x 16"	20ga	
187184	78A-17BN-1	1-1/2" x 16"	17ga	

Hi-Line End Outlet Waste

- -1 Polished chrome



Part #	Mfg #	Size	Gauge	Price
003299	2121A-1	1-1/2" x 16"	Budget	
003286	121A-1	1-1/2" x 16"	20ga	
025852	131A-1	1-1/2" x 16"	17ga	

Plastic Bath Wastes & Baffle Tees

Slip-Joint Plastic End Outlet Waste with Baffle Tee



Part #	Mfg #	Size	Slip Joint	Price
003251	P9108A	1-1/2" x 16"	PVC	

Plastic Hi-Line/Slip-Joint Combination End Outlet Waste with Telescopic Waste Arm



Part #	Mfg #	Size	Slip Joint	Price
036821	P9108AT	1-1/2" x 11-17"	PVC	
072524	P9121AT	1-1/2" x 11-17"	PVC	
086625	P9121T	1-1/2" x 21"	PVC	

Plastic Hi-Line Direct Connect End Outlet Waste with Baffle Tee



Part #	Mfg #	Size	Description	Price
046759	P9121	1-1/2" x 16"	PVC	

Plastic Hi-Line/Slip Joint Combination End Outlet Waste with Baffle Tee



Part #	Mfg #	Size	Description	Price
003252	P9121A	1-1/2" x 16"	PVC	

Slip-Joint Center Outlet Waste with Baffle Tee



Part #	Mfg #	Size	Description	Price
003253	P9123A	1-1/2" x 16"	PVC Hi-Line	

Tubular, Strainers, Bathwastes & Drains

Sink Wastes

Baffle Tee



Part #	Mfg #	Size	Description	Price
124332	P9186	1-1/2"	PVC Ctr Outlet SJ	

Plastic Waste Arms

Slip-Joint Waste Arm



Part #	Mfg #	Size	Description	Price
003254	P9137C	1-1/2" x 15"	PVC	

Plastic Trap Offsets



Part #	Mfg #	Size	Description	Price
052365	P9046A	1-1/2"	PVC	

Brass Wall Tubes

- -1 Polished chrome



Part #	Mfg #	Size	Gauge	Price
133620	402B-17-1	1-1/2" x 15"	17ga	

Tubular, Strainers, Bathwastes & Drains



Sink Wastes

Sinkwaste

- Heavy pattern cast brass
- Brass plug
- Available chrome-plated or brass
- Brass or nickel pull ring

C-212 1" Sinkwaste

- Includes tailpiece, washers and nuts



Part #	Mfg #	Description	Weight	Price
008254	C-212BR	Brass Finish	20 lbs	

Tubular, Strainers, Bathwastes
& Drains

Tailpieces

Brass Flanged Strainer Tailpieces

Flanged Strainer Tailpiece

- D - Double flange
- -1 Polished chrome



Part #	Mfg #	Size	Gauge	Price
003389	7991	1-1/2" x 4"	Budget	
187186	799173	1-1/2" x 4"	17ga	
003390	8001	1-1/2" x 6"	Budget	
003392	801-1	1-1/2" x 8"	Budget	
003394	803-1	1-1/2" x 12"	Budget	
003396	803BD1	1-1/2" x 12"	Budget	
003397	803ED1	1-1/2" x 16"	Budget	
003391	800171	1-1/2" x 6"	17ga	
003398	803171	1-1/2" x 12"	17ga	

Brass Branch Tailpieces

1/2" Nom Swt Branch Tailpiece

- -1 Polished chrome



Part #	Mfg #	Size	Price
003399	812A1	1-1/2" x 6"	

Hose & Clamp Branch Tailpiece

- -1 Polished chrome
- Budget gauge



Part #	Mfg #	Size	Price
003401	814A1	1-1/2" x 6"	
166058	814B1	1-1/2" x 8"	

Hose & Clamp with Threaded Top

- -1 Polished chrome



Part #	Mfg #	Size	Price
026730	814TA1	1-1/2" x 6"	

Hose & Clamp Branch Tailpiece w/ Slip Joint Top

- 20 Gauge
- Brass nut (nit down)



Part #	Mfg #	Size	Gauge	Price
180252	817ETBN1	1-1/4" x 8"		

Trap Primer Tailpieces



Part #	Mfg #	Size	Gauge	Price
135175	8311	1-1/4"	17ga	

Plastic Branch Tailpieces

Slip Joint Top

- Polypropylene construction
- Compatible with soft plastic pipe
- Connects a dishwasher to a plumbing drainage system
- Slip joint nut and washer for connection

PP9817



Part #	Mfg #	Top Size	Branch Size	Price
003274	PP9816	1-1/2" x 8"	1/2"	
167657	PP9817	1-1/2" x 8"	3/4"	
088799	PP9818	1-1/2" x 8"	1/2" Hi-Line	

Tubular, Strainers, Bathwastes & Drains

Tailpieces

Plastic Strainer Tailpieces



Part #	Mfg #	Size	Description	Price
228606	P9799	1-1/2" x 4"	PVC	
003271	P9800	1-1/2" x 6"	PVC	
228607	P9801	1-1/2" x 8"	PVC	
003272	P9803	1-1/2" x 12"	PVC	
003273	P9803E	1-1/2" x 16"	PVC Dbl Flg	

*Tubular, Strainers, Bathwastes
& Drains*

Tailpieces

Tubular Brass

Long Branch™ Dishwasher Tailpiece

- Downward inlet eliminates splash-up
 - No connector kits needed
 - Long 1/2" nominal copper branch provides work space for easy sweat or hose clamp connection
 - Quality 22-gauge copper and brass construction
- Direct Connection - Unfinished - Solid Brass Nut**



200-064

Part #	Mfg #	Size	Price
123798	200-084	1-1/2" x 8"	

Slip Joint - Unfinished - Solid Brass Nut

Part #	Mfg #	Size	Price
123800	206-084	1-1/2" x 8"	

TrapEase™ Trap Primer Tailpiece—Fine Thread

- Gravity feed, no mechanical parts
- Replenishes water in floor drain traps to prevent the escape of sewer gases
- 1/2" nominal branch connection
- Certified by the American Society of Sanitary Engineering to ASSE 1044
- Eco-friendly means of trap priming
- UPC/IAPMO listed



Part #	Mfg #	Size	Finish	Price
152234	213-092	1-1/4" x 6"	Chrome	

Tubular, Strainers, Bathwastes & Drains



Washers, Nuts & Stoppers

Sink Washers

Sink Strainer Coupling Washer



Part #	Mfg #	Description	Price
006248	852	1-1/2"	
006249	853	1-1/2" Flanged	

Slip Joint Washer



Part #	Mfg #	Description	Price
118268	721A	1-1/2" Molded TPR	
006232	762	1-1/4" Polyethylene	
006233	763	1-1/2" Polyethylene	

Gray Cut Slip Joint Washer

• Box of 100



Part #	Mfg #	Description	Price
006227	711	1-1/4" M	
006228	712	1-1/2" M S/C	
006229	713	2" M S/C	
006230	751	1-1/4"H	
006231	760	1-1/2" x 1-1/4"	

Waste and Overflow Washer

• Box of 25



Part #	Mfg #	Description	Price
006225	675	2-1/8" x 3-3/16", Thickness Tapered from 9/16" to 3/16", Beveled Sponge	
006226	677	1-11/16" x 2-3/4" x 3/32", Flat Rubber	

Tubular, Strainers, Bathwastes & Drains

Washers, Nuts & Stoppers

Plastic Nuts & Washers

Slip-Joint Nut



P9001

Part #	Mfg #	Size	Description	Price
031398	P9001A	1-1/4"	PVC	
003249	P9001	1-1/2"	PVC	

Slip-Joint Washer



Part #	Mfg #	Size	Description	Price
003412	9002	1-1/2" x 1-1/2"	Poly	
176601	9002A	1-1/4" x 1-1/4"	Poly	
003413	9003	1-1/2" x 1-1/4"	Poly	

Sink Strainer Replacement Washer



Part #	Mfg #	Size	Gauge	Price
228726	4202-2-3	Washer for 815B		

Toilet Repair Parts

Slip-Joint Washer

Part #	Mfg #	Description	Qty	Price
025958	7202	1-1/4" Rubber SJ	100	
020208	7203	1-1/2" Rubber SJ	100	

Slip Nuts - Die Cast



Part #	Mfg #	Size	Price
003208	8030	1-1/4"	
003209	8031	1-1/2" x 1-1/4"	
003211	8033	1-1/2"	
003212	8034	2"	

Tubular, Strainers, Bathwastes & Drains

Washers, Nuts & Stoppers

Nuts & Washers

Die Cast Slip Joint Nut



Part #	Mfg #	Size	Finish	Price
008041	1330C	1-1/4"	Chrome	
008043	1333C	1-1/2"	Chrome	

Brass Slip Joint Nut

Part #	Mfg #	Size	Finish	Price
017186	1336-C	1-1/4"	Chrome	
008045	1338-C	1-1/2"	Chrome	

Slip Joint Washer

- Square cut washers



Part #	Mfg #	Size	Price
008084	2209	1-1/4"	
008083	2208	1-1/2" x 1-1/4"	
008082	2204	1-1/2"	

Poly Washer for Tailpieces



Beveled

Part #	Mfg #	Size	Description	Price
113502	2219	1-1/4"	Beveled	
096353	2218	1-1/2" x 1-1/4"	Beveled	
096354	2214	1-1/2"	Beveled	

Tailpiece Washer

- Cloth inserted rubber



Part #	Mfg #	Size	Price
096352	2211	1-1/2" x 1-1/4"	

Tubular, Strainers, Bathwastes & Drains

Washers, Nuts & Stoppers

Poly Washers

Poly Beveled Slip-Joint Washer



Part #	Mfg #	Nut x Tube	Price
096451	T80-125	1-1/4" x 1-1/4"	
097344	T80-151	1-1/2" x 1-1/4"	

Flanged Poly Tailpiece Washer



Part #	Mfg #	Size	Price
077148	T81-150	1-1/2" x 1-1/2"	

Waste Connectors

MIP x SLIP Waste Connector

- Brass body ferrule and nut;
OD is copper tubular dimension
*T76-250 has a poly ferrule
- MIP units are combination female sweat



		MIP X OD	
169929	T76-150	1-1/2" x 1-1/2"	
169928	T76-151	1-1/2" x 1-1/4"	

Slip Joint Nuts

Slip Joint Nut

- Die Cast Zinc
- Multiple Sizes



Part #	Mfg #	Description	Price
169920	T77-125	1 1/4" X 1 1/4"	
169921	T77-150	1 1/2" x 1 1/2"	

Chrome Plated Brass Nut

- Chrome Plated Brass
- Multiple Sizes



Part #	Mfg #	Description	Price
169922	T78-125	1 1/4"x 1 1/4"	
169923	T78-150	1 1/2"x 1 1/2"	

Misc Nuts

Basin Cock Locknut

- Flanged or unflanged
- hex



Part #	Mfg #	Description	Price
170884	B10080	1/2" Basin Locknut	

Washers, Nuts & Stoppers

Washers

Drip-Free™ Washer

- Beveled design provides a better seal when used with standard slip nut
- Perfect washer for basket strainer installations
- Combo washers:
 - Rubber is thermoplastic
 - Reducing slip joint washer



290-20313

Slip Joint Washers

Part #	Mfg #	Size	Material	Color	Price
035392	290-20300	1-1/4"	Soft PVC	White	
035397	290-20310	1-1/2"	Soft PVC	Black	

Combo Washers

Part #	Mfg #	Size	Material	Price
035394	290-20312	1-1/2" x 1-1/4"	Rubber	
160363	290-20313	1-1/2" x 1-1/4"	Rubber	

Tailpiece Washer

Part #	Mfg #	Size	Material	Price
035395	290-20380	1-1/2"	Urethane	

Tailpiece and Slip Washer Job Pack

- Cloth-inserted C.I. rubber
- Slip washers are square cut

Part #	Mfg #	Size	Type	Material	Price
184091	990-20385	1-1/2"	TailpieceCI	Rubber	
184092	995-20320	1-1/4"	Slip	Rubber	
184093	995-20330	1-1/2"	Slip	Rubber	
184094	995-20335	1-1/2"x1-1/4"	Slip	Rubber	
184096	995-20340	2"	Slip	Rubber	

Beveled Slip Washer

- Polyethylene



996-6

Part #	Mfg #	Size	Price
184097	996-6	1-1/2" x 1-1/2"	
184099	996-8	1-1/2" x 1-1/4"	

Sammys™ Suspended Anchoring Systems

- Anchors for most common 3/8" all-thread rods
- Installs quickly and easily
- Vertical, horizontal or swivel applications
- Original American-made Sammy® super Screws
- UL & FM listed
- 3/8" Rod length



590-4411

Wood Applications

Part #	Mfg #	Type	Length	Price
183514	590-4411	GST20 Vertical	2"	
183518	590-4421	SWG20 Horizontal	2"	

Concrete Applications

Part #	Mfg #	Type	Length	Price
183516	590-4412	CST20 Vertical	1-1/4"	

Steel Beam Applications

Part #	Mfg #	Type	Length	Price
183517	590-4413	DST20 Vertical	1-1/4"	

Nut Driver for Anchors

- Vertical or horizontal anchors

Part #	Mfg #	Type	Color	Price
183519	590-44ND1	#14 Vertical	Black	
183520	590-44ND2	#14SW Horizontal	Red	

Tubular, Strainers, Bathwastes & Drains

Urinals

Vitreous China Urinals

Bardon™ High Efficiency Urinal

- Washout urinal
- 14" Extended rim
- 17" High rim from finished floor for ADA compliance
- Flowrate: .125 gpf to 1.0 gpf



Part #	Mfg #	Description	Color	Price
171241	K-4991-ER-0	ADA Urinal, 3/4" Rear Spud	White	
171242	K-4991-ET-0	ADA Urinal, 3/4" Top Spud	White	
229071	K-4991-ET-47	ADA Urinal, 3/4" Top Spud	Almond	
223381	K-4991-ET-7	ADA Urinal, 3/4" Top Spud	Black	
183294	K-4991-ET-96	ADA Urinal, 3/4" Top Spud	Biscuit	

Bardon™ Touchless™ Washdown Urinal

- 1/2" Rear spud
- Includes tank cover and tank cover locks
- Includes stainless steel, low-profile strainer for faster drain flow
- ADA-compliant when rim is mounted no higher than 17" from finished floor
- Battery-operated electronic flush valve powered by four AA alkaline batteries (included)
- Flowrate: 0.5 gpf



Part #	Mfg #	Description	Color	Price
230564	2590-0	ADA Urinal, 1/2" Rear Spud	White	

Branham™ Washout Floor-Mount Urinal

- Washout urinal
- 3/4" Top spud
- Flowrate: 1.0 gpf



Part #	Mfg #	Description	Rough-In	Color	Price
063730	K-4920-T-0	ADA Urinal, 3/4" Top Spud	White		
108602	K-4920-T-47	ADA Urinal, 3/4" Top Spud	Almond		
065589	K-4920-T-7	ADA Urinal, 3/4" Top Spud	Black		
076975	K-4920-T-96	ADA Urinal, 3/4" Top Spud	Biscuit		

*Vibrant Limited Lifetime Finish

www.plumbsupply.com • Serving our Customers Since 1946 • www.waterconcepts.net

Urinals

Darfield™ Urinal with 3/4" Top Spud

- Washout stall
- Includes
 - Strainer
 - Inlet and outlet 3/4" spuds
 - Bottom outlet for exposed p-trap
 - Hanger
 - 1-1/2" Tailpiece
- Flush valve sold separately
- 17" High mount from finished floor for ADA compliance
- Flow rate: 0.5 gpf to 1.0 gpf



Part #	Mfg #	Description	Color	Price
054421	K-5024-T-0	ADA Urinal, 3/4" Top Spud	White	
155471	K-5024-T-7	ADA Urinal, 3/4" Top Spud	Black	

Dexter™ 1.0 Urinal

- Siphon jet
- 14-1/2" Extended rim
- Includes:
 - Inlet and outlet 3/4" spuds
 - Hangers
 - Anti-backsplash wall
- 17" High mount from finished floor for ADA compliance
- Flow rate: 1.0 gpf



Part #	Mfg #	Description	Color	Price
078997	K-5016-ER-0	ADA Elongated Urinal, 3/4" Rear Spud	White	
167603	K-5016-ER-47	ADA Elongated Urinal, 3/4" Rear Spud	Almond	
053156	K-5016-ET-0	ADA Elongated Urinal, 3/4" Top Spud	White	
060306	K-5016-ET-47	ADA Elongated Urinal, 3/4" Top Spud	Almond	
080552	K-5016-ET-7	ADA Elongated Urinal, 3/4" Top Spud	Black	
060089	K-5016-ET-96	ADA Elongated Urinal, 3/4" Top Spud	Biscuit	

Touchless 0.5 gpf Hybrid Urinal Flushometer

- Fixture-mount design
- Wave technology
- Powered by one hybrid energy cell
- For use with wash-down, washout, and siphon jet installations with 3/4" top spud coupling connection

Part #	Mfg #	Description	Rough-In	Color	Price
232339	K-7526-CP	ADA			

*Vibrant Limited Lifetime Finish

www.waterconcepts.net • Serving our Customers Since 1946 • www.plumbsupply.com

Urinals

Freshman™ Space-Saving Wall-Mount 1.0 gpf Urinal

- Includes:
 - Inlet and outlet 3/4" spuds
 - Hangers
- 17" High mount from finished floor for ADA compliance
- Flow rate: 1.0 gpf



Part #	Mfg #	Description	Color	Price
053155	K-4989-T-0	Urinal, 3/4" Top Spud	White	
227860	K-4989-T-47	Urinal, 3/4" Top Spud	Almond	
098939	K-4989-T-96	Urinal, 3/4" Top Spud	Biscuit	
155688	K-4989-R-0	Urinal, 3/4" Rear Spud	White	
087957	K-4989-R-96	Urinal, 3/4" Rear Spud	Biscuit	
160298	K-8989-T-G9	Urinal, 3/4" Top Spud	Sandbar	

Stanwell™ Lite Elongated 1.0 Urinal

- Blow-out urinal
- Includes:
 - Inlet and outlet spuds
 - Hangers
 - 1-1/4" Top spud
- 17" High mount from finished floor for ADA compliance
- Flow rate: 1.0 gpf



Part #	Mfg #	Description	Color	Price
129912	K-4972-ER-0	ADA Urinal, 1-1/4" Raer Spud	White	
115511	K-4972-ET-0	ADA Urinal, 1-1/4" Top Spud	White	
115512	K-4972-ET-96	ADA Urinal, 1-1/4" Top Spud	Biscuit	

Steward® Hybrid High-Efficiency Urinal

- Washout
- 3/4" Top spud
- Ultra low consumption is WaterSense® certified product: .125 gpf
- 15-5/8" Extended rim allows for ADA installation
- Funnel design eliminates splash back
- Flow rate: .125 gpf



Part #	Mfg #	Description	Rough-In	Color	Price
167721	K-5244-ET-0	ADA Urinal, 3/4" Top Spud	White		
168593	K-5244-ET-96	ADA Urinal, 3/4" Top Spud	Biscuit		
183577	k-5244-ER-0	ADA Urinal, 3/4" Top Spud	White		

*Vibrant Limited Lifetime Finish

www.plumbsupply.com • Serving our Customers Since 1946 • www.waterconcepts.net

Urinals

Steward® Waterless Urinal

- 11" wide x 23-3/4" high x 14-3/4" deep
- Vitreous china
- 14-3/4" Extended rim
- Cartridge-free integral trapway
- Touch-free design
- Includes:
 - Removable strainer
 - Universal mounting bracket
 - 2" Rear outlet spud
 - Hangers
 - Sample bottles of waterless urinal sealing liquid and cleaner



Part #	Mfg #	Description	Rough-In	Color	Price
098279	K-4917-0	ADA Urinal, 2" Rear Spud		White	

Strainers

Stainless Steel Beehive Grate Urinal Strainer

- For vitreous china urinal stall
- For caulking 2" iron pipe or soldering 2" lead pipe
- Solid brass construction



		Description	
065590	K-9183-NA	NA	

China Grate Urinal Strainer

- For vitreous china urinal stall
- For caulking 2" iron pipe or 2" lead pipe
- Brass construction



		Description	
070972	K-9172-NA	NA	



Urinals

Urinals

Clinton 1.0 Urinal

- Dimensions: 21-3/4"H x 14-1/4"W x 14-3/8"D
- Minimum wall space
- Dual hangers
- 2" SPS Female outlet connection supplied
- Siphon-jet
- Flush valve sold separately
- Limited lifetime warranty



Part #	Mfg #	Description	Color	Price
004652	27-750	3/4" Top Spud	White	

Hamilton 1.0 Urinal

- Dimensions: 26-1/2"H x 18"W x 14-1/2"D
- Half stall size
- Integral flush spreader
- Extended shields
- Dual hangers
- 2" SPS Female outlet connection supplied
- Siphon-jet
- Flush valve sold separately
- Limited lifetime warranty



Part #	Mfg #	Description	Color	Price
004653	27-770	3/4" Top Spud	White	

Lafayette Washout 1.0 Urinal

- Dimensions: 18-1/2" x 13-1/2" x 13-3/4"
- Wall hung
- One-piece hanger
- Minimum wall space
- Integral strainer
- 1-1/2" x 1-1/2" Outlet spud for flushometer
- Flush valve sold separately
- Limited lifetime warranty



Part #	Mfg #	Description	Color	Price
004651	27-740	3/4" Top Spud	White	

Urinals



Urinals

Monitor Washout 1.0 Urinal

- Dimensions: 26-3/4"H x 18-1/2"W x 12-1/2"D
- Wall hung
- Commercial size
- Integral flush spreader
- Extended shields
- Dual hangers
- 2" SPS Female outlet connection supplied
- Flush valve sold separately
- Limited lifetime warranty



Part #	Mfg #	Description	Color	Price
004654	27-780	3/4" Top Spud	White	

North Point™ 0.5gpf Urinal

- Dimensions: 21-7/8"H x 14-1/4"W x 13-5/8"D
- Wall hung, space saving design
- Washout flush action
- 3/4" Inlet top spud for exposed flushometer
- Outlet connection threaded 2" inside
- Dual wall hangers



Part #	Mfg #	Description	Color	Price
156368	HE-27-720	3/4" Top spud, HET	White	

Urinals

WES Waterfree Wall-Hung Urinals

- Touch-free operation
- Uses no water
- Patented, sealed locking cartridge
- Smooth, non-porous surfaces
- Reduced water and sewer costs
- Water supply piping not required
- Odor-free
- Vandal resistant
- Requires minimal maintenance
- 1-Piece Wall hanger bracket with anchors included



Part #	Mfg #	Model	Description	Price
080390	1001000	WES-1000	19-1/4" x 14-3/8" x 26-1/4"	

WES Waterfree Urinal Cartridge Kit

- Cartridge is made from recyclable ABS
- Includes:
 - 100% Biodegradable sealant liquid
 - Cartridge installation/removal tool
 - Protective glove
 - Disposal bag



Part #	Mfg #	Model	Description	Price
080533	1001500	WES-150	6,000 to 7,000 Use Urinal Cartridge Kit	

Urinals

Urinals

Urinals Adam™ Urinal

- Washdown urinal
- 0.5 Gpf / 1.9 Lpf
- 13-5/8" x 19-1/2" x 13-1/4"
- Exposed trap
- Includes 3/4" top spud and hanger
- Inlet : 3/4"
- Outlet : 1-1/2"



Part #	Mfg #	Description	Color	Price
216560	401HE-WH	Urinal, 3/4" Top Spud	White	
198610	401HE-BI	Urinal, 3/4" Top Spud	Biscuit	

Cascade™ Urinal

- Half-stall, wall-mount, wash-down urinal
- 0.5 Gpf / 1.9 Lpf (also works with 1.0 Gpf flushometers)
- Integral trapway
- Complies with ADA requirements for accessibility
- WaterSense compliant
- Inlet: 3/4"
- Outlet: 2"



Part #	Mfg #	Description	Color	Price
197500	410HE-WH	ADA Urinal, 3/4" Top Spud	White	

Suburban™ Urinal

- Siphon jet urinal
- 0.5 Gpf / 1.9 Lpf
- High Efficiency Urinal (HEU)
- Integral trapway
- ADA compliant
- Concealed hanger and bolts
- Includes 3/4" top spud and hangers
- Inlet : 3/4"
- Outlet : 2"



Part #	Mfg #	Description	Color	Price
192334	475HE-WH	ADA Urinal, 3/4" Top Spud	White	

Urinals

Urinals

Urinal Flanges

Horizontal Adjustable Urinal Flange Kits

- Horizontal mounting slots accommodate urinals with 3-1/2" to 7" mount centers
- Kit includes all bolts, nuts, washers and gaskets
- The flange fits over 2" Sch 40 DWV pipe (Prod. No. 43540 and 43541)
- The flange solvent welds into any 2" fitting (Prod. No. 43542 and 43543)



Part #	Mfg #	Description	Price
041349	43541	2" PVC Urinal Flange Kit	
156925	43543	2" PVC Spigot Urinal Flange Kit	

Urinals

Urinal Flanges

Urinal Flanges

Adjustable Kit

- Fits over 2" Sch 40 DWV pipe
- Include:
 - Bolts
 - Nuts
 - Washers
 - Gasket
- 3-1/4" - 7" Flange mounting centers



Part #	Mfg #	Description	Price
056150	F10-001	2" PVC Spigot	
042007	F10-002	2" PVC Socket	

Urinal Drain Flange Kits

- Includes all necessary hardware



Part #	Mfg #	Size	Price
093777	F10-005	2" IPS x 4-1/4"	

Backflow Valves

Backflow Preventers

Repair Kit for Series 007

1-1/4" Repair Kit for 007

Part #	Mfg #	Model	Description	Price
132315	0887721	RK007M2RT	Complete Rubber	
051397	0062616	007M2-QT	1-1/2"	

Repair Kit for Series 009

Part #	Mfg #	Model	Part	Price
023137	0886020	RK009LUBE	Mechanical Lubricant	

1/4" to 1/2" Repair Kit for Series 009

Part #	Mfg #	Model	Part	Price
023139	0887291	RK009CK1	1st Chk	
023140	0887292	RK009CK2	2nd Chk	
023141	0887294	RK009VT	Total Relief	
023138	0887297	RK009RT	Total Rubber	

3/4" Repair Kit for Series 009

Part #	Mfg #	Model	Part	Price
023142	0887000	RK009M2CK1	1st Chk Kit	
023143	0887001	RK009M2CK2	2nd Chk Kit	
010828	0887002	RK009M2VT	Total Relief	
010826	0886999	RK009M2RT	Total Rubber	
040703	0888520	RK009M3CK1	1st Chk Kit	
040702	0888521	RK009M3CK2	2nd Chk Kit	
040704	0888524	RK009M3VT	Total Relief	
040705	0888526	RK009M3RT	Total Rubber	
058395	1047394	99BA47	Retainer	

3/4" to 1" Repair Kit for Series 009

Part #	Mfg #	Model	Part	Price
023144	0887005	RK009CK1	1st Chk Kit	
023145	0887007	RK009CK2	2nd Chk Kit	
108062	0887009	RK009CK1SS	1st Chk Kit	
108083	0887011	RK009CK2SS	2nd Chk Kit	
010833	0887015	RK009VT	Total Relief	
010830	0887017	RK009RC1	1st Chk Rbr	
010832	0887182	RK009RT	Total Rubber	

1" Repair Kit for Series 009

Part #	Mfg #	Model	Part	Price
064125	0887789	RK009M2CK1	1st Chk Kit	
064126	0887790	RK009M2CK2	2nd Chk Kit	

Backflow Preventers (Continued)

Repair Kit for Series 009

1" Repair Kit for Series 009

Part #	Mfg #	Model	Part	Price
040707	0887785	RK009M2VT	Total Relief	
040708	0887787	RK009M2RT	Total Rubber	

1-1/4" to 2" Repair Kit for Series 009

Part #	Mfg #	Model	Part	Price
030210	0887006	RK009CK1	1st Chk Kit	
030211	0887008	RK009CK2	2nd Chk Kit	
108085	0887010	RK009CK1SS	1st Chk Kit	
108088	0887012	RK009CK2SS	2nd Chk Kit	
029025	0887016	RK009VT	Total Relief	
023130	0887185	RK009RT	Total Rubber	
023148	0887270	RK009M1CK1	1st Chk Kit	
023149	0887271	RK009M1CK2	2nd Chk Kit	
108086	0887272	RK009M1CK1SS	1st Chk Kit	
108089	0887273	RK009M1CK2SS	2nd Chk Kit	
023131	0887280	RK009M1RT	Total Rubber	
023147	0887301	RK009M2CK2	2nd Chk Kit	
010829	0887307	RK009M2VT	Total Relief	
010827	0887309	RK009M2RT	Total Rubber	
023146	0887300	RK009M2CK1	1st Chk Kit	

2" Repair Kit for Series 009

Part #	Mfg #	Model	Part	Price
042500	0887540	RK009M2CK1	1st Chk Kit	
042501	0887541	RK009M2CK2	2nd Chk Kit	
042502	0887545	RK009M2VT	Total Relief	
030216	0887547	RK009M2RT	Total Rubber	

2-1/2" to 3" Repair Kit for Series 009

Part #	Mfg #	Model	Part	Price
156943	0794054	LFRK009CK1	1st Chk Kit	
156944	0794055	LFRK009CK2	2nd Chk Kit	
156945	0794052	LFRK009VT	Total Relief	
156953	0794053	LFRK009RV	Rubber Parts	
156955	0794056	LFRK009RT	Total Rubber	

1/4" to 3/4" Repair Kit for Series SS009

Part #	Mfg #	Model	Part	Price
108082	0887516	RKSS009M2/M3CK2	2nd Chk Kit	

Backflow Valves

Valves

1/2" Repair Kit for Series SS009

Part #	Mfg #	Model	Part	Price
108060	0887505	RKSS009CK1	1st Chk Kit	
108081	0887506	RKSS009CK2	2nd Chk Kit	

3/4" Repair Kit for Series SS009

Part #	Mfg #	Model	Part	Price
108061	0887515	RKSS009M2CK1	1st Chk Kit	

1" Repair Kit for Series SS009

Part #	Mfg #	Model	Part	Price
108065	0887525	RKSS009CK1	1st Chk Kit	
108084	0887526	RKSS009CK2	2nd Chk Kit	

Repair Kit for Series 188A/288A/388A

Part #	Mfg #	Model	Size	Price
029503	0887172	RK188A/288A/388T	3/4" - 1"	
079610	0887171	RK188A/288A	1/2"	

**909 Series RPZ Backflow Preventer - Cast Iron
Sizes 2-1/2" - 10"**

- Unique patented "air-in/water-out" design
- Body construction of fused epoxy-coated cast iron
- Replaceable bronze seat
- Captured spring assemblies
- Furnished with non-rising stem (NRS) resilient seated gate valve shut-offs
- Temperature range: 33° - 110°F continuous, 140°F intermittent
- Maximum working pressure: 175 psi
- Suffix Options:
 - NRS = Non-rising stem resilient seated gate valves



Shown w/Strainer

Part #	Mfg #	Model	Size	Option	Price
011331	0387184	909NRS	4"	NRS	

Repair Kits for Series 909

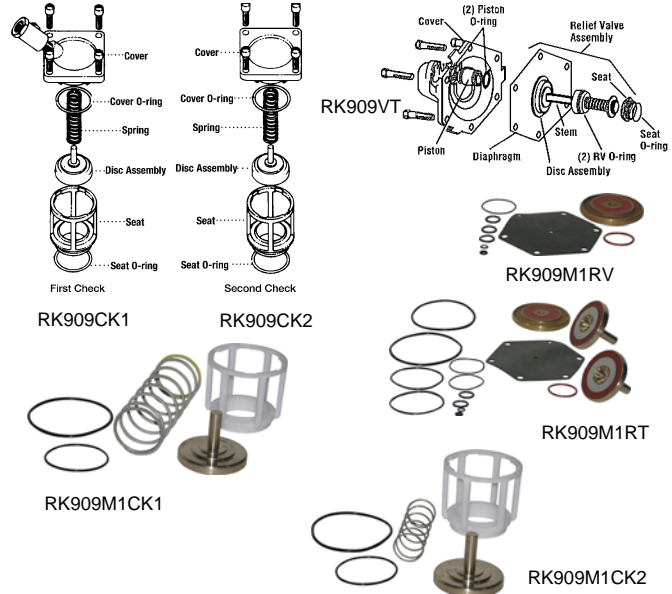

3/4" to 1" Repair Kit for Series 909

Part #	Mfg #	Model	Part	Price
023154	0887120	RK909CK1	1st Chk	
023155	0887121	RK909CK2	2nd Chk	
030214	0887122	RK909CK1SS	1st Chk	
030215	0887123	RK909CK2SS	2nd Chk	

3/4" to 1" Repair Kit for Series LF909

Part #	Mfg #	Model	Part	Price
156946	0794059	LFRK909VT	Total Relief	
156947	WTLFRK909RT341	LFRK909RT	Complete Rubber	

1-1/4" to 2" Repair Kit for Series LF909

Part #	Mfg #	Model	Part	Price
164646	0794063	LFRK909M1CK1	1st Chk	
160605	0794064	LFRK909M1CK2	2nd Chk	
159040	0794060	LFRK909M1VT	Total Relief	

2-1/2" to 3" Repair Kit for Series LF909

- LF Prefix: lead free

Part #	Mfg #	Model	Part	Price
156957	0794101	LFRK909CK2	2nd Chk Kit	
156963	0794081	LFRK909RV	Rubber Parts	
156965	0794085	LFRK909VT	Total Relief	
163699	0794089	LFRK909RT	Complete Rubber	

Backflow Valves

4" Repair Kit for Series LF909

Part #	Mfg #	Model	Part	Price
156967	0794090	LFRK909RT	Complete Rubber	
156960	0794102	LFRK909CK2	2nd Chk Kit	

4" & 6" Repair Kit for Series LF909

Part #	Mfg #	Model	Part	Price
156964	0794082	LFRK909RV	Rubber Parts	
156966	0794086	LFRK909VT	Total Relief	

6" Repair Kit for Series LF909

Part #	Mfg #	Model	Part	Price
156968	0794091	LFRK909RT	Complete Rubber	
156959	0794098	LFRK909CK1	1st Chk Kit	
156961	0794103	LFRK909CK2	2nd Chk Kit	

Hose Assembly for Series 909

Part #	Mfg #	Model	Size	Price
139960	0881487	AK909	6" to 8"	

Repair Kits for Series LF919

3/4" - 1" Repair Kit for Series LF919

Part #	Mfg #	Model	Size	Price
132377	0888136	RK919RV	Rubber Parts	
132385	0888142	RK919RT	Complete Rubber Parts Kit	

757, 757N Series Double Check Valve Assembly

- Extremely compact design
- 70% Lighter than traditional designs
- 304 (Schedule 40) Stainless steel housing & sleeve
- Groove fittings allow integral pipeline adjustment
- Patented tri-link check provides lowest pressure loss
- Replaceable check disc rubber



OSY- UL/FM outside stem and yoke, resilient seated gate valves

BFG-UL/FM grooved gear operated butterfly valves with tamper switch

Part #	Mfg #	Model	Size	Price
109090	757-BFG	0111534	2-1/2"	
109092	757-BFG	0111536	4"	
109093	757-BFG	0111537	6"	

Backflow Preventers (Continued)

757, 757N Series Double Check Valve Assembly

Part #	Mfg #	Model	Size	Price
109095	757-OSY	0111511	3"	
109096	757-OSY	0111513	6"	

SilverEagle™ 957 Series RPZ Reduced Pressure Zone Assembly

- Compact design
- 70% Lighter than traditional designs
- 304 (Sch 40) stainless steel housing and sleeve
- Groove fittings allow integral pipeline adjustment
- Patented torsion spring checks provides lowest pressure loss
- Unmatched ease of serviceability
- Available with grooved butterfly valve shutoffs
- May be used for horizontal, vertical, N pattern or Z pattern installations
- Bottom mounted cast stainless steel relief valve
- Replaceable check disc rubber
- Temperature range: 33° - 110°F
- Maximum working pressure: 175 psi
- Suffix Options:
 - NRS = Non-rising stem resilient seated gate valves
 - OSY = UL/FM outside stem and yoke resilient seated gate valves

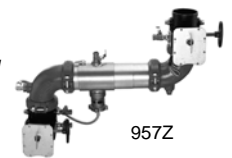

Part #	Mfg #	Model	Size	Option	Price
071743	0111602	957NRS	2-1/2"	NRS	
071505	0111603	957NRS	3"	NRS	
071744	0111604	957NRS	4"	NRS	
088845	0111585	957OSY	3"	OSY	
081866	0111586	957OSY	4"	OSY	

Repair Kit for 957

1st Check Kit

Part #	Mfg #	Model	Size	Price
093258	7018129	RK957/957RPDA-CK1	2-1/2" - 4"	

2nd Check Kit

Part #	Mfg #	Model	Size	Price
093256	0899216	RK957/957RPDA-CK2	2-1/2" - 4"	

Backflow Valves

Complete Rubber Parts Kit

Part #	Mfg #	Model	Size	Price
082509	0899245	RK957/957RPDA-RT	6"	

Total Relief Valve Kit

Part #	Mfg #	Model	Size	Price
094158	0899232	RK957/957RPDA-VT	2-1/2" - 10"	

LF007 Double Check Valve Assembly

- Ease of maintenance — only one cover
- Replaceable seats and seat discs
- Modular construction
- Compact design
- Lead Free* cast copper silicon alloy body construction — 1/2" – 2" (15 – 50mm)
- Fused epoxy coated cast iron body — 2 1/2" – 3" (65 – 80mm)
- Top mounted Lead Free* ball valve test cocks
- Low pressure drop
- No special tools required for servicing
- 1/2" – 1" (15 – 25mm) have tee handles



Part #	Mfg #	Model	Size	Price
157033	0063230	LF007-QT	1/2"	
157133	0063232	LF007M1-QT	1"	
157150	0063234	LF007M2-QT	1-1/2"	
157140	0063235	LF007M1-QT	2"	
160050	0063231	LF007M3-QT	3/4"	
159331	0122593	LF007M3-QTS	3/4"	

LF009 Reduced Pressure Zone Assembly

- Single access cover and modular check construction for ease of maintenance
- Top entry - all internals immediately accessible
- Internal relief valve
- Replaceable seats for economical repair
- Lead Free* cast copper silicon alloy body construction for durability
- 1/4" – 2" (8 – 50mm)
- Fused epoxy coated cast iron body 2 -1/2" and 3" (65 and 80mm)
- Ball valve test cocks — screwdriver slotted 1/4" – 2" (8 – 50mm)
- Large body passages provides low pressure drop
- Compact, space saving design



Part #	Mfg #	Model	Size	Price
157132	0122605	LF009-QT-S	3/8"	
157032	0122695	LF009-QT-S	1/2"	
157162	0122693	LF009M2-QT-S	1"	
157158	0122688	LF009M2-QT-S	1-1/4"	
157159	0122689	LF009M2-QT-S	1-1/2"	
157160	0122692	LF009M2-QT-S	2"	
157163	0122695	LF009M3-QT-S	3/4"	
157136	0122612	LF009-NRS	2-1/2"	
157137	0122613	LF009-NRS	3"	
157141	0122646	LF009-NRS-S-FDA2-1/2"		
157148	0122654	LF009-NRS-S-FDA3"		

LF909 Reduced Pressure Zone Assembly

- Modular design
- Replaceable seats
- Compact for installation ease
- Horizontal or vertical (up or down) installation



Part #	Mfg #	Model	Size	Price
168773	0122776	LF909-OSY	3"	
157173	0122773	LF909-NRS	2-1/2"	
157199	0391015	LF909-NRS	3"	
157202	0122797	LF909-NRS	4"	
157168	0122758	LF909M1-NRS	8"	
157316	0122771	LF909-QT-S-HW	3/4"	
157317	0122772	LF909-QT-S-HW	1"	
157174	0122774	LF909-QT-S	3/4"	
157175	0122775	LF909-QT-S	1"	
157169	0122765	LF909M1-QT-S	1-1/4"	
157170	0122766	LF909M1-QT-S	1-1/2"	

Backflow Valves

Backflow Preventers (Continued)

LF909 Reduced Pressure Zone Assembly

Part #	Mfg #	Model	Size	Price
157171	0122767	LF909M1-QT-S	2"	
157209	0122805	LF909NRSSFDA	3"	
157210	0122798	LF909NRSSFDA	6"	
157207	0122801	LF909NRSSFDA	4"	
157208	0122804	LF909NRSSFDA	2-1/2"	

LF919 Reduced Pressure Zone Assembly

- Top entry
- All rubber elastomers of chloramine resistant material
- Check valve poppet assemblies are fully guided by innovative plast seat guide
- Replaceable push-in check valve and relief valve seats eliminates threads from the water way
- EZ twist relief valve cover 1/4 turn locking joint captures the spring load during repair to facilitate disassembly



Part #	Mfg #	Model	Size	Price
157151	0065378	LF919-QT	3/4"	
157152	0065379	LF919-QT	1"	
157153	0065380	LF919-QT	1-1/4"	
157154	0065381	LF919-QT	1-1/2"	
157155	0065382	LF919-QT	2"	

LF7R Brass Dual Check Valve

- Can be installed vertically or horizontally
- Available with combination of inlet/outlet sizes, types or thread and end connection



Part #	Mfg #	Model	Size	Price
157028	0072203	LF7RU2	1/2"	
157164	0072221	LF7RU2-U2	3/4"	
157165	0072224	LF7RU2-RU2	1"	

LF7 Dual Check Valves

- Can be installed vertically or horizontally
- Available with combination of inlet/outlet sizes, types or thread and end connection including retrofit compression fittings and hose connections
- Can be installed in many piping configurations and with a wide range of meter horns, copper setters and meter boxes



LF7(Cast Copper Silicon Alloy) Sizes: 1-1/4" (32mm)
LF7C(Chrome-Nickel Plated) Sizes: 3/8" (10mm)

Part #	Mfg #	Model	Size	Price
185857	LF7C	LF7C	3/8"	

LFH7C Dual Check Valve with Hose Connection



Part #	Mfg #	Model	Size	Price
173743	0792078	LFH7C	3/4"	

9D Series Dual Check Valve with Intermediate Atmospheric Vent Backflow Preventer

- Continuous pressure applications
- Maximum temperature: 250°F
- Maximum pressure: 175 psi
- Minimum pressure: 25 psi



Part #	Mfg #	Model	Size	Option	Price
011323	0061935	9DM3	1/2"	-	
011324	0061888	9DM2	3/4"	-	
074245	0061952	9DSM3	1/2"	-	

9BD Series Dual Check Vending Machine Backflow Preventer

- For vending machine water supply lines
- Complies with FDA food additive regulations
- Vented triple check protection
- Temperature range: 33° - 140°F
- Maximum working pressure: 150 psi



Part #	Mfg #	Model	Connection(s)	Price
011322	0061894	9BD	3/8" FCT	

Backflow Valves

7 Series Dual Check Backflow Preventer

- For use at the drinking water supply service entrance or with individual outlets
- For non-health hazard residential water system containment and continuous pressure applications
- Bronze body construction
- Uses two compact replaceable check modules
- Buna-N seals and stainless steel springs
- Can be installed vertically or horizontally
- Suffix Options:
 - C = Chrome nickel-plated finish



Part #	Mfg #	Model	Size	Connection	Price
104202	0061783	7U2-2	1/2"	FNPT	

SD2 Series Dual Check Valve for Carbonated Beverage Machines

- 316 Stainless steel body
- All rubber compounds comply with FDA food additive regulations
- Prevents the reverse flow of potentially contaminated water into the potable water supply due to back pressure backflow
- For continuous or intermittent pressure conditions



Part #	Mfg #	Model	Size	Connection	Price
084940	0061655	SD2-MF	3/8"	SAE MFir	
144769	0061651	SD2-MF	1/4"	SAE MF Ir	

SD3 Series Dual Check Backflow Preventer With Atmospheric Port

- For use on Post-Mix Carbonated Beverage Equipment and dispensing for tea and coffee
- Prevents reverse flow of potentially contaminated water into potable water supply from pressure backflow
- For continuous or intermittent pressure conditions



Part #	Mfg #	Model	Size	Connection	Price
084941	0061657	SD3MF	3/8"	SAE MFir	

LF8 Hose Connection

- Copper silicon alloy body
- Stainless steel working parts for longevity
- Durable rubber diaphragm and disc for consistent positive seating



Part #	Mfg #	Model	Size	Price
157030	0792085	LF8	3/4"	

Backflow Preventers (Continued)

LF8 Hose Connection

Part #	Mfg #	Model	Size	Price
156605	0792091	LF8A	3/4"	
156606	0792086	LF8B	3/4"	
156608	0792087	LF8C	3/4"	
156610	0792092	LF8AC	3/4"	
156604	0792093	LFNF8	3/4"	
156609	0792094	LF8FR	3/4"	

Repair Kit For Series 008

Part #	Mfg #	Model	Size	Option	Price
137538	0887972	RK008T	3/8" - 1/2"	Check	

Air Gaps

- For use with backflow preventers on horizontal installations
- Can be easily mounted to body



909



957

Part #	Mfg #	Model	Size	Price
011325	0881399	909AGA	1/4" - 3/4"	
011326	0881376	909AGC	3/4" - 1"	
011327	0881378	909AGF	1-1/4" - 2"	
024595	0881385	909AGK	4" - 6"	
071506	0111764	957AG	2-1/2" - 10"	

919 Air Gap

- For Reduced pressure zone assemblies



Part #	Mfg #	Model	Size	Price
131593	0881577	919-AG-F	2"	

Hose Assembly Kits (Sensing Line)

Part #	Mfg #	Model	Size	Price
139959	0881486	AK909	2-1/2" - 4"	

Backflow Valves

Backflow Accessories

Vent Elbows



Part #	Mfg #	Model	Size	Price
011328	0881382	909ELF		

Test Cocks



Part #	Mfg #	Model	Size	Price
157246	0792000	LFTC	1/4"	
157243	0792001	LFNPT-TC	1/8"	



Backflow Valves

Parts Kit for 825Y Zone Assembly

- Set of rubbers for whole unit



Part #	Mfg #	Size	Description	Price
115070	905-111	3/4" - 1-1/4"	Rubber Parts Kit	
104968	905-112	1-1/2" - 2"	Rubber Parts Kit	

Valves

Backflow Valves

Wilkins Water Control Products

Wilkins 975XL Reduced Pressure Principle Assembly Backflow Preventer

- Maximum working water pressure: 175 psi
- Maximum working water temperature :180°F
- Full port QT ball valves
- ASSE Listed 1013
- UL and cUL Classified
- CSA Certified

WILKINS
A ZURN™ COMPANY



Part #	Mfg #	Size	Price
119692	975XL	3/4"	

Wilkins 975XL2SE Reduced Pressure Principle Assembly with 90° Street

- Maximu pressure: 175 psi
- Temperature range: 33°F-180°F
- Two full port resilient seated ball valves for shut-off and four resilient seated ball valve test cocks
- Nickel-plated ball valve handles
- Noryl® replaceable seats and silicone rubber check discs



Part #	Mfg #	Size	Price
178689	975XL2S	1/2"	
178691	975XL2S	1-1/4"	

Backwater Valves

Backwater Valves

Cast Iron Service Weight Backwater Valve

- Reduces backflow in drainage system
- All neoprene gaskets
- 300 Series stainless bolts and washers
- Repairable in service

Part #	Mfg #	Size	Length	Hub	Price
015321	B01-014	4"	11-3/4"	6-1/2"	

Plastic Backwater Valve

- Reduces backflow in drainage system
- Flapper and cover have elastomeric gasket to ensure watertight seal
- Stepped construction encourages flow (minimum 1/4" per foot fall)
- Threaded access cover for easy inspection and cleaning of drain line
- Sockets are Sch 40 DWV
- Magnetic strip for underground detection
- BOCA, IAPMO, SBCCI & CSA Approvals



Part #	Mfg #	Size	Price
103440	B04-200	2" PVC	
055192	B04-300	3" PVC	
043660	B04-400	4" PVC	

Backwater Devices

- Sleeve type
- Ball included



Part #	Mfg #	Description	Price
013927	D70-500	2" MIP Brass Body	

Extension Kits

- Kit includes cast iron tap, 16" sleeve and adapter

Part #	Mfg #	Description	Price
055193	B04-303	3" Complete Kit	
043662	B04-403	4" Complete Kit	
107105	B04-006	6" Cast Iron Sewer Lid	

Extension Kit Accessories

Part #	Mfg #	Description	Price
174628	BWV-300	3" BWV Ext Sleeve Adapter	

Backwater Valves

Backwater Valves

Clean Check™ Extendable Backwater Valve

Part #	Mfg #	Size	Type	Price
087228	223264WST	4"	PVC	

Backwater Valves

Valves

Backwater Valves and Accessories

Backwater Valve (DWV Hubs)



Part #	Mfg #	Size	Type	Price
136981	123285	4"	ABS	
132396	223283W	3"	PVC	
132399	223284W	4"	PVC	

Backwater Valve Access Sleeve

Part #	Mfg #	Description	Price
132398	123287-3	ABS Access Sleeve for 3" BWV	
132401	123285-3	ABS Access Sleeve for 4" BWV	

Backwater Valve Sleeve Lid



Part #	Mfg #	Description	Price
132397	123287-2	ABS Access Sleeve Lid for 3" BWV	
132402	123285-2	ABS Access Sleeve Lid for 4" BWV	

Backwater Valves

Gate Valves

Valterra PVC Slice Gate Valve (Slip)

- *Designed for pool and spa, irrigation, plumbing, waste water and agricultural applications*
- *Stainless steel shaft*
- *Ozone and chemical-resistant Santoprene™ materials*
- *Maximum working pressure: 50 psi (through 2")*
- *Solvent cement traps*
- *Triple o-ring neck seal*
- *3-Piece*



Part #	Mfg #	Size	Price
126449	VSGV200SL	2"	
103183	VSGV300SL	3"	
080021	VSGV400SL	4"	
092827	VSGV600SL	6"	



Backwater Valves

Check Valves

In-Line Spring Check Valve (Soc x Soc)

Part #	Mfg #	Size	Bag	Price
044147	S12-007	3/4"	120	
087121	S12-010	1"	80	
087614	S12-020	2"	40	

Valves

Backwater Valves

Check Valves

PVC Swing Check (Comp)

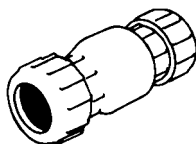

Part #	Mfg #	IPS Size	Body Length	Price
070747	1500-15	1-1/2"	7-1/2"	
004397	1500-20	2"	9-3/4"	

Valves

Backwater Valves

Valves

DWV Backwater Valves

PVC or ABS Solvent Weld Connection

- Threaded access seals hand tight and allows for easy maintenance and inspection
- Model **(869-4AS)** includes 16" sleeve & lid
- Model **(869-4SPS)** includes 16" shallow access sleeve



Part #	Mfg #	Size	Material	Price
099173	869-2P	2"	PVC	
123505	869-3P	3"	PVC	
158124	SC869S4PS	4"	PVC	
143131	869-4A	4"	ABS	
143226	869-4AS	4"	ABS	

Backwater Device

- Polypropylene thread body and float ball with EDPM sealing gasket
- Not designed for air or water test



Part #	Mfg #	Connection	Price
010031	SC8027	2" FIP	

ProCheck™ Residential Backwater Valve

- Available for 3" or 4" sch. 40 DWV lines.
- 3" Hub 5-1/2" x 8-5/8", out height x width
- 4" Hub 6-1/2" x 10-1/8", out height x width
- Valve body: ABS or PVC
- Vertical offset
- Sealing lid: polypropylene & carrier: ABS
- Flapper: elastomer overmolded polypropylene
- Valves can be adapted for standard, shallow-depth or deep-bury installations
- Modular valve design allows for interchangeable accessories – less inventory
- Structurally rugged and molded from engineered resins to stand up to job site abuse
- The unique flapper creates a tighter seal than other backwater valves



869-S3P

Part #	Mfg #	Offset	Conn.	Material	Price
160136	869-S3P	1/4"	3"	PVC	
159332	869-S4P	3/8"	4"	PVC	

Backwater Valve Replacement Parts

Part #	Mfg #	Description	Price
135088	869-23	Ext Sleeve Kit for 2" Valve Includes Sleeve Locking Collar and Lid	
128194	869-33	Ext Sleeve Lid for 3"	
128196	869-34	16" Ext Sleeve for 3"	
135329	869-36	Locking Collar for 869-34 Extension Sleeve	
123951	869-43	Ext Sleeve Lid for 4" Valve	
123506	869-44	16" Ext Sleeve for 4"	
184056	868-60	O-ring for 6" threaded lid	
152427	869-63	Ext Sleeve Lid for 6" Valve	

ProCheck™ Upper and Lower Deep-Bury Adapters

- For use with 3" or 4" backwater valves —purchased seperately



Part #	Mfg #	Material	Price
184057	869-S4PDB	PVC	

ProCheck™ Shallow Access Sleeve Kit

Part #	Mfg #	Includes:	Price
160138	869-SSK	Collar, Sleeve, & Lid	

Ball Valves - Potable

Bronze Ball Valves

T585-80-LF 2-Piece Full Port Bronze Ball Valve (FNPT x FNPT)

- Fire protection valve
- Lever handle (-LL models: CS locking lever)
- Blowout-proof stem
- Chrome-plated ball
- RTFE Seats
- Bar non-shock cold working pressure: 600 psi/41.4



Part #	Mfg #	Size	Price
160383	T585-80-LF	1/4"	
160384	T585-80-LF	3/8"	
160385	T585-80-LF	1/2"	
160386	T585-80-LF	3/4"	
160398	T585-80-LF-LL	3/4"	
160387	T585-80-LF	1"	
160388	T585-80-LF	1-1/4"	
160389	T585-80-LF	1-1/2"	
160390	T585-80-LF	2"	

S585-80-LF 2-Piece Full Port Bronze Ball Valve (C x C)

- Lever handle
- Blowout-proof stem
- Bar non-shock cold working pressure: 600 psi/41.4
- Maximum temperature rating: 400°F



Part #	Mfg #	Size	Price
160375	S585-80-LF	1/4"	
160376	S585-80-LF	3/8"	
160377	S585-80-LF	1/2"	
160378	S585-80-LF	3/4"	
160379	S585-80-LF	1"	
160380	S585-80-LF	1-1/4"	
160381	S585-80-LF	1-1/2"	
160382	S585-80-LF	2"	

S-585-80-LF-LL 2-Piece Bronze Ball Valve (S x S)

- Locking lever handle
- Chrome-plated ball
- RTFE Seats
- Blowout-proof stem
- Bar non-shock cold working pressure: 600 psi/41.4
- Bar saturated steam: 150 psi/10.3



Part #	Mfg #	Size	Price
160392	S585-80-LF-LL	1/2"	
160393	S585-80-LF-LL	3/4"	

T-585-66-LF Lead Free 2-Piece Full Port Bronze Ball Valve (FNPT x FNPT)

- Blowout-proof stem
- Chrome-plated ball
- Stainless trim
- RTFE Seats
- Bar non-shock cold working pressure: 600 psi/41.4
- Bar saturated steam: 150 psi/10.3



Part #	Mfg #	Size	Price
160409	T585-66-LF	1/2"	
160410	T585-66-LF	3/4"	
160411	T585-66-LF	1"	
160412	T585-66-LF	1-1/4"	
160413	T585-66-LF	1-1/2"	
160414	T585-66-LF	2"	

S585-66-LF 2-Piece Full Port Bronze Ball Valve (Swt x Swt)

- Blowout-proof stem
- Vented ball
- Stainless trim
- Bar non-shock cold working pressure: 600 psi/41.1
- Bar saturated steam: 150 psi/10.3



Part #	Mfg #	Size	Price
160401	S585-66-LF	1/2"	
160403	S585-66-LF	3/4"	
160404	S585-66-LF	1"	
160405	S585-66-LF	1-1/4"	
160406	S585-66-LF	1-1/2"	
160407	S585-66-LF	2"	

Valves

Ball Valves - Potable

Valves

**T-595Y-LF 3-Piece Full Port Bronze Ball Valve
(FIPT x FIPT)**

- Blowout-proof stem
- Silicon performance bronze™ alloy
- Non-shock cold working pressure



Part #	Mfg #	Size	Price
160415	T-595-Y-LF	1/2"	
160416	T-595-Y-LF	3/4"	
160417	T-595-Y-LF	1-1/2"	

Brass Ball Valves

**T-FP-600A-LF 2-Piece Full Port Brass Ball Valve
(FNPT x FNPT)**

- Lever handle
- Blowout-proof stem
- PTFE Seats
- 1/4" - 2" Non-shock cold working pressure: 600 psi
- 2-1/2" - 4" Non-shock cold working pressure: 400 psi
- Lead Free



Part #	Mfg #	Size	Price
157550	14BVNILF	1/4"	
157551	38BVNILF	3/8"	
157552	12BVNILF	1/2"	
157553	34BVNILF	3/4"	
157554	1BVNILF	1"	
157555	114BVNILF	1-1/4"	
157556	112BVNILF	1-1/2"	
157557	2BVNILF	2"	
157558	212BVNILF	2-1/2"	
157559	3BVNILF	3"	
157560	4BVNILF	4"	

**S-FP-600A-LF 2-Piece Full Port Brass Ball Valve
(C x C)**

- Lever handle
- Blowout-proof stem
- PTFE Seats
- Non-shock cold working pressure:
 - 1/4" - 2": 600 psi
 - 2-1/2" - 4": 400 psi
- Lead Free



Part #	Mfg #	Size	Price
157561	38SBVNILF	3/8"	
157562	12SBVNILF	1/2"	
157564	34SBVNILF	3/4"	
157565	1SBVNILF	1"	
157566	114SBVNILF	1-1/4"	
157568	112SBVNILF	1-1/2"	
157569	2SBVNILF	2"	
157570	212SBVNILF	2-1/2"	
157571	3SBVNILF	3"	

PXCP400-LF PEX Ball Valve

- 100 psi at 180°F
- Dezincification resistant
- Lever handle
- Lead-free*



Part #	Mfg #	Size	Price
210197	PXCP400-LF	1/2"	
210198	PXCP400-LF	3/4"	
210199	PXCP400-LF	1"	

Ball Valves - Potable

ProPRESS™ Full Port Ball Valves

(ProPRESS x ProPRESS)

- Lead free
- Brass
- Working pressure: 250 psi
- Maximum operating temperature: -4°F - 248°F



For Use with XL-C Press Jaws & Rings Only

- Lead free

Part #	Mfg #	Size	Price
157110	220XLCLF-11	2-1/2"	
157111	220XLCLF-12	3"	
157112	220XLCLF-14	4"	

Lead Free CimPress™ Ball Valves

1220NL ASC Ball Valve

- Lead free
- Suitable for 50% glycol/water mixtures
- Sure Connect O-Ring design
- 250 PSI pressure rating and 250° F temperature rating
- Conforms MSS-SP-110



Part #	Mfg #	Size	Price
159792	1220NLLF04	1/2"	
159793	1220NLLF06	3/4"	
159794	1220NLLF07	1"	
159795	1220NLLF08	1-1/4"	

Ball Valves - Potable

Valves

Bronze Ball Valves

LFB6080G2/LFB8081G2 Ball Valve

- Lead Free*, forged bronze body and adapter
- Full range of sizes from 1/4" – 2" (8 – 50mm)
- Stainless steel ball & stem option
- Minimal pressure drop due to large ports
- Blowout proof, pressure retaining stem
- Certified to NSF 372
- Adjustable stem packing gland
- White handles for easy Lead Free* identification
- BAA Compliant
- LFB6080 - NPT connections
- LFB8081 - Solder connections



Part #	Mfg #	Model	Size	Price
182108	0450100	LFB-6080G2	1/4"	
182109	0450101	LFB-6080G2	3/8"	
178154	0450107	LFB-6080G2	2"	
158054	0450102	LFB-6080G2	1/2"	
158045	0450104	LFB-6080G2	1"	
158046	0450105	LFB-6080G2	1-1/4"	
158047	0450106	LFB-6080G2	1-1/2"	
158055	0450109	LFB-6081G2	1/2"	
158049	0450110	LFB-6081G2	3/4"	
158050	0450111	LFB-6081G2	1"	
158051	0450112	LFB-6081G2	1-1/4"	
158052	0450113	LFB-6081G2	1-1/2"	
158053	0450114	LFB-6081G2	2"	

LFB6800 3-Piece Full-Port Ball Valve (NPT)

- Lead Free
- 3-piece, lift-out design
- Low operating torque
- Adjustable stem packing gland
- Each valve factory tested
- Stainless steel ball and stem
- Blow-out proof, pressure retaining stem
- Standard actuator mounting pads
- Vinyl insulator on heavy duty, zinc plated carbon steel handles
- Carbon/glass reinforced PTFE Durafill® valve seats



Part #	Mfg #	Model	Size	Price
158042	0123279	LFB-6801	1-1/2"	

Brass Ball Valves

LFB6001 Ball Valve (Swt)

- Brass
- Lead free
- 2-Piece, Standard Port



Part #	Mfg #	Model	Size	Price
160539	0555192	LFB6000	2-1/2"	
164360	0555196	LFB6001	1/2"	
164361	0555197	LFB6001	3/4"	
164362	0555198	LFB6001	1"	
156912	0555202	LFB6001	2-1/2"	
156913	0555203	LFB6001	3"	

LFIT6300/LFIS6301 Series Brass Ball and Waste Full Port Ball Valve

- Brass
- Lead free
- 2-Piece, side drain port
- For draining or venting of downstream line when valve is in the closed (off) position
- Pressure rating: 600 psi WOG (non-shock)
- Virgin PTFE valve seats
- Blow-out proof, pressure retaining stem



LFIT6300 Ball Valve (NPT)



Part #	Mfg #	Model	Size	Price
157127	0123625	LFIT6300	1/2"	
157128	0123626	LFIT6300	3/4"	
178155	0123627	LFIT6300	1"	

IS6301 Ball Valve (Swt)

Part #	Mfg #	Model	Size	Price
157129	0123628	LFIS6301	1/2"	
157130	0123629	LFIS6301	3/4"	

Ball Valves - Potable

FBV-3/FBVS-3 Series Brass Full Port Ball Valve

- Lead free
- 2-Piece construction
- Excellent for throttling and balancing applications
- For non-abrasive liquids or gases
- Temperature range: 40° - 450°F

FBVLF-2-Press Series Brass Full Port Ball Valve

- Lead free
- Integral press fitting end XL-C connection
- Designed for use in ProPress® piping systems
- Press connection rated to: 200 psi up to 250°F
- Blowout proof, bottom-loaded stem

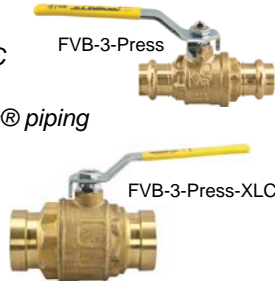

Part #	Mfg #	Model	Size	Price
157037	0555298	FBVLF-2-Press-M11/2"		
157038	0555299	FBVLF-2-Press-M13/4"		
157039	0555300	FBVLF-2-Press-M11"		
157040	0555301	FBVLF-2-Press-M11-1/4"		
157041	0555302	FBVLF-2-Press-M11-1/2"		
157036	0555303	FBVLF-2-Press-M12"		
157042	0555304	FBVLF-2-Press-M12-1/2"		

FBV-3C/FBVS-3C Series 2-Piece Full Port Brass Ball Valve

- Lead free
- Suitable for a full range liquids and gases
- Complies with MSS-SP-110
- Certified to NSF/ANSI Standard 61
- CSA Approved (1.4" to 3" threaded only), UL/FM approved (1.2" to 2" threaded only), UL Listed (1.2" to 2" solder)

LFFBV-3C 2-Piece Full Port Ball Valve (FNPT)

- Lead free
- UL Approved and NSF/ANSI 61/8 certified for 1/4" to 2"
- UL/FM Approved
- NSF/ANSI certified
- ASME B16.33, CSA Approved for 1/2" to 2"
- Sizes up to 2" /600 psi WOG/150 psi WSP
- Sizes 2-1/2" and 3" rated 600 psi WOG/125 psi WSP



Part #	Mfg #	Model	Size	Price
157070	0555100	LFFBV-3C	1/4"	
157071	0555101	LFFBV-3C	3/8"	
157072	0555102	LFFBV-3C	1/2"	

Brass Ball Valves (Continued)

FBV-3C/FBVS-3C Series 2-Piece Full Port Brass Ball Valve

LFFBV-3C 2-Piece Full Port Ball Valve (FNPT)

Part #	Mfg #	Model	Size	Price
157073	0555103	LFFBV-3C	3/4"	
157074	0555104	LFFBV-3C	1"	
157075	0555105	LFFBV-3C	1-1/4"	
157076	0555106	LFFBV-3C	1-1/2"	
157077	0555107	LFFBV-3C	2"	
157078	0555108	LFFBV-3C	2-1/2"	
157079	0555109	LFFBV-3C	3"	

LFFBVS-3C 2-Piece Full Port Brass Ball Valve (SWT)

- Lead free
- UL/FM Approved and NSF/ANSI 61/8 certified for 1/2" to 2"
- Sizes 1/2" to 2" rated 150 psi WSP/600 psi WOG
- Sizes 2-1/2" and 3" rated 400 psi WOG/125 psi WSP



Part #	Mfg #	Model	Size	Price
157080	0555110	LFBVS-3C	1/2"	
157081	0555111	LFBVS-3C	3/4"	
157082	0555112	LFBVS-3C	1"	
157083	0555113	LFBVS-3C	1-1/4"	
157084	0555114	LFBVS-3C	1-1/2"	
157085	0555115	LFBVS-3C	2"	
157086	0555116	LFBVS-3C	2-1/2"	
157087	0555117	LFBVS-3C	3"	

LFFBV-4 2-Piece Full Port Ball Valve (FNPT)

- Lead free
- Metal-to-metal adapter body seal to eliminate adapter leaks after soldering
- Fluorocarbon elastomer stem O-ring prevents stem leaks
- Adjustable stem packing gland provides longer service life
- Bottom loaded blowout proof stem
- PTFE stem packing seal and seats
- Machined chrome-plated Lead Free brass ball



Part #	Mfg #	Model	Size	Price
157093	0555118	LFFBV-4	1/4"	
157094	0555119	LFFBV-4	3/8"	
157095	0555120	LFFBV-4	1/2"	

Ball Valves - Potable

Valves

Brass Ball Valves (Continued)

LFFBV-4 2-Piece Full Port Ball Valve (FNPT)

Part #	Mfg #	Model	Size	Price
157096	0555121	LFFBV-4	3/4"	
157097	0555122	LFFBV-4	1"	
157098	0555123	LFFBV-4	1-1/4"	
157099	0555124	LFFBV-4	1-1/2"	
157100	0555125	LFFBV-4	2"	
157101	0555126	LFFBV-4	2-1/2"	
157102	0555127	LFFBV-4	3"	

LFFBVS-4 2-Piece Full Port Ball Valve (Swt)

- Lead free
- Metal-to-metal adapter body seal to eliminate adapter leaks after soldering
- Fluorocarbon elastomer stem O-ring prevents stem leaks
- Adjustable stem packing gland provides longer service life
- Bottom loaded blowout proof stem
- PTFE stem packing seal and seats
- Machined chrome-plated Lead Free brass ball



Part #	Mfg #	Model	Size	Price
157103	0555128	LFFBVS-4	1/2"	
157104	0555129	LFFBVS-4	3/4"	
157105	0555130	LFFBVS-4	1"	
157106	0555131	LFFBVS-4	1-1/4"	
157107	0555132	LFFBVS-4	1-1/2"	
157108	0555133	LFFBVS-4	2"	
157109	0555135	LFFBVS-4	3"	

WBVLF-3/WBVSLF-3 and WBVC Series Brass Standard Port Ball Valve

- Lead free
- For full range of gases and liquids on commercial residential and industrial applications

WBVCLF 3-Pc Brass Ball Valve (Comp)

- Lead free
- Pressure rating: 400 psi WOG, 150 psi WSP



Part #	Mfg #	Model	Size	Price
156517	0545306	WBVCLF	3/4"	

Ball Valves - Potable

ProPEX® Ball Valves

ProPEX® LF Brass Ball Valve - Large Bore (PEX x PEX)

- Not compatible with applications using glycol



Part #	Mfg #	Size	Price
028097	LF4815050	1/2" x 1/2"	
028098	LF4817575	3/4" x 3/4"	

ProPEX® LF Brass Ball Valve - Full Port (PEX x PEX)

- Not compatible with applications using glycol



Part #	Mfg #	Size	Price
132058	LF4827575	3/4" x 3/4"	
101212	LF4821010	1" x 1"	

ProPEX® LF Brass to Copper Ball Valve - Large Bore (PEX x CU Adapter)



Part #	Mfg #	Size	Price
033028	LF4805050	1/2" x 1/2"	
056788	LF4807575	3/4" x 3/4"	

ProPEX® LF Brass Ball Valve (PEX to MIP)

- Quarter-turn
- Not Compatible with applications using glycol



Part #	Mfg #	Description	Price
033014	LF4795050	1/2" x 1/2"	

ProPEX® LF Brass Commercial Ball Valves

- Compatible with applications containing no more than 50% propylene glycol



Part #	Mfg #	Description	Price
172250	LFC4825050	1/2" x 1/2"	
172251	LFC4827575	3/4" x 3/4"	
172253	LFC4821313	1-1/4" x 1-1/4"	
172254	LFC4821515	1-1/2" x 1-1/2"	
172255	LFC4822020	2" x 2"	

Ball Valve

- Copper Adapter



Part #	Mfg #	Description	Price
144914	A5802075	3/4" R20 Thread	

Ball and Balancing Valve

Part #	Mfg #	Description	Price
144915	A5902075	3/4" R20 Thread	

Quick and Easy Valves

ProPEX Copper Ball Valve (PEX x CU)

- Brass shut-off valve for 1/2" and 3/4" AQUAPEX® to 1/2" or 3/4" copper pipe
- Quick and Easy tool and Quick and Easy rings required (sold separately)

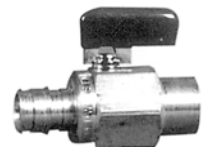

Part #	Mfg #	Size	Bore	Price
093399	Q5806375	5/8" x 3/4"	0.44"	

Valves

Ball Valves - Non-Potable

Ball Valves

73A Series 2-Piece Ball Valve

- Threaded
- Standard port
- Forged carbon steel
- 2000 CWP to 1", 1500 CWP to 2"



Part #	Mfg #	Size	Price
175124	73A-101-01A	1/4"	
175125	73A-201-01A	3/8"	
175126	73A-103-01A	1/2"	
175127	73A-104-01A	3/4"	
175128	73A-105-01A	1"	
175129	73A-106-01A	1-1/4"	
175131	73A-701-01A	1-1/2"	
175132	73A-801-01A	2"	

77C Series 2-Piece Ball Valve

- Threaded or solder
- Full port, bronze
- 600 CWP, Threaded sizes: 1/4" to 2-1/2"
- 600 CWP, Solder sizes: 3/8" to 2-1/2"



77C-100 Series - Threaded

Part #	Mfg #	Size	Price
175162	77C-101-01	1/4"	
175163	77C-102-01	3/8"	
175164	77C-103-01	1/2"	
175165	77C-104-01	3/4"	
175166	77C-105-01	1"	
175167	77C-106-01	1-1/4"	
175168	77C-107-01	1-1/2"	
175169	77C-108-01	2"	

77C-200 Series - Solder

Part #	Mfg #	Size	Price
175175	77C-202-01	3/8"	
175176	77C-203-01	1/2"	
175177	77C-205-01	1"	
175178	77C-206-01	1-1/4"	

94A Series 2-Piece Ball Valve

- Full-Port
- Blow-out Proof Stem Design
- Adjustable Stem Packing Nut
- Silicone Free
- 100% Factory Tested



94A Series - Threaded

Part #	Mfg #	Size	Price
175289	94A-101-01	1/4"	
175290	94A-102-01	3/8"	
175291	94A-103-01	1/2"	
175292	94A-104-01	3/4"	
175293	94A-105-01	1"	
175295	94A-106-01	1-1/4"	
175296	94A-107-01	1-1/2"	
175297	94A-108-01	2"	
175298	94A-109-01	2-1/2"	
175299	94A-100-01	3"	
175300	94A-10A-01	4"	

94A Series - Solder

Part #	Mfg #	Size	Price
175303	94A-203-01	1/2"	
175304	94A-204-01	3/4"	
175305	94A-205-01	1"	
175306	94A-206-01	1-1/4"	
175307	94A-207-01	1-1/2"	
175308	94A-208-01	2"	
175309	94A-209-01	2-1/2"	
175310	94A-200-01	3"	
175311	94A-20A-01	4"	

Valves

Ball Valves - Potable

Ball Valves

One-Piece Ball Valve

- 316 Stainless steel
- 150#
- Series SC101



Part #	Size	Price
065103	1/2"	

Two-Piece Ball Valve

- 316 Stainless steel
- Series SC201



Part #	Size	Price
167534	1/4"	
167535	3/8"	
167536	1/2"	
167537	3/4"	
167538	1"	
167539	1-1/4"	
167540	1-1/2"	
167541	2"	

Two-Piece Full Port Ball Valve

- 316 Stainless steel
- 1000#
- Series 50M76



Part #	Size	Price
175676	1/4"	
175677	3/8"	
175678	1/2"	
176137	3/4"	
176138	1"	
176139	1-1/4"	
176140	1-1/2"	
176141	2"	

Three-Piece Full Port Ball Valve with Mounting Pad

- 316 Stainless steel
- 1000#
- Series 53036



Threaded

Part #	Size	Price
176142	1/2"	
176143	3/4"	
176144	1"	
176145	1-1/4"	
176146	1-1/2"	
176147	2"	

Socket Weld

Part #	Size	Price
176148	1/2"	
176149	3/4"	
176150	1"	
176151	1-1/4"	
176152	1-1/2"	
176153	2"	

Ball Valves - Non-Potable

Valves

Bronze Ball Valves

T-580-70 Conventional Port 2-Piece Bronze Ball Valve (FNPT x FNPT)

- Lever handle
- Blowout-proof stem
- PTFE Seats
- Chrome-plated ball
- Bar non-shock cold working pressure: 600 psi/41.4
- Bar saturated steam: 150 psi/10.3



Part #	Mfg #	Size	Price
016216	T-580-70	1-1/4"	
016217	T-580-70	1-1/2"	
016218	T-580-70	2"	
016220	T-580-70	3"	

T-580-70-UL Conventional Port 2-Piece UL Listed Bronze Ball Valve

- Lever handle
- Blowout-proof system
- Chrome-plated ball
- Bar non-shock cold LP gas pressure: 250 psi/17.2 per UL842



Part #	Mfg #	Size	Price
136143	T580-70-UL	1-1/4"	

S-580-70 Conventional 2-Piece Port Bronze Ball Valve (C x C)

- Lever handle
- Blowout-proof stem
- Chrome-plated ball
- RTFE Seats



Part #	Mfg #	Size	Price
016257	S-580-70	1-1/4"	
016258	S-580-70	1-1/2"	
016259	S-580-70	2"	
016260	S-580-70	2-1/2"	
016261	S-580-70	3"	

T-585-70-UL 2-Piece Full Port Bronze Ball Valve (FNPT x FNPT)

- Blowout-proof stem
- Bronze trim
- UL Listed
- Bar non-shock LP Gas per UL842: 250 psi/17.2



Part #	Mfg #	Size	Price
032224	T-585-70-UL	3/4"	
100905	T-585-70-UL	1"	

T-585-70-HC 2-Piece Full Port Bronze Ball Valve (T x HC)

- Non-shock cold working pressure
- Blow out-proof stem
- 3/4" Hose connection with cap and chain
- Bronze trim



Part #	Mfg #	Size	Price
117873	T-585-70-HC	3/4"	

S-585-70-HC 2-Piece Full Port Bronze Ball Valve (S x HC)

- Non-shock cold working pressure
- Blow out-proof stem
- Solder end X 3/4" hose connection with cap and chain



Part #	Mfg #	Size	Price
117530	S-585-70-HC	1/2"	
143191	S-585-70-HC	3/4"	

Stainless Steel Ball Valves

T-580-S6-R-66-LL 2-Piece Stainless Steel Ball Valve

- Conventional port
- Blowout-proof stem
- Pressure rating: 2000 psi 138 bar non-shock cold working pressure
- Max temp: 400°F



Part #	Mfg #	Size	Price
017508	T580-S6R-66-LL	1/2"	

Ball Valves - Non-Potable

T-585-S6-R-66-LL 2-Piece Stainless Steel Ball Valve

- Full port
- Blowout-proof stem
- Pressure rating: 1000 psi
69 bar non-shock cold working pressure
- Max temp: 400°F



Part #	Mfg #	Size	Price
140221	T585-S6R-66-LL	1/2"	
140220	T585-S6R-66-LL	3/4"	
130022	T585-S6R-66-LL	1"	

Carbon Steel Ball Valves

T-580-CS-R-25 Conv Port Threaded Carbon Steel Ball Valve 2-Piece Body, Blowout-Proof Stem Chrome Plated Ball

- 1/4" - 1" 2000# WOG
- CS F x F w/RTFE seat; CS trim
- Material List
Body - Carbon Steel, A-216 GR WCB, Phosphate coated
Body - 1/4" to 1" - Carbon Steel, ASTM A-108 Type 12L14, Phosphate coated
Ball - Carbon Steel, ASTM A-108 Type 12L14, Chrome-plated
Stem - Carbon Steel, ASTM A-108 Type 12L14, Nickel-plated
Handle - Zinc-Plated Steel, Platisol coated



Part #	Mfg #	Size	Price
121054	T-580-CS-R-25	3/8"	
040659	T-580-CS-R-25	3/4"	
040658	T-580-CS-R-25	1/2"	

Ball Valve Accessories

Lever Handle Extension

Part #	Mfg #	Size	Use with	Price
117510	T025118FG	1/2"	T/S580	
077849	T025121FG	1"	T/S580	
117511	T025124FG	1-1/2"	T/S580	



Ball Valves - Non-Potable

True Union Ball Valves

True Union Ball Check Valves (Regular Style)

CPVC True Union Threaded & Socket Ball Check Valve -
Viton®



Part #	Mfg #	Size	Price
140335	2329-010C	1"	

Valves



Ball Valves - Non-Potable

PVC Ball Valves

Compact Ball Valve (Regular Style)

- Pressure rating for 3" - 6" & Flg: 150 psi @ 73°F
- Maximum service temperature: 140°F
- Rated for vacuum service
- Assembled with silicone-free water-soluble lubricants
- Standard 6" valve uses lever style handle



Compact Socket Ends Ball Valve - EPDM

Part #	Mfg #	Size	Price
038435	2122-030	3"	

Compact Socket Ends Ball Valve - Viton®

Part #	Mfg #	Size	Price
013175	2132-005	1/2"	
014742	2132-007	3/4"	
012264	2132-010	1"	
052610	2132-012	1-1/4"	
012526	2132-015	1-1/2"	
013900	2132-020	2"	

Utility Ball Valves

- Maximum pressure: 150 psi @ 73°F
- Maximum service temperature: 140°F
- Assembled with silicone-free water - soluble lubricants
- EPDM O-Ring seal



PVC White Utility Threaded Ends Ball Valve - EPDM

Part #	Mfg #	Size	Price
053653	2621-010	1"	

PVC White Utility Socket Ends Ball Valve - EPDM

- Maximum pressure: 150 psi @ 73°F

Part #	Mfg #	Size	Price
013167	2622-005	1/2"	
014738	2622-007	3/4"	
012261	2622-010	1"	
012852	2622-012	1-1/4"	
012492	2622-015	1-1/2"	
013866	2622-020	2"	
017765	2622-030	3"	

PVC Ball Valves (Continued)

Utility Ball Valves

PVC White Utility Socket Ends Ball Valve - EPDM

Part #	Mfg #	Size	Price
045205	2622-040	4"	

Valves



Ball Valves - Non-Potable

True Union Ball Valves

True Union 2000 Industrial PVC Ball Valve



PVC True Union 2000 Thrd & Soc Ball Valve - EPDM

Part #	Mfg #	Size	Price
065742	1829-005	1/2"	
065743	1829-007	3/4"	
065744	1829-010	1"	
065745	1829-012	1-1/4"	
065746	1829-015	1-1/2"	
065747	1829-020	2"	

PVC True Union 2000 Soc Ball Valve - EPDM

Part #	Mfg #	Size	Price
065749	1822-030	3"	
065750	1822-040	4"	

Valves

Butterfly Valves - Non-Potable

Commercial/Industrial Butterfly Valves

**Domestic Lug Body Butterfly Valve
Fig LD2000 200# Ductile Iron**

- For use in commercial and light industrial
- Bi-directional dead-end service
- Pressure rating: 200 psi
- Raised face flange
- EPDM Molded-in seat liner
- Aluminum bronze disc
- Stainless steel stem with copper bushings



Part #	Mfg #	Size	Operator	Price
016146	LD2000-3	2-1/2"	Lever Lock	
016148	LD2000-3	3"	Lever Lock	
016149	LD2000-3	4"	Lever Lock	
019076	LD2000-3	6"	Lever Lock	
071422	LD2000-5	10"	Gear Op	

**Fig LD3010-3 Domestic DI Lug Body Butterfly Valve
Lever Lock Operated Mechanism**

- Pressure rating: 250 psi
- Material list
Body - ductile iron
Disc - ductile iron
Seat - buna-N
Stem - 416 SS
Upper & lower - copper alloy
Collar - brass



Part #	Mfg #	Size	Price
016150	LD3010-3	2-1/2"	
016151	LD3010-3	3"	
016152	LD3010-3	4"	
016153	LD3010-3	5"	
016154	LD3010-3	6"	

Import Economy Lug Body Butterfly Valve

**Fig N200-235-LH Import Lug Body
Lever Lock Operating Mechanism**

- Pressure rating: 200 psi
- Material list
Body - cast Iron
Disc - aluminum bronze
Seat - EPDM



Part #	Mfg #	Size	Price
128245	N200-235-LH	2"	

**Commercial/Industrial Butterfly Valves
(Continued)**

Import Economy Lug Body Butterfly Valve

**Fig N200-235-LH Import Lug Body
Lever Lock Operating Mechanism**

Part #	Mfg #	Size	Price
128246	N200-235-LH	2-1/2"	
128247	N200-235-LH	3"	
128248	N200-235-LH	4"	
128249	N200-235-LH	5"	
128250	N200-235-LH	6"	
128251	N200-235-LH	8"	
128253	N200-235-GO 8", Gear Operated		
128255	N200-235-GO 12", Gear Operated		

GD-4765 Grooved Butterfly Valve

- Ductile iron
- 300 PSI
- Compatible with IPS pipe



Part #	Mfg #	Size	Price
150153	GD-4765	2-1/2"	
150154	GD-4765	3"	

GD-4775 Grooved Butterfly Valve

- Ductile iron
- 300 PSI
- Compatible with IPS pipe



Part #	Mfg #	Size	Price
165111	GD-4775	3"	

Valves

Butterfly Valves - Non-Potable

Valves

Butterfly Valves

- For positive shut-off service on commercial, irrigation, HVAC, and industrial applications
- Cast iron body, 416 stainless steel shaft
- Mounting shaft for 10-position lever, gear operator or actuator
- Extended neck for 2" of insulation, pinned disc

03-121-15 Butterfly Valve - Lug, Lever Handle

- Aluminum bronze disc
- EPDM seat
- Standard handle (10-position only)
- DBF Series use domestic and foreign components that have been assembled & tested in USA



Part #	Mfg #	Model	Size	Price
078611	0525567	BF0312115M2	2-1/2"	
078613	0525585	BF0312115M2	3"	
078614	0525603	BF0312115M2	4"	
078616	0525639	BF0312115M2	6"	
078617	0525657	BF0312115M2	8"	

03-121-1G Butterfly Valve - Lug, Gear Operator

- Ductile iron body
- Aluminum bronze disc
- 416 Stainless steel shaft
- EPDM Seat
- Gear operator



Part #	Mfg #	Model	Size	Price
078608	0525669	BF031211GM2	8"	
078609	0525687	BF031211GM2	10"	
078610	0525705	BF031211GM2	12"	

Butterfly Valves - Non-Potable

Butterfly Valves

Gear Operated Butterfly Valve

- 200 psi
- Cast iron body
- Lug style
- 316 SS disc
- EPDM Seat



Part #	Size	Price
174945	10"	
174946	12"	

Lever Operated Butterfly Valve

- 200 psi
- Cast iron body
- Lug style
- Aluminum bronze disc
- EPDM seat



Part #	Size	Price
175019	2"	
169464	2-1/2"	
169465	3"	
169466	4"	
169467	6"	
174944	8"	

Check Valves - Potable

Valves

Bronze Check Valves

T-413-Y 125# Bronze Check Valve (FNPT x FNPT)

- Horizontal swing
- Regrinding type
- Y-Pattern
- Renewable steam seat and disc
- Non-shock cold working pressure: 200 psi



Part #	Mfg #	Size	Price
161659	T413Y-LF	1/2"	
161660	T413Y-LF	3/4"	
161661	T413Y-LF	1"	
161662	T413Y-LF	1-1/4"	
161663	T413Y-LF	1-1/2"	
161664	T413Y-LF	2"	

S-413-Y 125# Bronze Check Valve (Swt x Swt)

- Horizontal swing
- Re-grinding type
- Y-Pattern
- Renewable PTFE seat disc
- Non-shock cold working pressure: 200 psi



Part #	Mfg #	Size	Price
161650	S413Y-LF	1/2"	
161652	S413Y-LF	3/4"	
161653	S413Y-LF	1"	
161654	S413Y-LF	1-1/4"	
161656	S413Y-LF	1-1/2"	
161657	S413Y-LF	2"	

Check Valves - Potable

Check Valves

LF600 Cast Copper Maxi-Flo Check Valve

- PTFE seat
- Silent operation
- Threaded ends
- Conical Lead Free* check for full fluid flow
- Low pressure drop equivalent to a swing check
- Stainless steel guide, rod and spring (1 1/4" to 2")
- Install in horizontal or vertical position with upward flow (consult factory for proper use in vertical installations)



Part #	Mfg #	Model	Size	Price
145898	0555175	LF600	1/2"	
145899	0555176	LF600	3/4"	
157063	0555177	LF600	1"	
157065	0555178	LF600	1-1/4"	
157066	0555179	LF600	1-1/2"	
157067	0555180	LF600	2"	

LF601S Cast Copper Maxi-Flo Valves

- Viton® disc
- Cast copper silicon alloy body for durability
- Integral Lead Free* copper silicon alloy seat
- Install in horizontal or vertical position with upward flow
- Low pressure drop equivalent to a swing check
- Silent operation



Part #	Mfg #	Model	Size	Price
156522	0555181	LF601S	1/2"	
156513	0555182	LF601S	3/4"	
156514	0555183	LF601S	1"	

LF709 Double Check Valve Assembly

- Replaceable ss seats
- Max flow at low pressure drop
- No special tools required for servicing
- Captured spring assemblies for safety
- Approved for vertical flow up installation



Part #	Mfg #	Model	Size	Price
157318	0122785	LF709-OSY	2-1/2"	
157319	0122786	LF709-OSY	3"	
157320	0122789	LF709-OSY	4"	
157321	0122790	LF709-OSY	6"	
157322	0122791	LF709-OSY	8"	

Check Valves (Continued)

LF709 Double Check Valve Assembly

Part #	Mfg #	Model	Size	Price
157323	0122794	LF709-OSY	10"	



Check Valves - Non-Potable

PVC Check Valves

PVC White Utility Swing Check Valves - Thrd

Part #	Mfg #	Size	Price
084826	S1520-07F	3/4"	
084827	S1520-10F	1"	

Valves

Check Valves - Non-Potable

Viega ProPress® Valves

**ProPress® Check Valve
(P x P)**

- Bronze
- Smart Connect® feature
- Inline



Part #	Mfg #	Size	Price
123636	22353	1/2"	
123637	22358	3/4"	
125222	22373	1-1/2"	
123639	22378	2"	

Check Valves - Non-Potable

Valves

Bronze Check Valves

S-413-B 125# Bronze Check Valve (C x C)

- Horizontal swing
- Re-grinding type
- Y-Pattern
- Renewable seat and disc
- 200psi/13.8 Bar non-shock cold working pressure



Part #	Mfg #	Size	Price
062776	S413-B	3/4"	

T-433-B 150# Bronze Check Valve (FNPT x FNPT)

- Horizontal swing
- Re-grinding type
- Y-Pattern
- Renewable bronze seat disc
- Non-shock cold working pressure: 300 psi



Part #	Mfg #	Size	Price
062782	T-433-B	3/4"	
062785	T-433-B	1-1/2"	

T-433-Y 150# Bronze Check Valve (FNPT x FNPT)

- Horizontal swing
- Re-grinding type
- Y-Pattern
- Renewable PTFE seat disc
- Non-shock cold working pressure: 300 psi



Part #	Mfg #	Size	Price
035223	T-433-Y	3/4"	
158701	T-433-Y	1"	
101111	T-433-Y	2"	
016196	T-433-Y	3"	

S-433-Y 150# Bronze Check Valve (Swt x Swt)

- Horizontal swing
- Re-grinding type
- Y-Pattern
- Renewable PTFE seat disc
- Non-shock cold working pressure: 300 psi



Part #	Mfg #	Size	Price
016252	S-433-Y	2-1/2"	

T-453-B 200# Bronze Check Valve (NPT x NPT)

- Horizontal swing
- Re-grinding type
- Renewable seat and disc
- Y-Pattern
- Non-shock cold working pressure: 400psi/27.6



Part #	Mfg #	Size	Price
016199	T-453-B	3/4"	
016203	T-453-B	2"	

Iron Body Check Valves

F-918-B 125# Cast Iron Check Valve (Flg x Flg)

- Bolted bonnet
- Horizontal swing
- Renewable seat and disc
- IBBM
- Non-shock cold working pressure: 200 psi/13.8 bar



Part #	Mfg #	Size	Price
016143	F-918-B	2-1/2"	
016144	F-918-B	3"	
016145	F-918-B	4"	
069778	F-918-B	6"	

F-910-B-LF 125# Cast Iron Check Valve (Flg x Flg)

- Flanged
- Globe style
- Renewable seat and disc
- Spring actuated
- 200psi/13.8 Bar non-shock cold working pressure



Part #	Mfg #	Size	Price
161668	F-910-B-LF	3"	
161669	F-910-B-LF	4"	

W-920-W-LF 125# Cast Iron Wafer Style Check Valve

- Buna-N seat
- Twin bronze discs
- Rubber seat
- Spring actuated
- 250psi/17.2 Bar non-shock cold working pressure



Part #	Mfg #	Size	Price
161671	W-920W-LF	2-1/2"	

Check Valves - Non-Potable

Iron Body Check Valves (Continued)

W-920-W-LF 125# Cast Iron Wafer Style Check Valve

Part #	Mfg #	Size	Price
161672	W-920W-LF	3"	

Check Valves - Non-Potable

Swing Check Valves

521 Brass Swing Check Valve

- 200 WOG



Valves

Part #	Mfg #	Size	Price
140282	521T03	1/2" FIP	
140283	521T04	3/4" FIP	
140284	521T05	1" FIP	
140285	521T06	1-1/4" FIP	
140286	521T07	1-1/2" FIP	
140287	521T08	2" FIP	
140275	521C03	1/2" C x C	
140276	521C04	3/4" C x C	
140277	521C05	1" C x C	
140278	521C06	1-1/4" C x C	
140279	521C07	1-1/2" C x C	
140280	521C08	2" C x C	

Check Valves - Non-Potable

Check Valves

Stainless Swing Check Valve

- 200# 316SS
- Series SV20276
- Threaded



Part #	Size	Price
176185	1/4"	
176187	3/8"	
176188	1/2"	
176189	3/4"	
176190	1"	
176191	1-1/4"	
176192	1-1/2"	
176193	2"	

Forged Carbon Swing Check Valve

- 800#
- Bolted bonnet
- Forged carbon steel A105



Socket Weld

Part #	Size	Price
176201	1/2"	
176202	3/4"	
176203	1"	
176204	1-1/4"	
176205	1-1/2"	
176206	2"	

Threaded

Part #	Size	Price
176195	1/2"	
176196	3/4"	
176197	1"	
176198	1-1/4"	
176199	1-1/2"	
176200	2"	



Gas Stop Valves

Gas Stop Valves - Domestic

**Bronze Flat/Tee Head with Check - 2 psi
(FIP x FIP)**

- Plug style



Part #	Mfg #	Size	Notes	Price
013133	10596	1/2"	CSA Approved	
014702	10596	3/4"	CSA Approved	
012236	10596	1"		
012827	10596	1-1/4"		
012457	10596	1-1/2"		
013826	10596	2"		

**Iron Body Flat Head Less Check - 100 psi
(FIP x FIP)**

- Plug style
- Black
- Non-tamperproof



Part #	Mfg #	Size	Price
002136	10685B	1-1/2"	

Valves

Gas Stop Valves

Stop Valves

GBV Series Gas Ball Valve

- CSA/UL Approved
- Brass 2-piece body construction
- Rated 32° - 125°F



GBV Ball Valve with Tee Handle (FNPT)

Part #	Mfg #	Model	Size	Price
013130	0545003	GBV	1/2"	
014698	0545005	GBV	3/4"	
069646	0545007	GBV	1"	

Gate Valves - Non-Potable

Valves

Bronze Gate Valves

T-111 125# Multi-Turn Bronze Gate Valve (FNPT x FNPT)

- Screw-in bonnet
- Rising stem
- Solid wedge
- Non-shock cold working pressure: 200 psi



Part #	Mfg #	Size	Price
016155	T-111	1/4"	
016156	T-111	3/8"	
016157	T-111	1/2"	
016158	T-111	3/4"	
016159	T-111	1"	
016160	T-111	1-1/4"	
016161	T-111	1-1/2"	
016162	T-111	2"	
016163	T-111	2-1/2"	
016164	T-111	3"	

S-111 125# Bronze Gate Valve (Swt x Swt)

- Screw-in bonnet
- Rising stem
- Solid wedge
- Non-shock cold working pressure: 200 psi



Part #	Mfg #	Size	Price
016230	S-111	1/2"	
016231	S-111	3/4"	
016232	S-111	1"	
016233	S-111	1-1/4"	
016234	S-111	1-1/2"	
016235	S-111	2"	
016236	S-111	2-1/2"	
064405	S-111	3"	

T-113-LF 125# Bronze Gate Valve (FNPT x FNPT)

- Screw-in bonnet
- Non-rising stem
- Solid wedge
- Non-shock cold working pressure: 200 psi



Part #	Mfg #	Size	Price
161683	T-113-LF	1/2"	
161684	T-113-LF	3/4"	
161685	T-113-LF	1"	
161686	T-113-LF	1-1/4"	
161687	T-113-LF	1-1/2"	
161688	T-113-LF	2"	

S-113 125# Bronze Gate Valves (Swt x Swt)

- Screw-in bonnet
- Non-rising stem
- Solid wedge
- Non-shock cold working pressure: 200 psi



Part #	Mfg #	Size	Price
016237	S-113	1/2"	
016238	S-113	3/4"	
016242	S-113	1"	
128277	S-113	1-1/4"	
016243	S-113	1-1/2"	
016244	S-113	2"	

T-131 150# Bronze Gate Valves (NPT x NPT)

- Screw-in bonnet
- Rising stem
- Solid wedge
- Bar non-shock working pressure: 300 psi



Part #	Mfg #	Size	Price
106175	T-131	3/4"	
147686	T-131	1"	

Gate Valves - Non-Potable

T-134 150# Bronze Gate Valves (FNPT x FNPT)

- Block pattern
- Union bonnet
- Rising stem
- Solid wedge
- Non-shock cold working pressure: 300 psi



Part #	Mfg #	Size	Price
059019	T-134	3/4"	
059021	T-134	1-1/4"	
059022	T-134	1-1/2"	
059023	T-134	2"	

S-134 150# Bronze Gate Valves (Swt x Swt)

- Block Pattern
- Union Bonnet
- Rising Stem
- Solid Wedge
- Non-shock cold working pressure: 300 psi



Part #	Mfg #	Size	Price
059025	S-134	1"	
059028	S-134	1-1/2"	
059027	S-134	2"	

T-174-SS 300# Bronze Gate Valves (FNPT x FNPT)

- Block pattern
- Union bonnet
- Rising stem
- Alloy solid wedge
- Stainless steel seats
- Non-shock cold working pressure: 600 psi



Part #	Mfg #	Size	Price
016173	T-174-SS	1/2"	
016174	T-174-SS	3/4"	
016175	T-174-SS	1"	
016176	T-174-SS	1-1/4"	
021386	T-174-SS	1-1/2"	
016177	T-174-SS	2"	

T-174-A 300# Bronze Gate Valves (NPT x NPT)

- Block pattern
- Union bonnet
- Rising stem
- Alloy solid wedge
- Non-shock cold working pressure: 600 psi



Part #	Mfg #	Size	Price
021419	T-174-A	3/4"	
027175	T-174-A	1"	
026363	T-174-A	1-1/2"	

Iron Body Gate Valves

F-617-O 125# Cast Iron Flanged Gate Valve (Flg x Flg)

- Bolted bonnet
- Outside screw & yoke
- Solid wedge
- Iron body bronze mounted (IBBM)
- Non-shock cold working pressure: 200 psi



Part #	Mfg #	Size	Price
071050	F-617-O	2"	
016137	F-617-O	2-1/2"	
016138	F-617-O	3"	
016139	F-617-O	4"	
023538	F-617-O	5"	
016140	F-617-O	6"	
022677	F-617-O	8"	

F-619 125# Cast Iron Flanged Gate Valve (Flg x Flg)

- Bolted bonnet
- Non-rising stem
- Solid wedge
- Bronze mounted
- Non-shock cold working pressure: 200 psi/13.8 bar



Part #	Mfg #	Size	Price
128235	F-619	2"	
080304	F-619	2-1/2"	
039077	F-619	3"	
080305	F-619	4"	
062873	F-619	6"	

Valves

Gate Valves - Non-Potable

Valves

Commercial Brass Gate Valves

Brass Gate Valve

- Non-rising stem (NRS)
- For shut-off service
- Pressure rating: 200 psi WOG
- Maximum temperature: 180°F

LFWGV - Round Handle (FNPT)



Part #	Mfg #	Model	Size	Price
164483	0555158	LFWGV	1/2"	
164485	0555159	LFWGV	3/4"	
164486	0555160	LFWGV	1"	
164487	0555167	LFWGVS	1/2"	
164488	0555168	LFWGVS	3/4"	
164489	0555169	LFWGVS	1"	

WGVS - Round Handle (Swt)

Part #	Mfg #	Model	Size	Price
010885	0760010	WGVS	1/2"	
010929	0760030	WGVS	3/4"	

Commercial Iron Gate Valves

405-RW Flanged Gate Valve

- Full port flow, low head loss
- Epoxy coated, internal and external
- Vulcanized encapsulated resilient wedge
- In-line serviceable
- Boss-tapped and plugged
- MSS-SP-70 conformance



Part #	Mfg #	Model	Size	Price
101022	0700103	405RW	2-1/2"	
094797	0700105	405RW	4"	
101023	0700106	405RW	6"	

Gate Valves

Gate Valves

Forged Stainless Gate Valve

- 800#
- Reduced port
- A182 / 316L SS body
- Bolted bonnet



Threaded

Part #	Size	Price
165056	1/2"	
165058	1"	
165059	1-1/2"	
165060	2"	

Socket Weld

Part #	Size	Price
165062	1/2"	
165063	3/4"	
165064	1"	
165065	1-1/4"	
165066	1-1/2"	
165067	2"	

Forged Carbon Steel Gate Valve

- 800#
- OS&Y
- A105 Forged carbon steel body
- Bolted bonnet



Threaded

Part #	Size	Price
176170	1/2"	
176171	3/4"	
176172	1"	
176173	1-1/4"	
176174	1-1/2"	
176175	2"	

Socket Weld

Part #	Size	Price
176176	1/2"	
176177	3/4"	
176178	1"	
176179	1-1/4"	

Gate Valves (Continued)

Forged Carbon Steel Gate Valve

Socket Weld

Part #	Size	Price
176180	1-1/2"	
176181	2"	

Cast Steel Gate Valve

- 150# Flanges
- Full port
- OS&Y
- Bolted bonnet



Flanged

Part #	Size	Price
165068	2-1/2"	
165069	3"	
165070	4"	

Globe Valves

Bronze Globe Valves

T-211-Y 125# Bronze Globe Valves (FNPT x FNPT)

- Screw-in bonnet
- Integral seat
- Renewable seat & disc
- Non-shock cold working pressure: 200 psi



Part #	Mfg #	Size	Price
016179	T-211-Y	1/2"	
016180	T-211-Y	3/4"	
016181	T-211-Y	1"	
016182	T-211-Y	1-1/4"	
016183	T-211-Y	1-1/2"	
016184	T-211-Y	2"	

Iron Body Globe Valves

F-718-B 125# Cast Iron Globe Valve (Fig x Fig)

- Bolted bonnet
- Renewable seat & disc
- Bronze mounted



Part #	Mfg #	Size	Price
128240	F-718-B	2-1/2"	
077393	F-718-B	3"	
060142	F-718-B	6"	

Valves

S-211-Y 125# Bronze Globe Valves (Swt x Swt)

- Screw-in bonnet
- Integral seat
- Renewable seat & disc
- Non-shock cold working pressure: 200 psi



Part #	Mfg #	Size	Price
021817	S-211-Y	1/2"	
050268	S-211-Y	3/4"	
122199	S-211-Y	1"	
085284	S-211-Y	1-1/4"	
128206	S-211-Y	1-1/2"	
128208	S-211-Y	2"	

T-235-Y 150# Bronze Globe Valves (FNPT x FNPT)

- Union bonnet
- Integral seat
- Renewable PTFE seat and disc
- Non-shock cold working pressure: 300 psi



Part #	Mfg #	Size	Price
051868	T-235-Y	1/2"	
051870	T-235-Y	3/4"	
051874	T-235-Y	2"	

Hose Bibbs

Vacuum Breakers



Part #	Mfg #	Size	Price
156240	646AS4LF	3/4" HPT	

Hose Bibbs

Hose Bibbs

Forged Brass Hose Bibb

- Hard chrome ball
- 1/4-Turn operation
- Teflon seats
- T-Handle



Part #	Mfg #	Size	Price
025391	B60-950	1/2"	
047137	B60-975	3/4"	

Hose Bibbs

Sillcocks

SC Series Hose Bibb Hex Shoulder Sillcock with Tee Handle



Part #	Mfg #	Model	Size	Price
157090	0123483	LFSC5	1/2" MIP or Swt	
157091	0123484	LFSC6	3/4" MIP	



Meter Valves

Angle Inverted Key Meter Valves

Pack Joint For Copper or Plastic x Meter Swivel Nut



Valves

Part #	Mfg #	Valve Size	Service Line	Meter Size	Price
004350	KV43-332W	3/4"	3/4"	5/8" x 3/4" & 3/4"	
004386	KV43-341W	3/4"	1"	5/8"	

Meter Valves

Commercial Balancing/Flow Valves

CSM-61 Series Bronze Flow Measurement Valve

- Used for hot or chilled water units for system balancing/flow measurement
- For fan coil units, unit ventilators, water source heat pumps, finned radiation, reheat coils, unit heaters and more



CSM-61-M1-S (Swt)

Part #	Mfg #	Model	Size	Price
180200	0856810	LFCSM61M1S	3/4"	
179998	0856811	LFCSM61M1S	1"	

CSM-61-M2-S (Swt)

Part #	Mfg #	Model	Size	Price
043157	0856814	LFCSM61M2S	2"	

Meter Valves

LFWAMV Brass Angle Meter Valve

- Cast Lead Free* cast copper silicon alloy
- Available with or without waste feature
- Angle pattern models



Part #	Mfg #	Model	Size	Price
157027	0123018	LFAMSV	1" x 3/4"	

Relief Valves

Water Heater Installation Products

100DT Series Drain Lines for T&P Relief Valve

- Connects to 3/4" T&P relief drain connections
- For use on T&P relief valves up to 100,000 BTUH



Part #	Mfg #	Model	For Use With:	Price
008984	0066125	100DT	Side-Mount RV	

315 Steam Safety Relief Valve



Part #	Mfg #	Model	Size	Price
157305	0342629	315-M2	3/4" 15	

ASME Hot Water Boiler Relief Valves

Boiler Pressure Relief Valve

- ASME Section IV
- For hot water heating and supply boilers
- Pressure protection only
- Standard pressure relief setting: 30 psi



LF174A Bronze Body (FNPT Inlet x Outlet - Drain)

Part #	Mfg #	Model	Size	PSI	Price
157290	0121470	LF174A	3/4"	75	
157291	0121475	LF174A	3/4"	100	
157292	0121479	LF174A	3/4"	125	
157293	0121484	LF174A	3/4"	150	
157294	0121504	LF174A	1"	125	

Bronze Body (FNPT Inlet x Outlet)

Part #	Mfg #	Model	Size	Price
165735	0275022	174A	1" 40	
165738	0275118	174A	1" 70	
165737	0275178	174A	1" 85	
165739	0278329	174A	2" 60	

740 Series ASME Iron Body Water Pressure Safety Relief Valve

- ASME Section IV
- For hot water heating boiler pressure protection
- Expanded outlet drain connections



740 (FNPT Inlet x Outlet - Drain)

Part #	Mfg #	Model	Size	PSI	Price
165734	0384240	740	2" 40		
011293	0382008	740M1	3/4" x 1" 30		

T&P Safety Relief Valves

Self-Closing T&P Valve

- For hot water storage tanks and heaters
- Thermo-bonded (non-metallic) protective coating on thermostat
- Fully automatic, includes test levers
- Bronze body with stainless steel spring

10L, 100XL Series ASME (MNPT Inlet x FNPT Outlet)

- ASME Section IV
- For tanks and heaters with extra thick insulation, use Watts L100XL, LL100XL, or LLL100XL
- For new generation water heaters containing extra thick insulation, send for literature ES-SL100XL/LLL100XL
- Prefix options:
 - L - Extended inlet shank for water heaters with up to 2" thick insulation
 - LLL - Extended inlet shank for water heaters with up to 3" thick insulation
- Suffix options:
 - XL-8 With 8" extension thermostat



Part #	Mfg #	Model	Size	PSI	Price
156641	0556000	LF100XL3/4	3/4" 150/200		
157261	0556001	LF100XL8	3/4" 150		
156643	0556002	LFLL100XL	3/4" 150/210		
156644	0556003	LF100XL3	3/4" 150		

Relief Valves

40 Series ASME Automatic Reseating T&P Valve

- ASME Section IV
 - For hot water supply tanks and heaters
 - Fully automatic, tamper-resistant bonnet screws
 - Series 40 and 140 feature unique thermostat with special thermo-bonded coating
 - Series 140 sizes 1" and above are standard furnished with stainless steel thermostat tube
 - Bronze body construction
 - Suffix options:
 - XL = Test lever and extension thermostat
- ASME (MNPT Inlet x FNPT Outlet)**



Part #	Mfg #	Model	Size	PSI	Price
010931	0153614	40L	3/4"	150	
010934	0156481	40XL	3/4"	125	
022492	0158774	40XL8	3/4"	150	
010932	0163725	40XL4	1"	150	

Pressure Relief Valves

Calibrated Pressure Relief Valve

- For commercial, residential and industrial applications to protect against excessive pressure in systems containing water, oil, or air

LF530C Calibrated Pressure Relief Valve

- Lead Free* brass
- Stainless steel springs
- Calibrated adjustment feature
- Protects against buildup of excessive pressure
- For use in systems containing water, oil, and air



Part #	Mfg #	Model	Size	Price
157306	0556035	LF530-C	1/2"	

Poppet Type Water Heater Pressure Relief Valve

- For protection against excessive pressure and pressure emergency conditions
- Fully automatic, includes test levers

LF3L ASME (MNPT Inlet x FNPT Outlet)

- Used in conjunction with model 210 gas shut-off valve on gas water heaters to shut off gas to heater at 210°F



Part #	Mfg #	Model	Size	PSI	Price
157249	0556034	LF3L	3/4"	150	

TWS Through the Wall Water Supply Shutoff

- Standardizes location of supply shutoff valve and drain connection
- Access available anytime for winterizing
- Durable bronze valve body and shaft
- One piece valve plunger
- Tamper resistant key operated hydrant
- Exterior chrome finish
- Resilient seated shutoff
- Union connection for ease of installation of backflow preventer
- Manual drain port



Part #	Mfg #	Model	Size	Price
107126	0722046	TWS-10	1"	

Valves

Relief Valves

Tankless Water Heater Valves

LFTWH Series Tankless Water Heater Valve

- Replace up to 18 fittings and 16 connections used in typical tankless water heater installations
- Hot and cold water valve set
- 3/4" FPT Union connections
- Full-port, quarter-turn ball valve with color-coded tee handle and union
- Quarter-turn purge and drain valve with hose connection and tethered brass cap
- 600 WOG Rated



Valves

Part #	Mfg #	Model	Description	Price
157060	0100156	LFTWHFTHCNRV	Relief Valve	
156424	0100165	LFTWH-UTS-HCN	Relief Valve	
157059	0120001	LFTWH-UT-HC-RV	3/4"	

Relief Valves

Tankless Water Heater Installation Kits

Tankless Service Valve Kit



Part #	Mfg #	Description	Price
135157	TWV30RX	3/4" IPS x IPS Service Valve Kit with Pressure Relief Valve	
135158	TWV3SRX	3/4" Swt x IPS Service Valve Kit with Pressure Relief Valve	

Valves



Relief Valves

Specialty Valves & Fittings

2600T Pressure Reducing Valve - Single Union



Part #	Mfg #	Size	Price
136118	2600T-3/4	3/4"	

Valves

Relief Valves

ASME Hot Water Boiler Safety Relief Valves

10 Series Hot Water Boiler ASME Safety Relief Valve- Brass Finish

- For hot water boilers and hydronic heating systems
- Protects against excessive water pressure and steam generated when BTU input controls fail
- Maximum temperature service to 250°F
- Stainless steel springs standard except 10-214
- ASME Section IV

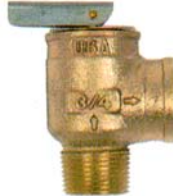

10 Series (MNPT Inlet x FNPT Outlet)

Part #	Mfg #	Size	Wt/ 100 Lbs	Set Press	Price
003009	10-407-05	3/4" M x F	62	30 psig	

13 Series Low Pressure Steam Heating Boiler Safety Valve

- ASME Section IV
- Capacity certified by National Board at 15 psi only in accordance with ASME Boiler and Pressure Vessel Code - Section IV
- All bronze construction
- Flat seat, Teflon® faced disc for positive seal
- Top guided, high capacity



13 Series Side Outlet Model (MNPT Inlet x FNPT Outlet)

Part #	Mfg #	Size	Wt/ 100 Lbs	Set Press	Price
122404	13-211-B15	3/4" M x F	475	15 psig	
003016	13-213B-15	1-1/4" M x 1-1/2" F	1200	15 psig	

Vacuum Breakers

AVB1 (38 Series) Atmospheric Type Vacuum Breaker (FNPT Inlet x Outlet)

- For hot and cold water service up to 212°F @ 125 psig
- Compact and lightweight
- Protects against back-siphonage and low hazard cross connections
- Cast bronze finish options:
 - RB= Rough Brass



Part #	Mfg #	Size	Finish	Price
102861	38-104-01	3/4"	RB	

Sillcock Valves

Sillcock Valves

ProLine™ Heavy-Duty Brass Sillcock Valve with
Lockshield

Part #	Mfg #	Size	Price
013025	108-013	1/2"	
014604	108-014	3/4"	

Valves

Stop Valves

Stop Valves

Stop & Waste Shut-Off Valve

- 150 psi WOG

Part #	Mfg #	Model	Size	Price
157117	0123612	LFSWT	1/2" FIP	
157119	0123616	LFSWS	1/2" Swt	
157118	0123613	LFSWT	3/4" Comp	

Stop Valve

- 150 psi WOG

Part #	Mfg #	Model	Size	Price
013204	0820846	ST	1/2" FIP	
014765	0820845	ST	3/4" FIP	
014768	0820851	SS	3/4" Swt	
013199	0820850	SS	1/2" Swt	

Stop Valves

Valves

Stop Valves

Ball-Type Supply Stop

- Angle
- Lead-Free
- 1/4 Turn



Part #	Mfg #	Size	Price
196258	T-595	1/2"PEX x 3/8"O.D.	

Multi-Turn Supply Stop

- Angle
- Lead-Free
- Chrome



Part #	Mfg #	Size	Price
215160	T-581NL	5/8"O.D. x 1/4"O.D.	
215163	T-581NL	1/2"FIP x 3/8"O.D.	
215156	T-581NL	3/8"FIP x 3/8"O.D.	

Ball-Type Supply Stop

- Straight
- Lead-Free
- 1/4 Turn



Part #	Mfg #	Size	Price
196259	T-596	1/2"PEX x 3/8"O.D.	

Multi-Turn Supply Stop

- Dual Outlet
- Lead-Free
- Chrome



Part #	Mfg #	Size	Price
215165	T-587NL	5/8"O.D. x 3/8"O.D. x 1/4"	
215166	T-587NL	5/8"O.D. x 3/8"O.D. x 3/8"	

Multi-Turn Supply Stop

- Straight
- Lead-Free
- Chrome



Part #	Mfg #	Size	Price
215158	T-582NL	5/8"O.D. x 3/8"O.D.	
215159	T-582NL	1/2"FIP x 3/8"O.D.	
215164	T-582NL	3/8"FIP x 3/8"O.D.	
215161	T-582NL	3/8"O.D. x 3/8"O.D.	

Valves - Miscellaneous

Tempering/Mixing Valves

MMV Series Thermostatic Mixing Valve

- Use in domestic water systems at hot water source or at point of use to provide accurate outlet temperature control or in radiant control
- ASSE 1016, 1017, 1070 Listed CSA B-125 certified
- Maximum working pressure: 150 psi
- Outlet temperature range: 80° - 120°F



Part #	Mfg #	Model	Size	Connection	Price
157283	0559115	LFMMVM1US	1/2"	Union Swt	
157284	0559118	LFMMVM1US	3/4"	Union Swt	
157285	0559121	LFMMVM1-US	1"	Union Swt	
156647	0559116	LFMMVM1-UT	1/2"	Union Thrd	
157287	0559122	LFMMVM1-UT	1"	Union Thrd	

LF1170 Hot Water Temperature Control Valve

- Lead Free cast copper silicon alloy body construction
- Solid wax hydraulic principle thermostat assures dependable mixing of hot and cold water
- Thermostat controls both hot and cold water
- Models available with solder, thread, Pex, Quick-Connect or cpvc end connections
- Integral filter washers and check valves
- Adjustment cap with locking feature



Part #	Mfg #	Model	Size	Price
156650	0559100	LF1170M2-US	1/2"	
156649	0559104	LF1170M2-UT	3/4"	

Under Sink Guardian™ Professional USG-B Series Thermostatic Mixing Valve (Comp)

- Bronze body
- Built-in check valves
- Includes tamper resistant locking cap
- Maintains mixed water temperature to ± 3°F up to 120°F
- ASSE 1016 Listed



Part #	Mfg #	Model	Size	Price
157282	0204143	LFUSG-B-M2	3/8"	

WAS Series Anti-Sweat Valve for Water Closets - Adjustable

- For residential applications, mixes cold and hot water to avoid condensation build-up on the outside of the water closet and to temper the water inside the toilet tank
- Brass body construction with compression end and/or IPS connections
- Maximum temperature: 180°F



Part #	Mfg #	Model	Size	Price
021272	0215476	WAS	1/2"	

Boiler Fill Fittings

Residential Boiler Fill Fitting

- Provides ease of service for expansion tanks and water pressure regulator valves in closed loop hot water heating systems
- 3-Way ball valve design
- 1-Piece construction eliminates up to 11 threaded joints
- Drain port with integral ball valve
- Maximum temperature: 250°F
- Maximum pressure: 125 psi
- 0-30 psi Pressure gauge

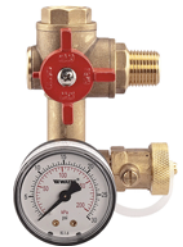

Part #	Mfg #	Model	Size	Price
131977	0386466	RBFF	1/2"	

Washing Machine Valves

2-M2 Series Washing Machine Water Shut-Off Valve

- Manually eliminates water pressure on supply hoses and prevents catastrophic water damage
- Controls hot and cold simultaneously
- Maximum pressure: 150 psi
- Maximum temperature: 180°F
- Bronze body, single lever on-off
- Dual copper adapters



Dual Elbow Adapter for 1/2" Swt or 1/2" Comp

Part #	Mfg #	Model	Size	Price
010893	0006644	2-M2	1/2"	

Dual Straight Adapter for 1/2" MNPT or 1/2" Swt

Part #	Mfg #	Model	Size	Price
010896	0006643	2TM2	1/2"	

Valves

Valves - Miscellaneous

Float Valves

Heavy Duty Mechanical Float Valve



Part #	Mfg #	Model	Size	Price
067226	0780003	500	1/2"	
067227	0780007	750	3/4"	

Valves

Valves - Miscellaneous

Thermostatic Mixing Valves

Navigator® EFX8 Thermostatic Mixing Valve

- 8 gpm at 30 psi
- Single valve design
- Factory pre-set at 85°F
- Adjustable temperature range: 65° to 95°F
- Universal mounting capability
- Positive shut-off of hot supply when cold supply is lost
- Built-in cold water bypass assures cold flow
- Easily installed and serviced
- Dial thermometer
- Rough bronze or chrome-plated finish
- Meets ANSI standard Z358.1-2009
- Reliable liquid filled thermostat with 10-year warranty



Navigator® S59-4000A Point-of-Use Thermostatic Mixing Valve with 3/8" Compression Fittings

- Easy installation and serviceability
- Factory-assembled and tested
- Lead-free brass and glass-filled polysulfone valve body provides superior strength
- Wax-filled thermostat ensures outlet temperature remains constant
- Certified by IAPMO
- ASSE 1070 & cUPC Certified



Valves

Part #	Mfg #	Description	Price
125362	S59-4000A	Point-of-Use Thermostatic Valve	

Part #	Mfg #	Description	Price
059075	S19-2000	Emergency Thermostatic Valve	

Navigator® EFX25 Thermostatic Mixing Valve

- 36 gpm at 30 psi
- Single valve design
- Factory pre-set at 85°F
- Adjustable temperature range: 65° to 95°F
- Universal mounting capability
- Positive shut-off of hot supply when cold supply is lost
- Built-in cold water bypass assures cold flow
- Easy installation and serviceability
- Dial thermometer
- Rough bronze or chrome-plated finish
- Meets ANSI standard Z358.1-2009
- Reliable liquid filled thermostat with 10-year warranty



Part #	Mfg #	Description	Price
071347	S19-2100	Emergency Thermostatic Valve	

Valves - Miscellaneous

Valves

Valve Tees

Add-A-Line™ Full-Slip Valve Tee (Trunk x Tee)

- Perfect for adding new water lines
- 5/8" or 7/8" OD Compression trunks provide easy and totally torchless installations
- 1-Piece forged brass compression and sweat tee body
- Quality brass ball valve replaces saddle valves

601-20V



Part #	Mfg #	Connection	Price
068535	601-30V	3/4" FSwt x 1/4" O.D. Comp	
067349	601-20CV	5/8" x 1/4" (O.D. Comp)	
068533	601-30CV	7/8" x 1/4" (O.D. Comp)	

PowerPEX® F1807 Ice Maker Valve

- For adding 1/4" OD supply lines for ice makers and humidifiers
- Lead-free solder joint

637XG9220



Part #	Mfg #	PEX x O.D. Comp	Type	Price
093427	637XG9220	1/2" x 1/4"	Tee	
170894	637XG920	1/2" x 1/4"	Straight	

Sweat Fittings & Valves

118-Series Frost-Proof Sillcock Vacuum Breaker Repair Kit

- Be sure to measure the stem you are replacing to guarantee correct replacement length

Part #	Mfg #	Includes:	Price
222220	118-08	Cap, Plunger & O-Ring	

Add-A-Line™ Full Slip Sweat Valve Tee

- Universal: works with all CTS pipe types
- Adding water lines has never been easier
- Perfect for adding humidifiers, dishwashers, ice makers or any new water line
- Attractive, clamshell packaging in a white cut case carton for peg hooks, counters or shelf displays

601-G20CV



Part #	Mfg #	OD Comp TrunkxOD Comp	Price
159741	601-G20CV	5/8" x 1/4"	
160210	601-G30CV	7/8" x 1/4"	

PDQ™ Add-A-Line™ Push Fittings—No Lead

- Plumbing done quickly
- Easy & fast compliant plumbing solutions
- Universal: works with all CTS pipe types
- Removable, replaceable, reusable.
- Adding water lines has never been easier
- Perfect for adding humidifiers, dishwashers, ice makers or any new water line
- Attractive, clamshell packaging in a white cut case carton for peg hooks, counters or shelf displays



601Q20V

Part #	Mfg #	PDQ x OD Comp	Price
186869	601Q20V	1/2" x 1/4"	
184847	601Q30V	3/4" x 1/4"	

Valves - Miscellaneous

Brass Needle Valves

Angle Compression - Brass (Comp x MIP)



Part #	Mfg #	Size	Price
037537	N10-442	1/4" x 1/8"	

Self-Piercing Valve - Brass

- 1/4" OD Compression outlet
- Fits 3/8" - 1.315" OD tube



Part #	Mfg #	Tube Size	Price
005888	S92-001	1/4"	

Valves - Miscellaneous

Valves

Resun® Cast Iron Lubricated Plug Valves

R-1430 Rectangular Port, Regular Opening Plug Valve

- Wrench operated
- Working pressures:
 - 200 psi WOG, Threaded end
 - 125 psi SWP
- Principal parts and materials:
 - Plug - cast iron, ASTM A-126 class B
 - Baseplate - cast iron, ASTM A-126 class B
 - Baseplate spring - Stainless steel 17-7
 - Sealant screw - Commercial steel
 - Double ball check valve - Commercial steel
 - Gasket - glass filled TFE

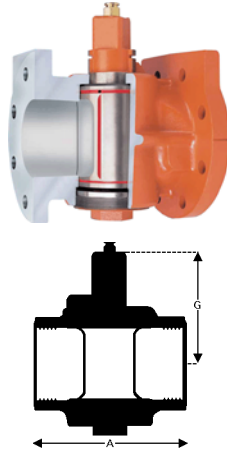

Part #	Mfg #	Size	Dimensions		Weight	Price
			A	G		
009721	R1430	1"	3-7/8"	2-1/2"	4 lbs	
009723	R1430	1-1/4"	5"	2-5/8"	5 lbs	
009722	R1430	1-1/2"	5"	2-3/4"	6 lbs	
009725	R1430	2"	5-3/4"	3-3/8"	9 lbs	

R-1431 Rectangular Port, Regular Opening Plug Valve

- Wrench operated
- Working pressures:
 - 200 psi WOG-Flanged end
 - 125 psi SWP
- Principal parts and materials:
 - Body - cast iron, ASTM A-126 class B
 - Plug - cast iron, ASTM A-126 class B
 - Baseplate - Cast iron, ASTM A-126 class B
 - Baseplate spring - Stainless steel 17-7
 - Sealant screw - Commercial steel
 - Double ball check valve - Commercial steel
 - Gasket - glass filled TFE
 - Body sealant fitting - Commercial steel (8", 10" & 12" only)

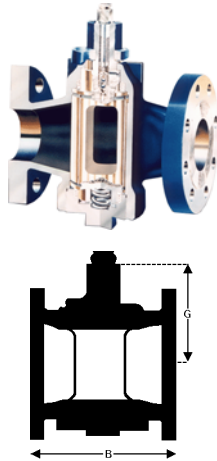

Part #	Mfg #	Size	Dimensions		Weight	Price
			B	G		
020968	R1431	2-1/2"	7-1/2"	5"	28 lbs	
009728	R1431	3"	8"	5-1/4"	38 lbs	
027892	R1431	4"	9"	6-5/8"	66 lbs	

Wye Strainers

Bronze Y-Strainers

S-221-A Bronze Y-Strainer with Wire Mesh Screen, Solder Ends

- Tapped cap with plug
- 20 Mesh stainless steel screen
- Non-shock cold working pressure: 200 psi/13.8 bar



Part #	Mfg #	Size	Price
132827	NJ2QA06	1/2"	
132825	NJ2QA08	3/4"	
132826	NJ2QA0A	1"	
132828	NJ2QA0B	1-1/4"	
132829	NJ2QA0C	1-1/2"	
132830	NJ2QA0D	2"	

T-221-A Bronze Y-Strainer with Wire Mesh Screen, Solder Ends

- Tapped cap with plug
- 20 Mesh stainless steel screen
- Non-shock cold working pressure: 200 psi/13.8 bar



Part #	Mfg #	Size	Price
132831	NL2QA06	1/2"	
132832	NL2QA08	3/4"	
132833	NL2QA0A	1"	
132834	NL2QA0B	1-1/4"	
132835	NL2QA0C	1-1/2"	

Iron Y-Strainers

F-721-A Iron Y-Strainer with Wire Mesh Screen, Flanged Ends

- Tapped cap with plug
- 20 Mesh stainless steel screen
- Dezincification resistant
- Non-shock cold working pressure: 200 psi/13.8 bar



Part #	Mfg #	Size	Price
132846	NHT000E	2-1/2"	
132847	NHT000F	3"	
132848	NHT000H	4"	
132850	NHT000K	6"	
132852	NHT000M	10"	

T-751-A Iron Y-Strainer with Wire Mesh Screen, Threaded Ends

- Tapped cap with plug
- 20 Mesh stainless steel screen
- Non-shock cold working pressure: 200 psi/13.8 bar



Part #	Mfg #	Size	Price
132838	NLT1006	1/2"	
132839	NLT1008	3/4"	
132840	NLT100A	1"	
132841	NLT100B	1-1/4"	
132842	NLT100C	1-1/2"	
132843	NLT100D	2"	

Wye Strainers

Valves

Commercial Y-Strainers

Iron Body Y-Type Strainer (End Flanged)

- For liquid or steam service to protect valves, backflow preventers and similar controls from foreign matter



77F-DI - ANSI 125 with Tapped Closure Plug (Flg)

- 125 psi WSP/200 psi WOG

Part #	Mfg #	Model	Size	Price
022414	0825202	77FDI-125	3"	
022415	0825203	77FDI-125	4"	

77F-DI - Epoxy Coated FDA Approved - ANSI 125 with Tapped Closure Plug (Flg)

- 200 psi WOG



Part #	Mfg #	Model	Size	Price
090681	0825210	77FDIFDA125	2-1/2"	
077920	0825211	77FDIFDA125	3"	
074524	0825212	77FDIFDA125	4"	
072090	0825214	77FDIFDA125	6"	

Cast Iron Y-Type Strainer

- For liquid or steam service
- Install upstream of equipment that need protection from scale, rust, dirt, etc

LF777SI WYE-Pattern Strainer, Tapped (FNPT)

- 250 psi WSP/400 psi WOG
- 2-1/2" and 3" have 3/64" perforated screen



Part #	Mfg #	Model	Size	Price
156653	0379111	LF777SI	1/2"	
156654	0379112	LF777SI	3/4"	
156655	0379113	LF777SI	1"	
156656	0379114	LF777SI	1-1/4"	
156657	0379115	LF777SI	1-1/2"	
156658	0379116	LF777SI	2"	

LFS777SI WYE-Pattern Strainer, Tapped (C)



Part #	Mfg #	Model	Size	Price
156659	0379119	LFS777SI	1/2"	
156660	0379120	LFS777SI	3/4"	
156662	0379121	LFS777SI	1"	
156663	0379122	LFS777SI	1-1/4"	
156664	0379123	LFS777SI	1-1/2"	
156665	0379124	LFS777SI	2"	

LF777 WYE-Pattern Strainer

- Lead Free* cast copper silicon alloy body
- Wye-pattern
- Solid retainer cap with gasket



Part #	Mfg #	Model	Size	Price
157309	0123086	LF777M1-20	3/4"	
157308	0124002	LF777SM1-20	3/4"	
157310	0124003	LF777SM1-20	1"	
157312	0124005	LF777SM1-20	1-1/2"	
157307	0124006	LF777SM3-20	2"	

Bath Accessories

Drawer Pulls & Knobs

- Tools and template included for installation

Archer® Drawer Knob



Part #	Mfg #	Description	Price
182997	K-11485-CP	Polished Chrome	

Archer® Drawer Pull



Part #	Mfg #	Description	Price
158114	K-11486-BN	*Brushed Nickel	
182998	K-11486-CP	Polished Chrome	

Artifacts® Drawer Knob



Part #	Mfg #	Description	Price
183645	K-72578-BN	*Brushed Nickel	
183647	K-72578-BV	*Brushed Bronze	
183648	K-72578-CP	Polished Chrome	
174465	K-72578-SN	*Polished Nickel	
183650	K-72578-2BZ	Oil-Rubbed Bronze	

Artifacts® Drawer Pull



Part #	Mfg #	Description	Price
183651	K-72579-SN	*Polished Nickel	

Bancroft™ Drawer Knob



Part #	Mfg #	Finish	Price
126037	K-11425-CP	Polished Chrome	
187833	K-11425-2BZ	Oil-Rubbed Bronze	

Composed® Drawer Pull



Part #	Mfg #	Description	Price
232039	K-73152-CP	Polished Chrome	

Damask™ Drawer Knob



Part #	Mfg #	Description	Price
183694	K-99686-HF1	Chrome	
185571	K-99686-HF2	Brushed	

Damask™ Drawer Pull



Part #	Mfg #	Description	Price
187730	K-99689-HF1	Chrome	
185570	K-99689-HF2	Brushed	

Devonshire® Drawer Knob



Part #	Mfg #	Description	Price
168315	K-10575-BN	*Brushed Nickel	
137255	K-10575-BV	*Brushed Bronze	
227983	K-10575-CP	Chrome	
146960	K-10575-2BZ	Oil-Rubbed Bronze	

Devonshire® Drawer Pull



Part #	Mfg #	Finish	Price
138190	K-10576-BN	*Brushed Nickel	
137256	K-10576-BV	*Brushed Bronze	
227985	K-10576-CP	Chrome	
146961	K-10576-2BZ	Oil Rubbed Bronze	

Forte® Drawer Knob



Part #	Mfg #	Description	Price
160267	K-11284-CP	Polished Chrome	
163788	K-11284-BN	*Brushed Nickel	
135025	K-11284-BV	*Brushed Bronze	

* Vibrant Limited Lifetime Warranty

www.plumbsupply.com • Serving our Customers Since 1946 • www.waterconcepts.net

Bath Accessories

Forte® Drawer Pull



Part #	Mfg #	Description	Price
155646	K-11285-CP	Polished Chrome	
156029	K-11285-BN	*Brushed Nickel	

Jacquard™ Ring Pull



Part #	Mfg #	Description	Price
183693	K-99685-HF1	Chrome	
181475	K-99685-HF2	Brushed	

Jute™ Bar Pull



Part #	Mfg #	Description	Price
168236	K-99688-HF1	Chrome	
169515	K-99688-HF2	Brushed	

Kelston® Drawer Knob



Part #	Mfg #	Description	Price
183463	K-13552-CP	Polished Chrome	

Kelston® Drawer Pull



Part #	Mfg #	Description	Price
183464	K-13554-CP	Polished Chrome	
146997	K-13554-2BZ	Oil-Rubbed Bronze	

Loure® Cabinet Knob



Part #	Mfg #	Description	Price
163167	K-11575-CP	Polished Chrome	

Drawer Pulls & Knobs (Continued)

Loure® Cabinet Knob

Part #	Mfg #	Description	Price
133515	K-11575-BN	*Brushed Nickel	

Lyntier® Drawer Knob



Part #	Mfg #	Description	Price
163367	K-11762-BV	*Brushed Bronze	

Margaux® Drawer Knob



Part #	Mfg #	Description	Price
141170	K-16262-CP	Polished Chrome	
112141	K-16262-BN	*Brushed Nickel	
124081	K-16262-BV	*Brushed Bronze	
157444	K-16262-SN	*Polished Nickel	
124109	K-16262-AF	*French Gold	

Margaux® Drawer Pull



Part #	Mfg #	Description	Price
112140	K-16263-BN	*Brushed Nickel	
124080	K-16263-BV	*Brushed Bronze	
146391	K-16263-CP	Polished Chrome	
183021	K-16263-SN	*Polished Nickel	

Memoirs® Stately Drawer Pull



Part #	Mfg #	Description	Price
142282	K-523-CP	Polished Chrome	
153892	K-523-BN	*Brushed Nickel	
158649	K-523-BV	*Brushed Bronze	
188935	K-523-2BZ	Oil-Rubbed Bronze	

* Vibrant Limited Lifetime Warranty

www.waterconcepts.net • Serving our Customers Since 1946 • www.plumbsupply.com

Bath Accessories

Memoirs® Stately Drawer Knob



Part #	Mfg #	Description	Price
144455	K-522-CP	Polished Chrome	
153893	K-522-BN	*Brushed Nickel	
188933	K-522-2BZ	Oil-Rubbed Bronze	

Pinstripe® Drawer Pull



Part #	Mfg #	Description	Price
183002	K-13125-CP	Polished Chrome	

Pinstripe® Drawer Knob



Part #	Mfg #	Description	Price
183003	K-13126-CP	Polished Chrome	

Poplin™ Drawer Pull

- Premium metal construction



Part #	Mfg #	Description	Price
170473	K-99687-HF1	Polished Chrome	
166445	K-99687-HF2	Brushed	
168877	K-99687-HF3	Black	

Purist® Drawer Knob



Part #	Mfg #	Description	Price
182962	K-14484-BN	*Brushed Nickel	
185006	K-14484-BV	*Brushed Bronze	
151257	K-14484-SN	*Polished Nickel	

Purist® 3" Drawer Pull



Part #	Mfg #	Description	Price
137294	K-14485-BN	*Brushed Nickel	
185002	K-14485-BV	*Brushed Bronze	
154617	K-14485-CP	Polished Chrome	
183015	K-14485-SN	*Polished Nickel	

Revival® Drawer Knob



Part #	Mfg #	Description	Price
157872	K-16295-BN	*Brushed Nickel	
144371	K-16295-BV	*Brushed Bronze	

Revival® Drawer Pull



Part #	Mfg #	Description	Price
157873	K-16296-BN	*Brushed Nickel	
183023	K-16296-BV	*Brushed Bronze	

Stillness® Drawer Pull



Part #	Mfg #	Description	Price
186200	K-14386-BN	*Brushed Nickel	

Glass Shelves

Devonshire® Single Glass Shelf

- Included tempered-glass shelf
- Tools and installation template included
- 22"L x 5-1/2"W x 2-1/2"H



Part #	Mfg #	Description	Price
099135	K-10563-CP	Polished Chrome	
090871	K-10563-BN	*Brushed Nickel	
153725	K-10563-BV	*Brushed Bronze	
089612	K-10563-PB	* Polished Brass	
146959	K-10563-2BZ	Oil-Rubbed Bronze	

* Vibrant Limited Lifetime Warranty

www.plumbsupply.com • Serving our Customers Since 1946 • www.waterconcepts.net

Bath Accessories

Forté Glass Shelf

- L22" x W5-3/4" x H3-11/16"
- Includes tempered-glass shelf
- Tools for installation included



Part #	Mfg #	Description	Price
085353	K-11283-CP	Polished Chrome	

Pinstripe® Single Glass Shelf

- Includes tempered-glass shelf
- Tools and installation template included
- 24"L x 6-5/8"W x 3-3/8"H



Part #	Mfg #	Description	Price
152010	K-13147-BN	*Brushed Nickel	

Purist® Glass Shelf

- L22-1/2" x W4-7/8" x H1-7/8"
- Includes tempered-glass shelf
- Installation tools included



Part #	Mfg #	Description	Price
073312	K-14440-CP	Polished Chrome	

Stillness® Glass Shelf

- Includes tempered-glass shelf
- Tools and installation template included
- 22-1/2" x 4-9/16" x 1-7/8"



Part #	Mfg #	Description	Price
176131	K-14455-CP	Polished Chrome	

Light Sconces

Bancroft® Wall Sconce

- Frosted-glass shades
- Sconces can be positioned up or down
- CUL- and UL-approved up to 100 watts



Part #	Mfg #	Description	Price
131696	K-11421-CP	1-Globe, Chrome	
124994	K-11422-CP	2-Globe, Chrome	
132914	K-11423-BN	3-Globe, *Brushed Nickel	
124223	K-11423-BV	3-Globe, *Br. Bronze	
132143	K-11423-CP	3-Globe, Chrome	
182996	K-11423-SN	3-Globe, *Pol	
187787	K-11423-2BZ	3-Globe, Oil-Rubbed Brz	

Devonshire® Wall Sconce

- Frosted-glass shades
- Sconces can be positioned up or down
- CUL- and UL-approved up to 100 watts



Part #	Mfg #	Description	Price
095251	K-10570-BN	1-Globe, *Brushed Nickel	
094341	K-10570-CP	1-Globe, Polished Chrome	
185600	K-10570-SN	1-Globe, *Polished Nickel	
178418	K-10570-2BZ	1-Globe, Oil-Rubbed Bronze	
088463	K-10571-BN	2-Globe, *Brushed Nickel	
182986	K-10571-BV	2-Globe, *Brushed Bronze	
097831	K-10571-CP	2-Globe, Polished Chrome	
164149	K-10571-2BZ	2-Globe, Oil-Rubbed Bronze	
113844	K-10572-BN	3-Globe, *Brushed Nickel	
152202	K-10572-BV	3-Globe, *Brushed Bronze	
102666	K-10572-CP	3-Globe, Polished Chrome	
188513	K-10572-SN	3-Globe, *Polished Nickel	
166028	K-10572-2BZ	3-Globe, Oil-Rubbed Bronze	

Forte® Wall Sconce

- Frosted-glass shades
- Sconces can be positioned up or down
- CUL- and UL-approved up to 100 watts



Part #	Mfg #	Description	Price
097113	K-11365-BN	1-Globe, *Brushed Nickel	
091593	K-11365-CP	1-Globe, Polished Chrome	
099731	K-11365-G	1-Globe, Brushed Chrome	
095185	K-11366-BN	2-Globe, *Brushed Nickel	
093458	K-11366-CP	2-Globe, Polished Chrome	
098396	K-11366-G	2-Globe, Brushed Chrome	
103173	K-11367-BN	3-Globe, *Brushed Nickel	
104368	K-11367-CP	3-Globe, Polished Chrome	

* Vibrant Limited Lifetime Warranty

www.waterconcepts.net • Serving our Customers Since 1946 • www.plumbsupply.com

Bath Accessories

Light Sconces (Continued)

Forte® Wall Sconce

Part #	Mfg #	Description	Price
115073	K-11367-G	3-Globe, Brushed Chrome	

Margaux® Wall Sconce

- Frosted-glass shades
- Requires T-10 bulb



Part #	Mfg #	Description	Price
223372	K-16268-SN	1-Globe, Polished Nickel	

Purist® Wall Sconce



Part #	Mfg #	Description	Price
175746	K-14483-BN	1-Globe, *Brushed Nickel	
167283	K-14483-CP	1-Globe, Polished Chrome	
170467	K-14483-SN	1-Globe, *Pol Nickel	

Brush Caddy's

Reset™ Brush Caddy

- Includes removable silicone drip tray
- Tip resistant design
- Rust-resistant stainless steel
- Dishwasher safe



Part #	Mfg #	Description	Price
172616	K-6378-0	White	

Rim Guards

Stainless Steel Rim Guard

- For use with K-12867 Camerton™ and K-6676 Tyrell™ service sinks



Part #	Mfg #	Description	Price
064178	K-8935-NA	Stainless Steel	

Whirlpool Remote Control

- For use with KOHLER® Experience whirlpools with neckjets or BubbleMassage™
- Includes stand



Part #	Mfg #	Description	Price
182815	K-1705-NA	Not Applicable	

Overflow Caps

Escale® Lavatory Overflow Cap

- For use with: Escale®, Reve™, Leaf™, Fit™, and Ronde™



Part #	Mfg #	Description	Price
113952	K-4061-BN	*Brushed Nickel	
143258	K-4061-BV	*Brushed Bronze	
119576	K-4061-CP	Polished Chrome	
183056	K-4061-SN	*Polished Nickel	
147047	K-4061-2BZ	Oil-Rubbed Bronze	

Iron Plains® Overflow Cap

- For use with Iron Plain® bathroom sinks



Part #	Mfg #	Description	Price
176738	K-6324-2BZ	Oil-Rubbed Bronze	

* Vibrant Limited Lifetime Warranty

www.plumbsupply.com • Serving our Customers Since 1946 • www.waterconcepts.net

Bath Accessories

Miscellaneous

Artifacts® Finishing Ensemble

- Coordinated set includes glass soap dispenser, glass tumbler, and ceramic tray
- Premium metal construction
- Coordinates with other products in the Artifacts® collection



Part #	Mfg #	Description	Price
183686	K-72574-2BZ	Oil-Rubbed Bronze	
183638	K-72574-SN	*Polished Nickel	

Choreograph® Shower Tray

- 12"L x 1-1/8"H x 4-5/8"W
- Made of natural teak wood
- Easy snap-on installation
- For use with Choreograph® shower bars
- Clips and screws included



Part #	Mfg #	Description	Price
176729	K-97629-NA	12" x 1-1/8" x 4-5/8"	

Vanity Cabinets & Hardware

* Vibrant Limited Lifetime Warranty

www.waterconcepts.net • Serving our Customers Since 1946 • www.plumbsupply.com

Bath Accessories

Towel Bars & Rings

- Tools and template included for installation

Alteo® Towel Bar



Part #	Mfg#	Size	Finish	Price
143627	K-37050-BN	18"	*Brushed Nickel	
148510	K-37050-CP	18"	Polished Chrome	
152312	K-37050-2BZ	18"	Oil Rubbed Bronze	
142070	K-37051-BN	24"	*Brushed Nickel	
139657	K-37051-CP	24"	Polished Chrome	
149755	K-37051-2BZ	24"	Oil Rubbed Bronze	

Archer™ Towel Bar



Part #	Mfg#	Size	Finish	Price
147083	K-11050-BN	18"	*Brushed Nickel	
129549	K-11051-BN	24"	*Brushed Nickel	
142983	K-11051-CP	24"	Polished Chrome	
149469	K-11052-BN	30"	*Brushed Nickel	

Archer™ Double Towel Bar



Part #	Mfg#	Size	Finish	Price
131642	K-11053-BN	24"	*Brushed Nickel	
159056	K-11053-CP	24"	Polished Chrome	

Artifacts® Towel Bar



Part #	Mfg#	Size	Finish	Price
189564	K-72567-BV	18"	*Brushed Bronze	
173117	K-72567-CP	18"	Polished Chrome	
173106	K-72567-SN	18"	Polished Nickel	
223900	K-72567-VNT	18"	Vintage Nickel	
189563	K-72568-BV	24"	*Brushed Bronze	
173118	K-72568-CP	24"	Polished Chrome	
173107	K-72568-SN	24"	Polished Nickel	
175226	K-72569-CP	30"	Polished Chrome	

Artifacts® Double Towel Bar



Part #	Mfg#	Size	Finish	Price
166098	K-72570-BN	24"	*Brushed Nickel	
183635	K-72570-CP	24"	Polished Chrome	
181720	K-72570-SN	24"	*Polished Nickel	

Artifacts® Hotelier



Part #	Mfg#	Size	Finish	Price
166096	K-72575-BN	24"	*Brushed Nickel	
225927	K-72575-BV	24"	*Brushed Bronze	
183639	K-72575-CP	24"	Polished Chrome	
174463	K-72575-SN	24"	*Polished Nickel	
223902	K-72575-VNT	24"	Vintage Nickel	
183640	K-72575-2BZ	24"	Oil Rubbed Bronze	

Bancroft® Towel Bar



Part #	Mfg#	Size	Finish	Price
096188	K-11410-BN	18"	*Brushed Nickel	
176831	K-11410-BV	18"	*Brushed Bronze	
087295	K-11410-CP	18"	Polished Chrome	
185467	K-14410-SN	18"	* Polished Nickel	
186091	K-11410-2BZ	18"	Oil Rubbed Bronze	
098107	K-11411-BN	24"	*Brushed Nickel	
114841	K-11411-BV	24"	*Brushed Bronze	
091755	K-11411-CP	24"	Polished Chrome	
169806	K-11411-2BZ	24"	Oil Rubbed Bronze	
227248	K-11412-BV	30"	*Brushed Bronze	
094943	K-11412-CP	30"	Polished Chrome	

Bancroft® Double Towel Bar



Part #	Mfg#	Size	Finish	Price
096185	K-11413-BN	24"	*Brushed Nickel	
221957	K-11413-BV	24"	*Brushed Bronze	
092263	K-11413-CP	24"	Polished Chrome	
156668	K-11413-2BZ	24"	Oil Rubbed Bronze	

* Vibrant Limited Lifetime Warranty

www.plumbsupply.com • Serving our Customers Since 1946 • www.waterconcepts.net

Bath Accessories

Composed™ Towel Bar



Part #	Mfg#	Size	Finish	Price
225521	K-73142-CP	24"	Polished Chrome	

Composed™ Towel Arm



Part #	Mfg#	Size	Finish	Price
225522	K-73145-CP	8"	Polished Chrome	

Coralais® Towel Bar



Part #	Mfg#	Size	Finish	Price
113799	K-13430-BN	18"	*Brushed Nickel	
097477	K-13430-CP	18"	Polished Chrome	
117703	K-13430-G	18"	Brushed Chrome	
113800	K-13431-BN	24"	*Brushed Nickel	
097476	K-13431-CP	24"	Polished Chrome	
117702	K-13431-G	24"	Brushed Chrome	
117332	K-13432-BN	30"	*Brushed Nickel	
110530	K-13432-CP	30"	Polished Chrome	
129880	K-13432-G	30"	Brushed Chrome	

Devonshire® Towel Bar



Part #	Mfg#	Size	Finish	Price
075036	K-10550-BN	18"	*Brushed Nickel	
104786	K-10550-BV	18"	*Brushed Bronze	
074750	K-10550-CP	18"	Polished Chrome	
093586	K-10550-PB	18"	*Polished Brass	
190233	K-10550-SN	18"	*Polished Nickel	
146950	K-10550-2BZ	18"	Oil Rubbed Bronze	
078141	K-10551-BN	24"	*Brushed Nickel	
105043	K-10551-BV	24"	*Brushed Bronze	
073746	K-10551-CP	24"	Polished Chrome	
078151	K-10551-PB	24"	*Polished Brass	
146951	K-10551-2BZ	24"	Oil Rubbed Bronze	
085240	K-10552-BN	30"	*Brushed Nickel	
090179	K-10552-CP	30"	Polished Chrome	
146952	K-10552-2BZ	30"	Oil Rubbed Bronze	

Devonshire® Double Towel Bar



Part #	Mfg#	Size	Finish	Price
077002	K-10553-BN	24"	*Brushed Nickel	
105044	K-10553-BV	24"	*Brushed Bronze	
087653	K-10553-CP	24"	Polished Chrome	
079491	K-10553-PB	24"	*Polished Brass	
146953	K-10553-2BZ	24"	Oil Rubbed Bronze	

Fairfax™ Small Towel Bar Arm

Part #	Mfg#	Size	Finish	Price
069236	K-12155-BN	7-5/8"	*Brushed Nickel	
072314	K-12155-CP	7-5/8"	Polished Chrome	
160132	K-12155-2BZ	7-5/8"	Oil Rubbed Bronze	

Fairfax® Towel Bar



Part #	Mfg#	Size	Finish	Price
069235	K-12150-BN	18"	*Brushed Nickel	
096880	K-12150-CP	18"	Polished Chrome	
154609	K-12150-2BZ	18"	Oil Rubbed Bronze	
072140	K-12151-BN	24"	*Brushed Nickel	
077817	K-12151-CP	24"	Polished Chrome	
160134	K-12151-2BZ	24"	Oil Rubbed Bronze	
073503	K-12152-BN	30"	*Brushed Nickel	
161756	K-12152-CP	30"	Polished Chrome	
159423	K-12152-2BZ	30"	Oil Rubbed Bronze	

Finial Towel Bar



Part #	Mfg#	Size	Finish	Price
080562	K-360-AF	24"	*French Gold	
071741	K-360-BN	24"	*Brushed Nickel	
077356	K-360-BV	24"	*Brushed Bronze	
076225	K-360-CP	24"	Polished Chrome	
180594	K-360-2BZ	24"	Oil Rubbed Bronze	

* Vibrant Limited Lifetime Warranty

www.waterconcepts.net • Serving our Customers Since 1946 • www.plumbsupply.com

Bath Accessories

Forté® Sculpted Towel Bar



Part #	Mfg#	Size	Finish	Price
080262	K-11370-BN	18"	Brushed Nickel	
090509	K-11370-CP	18"	Polished Chrome	
087273	K-11370-G	18"	Brushed Chrome	
082752	K-11371-BN	24"	*Brushed Nickel	
084207	K-11371-CP	24"	Polished Chrome	
087272	K-11371-G	24"	Brushed Chrome	
086148	K-11372-BN	30"	*Brushed Nickel	
087206	K-11372-CP	30"	Polished Chrome	
100767	K-11372-G	30"	Brushed Chrome	

Forte® Traditional Towel Bar



Part #	Mfg#	Size	Finish	Price
087029	K-11270-BN	18"	*Brushed Nickel	
092004	K-11270-CP	18"	Polished Chrome	
088018	K-11270-G	18"	Brushed Chrome	
089531	K-11271-BN	24"	*Brushed Nickel	
092003	K-11271-CP	24"	Polished Chrome	
088017	K-11271-G	24"	Brushed Chrome	
087030	K11272BN	30"	*Brushed Nickel	
085436	K-11272-CP	30"	Polished Chrome	
098393	K-11272-G	30"	Brushed Chrome	

Kelston® Towel Bar



Part #	Mfg#	Size	Finish	Price
136649	K-13500-BN	18"	*Brushed Nickel	
168610	K-13500-CP	18"	Polished Chrome	
146990	K-13500-2BZ	18"	Oil Rubbed Bronze	
134488	K-13501-BN	24"	*Brushed Nickel	
161338	K-13501-CP	24"	Polished Chrome	
146991	K-13501-2BZ	24"	Oil Rubbed Bronze	
137138	K-13502-BN	30"	*Brushed Nickel	
165430	K-13502-CP	30"	Polished Chrome	
146992	K-13502-2BZ	30"	Oil Rubbed Bronze	

Kelston® Double Towel Bar



Part #	Mfg#	Size	Finish	Price
134490	K-13503-BN	24"	*Brushed Nickel	
183005	K-13503-CP	24"	Polished Chrome	
146993	K-13503-2BZ	24"	Oil Rubbed Bronze	

Loure® Towel Arm



Part #	Mfg#	Finish	Price
122449	K-11586-CP	Polished Chrome	

Loure® Towel Bar



Part #	Mfg#	Size	Finish	Price
165334	K-11580-BN	18"	*Brushed Nickel	
122445	K-11580-CP	18"	Polished Chrome	
155634	K-11581-BN	24"	*Brushed Nickel	
122446	K-11581-CP	24"	Polished Chrome	
227500	K-11581-SN	24"	*Polished Nickel	
133512	K-11588-BN	30"	*Brushed Nickel	
122447	K-11588-CP	30"	Polished Chrome	

Loure® Double Towel Bar



Part #	Mfg#	Size	Finish	Price
122448	K-11582-CP	24"	Polished Chrome	

Margaux™ Towel Bar



Part #	Mfg#	Size	Finish	Price
109461	K-16250-BN	18"	*Brushed Nickel	
124074	K-16250-BV	18"	*Brushed Bronze	
111196	K-16250-CP	18"	Polished Chrome	
136651	K-16250-SN	18"	Polished Nickel	
183019	K-16251-AF	24"	*French Gold	
112992	K-16251-BN	24"	*Brushed Nickel	

* Vibrant Limited Lifetime Warranty

www.plumbsupply.com • Serving our Customers Since 1946 • www.waterconcepts.net

Bath Accessories

Towel Bars & Rings (Continued)

Margaux™ Towel Bar

Part #	Mfg#	Size	Finish	Price
124075	K-16251-BV	24"	*Brushed Bronze	
141179	K-16251-CP	24"	Polished Chrome	
152947	K-16251-SN	24"	Polished Nickel	
137921	K-16252-CP	30"	Polished Chrome	

Memoirs® Towel Bar



Part #	Mfg#	Size	Finish	Price
061208	K-486-BN	24"	*Brushed Nickel	
075023	K-486-BV	24"	*Brushed Bronze	
074988	K-486-CP	24"	Polished Chrome	
174229	K-486-2BZ	24"	Oil Rubbed Bronze	

Memoirs® Double Towel Bar



Part #	Mfg#	Size	Finish	Price
135482	K-16253-SN	24"	*Polished Nickel	

Memoirs® Stately Towel Bar



Part #	Mfg#	Size	Finish	Price
188931	K-485-2BZ	18"	Oil Rubbed Bronze	

Pinstripe® Towel Bar



Part #	Mfg #	Description	Price
106096	K-13109-CP	24" Polished Chrome	

Purist® Towel Bar



Part #	Mfg#	Size	Finish	Price
090892	K-14435-BN	18"	Brushed Nickel	
125811	K-14435-BV	18"	*Brushed Bronze	
069311	K-14435-CP	18"	Polished Chrome	
132494	K-14436-BGD	24"	*Moderne Brushed Gold	
086546	K-14436-BN	24"	*Brushed Nickel	
132500	K-14436-BV	24"	*Brushed Bronze	

Towel Bars & Rings (Continued)

Purist® Towel Bar

Part #	Mfg#	Size	Finish	Price
069312	K-14436-CP	24"	Polished Chrome	
097144	K-14436-SN	24"	*Polished Nickel	
089326	K-14437-BN	30"	*Brushed Nickel	
085195	K-14437-CP	30"	Polished Chrome	
149459	K-14437-SN	30"	*Polished Nickel	

Purist® Double Towel Bar



Part #	Mfg#	Size	Finish	Price
225301	K-14375-BN	24"	*Brushed Nickel	
223721	K-14375-BV	24"	*Brushed Bronze	
172064	K-14375-CP	24"	Polished Chrome	
183679	K-14375-SN	24"	*Polished Nickel	

Purist® Hotelier



Part #	Mfg#	Size	Finish	Price
162944	K-14381-BN	24"	*Brushed Nickel	
183011	K-14381-BV	24"	*Brushed Bronze	
182778	K-14381-CP	24"	Polished Chrome	

Stillness® Towel Bar



Part #	Mfg #	Description	Price
072157	K-14450-CP	18" Polished Chrome	
077073	K-14452-CP	30" Polished Chrome	

Toobi™ Towel Bar



Part #	Mfg#	Size	Finish	Price
172249	K-5666-BN	18"	*Brushed Nickel	
155340	K-5666-CP	18"	Polished Chrome	
153085	K-5667-BN	24"	*Brushed Nickel	
162267	K-5667-CP	24"	Polished Chrome	

* Vibrant Limited Lifetime Warranty

www.waterconcepts.net • Serving our Customers Since 1946 • www.plumbsupply.com

Bath Accessories

Toobi™ Double Towel Bar



Part #	Mfg#	Size	Finish	Price
223326	K-5668-CP	24"	Polished Chrome	

IV Georges Brass® Towel Bar



Part #	Mfg#	Size	Finish	Price
068589	K-6826-BN	24"	*Brushed Nickel	
105372	K-6826-BV	24"	*Brushed Bronze	

Towel Rings

Alteo® Towel Ring



Part #	Mfg #	Finish	Price
142072	K37057BN	*Brushed Nickel	
142899	K37057CP	Polished Chrome	
149757	K370572BZ	Oil Rubbed Bronze	

Archer® Towel Ring



Part #	Mfg #	Finish	Price
120025	K-11057-BN	*Brushed Nickel	
120083	K-11057-CP	Polished Chrome	

Artifacts® Towel Ring



Part #	Mfg #	Finish	Price
162103	K-72571-BN	*Brushed Nickel	
224548	K-72571-BV	*Brushed Bronze	
175228	K-72571-CP	Polished Chrome	
183636	K-72571-SN	*Polished Nickel	
223889	K-72571-VNT	Vintage Nickel	
183637	K-72571-2BZ	Oil Rubbed Bronze	

Bancroft™ Towel Ring



Part #	Mfg #	Finish	Price
096189	K-11416-BN	*Brushed Nickel	
119916	K-11416-BV	*Brushed Bronze	

Vanity Cabinets & Hardware

* Vibrant Limited Lifetime Warranty

www.plumbsupply.com • Serving our Customers Since 1946 • www.waterconcepts.net

Bath Accessories

Towel Rings (Continued)

Bancroft™ Towel Ring

Part #	Mfg #	Finish	Price
091754	K11416CP	Polished Chrome	
098453	K-11416-SN	*Polished Nickel	
162433	K-11416-2BZ	Oil Rubbed Bronze	

Coralais® Towel Ring



Part #	Mfg #	Finish	Price
111508	K-13435-BN	*Brushed Nickel	
098366	K-13435-CP	Polished Chrome	
125016	K-13435-G	Brushed Chrome	

Devonshire® Towel Ring



Part #	Mfg #	Finish	Price
075034	K-10557-BN	*Brushed Nickel	
086447	K10557BV	*Brushed Bronze	
073749	K-10557-CP	Polished Chrome	
078148	K-10557-PB	*Polished Brass	
146956	K-10557-2BZ	Oil Rubbed Bronze	

Fairfax® Towel Ring



Part #	Mfg #	Finish	Price
078771	K-12165-BN	*Brushed Nickel	
095555	K-12165-CP	Polished Chrome	
154611	K-12165-2BZ	Oil Rubbed Bronze	

Finial® Traditional Towel Ring



Part #	Mfg #	Finish	Price
080561	K-363-AF	*French Gold	
062461	K-363-BN	*Brushed Nickel	
091093	K-363-BV	*Brushed Bronze	
112920	K-363-CP	Polished Chrome	
074141	K-363-SN	*Polished Nickel	
152087	K-363-2BZ	Oil Rubbed Bronze	

Forté® Sculpted Towel Ring



Part #	Mfg #	Finish	Price
082751	K-11377-BN	*Brushed Nickel	
084210	K-11377-CP	Polished Chrome	
098281	K-11377-G	Brushed Chrome	

Forté® Traditional Towel Ring



Part #	Mfg #	Finish	Price
089528	K-11277-BN	*Brushed Nickel	
084058	K-11277-CP	Polished Chrome	

* Vibrant Limited Lifetime Warranty

www.waterconcepts.net • Serving our Customers Since 1946 • www.plumbsupply.com

Bath Accessories

Kelston® Towel Ring



Part #	Mfg #	Finish	Price
135326	K-13507-BN	*Brushed Nickel	
161342	K-13507-CP	Polished Chrome	
146995	K-13507-2BZ	Oil Rubbed Bronze	

Loure® Towel Ring



Part #	Mfg #	Finish	Price
129882	K-11587-BN	12", *Brushed Nickel	
130825	K-11587-CP	12", Polished Chrome	

Margaux™ Towel Ring



Part #	Mfg #	Finish	Price
183020	K-16254-AF	*French Gold	
109460	K-16254-BN	*Brushed Nickel	
124077	K-16254-BV	*Brushed Bronze	
119758	K-16254-CP	Polished Chrome	
135084	K-16254-SN	*Polished Nickel	

Memoirs® Stately Towel Ring



Part #	Mfg #	Finish	Price
061209	K-487-BN	*Brushed Nickel	
075025	K-487-BV	*Brushed Bronze	
072577	K-487-CP	Polished Chrome	

Towel Rings (Continued)

Memoirs® Stately Towel Ring

Part #	Mfg #	Finish	Price
170477	K-487-2BZ	Oil Rubbed Bronze	

Pinstripe® Towel Ring



Part #	Mfg #	Description	Price
106095	K-13112-CP	Polished Chrome	

Purist® Towel Ring



Part #	Mfg #	Finish	Price
132495	K-14441-BGD	*Moderne Brushed Gold	
080024	K-14441-BN	*Brushed Nickel	
132501	K-14441-BV	*Brushed Bronze	
091548	K-14441-CP	Polished Chrome	
148807	K-14441-SN	*Polished Nickel	

Revival® Towel Ring



Part #	Mfg #	Finish	Price
054871	K-16140-BN	*Brushed Nickel	
076861	K-16140-BV	*Brushed Bronze	
058876	K-16140-CP	Polished Chrome	
067095	K-16140-PB	*Polished Brass	

* Vibrant Limited Lifetime Warranty

www.plumbsupply.com • Serving our Customers Since 1946 • www.waterconcepts.net

Bath Accessories

Stillness® Towel Ring



Part #	Mfg #	Description	Price
072153	K-14456-CP	Polished Chrome	

Toobi™ Towel Ring



Part #	Mfg #	Finish	Price
151265	K-5671-BN	*Brushed Nickel	
167290	K-5671-CP	Polished Chrome	

Vanity Cabinets & Hardware

* Vibrant Limited Lifetime Warranty

www.waterconcepts.net • Serving our Customers Since 1946 • www.plumbsupply.com

Bath Accessories

Tissue Holders

Charlotte Tissue Holder



Part #	Mfg #	Description	Price
222852	695085-PC	Chrome	
176255	695085-BN	Brushed Nickel*	
148739	695085-PNCO	Cocoa Bronze & Pol Nickel	

Odin™ Tissue Holder



Part #	Mfg #	Description	Price
180708	695075-BN	Brushed Nickel*	
226376	695075-BL	Matte Black	

Litze™ Tissue Holder



Part #	Mfg #	Description	Price
229552	695035-NK	Luxe Nickel	

Siderna Tissue Holder



Part #	Mfg #	Description	Price
159348	695080-BL	Matte Black	
139359	695080-BN	Brushed Nickel*	
141651	695080-PC	Chrome	

Rook™ Tissue Holder



Part #	Mfg #	Description	Price
190001	695061-NK	Luxe Nickel*	
188713	695061-NKBL	Luxe Nickel/Matte Black	
188969	695061-PC	Chrome	

Sotria™ Tissue Holder



Part #	Mfg #	Description	Price
182226	695050-BL	Matte Black	
180763	695050-NK	Luxe Nickel*	
181915	695050-PC	Chrome	
187348	695050-PN	Polished Nickel*	

Traditional Tissue Holder



Part #	Mfg #	Description	Price
107467	69550-BN	Brushed Nickel*	
117040	69550-BZ	Brushed Bronze*	
079584	69550-PC	Chrome	
175473	69550-PN	Polished Nickel*	
085209	69550-RB	Venetian Bronze®	

Virage® Tissue Holder



Part #	Mfg #	Description	Price
134895	695030-BN	Brushed Nickel*	

Towel Rings

Charlotte™ Towel Ring



Part #	Mfg #	Description	Price
176253	694685-BN	Brushed Nickel*	
171443	694685-PC	Chrome	
148740	694685-PNCO	Cocoa Bronze & Pol Nickel	

Vanity Cabinets & Hardware

* Brilliance® Anti-Tarnish Lifetime Finishes

www.plumbsupply.com • Serving our Customers Since 1946 • www.waterconcepts.net

Bath Accessories

Odin™ Towel Ring



Part #	Mfg #	Description	Price
155262	694675-BN	Brushed Nickel*	
226374	694675-BL	Matte Black	

Siderna™ Towel Ring



Part #	Mfg #	Finish	Price
162489	694680-BL	Matte Black	
162500	694680-BN	Brushed Nickel*	
141655	694680-PC	Chrome	

Traditional Towel Ring



Part #	Mfg #	Description	Price
107466	69546-BN	Brushed Nickel*	
131964	69546-BZ	Brushed Bronze*	
081339	69546-PC	Chrome	
174834	69546-PN	Polished Nickel*	
085206	69546-RB	Venetian Bronze®	

Virage® Towel Ring



Part #	Mfg #	Description	Price
146534	694630-PC	Chrome	
134892	694630-BN	Brushed Nickel*	
140724	694630-RB	Venetian Bronze®	

Towel Bars

Charlotte™ Towel Bar



Part #	Mfg #	Description	Price
222854	691885-PC	18", Chrome	
181826	691885-BN	18", Brushed Nickel*	
166554	691885-PNCO	18", Cocoa Bronze & Pol Nkl	
222855	692485-PC	24", Chrome	
176254	692485-BN	24", Brushed Nickel*	
158270	692485-PNCO	24", Cocoa Bronze & Pol Nkl	

Charlotte™ Double Towel Bar



Part #	Mfg #	Description	Price
222853	692585-PC	24", Chrome	
166553	692585-PNCO	24", Cocoa Bronze & Pol Nkl	

Odin™ Towel Bar



Part #	Mfg #	Description	Price
165342	691875-BN	18", Brushed Nickel*	
166271	692475-BN	24", Brushed Nickel*	

Litze™ Towel Bar



Part #	Mfg #	Description	Price
229550	693035-NK	30", Luxe Nickel	

Rook™ Mini Towel Bar



Part #	Mfg #	Description	Price
188971	694761-PC	8" Polished Chrome	

Rook™ Towel Bar



Part #	Mfg #	Description	Price
223099	691861-NKBL	18", Luxe Nickel/Matte Black	
188972	692461-PC	24", Polished Chrome	

* Brilliance® Anti-Tarnish Lifetime Finishes

www.waterconcepts.net • Serving our Customers Since 1946 • www.plumbsupply.com

Bath Accessories

Siderna® Towel Bar



Part #	Mfg #	Description	Price
163539	691880-BN	18", Brushed Nickel*	
166140	691880-PC	18", Chrome	
162490	692480-BL	24", Matte Black	
139357	692480-BN	24", Brushed Nickel*	
141653	692480-PC	24", Chrome	

Sotria™ Towel Bar



Part #	Mfg #	Description	Price
182227	691850-BL	18", Matte Black	
179428	691850-PN	18", Polished Nickel*	
177254	692450-NK	24", Luxe Nickel*	

Sotria 8" Mini Towel Bar



Part #	Mfg #	Description	Price
177255	694750-NK	8", Luxe Nickel*	
181914	694750-PC	8", Chrome	

Traditional Towel Bar



Part #	Mfg #	Description	Price
222317	69518-PC	18", Chrome	
114917	69518-BN	18", Brushed Nickel*	
126231	69518-BZ	18", Brushed Bronze*	
175475	69518-PN	18", Polished Nickel*	
138260	69518-RB	18", Venetian Bronze®	
107468	69524-BN	24", Brushed Nickel*	
117039	69524-BZ	24", Brushed Bronze*	
159532	69524-PC	24", Chrome	
175476	69524-PN	24", Polished Nickel*	
085207	69524-RB	24", Venetian Bronze®	

Virage Towel Bar



Part #	Mfg #	Description	Price
134893	691830-BN	18", Brushed Nickel*	
177071	691830-BZ	18", Brushed Bronze*	
227603	691830-RB	18", Venetian Bronze®	
134894	692430-BN	24", Brushed Nickel*	

Towel Bars (Continued)

Virage Towel Bar

Part #	Mfg #	Description	Price
132575	692430-BZ	24", Brushed Bronze*	
146533	692430-PC	24", Chrome	
163800	692430-RB	24", Venetian Bronze®	

Grab Bars

Traditional Grab Bar

Part #	Mfg #	Description	Price
171841	69210-NK	12", Luxe Nickel*	
171843	69310-NK	24", Luxe Nickel*	

Providence™ Belle Traditional Decorative Grab Bar

- 1-1/4" Diameter
- Extends 2-3/4" from wall
- Concealed mounting
- 3" Diameter flanges
- 1-1/2" Wall clearance
- Supports up to 500 lbs.



Part #	Mfg #	Description	Price
188711	69310-PN	24" Polished Nickel*	

Drawer Knobs

Sotria Drawer Knob



Part #	Mfg #	Description	Price
225006	699250-PC	Chrome	

Rook™ Drawer Knob



Part #	Mfg #	Description	Price
188718	699261-NKBL	Luxe Nickel/Matte Black	

* Brilliance® Anti-Tarnish Lifetime Finishes

www.plumbsupply.com • Serving our Customers Since 1946 • www.waterconcepts.net

Bath Accessories

Rook™ Drawer Pull



Part #	Mfg #	Description	Price
188720	699161-NKBL	Luxe Nickel/Matte Black	

Mirrors & Medicine Cabinets

Virage Wall Mirror

• 20"W x 30"H



Part #	Mfg #	Description	Price
189235	698030-PC	Chrome	
186515	698030-PN	Polished Nickel*	

Vanity Cabinets & Hardware

* Brilliance® Anti-Tarnish Lifetime Finishes

www.waterconcepts.net • Serving our Customers Since 1946 • www.plumbsupply.com

Bath Accessories

Towel Rings
Addison® Towel Ring



Part #	Mfg #	Finish	Price
128420	79246	Chrome	
140639	79246-CZ	Champagne Bronze™	
129949	79246-RB	Venetian Bronze®	
128430	79246-SS	Stainless*	

Arzo Towel Ring



Part #	Mfg #	Description	Price
112699	77546	Chrome	
112700	77546-SS	Stainless*	

Ashlyn Towel Ring



Part #	Mfg #	Description	Price
174453	76446	Chrome	
172677	76446-RB	Venetian Bronze®	
173619	76446-SS	Stainless*	

Cassidy™ Towel Ring



Part #	Mfg #	Description	Price
156850	79746	Chrome	
153133	79746-CZ	Champagne Bronze™	
153344	79746-PN	Polished Nickel*	
151573	79746-RB	Venetian Bronze®	
151702	79746-SS	Stainless*	

Dryden™ Towel Ring



Part #	Mfg #	Finish	Price
117217	75146	Chrome	
148646	75146-CZ	Champagne Bronze™	
177157	75146-PN	Polished Nickel*	
117167	75146-SS	Stainless*	
116764	75146-RB	Venetian Bronze®	

Grail™ Towel Ring



Part #	Mfg #	Finish	Price
111858	77146	Chrome	
113014	77146-SS	Stainless*	

Lahara™ Towel Ring



Part #	Mfg #	Finish	Price
113770	73846	Chrome	
111496	73846-RB	Venetian Bronze®	
111522	73846-SS	Stainless*	

Leland® Towel Ring



Part #	Mfg #	Finish	Price
132450	77846	Chrome	
127559	77846-RB	Venetian Bronze®	
133258	77846-SS	Stainless*	

* Brilliance® Anti-Tarnish Lifetime Finishes

www.plumbsupply.com • Serving our Customers Since 1946 • www.waterconcepts.net

Bath Accessories

Linden™ Towel Ring



Part #	Mfg #	Finish	Price
143371	79446	Chrome	
144402	79446-CZ	Champagne Bronze™	
144559	79446-RB	Venetian Bronze®	
144200	79446-SS	Stainless*	

Victorian® Open Towel Ring

- 7-1/16" Ring
- Extends 3" from wall



Part #	Mfg #	Finish	Price
055722	75046-RB	Venetian Bronze®	
073347	75046-SS	Stainless*	

Tesla™ Towel Ring



Part #	Mfg #	Description	Price
181649	75246-SS	Stainless*	

Windemere® Towel Ring



Part #	Mfg #	Description	Price
159085	70046	Chrome	
166610	70046-OB	Oil-Rubbed Bronze	
167371	70046-SS	Stainless*	

Trinsic™ Towel Ring



Part #	Mfg #	Description	Price
153130	759460	Chrome	
186847	759460-CZ	Champagne Bronze™	
163074	759460-RB	Venetian Bronze®	
153360	759460-SS	Stainless*	

Towel Bars Addison® Towel Bar



Part #	Mfg #	Description	Price
129938	79218	18", Chrome	
126443	79218-RB	18", Venetian Bronze®	
127963	79218-SS	18", Stainless*	
128421	79224	24", Chrome	
137916	79224-CZ	24", Champagne Bronze™	
128429	79224-SS	24", Stainless*	
126444	79224-RB	24", Venetian Bronze®	
162381	79230	30", Chrome	
183315	79230-CZ	30", Champagne Bronze™	
160225	79230-RB	30", Venetian Bronze®	
159798	79230-SS	30", Stainless*	

Vero™ Towel Ring



Part #	Mfg #	Finish	Price
138387	77746	Chrome	
180009	77746-CZ	Champagne Bronze™	
149667	77746-RB	Venetian Bronze®	
138477	77746-SS	Stainless*	

Addison® Double Towel Bar



Part #	Mfg #	Description	Price
171208	79225	24", Chrome	
170713	79225-CZ	24", Champagne Bronze™	
162312	79225-RB	24", Venetian Bronze®	
162348	79225-SS	24", Stainless*	

* Brilliance® Anti-Tarnish Lifetime Finishes

www.waterconcepts.net • Serving our Customers Since 1946 • www.plumbsupply.com

Bath Accessories

Arzo® Towel Bar



Part #	Mfg #	Description	Price
112693	77518	18", Chrome	
112694	77518-SS	18", Stainless*	
112695	77524	24", Chrome	
112696	77524-SS	24", Stainless*	
175997	77530	30", Chrome	
174592	77530-SS	30", Stainless*	

Arzo Double Towel Bar



Part #	Mfg #	Description	Price
161530	77525	24", Chrome	
171631	77525-SS	24", Stainless*	

Ashlyn™ Towel Bar



Part #	Mfg #	Description	Price
175996	76418	18", Chrome	
176564	76418-RB	18", Venetian Bronze®	
173618	76418-SS	18", Stainless*	
174520	76424	24", Chrome	
172991	76424-RB	24", Venetian Bronze®	
174018	76424-SS	24", Stainless*	

Cassidy™ Towel Bar



Part #	Mfg #	Description	Price
171041	79712	12", Chrome	
174123	79712-RB	12", Venetian Bronze®	
160561	79712-SS	12", Stainless*	
153034	79718	18", Chrome	
151145	79718-CZ	18", Champagne Bronze™	
153035	79718-PN	18", Polished Nickel	
153036	79718-RB	18", Venetian Bronze®	
153037	79718-SS	18", Stainless*	
153038	79724	24", Chrome	
153039	79724-CZ	24", Champagne Bronze™	
153343	79724-PN	24", Polished Nickel*	
151571	79724-RB	24", Venetian Bronze®	

* Brilliance® Anti-Tarnish Lifetime Finishes

Towel Bars (Continued)

Cassidy™ Towel Bar

Part #	Mfg #	Description	Price
153041	79724-SS	24", Stainless*	
163144	79730	30", Chrome	
168309	79730-CZ	30", Champagne Bronze™	
170754	79730-PN	30", Polished Nickel*	
158699	79730-RB	30", Venetian Bronze®	
158142	79730-SS	30", Stainless*	

Cassidy™ Double Towel Bar



Part #	Mfg #	Description	Price
160677	79725	24", Chrome	
186110	79725-PN	24", Polished Nickel*	
160809	79725-RB	24", Venetian Bronze®	
167745	79725-SS	24", Stainless*	

Cassidy™ Glass Shelf with Bar



Part #	Mfg #	Description	Price
186497	79711	24", Chrome	
180597	79711-SS	24", Stainless*	

Cassidy™ Glass Shelf



Part #	Mfg #	Description	Price
153683	79710	Chrome	
174697	79710-RB	Venetian Bronze®	

Cassidy™ 24" Towel Bar/Assist Bar

- 7/8" diameter assist bar
- Extends 4-3/8" from wall
- Supports loads exceeding 250 lbs
- Mounting hardware included
- Retrievable assist bar wall anchor included



Part #	Mfg #	Description	Price
167065	41319-SS	24", Stainless*	

Vanity Cabinets & Hardware

Bath Accessories

Towel Bars (Continued)

Cassidy™ 24" Towel Bar/Assist Bar

Part #	Mfg #	Description	Price
162927	41319-RB	24", Venetian Bronze®	

Compel™ Towel Bar



Part #	Mfg #	Description	Price
113010	77118-SS	18", Stainless*	
113027	77124	24", Chrome	
113011	77124-SS	24", Stainless*	
175932	77130	30", Chrome	
182843	77130-SS	30", Stainless*	

Contemporary 24" Towel Bar/Assist Bar

- Supports loads exceeding 250 lbs



Part #	Mfg #	Description	Price
179497	41519	Chrome	
172779	41519-SS	Stainless*	

Delta 24" Double Towel Bar



Part #	Mfg #	Description	Price
171239	77125	24", Chrome	
175569	77125-SS	24", Stainless*	

Dryden™ Double Towel Bar



Part #	Mfg #	Description	Price
159636	75125	24", Chrome	
181105	75125-CZ	24", Champagne Bronze™	
160333	75125-SS	24", Stainless*	
211836	75125-RB	24", Venetian Bronze®	

Dryden™ Towel Bar



Part #	Mfg #	Description	Price
117208	75118	18", Chrome	
159516	75118-CZ	18", Champagne Bronze™	

Towel Bars (Continued)

Dryden™ Towel Bar

Part #	Mfg #	Description	Price
175057	75118-PN	18". Polished Nickel*	
117210	75118-RB	18", Venetian Bronze®	
117211	75118-SS	18", Stainless*	
117212	75124	24", Chrome	
175056	75124-PN	24", Polished Nickel*	
116973	75124-RB	24", Venetian Bronze®	
117166	75124-SS	24", Stainless*	
177726	75130	30", Chrome	
184862	75130-CZ	30", Champagne Bronze™	
182005	75130-PN	30", Polished Nickel*	
168284	75130-RB	30", Venetian Bronze®	
162697	75130-SS	30", Stainless*	

Lahara™ Towel Bar



Part #	Mfg #	Description	Price
115326	73818	18", Chrome	
111492	73818-RB	18", Venetian Bronze®	
111876	73818-SS	18", Stainless*	
113771	73824	24", Chrome	
113095	73824-RB	24" Venetian Bronze®	
111524	73824-SS	24", Stainless*	

Lahara 24" Double Towel/Assist Bar

- Towel bar also functions as assist bar
- 7/8" diameter assist bar
- Extends 3-5/8" from wall
- Supports weight exceeding 250 lbs
- Retrievable assist bar wall anchor included



Part #	Mfg #	Description	Price
189214	41419	24", Chrome	
163123	41419-CZ	24", Champagne Bronze™	
171617	41419-RB	24", Venetian Bronze®	
164838	41419-SS	24", Stainless*	

Leland® Towel Bar

- Mounting hardware and template included



Part #	Mfg #	Description	Price
133253	77818-SS	18", Stainless*	

* Brilliance® Anti-Tarnish Lifetime Finishes

www.waterconcepts.net • Serving our Customers Since 1946 • www.plumbsupply.com

Bath Accessories

Linden™ Towel Bar

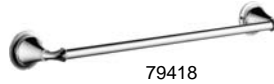

79418

Part #	Mfg #	Description	Price
144726	79418-SS	18", Stainless*	
144696	79418-RB	18", Venetian Bronze®	
143370	79424	24", Chrome	
144401	79424-CZ	24", Champagne Bronze™	
145614	79424-RB	24", Venetian Bronze®	
144201	79424-SS	24", Stainless*	

Tesla™ Towel Bar



Part #	Mfg #	Description	Price
187677	75218-SS	18", Stainless*	
186439	752240-SS	24", Stainless*	
229529	75230-SS	30", Stainless*	

Tesla™ Double Towel Bar



Part #	Mfg #	Description	Price
224767	75225-SS	24", Stainless*	

Trinsic™ Towel Bar



Part #	Mfg #	Description	Price
159205	75912	12", Chrome	
187487	75912-CZ	12", Champagne Bronze™	
160127	75912-RB	12", Venetian Bronze®	
172524	75912-SS	12", Stainless*	
153323	75918	18", Chrome	
225347	75918-CZ	18", Champagne Bronze™	
172746	75918-RB	18", Venetian Bronze®	
157011	75918-SS	18", Stainless*	
153129	759240	24", Chrome	
225348	759240-CZ	24", Champagne Bronze™	
160129	759240-RB	24", Venetian Bronze®	
153915	759240-SS	24", Stainless*	
176390	75930	30", Chrome	
189017	75930-RB	30", Venetian Bronze®	
179771	75930-SS	20", Stainless*	

Trinsic Double Towel Bar



Part #	Mfg #	Description	Price
213877	75925	24", Chrome	
186849	75925-CZ	24", Champagne Bronze™	
171856	75925-SS	24", Stainless*	

Towel Shelf

- Concealed mounting
- Mounting hardware included



Part #	Mfg #	Description	Price
170510	43018	18", Chrome	
155322	43024	24", Chrome	

Vero™ Towel Bar



Part #	Mfg #	Description	Price
138065	77718	18", Chrome	
148548	77718-CZ	18", Champagne Bronze™	
158012	77718-RB	18", Venetian Bronze®	
136654	77718-SS	18", Stainless*	
138067	77724	24", Chrome	
171609	77724-RB	24", Venetian Bronze®	
136655	77724-SS	24", Stainless*	
165157	77730	30", Chrome	
164950	DE77730SS	30", Stainless*	

Vero™ Double Towel Bar



Part #	Mfg #	Description	Price
182239	77725	24" Chrome	
180008	77725-CZ	24", Champagne Bronze™	
167401	77725-RB	24", Venetian Bronze®	
162593	77725-SS	24", Stainless*	

Victorian® Towel Bar



Part #	Mfg #	Description	Price
055811	75018	18", Chrome	
073501	75018-SS	18", Stainless*	
146411	75024-CZ	24", Champagne Bronze™	
075143	75024-SS	24", Stainless*	

* Brilliance® Anti-Tarnish Lifetime Finishes

www.plumbsupply.com • Serving our Customers Since 1946 • www.waterconcepts.net

Bath Accessories

Towel Bars (Continued)

Victorian® Towel Bar

Part #	Mfg #	Description	Price
184587	75030	30", Chrome	
184586	75030-CZ	30", Champagne Bronze™	
174971	75030-PB	30" Polished Brass*	
181975	75030-RB	30", Venetian Bronze®	
171223	75030-SS	30", Stainless*	

Virage® Towel Bar



Part #	Mfg #	Description	Price
189316	691830-PC	18", Polished Chrome	

Windemere® Towel Bar



Part #	Mfg #	Description	Price
179723	70018	Chrome	
167370	70018-OB	Oil-Rubbed Bronze	
162360	70018-SS	Stainless*	
179722	70024	Chrome	
166607	70024-OB	Oil-Rubbed Bronze	
162361	70024-SS	Stainless*	

Misc Bath Accessories

Victorian™ Toothbrush/Tumbler Holder

- Extends 4-1/16" from wall
- Mounting hardware and template included
- Assembled dimension:
6-1/4"H x 4-1/16"D x 2-15/16"W



Part #	Mfg #	Description	Price
059731	75056	Chrome	
163312	75056-CZ	Champagne Bronze™	
078179	75056-RB	Venetian Bronze®	
098382	75056-SS	Stainless*	

* Brilliance® Anti-Tarnish Lifetime Finishes

www.waterconcepts.net • Serving our Customers Since 1946 • www.plumbsupply.com

Bath Accessories

Towel Rings
90° Towel Bar/Ring



Part #	Mfg #	Finish	Price
147798	YB8886BN	Brushed Nickel	
132635	YB8886CH	Chrome	

Align™ Towel Ring



Part #	Mfg #	Finish	Price
174591	YB0486CH	Chrome	

Arris™ Towel Ring



Part #	Mfg #	Finish	Price
175358	YB0886CH	Chrome	

Aspen™ Towel Ring



Part #	Mfg #	Finish	Price
072472	5886CH	Chrome	

Brantford™ Towel Ring



Part #	Mfg #	Finish	Price
113975	YB2286CH	Chrome	
103428	YB2286BN	Brushed Nickel	
102306	YB2286ORB	Oil Rubbed Bronze	

Contemporary Towel Ring



Part #	Mfg #	Finish	Price
189765	P5860	Chrome	

Dartmoor Towel Ring



Part #	Mfg #	Finish	Price
189421	YB2186CH	Chrome	

Eva® Towel Ring



YB2886

YB2808

Part #	Mfg #	Finish	Price
107065	YB2808CH	Chrome	
113432	YB2886CH	Chrome	
097369	YB2886BN	Brushed Nickel	
096192	YB2886ORB	Oil Rubbed Bronze	

Glenshire™ Towel Ring



Part #	Mfg #	Finish	Price
158112	DN2686BN	Brushed Nickel	
165283	DN2686CH	Chrome	

Vanity Cabinets & Hardware

Bath Accessories

Icon™ Towel Ring



Part #	Mfg #	Finish	Price
096173	YB5886BN	Brushed Nickel	
099703	YB5886CH	Chrome	

Lounge™ Towel Ring



Part #	Mfg #	Finish	Price
099087	DN7786BN	Brushed Nickel	

Iso™ Towel Ring



Part #	Mfg #	Finish	Price
113841	DN0786CH	Chrome	

Madison Towel Ring



Part #	Mfg #	Finish	Price
174049	BP6986OWB	Old World Bronze	

Preston™ Towel Ring



Part #	Mfg #	Finish	Price
096889	DN8486BN	Brushed Nickel	

Kingsley™ Towel Ring



Part #	Mfg #	Finish	Price
007453	YB5486BN	Brushed Nickel	
072057	YB5486CH	Chrome	
077253	YB5486ORB	Oil Rubbed Bronze	

Retreat® Towel Ring



Part #	Mfg #	Finish	Price
093026	DN8386BN	Brushed Nickel	

Vanity Cabinets & Hardware

Bath Accessories

Sage® Towel Ring



Part #	Mfg #	Finish	Price
081792	DN6886CH	Chrome	

Weymouth™ Towel Ring



Part #	Mfg #	Finish	Price
146271	YB8486BN	Brushed Nickel	
223045	YB8486CH	Chrome	
152849	YB8486NL	Polished Nickel	
181599	YB8486ORB	Oil Rubbed Bronze	

Voss™ Towel Ring



Part #	Mfg #	Finish	Price
151704	YB5186BN	Brushed Nickel	
154434	YB5186CH	Chrome	
164523	YB5186ORB	Oil Rubbed Bronze	

Wynford Towel Ring



Part #	Mfg #	Finish	Price
217279	YB5286BN	Brushed Nickel	
188045	YB5286CH	Chrome	
223753	YB5286ORB	Oil Rubbed Bronze	

Waterhill™ Towel Ring



Part #	Mfg #	Finish	Price
123963	YB9886ORB	Oil Rubbed Bronze	

Yorkshire Towel Ring



Part #	Mfg #	Finish	Price
104361	BP5386CH	Chrome	
124390	BP5386OWB	Old World Bronze	

Wembley® Towel Ring



Part #	Mfg #	Finish	Price
115110	DN8286BN	Brushed Nickel	

Towel Bars

90° Towel Bar



Part #	Mfg #	Finish	Price
139439	YB8818BN	18", Brushed Nickel	
132637	YB8818CH	18" Chrome	
141014	YB8824BN	24", Brushed Nickel	

Vanity Cabinets & Hardware

Bath Accessories

Towel Bars (Continued)

90° Towel Bar

Part #	Mfg #	Finish	Price
132636	YB8824CH	24", Chrome	

Align Towel Bar



Part #	Mfg #	Finish	Price
181497	YB0418BN	18", Brushed Nickel	
174589	YB0424CH	24", Chrome	

Arris™ Towel Bar



Part #	Mfg #	Finish	Price
165369	YB0818CH	18", Chrome	
175359	YB0824CH	24", Chrome	

Aspen™ Towel Bar



Part #	Mfg #	Finish	Price
072471	5818CH	18", Chrome	
113976	5824CH	24", Chrome	

Banbury™ Double Towel Bar



Part #	Mfg #	Finish	Price
158111	DN2622BN	24", Brushed Nickel	
099699	DN2622CH	24", Chrome	

Brantford™ Towel Bar



Part #	Mfg #	Finish	Price
118282	YB2218BN	18", Brushed Nickel	
113969	YB2218CH	18", Chrome	
102304	YB2218ORB	18", Oil Rubbed Bronze	
103430	YB2224BN	24", Brushed Nickel	
102305	YB2224ORB	24", Oil Rubbed Bronze	

Contemporary Towel Bar



Part #	Mfg #	Finish	Price
189764	P5124	24", Chrome	

Danbury® Towel Bar



Part #	Mfg #	Finish	Price
092972	DN6718BN	18", Brushed Nickel	
112420	DN6718ORB	18", Oil Rubbed Bronze	

Dartmoor Towel Bar



Part #	Mfg #	Finish	Price
224172	YB2124CH	24", Chrome	

Vanity Cabinets & Hardware

Bath Accessories

Eva® Towel Bar



Part #	Mfg #	Finish	Price
104947	YB2818BN	18", Brushed Nickel	
105254	YB2818CH	18", Chrome	
096167	YB2818ORB	18", Oil Rubbed Bronze	
104948	YB2824BN	24", Brushed Nickel	
107064	YB2824CH	24", Chrome	
098297	YB2824ORB	24", Oil Rubbed Bronze	

Iso™ Towel Bar



Part #	Mfg #	Finish	Price
113840	DN0718CH	18", Chrome	
113842	DN0724CH	24", Chrome	

Iso™ Double Towel Bar



Part #	Mfg #	Finish	Price
113843	DN0722CH	24", Chrome	

Glenshire™ Towel Bar



Part #	Mfg #	Finish	Price
115388	DN2618BN	18", Brushed Nickel	
115389	DN2624BN	24", Brushed Nickel	
165284	DN2624CH	24", Chrome	

Kingsley Towel Bar



Part #	Mfg #	Finish	Price
077255	YB5418ORB	18", Oil Rubbed Bronze	
082930	YB5424BN	24", Brushed Nickel	
072064	YB5424CH	24", Chrome	

Icon™ Towel Bar



Part #	Mfg #	Finish	Price
096175	YB5818BN	18", Brushed Nickel	
099707	YB5818CH	18", Chrome	
109396	YB5824BN	24", Brushed Nickel	
101288	YB5824CH	24", Chrome	

Kingsley® Double Towel Bar



Part #	Mfg #	Finish	Price
132203	YB5422BN	24", Brushed Nickel	
133194	YB5422CH	24", Chrome	
139824	YB5422ORB	24", Oil Rubbed Bronze	
168068	YB5422WR	24", Wrought Iron	

Icon™ Double Towel Bar



Part #	Mfg #	Finish	Price
101290	YB5822BN	24", Brushed Nickel	
099704	YB5822CH	24", Chrome	

Vanity Cabinets & Hardware

Bath Accessories

Lounge™ Towel Bar



Part #	Mfg #	Finish	Price
109499	DN7718BN	18", Brushed Nickel	
110043	DN7724BN	24", Brushed Nickel	

Retreat® Towel Bar



Part #	Mfg #	Finish	Price
093028	DN8324BN	24", Brushed Nickel	

Mason Towel Bar



Part #	Mfg #	Finish	Price
110825	YB8094CH	24", Chrome	

Rothbury Towel Bar



Part #	Mfg #	Finish	Price
229063	YB8286BN	9", Brushed Nickel	
132147	YB8218ORB	18", Oil Rubbed Bronze	
229064	YB8224BN	24", Brushed Nickel	
152542	YB8224CH	24", Chrome	
132403	YB8224ORB	24", Oil Rubbed Bronze	

Method™ 9" Towel Bar



Part #	Mfg #	Finish	Price
153206	YB2486BN	Brushed Nickel	
134233	YB2486CH	Chrome	

Sage® Towel Bar



Part #	Mfg #	Finish	Price
081790	DN6824CH	24", Chrome	

Preston Towel Bar



Part #	Mfg #	Finish	Price
048796	DN8418CH	18", Chrome	

Sage® Double Towel Bar



Part #	Mfg #	Finish	Price
114452	DN6822BN	24", Brushed Nickel	

Preston Double Towel Bar



Part #	Mfg #	Finish	Price
050107	DN8422CH	24", Chrome	

Vanity Cabinets & Hardware

Bath Accessories

Voss™ Towel Bar



Part #	Mfg #	Finish	Price
150987	YB5118BN	18", Brushed Nickel	
152103	YB5118CH	18", Chrome	
169224	YB5118ORB	18", Oil Rubbed Bronze	
150988	YB5124BN	24", Brushed Nickel	
152105	YB5124CH	24", Chrome	
158211	YB5124ORB	24", Oil Rubbed Bronze	

Weymouth™ Towel Bar



Part #	Mfg #	Finish	Price
173401	YB8418CH	18", Chrome	
189388	YB8418NL	18", Polished Nickel	
173402	YB8424CH	24", Chrome	
152848	YB8424NL	24", Polished Nickel	
181598	YB8424ORB	24", Oil Rubbed Bronze	

Wynford™ Towel Bar



Part #	Mfg #	Finish	Price
188041	YB5218CH	18", Chrome	
225352	YB5218BN	18", Brushed Nickel	
180027	YB5224BN	24", Brushed Nickel	

Wynford™ Double Towel Bar



Part #	Mfg #	Finish	Price
188043	YB5222CH	24" Chrome	
225333	YB5222BN	24", Brushed Nickel	

Yorkshire Towel Bar



Part #	Mfg #	Finish	Price
134591	5318CH	18", Chrome	
124391	BP5318OWB	18", Old World Bronze	

Wembley® Double Towel Bar



Part #	Mfg #	Finish	Price
115109	DN8222BN	24", Brushed Nickel	

Vanity Shelves

Eva® Glass Vanity Shelf



Part #	Mfg #	Finish	Price
126032	YB2894BN	Brushed Nickel	

Icon™ Glass Vanity Shelf



Part #	Mfg #	Finish	Price
225904	YB5890BN	20", Brushed Nickel	

Vanity Cabinets & Hardware

Bath Accessories

Iso™ Towel Shelf



Part #	Mfg #	Finish	Price
159757	DN0794BN	Brushed Nickel	

Kingsley™ Glass Vanity Shelf



Part #	Mfg #	Finish	Price
153236	YB5490BN	Brushed Nickel	
139461	YB5490CH	Chrome	
096169	YB5409ORB	Oil Rubbed Bronze	
097027	YB5409WR	Wrought Iron	

Kingsley® Towel Shelf



Part #	Mfg #	Finish	Price
132204	YB5494BN	Brushed Nickel	
168624	YB5494CH	Chrome	

Lounge Glass Vanity Shelf



Part #	Mfg #	Finish	Price
118161	DN7790CH	Chrome	
225555	DN7790BN	Brushed Nickel	

Retreat® Glass Vanity Shelf



Part #	Mfg #	Finish	Price
109498	DN8390BN	Brushed Nickel	

Sage® Glass Vanity Shelf



Part #	Mfg #	Finish	Price
106026	DN6890BN	Brushed Nickel	

Bath Accessories

Toilet Tissue Holders

- Tools and template included for installation

Alteo® Pivoting Toilet Tissue Holder



Part #	Mfg #	Finish	Price
142071	K-37054-BN	*Brushed Nickel	
139658	K-37054-CP	Polished Chrome	
149756	K-37054-2BZ	Oil Rubbed Bronze	

Alteo® Vertical Toilet Tissue Holder



Part #	Mfg #	Finish	Price
144467	K-37056-BN	*Brushed Nickel	
148511	K-37056-CP	Polished Chrome	
157866	K-37056-2BZ	Oil Rubbed Bronze	

Archer® Toilet Tissue Holder



Part #	Mfg #	Description	Price
120026	K-11054-BN	*Brushed Nickel	
120082	K-11054-CP	Polished Chrome	

Archer® Vertical Toilet Tissue Holder



Part #	Mfg #	Description	Price
123908	K-11056-BN	*Brushed Nickel	
135973	K-11056-CP	Polished Chrome	

Artifacts® Pivoting Tissue Holder



Part #	Mfg #	Description	Price
174108	K-72573-BN	*Brushed Nickel	
224550	K-72573-BV	*Brushed Bronze	
173115	K-72573-CP	Polished Chrome	
173105	K-72573-SN	Polished Nickel	
223892	K-72573-VNT	Vintage Nickel	
168461	K-72573-2BZ	Oil-Rubbed Bronze	

Artifacts® Vertical Toilet Tissue Holder



Part #	Mfg #	Description	Price
162104	K-72576-BN	*Brushed Nickel	
183642	K-72576-SN	*Polished Nickel	
183643	K-72576-2BZ	Oil Rubbed Bronze	

Bancroft® Toilet Tissue Holder



Part #	Mfg #	Description	Price
109365	K-11415-AF	*French Gold	
096180	K-11415-BN	*Brushed Nickel	
114843	K-11415-BV	*Brushed Bronze	
087297	K-11415-CP	Polished Chrome	
098451	K-11415-SN	*Polished Nickel	
162435	K-11415-2BZ	Oil-Rubbed Bronze	

Composed™ Toilet Tissue Holder



Part #	Mfg #	Description	Price
225540	K-73147-CP	Polished Chrome	
228448	K-73148-CP	Polished Chrome, Vertical	

* Vibrant Limited Lifetime Warranty

www.plumbsupply.com • Serving our Customers Since 1946 • www.waterconcepts.net

Bath Accessories

Coralais® Toilet Tissue Holder



Part #	Mfg #	Finish	Price
111507	K-13434-BN	*Brushed Nickel	
097475	K-13434-CP	Polished Chrome	
117701	K-13434-G	Brushed Chrome	

Devonshire® Toilet Tissue Holder



Part #	Mfg #	Finish	Price
075035	K-10554-BN	*Brushed Nickel	
086445	K10554BV	*Brushed Bronze	
073748	K-10554-CP	Polished Chrome	
078149	K-10554-PB	Polished Brass	
190234	K-10554-SN	*Polished Nickel	
146954	K-10554-2BZ	Oil Rubbed Bronze	

Fairfax® Toilet Tissue Holder



Part #	Mfg #	Description	Price
069237	K-12157-BN	*Brushed Nickel	
072315	K-12157-CP	Polished Chrome	
154610	K-12157-2BZ	Oil Rubbed Bronze	

Finial® Traditional Toilet Tissue Holder



Part #	Mfg #	Description	Price
080559	K-361-AF	*French Gold	
062460	K-361-BN	*Brushed Nickel	
077357	K-361-BV	*Brushed Bronze	

Toilet Tissue Holders (Continued)

Finial® Traditional Toilet Tissue Holder

Part #	Mfg #	Description	Price
060169	K-361-CP	Polished Chrome	
074140	K-361-SN	*Polished Nickel	
152086	K-361-2BZ	Oil-Rubbed Bronze	

Forté® Sculpted Toilet Tissue Holder



Part #	Mfg #	Finish	Price
080263	K-11374-BN	*Brushed Nickel	
084209	K-11374-CP	Polished Chrome	
087274	K-11374-G	Brushed Chrome	

Forté® Traditional Toilet Tissue Holder



Part #	Mfg #	Finish	Price
087031	K-11274-BN	*Brushed Nickel	
084059	K-11274-CP	Polished Chrome	

Kelston® Toilet Tissue Holder



Part #	Mfg #	Description	Price
134491	K-13504-BN	*Brushed Nickel	
160293	K-13504-CP	Polished Chrome	
150913	K-13504-2BZ	Oil Rubbed Bronze	

Loure® Covered Toilet Tissue Holder



Part #	Mfg #	Description	Price
133516	K-11584-BN	*Brushed Nickel	
165332	K-11584-CP	Polished Chrome	

* Vibrant Limited Lifetime Warranty

www.waterconcepts.net • Serving our Customers Since 1946 • www.plumbsupply.com

Bath Accessories

Loure® Vertical Toilet Tissue Holder



Part #	Mfg #	Description	Price
123909	K-11583-BN	*Brushed Nickel	
121347	K-11583-CP	Polished Chrome	
142544	K-11583-SN	*Polished Nickel	

Margaux™ Toilet Tissue Holder



Part #	Mfg #	Finish	Price
183022	K-16265-AF	*French Gold	
132764	K-16265-BN	*Brushed Nickel	
138823	K-16265-BV	*Brushed Bronze	
141876	K-16265-CP	Polished Chrome	
160874	K-16265-SN	*Polished Nickel	

Margaux® Vertical Toilet Tissue Holder



Part #	Mfg #	Description	Price
136522	K-16255-AF	*French Gold	
109462	K-16255-BN	*Brushed Nickel	
124078	K-16255-BV	*Brushed Bronze	
111198	K-16255-CP	Polished Chrome	
135086	K-16255-SN	*Polished Nickel	

Memoirs® Stately Toilet Tissue Holder



Part #	Mfg #	Description	Price
057962	K-490-BN	*Brushed Nickel	
075021	K-490-BV	*Brushed Bronze	
063413	K-490-CP	Polished Chrome	
170476	K-490-2BZ	Oil-Rubbed Bronze	

Pinstripe® Toilet Tissue Holder



Part #	Mfg #	Description	Price
086162	K-13114-CP	Polished Chrome	
099492	K-13114-SN	*Polished Nickel	

Purist® Pivoting Tissue Holder



Part #	Mfg #	Description	Price
228967	K-14377-BGD	*Moderne Brushed Gold	
159063	K-14377-BN	*Brushed Nickel	
185004	K-14377-BV	*Brushed Bronze	
152949	K-14377-CP	Polished Chrome	
148808	K-14377-SN	*Polished Nickel	

Purist® Vertical Toilet Tissue Holder



Part #	Mfg #	Description	Price
132493	K-14444-BGD	*Moderne Brushed Gold	
080025	K-14444-BN	*Brushed Nickel	
132499	K-14444-BV	*Brushed Bronze	
069310	K-14444-CP	Polished Chrome	

* Vibrant Limited Lifetime Warranty

www.plumbsupply.com • Serving our Customers Since 1946 • www.waterconcepts.net

Bath Accessories

Toilet Tissue Holders (Continued)

Purist® Vertical Toilet Tissue Holder

Part #	Mfg #	Description	Price
091453	K-14444-SN	*Polished Nickel	

Stillness® Pivoting Tissue Holder



Part #	Mfg #	Description	Price
183012	K-14393-BN	*Brushed Nickel	
155207	K-14393-CP	Polished Chrome	

Stillness® Vertical Toilet Tissue Holder

- Solid-brass construction for durability
- Can be installed vertically or horizontally
- Tools for installation included



Part #	Mfg #	Description	Price
072152	K-14459-CP	Polished Chrome	

Toobi® Toilet Tissue Holder



Part #	Mfg #	Description	Price
150831	K-5672-BN	*Brushed Nickel	
155341	K-5672-CP	Polished Chrome	

Toobi® Vertical Toilet Tissue Holder



Part #	Mfg #	Description	Price
162523	K-5673-BN	*Brushed Nickel	
157517	K-5673-CP	Polished Chrome	

* Vibrant Limited Lifetime Warranty

www.waterconcepts.net • Serving our Customers Since 1946 • www.plumbsupply.com

Bath Accessories

Tissue Holders

Addison® Tissue Holder



Part #	Mfg #	Finish	Price
128419	79250	Chrome	
137914	79250-CZ	Champagne Bronze™	
126442	79250-RB	Venetian Bronze®	
128433	79250-SS	Stainless*	

Arzo® Tissue Holder



Part #	Mfg #	Finish	Price
112701	77550	Chrome	
112702	77550-SS	Stainless*	

Ashlyn Tissue Holder



Part #	Mfg #	Description	Price
174454	76450	Chrome	
172679	76450-RB	Venetian Bronze®	
173620	76450-SS	Stainless*	

Cassidy™ Tissue Holder



Part #	Mfg #	Description	Price
155332	79750	Chrome	
151144	79750-CZ	Champagne Bronze™	
153347	79750-PN	Polished Nickel*	
151572	79750-RB	Venetian Bronze®	
151710	79750-SS	Stainless*	

Cassidy™ Tissue Holder/Assist Bar

- 6" Long
- Tissue holder also functions as an assist bar
- 7/8" diameter assist bar
- Pivoting arm
- Extends 5-1/4" from wall
- Supports loads exceeding 250 lbs
- Mounting hardware included



Part #	Mfg #	Description	Price
168134	41350	Chrome	
225974	41350-CZ	Champagne Bronze™	
168130	41350-PN	Polished Nickel*	
170143	41350-RB	Venetian Bronze®	
165281	41350-SS	Stainless*	

Contemporary Tissue Holder/Assist Bar



Part #	Mfg #	Description	Price
179498	41550	Chrome	
171287	41550-CZ	Champagne Bronze™	
181197	41550-SS	Stainless*	

Compel™ Tissue Holder



Part #	Mfg #	Description	Price
163462	77250	Chrome	
171642	77250-SS	Stainless*	

Dryden™ Tissue Holder



Part #	Mfg #	Finish	Price
117219	75150	Chrome	
146203	75150-CZ	Champagne Bronze™	
175055	75150-PN	Polished Nickel*	
116766	75150-RB	Venetian Bronze®	
117165	75150-SS	Stainless*	

* Brilliance® Anti-Tarnish Lifetime Finishes

www.plumbsupply.com • Serving our Customers Since 1946 • www.waterconcepts.net

Bath Accessories

Grail® Tissue Holder



Part #	Mfg #	Finish	Price
111859	77150	Chrome	
113015	77150-SS	Stainless*	

Trinsic™ Tissue Holder



Part #	Mfg #	Description	Price
151404	75950	Chrome	
186846	75950-CZ	Champagne Bronze™	
153361	75950-SS	Stainless*	
158327	75950-RB	Venetian Bronze®	

Lahara™ Tissue Holder



Part #	Mfg #	Finish	Price
114058	73850	Chrome	
157537	73850-CZ	Champagne Bronze™	
111497	73850-RB	Venetian Bronze®	
111523	73850-SS	Stainless*	

Victorian® Tissue Holder

• 9-1/4" Long



Part #	Mfg #	Finish	Price
054206	75050	Chrome	
146409	75050-CZ	Champagne Bronze™	
055723	75050-RB	Venetian Bronze®	

Lahara Tissue Holder/Assist Bar



Part #	Mfg #	Description	Price
170469	41450	Chrome	
163121	41450-CZ	Champagne Bronze™	
171616	41450-RB	Venetian Bronze®	
169509	41450-SS	Stainless*	

Vero™ Tissue Holder



Part #	Mfg #	Description	Price
138066	77750	Chrome	
173123	77750-CZ	Champagne Bronze™	
149665	77750-RB	Venetian Bronze®	
136656	77750-SS	Stainless*	

Linden™ Tissue Holder



Part #	Mfg #	Finish	Price
143372	79450	Chrome	
144403	79450-CZ	Champagne Bronze™	
144560	79450-RB	Venetian Bronze®	
143870	79450-SS	Stainless*	

Windemere Tissue Holder



Part #	Mfg #	Description	Price
159086	70050	Chrome	
164492	70050-OB	Oil-Rubbed Bronze	
162359	70050-SS	Stainless*	

Tesla® Tissue Holder



Part #	Mfg #	Description	Price
222230	752500-PN	Polished Nickel	
186447	752500-SS	Stainless*	

* Brilliance® Anti-Tarnish Lifetime Finishes

www.waterconcepts.net • Serving our Customers Since 1946 • www.plumbsupply.com

Bath Accessories

Paper Holders

90°™ Pivoting Toilet Paper Holder



Part #	Mfg #	Finish	Price
139435	YB8808BN	Brushed Nickel	
132634	YB8808CH	Chrome	

Align™ Toilet Paper Holder



Part #	Mfg #	Finish	Price
175077	YB0409BN	Brushed Nickel	
174590	YB0409CH	Chrome	

Align™ Toilet Paper Holder



Part #	Mfg #	Finish	Price
168502	YB0408CH	Chrome	

Arris™ Pivoting Toilet Paper Holder



Part #	Mfg #	Finish	Price
165370	YB0808CH	Chrome	

Aspen™ Toilet Paper Holder



Part #	Mfg #	Finish	Price
072474	5808CH	Chrome	

Brantford™ Toilet Paper Holder



Part #	Mfg #	Finish	Price
103432	YB2208BN	Brushed Nickel	
120275	YB2208CH	Chrome	
102303	YB2208ORB	Oil Rubbed Bronze	

Contemporary Tissue Holder



Part #	Mfg #	Finish	Price
189763	P5080	Chrome	

Danbury® Toilet Tissue Holder



Part #	Mfg #	Finish	Price
092973	DN6708BN	Brushed Nickel	

Dartmoor™ Toilet Paper Holder



Part #	Mfg #	Finish	Price
189420	YB2108CH	Chrome	

Donner™ Commercial Paper Holder



Part #	Mfg #	Finish	Price
157882	DN5075	Chrome	
083507	575	Chrome	

Vanity Cabinets & Hardware

Bath Accessories

Eva® Toilet Tissue Holder



Part #	Mfg #	Finish	Price
097220	YB2808BN	Brushed Nickel	
096168	YB2808ORB	Oil Rubbed Bronze	

Glenshire™ Toilet Paper Holder



Part #	Mfg #	Finish	Price
115387	DN2608BN	Brushed Nickel	
165282	DN2608CH	Chrome	

Icon™ Pivoting Toilet Paper Holder



Part #	Mfg #	Finish	Price
096174	YB5808BN	Brushed Nickel	
099702	YB5808CH	Chrome	

Iso™ Toilet Paper Holder



Part #	Mfg #	Finish	Price
113839	DN0708CH	Chrome	

Kingsley™ Pivoting Toilet Paper Holder



Part #	Mfg #	Finish	Price
095723	YB5408BN	Brushed Nickel	

Paper Holders (Continued)

Kingsley™ Pivoting Toilet Paper Holder

Part #	Mfg #	Finish	Price
072055	YB5408CH	Chrome	
077254	YB5408ORB	Oil Rubbed Bronze	

Lounge™ Paper Holder



Part #	Mfg #	Finish	Price
099088	DN7708BN	Brushed Nickel	
118159	DN7708CH	Chrome	

Madison™ Toilet Paper Holder



Part #	Mfg #	Finish	Price
189816	BP6980CH	European Style, Chrome	
067049	DN6908PW	Pewter	

Preston™ Toilet Paper Holder



Part #	Mfg #	Finish	Price
048794	DN8408CH	Chrome	
096888	DN8408BN	Brushed Nickel	

Rothbury™ Pivoting Toilet Paper Holder



Part #	Mfg #	Finish	Price
152540	YB8208BN	Brushed Nickel	

Vanity Cabinets & Hardware

Bath Accessories

Paper Holders (Continued)

Rothbury™ Pivoting Toilet Paper Holder

Part #	Mfg #	Finish	Price
152541	YB8208CH	Chrome	
120612	YB8208ORB	Oil Rubbed Bronze	

Rothbury™ Toilet Paper Holder



Part #	Mfg #	Finish	Price
153847	YB8286CH	Chrome	
120613	YB8286ORB	Oil Rubbed Bronze	

Sage® Toilet Paper Holder



Part #	Mfg #	Finish	Price
081791	DN6808CH	Chrome	

Sienna® Freestanding Paper Holder



Part #	Mfg #	Finish	Price
124415	DN4950BK	Matte Black	

Sage™ Freestanding Paper Holder



Part #	Mfg #	Finish	Price
122121	DN6850BN	Brushed Nickel	

Stockton® Freestanding Paper Holder



Part #	Mfg #	Finish	Price
105290	DN4150BN	Brushed Nickel	

Voss™ Pivoting Toilet Paper Holder



Part #	Mfg #	Finish	Price
150986	YB5108BN	Brushed Nickel	
152106	YB5108CH	Chrome	
154053	YB5108ORB	Oil Rubbed Bronze	

Wembley® Pivoting Toilet Paper Holder



Part #	Mfg #	Finish	Price
115108	DN8208BN	Brushed Nickel	

Vanity Cabinets & Hardware

Bath Accessories

Weymouth™ Pivoting Toilet Paper Holder



Part #	Mfg #	Finish	Price
143680	YB8408BN	Brushed Nickel	
173403	YB8408CH	Chrome	
152851	YB8408NL	Polished Nickel	
176404	YB8408ORB	Oil Rubbed Bronze	

Wynford™ Toilet Paper Holder



Part #	Mfg #	Finish	Price
180029	YB5208BN	Brushed Nickel	
188040	YB5208CH	Chrome	
184857	YB5208ORB	Oil Rubbed Bronze	

Yorkshire Toilet Paper Holder



Part #	Mfg #	Finish	Price
104362	BP5308CH	Chrome	
124392	BP5308OWB	Old World Bronze	

Yorkshire European Paper Holder



Part #	Mfg #	Finish	Price
134590	BP5380CH	Chrome	

Paper Holder Mounting Posts



Part #	Mfg #	Finish	Price
185360	P5100	Chrome	

Bath Accessories

Robe Hooks

- Tools and template included for installation

Alteo® Robe Hook



Part #	Mfg #	Finish	Price
142898	K-37055-CP	Polished Chrome	
144687	K-37055-BN	*Brushed Nickel	
156440	K-37055-2BZ	Oil-Rubbed Bronze	

Archer® Robe Hook



Part #	Mfg #	Description	Price
129550	K-11055-BN	*Brushed Nickel	

Artifacts® Double Robe Hook



Part #	Mfg #	Description	Price
166097	K-72572-BN	*Brushed Nickel	
175227	K-72572-CP	Polished Chrome	
174464	K-72572-SN	Polished Nickel	
223903	K-72572-VNT	Vintage Nickel	
168460	K-72572-2BZ	Oil-Rubbed Bronze	

Bancroft® Double Robe Hook



Part #	Mfg #	Description	Price
105975	K-11414-BN	*Brushed Nickel	
114842	K-11414-BV	*Brushed Bronze	
087296	K-11414-CP	Polished Chrome	
098456	K-11414-SN	*Polished Nickel	
187788	K-11414-2BZ	Oil-Rubbed Bronze	

Composed™ Double Robe Hook



Part #	Mfg #	Description	Price
228447	K-73146-CP	Polished Chrome	

Coralais® Robe Hook



Part #	Mfg #	Description	Price
114304	K-13433-BN	*Brushed Nickel	
097474	K-13433-CP	Polished Chrome	
172002	K-13433-G	Brushed Chrome	

Devonshire® Robe Hook



Part #	Mfg #	Finish	Price
077003	K-10555-BN	*Brushed Nickel	
086446	K10555BV	*Brushed Bronze	
073747	K-10555-CP	Polished Chrome	
078150	K-10555-PB	*Polished Brass	
183448	K-10555-SN	*Polished Nickel	
146955	K-10555-2BZ	Oil Rubbed Bronze	

Fairfax® Robe Hook



Part #	Mfg #	Description	Price
072942	K-12156-CP	Polished Chrome	
078575	K-12156-BN	*Brushed Nickel	
156624	K-12156-2BZ	Oil-Rubbed Bronze	

* Vibrant Limited Lifetime Warranty

www.plumbsupply.com • Serving our Customers Since 1946 • www.waterconcepts.net

Bath Accessories

Fairfax® Double Robe Hook



Part #	Mfg #	Description	Price
089185	K-12153-CP	Polished Chrome	
074971	K-12153-BN	*Brushed Nickel	
159425	K-12153-2BZ	Oil-Rubbed Bronze	

Kelston® Robe Hook



Part #	Mfg #	Description	Price
161343	K-13505-CP	Polished Chrome	
140186	K-13505-BN	*Brushed Nickel	
146994	K-13505-2BZ	Oil-Rubbed Bronze	

Finial Robe Hook



Part #	Mfg #	Description	Price
182451	K-364-CP	Polished Chrome	
180595	K-364-2BZ	Oil-Rubbed Bronze	

Loure® Robe Hook



Part #	Mfg #	Description	Price
174350	K-11585-CP	Polished Chrome	
155635	K-11585-BN	*Brushed Nickel	

Forte® Sculpted Double Robe Hook



Part #	Mfg #	Description	Price
082750	K-11375-BN	*Brushed Nickel	
090032	K-11375-CP	Polished Chrome	
098282	K-11375-G	Brushed Chrome	

Margaux® Double Robe Hook



Part #	Mfg #	Finish	Price
183365	K-16256-AF	*French Gold	
132765	K-16256-BN	*Brushed Nickel	
124079	K-16256-BV	*Brushed Bronze	
111199	K-16256-CP	Polished Chrome	
135087	K-16256-SN	*Polished Nickel	

Forte® Traditional Single Robe Hook

- Bullet one
- Bullet two all lower case after first word



Part #	Mfg #	Description	Price
089530	K-11275-BN	*Brushed Nickel	

Memoirs® Robe Hook



Part #	Mfg #	Description	Price
061211	K-492-BN	*Brushed Nickel	
075026	K-492-BV	*Brushed Bronze	
063414	K-492-CP	Polished Chrome	
174230	K-492-2BZ	Oil-Rubbed Bronze	

* Vibrant Limited Lifetime Warranty

www.waterconcepts.net • Serving our Customers Since 1946 • www.plumbsupply.com

Bath Accessories

Pinstripe® Robe Hook



Part #	Mfg #	Description	Price
114051	K-13113-SN	*Polished Nickel	

Purist® Robe Hook



Part #	Mfg #	Description	Price
132496	K-14443-BGD	*Moderne Brushed Gold	
086547	K-14443-BN	*Brushed Nickel	
187198	K-14443-BV	*Brushed Bronze	
069308	K-14443-CP	Polished Chrome	
091452	K-14443-SN	*Polished Nickel	

Revival® Robe Hook



Part #	Mfg #	Description	Price
076860	K-16146-BV	*Brushed Bronze	

Stillness® Robe Hook



Part #	Mfg #	Description	Price
072155	K-14458-CP	Polished Chrome	

Toobi™ Double Robe Hook



Part #	Mfg #	Description	Price
189977	K-5670-BN	*Brushed Nickel	
150366	K-5670-CP	Polished Chrome	

* Vibrant Limited Lifetime Warranty

www.plumbsupply.com • Serving our Customers Since 1946 • www.waterconcepts.net

Bath Accessories

Robe Hooks

Charlotte™ Robe Hook



Part #	Mfg #	Description	Price
171442	693585-PC	Chrome	
148745	693585-PNC	Cocoa Bronze & Pol Nickel O	

Odin™ Robe Hook



Part #	Mfg #	Description	Price
165341	693575-BN	Brushed Nickel*	

Litze™ Robe Hook



Part #	Mfg #	Description	Price
229551	693535-NKTK	Luxe Nickel/Teak Wood	

Rook™ Double Robe Hook



Part #	Mfg #	Description	Price
190002	693561-NK	Luxe Nickel*	
188715	693561-NKBL	Luxe Nickel/Matte Black	
188970	693561-PC	Chrome	

Siderna™ Robe Hook



Part #	Mfg #	Description	Price
162488	693580-BL	Matte Black	
139358	693580-BN	Brushed Nickel*	

Robe Hooks (Continued)

Siderna™ Robe Hook

Part #	Mfg #	Description	Price
141656	693580-PC	Chrome	

Sotria™ Double Robe Hook



Part #	Mfg #	Description	Price
177249	693550-NK	Luxe Nickel*	
181913	693550-PC	Chrome	
187349	693550-PN	Polished Nickel*	

Traditional Robe Hook



Part #	Mfg #	Description	Price
173168	69535-BN	Brushed Nickel*	
109172	69535-BZ	Brushed Bronze*	
079585	69535-PC	Chrome	
175474	69535-PN	Polished Nickel*	
085208	69535-RB	Venetian Bronze®	

Vesi® Channel Double Robe Hook



Part #	Mfg #	Description	Price
170976	693540-BN	Brushed Nickel*	

Virage® Robe Hook



Part #	Mfg #	Description	Price
164494	693530-BN	Brushed Nickel*	
166208	693530-PC	Chrome	
140725	693530-RB	Venetian Bronze®	

* Brilliance® Anti-Tarnish Lifetime Finishes

www.waterconcepts.net • Serving our Customers Since 1946 • www.plumbsupply.com

Bath Accessories

Robe Hooks
Addison® Robe Hook



Part #	Mfg #	Finish	Price
128422	79235	Chrome	
141295	79235-CZ	Champagne Bronze™	
129950	79235-RB	Venetian Bronze®	
128431	79235-SS	Stainless*	

Ashlyn™ Robe Hook



Part #	Mfg #	Description	Price
173784	76435	Chrome	
172992	76435-RB	Venetian Bronze®	
174019	76435-SS	Stainless*	

Arzo Robe Hook



Part #	Mfg #	Description	Price
112697	77535	Chrome	
112698	77535-SS	Stainless*	

Cassidy™ Robe Hook



Part #	Mfg #	Description	Price
155318	79735	Chrome	
158509	79735-CZ	Champagne Bronze™	
153345	79735-PN	Polished Nickel*	
152373	79735-RB	Venetian Bronze®	
154633	79735-SS	Stainless*	

Compel Robe Hook



Part #	Mfg #	Description	Price
120917	77135	Chrome	
113013	77135-SS	Stainless*	

Dryden™ Robe Hook



Part #	Mfg #	Finish	Price
117214	75135	Chrome	
163749	75135-CZ	Champagne Bronze™	
169982	75135-PN	Polished Nickel*	
116974	75135-RB	Venetian Bronze®	
117216	75135-SS	Stainless*	

Lahara™ Robe Hook



Part #	Mfg #	Finish	Price
115327	73835	Chrome	
111494	73835-RB	Venetian Bronze®	
111865	73835-SS	Stainless*	

Leland® Robe Hook



Part #	Mfg #	Finish	Price
132711	77835-RB	Venetian Bronze®	
133257	77835-SS	Stainless*	

* Brilliance® Anti-Tarnish Lifetime Finishes

www.plumbsupply.com • Serving our Customers Since 1946 • www.waterconcepts.net

Bath Accessories

Linden™ Robe Hook



Part #	Mfg #	Finish	Price
148347	79435	Chrome	
145612	79435-RB	Venetian Bronze®	
144832	79435-SS	Stainless*	

Victorian® Double Robe Hook

- 3" Flange diameter
- Extends 4-3/4" from wall



Part #	Mfg #	Finish	Price
058902	75035	Chrome	
059504	75035-RB	Venetian Bronze®	

Windemere® Robe Hook



Part #	Mfg #	Description	Price
159084	70035	Chrome	
166609	70035-OB	Oil-Rubbed Bronze	
162362	70035-SS	Stainless*	

Tesla® Double Robe Hook



Part #	Mfg #	Description	Price
223521	75235	Chrome	
186442	75235-SS	Stainless*	

Trinsic™ Robe Hook



Part #	Mfg #	Description	Price
153132	75935	Chrome	
187311	75935-CZ	Champagne Bronze™	
152672	75935-SS	Stainless*	
162051	75935-RB	Venetian Bronze®	

Vero™ Robe Hook



Part #	Mfg #	Description	Price
138336	77736	Chrome	
184867	77736-CZ	Champagne Bronze™	
158013	77736-RB	Venetian Bronze®	
140652	77736-SS	Stainless*	

* Brilliance® Anti-Tarnish Lifetime Finishes

www.waterconcepts.net • Serving our Customers Since 1946 • www.plumbsupply.com

Bath Accessories

Robe Hooks
90° Robe Hook



Part #	Mfg #	Finish	Price
143190	YB8803CH	Chrome	
139438	YB8803BN	Brushed Nickel	

Align™ Robe Hook



Part #	Mfg #	Finish	Price
168503	YB0403CH	Chrome	

Align™ Swivel Robe Hook



Part #	Mfg #	Finish	Price
176873	YB0402CH	Chrome	

Arris™ Double Robe Hook



Part #	Mfg #	Finish	Price
158614	YB0803BN	Brushed Nickel	
165371	YB0803CH	Chrome	

Aspen™ Robe Hook



Part #	Mfg #	Finish	Price
072473	5802CH	Chrome	

Brantford™ Double Robe Hook



Part #	Mfg #	Finish	Price
127641	YB2203BN	Brushed Nickel	
102302	YB2203ORB	Oil Rubbed Bronze	

Ellsworth Robe Hook



Part #	Mfg #	Finish	Price
186106	DN9103BRB	Mediterranean Bronze	

Eva® Robe Hook



Part #	Mfg #	Finish	Price
097221	YB2803BN	Brushed Nickel	
113431	YB2803CH	Chrome	

Danbury® Robe Hook



Part #	Mfg #	Finish	Price
092974	DN6703BN	Brushed Nickel	

Glenshire™ Double Robe Hook



Part #	Mfg #	Finish	Price
158113	DN2603BN	Brushed Nickel	

Vanity Cabinets & Hardware

Bath Accessories

Kingsley Double Robe Hook



Part #	Mfg #	Finish	Price
072065	YB5403CH	Chrome	
115691	YB5403WR	Wrought Iron	

Preston™ Robe Hook



Part #	Mfg #	Finish	Price
059555	DN8403CH	Chrome	

Retreat® Robe Hook



Part #	Mfg #	Finish	Price
094646	DN8303BN	Brushed Nickel	

Icon™ Double Robe Hook



Part #	Mfg #	Finish	Price
109397	YB5803BN	Brushed Nickel	

Rothbury™ Robe Hook



Part #	Mfg #	Finish	Price
225080	YB8203CH	Chrome	
229066	YB8203BN	Brushed Nickel	

Iso™ Robe Hook



Part #	Mfg #	Finish	Price
113838	DN0703CH	Chrome	

Sage® Robe Hook



Part #	Mfg #	Finish	Price
114451	DN6803BN	Brushed Nickel	

Lounge™ Double Robe Hook



Part #	Mfg #	Finish	Price
099089	DN7703BN	Brushed Nickel	

Sienna® Robe Hook



Part #	Mfg #	Finish	Price
083093	DN4903BK	Matte Black	

Vanity Cabinets & Hardware

Bath Accessories

Voss™ Robe Hook



Part #	Mfg #	Finish	Price
150989	YB5103BN	Brushed Nickel	
152104	YB5103CH	Chrome	
162350	YB5103ORB	Oil Rubbed Bronze	

Weymouth™ Double Robe Hook



Part #	Mfg #	Finish	Price
143679	YB8403BN	Brushed Nickel	
189818	YB8403CH	Chrome	
152852	YB8403NL	Polished Nickel	
181600	YB8403ORB	Oil Rubbed Bronze	

Wynford™ Robe Hook



Part #	Mfg #	Finish	Price
180028	YB5203BN	Brushed Nickel	
188039	YB5203CH	Chrome	
184856	YB5203ORB	Oil Rubbed Bronze	

Bath Accessories

Cabinet Hardware

90° Drawer Pull



Part #	Mfg #	Finish	Price
207656	YB8807CH	Chrome	

90° Drawer Knob



Part #	Mfg #	Finish	Price
147715	YB8805CH	Chrome	

Kingsley Drawer Pull



Part #	Mfg #	Finish	Price
162342	YB5407ORB	Oil Rubbed Bronze	

Rothbury Drawer Knob



Part #	Mfg #	Finish	Price
228794	YB8205CH	Chrome	

Waterhill® Drawer Pull



Part #	Mfg #	Finish	Price
169981	YB9807CH	Chrome	
227074	YB9807ORB	Oil Rubbed Bronze	

Waterhill Drawer Knob



Part #	Mfg #	Finish	Price
227075	YB9805ORB	Oil Rubbed Bronze	

Weymouth™ Drawer Knob



Part #	Mfg #	Finish	Price
181603	YB8405NL	Polished Nickel	
181601	YB8405ORB	Oil Rubbed Bronze	

Globe Light Fixtures

90° Bath Lighting



Part #	Mfg#	Globes	Finish	Price
224149	YB8863CH	3	Chrome	
222121	YB8864CH	4	Chrome	

Brantford™ Bath Lighting



Part #	Mfg#	Globes	Finish	Price
224878	YB2262BN	2	Brushed Nickel	
177404	YB2262ORB	2	Oil Rubbed Bronze	
214675	YB2263BN	3	Brushed Nickel	
177365	YB2263ORB	3	Oil Rubbed Bronze	
177366	YB2264ORB	4	Oil Rubbed Bronze	

Eva™ Bath Lighting



Part #	Mfg#	Globes	Finish	Price
180777	YB2864CH	4	Chrome	
225703	YB2862BN	2	Brushed Nickel	
226013	YB2863BN	3	Brushed Nickel	

Vanity Cabinets & Hardware

Bath Accessories

Iso™ Bath Lighting



Part #	Mfg#	Globes	Finish	Price
160523	DN0761BN	1	Brushed Nickel	
162221	DN0761CH	1	Chrome	
177268	DN0762CH	2	Chrome	
177269	DN0763CH	3	Chrome	
179784	DN0764CH	4	Chrome	

Rothbury™ Bath Lighting



Part #	Mfg#	Globes	Finish	Price
156251	YB8261BN	1	Brushed Nickel	

Voss™ Bath Lighting



Part #	Mfg#	Globes	Finish	Price
176467	YB5162BN	2	Brushed Nickel	
225684	YB5163BN	3	Brushed Nickel	
189713	YB5163CH	3	Chrome	
224372	YB5164CH	4	Chrome	
187072	YB5164ORB	4	Oil Rubbed Bronze	

Waterhill® Bath Lighting



Part #	Mfg#	Globes	Finish	Price
139680	YB9862ORB	2	Oil Rubbed Bronze	
161651	YB9863BN	3	Brushed Nickel	
136553	YB9863ORB	3	Oil Rubbed Bronze	
227250	YB9864BN	4	Brushed Nickel	
160743	YB9864ORB	4	Oil Rubbed Bronze	

Mirrors

Arris™ Magnifying Mirror



Part #	Mfg #	Finish	Price
173216	YB0892BN	Brushed Nickel	
176261	YB0892CH	Chrome	

Gilcrest® Mirror



Part #	Mfg #	Finish	Price
116645	DN0892ORB	Oil Rubbed Bronze	

Glenshire® Mirror



Part #	Mfg #	Finish	Price
109190	DN2692BN	Brushed Nickel	
116221	DN2692CH	Chrome	

Iso™ Mirror



Part #	Mfg #	Finish	Price
106155	DN0792CH	Chrome	

Vanity Cabinets & Hardware

Bath Accessories

Sage® Mirror



Part #	Mfg #	Finish	Price
104366	DN6892BN	Brushed Nickel	

Sienna® Mirror



Part #	Mfg #	Finish	Price
124416	DN4992BK	Matte Black	

Hair Dryer Holders Voss™ Hair Dryer Holder



Part #	Mfg #	Finish	Price
154325	YB5170BN	Brushed Nickel	

Shower Seats

Home Care Shower Seat



Part #	Mfg #	Finish	Price
151734	DN7025	Glacier	

Home Care Transfer Bench

- Supports up to 300 lbs
- Non-slip seat surface
- Complies with ADA specifications
- 33.25"W x 19.25"D
- 17" to 21" adjustable height



Part #	Mfg #	Finish	Price
125009	DN7065	Glacier	

Home Care Shower Chair



Part #	Mfg #	Finish	Price
173389	DN8060	Glacier	

Home Care Tub Safety Bar



Part #	Mfg #	Finish	Price
171542	DN7010	Glacier	
110283	DN7005	Glacier	

Home Care Bath Tread Strips



Part #	Mfg #	Finish	Price
104338	DN7045	Tread Strips	

Bath/Shower Mat

- Adhesive backing for easy application
- Fits most tubs and showers



Part #	Mfg #	Finish	Price
206482	DN7050	Glacier	

Bath Accessories

Bath Safety Teak Folding Shower Seat



Part #	Mfg #	Finish	Price
114623	DN7110	Stainless Hardware	
225112	DN7110OWB	Old World Bronze Hardware	

Grab Bars

Grab Bars

Contemporary Grab Bar

- Premium metal construction
- ADA Compliant when located and mounted per ADA guidelines



Part #	Mfg #	Description	Price
124629	K-14560-BN	12", *Brushed Nickel	
102409	K-14560-BS	12", Brushed Stainless	
168842	K-14560-S	12", Polished Stainless	
114191	K-14561-BN	18", *Brushed Nickel	
225937	K-14561-S	18", Pol Stainless	
119862	K-14562-BN	24", *Brushed Nickel	
102410	K-14562-BS	24", Brushed Stainless	
131515	K-14562-SN	24", Pol Stainless	
158851	K-14562-SN	24", *Pol Nickel	
137083	K-14564-BN	36", *Brushed Nickel	
102411	K-14564-BS	36", Brushed Stainless	

Elevance® 17" Curved Grab Bar

- Premium brass construction
- For use with Elevance® rising wall baths



Part #	Mfg #	Description	Price
158866	K-1010-CP	17", Pol Chrome	
150204	K-1010-BN	17", *Brushed Nickel	
182983	K-1010-BV	17", *Brushed Bronze	
150242	K-1010-2BZ	17", Oil-Rubbed Bronze	

Traditional Grab Bar

- Premium metal construction
- ADA Compliant when located and mounted per ADA guidelines



Part #	Mfg #	Description	Price
171861	K-10540-S	12", Pol Stainless	
123172	K-10540-BN	12", *Brushed Nickel	
124850	K-10540-BV	12", *Brushed Bronze	
172825	K-10540-SN	12", Pol Nickel	
173985	K-10540-AF	12", *French Gold	
155921	K-10540-2BZ	12", Oil Rubbed Bronze	
137490	K-10541-S	18", Pol Stainless	
112382	K-10541-BN	18", *Brushed Nickel	
117932	K-10541-BV	18", *Brushed Bronze	
189392	K-10541-SN	18", *Polished Nickel	
153140	K-10541-2BZ	18", Oil-Rubbed Bronze	
124878	K-10542-S	24", Polished Stainless	

Grab Bars (Continued)

Traditional Grab Bar

Part #	Mfg #	Description	Price
123173	K-10542-BN	24", *Brushed Nickel	
124851	K-10542-BV	24", *Brushed Bronze	
154806	K-10542-AF	24", *French Gold	
156171	K-10542-2BZ	24", Oil Rubbed Bronze	
156094	K-10543-BN	32", *Brushed Nickel	
162720	K-10543-BV	32", *Brushed Bronze	
172824	K-10543-SN	32", Polished Nickel	
125675	K-10544-BN	36", *Brushed Nickel	
176335	K-10544-BV	36", *Brushed Bronze	
226396	K-10544-S	36", Polished Stainless	
189391	K-10544-SN	36", *Polished Nickel	
159745	K-10544-2BZ	36", Oil Rubbed Bronze	
176898	K-10545-BN	42", *Brushed Nickel	
146925	K-10545-BV	42", *Brushed Bronze	
226397	K-10545-S	42", Polished Stainless	
176891	K-10545-2BZ	42", Oil-Rubbed Bronze	

Traditional Grab Bar



Part #	Mfg #	Description	Price
135482	K-11875-S	36", Pol Stainless	

Transitional Grab Bar

- Premium metal construction
- Template included
- ADA Compliant when located and mounted per ADA guidelines



Part #	Mfg #	Description	Price
118169	K-11390-BN	12", *Brushed Nickel	
103055	K-11390-BS	12", Brushed Stainless	
116849	K-11390-BV	12", *Brushed Bronze	
128581	K-11390-S	12", Pol Stainless	
119182	K-11391-BN	18", *Brushed Nickel	
122293	K-11391-BS	18", Brushed Stainless	
116795	K-11391-BV	18", *Brushed Bronze	
102911	K-11391-S	18", Pol Stainless	
117270	K-11392-BN	24", *Brushed Nickel	
103056	K-11392-BS	24", Brushed Stainless	
116850	K-11392-BV	24", *Brushed Bronze	
116955	K-11392-S	24", Pol Stainless	
182994	K-11394-BN	36", *Brushed Nickel	
103058	K-11394-BS	36", Brushed Stainless	
123138	K-11394-BV	36", *Brushed Bronze	

* Vibrant Limited Lifetime Warranty

www.waterconcepts.net • Serving our Customers Since 1946 • www.plumbsupply.com

Grab Bars

Grab Bars (Continued)

Transitional Grab Bar

Part #	Mfg #	Description	Price
189924	K-11394-S	36", Polished Stainless	
182995	K-11395-BN	42", *Brushed Nickel	

Decorative Traditional Grab Bar

- Premium metal construction
- Tools and installation template included



Part #	Mfg #	Description	Price
169144	K-11870-BN	9", *Brushed Nickel	
183000	K-11870-BN	9", *Brushed Bronze	
137760	K-11870-S	9", Polished Stainless	
144718	K-11871-BN	12", *Brushed Nickel	
162716	K-11871-BV	12", Brushed Bronze	
173109	K-11871-S	12", Pol Stainless	
173119	K-11871-SN	12", Pol Nickel	
185461	K-11872-BN	18" *Br Nickel	
162717	K-11872-BV	18", Brushed Bronze	
173108	K-11872-S	18", Polished Stainless	
186682	K-11872-SN	18", *Polished Nickel	
156975	K-11873-BN	24", *Brushed Nickel	
162718	K-11873-BV	24", Brushed Bronze	
173112	K-11873-S	24", Pol Stainless	
186683	K-11873-SN	24" *Pol Nickel	
162719	K-11874-BV	32", *Brushed Bronze	
181159	K-11875-BV	36", *Brushed Bronze	
178625	K-11876-S	42", Polished Stainless	

Maestro™ Hand Grab Bars

- Set of (2) grab bars



Part #	Mfg #	Description	Price
158204	K-9621-CP	Polished Chrome	

Margaux® Grab Bar

- Premium metal construction
- Tools and installation template included
- ADA Compliant when located and mounted per ADA guidelines



Part #	Mfg #	Description	Price
133517	K-11880-BN	9", *Brushed Nickel	
157462	K-11880-BV	9", *Brushed Bronze	
151140	K-11881-BN	12", *Brushed Nickel	
223018	K-11881-S	12", Polished Stainless	
222089	K-11882-SN	18", *Polished Nickel	
183169	K-11883-BV	24", *Brushed Bronze	
222088	K-11883-SN	24", *Polished Nickel	
151142	K-11885-BN	36", *Brushed Nickel	

Purist® Grab bar

- Premium metal construction
- Tools and installation template included



Part #	Mfg #	Description	Price
136777	K-11891-BN	12", *Brushed Nickel	
143117	K-11891-BS	12", Brushed Stainless	
148126	K-11891-S	12", Pol Stainless	
146886	K-11892-S	18", Pol Stainless	
143789	K-11893-BN	24", *Brushed Nickel	
129939	K-11893-S	24", Pol Stainless	
158402	K-11894-BN	32", *Brushed Nickel	
158663	K-11894-S	32", Pol Stainless	
143790	K-11895-BN	36", *Brushed Nickel	
146761	K-11895-BS	36", Brushed Stainless	
147147	K-11895-BV	36", *Brushed Bronze	
171151	K-11895-S	36", Polished Stainless	
183001	K-11896-BS	42", Brushed Stainless	

Sonata® Accessory Kit

- Includes: Grab bar and shelf kit
- Premium metal construction
- Tempered glass shelf
- Required for 1-piece Sonata® shower stalls, except K-1569



Part #	Mfg #	Description	Price
071873	K-9459-CP	16", Chrome	
081814	K-9459-AF	16", *French Gold	
073663	K-9459-BN	16", *Brushed Nickel	
094052	K-9459-BV	16", *Brushed Bronze	
094053	K-9459-G	16", Brushed Chrome	

* Vibrant Limited Lifetime Warranty

www.plumbsupply.com • Serving our Customers Since 1946 • www.waterconcepts.net

Grab Bars

Grab Bars (Continued)

Sonata® Accessory Kit

Part #	Mfg #	Description	Price
074241	K-9459-PB	16", *Polished Brass	
147098	K-9459-2BZ	16", Oil-Rubbed Bronze	

Vigora®Waterscape® Grab Bars

- Set of two grab bars
- Premium metal construction
- For use with k-1418, k-1375, k-1457, k-856 Whirlpools



Part #	Mfg #	Description	Price
079157	K-9653-BN	10-1/2", *Brushed Nickel	
183659	K-9653-2BZ	10-1/2", Oil Rubbed Bronze	

* Vibrant Limited Lifetime Warranty

www.waterconcepts.net • Serving our Customers Since 1946 • www.plumbsupply.com

Grab Bars

Stainless Steel Grab Bars
Concealed Flange SS Grab Bar



Part #	Mfg #	Size	Finish	Price
036268	DB8912	1-1/2" x 12"	Satin	
036269	DB8916	1-1/2" x 16"	Satin	
036272	DB8918	1-1/2" x 18"	Satin	
036275	DB8924	1-1/2" x 24"	Satin	
036276	DB8930	1-1/2" x 30"	Satin	
036277	DB8932	1-1/2" x 32"	Satin	
036278	DB8936	1-1/2" x 36"	Satin	
036279	DB8942	1-1/2" x 42"	Satin	
036280	DB8948	1-1/2" x 48"	Satin	

Vanity Cabinets & Hardware

Grab Bars

Tub & Shower Components

Straight Thin Grip Grab Bar

- 2-7/8" Thin grip



Part #	Mfg #	Description	Price
153231	80001012-N	12", Nickel	
154517	80001012-V	12", Matte Silver	
143053	80001018-V	18", Matte Silver	
155776	80001024-N	24", Nickel	
138995	80001024-V	24", Matte Silver	
169829	80011032-N	32", Matte Silver	

Straight Wide Grip Grab Bar

- 3-1/4"



Part #	Mfg #	Description	Price
171936	80011032-N	32", Nickel	

Curved Wide Grip Grab Bar

- 3-1/4" Wide grip



Part #	Mfg #	Description	Price
153230	80012031-N	28", Nickel	
144671	80012031-V	31", Matte Silver	
142413	80012134-N	33-1/2", Nickel	
138042	80012134-V	33-1/2", Matte Silver	

Vanity Cabinets & Hardware

Grab Bars

Grab Bars

90° Decorative Grab Bar

- Supports up to 500 lbs
- 1.25" Diameter
- 2.94" From wall



Part #	Mfg #	Finish	Price
165963	YG8812BN	12", Brushed Nickel	
171268	YG8812CH	12", Chrome	
162299	YG8818BN	18", Brushed Nickel	
171372	YG8818CH	18", Chrome	
160224	YG8824BN	24", Brushed Nickel	
171269	YG8824CH	24", Chrome	
171373	YG8836CH	36", Chrome	
182235	YG8836BN	36", Brushed Nickel	
171374	YG8842CH	42", Chrome	

Align™ Designer Grab Bar

- Supports up to 500 lbs
- 1.25" Diameter



Part #	Mfg #	Finish	Price
223772	YG0418CH	18", Chrome	
219819	YG0436CH	36", Chrome	

Arris™ Designer Grab Bar

- 1.25" Diameter
- 2.75" From wall
- Supports up to 500 lbs
- ADA compliant



Part #	Mfg #	Finish	Price
165367	YG0812CH	12" Chrome	
188943	YG0812BN	12", Brushed Nickel	
165368	YG0818CH	18" Chrome	
188944	YG0824BN	42", Brushed Nickel	

Brantford Designer Grab Bar

- Supports up to 500 lbs
- 1.25" Bar diameter



Part #	Mfg #	Finish	Price
179504	YG2212ORB	12", Oil Rubbed Bronze	
177363	YG2218ORB	18", Oil Rubbed Bronze	
228780	YG2224ORB	24", Oil Rubbed Bronze	

Eva Designer Grab Bar

- Supports up to 500 lbs
- 1.25" Diameter



Part #	Mfg #	Finish	Price
181421	YG2812ORB	12", Oil Rubbed Bronze	
226989	YG2818BN	18", Brushed Nickel	
186303	YG2818CH	18", Chrome	
180901	YG2818ORB	18", Oil Rubbed Bronze	
186304	YG2824CH	24", Chrome	
186186	YG2824ORB	24", Oil Rubbed Bronze	

Kingsley® Designer Grab Bar

- 1.25" Diameter
- 2.925" From wall
- ADA Compliant
- Supports up to 500 lbs



Part #	Mfg #	Finish	Price
108390	YG5412CH	12", Chrome	
085509	YG5412BN	12", Brushed Nickel	
102252	YG5412ORB	12", Oil Rubbed Bronze	
094539	YG5418BN	18", Brushed Nickel	
102253	YG5418ORB	18", Oil Rubbed Bronze	
086137	YG5424BN	24", Brushed Nickel	
107134	YG5424CH	24", Chrome	
102254	YG5424ORB	24", Oil Rubbed Bronze	
117678	YG5430BN	30", Brushed Nickel	
121288	YG5430CH	30", Chrome	
105778	YG5436BN	36", Brushed Nickel	
128051	YG5436CH	36", Chrome	
167309	YG5442BN	42" Brushed Nickel	
128052	YG5442CH	42", Chrome	

Iso® Decorative Grab Bar

- 1.25" Diameter
- Supports up to 500 lbs
- ADA compliant
- 2.75" From wall



Part #	Mfg #	Finish	Price
170507	YG0712BN	12", Brushed Nickel	
167207	YG0718BN	18", Brushed Nickel	
170508	YG0724BN	24", Brushed Nickel	
184457	YG0724CH	24", Chrome	
184458	YG0736CH	36", Chrome	

Vanity Cabinets & Hardware

Grab Bars

Grab Bars (Continued)

Iso® Decorative Grab Bar

Part #	Mfg #	Finish	Price
190097	YG0736BN	36", Brushed Nickel	
167208	YG0742BN	42", Brushed Nickel	

Voss™ Designer Grab Bar



Part #	Mfg #	Finish	Price
225686	YG5124BN	24", Brushed Nickel	

SecureMount™ Designer Elegance Grab Bar

- 1-1/4" Diameter
- Concealed screw
- ADA Compliant



Part #	Mfg #	Description	Price
114000	R8716D1GBN	16", Brushed Nickel	
117346	LR8716D3BN	16", Brushed Nickel	
104832	LR8724D1GCH	24", Chrome	
112704	LR8724D1GBN	24", Brushed Nickel	
127986	LR8724D1GOWB	24", Old World Bronze	

SecureMount™ Designer Elite Grab Bar

- 1-1/4" Diameter
- Concealed screw
- ADA Compliant



Part #	Mfg #	Description	Price
101125	LR8716D2BN	16", Brushed Nickel	
093871	LR8716D3GBN	16", Brushed Nickel	
147703	LR8716D3CH	16", Chrome	
113705	LR8716D3GOWB	16", Old World Bronze	
101166	LR8724D2BN	24", Brushed Nickel	
107061	LR8724D3GCH	24", Chrome	
113706	LR8724D3GOWB	24", Old World Bronze	
106865	LR8724D2CH	24", Chrome	

SecureMount™ Designer Ultima Grab Bar

- 1-1/4" Diameter
- Concealed screw
- ADA Compliant



Part #	Mfg #	Description	Price
151733	R8712D3GBN	12", Brushed Nickel	
151461	R8712D3GCH	12", Chrome	
150880	R8712D3GOWB	12", Old World Bronze	
095077	LR8716D3GCH	16", Chrome	
178362	R8718D3GBN	18", Brushed Nickel	
160669	R8718D3GOWB	18", Old World Bronze	
104687	LR8724D3GBN	24", Brushed Nickel	
106566	LR8724D3BN	24", Brushed Nickel	
121836	LR8724D3CH	24", Chrome	
107062	R8736D3GCH	36", Chrome	
131290	R8736D3GBN	36", Brushed Nickel	
174435	R8742D3GBN	42", Brushed Nickel	
107063	R8742D3GCH	42", Chrome	

Home Care® Concealed Screw Grab Bar

- 1.25" Diameter
- Supports up to 500 lbs
- ADA Compliant



Part #	Mfg #	Description	Price
165824	8912	12", Stainless	
147414	R8712P	12", Peened	
147415	R8716P	16", Peened	
158549	R8716W	16", Glacier	
158546	8718	18" Stainless	
113597	R8918	18", Stainless	
159011	R8918P	18", Peened	
116799	R8718PS	18", Polished Stainless	
098876	R8718PB	18", Polished Brass	
110247	R8718W	18", Glacier	
107317	R8918W	18", Glacier	
116977	8724	24", Stainless	
142352	R8724P	24", Peened	
109409	R8724PS	24", Polished Stainless	
084087	LR8724PS	24", Polished Stainless - Retail Packaging	
087162	R8724W	24", Glacier	
113349	R8924	24", Stainless	
078165	R8924W	24", Glacier	
201420	R8930	30", Stainless	

Grab Bars

Grab Bars (Continued)

Home Care® Concealed Screw Grab Bar

Part #	Mfg #	Description	Price
134809	R8930W	30", Glacier	
139485	R8730W	30", Glacier	
136776	R8730P	30", Peened	
205876	R8932	32", Stainless	
104545	R8736PS	36", Polished Stainless	
087161	R8736W	36", Glacier	
159012	R8936P	36", Peened	
142353	R8736P	36", Peened	
116728	R8936W	36", Glacier	
162301	8742	42" Stainless	
104546	R8742PS	42", Polished Stainless	
078084	8748	48", Stainless	
200253	R8948P	48", Peened	
153952	R8748W	48", Glacier	
227217	R8748P	48", Peened	
190906	DN8948	48", Stainless	

Home Care® Grab Bar with Accessories

- Corrosion resistant
- Supports up to 250 lbs
- 1.0" Diameter



Part #	Mfg #	Finish	Price
151460	LR2350DBN	24", Brushed Nickel	
163602	LR2354DCH	9", Chrome	

Home Care® Curved Grab Bar with Accessories

- Supports up to 250 lbs
- 1" Bar diameter



Part #	Mfg #	Finish	Price
183964	LR2356DCH	16", Chrome	
226821	R2356DBN	16", Brushed Nickel	
220767	R2356DOWB	16", Old World Bronze	

Home Care® Bath Grip

- 0.875" Bar diameter
- Supports up to 250 lbs
- Corrosion resistant



Part #	Mfg #	Finish	Price
155745	LR2260	16", Chrome	
108377	R2270W	24", Glacier	

Home Care® Designer Bath Grip



Part #	Mfg #	Finish	Price
106694	LR2250DCH	9", Chrome	

Home Care® Suction Hand Grip

- Corrosion resistant
- 1.26" Diameter
- Plastic construction



Part #	Mfg #	Finish	Price
163239	LR2308W	12", White	

Grab Bar with Paper Holder



Part #	Mfg #	Finish	Price
149166	LR2352DCH	8", Chrome	

Flip Up Grab Bar

- 1.25" Bar diameter
- Corrosion resistant
- Supports up to 300 lbs
- ADA Compliant



Part #	Mfg #	Finish	Price
167802	R8960FD	30", Chrome	
176950	R8960FDW	30", Glacier	
138090	R8962FDW	30", Glacier w/ Paper Holder	

Home Care® SecureMount Anchor

- Supports up to 300 lbs
- ADA compliant
- 2 Anchors with mounting plate



Part #	Mfg #	Finish	Price
100610	SMA1000CH	Chrome Anchor	

Grab Bars

Home Care® L-Shaped Grab Bar

- 1.5" Bar diameter
- 16" Bar length
- Supports up to 500 lbs
- Peened finish



Part #	Mfg #	Finish	Price
157449	8992	Chrome	

Grab Bars

Grab Bars

Lahara® Corner Self/Assist Bar

- 9-1/2"
- 7/8" Diameter assist bar
- Supports loads exceeding 250 lbs when properly installed
- Mounting hardware included



Part #	Mfg #	Description	Price
174533	41416	Chrome	
227417	41416-SS	Stainless*	

Delta 24" Grab Bar

- 24" Long
- 1-1/4" Width



Part #	Mfg #	Description	Price
154282	40024	24", Chrome	
146401	40024-RB	24", Venetian Bronze®	
151752	40024-SS	24", Stainless	

Concealed Mounting Grab Bar

- Concealed mounting



1-1/2" Wide

Part #	Mfg #	Description	Price
154462	40118-SS	18", Stainless*	
156072	40124-SS	24", Stainless*	

1-1/4" Wide

Part #	Mfg #	Description	Price
163858	41218-SN	18", Satin Nickel	

Contemporary Grab Bar

- 1-1/4" Diameter
- Extends 2-3/4" from wall
- Concealed mounting
- 3" Diameter
- 1-1/2" Wall clearance
- Supports up to 500 lbs



Part #	Mfg #	Description	Price
181427	41812	12", Chrome	
167081	41812-SS	12", Stainless*	
225342	41812-CZ	12", Champagne Bronze™	
158256	41818	18", Chrome	
225346	41818-CZ	18", Champagne Bronze™	

Grab Bars (Continued)

Contemporary Grab Bar

Part #	Mfg #	Description	Price
167998	41818-RB	18", Venetian Bronze®	
167082	41818-SS	18", Stainless*	
164325	41824	24", Chrome	
168000	41824-RB	24", Venetian Bronze®	
170335	41824-SS	24", Stainless*	
173932	41836	36", Chrome	
158753	41836-RB	36", Venetian Bronze®	
168818	41836-SS	36", Stainless*	
190274	41842	42", Chrome	

Modern Grab Bar

- 1-1/4" Diameter
- Extends 2-3/4" from wall
- Concealed mounting
- 3" Diameter
- 1-1/2" Wall clearance
- Supports up to 500 lbs



Part #	Mfg #	Description	Price
166139	41912	12", Chrome	
182462	41912-RB	12", Venetian Bronze®	
167232	41912-SS	12", Stainless*	
169898	41918	18", Chrome	
171387	41918-CZ	18", Champagne Bronze™	
186776	41918-PN	18", Polished Nickel*	
160268	41918-RB	18", Venetian Bronze®	
163184	41918-SS	18", Stainless*	
169288	41924	24", Chrome	
180880	41924-CZ	24", Champagne Bronze™	
176544	41924-RB	24", Venetian Bronze®	
158611	41924-SS	24", Stainless*	
171386	41936	36", Chrome	
179989	41936-CZ	36", Champagne Bronze™	
166734	41936-RB	36", Venetian Bronze™	
164949	41936-SS	36", Stainless*	

Vanity Cabinets & Hardware

* Brilliance® Anti-Tarnish Lifetime Finishes

www.plumbsupply.com • Serving our Customers Since 1946 • www.waterconcepts.net

Grab Bars

Traditional Grab Bar

- 1-1/4" Diameter
- Extends 2-3/4" from wall
- Concealed mounting
- 3" Diameter
- 1-1/2" Wall clearance
- Supports up to 500 lbs



Part #	Mfg #	Description	Price
174299	41612	12", Chrome	
174842	41612-CZ	12", Champagne Bronze™	
171304	41612-PN	12", Polished Nickel*	
168258	41612-RB	12", Venetian Bronze®	
164928	41612-SS	12", Stainless*	
169818	41618	18", Chrome	
174843	41618-CZ	18", Champagne Bronze™	
222844	41618-PN	18", Polished Nickel	
162432	41618-RB	18", Venetian Bronze®	
163976	41618-SS	18", Stainless*	
167709	41624	24", Chrome	
159243	41624-CZ	24" Champagne Bronze™	
222845	41624-PN	24", Polished Nickel	
163977	41624-RB	24", Venetian Bronze®	
163975	41624-SS	24", Stainless*	
178588	41636	36", Chrome	
172364	41636-CZ	36", Champagne Bronze™	
164886	41636-RB	36", Venetian Bronze®	
163974	41636-SS	36", Stainless*	
229407	41642	42", Chrome	
226490	41642-SS	42", Stainless*	

Transitional Grab Bar

- 1-1/4" Diameter
- Extends 2-3/4" from wall
- Concealed mounting
- 3" Diameter
- 1-1/2" Wall clearance
- Supports up to 500 lbs



Part #	Mfg #	Description	Price
164868	41712	12", Chrome	
160848	41712-CZ	12", Champagne Bronze™	
166011	41712-RB	12", Venetian Bronze®	
160630	41712-SS	12", Stainless*	
168664	41718	18", Chrome	
163117	41718-CZ	18", Champagne Bronze™	
164451	41718-RB	18", Venetian Bronze®	
166379	41718-SS	18", Stainless*	
164869	41724	24", Chrome	

* Brilliance® Anti-Tarnish Lifetime Finishes

Grab Bars (Continued)

Transitional Grab Bar

Part #	Mfg #	Description	Price
167529	41724-CZ	24", Champagne Bronze™	
158916	41724-RB	24", Venetian Bronze®	
168025	41724-SS	24", Stainless*	
173016	41736	36", Chrome	
166034	41736-CZ	36", Champagne Bronze™	
163507	41736-RB	36", Venetian Bronze®	
160625	41736-SS	36", Stainless*	
224231	41742	42", Chrome	

Grab Bar with Adjustable Slide

- 24"



Part #	Mfg #	Description	Price
163865	RP32796	Chrome	

Shower Rods

Curved Shower Rod

- 5' Long
- 6' Bow
- 1" Stainless steel tubing
- Includes mounting brackets



Part #	Mfg #	Description	Price
158651	42205-SS	Stainless*	
157353	42205-ST	Bright Stainless-Chr Appr	

Grab Bars

Grab Bars

Grab Bar with Concealed Snap-On Flange

- 18 Gauge stainless steel
- Meets 900 lb downward pull when installed properly
- Meets ANSI 117.1 and all ADA code requirements



Part #	Mfg #	Description	Price
222821	G12116	1-1/4" x 16" Satin Finish	
222822	G12142	1-1/4" x 42" Satin Finish	

Medicine Cabinets & Mirrors

Medicine Cabinets

Aluminum Single-Door Medicine Cabinet with Framed Mirror Door

- Anodized aluminum construction
- Two adjustable tempered-glass shelves
- Mirrored door with bronze-finish frame
- Mirrors on back of door and interior back of cabinet
- Two-way adjustable hinges with 108° opening capability
- Can be installed with left- or right-hand swing
- Includes mounting hardware for surface or recessed installation
- Includes side mirror kit for surface mount installation



Part #	Mfg #	Description	Price
119763	K-2967-BR1	20"W x 26"H x 5-3/8"D, 1 Door 108° Hinge	

Archer® Single Door Medicine Cabinet

- Beveled edges
- Two adjustable glass shelves
- Full-overlay mirrored door with beveled edges
- Mirrors on back of door and interior back of cabinet
- Two-way adjustable hinges with 108° opening
- Can be installed with left- or right-hand swing
- Includes mounting hardware for surface or recessed installation
- Includes side mirror kit for surface mount installation



Part #	Mfg #	Description	Price
109734	K-3073-NA	20"W x 31"H x 5"D, 1 Door 108° Hinge	

Bancroft® Single Door Medicine Cabinet

- Full-overlay beveled mirror
- Mirrors on back of door and interior back of cabinet
- Two adjustable glass shelves
- Can be installed with left- or right-hand swing
- Includes mounting hardware for surface or recessed installation
- Includes side mirror kit for surface installation



Part #	Mfg #	Description	Price
117489	K-CB-CLC2031BAN	20"W x 31"H x 5"D, 1 Door	

* Vibrant Limited Lifetime Warranty

www.waterconcepts.net • Serving our Customers Since 1946 • www.plumbsupply.com

Medicine Cabinets & Mirrors

Catalan® Aluminum Cabinet

- 4-3/4"D
- Recessed or surface-mount installation
- Triple mirror design - front of door, back of door, and interior back of cabinet
- (4) Adjustable black-tinted glass shelves
- Reversible left-hand or right-hand door hinge option
- Removable door for easy installation and cleaning



Part #	Mfg #	Description	Price
159381	K-2918-PG-SAA	20-1/8"W x 36"H x 4-3/4"D, 1 Door, 107° Hinge	
153948	K-2936-PG-SAA	24-1/8"W x 36"H x 4-3/4"D, 1 Door	
181828	K-2938-PG-SAA	15"W x 36"H x 4-3/4"D, 1 Door	
156765	K-2939-PG-SAA	20-1/8"W x 36"H x 4-3/4"D, 1 Door	
141972	K-2943-PG-SAA	24-1/8" x 36-1/8" x 4-3/4"D, 1 Door, 170°	

CL Flat Silver Aluminum Cabinet

- Mirrored door(s)
- 1/2" Beveled frameless door
- (2) Adjustable 1/4" glass shelves inside
- Side kit included for recess- or surface-mount



Part #	Mfg #	Description	Price
109869	K-CB-CLC1526FS	15"W x 26"H x 5"D, 1 Door	
121818	K-CB-CLC2026FS	20"W x 26"H x 5"D, 1 Door	

CB Aluminum Single Door Medicine Cabinet

- Recessed installation only
- Anodized aluminum construction with a durable rust-free and chip-free finish
- Two adjustable glass shelves
- Full-overlay mirrored door with beveled edges
- Mirrored interior
- Two-way adjustable hinges with 108° opening capability for easy cabinet access
- Can be installed with left- or right-hand swing



Part #	Mfg #	Description	Price
122188	K-CB-CLR1620FS	16"W x 20"H x 5"D, 1 Door 108° Hinge	

* Vibrant Limited Lifetime Warranty

www.plumbsupply.com • Serving our Customers Since 1946 • www.waterconcepts.net

Medicine Cabinets & Mirrors

CB Aluminum Two-Door Medicine Cabinet

- Recessed or surface mount installation
- Includes side mirror kit for surface mount installation
- Can be installed with left- or right-hand swing
- Mirrored interior
- Four adjustable glass shelves with vertical divider
- Two-way adjustable hinges with 108° opening capability for easy cabinet access



Part #	Mfg #	Description	Price
114799	K-CB-CLC2526FS	25"W x 26"H x 5"D, 2 Door 108° Hinge	
111706	K-CB-CLC3026FS	30"W x 26"H x 5"D, 2Door 108° Hinge	
108273	K-CB-CLC3526FS	35"W x 26"H x 5"D, 2Door 108° Hinge	

Damask™ Solid Wood Medicine Cabinet Surround

- Mounts directly to wall
- Solid wood and veneers
- Coordinates with Damask™ vanities for matched ensemble
- (K-99662-15) if for models K-99000-NA & K-99001-NA
- (K99662-24) is for models K-99006-NA & K-99007-NA



Part #	Mfg #	Description	Price
184122	K-99662-15-1WA	21"W x 36"H x 2"D, Linen White	For Models K-99000-NA & K-99001-NA
187731	K-99662-15-1WD	21"W x 36"H x 2"D, Ramie Walnut	For Models K-99000-NA & K-99001-NA
188987	K-99662-24-1WA	24"W x 32"H x 2"D, Linen White	For Models K-99006-NA & K-99007-NA

Devonshire® White Enameled Aluminum Single Door Medicine Cabinet

- 20"W x 29-1/2"H x 5-1/4"D
- Anodized aluminum
- Two adjustable tempered-glass shelves
- Right-hand door with mirror and white-enameled frame
- Mirrors on back of door and interior back of cabinet
- Includes side mirror kit for surface installation
- Includes mounting hardware for surface or recessed installation



Part #	Mfg #	Description	Price
108202	K-CB-CLW2030DAW	20"W x 29-1/2"H x 5-1/4"D, 2 Door 108° Hinge	

* Vibrant Limited Lifetime Warranty

www.waterconcepts.net • Serving our Customers Since 1946 • www.plumbsupply.com

Medicine Cabinets & Mirrors

Verdera™ Aluminum Cabinet

- Recessed or surface-mount installation
- Vertically adjustable magnifying mirror on inside of door
- (3) Adjustable glass shelves
- Full-overlay mirrored door
- Mirrored interior
- Slow-close door prevents slamming
- Two-way adjustable hinges with 108° opening capability for easy cabinet access
- Can be installed with left- or right-hand swing



Requires: K-99012 side mirror kit for surface mount installation

Part #	Mfg #	Description	Price
222823	K-99000-NA	15"W x 30"H x 4-3/4", 1 Door - Less Magnifying Mirror	
160371	K-99001-NA	15"W x 30"H x 4-3/4", 1 Door	
170991	K-99002-NA	20"W x 30"H x 4-3/4", 1 Door - Less Magnifying Mirror	
160140	K-99003-NA	20"W x 30"H x 4-3/4", 1 Door	
173209	K-99006-NA	24"W x 30"H x 4-3/4", 1 Door - Less Magnifying Mirror	
159444	K-99007-NA	24"W x 30"H x 4-3/4", 1 Door	
183662	K-99008-NA	34"W x 30"H x 4-3/4", 2 Doors	
166495	K-99009-NA	34"W x 30"H x 4-3/4", 2 Doors	
170057	K-99010-NA	40"W x 30"H x 4-3/4", 3 Doors - Less Magnifying Mirror	
173818	K-99011-NA	40"W x 30"H x 4-3/4", 3 Doors	

Verdera® Aluminum Cabinet with Open Bottomed Shelf

- Anodized aluminum construction with a durable rust-free and chip-free finish
- Open shelf offers quick access
- Two adjustable glass shelves
- Full-overlay mirrored door
- Mirrored interior
- Slow-close door prevents slamming
- Two-way adjustable hinges with 108-degree opening capability for easy cabinet access
- Includes mounting hardware for surface or recessed installation
- Requires K-99012 side mirror kit (sold separately) for surface mount installation



Part #	Mfg #	Description	Price
171790	K-99005-R-NA	20"W x 30"H x 4-3/4", 1 Door Right-Hand Swing	

* Vibrant Limited Lifetime Warranty

www.plumbsupply.com • Serving our Customers Since 1946 • www.waterconcepts.net

Medicine Cabinets & Mirrors

Framed Mirrors

Damask™ Framed Mirror

- 21-3/4"W x 36-3/4"H x 1"D



Part #	Mfg #	Description	Price
223008	K-99665-1WC	21-3/4"W x 36-3/4"H x 1"D, Felt Grey	

Evandale® Wood-Frame Mirror

- 23-1/2" x 32"
- Solid mahogany
- Includes hardware for vertical wall-mount installation



Part #	Mfg #	Description	Price
183035	K-2746-F25	23-1/2" x 32", Sapele Finish	
183170	K-2746-F44	23-1/2" x 32", Lily Finish	

Jacquard™ Wood-Frame Mirror

- 19-1/2" x 34-1/2"
- Solid woods and veneers
- Includes hardware for wall-mount installation
- Coordinates with Jacquard™ vanities for a matched ensemble



Part #	Mfg #	Description	Price
189036	K-99664-1WA	19-1/2" x 34-1/2", Linen White	

* Vibrant Limited Lifetime Warranty

www.waterconcepts.net • Serving our Customers Since 1946 • www.plumbsupply.com

Medicine Cabinets & Mirrors

Accessories

Catalan® Side Mirror Kit

- For Catalan medicine cabinets
- Surface-mount installations only
- Hardware included



Part #	Mfg #	Description	Price
143436	K-2878-NA	Catalan Side Mirror Kit	

Verdera™ Side Mirror Kit

- Required for surface mounting of Verdera™ medicine cabinets
- Hardware included



Part #	Mfg #	Description	Price
159445	K-99012-NA	Verdera™ Side Mirror Kit	

Catalan® Ganging Hardware



Part #	Mfg #	Description	Price
156766	K-2879-NA	Ganging Hardware	

Jacquard™ Medicine Cabinet Surround

- Designed to fit k-99010-na and k-99011-na Verdera™ Medicine Cabinets (Sold Separately)
- Coordinates with Jacquard™ vanities for a matched ensemble
- Catalyzed conversion varnish provides a durable moisture-resistant finish
- Mounts directly to wall
- Solid wood and veneers



Part #	Mfg #	Description	Price
185462	K-99661-40-1WE	36"H x 46"W x 2"D Terry Walnut	

* Vibrant Limited Lifetime Warranty

www.plumbsupply.com • Serving our Customers Since 1946 • www.waterconcepts.net

Medicine Cabinets & Mirrors

Poplin™ Medicine Cabinet Surround

- Designed to fit k-99000-na and k-99001-na Verdera™ medicine cabinets (sold separately)
- Coordinates with Poplin™ and Marabou™
- Catalyzed conversion varnish provides a durable moisture-resistant finish
- Mounts directly to wall
- Solid wood and veneers



Part #	Mfg #	Description	Price
183666	K-99663-15-1WA	36"H x 21"W x 15/16"D Linen White	

Verdera™ Medicine Cabinet Wood Side Kit

- Includes all hardware
- Solid wood and veneers
- For surface mounting of Verdera™ 30" tall medicine cabinets
- Coordinates with vanities in the KOHLER® Tailored vanity collection



Part #	Mfg #	Description	Price
188604	K-99675-1WA	30"H x 4"W x 2"D Linen White	
183692	K-99675-1WL	30"H x 4"W x 2"D Laurentii Silk	
222371	K-99675-1WU	30"H x 4"W x 2"D Batiste Black	

Vanity Cabinets & Hardware

* Vibrant Limited Lifetime Warranty

www.waterconcepts.net • Serving our Customers Since 1946 • www.plumbsupply.com

Vanities

Vanities

Alberry® 36" Vanity with Adjustable Shelf

- 33-1/2"H x 36"W x 21-1/2"D
- Express™
- Double doors with adjustable hinges
- Birch solids and paintable substrate
- Catalyzed polyurethane provides a durable moisture-resistant finish



Part #	Mfg #	Description	Dimensions	Color	Price
150622	K-2488-F40	Vanity Only	33-1/2" x 36" x 21-1/2"	Cinder	

Archer® Petite Vanity — 23" x 18-3/4" x 32-13/16"

- Maple solids and veneers
- Catalyzed polyurethane provides a durable moisture-resistant finish
- Pullout basket and bottom drawer



Combines with K-2358 Archer® 24" sink for complete vanity

Part #	Mfg #	Description	Dimensions	Color	Price
103424	K-2449-F2	Vanity Only	23" x 18-3/4" x 32-13/16"	Black Forest	

Bancroft® Petite Vanity — 22-1/8" x 19-3/4" x 31-3/4"

- Catalyzed polyurethane provides a durable moisture-resistant finish
- Full-extension bottom drawer



Combines with K-2340 Bancroft® 24" sink for complete vanity

Part #	Mfg #	Description	Dimensions	Color	Price
110521	K-2461-F2	Vanity Only	22-1/8" x 19-3/4" x 31-3/4"	Black Forest	

Clermont® Petite Vanity — 24" x 21-1/2" x 33-1/2"

- Ailanthus solids and quarter-sawn ash veneers
- Catalyzed polyurethane provides a durable moisture-resistant finish
- Single door, hinged left, with adjustable hinges
- Adjustable shelf including cabinet hardware
- Express™ vanities are easy to transport and set up in minutes



Part #	Mfg #	Description	Dimensions	Color	Price
181989	K-2415-F39	Vanity Only	24" x 21-1/2" x 33-1/2"	Oxford	

Vanities

Clermont® 30" Vanity

- 33-1/2" x 32" x 21-1/2"
- Ailanthus solids and quarter-sawn ash veneers
- Catalyzed polyurethane provides a durable moisture-resistant finish
- Adjustable shelf including cabinet hardware
- Express™ vanities are easy to transport and set up in minutes



Part #	Mfg #	Description	Dimensions	Color	Price
116039	K-2483-F39	Vanity Only	33-1/2" x 32" x 21-1/2"	Oxford	

Damask™ Vanity — 21-7/8" x 34-1/2"

- Catalyzed conversion varnish provides a durable moisture-resistant finish
- Three-way adjustable slow-close door hinges with 110-degree opening capability for easy cabinet access
- Full extension 18" depth drawers with slow-close under-mount slides for smooth opening
- Solid wood and veneers



Part #	Mfg #	Description	Dimensions	Color	Price
183664	K-99515-LG-1WD	Vanity Only, 2 Doors	30" x 21-7/8" x 34-1/2"	Ramie Walnut	
185568	K-99516-LG-1WC	Vanity Only, 2 Doors 1 Drawer	30" x 21-7/8" x 34-1/2"	Felt Grey	
187729	K-99517-LGL-1WD	Vanity Only, 1 Door 3 Drawers on Left	30" x 21-7/8" x 34-1/2"	Ramie Walnut	
224171	K-99524-LGSD-1WT	Vanity Only, 2 Doors 3 Drawers in Middle	60" x 21-7/8" x 34-1/2"	Mohair Grey	

Jacquard™ Vanity

- Catalyzed conversion varnish provides a durable moisture-resistant finish
- Three-way adjustable slow-close door hinges with 110-degree opening capability for easy cabinet access
- Full-extension 18" depth drawers with slow-close under-mount slides for smooth opening.
- Solid wood drawers with dovetail construction.
- Optional adjustable shelf / drawer organizer
- Door and drawer pulls are sold separately



Part #	Mfg #	Description	Dimensions	Color	Price
228180	K-99503-LG-1WC	Vanity Only, 2 Doors, 1 Bottom Drawer	30" x 21-7/8" x 34-1/2"	Felt Grey	
181471	K-99506-LG-1WC	Vanity Only, 2 Doors, 1 Bottom Drawer	36" x 21-7/8" x 39"	Felt Grey	
173937	K-99507-LG-1WC	Vanity Only, 1 Door, 3 Drawers on Left	36" x 21-7/8" x 39"	Felt Grey	
176499	K-99510-LG-1WC	Vanity Only, 2 Doors, 6 Drawers	60" x 21-7/8" x 34-1/2"	Felt Grey	
226204	K-99509-LGSD-1WE	Vanity Only, 2 Doors, 6 Drawers	48" x 21-7/8" x 34-1/2"	Terry Walnut	

Vanities

Jaquard™ Vanity with Toe Kick

- Catalyzed conversion varnish provides a durable moisture-resistant finish
- Frameless construction with full-overlay doors and drawers
- One door and three right offset drawers
- Three-way adjustable slow-close door hinges with 110-degree opening capability for easy cabinet access
- Optional adjustable shelf / drawer organizer (sold separately)
- Coordinates with other products in the Jacquard™ collection
- Toe kick covers blemished or inconsistent flooring
- Full-extension 18" depth drawers with slow-close under-mount slides for smooth opening
- Solid wood drawers with dovetail construction
- Door and drawer pulls are sold separately



Part #	Mfg #	Description	Dimensions	Color	Price
226537	K-99507-TKR-1WA	Vanity, 1 Door, 3 Drawers on Right	36" x 21-7/8" x 34-1/2"	Linen White	

Jute™ Wall-Hung Vanity — 21-7/8" x 19-1/2"

- Solid wood drawer with dovetail construction
- Frameless construction with full-overlay doors and drawer.
- Catalyzed conversion varnish provides a durable moisture-resistant finish.
- Full-extension 18" depth drawer with slow-close under-mount slides for smooth opening.
- Three-way adjustable slow-close door hinges with 110-degree opening capability for easy cabinet access.



Part #	Mfg #	Description	Dimensions	Color	Price
177669	K-99540-1WK	Vanity Only, 2 Doors	30" x 21-7/8" x 19-1/2"	Satin Oak	
186039	K-99542-1WJ	Vanity Only, 2 Doors	36" x 21-7/8" x 19-1/2"	Jersey Oak	
169514	K-99543-R-1WA	Vanity Only, 1 Door and 1 Drawer on Right	36" x 21-7/8" x 19-1/2"	Linen White	
168234	K-99544-1WK	Vanity Only, 2 Doors and 2 Drawers	48" x 21-7/8" x 19-1/2"	Satin Oak	
180838	K-99544-1WJ	Vanity Only, 2 Doors and 2 Drawers	48" x 21-7/8" x 19-1/2"	Jersey Oak	

Marabou™ Vanity — 21-7/8" x 34-1/2"

- Catalyzed conversion varnish provides a durable moisture-resistant finish.
- Frameless construction with full-overlay doors.
- Three-way adjustable slow-close door hinges with 110-degree opening capability for easy cabinet access.



99553-1WG
30" Cherry Tweed

Part #	Mfg #	Description	Dimensions	Color	Price
169581	K-99553-1WG	Vanity Only, 2 Doors	30" x 21-7/8" x 34-1/2"	Cherry Tweed	
183691	K-99555-1WG	Vanity Only, 2 Doors	36" x 21-7/8" x 34-1/2"	Cherry Tweed	
170471	K-99555-1WB	Vanity Only, 2 Doors	36" x 21-7/8" x 34-1/2"	Claret Suede	
225001	K-99556-L-1WC	Vanity Only, 2 Doors 2 LH Drawers	36" x 21-7/8" x 34-1/2"	Felt Grey	
183665	K-99557-1WB	Vanity Only, 2 Doors 4 Drawers	48" x 21-7/8" x 34-1/2"	Claret Suede	
168876	K-99559-1WG	Vanity Only, 4 Doors and 2 Drawers	60" x 21-7/8" x 34-1/2"	Cherry Tweed	

Vanities

Persuade® Petite Vanity

- Melamine and steel
- Durable melamine surface on interior and exterior of cabinet
- Two storage drawers and frosted glass shelf



Combines with K-2956 Persuade® sink for complete vanity

Part #	Mfg #	Description	Dimensions	Color	Price
161974	K-2527-F65	Vanity Only	25" x 22" x 31-1/2"	Mantle	

Persuade Single Door Vanity

- Durable melamine surface-exterior & interior
- Silver metallic powder coated finish frame
- Pull-out drawer with two storage trays

Part #	Mfg #	Description	Dimensions	Color	Price
132944	K-2529-F65	Vanity Only, 1 Door and 2 Drawers w/ Trays	25" x 22" 31-1/2"	Mantle	

Poplin™ Vanity — 21-7/8" x 34-1/2"

- Catalyzed conversion varnish provides a durable moisture-resistant finish
- Frameless construction with full-overlay door and drawers
- Solid wood drawers with dovetail construction
- Full extension 18" depth drawers with slow-close under-mount slides for smooth opening



Part #	Mfg #	Description	Dimensions	Color	Price
226749	K-99529-TK-1WA	Vanity Only, Toe Kick, 2 Doors 1 Drawer	30" x 21-7/8" x 34-1/2"	Linen White	
166450	K-99530-TKR-1WD	Vanity Only, Toe Kick, 1 Door 3 Drawers	30" x 21-7/8" x 34-1/2"	Ramie Walnut	
222223	K-99530-LGR-1WU	Vanity Only, Furniture Legs, 1 Door 3 RH Drawers	30" x 21-7/8" x 34-1/2"	Batiste Black	
230754	K-99532-LG-1WA	Vanity Only, Furniture Legs, 2 Door 1 Drawer	36" x 21-7/8" x 34-1/2"	Linen White	
175683	K-99533-LGL1-WB	Vanity Only, Furniture Legs, 1 Door 3 LH Drawers	36" x 21-7/8" x 34-1/2"	Claret Suede	
226540	K-99535-TKSD-1WA	Vanity Only, Toe Kick, 2 Doors 6 Drawers	48" x 21-7/8" x 34-1/2"	Linen White	
222222	K-99537-LGSD-1W	Vanity Only, Furniture Legs, 2 Doors 3 Drawers	60" x 21-7/8" x 34-1/2"	Batiste Black	

Tresham® Vanity

- Ash solids and veneers
- Three-way adjustable slow-close door hinges with 100-degree opening capability for easy cabinet access
- Slow-close under-mount drawer slides for smooth opening
- Includes decorative cabinet hardware
- Coordinates with other products in the Tresham collection
- Solid wood drawer with dovetail construction



Part #	Mfg #	Description	Dimensions	Color	Price
190456	K-5289-1WT	Vanity Only, 2 Doors	30" x 21-7/8" x 34-1/2"	Mohair Grey	

Vanities

Tresham® Petite Vanity

- Three-way adjustable slow-close door hinges with 100° opening capability for easy cabinet access
- Includes decorative cabinet hardware



Combines with K-2979 Tresham® sink for complete vanity

Part #	Mfg #	Description	Dimensions	Color	Price
144151	K-2604-F69	Vanity Only	23-3/4" x 18-1/4" x 32-1/2"	Woodland	

Vanity Accessories

Adjustable Shelf for 30" Tailored Vanities with 2 Doors

- Includes 4 electrical outlets (2 switched, 2 always live)
- Appliances can remain plugged in while vanity door is closed
- Solid wood and veneers



For use with K-99502 Jacquard™, K-99515 Damask™, and K-99528 Poplin™ vanities

Part #	Mfg #	Description	Dimensions	Color	Price
166451	K-99678-SH2-1WR	Vanity Shelf, 4 Electrical Outlets	28-3/8" x 18" x 3-1/8"	Oxford Maple	

Adjustable Shelf for 60" Tailored Vanities with 2 Doors

- Appliances can remain plugged in while vanity door is closed
- Solid wood and veneers



For use with K-99511 Jacquard™, K-99524 Damask™, and K-99537 Poplin™ vanities

Part #	Mfg #	Description	Dimensions	Color	Price
224170	K-99677-SH6-1WR	Vanity Shelf	22-15/16" x 19" x 3/4"	Oxford Maple	
224169	K-99678-SH6-1WR	Vanity Shelf, 4 Electrical Outlets	22-15/16" x 19" x 3/4"	Oxford Maple	

Drawer Divider for Tailored Vanities

- Compartmentalizes vanity drawer to maximize storage space and organize items
- Four storage compartments
- Sliding top tray for two-level storage
- Bamboo construction
- Includes 4 compartments plus a sliding top tray for two-level storage



For use with Jacquard™, Damask™, Poplin™, Marabou™, and Jute™ vanities

Part #	Mfg #	Description	Dimensions	Color	Price
166456	K-99684-1WS	Drawer Divider Package	8-3/4" x 16-5/8" x 3"	Bamboo Twill	

Vanities

General Storage Package

- Bamboo construction
- Includes one storage tray and one oral care tray
- Rubber feet allow you to set tray on the countertop during use
- Compartmentalizes vanity drawer to maximize storage space and organize items



For use with Jacquard™, Damask™, Poplin™, Marabou™, and Jute™ vanities

Part #	Mfg #	Description	Dimensions	Color	Price
166453	K-99682-1WS	General Storage Package	8-11/16" x 8-1/4"	Bamboo Twill	

Makeup Storage for Tailored Vanities

- Compartmentalizes vanity drawer to maximize storage space and organize items
- Includes removable magnifying mirror
- Compartments for holding makeup brushes and makeup items
- Bamboo construction
- Rubber feet allow you to set tray on the countertop during use



For use with Jacquard™, Damask™, Poplin™, Marabou™, and Jute™ vanities

Part #	Mfg #	Description	Dimensions	Color	Price
166454	K-99683-1WS	Makeup Storage Package	8-11/16" x 8-1/4" x 2-1/4"	Bamboo Twill	

Rollout Drawer for 30" Tailored Vanities with 1 Door, 3 Drawers

- Full-extension 18-inch depth drawer with slow-close under-mount slides for smooth opening
- Solid wood and veneers

For use with K-99504 Jacquard™, K-99517 Damask™, and K-99530 Poplin™ Vanities with 1 Door and 3 Drawers

Requires: K-99738 Appliance Tray

Can be paired with the K-99677 Adjustable Shelf or K-99678 Adjustable Shelf with Electrical Outlets



Part #	Mfg #	Description	Dimensions	Color	Price
166452	K-99679-SH8-1WR	Rollout Drawer	14-7/8" x 18" x 7-11/16"	Oxford Maple	

Rollout Tray for 60" Tailored Vanities with Double Basin

- Full-extension 18" depth trap with slow-close under-mount slides for smooth opening

For use with K-99511 Jacquard™, K-99524 Damask™, and K-99537 Poplin® vanities



Part #	Mfg #	Description	Dimensions	Color	Price
224168	K-99680-SH6-1WR	Rollout Drawer	20-11/16" x 18" x 3"	Oxford Maple	

Vanities

Side-Mount Electrical Outlets

- For use with *Jacquard™*, *Damask™*, *Poplin™*, *Marabou™*, and *Jute™* vanities
- Includes 4 electrical outlets (2 switched, 2 always live)
- Mounts into pre drilled holes in vanity for easy installation



Part #	Mfg #	Description	Dimensions	Color	Price
168235	K-99681-1WR	Side-Mount Electrical Outlet	19" x 2-3/8"	Oxford Maple	

Vanity Tops

**Oasis Cultured Marble Tops
Recessed Single Oval Bowl**

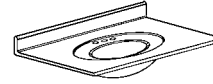

- Integral 4-1/4" high backsplash

Part #	Mfg #	Description	Price
002519	O01-OB2519	25" x 19" White on White Cultured Marble Top	
002520	O01-OB2522	25" x 22" White on White Cultured Marble Top	
002521	O01-OB3122	31" x 22" White on White Cultured Marble Top	
002523	O01-OB3722	37" x 22" White on White Cultured Marble Top	
002524	O01-OB4922	49" x 22" White on White Cultured Marble Top	

Commercial Electric Water Heaters

Commercial Electric Water Heaters

Point-of-Use - Commercial

3-Year Limited Warranty on Tank Against Leaks

- 120, 208, 240, 277 & 480 Volts, 1-phase
- Porcelain enamel lined tank
- Patented R-Tech anode rod provides advanced technology, equalizing aggressive water action while prolonging the effective life of the anode rod and in turn the life of the tank
- Rigid polyurethane foam insulation provides superior insulating qualities resulting in reduced operating costs
- Baked enamel steel jacket
- Resistor heating element
- Surface mounted thermostat automatically cycles on and off to maintain the water temperature at a desired preset level
- Manual reset high limit control



AGA/ASME Rated T&P Valve Included

Part #	Mfg #	Gal Cap	Min/Max Watts	Tank Height	Width	Approx Ship Weight	Price
066894	EGSP10	10	1,500 / 6,000	22-7/8"	15-3/4"	53 lbs	

Storage Tank - Commercial

5-Year Limited Warranty Against Tank Leaks

- Meets or exceeds thermal efficiency and standby loss requirements of current ASHRAE standard
- Installed individually, or in parallel manifold
- Steel tank with two coats of high temperature porcelain enamel
- Two magnesium anode rods
- Maximum working pressure: 150 psi
- ST80 and ST120 Can pass through a 30" opening, ST175 passes 33" openings
- 2" Rigid polyurethane foam insulation
- Order T&P valve separately



Part #	Mfg #	Gal Cap	Jacket Height	Diameter	Top Outlet/ Front Side Connections	Approx Ship Weight	Price
067164	ST80	80	58-5/16"	24-7/16"	2" NPT	220 lbs	
066488	ST120	115	59-1/4"	28-1/4"	2" NPT	300 lbs	
077341	ST200A	120	59-1/5"	28-1/5"	2" NPT	315lbs	

Water Heaters



Commercial Gas Water Heaters

Commercial Gas Water Heaters

SPIDERfire Sealed-Combustion Gas Water Heater- Commercial

3-Year Limited Tank Warranty

- Thermal efficiency of up to 95%
- No chimney required, vent using plastic pipe
- Low NOx emissions
- Direct spark ignition system
- Corrosion resistant, high efficiency 3-pass heat exchanger
- Small jacket diameters
- Short floor-to-vent heights
- Self-diagnostic LCD electronic control
- Zero clearance to all combustible surfaces
- Maximum operating temperature: 185°
- Front and back water connections
- Full flow drain valve

T&P Valve Included



Part #	Mfg #	Type Gas	Gal Cap	Input BTUH	Unit Height	Diameter	Vent	Approx Ship Weight	Price
151103	GHE80ES-130A	NG/LP	80	130,000	69-5/8"	26-1/4"	2",3",4"	725 lbs	
151102	GHE80ES-200	NG/LP	80	199,000	69-5/8"	26-1/4"	2",3",4"	725 lbs	
130062	GHE100-160	NG	100	160,000	78-3/4"	26-1/4"	2",3",4"	785 lbs	
130063	GHE100-160A	ASME NG	100	160,000	78-3/4"	26-1/4"	2",3",4"	820 lbs	
130064	GHE100ES200	NG	100	199,000	78-3/4"	26-1/4"	2",3",4"	785 lbs	
130065	GHE100ES200A	ASME NG	100	199,000	78-3/4"	26-1/4"	2",3",4"	820 lbs	
130067	GHE100ES250A	ASME NG	100	250,000	78-3/4"	26-1/4"	3",4"	860 lbs	
130070	GHE100ES300A	ASME NG	100	300,000	78-3/4"	26-1/4"	3",4"	860 lbs	

AdvantagePlus™ Sealed-Combustion Gas Water Heater- Commercial

3-Year Limited Tank Warranty

- 316L Stainless steel tank construction (requires no anode rods)
- Thermal efficiency to 95%
- No chimney required, direct vent using plastic pipe
- Low NOx emissions
- 2" Non-CFC polyurethane foam insulation
- Corrosion resistant, high efficiency 90/10 cupronickel heat exchanger
- Self-diagnostic LCD electronic control
- Zero clearance to all combustible surfaces
- Maximum operating temperature: 160°
- Removable front cover

T&P Valve Included



Part #	Mfg #	Type Gas	Gal Cap	Input BTUH	Unit Height	Diameter	Vent	Approx Ship Weight	Price
062009	HE80-130	NG	80	130,000	72"	23-1/2"	3"	235 lbs	

www.waterconcepts.net • Serving our Customers Since 1946 • www.plumbsupply.com



Commercial Gas Water Heaters

Commercial Gas Water Heaters (Continued)

AdvantagePlus™ Sealed-Combustion Gas Water Heater- Commercial

Part #	Mfg #	Type Gas	Gal Cap	Input BTUH	Unit Height	Diameter	Vent	Approx Ship Weight	Price
062016	HE119-199	NG	119	199,000	73"	27"	3"	405 lbs	

Universal Gas Water Heater - Commercial

3-Year Limited Tank Warranty

- Spark-to-pilot ignition system
- 80% Thermal efficiency
- Small jacket diameters
- Short floor-to-vent heights
- System Sentinel™ LED diagnostic system
- Maximum operating temperature: 180°
- Patented multi-flue design
- Low profile automatic flue damper
- Stainless steel burners
- Full port, full flow brass drain valve



T&P Valve Included

Part #	Mfg #	Type Gas	Gallon Capacity	Input BTUH	Height To Top Of Flue	Diameter	Flue	Approx Ship Weight	Price
061996	G75-125	NG	75	125,000	65-1/2"	26-1/4"	5"	480 lbs	
061999	G76-180	NG	76	180,000	68-13/16"	26-1/4"	6"	540 lbs	
062000	G76-200	NG	76	199,900	68-13/16"	26-1/4"	6"	540 lbs	
061994	G91-200	NG	91	199,900	76-5/16"	26-1/4"	6"	600 lbs	
061993	G100-200	NG	100	199,900	73-1/16"	30-1/4"	6"	780 lbs	
069620	G100-250A	ASME NG	100	250,000	73-1/4"	30-1/4"	8"	835 lbs	

Water Heaters



Commercial Gas Water Heaters

Medium Duty Gas Water Heater - Commercial 3-Year Limited Tank Warranty

- Small jacket diameters
- Short floor-to-vent heights
- Maximum operating temperature: 180°
- Designed to shut off gas if the pilot flame is extinguished
- Rigid polyurethane foam insulation
- Full port, full flow brass drain valve

AGA/ASME Rated T&P Valve Included

'N' Suffix denotes models meet Low NOx construction standard

"2" Suffix denotes models that are FVIR Compliant



Part #	Mfg #	Type Gas	Gallon Capacity	Input BTUH	Height To Top Of Flue	Diameter	Flue	Approx Ship Weight	Price
062004	G75-75N-3	NG	75	75,100	64"	26-1/4"	4"	320 lbs	
115995	G100-80	NG	100	80,000	69-5/8"	28-1/4"	4"	410 lbs	

Super Duty Gas Water Heater - Commercial 3-Year Limited Tank Warranty

- 93% Thermal efficiency
- 4" or 6" PVC vent
- Super duty units can be installed with power vent or power direct vent configurations
- LCD User interface
- Corrosion protection
- Multiple water connections
- Factory installed brass drain valve
- Advance burner design
- Hot surface ignition system
- Altitude certification
- CSA/ASME rated T&P valve: Factory installed relief valve



Part #	Mfg #	Type Gas	Gallon Capacity	Input BTUH	Height To Top Of Flue	Diameter	Flue	Approx Ship Weight	Price
162542	GHE119-500	NG/LG	119	500,000	78-1/2"	32"	4"	1,200	
162543	GHE125-500A	NG/LG	125	500,000	78-1/2"	32"	4"	1,200	

Water Heaters

Indirect Water Heaters

Water Heaters

Aqua Plus Indirect Fired Water Heater

- 316L Stainless steel tank welded with "TIG and Plasma" technology coil tank
- Temperature and pressure relief valve standard equipment
- Thermostat connections already installed for quick and easy wiring
- All connections include boiler supply and return, domestic water and domestic recirculation on side of tank
- Magnesium Anode installed in all tanks
- Inspection port located near bottom of all tanks
- Exceptional "R Value" with 2" dense foam insulation
- Adjustable feet for uneven floors
- Available in gold and pewter colors



Part #	Mfg #	Model	Domestic Water Gallons	Domestic Water Inlet/Outlet	Boiler Water Supply/Return	Dimensions H x Dia	Approx Ship Wt	Price
144390	633-500-000	Aqua Plus 35	29.6	3/4"	1"	36-3/8" x 21-7/8"	94 lbs	
144393	633-500-001	Aqua Plus 45	39.9	3/4"	1"	46-1/4" x 21-7/8"	111 lbs	
144394	633-500-002	Aqua Plus 55	53.1	3/4"	1"	60" x 21-7/8"	122 lbs	
144396	633-500-003	Aqua Plus 85	80.6	1"	1"	59-1/2" x 26"	223 lbs	
144397	633-500-004	Aqua Plus 105	109.4	1"	1"	59-3/4" x 30"	238 lbs	

Plus Indirect-Fired Water Heater

- Tank-within-a-tank design
- Corrugated stainless steel inner tank; steel outer tank
- Self-cleaning design resists liming
- No CFC used in insulation
- Special wrap-around design heats faster - no cold spots
- Every tank is 100% leak-tested



Part #	Mfg #	Model	Circulator Rate	Tank Capacity	Boiler Side Capacity	Tank Height	Tank Diameter	Approx Ship Wt	Price
074396	633-800-372	Ultra Plus 60	13 gpm	46 gal	8 gal	57"	22-1/4"	180 lbs	
021966	633-800-426	Plus 119	28 gpm	119 gal	30 gal	73-1/4"	32-1/4"	479 lbs	

Water Heaters



Residential Electric Water Heaters

Electric Water Heaters

Professional™ Electric Water Heater

8-Year Limited Tank and Parts Warranty with a Professional Installation

With ProtectionPlus™ the 8-Year Limited Tank Warranty Becomes 12-Years

- Brass drain valve
- Stainless steel lower heating element
- EverKleen™ self cleaning device
- Premium grade anode rod
- Exclusive Ruudglas® tank lining resists corrosion and prolongs tank life
- Electric junction box located above heating elements for easy installation
- Over-temperature protector cuts off power in excess temperature situations
- Automatic thermostat keeps water at desired temperature
- Meets or exceeds requirements of the National Appliance Energy Conservation Act (NAECA)
- Heaters furnished with standard 240V, single-phase non-simultaneous wiring, and 4500W upper and lower heating elements

T&P Valve Included



Tall

Part #	Mfg #	Gal Cap	Tank Height	Jacket Dia	First Hour Rating	Energy Factor	Approx Ship Weight	Price
173873	PRO+E40T2RU95EC1	40	46-3/4"	22-1/4"	56 gph	0.95	104 lbs	
173874	PRO+E50T2RU95EC	50	57"	22-1/4"	67 gph	0.95	123 lbs	

Professional Achiever™ Series Electric Water Heaters

6-Year Limited Tank and Parts Warranty with Professional Installation

- EverKleen™ patented self-cleaning system
- Isolated tank design
- Highly efficient restored heating elements
- Anode rod
- Electric junction box located above heating elements
- Over-temperature protector
- Automatic thermostat
- Brass drain valve
- Meets or exceeds National Appliance Energy Conservation Act (NAECA) requirements

T&P Valve Included



Tall

Part #	Mfg #	Gal Cap	Tank Height	Jacket Diameter	First Hour Rating	Energy Factor	Approx Ship Weight	Price
175819	PROE30T2RU95	30	47-1/2"	19-1/4"	48	0.95	92 lbs	
173871	PROE40T2RU95EC1	40	59-1/4"	17-3/4"	57	0.92	96 lbs	

Water Heaters



Residential Electric Water Heaters

Electric Water Heaters (Continued)

Professional Achiever™ Series Electric Water Heaters

Tall

Part #	Mfg #	Gal Cap	Tank Height	Jacket Diameter	First Hour Rating	Energy Factor	Approx Ship Weight	Price
176310	PROE40T2RU95	40	60-3/4"	19-1/4"	57	0.95	109 lbs	
176309	PROE50T2RU95	50	58-5/8"	20-1/4"	67	0.95	121 lbs	
185228	PROE55T2RU94	55	59-3/4"	22-1/4"	71	0.94	128 lbs	

Medium

Part #	Mfg #	Gal Cap	Tank Height	Jacket Diameter	First Hour Rating	Energy Factor	Approx Ship Weight	Price
173882	PROE30M2RU95	30	37-1/2"	20-1/4"	44	0.95	92 lbs	
175634	PROE40M2RU95	40	46-1/2"	19-3/4"	53	0.95	95 lbs	
173894	PROE50M2RU95	50	48"	23"	65	0.95	132 lbs	

Short

Part #	Mfg #	Gal Cap	Tank Height	Jacket Diameter	First Hour Rating	Energy Factor	Approx Ship Weight	Price
173885	PROE30S2RU95B	30	30-1/8"	19-3/4"	42	0.95	95lbs	
173890	PROE38S2RU95B	38	31-1/2"	23"	45	0.92	108 lbs	
173892	PROE47S2RU95	47	32"	26-1/4"	55	0.91	149 lbs	

* 208V, 4500W

Marathon™ Electric Water Heater 5-Year Parts Warranty, Lifetime Limited Tank Warranty

- PermaGuard Lifetime tank - combines a seamless blow molded polybutylene inner tank reinforced with a filament wound fiberglass outer tank for maximum strength
- Lightweight polyethylene outer jacket resist damage and corrosion
- Patented Envirofoam™ insulation process for superior heat retention
- Upper low watt density element

T&P Valve Included



Tall

Part #	Mfg #	Gal Cap	Tank Height	Jacket Diameter	First Hour Rating	Energy Factor	Approx Ship Weight	Price
062159	MR50245	50	62-3/4"	23-1/2"	61	0.94	100 lbs	

Water Heaters



Residential Electric Water Heaters

Heavy Duty

Part #	Mfg #	Gal Cap	Tank Height	Jacket Diameter	First Hour Rating	Energy Factor	Approx Ship Weight	Price
175548	MHD85245	85	66-1/4"	28-1/4"	91	0.92	134 lbs	
175547	MHD105245	105	66-3/4"	30-1/4"	104	0.92	152 lbs	

Marathon™ Electric Point-of-Use Water Heater

5-Year Limited Tank Warranty, 1-Year on Parts

- Seamless, blow-molded, polybutene tank – impervious to rust and corrosion
- Polyurethane insulation helps reduce energy consumption and standby heat loss
- Recessed drain valve is out of the way of brooms and scrubbers
- High temperature polysulfone dip tube
- Tough molded polyethylene outer shell resists dents, scratches, and salt air
- 3/4-Inch inlet and outlet connections
- Thermally fused element to protect against dry-firing; low watt, density for long life
- Full-flow, brass drain valve
- Temperature and pressure relief valve



Part #	Mfg #	Gal Cap	Tank Height	Jacket Diameter	Element Wattage	Voltage	Approx Ship Weight	Price
072829	MR20230	19.9	30-1/2"	23-1/2"	3000	240	61 lbs	

Point-of-Use Ruudglas® Energy Miser® Electric Water Heater

6-Year Limited Tank and Parts Warranty

- Space-saving design for installation in limited spaces
- High efficiency heating elements
- Over-temperature protector
- Automatic thermostat
- Meets or exceeds National Appliance Energy Conservation Act (NAECA) requirements



T&P Valve Included

2.5 Gallon Point-of-Use Model

- Standard 120V with (3) prong cord set
- Optional 240V model includes junction box
- Corrosion resistant 1/4-turn drain valve
- Wall bracket for easy wall mount installations
- 1/2" NPT Inlet and outlet
- 3/4" Relief valve connection

Part #	Mfg #	Gal Cap	Tank Height	Jacket Diameter	Approx Ship Weight	Price
161883	PROE21RUPOU	2.5	14"	9-3/4"	22 lbs	

Water Heaters



Residential Electric Water Heaters

6 Through 30 Gallon Point-of-Use Models

- 3/4" NPT Outlet and inlet
- Anode rod
- Patented R-Foam® Insulation process
- Not available with 3-phase wiring
- Standard 120V, 2,000W single element

Part #	Mfg #	Gal Cap	Tank Height	Jacket Diameter	Energy Factor	Approx Ship Weight	Price
161896	PROE61RUPOU	6	15-1/4"	15-3/4"	-	36 lbs	
161882	PROE101RUPOU	10	23"	15-3/4"	-	46 lbs	
163135	PROE101RUPPOU240V	10	23"	15-3/4"	-	46 lbs	
161894	PROE151RUPOU	15	24-1/4"	17-3/4"	-	54 lbs	
161897	PROE201RUPOU	20	25-1/4"	19-3/4"	-	69 lbs	
173870	PROE301RU95POU	30	30"	21-3/4"	0.93	91 lbs	
166157	PROE302RU93POU	30	30"	21-3/4"	0.93	91 lbs	

* Double element - 240V

Hybrid Electric Water Heaters

10-Year Limited Tank and Parts Warranty

Professional Ultra Series Hybrid Electric Water Heater

- High 3.5 EF reduces operating cost
- Delivers hot water faster than most standard electric water heaters
 - 70 gallons first-hour delivery for 50-gallon model
 - 78 gallons FHD for 65-gallon model
 - 90 gallons FHD for 80-gallon model
- Ambient operating range: 37-145° F is widest in class, offering more days of HP operation annually; designed to meet Northern Climate Spec (Tier 3)
- Easy access side connections, quick access to electrical junction box
- LCD Screen with built-in water sensor alert with audible alarm
- EcoNet™ WiFi-connected† technology and free mobile app
- Operation Modes: Energy Saver, Heat Pump, High Demand, Electric Vacation: 2-28 days (or placed on hold indefinitely)
- 3/4" NPT water inlet and outlet; 3/4" condensate drain connections
- Temperature and pressure relief valve installed
- Low lead compliant



Part #	Mfg #	Gal Cap	Tank Height	Diameter	First Hour Rating	Energy Factor	Approx Ship Weight	Price
228671	PROUH50T2RU350	50	61"	22-1/4"	70	3.50 EF	218 lbs	
228427	PROUH65-T2-RU350	65	64"	24-1/4"	78	3.50 EF	262 lbs	
228672	PROUH80-T2-RU350	80	74"	24-1/4"	90	3.50 EF	281 lbs	

Water Heaters

Residential Electric Water Heaters

EMT Electric Mini-Tanks

- Glass-lined tank for longer life
- Mounts on wall or floor
- T&P Relief valve included
- 2-Year warranty on parts
- 5-Year warranty on tank



EMT2.5 / EMT4 Electric Point-of-Use Mini-Tank

- Plugs into standard 110V outlet, 1.2kW, 10A
- 1/2" NPT Connections

Part #	Mfg #	Recovery Time (60° to 150°)	Dimensions	Use With:	Price
141431	EMT2.5	25 Minutes	17-5/16" x 11-7/16" x 11-7/16"	1 Sink	
141434	EMT4	45 Minutes	18-1/2" x 11-7/16" x 11-7/16"	2 Sinks	

EMT6 Hardwired Electric Point-Of-Use Mini-Tank

- 110V/120V, 1.5kW, 16.7A
- Note: 1,500W, 120V requires two 20A breakers
- 3/4" NPT Connections
- 1" Non-CFC foam insulation
- Factory dielectric
- Screw type immersion element
- Fully automatic controls, fast acting surface-mount thermostat
- Protective magnesium anode rod



Part #	Mfg #	Recovery Time (60° to 150°)	Dimensions	Price
141435	EMT6	55 Minutes	16-1/2" x 14"Dia	



Residential Gas Water Heaters

PowerVent™ Gas Water Heaters

PowerVent™ Induced Draft Residential Gas Water Heater with Guardian System™

6-Year Limited Tank and Parts Warranty

- Guardian System™ - air/fuel shut-off system offers double protection
- Maintenance free - no filter to clean
- Silicon nitride igniter (HSI)
- Flammable vapor detection sensor
- PVC, ABS or CPVC Venting up to 100' with vertical or horizontal termination
- Integrated self-diagnostic system
- Low NOx design for low nitrous oxide emissions
- High altitude compliant
- EverKleen™ patented self-cleaning system on 40 - 60 gal models
- Patented magnesium anode rod design
- Standard 110V electrical connection
- Exceeds National Appliance Energy Conservation Act (NAECA) and ASHRAE requirements
- Energy Star® Phase II on 40 and 50 gal models
- Brass drain valve



T&P Valve Included

Tall

Part #	Mfg #	Type Gas	Gal Cap	Gas Input BTUH	Height to Top of Assembly	Jacket Diameter	Vent Size	Energy Factor	Approx Ship Weight	Price
161252	PROG4040NRU67PV	NG	40	40,000	67-3/8"	19-3/4"	-	0.67	140 lbs	
161254	PROG4036PRU67PV	LP	40	36,000	67-3/8"	19-3/4"	-	0.67	140 lbs	
161253	PROG5042NRU67PV	NG	50	42,000	66-3/8"	21-3/4"	-	0.67	170 lbs	
161260	PROG5042PRU67PV	LP	50	42,000	66-3/8"	21-3/4"	-	0.67	170 lbs	

Short

Part #	Mfg #	Type Gas	Gal Cap	Gas Input BTUH	Height to Top of Assembly	Jacket Diameter	Vent Size	Energy Factor	Approx Ship Weight	Price
161256	PROG40S36NRU67PV	NG	40	36,000	62-1/2"	21-3/4"	-	0.67	155 lbs	
161258	PROG40S32PRU67PV	LP	40	32,000	62-1/2"	21-3/4"	-	0.67	155 lbs	
161261	PROG50S36NRU67PV	NG	50	36,000	62-1/2"	23-3/4"	-	0.67	175 lbs	
161262	PROG50S32PRU67PV	LP	50	32,000	62-1/2"	23-3/4"	-	0.67	175 lbs	

Heavy-Duty Tall

Part #	Mfg #	Type Gas	Gal Cap	Gas Input BTUH	Height to Top of Assembly	Jacket Diameter	Vent Size	Energy Factor	Approx Ship Weight	Price
173848	PRO+G7576NRUPV	NG	75	75,000	72"	26-1/4"	-	0.57	330 lbs	
173849	PRO+G7576PRUPV	LP	75	69,000	72"	26-1/4"	-	0.57	330 lbs	

Water Heaters



Residential Gas Water Heaters

Pacemaker® Gas Water Heaters

Pacemaker® Gas Water Heater with Guardian System™

6-Year Limited Tank and Parts Warranty with Professional Installation

- Guardian System™ - air/fuel shut-off system offers double protection and no filter maintenance free
- Low NOx design for low nitrous oxide emissions
- EverKleen™ patented self-cleaning system
- Easy to light - no matches required
- High altitude compliant
- Energy efficient
- Patented magnesium anode rod design
- All models certified for applications up to 6,000 feet above sea level
- Brass drain valve
- Meets or exceeds National Appliance Energy Conservation Act (NAECA) requirements

T&P Valve included



Tall

Part #	Mfg #	Type Gas	Gal Cap	Gas Input BTUH	Height to Top of Assembly	Jacket Diameter	Vent Size	Energy Factor	Approx Ship Weight	Price
173853	PROG2930PRU63	LP	29	30,000	59-3/4"	16-1/2"	3" or 4"	0.63	110 lbs	
173852	PROG2932NRU63	NG	29	32,000	59-3/4"	16-1/2"	3" or 4"	0.63	110 lbs	
173855	PROG4038NRU62	NG	40	38,000	61-3/4"	18-1/8"	3" or 4"	0.59	120 lbs	
176566	PROG4036PRU62	LP	40	34,000	61-1/2"	19-3/4"	3" or 4"	0.60	125 lbs	
180245	PROG4036NRU62	NG	40	36,000	61-1/2"	19"	3" or 4"	0.62	127 lbs	
185222	PROG5036PRU60	LP	50	36,000	61-1/4"	20-1/2"	3" or 4"	0.60	150 lbs	
173857	PROG5038NRU60	NG	50	38,000	61-1/2"	20-1/8"	3" or 4"	0.58	130 lbs	
173842	PROG5036PRU62	LP	50	36,000	61-1/2"	21-3/4"	3"	0.58	150 lbs	

Short

Part #	Mfg #	Type Gas	Gal Cap	Gas Input BTUH	Height to Top of Assembly	Jacket Diameter	Vent Size	Energy Factor	Approx Ship Weight	Price
173854	PROG30S30NRU63	NG	30	30,000	49-3/4"	19-3/4"	3"	0.61	98 lbs	
174562	PROG40S38NRU62	NG	40	40,000	53-7/8"	20-1/8"	3" or 4"	0.59	130 lbs	
161296	PROG40S36PRU62	LP	40	36,000	53-7/8"	20-1/8"	3" or 4"	0.59	130 lbs	
173844	PROG50S36PRU61	LP	50	40,000	54-1/4"	23-3/4"	3" or 4"	0.61	186 lbs	
173843	PROG50S40NRU61	NG	50	40,000	54-1/4"	22-1/4"	3"	0.59	158 lbs	

Water Heaters



Residential Gas Water Heaters

Pacemaker® Heavy-Duty Gas Water Heater with Guardian System™

6-Year Limited Tank and Parts Warranty with Professional Installation

- Guardian System™ - air/fuel shut-off system offers double protection and no filter maintenance free
- Low NOx design for low nitrous oxide emissions
- EverKleen™ patented self-cleaning system
- Easy to light - no matches required
- Energy efficient
- Patented magnesium anode rod design
- All models certified for applications up to 7,700 feet above sea level
- Brass drain valve
- Meets or exceeds National Appliance Energy Conservation Act (NAECA) requirements

T&P Valve included



Tall

Part #	Mfg #	Type Gas	Gal Cap	Gas Input BTUH	Height to Top of Assembly	Jacket Diameter	Vent Size	Energy Factor	Approx Ship Weight	Price
173845	PRO+G7576NRU	NG	75	75,100	64"	26-1/4"	4"	-	320 lbs	
182860	PRO+G7576PRU	LP	75	65,000	64"	26-1/4"	4"	0.53	320 lbs	

Professional™ Gas Water Heaters

Professional™ Achiever Plus™ Gas Water Heater with Guardian System™

8-Year Limited Tank and Parts Warranty with Professional Installation

- Guardian System™ - air/fuel shut-off system offers double protection and no filter maintenance free
- Low NOx design for low nitrous oxide emissions
- EverKleen™ patented self-cleaning system
- Easy to light - no matches required
- High altitude compliant
- Energy efficient
- Patented magnesium anode rod design
- Brass drain valve and temperature and pressure relief valve included
- Meets or exceeds National Appliance Energy Conservation Act (NAECA) requirements

T&P Valve Included



Tall

Part #	Mfg #	Type Gas	Gal Cap	Gas Input BTUH	Height to Top of Assembly	Jacket Diameter	Vent Size	Energy Factor	Approx Ship Weight	Price
166949	PRO+G4040NRU62	NG	40	40,000	63-1/4"	21"	3"	0.62	135 lbs	
166950	PRO+G4036PRU62	LP	40	34,000	63-1/4"	21"	3"	0.62	135 lbs	
177076	PRO+G4860NRU60	NG	48	60,000	61-3/4"	21-3/4"	4"	0.60	150 lbs	

Water Heaters

www.plumbsupply.com • Serving our Customers Since 1946 • www.waterconcepts.net



Residential Gas Water Heaters

Professional™ Gas Water Heaters (Continued)

Professional™ Achiever Plus™ Gas Water Heater with Guardian System™

Tall

Part #	Mfg #	Type Gas	Gal Cap	Gas Input BTUH	Height to Top of Assembly	Jacket Diameter	Vent Size	Energy Factor	Approx Ship Weight	Price
166951	PRO+G5036PRU62	LP	50	36,000	62-1/4"	23"	3"	0.62	165 lbs	
166965	PRO+G5040NRU62	NG	50	40,000	62-1/4"	23"	3"	0.62	165 lbs	
176121	PRO+G5550NRU59	NG	55	50,000	59-1/8"	23-3/4"	3" or 4"	0.59	175 lbs	

Short

Part #	Mfg #	Type Gas	Gal Cap	Gas Input BTUH	Height to Top of Assembly	Jacket Diameter	Vent Size	Energy Factor	Approx Ship Weight	Price
171816	PRO+G40S40NRU62	NG	40	40,000	53-7/8"	23"	3"	0.62	135 lbs	

Professional Achiever™ Atmospheric Water Heater with Gaurdian System

- Professional Classic Plus™ Atmospheric gas water heaters are engineered for more hot water at a low operating cost
- .59 - .62 EF
- More hot water at a low operating cost
- FHR: 54 - 90 gallons
- Recovery: 30.3 to 40.4 GPH at a 90° F rise, depending on model
- Guardian System™ & Sensor
- Exclusive air/fuel shut-off device
- Maintenance free – no filter to clean
- Protective control system that disables the heater in the presence of flammable vapor accumulation
- Eco-friendly burner, low NOx design
- Easy to light – no matches required EverKleen™ patented system fights sediment build-up
- Enhanced flow brass drain valve
- Temperature and pressure relief valve included
- Low lead compliant



Tall

Part #	Mfg #	Type Gas	Gal Cap	Gas Input BTUH	Height to Top of Assembly	Jacket Diameter	Vent Size	Energy Factor	Approx Ship Weight	Price
216796	PROG40-32P RU62	LP	50	32,000	61-1/2"	18-1/2"	3" or 4"	.62	125 lbs	

Water Heaters



Residential Gas Water Heaters

Professional™ Ultra Series: High Efficiency Condensing Power Direct Vent

- .82 EF
- Low NOx design
- Use 2 or 3 inch diameter PVC, ABS, or CPVC vent pipe options
- FVIR compliant protective
- Power direct vents are an ideal choice when either indoor air quality or negative air pressure are concerns
- Two-pipe system: one pipe pulls in outside air for combustion and the other exhausts combustion gases
- 120 VAC, 60Hz, induced draft blower
- New whisper quiet blower



Short

Part #	Mfg #	Type Gas	Gal Cap	Gas Input BTUH	Height to Top of Assembly	Jacket Diameter	Vent Size	Energy Factor	Approx Ship Weight	Price
157608	PHE40S	NG	38	40,000	60-3/8"	22-1/8"	2" or 3"	0.82	220 lbs	
157610	PHE40SP	LP	38	36,000	60-3/8"	22-1/8"	2" or 3"	.82	220 lbs	

Tall

Part #	Mfg #	Type Gas	Gal Cap	Gas Input BTUH	Height to Top of Assembly	Jacket Diameter	Vent Size	Energy Factor	Approx Ship Weight	Price
157611	PHE50	NG	48	40,000	68-3/4"	22-1/8"	2" or 3"	0.82	250 lbs	
157612	PHE50P	LP	48	36,000	68-3/4"	22-1/8"	2" or 3"	.82	250 lbs	

Professional™ Achiever™ Power Direct Vent Gas Water Heater

- Electronic gas control for improved monitoring and service
- Eco-friendly burner, low NOx design
- Two pipe system: one pipe pulls in outside air for combustion and the other exhausts combustion gases
- 120 VAC powered blower
- New whisper quiet blower
- 6-Year limited tank and parts warranty*
- Temperature and pressure relief valve included



Tall

Part #	Mfg #	Type Gas	Gal Cap	Gas Input BTUH	Height to Top of Assembly	Jacket Diameter	Vent Size	Energy Factor	Approx Ship Weight	Price
161232	PROG4040NRU67PDV	NG	40	40,000	68-1/2"	19-3/4"	3" or 4"	.67	180 lbs	

Water Heaters



Residential Gas Water Heaters

Professional™ Powered Damper Water Heater with Guardian System™ 8-Year Limited Tank and Parts Warranty with Professional Installation

- Guardian System™ - air/fuel shut-off system offers double protection and no filter maintenance free
- Low NOx design for low nitrous oxide emissions
- Maintenance free - no filter to clean
- Easy to light - no matches required
- High altitude compliant
- Meets or exceeds Energy Star® Phase II certification
- Patented magnesium anode rod design
- Brass drain valve
- Meets or exceeds National Appliance Energy Conservation Act (NAECA) requirements

T&P Valve Included



Tall

Part #	Mfg #	Type Gas	Gal Cap	Gas Input BTUH	Height to Top of Assembly	Jacket Diameter	Vent Size	Energy Factor	Approx Ship Weight	Price
161301	PRO+G3836PRU69PD	LP	38	36,000	62-3/4"	19-3/4"	3" or 4"	0.69	140 lbs	
161300	PRO+G3840NRU69PD	NG	38	40,000	62-3/4"	19-3/4"	3" or 4"	0.69	140 lbs	
161302	PRO+G5040NRU67PD	NG	50	40,000	63"	21-3/4"	3" or 4"	0.67	160 lbs	

Short

Part #	Mfg #	Type Gas	Gal Cap	Gas Input BTUH	Height to Top of Assembly	Jacket Diameter	Vent Size	Energy Factor	Approx Ship Weight	Price
172525	PRO+G40S40NRU67PD	NG	40	40,000	55-1/2"	21-3/4"	3" or 4"	0.67	140 lbs	
180335	PRO+G50S40NRU67P	NG	50	40,000	55-1/2"	23-3/4"	3" or 4"	0.67	160 lbs	

Water Heaters



Residential Gas Water Heaters

Warrior Gas Series Water Heaters

Warrior Gas Water Heater for Manufactured Housing with Guardian System™ - Tall

5-Year Limited Tank Warranty and 1-Year Limited Parts Warranty

- Guardian System™ - air/fuel shut-off system offers double protection
- Maintenance free - no filter to clean
- Low NOx design for low nitrous oxide emissions
- Side inlet temperature and pressure relief valve opening
- Two-hole top for anode rod and hot water outlet
- Ruudglas® tank lining resists corrosion and prolongs tank life
- Patented R-Foam® insulation process for superior heat retention
- Piezo Igniter - easy light pilot
- Cold water inlet - side connection allows for quick, economical hook-up

T&P Valve Installed



Part #	Mfg #	Type Gas	Gal Cap	Gas Input BTUH	Height to Top of Assembly	Jacket Diameter	Vent Size	Energy Factor	Approx Ship Weight	Price
173878	PROG3032NRH63MH	NG	30	32,000	56-3/8"	16-1/8"	3"	0.61	100 lbs	
173877	PROG4034NRH62MH	NG	40	34,000	61-3/4"	18-1/8"	3"	0.59	120 lbs	

Warrior DV Direct Vent Gas Water Heater for Manufactured Housing - Tall

5-Year Limited Tank Warranty and 1-Year Limited Parts Warranty

- No external vented door is required
- All combustion air comes from outside the home
- Hot water outlet located at top
- Field convertible controls for natural gas or LP operation
- Ruudglas® tank lining resists corrosion and prolongs tank life
- Piezo Igniter - easy light pilot
- Cold water inlet - side connection allows for quick, economical hook-up
- Meets or exceeds National Appliance Energy Conservation Act (NAECA) requirements

T&P Valve Installed



Part #	Mfg #	Type Gas	Gal Cap	Gas Input BTUH	Height to Top of Assembly	Jacket Diameter	Vent Size	Energy Factor	Approx Ship Weight	Price
173875	PROG3030NRH63MH	NG	30	30,000	57"	17-3/4"	3"	0.61	110 lbs	
173876	PROG4030NRH62MH	NG	40	30,000	57-1/2"	19-3/4"	3"	0.59	125 lbs	

Water Heaters



Residential Gas Water Heaters

XR90 Compact Gas Water Heater 6-Year Limited Tank and Parts Warranty

- Compact, high BTUH and draft induced
- 29 Gallon water heater outperforms standard 50 gallon models
- Energy efficient/low emissions
- Dual certified for both potable water and space heating



Part #	Mfg #	Type Gas	Gal Cap	Gas Input BTUH	Height to Top of Assembly	Jacket Dia	Vent Size	Energy Factor	Approx Ship Weight	Price
161297	PRO+G2960NRU70ID	NG	29	60,000	65-1/2"	17-3/4"	3" or 4"	0.70	136 lbs	



Tankless Water Heaters

Tankless Gas Water Heaters

84 Series Prestige™ Direct Vent Condensing Tankless Gas Water Heater

12-Year Limited Warranty on Heat Exchanger; 5-Year Limited Warranty on Parts; 1-Year on Labor

- 94% Energy efficient
- 2-Pipe direct vent system designed for PVC pipe
- Compact, continuous hot water
- Digital remote control and 10' of thermostat wire included
- EZ-Link™ cable connects two tankless units to operate as one
- Guardian OFW™ overheat film wrap
- Third-party efficiency listed by AHRI
- Intelligent electronic controls designed to increase energy efficiency and safety
- Self diagnostic program
- Digital display shows temperature setting and maintenance codes
- Built-in electric blower
- Indoor models supplied with a 120V power cord
- Temperature range: 85° to 185°F
- 3/4" Water and gas connections
- Indoor and outdoor models feature freeze protection to -30°F
- Exceeds Energy Star® requirements



Indoor

Part #	Mfg #	Type Gas	Gas Input BTUH	Dimensions H x W x D	Vent Diameter	Energy Factor	Approx Ship Weight	Price
139857	RUTGH-84DVN	NG	11,000 - 157,000	27-1/2" x 18-1/2" x 9-3/4"	3" PVC	.94	82 lbs	
139858	RUTGH-84DVP	LP	11,000 - 157,000	27-1/2" x 18-1/2" x 9-3/4"	3" PVC	.94	82 lbs	

Water Heaters



Tankless Water Heaters

95 Series Direct Vent Condensing Tankless Gas Water Heater

12-Year Limited Warranty on Heat Exchanger; 5-Year Limited Warranty on Parts; 1-Year on Labor

- 2-Pipe direct vent system designed for PVC pipe
- Compact, continuous hot water
- UMC-117 Remote control and 10' of thermostat wire included
- EZ-Link™ cable connects two tankless units to operate as one
- Guardian OFW™ overheat film wrap
- Third-party certified by GAMA
- Qualifies for federal energy tax credit
- Intelligent electronic controls designed to increase energy efficiency and safety
- Self diagnostic program
- Digital display shows temperature setting and maintenance codes
- Built-in electric blower
- Indoor models supplied with a 120V power cord
- Temperature range: 85° to 140°F
- 3/4" Water and gas connections
- Indoor and outdoor models feature freeze protection to -30°F



Indoor

Part #	Mfg #	Type Gas	Gas Input BTUH	Dimensions H x W x D	Vent Diameter	Energy Factor	Approx Ship Weight	Price
137358	RUTGH-95DVN	NG	11,000 - 199,900	27-1/2" x 18-1/2" x 9-3/4"	3" PVC	.94	82 lbs	
137703	RUTGH-95DVP	LP	11,000 - 199,900	27-1/2" x 18-1/2" x 9-3/4"	3" PVC	.94	82 lbs	



Tankless Water Heaters

Ruud Indoor Direct Vent Tankless Gas Water Heater 10-Year Residential Limited Warranty on Heat Exchanger 3-Year Residential Limited Warranty on Parts

- Includes UMC-117 remote control
- EZ-Link™ cable connects two tankless units
- Guardian SBT™ sensing burner technology
- Guardian OFW™ overhead film wrap
- Optional high-altitude options with altitude chip sold separately
- Certified by GAMA
- Qualifies for up to a \$300 federal energy tax credit
- Can be linked in up to 20 unit manifold installations using optional
- MIC-180 and MICS-180 Manifold control assemblies
- Energy saving design
- Intelligent electronic controls
- Self-diagnostic program
- Digital display shows temperature setting and maintenance codes
- Built-in electric blower
- Uses Category III stainless steel vents, vents vertically or horizontally
- 120V Power cord
- Environmentally friendly Low NOx burner



Tankless Water Heaters for Two - Three Bathroom Homes

Part #	Mfg #	Type Gas	Gas Input BTUH	Dimensions H x W x D	Vent Diameter	Energy Factor	Approx Ship Weight	Price
131496	RUTG-84DVN	Indoor NG	11,000 - 180,000	25-5/8" x 13-7/8" x 9-7/8"	3" by 5"	.82	54 lbs	

Water Heaters

Tankless Water Heaters

Tankless Water Heaters

- Made in USA
- Easy to install-no T&P valve needed unless required by local codes
- 1-Year warranty on field serviceable cartridge element
- 5-Year full factory warranty against failure due to leaks

"Single Point" Code Compliant Tankless Electric Handwashing Heater

- 99% Efficient, flow switch activates heater on demand
- Replaceable cartridge insert
- Faucet aerator with flow restrictor supplied
- Mounts on wall under tank
- Single cold water supply, 3/8" Comp pipe fitting at top of unit
- Ni Chrome element



Part #	Mfg #	Volts	kW	Amps	Dimensions	Price
004189	SP3512	120V	3.5kW	29.0A	10.75" x 5.25" x 2.875"	

Tankless Water Heaters

Ultra Series Tankless Condensing Water Heaters

12-Year heat exchanger limited warranty for residential installations
5-Years on Parts, 1-Year on Labor

- (2) Heat exchangers
- Energy Star® rated
- Integrated condensate collector
- Integrated MC-91-1 digital controller with error code indicator
- Temperature range
 - Residential: 98° - 120°F
 - Commercial: 98° - 185°F



Indoor

Part #	Mfg #	Description	Input MBTUH	Gas Type	Max GPM	Dimensions (H x W x D)	Wt	Price
148133	RU98i-N	Residential	15.2 - 199	NG	9.8	25.7" x 18.3" x 10.1"	70.5 lbs	
148134	RU98i-P	Residential	15.2 - 199	LP	9.8	25.7" x 18.3" x 10.1"	70.5 lbs	

Luxury Series Continuous Flow Tankless Water Heaters

12-Year heat exchanger limited warranty for residential installations
5-Years on Parts, 1-Year on Labor

- (2) Heat exchangers
- Energy Star® rated
- Integrated condensate collector
- Integrated MCC-91-2 digital controller
- Temperature range
 - Residential: 98° - 120°F
 - Commercial: 98° - 160°F



- Indoor -

Part #	Mfg #	Description	Input MBTUH	Gas Type	Max GPM	Dimensions (H x W x D)	Wt	Price
141090	RL75i-N	Residential/Commercial	10.3 - 180	NG	7.5	22-3/4" x 14" x 9-1/2"	50 lbs	
140712	RL75i-P	Residential/Commercial	10.3 - 180	LP	7.5	22-3/4" x 14" x 9-1/2"	50 lbs	
141091	RL94i-N	Residential/Commercial	10.3 - 199	NG	9.8	22-3/4" x 14" x 9-1/2"	50 lbs	
140713	RL94i-P	Residential/Commercial	10.3 - 199	LP	9.8	22-3/4" x 14" x 9-1/2"	50 lbs	

Water Heaters

Tankless Water Heaters

Tankless Water Heater Accessories
Controller

• For LS series heaters

Part #	Mfg #	Description	Price
147191	MCC-91-2W	Commercial Remote Temperature Controller, For LS >140°F	

Termination Kit

• For LS series heaters

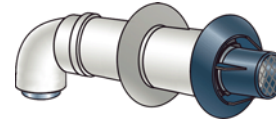

Part #	Mfg #	Description	Price
108229	STDKITVA-A	All Weather Termination Kit - 12"	
137064	223182	21" Universal Non-Condensing Horizontal All Weather Term Kit	
126725	223176-PP	12" Condensing Termination Kit	
126726	223177-PP	Condensing Termination Kit	
105473	FSDVWMT04LH	Wall-Mount Concentric Termination Kit for RC98 & R98LS	
108230	224046	Raised Horizontal Termination Kit (Snorkel)	

Venting Components

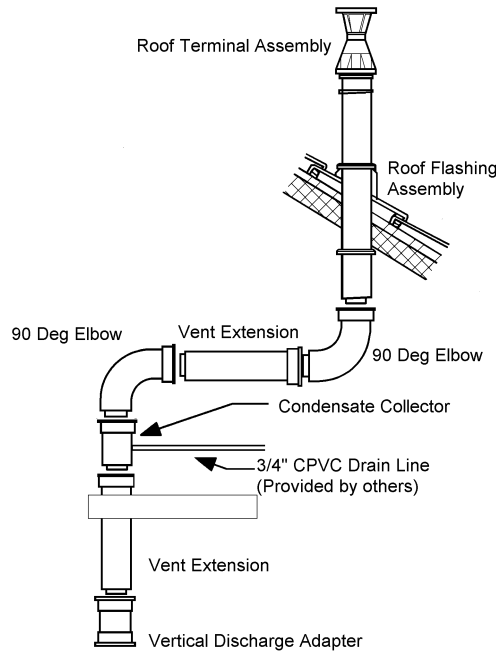
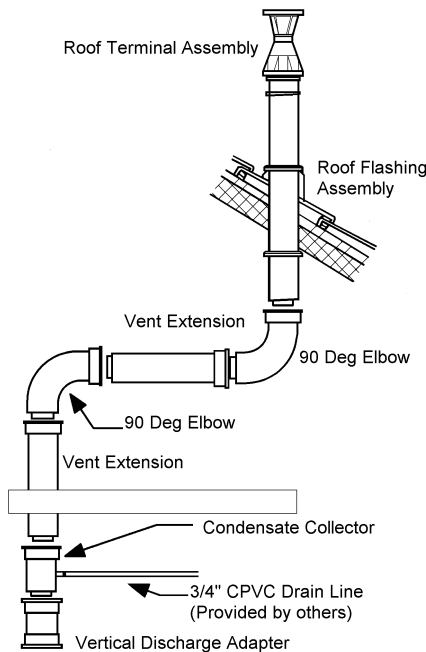

Part #	Mfg #	Description	Price
065658	146141	Roof Flashing Assy (Flat Roof)	
115331	189950	Polymer Roof Flashing 1/12 to 6/12 Pitch or 5° to 25°	
115332	189951	Polymer Roof Flashing 6/12 to 12/12 Pitch or 25° to 45°	
126724	184162-PP	Roof Condensing Discharge Terminal Short	
065655	224069	Condensate Collector	
130233	222053	Condensate Trap	
126728	224078PP	Condensing 90° Vent Pipe	

Water Heaters

Tankless Water Heaters

Venting Components (Continued)

Part #	Mfg #	Description	Price
106310	224042	Universal Bug Guard	
126732	224047-PP	Raised Horizontal Kit	
114113	A-H-66-398X-01	Electrode Packing	

Extension

Part #	Mfg #	Description	Price
065649	224051	10" Vent Extension 2532	
065650	224052	19.5" Vent Pipe Extension 2402	
065651	224053	39" Vent Pipe Extension	
126730	224079PP	Condensing 19.5" Vent Pipe Extension	
126731	224080PP	Condensing 39" Vent Pipe Extension	
126729	224087PP	Condensing 10" Vent Pipe Extension	

Elbow

Part #	Mfg #	Description	Price
065653	224063	90° Vent Pipe Elbow 2532	

Terminal

Part #	Mfg #	Description	Price
065657	184118S	45" Standard Roof Discharge Terminal	
093342	184119	38" Roof Discharge Terminal	

Tankless Water Heaters

Gas Tankless Water Heaters

Premium Condensing Tankless Gas Water Heater (NPE-A)

- 1/2" Gas pipe capable up to 24"
- Field convertible gas system
- Ultra condensing efficiency
- Dual stainless steel heat exchangers
- Low NOx emissions
- SCH 40, 2" venting up to 60'
- Cascading capable

ComfortFlow Technology



Part #	Mfg #	Gas	Gas Supply Pressure Min - Max	Heat Capacity Input (BTUH) Min - Max	CAFUE	Dimensions H x W x D	Ship Wt	Price
152650	NPE-180A	NG/LP	3.5"-10.5"wc	15,000-150,000	-	27.4" x 17.3" x 13.2"	75 lbs	
152651	NPE-210A	NG/LP	3.5"-10.5"wc	19,900-180,000	-	27.4" x 17.3" x 13.2"	82 lbs	
152652	NPE-240A	NG/NP	3.5"-10.5"wc	19,900-199,900	-	27.4" x 17.3" x 13.2"	82 lbs	

Premium Condensing Tankless Gas Water Heater (NPE-S)

- 1/2" Gas pipe capable up to 24'
- Field convertible gas system
- Ultra condensing efficiency .99EF
- Dual stainless steel heat exchangers
- Low NOx emissions (= 20ppm)
- SCH 40, 2" venting up to 60'
- Cascading capable



Part #	Mfg #	Gas	Gas Supply Pressure Min - Max	Heat Capacity Input (BTUH) Min - Max	CAFUE	Dimensions H x W x D	Ship Wt	Price
181351	NPE-150S	NG/LP	3.5"-10.5"wc	18,000-120,000	-	27.4" x 17.3" x 13.2"	55 lbs	
176901	NPE-240S	NG/LP	3.5"-10.5"wc	19,900-199,900	-	27.4" x 17.3" x 13.2"	75 lbs	

Water Heaters



Tankless Water Heaters

Cleaners & Degreasers

Calci-Free™ Tankless Water Heater Flush

- *Cleans heater coils thoroughly*
- *Biodegradable cleaner contains organic, inorganic, and corrosion inhibiting ingredients*
- *Removes calcium and other solid deposits from heating coils*



Part #	Mfg #	Size	Price
124755	68708	1.2 lbs	

Water Heaters

Water Heater Accessories

Direct Connect™ Thermostatic Mixing Valves
AMX300 DirectConnect™ Thermostatic Mixing Valve Kit

- Patented DirectConnect design
- Kit includes:
 - Mixing valve
 - Cold water tee
 - Flexible 8" or 11" metal connectors
 - Thermostrip
- Easy installation on water heaters
- Added safety designed to prevent scalding
- ASSE 1017 approved for point of source/whole house protection
- Teflon® coating extends service life
- Integrated recirculation and hot water ports



Part #	Mfg #	Tank Connection	System Connection	Flow GPM Min - Max	Notes	Price
188973	AMX300TLF/U	3/4" FNPT	3/4" MNPT	0.25 - 19	8" Flex Connector	
131426	AMX302T	3/4" FNPT	3/4" MNPT	0.25 - 19	11" Flex Connector	
131427	AMX300	3/4" FNPT	3/4" MNPT	0.25 - 19	Valve for Repl Only	

AMX Series DirectConnect™ Thermostatic Mixing Valve

- Patented DirectConnect design
- Orientation of cold and hot ports typically eliminate need for elbows and tees
- Added safety designed to prevent scalding
- Constant water temperature
- Proportional valve
- Designed to be directly installed on water heater hot outlet port
- Integral check valve on cold port
- Brass/stainless construction
- Teflon® coated wear surfaces



Part #	Mfg #	Pipe Size	Connection	Operating Temperature	Price
094298	AMX101-US-1	3/4"	Union Sweat	90° - 130°F	
094299	AMX102-US-1	1"	Union Sweat	90° - 130°F	

Water Heaters

Water Heater Accessories

Water Heater Connectors

PowerPEX® ASTM F1807 PEX x FIP—Swivel Straight

- Full flow, dielectric fitting – no restriction
- Brass FIP swivel nut includes gasket
- Fitting with 600 WOG full port ball valve available
- 3/4" FIP branch for 2 gallon expansion tank

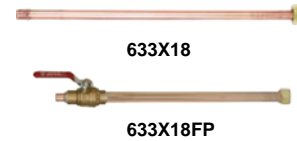

Standard

Part #	Mfg #	PEX x FIP Swivel	Length	Material	Ball Valve	Lead Free Solder Joint	Price
119820	633-X18	3/4" x 3/4"	18"	Type L Copper Tube	No	Yes	

Valved

Part #	Mfg #	PEX x FIP Swivel	Length	Material	Ball Valve	Lead Free Solder Joint	Price
119821	633-X18FP	3/4" x 3/4"	18"	Type L Copper Tube	Yes	Yes	
149089	634X418FP	3/4" x 1"	18"	Type L Copper Tube	Yes	No	

Sweat Water Heater Connector—FIP x FIP Swivel Flex Fitting or FIP x FSwt Flex Fitting

- Flexible copper fitting provides easy connection
- Brass FIP swivel nut includes gasket



Part #	Mfg#	Connection	Length	Price
183729	634-115	3/4" FIP Swivel x 3/4" FIP Swivel	15"	
183730	634-318	3/4" FIP Swivel x 3/4" FSWT	18"	

PowerPEX® ASTM F1960 Lead-Free—FIP Swivel Flex

- Brass FIP swivel nut includes gasket
- Fitting with 600 WOG full port ball valve available
- Flexible dielectric fitting works well in tight spaces
- Lead-free solder joint



Part #	Mfg#	Connection	Length	Price
183731	634WG418	3/4" F1960 x 3/4" FIP Swivel	18"	

Bands for Expansion Tank Support Kitchen Installations

- Fast, easy, and affordable
- 16 Gauge galvanized bracket, made in the USA
- All stainless steel band, housing and screw



Part #	Mfg#	Band	Diameter	Tank	Price
162391	598-0210	3.25"	10"	2-Gallons	
162392	598-0213	45"	13"	5-Gallons	

No Lead Water Heater Stub-Out Loop

- Preformed copper loop bypasses water heater before test



Part #	Mfg #	Description	Material	Price
183732	636-L3888	3/4" Male Sweat	Type L Copper Tube	

Water Fountains & Coolers

EZH2O™ System

Hand-Free® Enhanced Cooler/Bottle Filling Station

- Space saving design
- No-touch, sensor activation with automatic 20-second shut-off timer (bottle filler)
- Easy-touch front and side pushbar controls (cooler)
- WaterSentry® Plus™ 3000 gallon filtration system
- Flexi-guard® bubbler
- Silver-Ion anti-microbial protection
- Laminar flow provides minimal splash
- Real drain system eliminates standing water
- Visual interface display on bottle filler
 - Innovative Green Ticker™ counts bottles saved from waste
 - LED visual filter monitor shows when replacement is necessary
- Quick fill rate: 1.1 gpm (refrigerated models);
 - 1.5 gpm (non-refrigerated models)



Water Fountains & Coolers

Part #	Mfg #	Flow Rate	Rated	Full Load	Ship Wt	Description	Price
177746	LZS8WSLP	8.0 gph	115V	6A	87 lbs	Light Gray Granite, Filtered	

Hands-Free® Cooler/Bottle Filling Station with EZ Cooler

- Space saving design
- No-touch, sensor activation with automatic 20-second shut-off timer (bottle filler)
- Easy-touch front and side pushbar controls (cooler)
- Optional WaterSentry® Plus™ 3000 gallon filter
- Flexi-guard® bubbler, optional vandal-resistant bubbler available (VR)
- Silver-Ion anti-microbial protection
- Easy-to-install universal design
- Laminar flow provides minimal splash
- Real drain system eliminates standing water
- Visual interface display includes:
 - Innovative Green Ticker™
 - Filter monitor indicating when replacement is necessary
- Quick fill rate: 1.1 gpm
 - 1.5 gpm non-refrigerated models



Part #	Mfg #	Flow Rate	Rated	Full Load	Ship Wt	Description	Price
146628	EZS8WSLK	8.0 gph	115V	5A	68 lbs	Light Gray Granite, Non-Filtered	
153726	EZS8WSVRLK	8.0 gph	115V	5A	68 lbs	Light Gray Granite, Non-Filtered	
170533	LZSDWSLK	Non-Refrigerated	115V	1A	45 lbs	Light Gray Granite, Filtered	
176546	LZS8WSL2K	6.7 gph	220V	2.5A	71 lbs	Light Gray Granite, Filtered	
138622	LZS8WSSK	8.0 gph	115V	5A	71 lbs	Stainless Steel, Filtered	

Water Fountains & Coolers

Hands-Free® EZH2O® Bottle Filling Station with GreenSpec® EZ Cooler

- High efficiency refrigeration system over average market performance
- No-touch, sensor activation with automatic 20-second shut-off timer (bottle filler)
- Flexi-guard® StreamSaver™ water efficient bubbler
- Optional WaterSentry® Plus™ 3000 gallon filter
- Easy-touch front and side pushbar controls (cooler)
- Silver-ion anti-microbial protection
- Easy-to-install universal design
- Laminar flow provides minimal splash
- Real drain system eliminates standing water
- Visual interface display includes:
 - Innovative Green Ticker™
 - Filter monitor indicating when replacement is necessary
- Quick fill rate: 1.1 gpm
 - 1.5 gpm non-refrigerated models
- Rated for indoor service



Water Fountains & Coolers

Part #	Mfg #	Flow Rate	Rated	Full Load	Ship Wt	Description	Price
165132	LZSG8WSLK	8.0 gph	115V	4.2A	71 lbs	Light Gray Granite, Filtered	

Enhanced Cooler/Bottle Filling Station with Bi-Level Versatile Cooler

- Space saving design
- No-touch, sensor activation with automatic 20-second shut-off timer (bottle filler)
- Easy-touch front and side pushbar controls (cooler)
- WaterSentry® Plus 3000 gallon filtration system, certified to NSF/ANSI 42 & 53
 - (Lead, class 1 particulate, chlorine, taste & odor)
- Flexi-guard® bubbler
- Silver-ion anti-microbial protection
- Laminar flow provides minimal splash
- Real drain system eliminates standing water
- Visual interface display on bottle filler
 - Innovative Green Ticker™
 - LED visual filter monitor shows when replacement is necessary
 - Automatic filter status with each filter change
- Quick fill rate: 1.1 gpm (refrigerated models);
 - 1.5 gpm (non-refrigerated models)



Part #	Mfg #	Flow Rate	Rated	Full Load	Ship Wt	Description	Price
183386	LZSTL8WSLP	8.0 gph	115V	4.2A	98 lbs	Light Gray Granite, Filtered	
177160	LZSTL8WSSP	8.0 gph	115V	4.2A	98 lbs	Stainless Steel, Filtered	

Water Fountains & Coolers

Water Fountains & Coolers

Swirflo® EZH2O® Bottle Filler Fountain with Integral Cooler

- Touchless, sensor-activation (bottle filler); easy-to-operate push button activation (fountain)
- Automatic 20-second shut-off timer
- Flexi-Guard® Safety bubblers
- Visual user interface includes:
 - Innovative Green Ticker™
 - Filter monitor indicating when replacement is necessary
- Swirflo™ GRN features the Strea mSaver bubbler and high-efficiency water chiller
 - Chiller operates over 55% more energy than market average performance
- Laminar flow provides minimal splash
- Real drain eliminates standing water
- Rated for indoor service
- Mounting frame included
- Quick fill rate: 1.1 gpm (refrigerated models);
 - 1.5 gpm (non-refrigerated models)



Part #	Mfg #	Flow Rate	Rated	Full Load	Ship Wt	Description	Price
173900	EZWSDFPBM1 17	Non-Refrigerated	115V	1A	118 lbs	Stainless Steel, Non-Filtered	
174530	EZWSERPBM28 K	8.0 gph	115V	5A	170 lbs	Stainless Steel, Filtered	

In-Wall Recessed EZH2O Bottle Filling Station

- Stainless steel construction
- Special panel height designed to pair with non-refrigerated (EDFPBM) Swirflo® models
- Sanitary, touchless, sensor activation with automatic 20-second shut-off timer (bottle filler)
- WaterSentry® Plus 3000-gallon capacity Filtration System
- Silver ion anti-microbial protection
- Visual user interface display includes:
 - Innovative Green ticker™ counts the quantity of 16 ounce bottles saved
 - LED visual filter monitor shows when replacement is necessary
- Includes mounting frame and lower hinged panel for easy access and servicing
 - Pre order mounting (MFWS100) for model (LZWSDK only)
- Quick fill rate: 1.1 gpm (refrigerated models);
 - 1.5 gpm (non-refrigerated models)



LZWSM8K



LZWSDK

Part #	Mfg #	Flow Rate	Rated	Full Load	Ship Wt	Description	Price
187409	LZWSDK	Non-Refrigerated	115V	1A	33 lbs	Stainless Steel, Filtered	
132214	LZWSM8K	8.0 gph	115V	5A	80 lbs	Light Gray Granite, Filtered	

Water Fountains & Coolers

In-Wall Recessed EZH2O Filtered Bottle Filling Station with Green Chiller

- High-efficiency ECH8GRN chilling unit
- Stainless steel construction
- Sanitary, touchless, sensor activation with automatic 20-second shut-off timer (bottle filler)
- WaterSentry® Plus 3000-gallon capacity Filtration System, certified to NSF/ANSI 42 & 53 (Lead, Class 1 Particulate, Chlorine, Taste & Odor)
- Silver ion anti-microbial protection
- Visual user interface display includes:
 - Innovative Green ticker™ counts the quantity of 16 ounce bottles saved
 - LED visual filter monitor shows when replacement is necessary
- Includes mounting frame and lower hinged panel for easy access and servicing
- Quick fill rate: 1.1 gpm (refrigerated models);
—1.5 gpm (non-refrigerated models)



Water Fountains & Coolers

Part #	Mfg #	Flow Rate	Rated	Full Load	Ship Wt	Description	Price
178406	LZWSSGRN8K	8.0 gph	115V	4.5A	80 lbs	Stainless Steel, Filtered	

In-Wall Recessed EZH2O® Bottle Filling Station for Pairing with Swirlfo® EDFPB Fountains

- Ideal for education, healthcare facilities, fitness clubs, and hospitality
- Stainless steel construction
- Sanitary, touchless, sensor activation with automatic 20-second shut-off timer (bottle filler)
- Hinged door for easy servicing
- Optional WaterSentry® Plus™ 3000 gallon Filtration System
- Silver ion anti-microbial protection
- Visual user interface display includes:
 - Innovative Green ticker™ counts the quantity of 16 ounce bottles saved
 - LED visual filter monitor shows when replacement is necessary
- Includes mounting frame and lower hinged panel for easy access and servicing
- Quick fill rate: 1.1 gpm (refrigerated models);
—1.5 gpm (non-refrigerated models)
- Rated for indoor service



Part #	Mfg #	Flow Rate	Rated	Full Load	Ship Wt	Description	Price
158450	EZWSSM8PK	8.0 gph	115V	5A	77 lbs	Stainless Steel, Non-Filtered	

Water Fountains & Coolers

Water Fountains & Coolers

In-Wall Recessed EZH2O® Bottle Filling Station with Swirlflo® Green Bi-Level Fountains

- Ideal for hospitality, healthcare facilities and office complexes
- Paired with choice of SwirlFlo® Green or SoftSides® refrigerated fountain
- High-efficiency ECH8GRN chilling unit
- Stainless steel construction
- Sanitary, touchless, sensor activation with automatic 20-second shut-off timer (bottle filler)
- WaterSentry® Plus™ 3000-gallon capacity Filtration System
- Laminar flow provides minimal splash while real drain system eliminates standing water
- Silver ion anti-microbial protection
- SwirlFlo® Green features Flexi-Guard StreamSaver™ bubbler and high-efficiency water chiller — Chiller operates over 55% more energy efficient than market average performance
- Visual user interface display includes:
 - Innovative Green ticker™ counts the quantity of bottles saved from waste
 - LED visual filter monitor shows when replacement is necessary
- Includes mounting frame and lower hinged panel for easy access and servicing
- Rated for indoor service
- Quick fill rate: 1.1 gpm (refrigerated models); —1.5 gpm (non-refrigerated models)



Part #	Mfg #	Flow Rate	Rated	Full Load	Ship Wt	Description	Price
176713	LZWSSFGRN28 K	8.0 gph	115V	4.5A	164 lbs	Stainless Steel, Filtered	

EZH2O® Bottle Filling Station with Retrofit Swirlflo® Drining Fountain

- Touchless, sensor activation with automatic 20-second shut-off timer (bottle filler)
- Stainless steel construction
- WaterSentry® Plus™ 3000-gallon capacity Filtration System
- Bottle filler meets ADA guidelines for each range
- Fountain meets ADA guidelines for wheelchair access
- Ships with new panel, frame, and integral EZH2O® station
- Designed to retrofit existing refrigerated bi-level pushbutton activated installation models
 - SwirlFlo®
 - SoftSides®
- Reuses existing fountains and chillers, as applicable
- Laminar flow provides minimal splash while real drain system eliminates standing water
- Integrated silver ion anti-microbial protection
- Visual user interface display includes:
 - Innovative Green ticker™ counts the quantity of bottles saved from waste
 - LED visual filter monitor shows when replacement is necessary
- Quick fill rate: 1.1 gpm (refrigerated models); —1.5 gpm (non-refrigerated models)
- Rated for indoor service



Part #	Mfg #	Flow Rate	Rated	Full Load	Ship Wt	Description	Price
171489	EZWSERP8RF	8.0 gph	115V	1A	50 lbs	Stainless Steel, Non-Filtered	

Water Fountains & Coolers

Non—Refrigerated Retro-Fit Kit Bottle Filling Station

- Attaches to most 115V/60Hz pushbar activated water coolers
- Space saving ADA-compliant design
- Touchless, sensor activation with automatic 20-second shut-off timer
- Silver-Ion anti-microbial protection
- Laminar flow provides minimal splash
- Real drain system eliminates standing water
- Visual user interface display includes:
 - Innovative green ticker™
 - Filter monitor indicating when replacement is necessary
- Rated for indoor service
- Quick fill rate of 1.1 gpm when connected to refrigerated EZ models; 1.5 gpm for non-refrigerated connections



Water Fountains & Coolers

Part #	Mfg #	Flow Rate	Rated	Full Load	Ship Wt	Description	Price
159404	EZWSRK	Non-Refrigerated	115V	1A	24 lbs	Stainless Steel, Non-Filtered	
132209	LZWSRK	Non-Refrigerated	115V	1A	19 lbs	Stainless Steel, Filtered	

Mechanical Surface Mount EZH2O® Non-Refrigerated Bottle Filling

- Ideal for facilities where electric wiring is not easily accessible or locations looking to reduce electrical usage
- Complete mechanical activation and function, no electrical connection required
- Installs onto a wall with robust hanging bracket
- Integrated silver ion Anti-microbial protection
- Optional AquaSentry® 500 gallon filter
- Optional battery powered visual interface display includes:
 - Innovative Green Ticker™
 - Filter monitor indicating when replacement is necessary
- Optional remote chiller can be installed within 15 feet of unit for chilled drinking water
- Laminar flow provides minimal splash while real drain system eliminates standing water
- Pushbutton activation
- Rated for indoor service
- Quick fill rate: 1.0 gpm



Part #	Mfg #	Flow Rate	Rated	Full Load	Ship Wt	Description	Price
176483	EMASM	Non-Refrigerated	N/A	N/A	20 lbs	Stainless Steel, Non-Filtered	

Water Fountains & Coolers

Water Fountains & Coolers

Retro-Fit Kit Non-Refrigerated Mechanically Activated Bottle Filling Station

- Mechanical-activation on water coolers is ideal for disaster-prone regions
—Operates during power disrutions
- Attaches to most 115V/60Hz EMABF pushbar activated models
- Retro-Fit design includes
—New basin and real drain system that eliminates standing water
- Touchless, sensor activation (bottle filler) with automatic 20-second shut-off timer
- Easy to operate pushbar activation (cooler)
- Silver-Ion anti-microbial protection
- Laminar flow provides minimal splash
- Visual user interface display includes:
—Innovative green ticker™
—Filter monitor indicating when replacement is necessary
- Rated for indoor service
- Quick fill rate of 1.1 gpm when connected to refrigerated EZ models;
1.5 gpm for non-refrigerated connections



Part #	Mfg #	Flow Rate	Rated	Full Load	Ship Wt	Description	Price
165729	EMABFWSRF	Non-Refrigerated	115V	15W	23 lbs	Stainless Steel, Non-Filtered	
190125	LMABFWSRF	Non-Refrigerated	115V	15W	23 lbs	Stainless Steel, Filtered	

Hands-Free® EZH2O® Bottle Filling Station with Mechanically Activated Cooler

- Mechanical-activation on water coolers is ideal for disaster-prone regions
—Operates during power disrutions
- Touchless, sensor activation (bottle filler) with automatic 20-second shut-off timer
- Easy to operate pushbar activation (cooler)
- WaterSentry® Plus 3000 gallon capacity filter
- Silver-Ion anti-microbial protection
- Flexi-Guard® safety bubbler
- Laminar flow provides minimal splash while
- Real drain system eliminates standing water
- Visual user interface display includes:
—Innovative green ticker™
—Filter monitor indicating when replacement is necessary
- Rated for indoor service
- Quick fill rate: 1.1 gpm (refrigerated models);
—1.5 gpm (non-refrigerated models)



Part #	Mfg #	Flow Rate	Rated	Full Load	Ship Wt	Description	Price
181650	LMABFDWSLK	Non-Refrigerated	N/A	15W	40 lbs	Light Gray Granite, Filtered	
163405	LMABF8WSLK	8.0 gph	115V	370W	75 lbs	Light Gray Granite, Filtered	
163859	LMABF8WSSK	8.0 gph	115V	370W	75 lbs	Stainless Steel, Filtered	

Water Fountains & Coolers

Bi-Level SoftSides® Architectural Fountains with Integral EZH2O® Hands-Free® Bottle Filling Station

- Touchless, sensor-activation (bottle filler); easy to operate pushbutton activation (fountain)
- Optional WaterSentry® Plus™ 3000 gallon filter
- Automatic 20-second shut-off timer
- Flexi-Guard® safety bubbler
- Laminar flow provides minimal splash
- Real drain system eliminates standing water
- Integrated silver ion anti-microbial protection
- Visual use interface display includes:
 - Innovative Green Ticker™ counts bottles saved from waste
 - Filter monitor indicating when replacement is necessary
- Existing installations would require expanding wall opening
- Mounting frame included
- Rated for indoor service



Water Fountains & Coolers

Part #	Mfg #	Flow Rate	Rated	Full Load	Ship Wt	Description	Price
188246	EZWSEDFP217K	Non-Refrigerated	115V	1A	118 lbs	Stainless Steel, Non-Filtered	

Surface Mount EZH2O® Bottle Filling Station

- Hands-Free®, sensor activation with automatic 20-second shut-off timer
- Ideal for education, healthcare facilities, fitness clubs, and hospitality
- Designed for application with limited wall depth
- Installs directly onto a wall with robust hanging bracket
- Optional WaterSentry® Plus™ 3000 gallon Filtration System
- Optional remote chiller
- Laminar flow minimizes splashing
- Real drain system eliminates standing water
- Silver ion anti-microbial protection
- Visual user interface display includes:
 - Innovative Green ticker™ counts the quantity of 16 ounce bottles saved
 - LED visual filter monitor shows when replacement is necessary
- Quick fill rate: 1.1 gpm-1.5 gpm
- Rated for indoor service



Part #	Mfg #	Flow Rate	Rated	Full Load	Ship Wt	Description	Price
161874	EZWSSM	Non-Refrigerated	115V	1A	18 lbs	Stainless Steel, Non-Filtered	
168526	LZWSSM	Non-Refrigerated	115V	1A	18 lbs	Stainless Steel, Filtered	

Water Fountains & Coolers

Water Fountains & Coolers

Vandal-Resistant EZH2O Bottle Filler with Single Filtered Cooler

- Ideal for heavy-use installations such as educational and indoor recreational facilities
- Embossed graphics
- Vandal-resistant push button activation on bottle filler and cooler
—Also includes vandal-resistant bubbler
- WaterSentry® VII 1500-gallon capacity filtration system, certified to NSF/ANSI 42 & 53
—Class 1 particulate, chlorine, taste & odor **(LVRC8WSK model ONLY)**
- Automatic 20-second shut-off on bottle filler water flow
- Laminar flow provides minimal splash while a real drain system eliminates standing water
- Visual user interface display includes:
—Innovative Green Ticker™
—LED filter monitor indicating when replacement is necessary **(LVRC8WSK model ONLY)**
- Rated for indoor service
- Quick fill rate: 1.1 gpm (refrigerated models);
—1.5 gpm (non-refrigerated models)



Part #	Mfg #	Flow Rate	Rated	Full Load	Ship Wt	Description	Price
158840	LVRC8WSK	8 gph	115V	5A	88 lbs	Stainless Steel, Filtered	
227789	VRCDWSK	Non-Refrigerated	115V	1A	58 lbs	Stainless Steel, Non-Filtered	
176553	VR8WSK	8 gph	115V	5A	88 lbs	Stainless Steel, Non-Filtered	

Vandal-Resistant EZH2O Bottle Filling Station with Bi-Level Cooler

- Ideal for heavy-use installations such as educational and indoor recreational facilities
- Embossed graphics
- Vandal-resistant push button activation on bottle filler and cooler
—Also includes vandal-resistant bubbler
- Optional WaterSentry® Plus™ VII 3000 gallon filter
—(Certified to NSF 42 & 53 class 1 particulate, chlorine, taste & odor)
- Automatic 20-second shut-off on bottle filler water flow
- Laminar flow provides minimal splash while a real drain system eliminates standing water
- Visual user interface display includes:
—Innovative Green Ticker™
—LED filter monitor indicating when replacement is necessary
- Filter models rated for indoor service, filterless models rated for indoor/outdoor service
- Quick fill rate: 1.1 gpm (refrigerated models);
—1.5 gpm (non-refrigerated models)



Part #	Mfg #	Flow Rate	Rated	Full Load	Ship Wt	Description	Price
147471	VRCTL8WSK	8.0 gph	115V	5A	114 lbs	Stainless Steel, Non-Filtered	

Water Fountains & Coolers

Vandal-Resistant EZH2O Bottle Filling Station with Bi-Level Reverse Cooler

- Ideal for heavy-use installations such as educational and indoor recreational facilities
- Embossed graphics
- Vandal-resistant push button activation on bottle filler and cooler
—Also includes vandal-resistant bubbler
- Optional WaterSentry® Plus™ VII 3000 gallon filter
—(Certified to NSF 42 & 53 class 1 particulate, chlorine, taste & odor)
- Automatic 20-second shut-off on bottle filler water flow
- Visual user interface display includes:
—Innovative Green Ticker™
—LED filter monitor indicating when replacement is necessary
- Laminar flow provides minimal splash while a real drain system eliminates standing water
- Filter models rated for indoor service, filterless models rated for indoor/outdoor service
- Quick fill rate: 1.1 gpm (refrigerated models);
—1.5 gpm (non-refrigerated models)



Water Fountains & Coolers

Part #	Mfg #	Flow Rate	Rated	Full Load	Ship Wt	Description	Price
166365	LVRCTL8WSK	8.0 gph	115V	5A	114 lbs	Stainless Steel, Filtered	
153756	VRCTLR8WSK	8.0 gph	115V	5A	88 lbs	Stainless Steel, Non-Filtered	

Versatile Bi-Level EZH2O Cooler/Bottle Filling Station

- Fully-exposed, wall-mount
- Touchless, sensor-activation with automatic 20-second shut-off timer (Bottle filler)
- Easy-Touch front and side pushbar controls (Cooler)
- Available with Flexi-Guard® bubbler or vandal-resistant bubbler (includes "VR" code in model number)
- Versatile cooler design allows units to be installed either left-hand high and right-hand low or left-low and right high
- Real drain system eliminates standing water
- Laminar flow provides minimal splash
- Visual user interface display includes:
—Innovative Green Ticker™
—Filter monitor indicating when replacement is necessary
- Rated for indoor service
- Quick fill rate: 1.1 gpm (refrigerated models);
—1.5 gpm (non-refrigerated models)



Part #	Mfg #	Flow Rate	Rated	Full Load	Ship Wt	Description	Price
152073	EZSTL8WSLK	8.0 gph	115V	5A	89 lbs	Light Gray Granite, Non-Filtered	
150299	EZSTL8WSSK	8.0 gph	115V	5A	89 lbs	Stainless Steel, Non-Filtered	
178016	EZSTL8WSVRS K	8.0 gph	115V	5A	89 lbs	Stainless Steel, Non-Filtered	
148941	LZSTL8WSSK	8.0 gph	115V	5A	92 lbs	Stainless Steel, Filtered	
160329	LZSTL8WSVRLK	8.0 gph	115V	5A	92 lbs	Light Gray Granite, Filtered	

Water Fountains & Coolers

Water Fountains & Coolers

Versatile GreenSpec® Bi-Level EZH2O® Bottle Filling Cooler Combos

- Features Flexi-Guard® StreamSaver™ water efficient bubbler
- Touchless, sensor-activation (bottle filler); easy-to-operate push bar activation (cooler)
- Automatic 20-second shut-off timer
- Visual user interface display includes
 - Innovative Green Ticker™
 - Filter monitor indicating when replacment is necessary
- Laminar flow provides minimal splash
- Integrated silver ion anti-microbial protection in key areas
- Real drain system eliminates standing water
- Versatile cooler design
- Energy efficiency performance exceeds average market performance by 35% per CSA 815-99
- Rated for indoor service
- WaterSentry® plus 3000-gallon capacity filtration System **(For L models only)**
- Quick fill rate: 1.1 gpm (refrigerated models);
 - 1.5 gpm (non-refrigerated models)



Part #	Mfg #	Flow Rate	Rated	Full Load	Ship Wt	Description	Price
168871	EZSTLG8WSSK	8.0 gph	115V	4.2A	89 lbs	Stainless Steel, Non-Filtered	
168757	LZSTLG8WSLK	8.0 gph	115V	4.2A	92 lbs	Light Gray Granite, Filtered	
172775	LZSTLG8WSSK	8.0 gph	115V	4.2A	92 lbs	Stainless Steel, Filtered	

EZH2O® Hands-Free® Bottle Filler with Mechanically-Activated Cooler

- Mechanical-activation on water coolers is ideal for disaster prone regions
 - operates even during power disruptions
- Available as:
 - Retrofit kit
 - Complete water cooler and bottle filling station
- Touchless, sensor-activation (bottle filler); easy to operate pushbar activation (cooler)
- Flexi-Guard® saftey bubbler
- Optional WaterSentry® Plus™ 3000 gallon filter
- Automatic 20-second shut-off timer (bottle filler)
- Visual interface display includes:
 - Innovative Green Ticker™
 - Filter monitor indicating when replacement is necessary
- Quick fill rate: 1.1 gpm (refrigerated models);
 - 1.5 gpm (non-refrigerated models)
- Rated for indoor service



Part #	Mfg #	Flow Rate	Rated	Full Load	Ship Wt	Description	Price
222457	EMABFDWSSK	Non-Refrigerated	115V	1.0A	40 lbs	Stainless Steel, Non-Filtered	
189287	EMABF8WSLK	8.0 gph	115V	4.0A	75 lbs	Light Gray Granite, Non-Filtered	

Water Fountains & Coolers

EZH2O® Hands-Free® Bottle Filling Station with GreenSpec Vandal-Resistant Cooler

- Ideal for educational, healthcare fitness, and office facilities
- Refrigeration system is over 50% more energy efficient
- Vandal-resisant StreamSaver™ bubbler reduces water usage by nearly 40%
- Sanitary, touchless activation with auto 20-second shut-off (bottle filler)
- WaterSentry® Plus™ 3000 gallon capacity filtration system
- Laminar flow provides minimal splash while a real drain system eliminates standing water
- Visual user interface display includes:
 - Innovative Green Ticker™
 - LED filter monitor indicating when replacement is necessary
- Quick fill rate of 1.1 gpm
- Rated for indoor service



Part #	Mfg #	Flow Rate	Rated	Full Load	Ship Wt	Description	Price
144472	LVRGRN8WSK	8 gph	115V	3.8A	89 lbs	Stainless Steel, Filtered	

EZH2O® Hands-Free® Bi-Level Bottle Filling Station with GreenSpec® Vandal-Resistant Cooler

- Ideal for educational, healthcare fitness, and office facilities
- Refrigeration system is over 50% more energy efficient
- Vandal-resisant StreamSaver™ bubbler reduces water usage by nearly 40%
- Sanitary, touchless activation with auto 20-second shut-off (bottle filler)
- WaterSentry® Plus™ 3000 gallon capacity filtration system
- Laminar flow provides minimal splash while a real drain system eliminates standing water
- Visual user interface display includes:
 - Innovative Green Ticker™
 - LED filter monitor indicating when replacement is necessary
- Quick fill rate of 1.1 gpm
- Rated for indoor service



Part #	Mfg #	Flow Rate	Rated	Full Load	Ship Wt	Description	Price
169528	VRCGRNTL8WSK	8.0 gph	115V	3.8A	112 lbs	Stainless Steel, Non-Filtered	

Water Coolers

Adult or Child Water Cooler

- Self-contained, wall hung electric refrigerated cooler
- Hooded stream projector with Easy-Touch® controls
- Valve with built-in flow regulator provide constant stream from 20 to 105 psi
- Bubbler orifice fully protected to meet all sanitary codes
- Non-pressurized stainless steel cooling tank
- Front and side pushbars
 - Front pushbars (LZ8S model only)



EZS8L

Part #	Mfg #	Flow Rate	Rated	Full Load	Ship Wt	Description	Price
059725	EZS4L	4.0 gph	115V	4A	57 lbs	Light Gray Granite, Non-Filtered	
051564	EZS8L	8.0 gph	115V	4A	56 lbs	Light Gray Granite, Non-Filtered	
065806	EZS8S	8.0 gph	115V	4A	89 lbs	Stainless, Non-Filtered	
173317	LZ8S	8.0 gph	115V	5A	54 lbs	Stainless, Filtered	

Water Fountains & Coolers

Water Fountains & Coolers

Mechanically-Activated Wall-Mount Water Cooler

- Operates during power disruptions
- Light-touch front and side pushbuttons with raised buttons
- Optional 1500 gallon capacity WaterSentry® VII filter
- Contoured basin minimizes splashing; with integral drain
- Flexi-Guard® safety bubbler
- Valve with built inflow regulator provides constant stream from 20-105 psi
- Impact resistant vinyl coating
- Vandal-resistant models include **(VR)** in number
- Rated for indoor service



Part #	Mfg #	Flow Rate	Rated	Full Load	Ship Wt	Description	Price
170182	EMABFDL	Non-Refrigerated	N/A	N/A	36 lbs	Light Gray Granite, Non-Filtered	
162497	EMABFVR8S	8.0 gph	115V	5A	58 lbs	Stainless Steel, Non-Filtered	
173252	LMABF8L	8.0 gph	115V	370W	68 lbs	Light Gray Granite, Filtered	

Mechanically-Activated Bi-Level Wall-Mount Water Cooler

- Operates during power disruptions
- Light-touch front and side pushbuttons with raised buttons
- Optional 1500 gallon capacity WaterSentry® VII filter
- Contoured basin minimizes splashing; with integral drain
- Flexi-Guard® safety bubbler
- Valve with built inflow regulator provides constant stream from 20-105 psi
- Impact resistant vinyl coating
- Vandal-resistant models include **(VR)** in number
- Rated for indoor service



Part #	Mfg #	Flow Rate	Rated	Full Load	Ship Wt	Description	Price
159021	EMABFTLDDLC	Non-Refrigerated	N/A	N/A	46 lbs	Light Gray Granite	

Hands-Free® EZ Sensor Operated Non-Filtered Water Cooler

- 1500 Gallon capacity WaterSentry® VII Filter
- Filter monitor indicating when replacement is necessary
- Auto shut-off device prevents need to turn off water supply to change filter
- Valve with built-in flow regulator, provides constant stream from 20-105 psi
- Barrier-free ADA design meets adult or child ADA standards when properly installed
- Extra deep basin minimizes splashing, with vandal resistant integrated design
- Flexi-Guard® anti-microbial safety bubbler
- Easy-to-install universal design
- Impact resistant vinyl coating
- Rated for indoor service



Part #	Mfg #	Flow Rate	Rated	Full Load	Ship Wt	Description	Price
170532	EZODL	Non-Refrigerated	115V	N/A	25 lbs	Light Gray Granite, Non-Filtered	
172469	EZO8S	8.0 gph	115V	5A	51 lbs	Stainless Steel, Non-Filtered	

Water Fountains & Coolers

Versatile Adult or Child Bi-Level Water Cooler

- Wall hung, electric refrigerated cooler
- Extra deep basin minimizes splashing
- Flexi-Guard® safety bubbler and Easy-Touch® controls on front & sides
- Impact resistant vinyl coating
- Valve with built-in flow regulator provides constant stream from 20 to 105 psi
- Versatile cooler design
- Vandal-resistant bubbler (includes "VR" code in model number)
- Non-pressurized stainless steel cooling tank
- Rated for indoor service



Water Fountains & Coolers

Part #	Mfg #	Flow Rate	Rated	Full Load	Ship Wt	Description	Price
059125	EZSTL8LC	8.0 gph	115V	4A	72 lbs	Light Gray Granite, High Cooler on Left	
070020	EZSTL8SC	8.0 gph	115V	4A	72 lbs	Stainless, High Cooler on Left	
180516	EZSTLVR8LC	8.0 gph	115V	4A	72 lbs	Light Gray Granite, High Cooler on Right	

Versatile GreenSpec® Filtered Bi-Level Water Cooler

- High-efficiency, electric refrigerated cooler
- Flexi-Guard® StreamSaver™ water conservation bubbler
- Energy efficiency performance exceeds average market performance by 35% per CSA 815-99
- Easy-Touch front and side pushbar
- WaterSentry® VII 1500-gallon capacity Filtration System, certified to NSF/ANSI 42 & 53 (Lead, Class 1 Particulate, Chlorine, Taste & Odor)
- Rated for indoor service



Part #	Mfg #	Flow Rate	Rated	Full Load	Ship Wt	Description	Price
180239	LZSTLG8LC	8.0 gph	115V	3.2A	75 lbs	Light Gray Granite	
188122	LZSTLG8SC	8.0 gph	115V	3.2A	75 lbs	Stainless Steel	

Legacy Wall-Mount Water Cooler

- Light-touch controls on front and sides
- One-piece basin with high integral backsplash
- Flexi-guard® safety bubbler
- Impact resistant vinyl coating
- Mounting hangers furnished
- NSF/ANSI 61 & 372 certified
- Rated for indoor service



Part #	Mfg #	Flow Rate	Rated	Full Load	Ship Wt	Description	Price
167248	EHFSADL	Non-Refrigerated	N/A	N/A	39 lbs	Light Gray Granite, Non-Filtered	
006092	EHFSA8L1Z	7.6 gph	115V	4A	70 lbs	Light Gray Granite, Filtered	

Water Fountains & Coolers

Water Fountains & Coolers

Simulated Semi-Recessed Wall-Mount Water Cooler

- Complete with mounting hangers
- One-piece satin finish stainless steel top, vinyl sides
- Flexi-Guard® safety bubbler



Part #	Mfg #	Flow Rate	Rated	Full Load	Ship Wt	Description	Price
006098	EWA8L1Z	7.8 gph	115V	3.5A	68 lbs	Light Gray Granite	

Adult or Child Bi-Level Filtered Water Cooler

- Wall hung electric refrigerated cooler
- Operates during power disruptions
- WaterSentry® VII 1500-gallon capacity filtration system, certified to NSF/ANSI 42 & 53 —Lead, class 1 particulate, chlorine, taste & odor
- Contoured basin minimizes splashing; with integral drain
- Flexi-Guard® safety bubbler
- Models including VR stands for vandal-resistant bubbler style
- Valve with built inflow regulator provides constant stream from 20-105 psi
- Impact resistant vinyl coating
- Rated for indoor service



Part #	Mfg #	Flow Rate	Rated	Full Load	Ship Wt	Description	Price
173251	LMABFTL8LC	8.0 gph	115V	5A	97 lbs	Light Gray Granite	
190250	LMABFTLVR8LC	8.0 gph	115V	5A	97 lbs	Light Gray Granite	

Legacy Simulated Semi-Recessed Refrigerated Water Cooler

- One-piece basin with high integral backsplash
- Flexi-Guard® anti-microbial safety bubbler
- Impact resistant vinyl coating
- Front pushbutton activation
- Rated for indoor use



Part #	Mfg #	Flow Rate	Rated	Full Load	Ship Wt	Description	Price
006095	ESWA8L1Z	7.8 gph	115V	325W	57 lbs	Light Gray Granite	

Water Fountains & Coolers

Legacy Deluxe Electric Refrigerated Water Cooler

- Traditional, classic styling looks good in any setting
- Optional 1500 gallon capacity WaterSentry® VII filter
- Cascade basin minimizes splashing
- Flexi-Guard® anti-microbial safety bubbler
- Removable front panels for easy access
- Impact resistant vinyl coating
- Rated for indoor service



Water Fountains & Coolers

Part #	Mfg #	Flow Rate	Rated	Full Load	Ship Wt	Description	Price
006096	EWA14L1Z	13.5 gph	115V	665W	76 lbs	Light Grey Granite	
186435	EWA14S1Z	13.5 gph	115V	665W	76 lbs	Stainless Steel	

SwirlFlo® Bi-Level Wheelchair Access Water Cooler

- Uses HFC-134A refrigerant
- Flexi-Guard safety bubbler
- In-line flow regulator
- Removable louvered front ventilating grill
- ADA Compliant



Part #	Mfg #	Flow Rate	Rated	Full Load	Ship Wt	Description	Price
027068	ERPBM28K	7.5 gph	115V	4.0A	140 lbs	Stainless	

Space-ette® Flush to Wall Refrigerated Air Cooled Floor Mount Water Cooler

- Trim, space—saving units
- Impact resistant vinyl coating
- WaterSentry® VII 1500-gallon capacity filtration system
— Included with **LFDE** models (Models are filtered)
— **Order separately** for all other models
- Flex—Guard®
- Removable front panel for easy access
- Space-ette® basin has integral vandal-resistant strainer
- Glass filler prepped—models with letter (F)
- Rated for indoor service



Part #	Mfg #	Flow Rate	Rated	Full Load	Ship Wt	Description	Price
134660	FD70010L(F)1Z	9.8 gph	115V	6.8A	65 lbs	Light Gray Granite	
163500	FD70010T1Z	9.8 gph	115V	6.8A	65 lbs	Sandalwood	
132042	FD7003L1Z	3.0 gph	115V	3.5A	54 lbs	Light Gray Granite	
006100	FD7003L(F)1Z	3.0 gph	115V	3.5A	54 lbs	Light Gray Granite	
148216	FD7005L1Z	5.0 gph	115V	3.5A	54 lbs	Light Gray Granite	
133366	LFDE10L(F)1Z	9.8 gph	115V	6.8A	68 lbs	Light Gray Granite	

Water Fountains & Coolers

Water Fountains & Coolers

Legacy Deluxe Water Cooler

- Impact resistant vinyl coating
- Optional 1500 gallon capacity WaterSentry® VII filter
- Flexi-Guard® safety bubbler
- Extra deep basin minimizes splashing; with integral vandal-resistant strainer
- Removable front panel for easy access
- Glass filler prepped—models with letter (F)
- Rated for indoor service
- NSF/ANSI 61 and 372 certified



Part #	Mfg #	Flow Rate	Rated	Full Load	Ship Wt	Description	Price
186463	EFA8S1Z	8.0 gph	115V	4A	72 lbs	Stainless Steel, Non-Filtered	

Bracket Drinking Fountain

- 300 Series, nickel bearing stainless steel fountain
- 14 Gauge, heavy-duty wall bracket
- Contoured basin to eliminate splashing and standing water
- Basin has rounded corners and removable chrome-plated strainer



Part #	Mfg #	Overall Size	Control	Ship Wt	Price
094889	EDF15R	10"W x 6"D x 3"H	Pushbutton Bubbler	5 lbs	

Vandal-Resistant Water Cooler

- Ideal for schools and other heavy-use installations
- Vandal-resistant items include
 - Pinned Torx® screws
 - Bubbler
 - Single action, self-closing mechanical pushbutton
- Real drain system eliminates standing water
- ADA design meets adult or child standards when properly installed
- Stream height regulator can be adjusted through hole in pushbutton
 - Provides constant stream from 20 to 105 psi
- Filtered models rated for indoor service, filterless rated for indoor/outdoor service



Part #	Mfg #	Flow Rate	Rated	Full Load	Ship Wt	Description	Price
162371	VRCD5	Non-Refrigerated	N/A	N/A	N/A	Stainless Steel, Non-Filtered	
177830	VRCS8S	8 gph	115V	5A	59 lbs	Stainless Steel, Non-Filtered	

Water Fountains & Coolers

Vandal-Resistant Bi-Level Water Cooler

- Ideal for schools and other heavy-use installations
- Vandal-resistant items include
 - Pinned Torx® screws
 - Bubbler
 - Single action, self-closing mechanical pushbutton
- Features louver screens
- Real drain system eliminates standing water
- 115V/60Hz—voltage/hertz
- ADA design meets adult or child standards when properly installed
- Stream height regulator can be adjusted through hole in pushbutton
 - Provides constant stream from 20 to 105 psi
- Filtered models rated for indoor service, filterless rated for indoor/outdoor service



Part #	Mfg #	Flow Rate	Rated	Full Load	Ship Wt	Description	Price
189490	LVRCTLSC8SC	8 gph	115V	5A	94 lbs	Stainless Steel, Filtered	
177251	VRCTLSC8SC	8 gph	115V	5A	94 lbs	Stainless Steel, Non-Filtered	

GreenSpec® Vandal-Resistant Bi-Level Water Cooler

- Over 50% more energy efficient
- Reduces refrigerant use by nearly 8%
- Optional WaterSentry® VII1500 gallon filter
- Vandal-resistant StreaaSaver™ bubbler reduces water usage by almost 40%
- Vandal-resistant, single-action mechanical pushbutton is self-closing
 - Does not require grasping or twisting
 - Operates during power disruptions
- Flow regulator provides constant stream from 20 to 105 psi water pressure
- Glass filler prepped— (lvrcgrntl8fc model only)
- Rated for indoor service



Part #	Mfg #	Flow Rate	Rated	Full Load	Ship Wt	Description	Price
167555	LVRGCRNTL8FC	8 gph	115V	2.8A	98 lbs	Stainless Steel, Filtered	
134332	VRCGRNTL8C	8 gph	115V	2.8A	94 lbs	Stainless Steel, Non-Filtered	

EZ Wall-Mount Water Cooler

- ADA design meets adult or child ADA standards when properly installed
- Optional 1500 gallon capacity WaterSentry® VII filter
- Extra deep basin minimizes splashing, with vandal resistant integrated drain
- Valve with built-in flow regulator to provide constant stream from 20-105 psi water pressure
- Glass filler prepped
- Easy-touch controls
- Flexi-Guard® safety bubbler
- Easy-to-install universal design
- Impact resistant vinyl coating
- Rated for indoor service



Part #	Mfg #	Flow Rate	Rated	Full Load	Ship Wt	Description	Price
109946	EZS4LF	4.0 gph	115V	2A	50 lbs	Light Gray Granite, Non-Filtered	
085547	EZS8LF	8.0 gph	115V	4A	51 lbs	Light Gray Granite, Non-Filtered	

Water Fountains & Coolers

Water Fountains & Coolers

Water Coolers (Continued)

EZ Wall-Mount Water Cooler

Part #	Mfg #	Flow Rate	Rated	Full Load	Ship Wt	Description	Price
152700	LZS8LF	8.0 gph	115V	4A	51 lbs	Light Gray Granite, Filtered	

EZ GreenSpec® Water Cooler

- High energy efficiency refrigeration system exceeds average market performance by 35%
- Includes Flexi-Guard®StreamSaver® water efficient bubbler
- Easy-to-touch front and side pushbar controls
- Easy-to-install universal design
- Rated for indoor service



Part #	Mfg #	Flow Rate	Rated	Full Load	Ship Wt	Description	Price
167552	EZSG8S	8.0 gph	115V	3.2A	64 lbs	Stainless Steel, Non-Filtered	

Soft Sides® Composite Gel-Coated Drinking Fountain

- No electrical required
- Contoured basin minimizes splashing
- Pushbutton, self-closing bubbler with pressure regulator
- Flow regulator provides constant stream from 20 to 105 psi water pressure
- Vandal-resistant bottom cover plate
- Drain and trap assembly included
- Rated for indoor/outdoor service



Part #	Mfg #	Flow Rate	Rated	Full Load	Ship Wt	Description	Price
157484	EDF214WC	Non-Refrigerated	N/A	N/A	N/A	White Granite, Non-Filtered	

SwirIFlo Oval® Legacy Countertop Non-Refrigerated Drinking Fountain

- Contoured basin minimizes splashing
- Push button, self-closing bubbler
- Flow regulator provides constant stream from 20 to 105 psi
- Brackets provided for countertop mounting
- Rated for indoor/outdoor service



Part #	Mfg #	Flow Rate	Rated	Full Load	Ship Wt	Description	Price
078307	DRKR14C	Non-Refrigerated	N/A	N/A	7.3 lbs	Stainless Steel, Non-Filtered	

Water Fountains & Coolers

Freeze-Resistant Outdoor Tubular Steel Drinking Fountain

- Weather-resistant textured finish
- Contour-formed stainless steel design includes:
 - Rounded edges
 - Minimizes splashing
 - Ensures proper drainage
 - Prevents standing water
- Constructed of cold-rolled steel
- 3/8" O.D. tubing—water inlet
- 1-1/4" tube outlet for 1-1/4" slip joint connection—drain outlet
- E-coat immersion process coats inside and outside of fountain for ultimate corrosion protection
- Vandal-resistant pushbuttons with self-closing valve
- Vandal-resistant bubbler—chrome plated, one piece design
- Access panel features vandal-resistant screws
- Optional locking and non-locking hose bib accessories available
- NSF/ANSI 61 certified



Water Fountains & Coolers

Part #	Mfg #	Flow Rate	Rated	Full Load	Ship Wt	Description	Price
182672	LK4405FRK	Non-Refrigertaed	N/A	N/A	62 lbs	Evergreen, Non-Filtered	

Barrier-Free Access

SoftSides® Heavy-Duty Drinking Fountain

- No electrical required
- Barrier-free ADA design meets adult standards when properly installed
- Self-closing vandal-resistant pushbuttons do not require grasping or twisting
- Vandal-resistant bubbler
- Contoured basin minimizes splashing
- One-piece vandal-resistant drain
- Bottom cover plate
- Intgral P-trap included
- Flow regulator provides constant stream from 20 to 105 psi water pressure
- NSF/ANSI 61 certified
- Rated for indoor/outdoor service



Part #	Mfg #	Flow Rate	Rated	Full Load	Ship Wt	Description	Price
151536	EHWM214C	Non-Refrigerated	N/A	N/A	39 lbs	Stainless Steel, Non-Filtered	

Water Fountains & Coolers

Water Fountains & Coolers

Legacy Fully Recessed Water Cooler

- Entire unit doesn't extend more than 1/2" from wall surface
- Optional 1500 gallon capacity WaterSentry® VII filter
- Stainless steel louvered ventilating grill
- Cooling unit is removable without disturbing electrical or drain connections
- Front push activation
- Flexi-Guard® safety bubbler
- Flow regulator provides constant stream from 20 to 105 psi water pressure
- Complete with refrigeration package, mounting box, and grill
- Rated for indoor service



Part #	Mfg #	Flow Rate	Rated	Full Load	Ship Wt	Description	Price
227438	LJNEM12K	12 gph	115V	4.7A	129 lbs	Stainless Steel, Filtered	

SwirlFlo® Non-Refrigerated Drinking Fountain

- Wall-mount-fully exposed with wall plate
- Tubular stainless steel support arm is integrated with basin
- Contoured basin minimizes splashing and has Flexi-Guard® safety bubbler
- Vandal-resistant front pushbutton and bottom cover plate
- Flow regulator provides constant stream from 20 to 105 psi water pressure
- Barrier-Free ADA design meets adult ADA standards when properly installed



Part #	Mfg #	Flow Rate	Rated	Full Load	Ship Wt	Description	Price
094160	EDFPBWM114C	Non-Refrigerated	N/A	N/A	22 lbs	Stainless Steel, Non-Filtered	

Swirlflo® Single Water Cooler

- Barrier-Free ADA design meets adult ADA standards when properly installed
- Flexi-Guard® safety bubbler is standard, optional vandal-resistant bubbler is available
- Removable louvered front ventilating grill encloses refrigeration
- Stainless steel tubular arm integrated with basin
- Contoured basin designed to minimize splashing
- Vandal-resistant front pushbutton
- Flow regulator provides constant stream from 20 to 105 psi water pressure
- Optional WaterSentry® VII 1500 gallon capacity filtration system
- Rated for indoor use only



Part #	Mfg #	Flow Rate	Rated	Full Load	Ship Wt	Description	Price
226634	LRPBM8K	8 gph	115V	4A	93 lbs	Stainless Steel, Filtered	

Water Fountains & Coolers

Swirlflo® Bi-Level GreenSpec® Filtered Water Fountain

- Over 55% more energy efficient
- StreamSaver™ bubbler reduces water usage by almost 40%; available as Flexi-Guard® or vandal-resistant style
- Removable louvered front ventilating grill encloses refrigeration
- Reduces refrigerant use by nearly 20%
- Optional WaterSentry® VII 1500-gallon capacity filtration system, certified to NSF/ANSI —Lead, class 1 particulate, chlorine, taste & odor
- Rated for indoor use only



Part #	Mfg #	Flow Rate	Rated	Full Load	Ship Wt	Description	Price
180996	LRPBGRNM28K	8.0gph	260W	2.8A	140 lbs	Stainless Steel	

SwirlFlo® Bi-Level Non-Refrigerated Drinking Fountains

- Fountain dimensions
—Length: 38-1/2", Width: 19", Height: 21-15/16"
- Stainless steel support arms are integrated with basin
- Contoured basin minimizes splashing
- ADA design meets adult ADA standards when properly installed
- Flexi-Guard® safety bubblers or vandal-resistant bubbler is available
—Available if the letter (V) is included in the model number
- Vandal-resistant front pushbutton
- Flow regulator provides constant stream from 20 to 150 psi
- Vandal-resistant bottom cover plates included
- Includes stainless steel back panel and surface mounting plate
- Rated for indoor and outdoor service



Part #	Mfg #	Flow Rate	Rated	Full Load	Ship Wt	Description	Price
104731	EDFPBM117C	Non-Refrigerated	N/A	N/A	72 lbs	Stainless Steel, Non-Filtered	
180858	EDFPBM(V)117C	Non-Refrigerated	N/A	N/A	72 lbs	Stainless Steel, Non-Filtered	

Swirlflo® Reverse Bi-Level Water Cooler

- Barrier free ADA design meets adult ADA standards when properly installed
- Optional 1500 gallon capacity WaterSentry® VII filter
- Contoured basin designed to minimize splashing
- Stream height regulator provides constant stream from 20 to 105 psi
- Flexi-Guard® safety bubbler
- Rated for indoor service



Part #	Mfg #	Flow Rate	Rated	Full Load	Ship Wt	Description	Price
106888	ERPBM28RAK	7.5 gph	115V	370W	140 lbs	Stainless Steel, Non-Filtered	

Water Fountains & Coolers

Water Fountains & Coolers

Swirlflo® Reverse Bi-Level Drinking Fountain

- No electrical required
- Barrier free ADA design meets adult ADA standards when properly installed
- Stainless steel tubular arms intergrated into basin
- Contoured basin designed to minimize splashing
- Flow regulator provides constant stream from 20 to 105 psi
- Flexi-Guard® safety bubbler is standard, optional vandal-resistant bubbler is available
- Vandal-resistant front pushbutton
- Lower left fountain positioned for wheelchair use
- NSF/ANSI 61 certified
- Rated for indoor service



Part #	Mfg #	Flow Rate	Rated	Full Load	Ship Wt	Description	Price
159954	EDFPBMV117RA C	Non-Refrigerated	N/A	N/A	72 lbs	Stainless Steel, Non-Filtered	

Swirlflo® Hands-Free® Sensor Operated Bi-Level Water Cooler

- In-the-wall energy efficiated refrigerated system with stainless steel grill
- Stainless steel tubular support arms intergrated into basin
- All stainless steel is polished to a lustrous satin finish with high shine outer edge
- Barrier free ADA design meets adult ADA standards when properly installed
- Optional 1500 gallon capacity WaterSenrty® VII filter
- Contoured basin designed to minimize splashing
- Stream height regulator provides constant stream from 20 to 105 psi
- Flexi-Guard® safety bubbler
- Rated for indoor service



Part #	Mfg #	Flow Rate	Rated	Full Load	Ship Wt	Description	Price
124692	ENOBM28K	7.5 gph	115V	370W	140 lbs	Stainless Steel, Non-Filter	

Soft Sides® Bi-Level Non-Refrigerated Drinking Fountain

- Wall mount-fully exposed with wall plate
- Barrier-free ADA design meets adult standards when properly installed
- Stream height regulator provides constant stream from 20 to 105 psi
- Vandal-resistant front pushbutton
- Flexi-Guard® safety bubbler
- Contoured basin provides a splash-resistant surface
- Bottom cover plate prevents vandalism
- Integral P-trap included
- Freeze-resistant models include **(FPK)** in model number
- NSF/ANSI 61 certified
- Rated for indoor/outdoor service



Part #	Mfg #	Flow Rate	Rated	Full Load	Ship Wt	Description	Price
040432	EDFP217C	Non-Refrigerated	N/A	N/A	42 lbs	Stainless Steel, Non-Filtered	
163065	EDFP217FPK	Non-Refrigerated	N/A	N/A	69 lbs	Stainless Steel, Non-Filtered	

Water Fountains & Coolers

Soft Sides® Non-Refrigerated Drinking Fountain

- Wall mount-fully exposed with wall plate
- Barrier-free ADA design meets adult standards when properly installed
- Stream height regulator provides constant stream from 20 to 105 psi
- Vandal-resistant front pushbutton
- Flexi-Guard® safety bubbler
- Contoured basin provides a splash-resistant surface
- Bottom cover plate prevents vandalism
- Integral P-trap included



Part #	Mfg #	Flow Rate	Rated	Full Load	Ship Wt	Description	Price
066795	EDFP214C	Non-Refrigerated	N/A	N/A	16 lbs	Stainless Steel, Non-Filtered	

Soft Sides® Hands-Free® Drinking Fountain

- Barrier-free ADA design meets adult standards when properly installed
- Optional 1500 gallon capacity Watersentry® VII filter
- Stream height regulator provides constant stream from 20 to 105 psi
- Energy efficient refrigeration system
- Flexi-Guard® safety bubbler is standard, optional vandal-resistant bubbler is available
- Contoured basin provides a splash-resistant surface
- Removable louvered front ventilating grill encloses refrigeration and plumbing
- Bottom cover plate prevents vandalism
- Rated for indoor service



Part #	Mfg #	Flow Rate	Rated	Full Load	Ship Wt	Description	Price
187013	EROM8K	8.0 gph	115V	4.5A	100 lbs	Stainless Steel	

Water Fountains & Coolers

Water Fountains & Coolers

Commercial Specialties
Self Closing Drinking Fountain

- 1/2" FPT
- Flow regulator screw
- Cross handle
- Precision ball bearing action



Part #	Mfg #	Description	Price
008080	2190	Chrome Plated Brass	

Water Fountains & Coolers

Water Fountains & Coolers

Water Chiller Parts

Part #	Mfg #	Description	Price
125574	27638C	Chiller Shelf	

Bubblers



51544C



56073C



LK142



LK1141A

Part #	Mfg #	Description	Price
130410	51544C	Halsey Taylor, Chrome Plated	
160547	98481C	StreamSaver™, Chrome	
030555	LK1141A	Flexi-Guard®, Chrome Plated	
006109	LK142	Pushbutton, Chrome	
165885	98533C	Bubbler	

Cane Aprons

Part #	Mfg #	Flow Rate	Rated	Full Load	Ship Wt	Description	Price
128063	97258C					Black ABS Plastic	
128010	98324C					Stainless Steel	
151905	LKAPR1					Gray ABS Plastic	
076007	LKAPREZL					Gray ABS Plastic	

Air-Cooled Indoor Remote Water Chillers

- Converts any drinking fountain into a water cooler
- Galvanized steel cabinet
- Hermetically sealed compressor
- Rated for indoor service

Part #	Mfg #	Flow Rate	Rated	Full Load	Ship Wt	Description	Price
081714	ECH8	8 gph	115V	2-Stations	370W	43 lbs Non-Filtered	
166212	ER101Y	10 gph	115V	2-Stations	490W	74 lbs Non-Filtered	
159955	ER21Y	2 gph	115V	1-Station	185W	44 lbs Non-Filtered	
165758	ERS11Y	1 gph	115V	1-Station	140W	33 lbs Non-Filtered	

Mounting Frames

Part #	Mfg #	Flow Rate	Rated	Full Load	Ship Wt	Description	Price
055235	MF200					Bi-Level, For ENOB, ERFP, ERO, ERPB, LNTE, LRPB Models	

Water Fountains & Coolers

Water Fountains & Coolers

Mounting Systems

In-Wall Mounting Carrier Plate

- For models EDFP210, EDFP214, EDFPB114, EDFPBW114, EHW214 and single HDFF & HRF
- Heavy gauge steel in-wall support legs
—Supports up to 500 lbs
- Adjustable height setting allows for adult or child installation
- Plate can be installed two ways:
—Directly to studs
—Connect with (ML100) mounting legs
- Parts are painted with protective coating
- Universal design enables mounting to EDFP214, EDFPB114, EHW214, and single HDFF & HRF models all on one mounting plate



Part #	Mfg #	Flow Rate	Rated	Full Load	Ship Wt	Description	Price
186102	MPW101	Black					

Wall Access Panels

- Allows access for units with traps located behind the wall
- For use with bi-level Swirflo® or SoftSides® drinking fountains

Part #	Mfg #	Flow Rate	Rated	Full Load	Ship Wt	Description	Price
173810	ACCESS12X385	Stainless Steel					

Repair Parts

Part #	Mfg #	Flow Rate	Rated	Full Load	Ship Wt	Description	Price
181422	0000000238	Control Switch for ECH8 Model					
175384	0000001192	Gasket, 4-Pack					
225110	1000001600	Push Bar Assembly					
178181	1000001673	Regulator Kit					
222929	1000001772	Elbow Fittings					
186852	1000001791	Nipple/Gasket					
189177	1000001913	Regulator					
174397	1000001926	Hex Nut					
168541	100147140560	Drain Gasket					
168676	101567443730	Hook Rods for Shelf					
161319	15009C	Bubbler Nipple					
190309	20430C	Hanger Bracket					
162775	27209C	ESWA Gray/Beige Wrapper					
225722	28260C	Cooler Bracket, For Bi-Level Models					
222522	28536C	Left Hand Rear Panel, Stainless Steel					
222521	28539C	Right Hand Rear Panel, Stainless Steel					
160103	30120C	Overload					
160104	30143C	Relay					
170735	36216C	Wiring Harness					
166556	36248C	Solenoid Assembly					
168765	36272C	Capacitor					

Water Fountains & Coolers

Repair Parts (Continued)

Part #	Mfg #	Flow Rate	Rated	Full Load	Ship Wt	Description	Price
159101	36292C					Power Block	
226039	40500C					Valve Replacement Kit	
048471	40572C					Tailpipe	
181369	45330C					Waste Arm	
176361	45662C					Push Button	
181894	45728C					Drain Ferrule	
174396	45736C					Regulator Half Nut	
174394	45738C					Push Button Sleeve	
189639	45769C					Drain/Tailpiece Assembly	
154781	45894C					Drain Tube	
173736	51560C					Front Push Bar	
176362	56087C					Push Button Extension	
174399	56092C					Poly Tubing	
154777	56118C					Drain Fitting	
157432	56237C					PVC Fan Shroud	
154780	70444C					Clamp For Drain Fitting	
166998	70920C					Rod Pivot	
173200	72000483					Brass Washer, For LK24RT Model	
173199	72000484					"C" Spring Washer For LK24 Model	
173201	72000486					Rubber O-Ring, For LK24RT Model	
173203	72000488					CP Brass Packing Nut	
058214	72000492					O-Ring	
179499	72000580					Overflow Tube, NP	
167634	72001553					Rubber O-Ring	
167635	72001567					Ball Lever	
173198	72001879					O-Ring for LK24RT Model	
174305	72002160					Strainer, For LK35 Model	
072434	75580C					Bubbler Nut, For 56073C Model	
174398	75672C					Cap Screw	
168538	92776C					Regulator Assembly	
168539	96846C					Drain Assembly	
188578	97969C					Drain Replacement	
096667	98169C					Replacement Cap	
222185	98498C					Gooseneck Glass Filler	
225194	98546C					Aerator	
134443	98551C					Kitchen LZ Filter Mounting	
174395	98682C					Push Button Assembly	
169108	98719C					Evap Assembly	
168198	98731C					Regulator Kit	
178303	98773C					Cold Control	
165883	97970C					Drain Tube	
158432	98532C					Fountain O-Ring Kit	
170298	98535C					Overload	
165884	98537C					Push Bar Kit	
168732	98539C					Solenoid Assembly	

Water Fountains & Coolers

Water Fountains & Coolers

Repair Parts (Continued)

Water Fountains & Coolers

Part #	Mfg #	Flow Rate	Rated	Full Load	Ship Wt	Description	Price
165744	98543C					Electric Package Kit	
165745	98545C					Solenoid Valve Assembly	
165877	98733C					Kit Freeze Resist Fountain	
165715	98732C					Regulator Kit	
165886	98734C					Push Bar Set	
165879	98755C					Overload/Relay	
165880	98869C					Switch	
172795	A51266					Locknut	
164135	A51853R					Press Balance Cartridge	
163615	A51866R					Cartridge	
158038	A53080					Handle Assembly	
158612	A55961R					Lever Handle Assy, Brushed Nickel	
152310	A74921R					Handle	
185801	LK735					Aerator, Vandal Resistant 1.5 gpm	
172796	P02103					Coupling Nut	
172797	P35163					Wahser	
224492	P45746CR					Spray Head	

Water Fountains & Coolers

Bubblers



Part #	Mfg #	Description	Price
056339	B45-215	Pushbutton Bubbler	

Bubbler Accessories

Replacement Cartridge for Drinking Fountain Bubbler

- Lead free
- Chrome plated brass body
- Equipped with unique neo-poly water shield to prevent injuries to teeth, gums and face
- Tamper proof design requires 5/16" hex key to remove/replace water shield for cleaning



Part #	Mfg #	Description	Price
172608	B45-216	For B45-215 Pushbutton Bubbler	



Enviroplug - Bentonite

ENVIROPLUG® MEDIUM

- Were the first bentonite chips developed and marketed
- Pure Wyoming bentonite
- Designed for use as sealants for hole abandonment, casing seals or any vertical seal to prevent water movement up or down a bore hole
- When absorbing water, ENVIROPLUG® MEDIUM swells to fill voids, exerting pressure against all surfaces to create a flexible low permeability seal
- ENVIROPLUG® is introduced in a "dry" state, shrinkage cannot occur and there is a reserve expansion capacity
- Generally hydration takes one to two hours
- Certified to NSF/ANSI 60



Part #	Mfg #	Description	Price
012164	4230-8250	Medium, 50 lb Bag	

Water Systems

Jet Pumps

Booster Pump

- *Self-priming*
- *Ideal for pressure boosting from storage tanks*
- *Easy to use control panel*
- *Built-in dry-run protection*
- *Made from weatherproof, corrosion resistant materials*



Part #	Mfg #	HP	Volts	GPM	Price
063318	MQ3-35-115	3/4	115V	Up to 20	
056291	MQ3-45-115	1	115V	Up to 20	

Water Systems

Jet Pumps

Convertible Jet Pumps

- Cast iron casing and seal plate
- AO Smith higher than standard NEMA service factor dual compartment motor
- Dual voltage 115/230V
- Square D pressure switch preset at 30 to 50 psi
- 1-1/4" Suction, 1" NPT discharge and brass flow control valve
- Pressure gauge included
- Stainless steel motor shaft and dual ball bearings
- Precision engineered thermoplastic impeller, diffuser, nozzle and venturi
- 2-Year fully serviceable warranty



Deep Well Pump

- For installations where the vertical distance to pumping water level does not exceed 90'
- Deep well venturi supplied

Part #	Mfg #	Model	HP	Flow	Shut-Off	Price
119521	558281	JPC-050-C	1/2 hp	11 gpm	176'	
119522	558282	JPC-075-C	3/4 hp	18 gpm	164'	
119518	558283	JPC-100C	1 hp	20 gpm	164'	

Shallow Well Pump

- Clean-out plug to easily unclog nozzle

Part #	Mfg #	Model	HP	Flow	Shut-Off	Price
119520	558274	JP-050-C	1/2 hp	13 gpm	148'	

Jet Pumps

Quick-Set® Convertible Jet Pumps

- *Easy-to-stock Quick-Set components convert to deep or shallow well in minutes*
- *Low pressure/high volume or high pressure/low volume settings can be made easily*
- *Includes streamlined case with two discharge openings*



Part #	Mfg #	Description	Price
023935	100RJA	1 hp	

Water Systems

Submersible Pumps

3" SQ/SQE Submersible Well Pumps

- SQ/SQE Pumps are suitable for both continuous and intermittent operation for a variety of applications such as domestic water supply, small waterworks irrigation and tank applications
- Permanent-magnet motor and micro frequency converter
- Simple 2-wire design, single-phase power
- SQE Includes "Smart Motor" which communicates via CU300 status box through power leads



Part #	Mfg #	HP	Volts	Pump Outlet NPT	Price
043807	10SQ07-240	3/4	240V	1-1/4"	
070280	15SQE07-180	3/4	200-240V	1-1/4"	
107447	15SQE15-290	1-1/2	230V	1-1/4"	
085688	22SQE15-220	1-1/2	200-240V	1-1/2"	

SQ/SQE Constant Pressure Kit

- Includes status box and pressure transducer

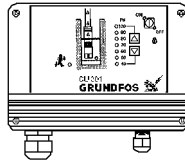

Part #	Mfg #	Description	Price
070281	CU301	"Smart Flo" & Transducer	

Water Systems

Submersible Pumps

Submersible Deep Well Pumps

- For new installs and replacement applications where water must be transferred under pressure from wells, cisterns, ponds, lakes and streams
- Stainless steel discharge
- Ceramic bearing sleeve
- Hex rubber bearing has extra-large surface to ensure shaft stability, and multiple flow channels to keep small particles away from bearing surfaces
- Celcon® disk for close tolerances and increased performance
- Stainless steel up-thrust washer
- Built-in Flomatic® check valve
- Removable suction screen



2-Wire Submersible Pump

Part #	Mfg #	Model	Description	Price
119416	558588	W12G05S7-21S	1/2 hp 115V 12 gpm	
119417	558589	W12G05S7-22S	1/2 hp 230V 12 gpm	
119418	558590	W12G07S9-22S	3/4 hp 230V 12 gpm	

3-Wire Submersible Pump

Part #	Mfg #	Model	Description	Price
119421	558593	W12G05S7-32S	1/2 hp 230V 12 gpm	
119422	558594	W12G07S9-32S	3/4 hp 230V 12 gpm	
119423	558595	W12G10S12-32S	1 hp 230V 12 gpm	
120054	558549	W22G15S9-32S	1-1/2 hp 230V 22 gpm	

Water Systems

Submersible Pumps

Submersible Motors

Super Stainless Single-Phase 4" 3-Wire Motor

- Water well construction
- 60Hz
- 3,450 rpm
- Corrosion-resistant stainless steel exterior
- Stainless steel spined shaft
- Hermetically-sealed windings
- StatorShield™ resin system
- Filter check valve
- Water lubrication
- Kingsbury-type thrust bearing
- Pressure-equalizing diaphragm
- Built-in lightning arrestors
- Removable WaterBloc™ lead

Part #	Mfg #	HP	Volts	Price
127981	2145059004S	1/2	230V	
127982	2145079004S	3/4	230V	
127983	2145089003S	1	230V	

Control Boxes

Quick Disconnect Control Box

- Designed for use with 3-wire single-phase submersible motors through 1 hp

Part #	Mfg #	HP	Hz	Volts	Price
119523	280 104 4915	1/2	60Hz	115V	
085267	280 105 4915	1/2	60Hz	230V	
085268	280 107 4915	3/4	60Hz	230V	
085269	280 108 4915	1	60Hz	230V	

Capacitor Run Control Box

- Designed for use with 3-wire single-phase submersible motors through 1 hp

Part #	Mfg #	HP	Hz	Volts	Price
119515	282 405 50	1/2	60Hz	230V	
124472	282 407 50	3/4	60Hz	230V	
119517	282 408 50	1	60Hz	230V	

Standard Control Box

- Designed for use with 3-wire single-phase submersible motors from 1 to 15 hp
- Recommended for water systems that use standard/heavy-duty pressure switches, level switches, or other pilot devices

Part #	Mfg #	HP	Hz	Volts	Price
119426	282 300 8110	1-1/2	60Hz	230V	

Water Service Accessories

Thermometers

Hot Water/Refrigerant Line Thermometer

- 1/2" NPT; 1" Stem



Part #	Mfg #	Description	Price
074478	J40-503	Angle Pattern, Brass Well	

Water Service Accessories

PCT Contractor Gauges

- Stainless steel case
- Highly accurate
- Zero adjustment screw
- CRN Registered
- 5-Year warranty



4-1/2" Stainless Steel Gauge with Bottom Connection

- 1/4" NPT Connection

Part #	Mfg #	Range	Price
129051	PCT321	0-30 psi/kPa	
129052	PCT322	0-60 psi/kPa	
129053	PCT323	0-100 psi/kPa	
129054	PCT324	0-160 psi/kPa	
129055	PCT325	0-200 psi/kPa	
129057	PCT326	0-300 psi/kPa	
181244	PCT329-R1	30"/0/30 psi/kPa	

PEM Series Economy Gauges

- Friction bezel ring
- Black steel case
- Brass internals
- Highly accurate
- CRN Registered
- 5-Year warranty



2" Steel Gauge with Back (CB) Connection

Part #	Mfg #	Range	Price
187692	PEM1404	0-60 psi/kPa	

2-1/2" Steel Gauge with Bottom Connection

- 1/4" NPT Connection

Part #	Mfg #	Range	Price
129059	PEM211	0-15 psi/kPa	
129060	PEM212	0-30 psi/kPa	
129061	PEM213	0-60 psi/kPa	
129063	PEM214	0-100 psi/kPa	
129064	PEM215	0-160 psi/kPa	
129065	PEM216	0-200 psi/kPa	
129066	PEM217	0-300 psi/kPa	

4" Steel Gauge with Bottom Connection

- 1/4" NPT Connection

Part #	Mfg #	Range	Price
174195	PEM223	0-100 psi/kPa	

PPC Process Gauges

- Field liquid-fillable, phenolic solid front blowout back safety case
- Stainless steel full rotary movement for longer life
- Micrometer pointer for ease in calibration
- Under and overload stops
- 316L Stainless steel, brass, Monel® or carbon steel wetted parts
- Restrictor screws standard on dual scale (optional on single scale gauges)
- CRN Registered
- 5-Year warranty



Single Scale with Bottom Connection

Part #	Mfg #	Range	Price
181222	PPC5062R1	0-30 psi, 1/2" Conn., Glycerin GW	
181223	PPC5063R1	0-60 psi, 1/2" Conn., Glycerin GW	
181224	PPC5064R1	0-100 psi, 1/2" Conn., Glycerin GW	
181225	PPC5065R1	0-160 psi, 1/2" Conn., Glycerin GW	
181226	PPC5067R1	0-300 psi, 1/2" Conn., Glycerin GW	
187776	PPC5062R1	0-30 psi, 1/2" Connection	
146839	PPC5044R1	0-100 psi, 1/4" Connection	
181227	PPC5141R1	30"/0-30 psi, 1/2" Connection GW	

Dual Scale with Bottom Connection

Part #	Mfg #	Range	Price
189429	PPC5042	0-30 psi/kPa, 1/4" Connection	
185146	PPC5084	0-100 psi/kPa, 1/4" Connection	

Water Systems



Water Service Accessories

PFP Premium Stainless Steel Liquid Filled Pressure Gauge

- Liquid filled stainless steel case
- Bayonet ring
- Highly accurate
- Back, bottom, or panel mounted
- Under and overload stops
- Ventable plug on 2.5" to 4.5"
- Dry case available
- ASME B40.100 compliant (EN837-1 available)
- CRN registered
- 5 year warranty



4" Steel Gauge with Bottom Connection

- (-GW) Models - Glycerin Water

Part #	Mfg #	Range	Price
181243	PFP1045R1	30"/ 0-30 psi	
	GW		
181238	PFP657R1G	0-30 psi	
	W		
181239	PFP658R1G	0-60 psi	
	W		
181240	PFP659R1G	0-100 psi	
	W		
181241	PFP660R1G	0-160 psi	
	W		
181242	PFP662R1G	0-300 psi	
	W		
189146	PFP660R1	0-160 psi	

2.5" Steel Gauge with Bottom Connection

Part #	Mfg #	Range	Price
165895	PFP824DRY	0-100 psi, Dry	

2.5" Steel Gauge with Back Connection

Part #	Mfg #	Range	Price
165896	PFP924DRY	0-100 psi, Dry	
172134	PFP924	0-100 psi, Liquid Filled	

PFQ Stainless Steel Liquid Filled Pressure Gauge

- Pulsation resistant, liquid filled stainless steel case
- Glycerin filled standard
- Brass, lead free brass or stainless steel internals
- Restricted orifice
- Crimp-On bezel
- Single (psi) or dual scale (psi/kPa)/(psi/bar) available
- Optional U-Clamps and front flanges
- Dry case available
- ASME B40.100 compliant
- RoHS compliant (SS internals only)
- CRN registered
- 5 year warranty



1.5" Pressure Gauge with Bottom Connection

Part #	Mfg #	Range	Price
190119	PFQ1105	0-160 psi, Brass Internals	
190120	PFQ1106	0-200 psi, Brass Internals	

2.5" Pressure Gauge with Bottom Connection

- 1/4" NPT connection

Part #	Mfg #	Range	Price
181232	PFQ802R1G	0-30 psi, Brass Internals	
	W		
181233	PFQ803R1G	0-60 psi, Brass Internals	
	W		
181234	PFQ804R1G	0-100 psi, Brass Internals	
	W		
181235	PFQ805R1G	0-160 psi, Brass Internals	
	W		
181236	PFQ807R1G	0-300 psi, Brass Internals	
	W		
184650	PFQ106	30" Hg Vac/kPa, SS Internals	

2.5" Pressure Gauge with Back Connection

- 1/4" NPT connection

Part #	Mfg #	Range	Price
188078	PFQ902	0-30 psi, Brass Internals	

Water Systems

Water Service Accessories

4" Pressure Gauge with Bottom Connection

- 1/4" NPT connection

Part #	Mfg #	Range	Price
181237	PFQ702R1G	30"/ 0-30 psi, Brass Internals W	
157195	PFQ711R1	0-100 psi, Brass Internals	
187017	PFQ760	30" Hg Vac/kPa, SS Internals	

4" Pressure Gauge with Back Connection

Part #	Mfg #	Range	Price
172133	PFQ1274	0-300 psi, SS Internals	

PSQ 3A All-Purpose Quality Sanitary Gauge

- Food grade glycerin filling standard
- Electro-polish finish
- Industrial grade polycarbonate lens standard
- Clean-In-Place and steam-in-place design
- ASME B40.100 compliant
- CRN Registered
- 5 year warranty
- 0.75", 1.5" and 2" Tri-Clamp® connections bottom and back



2.5" PSQ Sanitary Gauge

Part #	Mfg #	Range	Price
190135	PSQ15802	0-30 psi/bar, 1.5" Btm Connect	

LF Series Quality Gauges

- AISI 304 Stainless steel case & ring
- Plexiglass lens
- Over-pressure limit is 25% for pressures up to 1,400 psi; 15% for pressures over 1,400 psi
- Working pressure: maximum 75% of full scale value
- OT 59 Brass movement



2-1/2" LF Quality Gauge with Bottom Connection

- 1/4" NPT Connection

Part #	Mfg #	Range	Price
130267	PFQ803	0-60 psi/kPa	
130268	PFQ804	0-100 psi/kPa	
130269	PFQ806	0-200 psi/kPa	

2-1/2" LF Quality Gauge with Back Connection

- 1/4" NPT Connection

Part #	Mfg #	Range	Price
187695	PFQ902LF	0-30 psi/kPa	

Economy Test Gauges

- Valve body is chrome/nickel plated
- Steel case
- Adapts to 3/4" MPT
- Brass movement, socket, tube

2-1/2" LF Steel Gauge with Bottom Connection

- 1/4" NPT Connection

Part #	Mfg #	Range	Price
174289	PEM214LF	0-100 psi/kPa	

2" Economy Gas Test Gauge



Part #	Mfg #	Range	Price
129072	PETG202	0-30#	
129073	PETG204	0-100#	

2-1/2" Economy Maximum Pointer Water Test Gauge

- 3/4" Swivel hose adapter
- CRN Registered
- 5-Year warranty



Part #	Mfg #	Range	Price
129197	PETM217	0-300 psi	

Water Service Accessories

PLT Low Pressure Test Kits

- Sensitive phosphor bronze diaphragm gauge
- Re-zero with external recalibration screw
- Plastic blow molded black painted steel case
- Sleek design featuring secure latch
- 2.5" White aluminum dial with red and black markings
- 1/4" Brass hose barb connection
- 5-Year warranty



Part #	Mfg #	Range	Price
129076	PLT15	0-15" water/oz/in2	

Accessories

SSP Syphon

- 180° Coil
- CRN Registered
- 1-Year warranty



Part #	Mfg #	Description	Price
129967	SSP545	1/4" NPT Sch 40 Brass	
129968	SSP555	1/2" NPT Sch 40 Steel	

Test Plug

- Brass
- Facilitates quick pressure and temperature readings at recommended test points within process
- 1-Year warranty



Part #	Mfg #	Description	Price
141896	STP001	1/4" NPT Male Connection	
129058	STP003	2.75 OAL x 1.75" x 0.125" Probe Gauge Adapter	

TBR Bi-Metal Threaded Thermowell

- Allows the easy replacement of thermometers without the need to shut down or drain the system
- CRN Registered
- 1-Year warranty



Part #	Mfg #	Description	Price
130608	TBR950	1/2" NPT Brass, 7-1/2" Insertion Length, 9" Stem	

TIW-LF Thermowell

Part #	Mfg #	Range	Price
186143	TIW01LF	3/4" LF Brass Thermowell	

Thermometers

TBM Bi-Metal Thermometer

- A general purpose, versatile 1" to 6" dial, 304 stainless steel thermometer
- Bi-metallic sensing element
- Back, bottom or adjustable angle connection
- Welded stem length from 2.5" and up
- ±1% accuracy
- Anti-parallax dial that reduces operator reading errors (3"–6")
- Recalibrator screw is standard on all dial sizes
- ASME B40.200 compliant
- RoHS compliant
- 5 year warranty



3" Dial, Fixed Center Back

Part #	Mfg #	Range	Price
174469	TBM30025B	-40 - 160°F , 2.5" Stem	
	4		
187009	TBM30025B	0-250°F, 2.5" Stem	
	8		

TIM Industrial 9IT Thermometer

- Includes a separable thermowell
- 9" Case
- Organic filled tube (non-mercury)
- Dual scale (°F and °C)
- Vari-angle connection and 360° case rotation for easy installation
- Graphite filled bulb chamber for maximum heat conduction
- ±1% Accuracy
- 5-Year warranty



3-1/2" Stem with Aluminum Case

Part #	Mfg #	Range	Price
187727	TIM101A	-40°F - 110°F	
129068	TIM102A	0°F - 120°F	
129069	TIM100A	30°F - 240°F	

6" Stem with Aluminum Case

Part #	Mfg #	Range	Price
186206	TIM105-6A	30°F - 300°F	

Water Service Accessories

Hot Water Thermometer

- Measures air or water temperature
- Dial type or vertical scale type
- 1/2" NPT Process connection
- 5-Year warranty

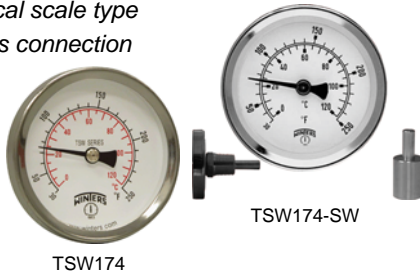

Part #	Mfg #	Description	Price
129071	TSW174	30°F - 250°F, 2" Dial	
129965	TSW174-SW	30°F - 250°F, 2" Dial with Sweat well	

TASK Industrial 5AS Thermometer

- For use in small pipelines, tanks and other pressurized systems
- 5", Aluminum, painted white and black markings
- Brass, 1/2" NPT standard, separable thermowell
- Accuracy +/- 2% of full scale



Part #	Mfg #	Range	Price
190522	TAS131	20°F - 180°F Straight	
129074	TAS132	30°F - 240°F, Straight	
129075	TAS150	30°F - 240°F, Angle	

Industrial 9IT Solar Digital Thermometer

- Provides a solar powered digital readout
- Low light compatible
- Durable ABS case
- Vari-angle connection
- 5-Year warranty



Part #	Mfg #	Range	Price
129070	TSD9ITSD	-50°F - 320°F	

TCT Clamp-On Thermometer

- Clamp-on steel spring
- For 1/2" to 4" diameter pipe
- Features:
 - 2-1/2" Dial
 - Chrome-plated steel case
 - Plexiglass lens
 - Aluminum pointer
 - Bi-metal element
 - +/-3% Accuracy



Part #	Mfg #	Range	Price
129964	TCT167	30°F - 240°F	

Tridicator

- Measures both pressure and temperature on the same dial
- 2" Stem
- 1-Year warranty



2-1/2" Dial Size - 1/4" NPT Connection

Part #	Mfg #	Range	Conn	Price
129966	TTD404	0 - 75 psi 30°F - 240°F	Back	

3" Dial Size - 1/2" NPT Connection

Part #	Mfg #	Range	Conn	Price
129067	TTD403	0 - 75 psi 30°F - 240°F	Bottom	
129196	TTD402	0 - 75 psi 30°F - 240°F	Back	
186033	TTD405	0-200 psi 70°F-320°F	Bottom	
136488	TTD398	0 - 250 psi 60°F - 240°F	Back	

Thermowell

Part #	Mfg #	Description	Price
129808	TTW050	1/2" Brass Thermowell	

Water Service Accessories

Century® PVC Submersible Pump Cables
Flat Double Insulated Cable - 3 Conductor with Ground

- 600V



Part #	Mfg #	Size AWG/Cond	Copper Const.	Ground AWG	Insulation Thickness	Jacket Thickness	Ft/Reel	Price
003231	31712500	12/3	65 x 30	12	45mils	30mils	500'	

Water Systems

Water System Accessories

Tank Accessories

- Recommended for all cold water system installations to protect against damage to piping and pressure tanks

Field Adjustable Pressure Relief Valve

- Set at 75 psi - field adjustable to 150 psi
- PRVNL Prefix: No lead brass construction



Part #	Mfg #	Inlet x Outlet	Ctn Qty	Ctn Weight	Price
006654	PRV50	1/2" x 1/2"	10	3.5 lbs	
006655	PRV75	3/4" x 1/2"	10	3.8 lbs	

Air Valve

- Complete with valve core and plastic cap
- Provides method of injecting and holding air in pneumatic water systems
- Air valve with standard core spring



Part #	Mfg #	Size	Price
006701	SV-125	1/8"	
006702	SV-250	1/4"	

Check Valves

Merrill 800 Series Red Brass Check Valve

- Valve body and poppet assembly are cast red brass
- Abrasion resistant o-ring is precision fitted to the poppet for a positive seal into the tapered self cleaning valve seat
- Check valve has Delrin guide bearing for the poppet stem assures smooth, noise-free valve operation
- Can be used in both vertical & horizontal positions



Part #	Mfg #	Pipe Size	Approx Weight	Dia	Length	Ctn Qty	Master Ctn Qty	Price
006567	CV75	3/4"	0.57 lbs	1.43"	2.87"	7	70	
006563	CV100	1"	0.86 lbs	1.75"	3.25"	10	60	
006564	CV125	1-1/4"	1.28 lbs	2.25"	3.87"	5	40	
006565	CV150	1-1/2"	1.65 lbs	2.50"	4.25"	5	30	
006566	CV200	2"	2.89 lbs	3.12"	5.00"	4	20	

Drive Well Points & Accessories

Drive Coupling

- For threaded pipe to drive well points



Part #	Mfg #	Pipe Size	Coupling Length	Material	Approx Weight	Price
006568	DRCOUP125	1-1/4"	2-3/4"	Galv Steel	0.9 lbs	

Water Systems

Water System Accessories

Drive Point



Part #	Mfg #	Pipe Size	Coupling Length	Material	Approx Weight	Price
006570	DWP1253660S	1-1/4"	36"	60	7.5 lbs	

Drop Pipe Couplings

- For threaded pipe to submersible pump
- Chamfered ends for quick easy starting of threads
- Tapered pipe threads for positive watertight connection



Brass

Part #	Mfg #	Pipe Size	Cplg Length	Price
006552	BDC100	1"	2-1/2"	
006553	BDC125	1-1/4"	2-1/2"	

Heavy Sch 80 PVC

Part #	Mfg #	Pipe Size	Cplg Length	Price
012280	PDC100	1"	2-3/4"	

Extra Heavy Sch 120 PVC

Part #	Mfg #	Pipe Size	Cplg Length	Price
012866	PDCH125	1-1/4"	2-3/4"	

Foot Valves

Merrill 810 Series Red Brass Foot Valve

- 1-15/16" Dia Stainless steel strainer
- Valve body and poppet assembly are cast red brass
- Abrasion resistant o-ring is precision fitted to the poppet for a positive seal into the tapered self cleaning valve seat
- Check valve has Delrin guide bearing for the poppet stem assures smooth, noise-free valve operation
- Can be used in both vertical & horizontal positions



Part #	Mfg #	Pipe Size	Approx Weight	Length	Ctn Qty	Master Ctn Qty	Price
006579	FV100	1"	0.65 lbs	5.00"	10	60	
006580	FV125	1-1/4"	0.97 lbs	5.50"	5	50	

Splice Kits

Heat Shrink Tubing

- Inside adhesive in shrink tube bonds to splice

Extra Heavy Black Tubing Splice Kit

Part #	Mfg #	Tube Qty	Tubing Size	Crimp Qty	Crimp Conn	Wire Sizes	Approx Weight	Price
006556	BSKEH5033	3	1/2" x 3"	3	1014	#10 - 12 - 14	0.04 lbs	
020307	BSKEH50344	4	1/2" x 3"	4	1014	#8 - 10 - 12	0.06 lbs	

Water System Accessories

Pitless Units, Kits & Adapters

Red Brass Pitless Adapter

- Brass male part of adapter is tapered for easy connection of female and male parts
- Brass female part is tapered for tight connection and easy removal
- Replaceable o-ring seal in solid brass casing
- Molded gasket for positive outside seal on discharge, plus o-ring or gasket glued in place, for seal on inside of casing
- Solid brass collar made for perfect fit and positive seal between molded gasket to discharge and outside of casing to insure sanitary watertight seal to casing
- Extra-wide solid brass nut to accommodate wrench for easier installation



Part #	Mfg #	Drop & Discharge	Discharge Length	Casing Sizes	Will Support	Hole Saw	Approx Weight	Ctn Qty	Price
006600	MB50	1" Brass	1.8" Long Model	5" - 8"	300'	1-3/4"	2.4 lbs	4	
006598	MB125	1-1/4"	1.8" Long Model	5" - 8"	300'	2-1/16"	5.0 lbs	2	
006599	MB200	1" Brass	1.8" Long Model	5" - 8"	400'	1-3/4"	2.8 lbs	4	

Pressure Switches & Gauges

Pressure Gauge

- Suitable for air, steam and other pressure applications that will not deteriorate brass

Part #	Mfg #	Dial Size	Pressure Range	Master Conn	Description	Price
006634	PG100	2"	0-100 psi	1/4" NPT Brass	Plastic Case, Bottom-Mount	

Merrill Pressure Switch



Part #	Mfg #	Preset Settings	Price
060597	MPS2040	20/40 psig	
060599	MPS3050	30/50 psig	
060600	MPS4060	40/60 psig	

Low Water Cut-Off Pressure Switch

- Auto start, manual start or off lever



Part #	Mfg #	Preset On	Preset Off	Price
079897	MPSM43050	On @ 30 psi	Off @ 50 psi	

Water System Accessories

Class 9013 Square D Pressure Switch

- Diaphragm actuated
- Standard action: contacts open on rising pressure
- Connection: 1/4" NPSF internal

Pressure Switch for Pumping Applications



Part #	Mfg #	Cut-Out Range	Approx Adj Diff	Preset Settings	Price
006572	FSG2M420	34-65 psig	15-30 psig	20/40 psig	

Pressure Switch for Heavy Duty Pumps & Air Compressors



Part #	Mfg #	Cut-Out Range	Approx Adj Diff	Preset Settings	Approx Weight	Ctn Qty	Price
006582	GHG260	65-200 psig	20-40 psig	60/80 psig	2.25 lbs	1	

Tank Tees, Kits, & Accessories

Brass & Red Brass Fabricated Tank Tee

- No nipples included
- Rough brass
- Brass castings and Type L copper tube soldered with no lead solder



Part #	Mfg #	Tank Connection	Lateral	Overall Length	Drain Hole	Approx Weight	Price
006551	BAT125XL	1-1/4" MIP	1-1/4" MIP & 1" FIP	16"	(1) 3/4"	2.4 lbs	

Brass & Red Brass All-Cast Tank Tee

- No nipples included
- One-piece cast brass tank tees



BAT100CS



BAT1025



BAT1252

Part #	Mfg #	Tank Connection	Lateral	Overall Length	Drain Hole	Approx Weight	Price
006547	BAT100C	1" MIP	1" MIP & 3/4" FIP	11"	(2) 1/2"	2.0 lbs	
023937	BAT100CS	1" MIP	1" MIP & 3/4" FIP	5"	(2) 1/2"	1.2 lbs	
006549	BAT1025	1-1/4" MIP & 1" FIP	1" MIP & 3/4" FIP	5"	(1) 3/4"	1.4 lbs	

Water System Accessories

Tank Tees, Kits, & Accessories (Continued)

Brass & Red Brass All-Cast Tank Tee

Part #	Mfg #	Tank Connection	Lateral	Overall Length	Drain Hole	Approx Weight	Price
040899	BAT1252	1-1/4" MIP & 1" FIP	1-1/4" MIP & 1" FIP	4"	(2) 3/4"	1.7 lbs	

Brass Compact Tank Tee



Part #	Mfg #	Tank Connection	Lateral	Overall Length	Drain Hole	Approx Weight	Price
113025	BCT100	1" FIP	1" FIP	2.5"	(1) 1/2"	0.73 lbs	

Arrestors

Deluxe Torque Arrestor

- Installed directly above submersible pump
- Protects pump from starting torque damage
- Clamps 1" or 1-1/4" drop pipe and adjusts to fit 4" through 8" well casing
- Two-piece construction
- FDA Approved compounds in material



Part #	Mfg #	Description	Length	Qty	Approx Weight	Price
006700	STA48C	All Stainless Steel, Clamps Included	11-3/4"	20	1.5 lbs	

Well Seals

WS Series Cast Iron Single Drop Pipe - Split Top Plate

- 3/4" Thick rubber packer
- Painted cast iron
- Individually boxed and labeled



Part #	Mfg #	Well Size ID	Drop Pipe	Cable Tapping	Vent Tapping	Approx Weight	Price
031601	WS400100	4"	1"	1"	1/2"	3.64 lbs	

Water System Tanks

Water Systems Products

Well-X-Trol® Pressurized Diaphragm Well Tank

- 100% Non-metallic water reservoir
- Heavy-duty butyl diaphragm meets FDA requirements for potable water supply
- Rigid water reservoir is 100% corrosion resistant
- Unique diaphragm seal ring
- Stainless steel system construction
- Maximum operating temperature: 200°F
- Maximum working pressure: 150 psig
- Factory pre-charged: 38 psig
- 7-Year warranty



WX Well-X-Trol® In-Line Well Tank

Part #	Mfg #	Dia	Height	Volume	Price
012151	WX-101	8"	12-5/8"	2.0 gal	
012152	WX-102	11"	15"	4.4 gal	
012153	WX-103	11"	22-3/4"	7.6 gal	

WX Well-X-Trol® Vertical Stand Well Tank

Part #	Mfg #	Dia	Height	Volume	Price
012156	WX-202	15-3/8"	31-5/8"	20.0 gal	
012157	WX-203	15-3/8"	46-1/2"	32.0 gal	
012159	WX-250	22"	36"	44.0 gal	
012160	WX-251	22"	46-3/4"	62.0 gal	
012161	WX-302	26"	47-1/4"	86.0 gal	
012162	WX-350	26"	61-7/8"	119.0 gal	
123456	WX-500	26"	61-7/8"	500 gal	

Water Systems Accessories

Tube Hangers - 601 Series



Part #	Mfg #	Diameter	Price
227433	601-1	1/2"	
227434	601-2	3/4"	
144546	601-3	1"	
145047	601-4	1-1/4"	

Reverse Osmosis Systems

Reverse Osmosis Systems

Reverse Osmosis System

- 4-Stage
- (1) 5 Micron sediment filter
- (1) 5 Micron carbon block filter
- Produces 50 gallons per day
- (1) 6" GAC inline filter
- 3 Gallon steel water storage tank
- NSF Certified Standard 58



Part #	Mfg#	Model	Description	Price
142207	7100103	PWRO4	4-Stage	

Kwik-Change™ Reverse Osmosis System

- 4-Stage
- (1) 5 Micron sediment filter
- (1) Carbon block filter
- (1) Membrane filter
- (1) GAC Inline filter
- Produces up to 60 gallons per day
- Long reach faucet for easy fill
- Kwik-Change™ cartridges
- 1/4-Turn pivot filter head
- Space saving design installs under sink or in limited space
- Adapt-A-Valve™ easily connects to water source for 3/8" compression or 1/2" NPT
- Automatic shutoff
- 3 Gallon water storage tank
- NSF Certified Standard 58



Part #	Mfg#	Model	Description	Price
150184	7100107	PWROK4	4-Stage	

Reverse Osmosis Systems

Eclipse™ Reverse Osmosis Drinking Water System

- Designed to provide the cleanest, healthiest water possible
- Multiple filters clean ordinary household water to reduce unwanted and harmful contaminants
- System performance is verified with a touch monitor on the system's faucet base
- Installation is simple - no electricity needed



Part #	Mfg #	Description	Price
063049	WRO-35	Eclipse™ RO Unit	

Impression Series® Reverse Osmosis Drinking Water System

- Pre filter contains activated carbon that reduces chlorine and captures large particles, such as silt, rust or scale
- Membrane traps and removes particles too small for the pre filter to catch
- Dissolved solids and other contaminants are flushed out of the system
- Two final carbon filters remove any remaining tastes and odors
- Holding tank stores approximately two gallons of fresh, clean water



Part #	Mfg #	Description	Price
136684	CTFC400	50 gpd RO System	

Filters

Part #	Mfg #	Description	Price
081202	S7206W-JG	Filter	

Impression Series® Air Sulfur & Air Iron Filter

- Extremely effective in removing hydrogen sulfide and iron, commonly associated with problem well-water
- Uses a unique air-injection filtering technology to oxidize sulfur or iron into precipitates that can be readily filtered and removed
- Environmentally safe - no toxic chemicals are used

Part #	Mfg #	Mineral cu ft	Gravel Amount	Peak Flow	Total Dimensions	Price
107075	IMB-1054-ME	1.0 Birm	14 lb 1/4 x 1/8	10.0 gpm	52"H x 10"W	

Pre filter

Part #	Mfg #	Description	Price
091413	CS7028	Pre filter	
066878	CS7128X	Pre filter	

Post filter

Part #	Mfg #	Description	Price
091415	CS7025	Carbon Post Filter	
066879	CS7125X	Post Filter	

Water Conditioners

Water Conditioners

ClearWave® Water Conditioner

- *Maximum pipe diameter: 1"*
- *Maximum flow rate: 28 gpm*
- *Works without chemicals, salt or plumbing to eliminate scale build-up and prevent scale formation*



Part #	Mfg #	Volts	Watts	Amps	Price
146787	CW-125	18VAC	5	.09A	

Water Filter Cartridges

Inline Filter Cartridges

In-Line Filter for Reverse Osmosis Systems

- Connection size: 1/4" FNPT
- For residential ice makers, refrigerators, drinking fountains, coffee and tea brewers, motor homes and campers
- Final polishing filter
- Reduces bad taste and odor
- Acid wash coconut shell
- Flow rate: 0.75 gpm



Part #	Mfg#	Model	Lgth	Conn Size	Price
146805	7100453	PWILGAC6	6	1/4" FNPT	
150174	7100454	PWILGAC10	10"	1/4" FNPT	

Water Filtration System Filters

PWMEM Standard Residential RO Membrane

- 25-100 Gallon per day replacement RO membrane



Part #	Mfg#	Order #	Size	Qty	Price
153293	7100122	PWMEM50			

PWMEMKC60 Replacement Filter

- 60 Gallon per day replacement RO membrane



Part #	Mfg#	Order #	Size	Qty	Price
153294	7100125	PWMEMKC60			

Replacement Filter Kit

Part #	Mfg#	Model	Description	Price
142216	7100110	PWFPKSEDCB	Water Guard	
150181	7100111	PWFPLCV	2-Pk LCV	

Replacement Filter Kit for Kwik-Change™ Ultra Systems



Part #	Mfg#	Model	Description	Price
150179	7100116	PWFPK2KC4	4-Stage	
150183	7100118	PWFPKKCUF	3-Stage	
155993	7100462	PWKCGAC13	GAC	

Drinking Water Filtration Systems

Under Counter Water Filtration System

- 2-Stage
- (1) 5 Micron sediment filter
- (1) Carbon block filter
- Chrome faucet
- Adapt-A-Valve™
- NSF Certified Standard 58



Part #	Mfg#	Model	Description	Price
146818	7100101	PWDWLCV2	2-Stage LCV	

Kwik-Change™ Ultra Filtration Membrane Water Filtration System

- 3-Stage
- (1) 5 Micron sediment filter
- (1) Carbon block filter
- (1) UF Membrane filter
- Long reach faucet for easy fill
- Kwik-Change™ cartridges
- 1/4-Turn pivot filter head
- Space saving design installs under sink or in limited space
- Double Seal o-ring cartridges ensure system integrity
- No storage tank needed
- NSF Certified Standard 58



Part #	Mfg#	Model	Description	Price
150182	7100106	PWDWUFKC3	3-Stage	

Water Filter Cartridges

Melt Blown Filter Cartridges

10" Melt Blown Filter Cartridge

- For standard filter housings
- 2-1/2" OD x 9-7/8" Length
- Reduces dirt, sediment, rust and particles
- Food grade for use with beverages, food and potable water



Part #	Mfg#	Model	Size	Micron Rating	Price
146819	7100331	PWMB10M5	10"	5 Mic	
150170	7100335	PWMB10M50	10"	50 Mic	

20" Melt Blown Filter Cartridge

- For standard filter housings
- 2-1/2" OD x 20" Length
- Reduces dirt, sediment, rust and particles
- Food grade for use with beverages, food and potable water



Part #	Mfg#	Model	Size	Micron Rating	Price
154627	7100337	PWMB20M5	20"	5 Mic	

20" Melt Blown Filter Cartridge for Full-Flow Filter Housings

- For full flow filter housings
- 4-1/2" OD x 20"
- Reduces dirt, sediment, rust and particles
- Food grade for use with beverages, food and potable water



Part #	Mfg#	Model	Size	Micron Rating	Price
148591	7100353	PWMB20FFM5	20"	5 Mic	

String Wound Filter Cartridges

10" String Wound Filter Cartridge

- For standard filter housings
- 2-1/2" OD x 9-7/8" Length
- Reduces dirt, sediment, rust and particles
- Food grade for use with beverages, food and potable water



Part #	Mfg#	Model	Size	Micron Rating	Price
146815	7100357	PWSW10M5	10"	5 Mic	

String Wound Filter Cartridges (Continued)

10" String Wound Filter Cartridge

Part #	Mfg#	Model	Size	Micron Rating	Price
146816	7100359	PWSW10M50	10"	50 Mic	

20" String Wound Filter Cartridge

- Low cost
- Food grade ingredients for potable water
- No leachables to contaminate downstream
- Wide range of lengths and micron ratings
- Cartridges with stainless steel center tubes for higher temperature applications



Part #	Mfg#	Model	Size	Micron Rating	Price
158535	7100375	PWSWB20FFM520"		5 Mic	

10" Big Blue String Wound Filter Cartridge

- For standard filter housings
- 4-1/2" OD x 9-3/4" Length
- Reduces dirt, sediment, rust and particles
- Food grade for use with beverages, food and potable water



Part #	Mfg#	Model	Size	Micron Rating	Price
148020	7100349	PWSW10BBM5	10"	5 Mic	

Pleated Filter Cartridges

10" Pleated Filter Cartridge

- For standard filter housings
- 2-3/4" OD x 9-3/4" Length
- Reduces dirt, sediment, rust and particles



Part #	Mfg#	Model	Size	Micron Rating	Price
146814	7100387	PWPL10M1AB	10"	1AB Mic	
146811	7100391	PWPL10M20	10"	20 Mic	
148792	7100392	PWPL10M50	10"	50 Mic	

Water Filter Cartridges

10" Big Blue Pleated Filter Cartridge

- For standard filter housings
- 4-1/2" OD x 9-3/4" Length
- Reduces dirt, sediment, rust and particles



Part #	Mfg#	Model	Size	Micron Rating	Price
153732	7100410	PWPL10FFM5	10"	5 Mic	
150172	7100411	PWPL10BBM20	10"	20 Mic	
148800	7100412	PWPL10BBM50	10"	50 Mic	

20" Big Blue Pleated Filter Cartridge

- For standard filter housings
- 4-1/2" OD x 20" Length
- Reduces dirt, sediment, rust and particles



Part #	Mfg#	Model	Size	Micron Rating	Price
170037	7100417	PWPL20FFM20	20"	20 Mic	

Carbon Filter Cartridges

Big Blue Water Washed Coconut Shell Granular Activated Carbon Cartridge

- Minimum working pressure: 20 psi
- Maximum working pressure: 125 psi



Part #	Mfg#	Model	Description	Price
146812	7100444	PWGAC10BB	4-1/2" x 9-3/4"	

Premium Carbon Block Filter Cartridge

- Maximum working pressure: 125 psi
- Mincron rating: 5 Mic
- Low-pressure drop
- 100% coconut shell carbon
- Up to 90% chlorine reduction



Part #	Mfg#	Model	Description	Price
146813	7100446	PWCB10P	2-1/2" x 9-3/4"	

Big Blue Premium Carbon Block Filter Cartridge

- Maximum working pressure: 125 psi
- Mincron rating: 5 Mic
- Low-pressure drop
- 100% coconut shell carbon
- Up to 90% chlorine reduction



Part #	Mfg#	Model	Description	Price
150163	7100448	PWCB10BBP	4-1/2" x 9-3/4"	
150173	7100449	PWCB20BBP	4-1/2" x 20"	

Carbon Block Filter Cartridge

- 2-1/2" OD x 10" Length



Part #	Mfg#	Model	Description	Price
146820	7100451	PWCB10LCV	Lead, Cysts, VOC	

Water Washed Coconut Shell GAC Replacement Cartridge

- Granular Activated Carbon (GAC)
- 2-3/4" OD x 9-3/4"



Part #	Mfg#	Model	Description	Price
146803	7100442	PWGAC10	10"	

Water Treatment

Water Filter Cartridges

Filter Housings

Individual Boxed Plastic Housing

- Heavy-duty construction, made using high-quality FDA grade polypropylene
- Superior chemical resistance from many aggressive chemicals
- Buttress thread design for superior security
- Thick side walls with heavy-duty ribs to provide greater strength
- Temperature rated to 125°F (52°C)
- Cap, sump and top-seated o-rings compress to provide leak proof sealing



Part #	Mfg#	Model	Description	Price
146807	7100267	PWHIB34VIH	10" Valve-In-Head	
150178	7100268	PWHIB10BB	10" Big Blue	
150176	7100269	PWHIB20BB	20" Big Blue	

Clear Filter Cartridge Housing

- White cap



Part #	Mfg#	Model	Description	Price
146804	7100275	PWHP1034CPR	3/4" x 10"	

Big Blue Filter Cartridge Housing

- For 4-1/2" OD cartridges
- Black cap



Part #	Mfg#	Model	Description	Price
146810	7100287	PWHP10BB1B	1" x 10"	
150161	7100288	PWHP10BB1BPR	1" x 10"	

Filter Housing Bracket

- Heavy duty steel
- 10" x 20"



Part #	Mfg#	Model	Description	Price
146806	7100463	PWMBSTD1	Standard Single	
153730	7100466	PWMBFF1	Full Flow Single	

Filter Housing Wrench



Part #	Mfg#	Model	Description	Price
146809	7100298	PWWRSTDHSG	Standard	
153159	7100299	PWWRFFHSG	Full Flow	

Water Filter Cartridges

Housings

Slim Line® Housing

- 3/8" NPT Inlet/outlet
- Pressure relief button
- WMB38 Mounting bracket included
- 4-1/2" Diameter
- Cartridge not included



Part #	Mfg #	Model #	Description	Price
001138	152007	W385-PR	Gray, 7" Long	

Standard Housing

- 3/4" NPT Inlet/outlet
- Pressure relief button
- Accepts a wide variety of 2-1/2" to 3" diameter cartridges
- 12-1/4" x 5-1/8" Overall dimensions
- Cartridge not included



Part #	Mfg #	Model #	Description	Price
001109	152018	WC34-PR	Clear	

Valve-In-Head Housing

- Closes both the inlet & outlet port simultaneously w/half turn of the handle
- 3/4" NPT inlet/outlet
- Pressure relief button
- Accepts a wide variety of 2-1/2" to 3" diameter cartridges
- 12-1/4" x 5-1/4" Overall dimensions



Part #	Mfg #	Model #	Description	Price
001120	152003	WVC34	Clear	

Heavy-Duty Housing

- Large capacity housing designed for whole house & high-flow applications
- Pressure relief button
- Accepts large capacity 4-1/2" diameter cartridges
- Cartridge not included



Part #	Mfg #	Model #	Sump	I/O NPT	Price
001126	152014	W10-PR	Gray	1"	

Housing Parts & Accessories

Standard Housing Bracket

- For 3/4" housings
- Kit includes bracket & screws
- Constructed of zinc-plated steel



Part #	Mfg #	Model #	Use With:	Price
001117	152040	WMB34	3/4" Inlet/Outlet	

Heavy-Duty Housing Bracket

- For 3/4" housings
- Kit includes bracket & screws
- Constructed of zinc-plated steel



Part #	Mfg #	Model #	Use With:	Price
023980	150061	WMB20	For 10" or 20" HD Housing	

Spanner Wrench

- Use to loosen sump when changing cartridges



Part #	Mfg #	Model #	Use With:	Price
001123	152037	WW34	3/4" Std & Valve-In-Head	
001122	152039	WWHD	1" & 1-1/2" HD 10" Opaque	

Sediment Cartridges

Spun Polypropylene Sediment Cartridge

- Manufactured from pure 100% polypropylene
- Spun fibers provide a gradient density from the outer surface to inner core
- High dirt-holding capacity and superior sediment filtration
- Excellent bacteria and chemical resistance
- Dimensions: 2-3/8" Dia x 9-7/8" Length



Part #	Mfg #	Model #	Micron Rating	Max Flow Rate	Price
001141	155014-52	W5P	5	10 gpm	

Water Treatment

Water Filter Cartridges

Pleated Cellulose Sediment Cartridge

- Economically priced
- Pleated design maximizes dirt-holding capacity
- Nominal 5-micron rating for cellulose/polyester cartridges
- Designed for municipal/chlorinated water
- Good for general purpose filtration
- Dimensions: 2-5/8" Dia x 9-3/4" length



Part #	Mfg #	Model #	Micron Rating	Max Flow Rate	Price
001129	155001-52	W20CLA	20	12 gpm	

Carbon Impregnated Cellulose Cartridge

- Economically priced
- Dual purpose cartridge provides bad taste/odor/chlorine: taste and odor reduction as well as sediment filtration
- Design maximizes dirt holding capacity
- For municipal/chlorinated water
- Recommended for point of use filtration



Part #	Mfg #	Model #	Max Flow Rate	Length	Price
002022	155022-52	W5CIP478	1 gpm	4-7/8"	
001139	155002-52	W5CIP	5 gpm	9-3/4"	

Pleated Cellulose Heavy-Duty Cartridge

- Economically priced
- Pleated design maximizes dirt-holding capacity
- Nominal 5-micron rating for cellulose/polyester cartridges
- Designed for municipal/chlorinated water
- Good for general purpose filtration
- Dimensions: 4-1/2" Dia x 9-3/4" length



Part #	Mfg #	Model #	Micron Rating	Max Flow Rate	Price
001140	155184-51	W5CPHD	5	20 gpm	

Granular Activated Carbon (GAC) Cartridge

- Effective taste/odor/chlorine, taste & odor reduction
- Cartridge design ensures that water passes through entire length of the carbon bed maximizing contact time
- Nominal 20-micron post filter reduces carbon fines and suspended carbon



Part #	Mfg #	Model #	Max Flow Rate	Length	Price
001108	155155-51	WCC	1 gpm	9-3/4"	

Taste & Odor Cartridges

Radial Flow Carbon Cartridge

- Ideal for whole house & other high flow rate applications
- Unique design & nominal 25-micron inner wrap reduces carbon fines
- Effectively reduces bad taste, odor & chlorine
- Granular activated carbon
- 4-1/2" Diameter



Part #	Mfg #	Model #	Max Flow Rate	Length	Price
001119	155141-51	WRC25HD	3 gpm	9-3/4"	

Refrigerator/Ice Maker Filters

Quick-Connect Inline Filter

- Ideal for refrigerator ice makers & water dispensers, coffee makers & other in-line applications
- Granular activated carbon removes chlorine, taste & odor, bad taste & odor from water
- WICS Includes phosphate crystals to prevent lime/scale build-up
- Quick-connect fittings attach easily to 1/4" copper or plastic cold water lines
- Pressure rated to 125 psi, polyester pre- & post-filters



Part #	Mfg #	Model #	Description	Price
001115	155083-51	WICSA	2" Dia x 10" L	

Water Filter Cartridges

Drinking Water Systems

DW-600 Quick-Change Under-Sink Drinking Water System

- 1/4" Comp Inlet/outlet
- Works with copper, plastic or flex tubing
- Capacity: 500 gal
- 3" x 3" x 13.5"
- 0.5 Micron reduces lead, cysts, Lindane, Atrazine, chlorine taste & odor, sediment



Part #	Mfg #	Model #	Description	Price
146322	155785-51	600R	Cartridge	

Water Treatment

Water Softeners

Impression® Series Water Conditioners

- Specifically designed to effectively treat a multitude of water problems
- Flexible adjustable cycle sequence programming - saves salt and water
- Advanced history and diagnostic screens
- Extended lithium battery backup

Impression Series® Metered Water Conditioner

- Monitors and self-adjusts regeneration cycles based on household trend of water consumption
- Features an optional weather cover for outdoor installations



Part #	Mfg #	Max Capacity (Grains/Lbs NaCl)	Peak Flow Rate (GPM @ P-PSI)	Media (Cu Ft)	Dimensions		Price
					Media Tank	Brine Tank	
073582	IM-844ME	25,600 @ 9.0	11.4 @ 15.0	0.85	52"H x 8"W	33"H x 18"W	
065079	IM-1044ME	32,000 @ 15.0	17.1 @ 15.0	1.0	52"H x 10"W	33"H x 18"W	
068733	IM-1054ME	48,800 @ 21.0	14.3 @ 15.0	1.5	62"H x 10"W	40"H x 18"W	
066032	IM-1354ME	72,800 @ 24.0	18.5 @ 15.0	2.5	62"H x 13"W	40"H x 18"W	
125944	IMC-1035	32,000 @ 15.0	17.1 @ 15.0	1.0	42.5"H x 13.5"W	-	

Impression Series® RC Water Conditioner

- Unique "mid-plate" design allows the use of activated carbon and high capacity resin in one tank
- Removes hardness
- Removes chlorine and associated odors
- Softens household water using minimal salt and water

Part #	Mfg #	Max Capacity (Grains/Lbs NaCl)	Peak Flow Rate (GPM @ P-PSI)	Resin Media (Cu Ft)	Carbon Media (Cu Ft)	Dimensions		Price
						Media Tank	Brine Tank	
144557	IM-RC1054	32,000 @ 15.0	15.6 @ 15.0	1.0	0.5	62"H x 10"W	33"H x 18"W	

Sanitizer Plus Series® Water Conditioners

- Exclusive Crystal-Right™ media to remove hardness, iron and manganese, correct pH and control odor
- Patented self-chlorinator technology for bacteria control
- Single unit operation - no chemicals or added equipment
- Visual and audible "Check Salt" indicator
- Extended lithium battery backup
- Flexible "adjustable cycle sequence" programming - saves salt and water
- Features an optional weather cover for outdoor installations
- MP Suffix = preloaded Min-Plus mineral pack



Part #	Mfg #	Max Capacity (Grains/Lbs NaCl)	Peak Flow Rate (GPM @ P-PSI)	Media (Cu Ft)	Dimensions		Price
					Media Tank	Brine Tank	
144566	ASP213540002	60,300 @ 26.5	19 @ 15.0	2.5	62"H x 13"W	40"H x 18"W	
066034	ASP21054ME	34,800 @ 15.9	17 @ 15.0	1.5	62"H x 10"W	33"H x 18"W	
070400	ASP21054MEMP	60,300 @ 26.5	19 @ 15.0	2.5	62"H x 13"W	40"H x 18"W	
066803	ASP21354MEMP	34,800 @ 15.9	17 @ 15.0	1.5	62"H x 10"W	33"H x 18"W	

Water Softeners

Water Softener Systems

Series Pro SE Water Softener

- Drain line connection: 1/2" NPT
- Maximum flow rate: 15.5 gpm
- Complete whole house water treatment system
- Computer programming increases efficiency, save salt and water
- Uses downflow regeneration
- Demand regeneration
- 5 Fully adjustable cycles
- Weather resistant enclosures
- Full flow bypass valve included



Part #	Mfg#	Model	Description	Price
150185	7100140	PWSPSE45K	45K	

Water Softeners

Electric Water Softeners

Water-King WK-1 Electric Water Softener

- *Designed to meet the needs of an individual or small family with a home of 1,000 sq ft or less*
- *Transmits a series of low-frequency random sequenced radio waves ranging from 1 to 10kHz, pre-selected and controlled by micro-chip technology*
- *110V Power source is transformed to 12-18V and draws a maximum of 800mA with an antenna transmission of .75W*
- *Includes 110/9V CSA/UL approved transformer*



Part #	Mfg #	Description	Price
148094	WK-1	Water Softener	



Water Treatment Chemicals

Pellet Salt

Part #	Mfg #	Description	Price
009801	SALT50LBP	50 lb	

Water Treatment



Water Treatment Chemicals

Pellet Salt

Part #	Description	Price
009802	50# Bag Solar Salt	

Water Treatment



Miscellaneous Water Works

Chrome Supply Stops

Utility Vent

- Double outlet design
- Non-potable
- Ideal for use in industrial applications or with traffic control signals
- Iron body, brass screens
- FNPT end connections



Part #	Mfg #	Size	Price
002243	908	1"	

Insert Stiffeners

Stainless Steel Insert Stiffener for Polyethylene Tubing



Part #	Mfg #	Size	Price
041161	6133T	3/4"	
041162	6133T	1"	
112644	6133T	1-1/4"	
112643	6133T	1-1/2"	
107690	6133T	2"	

Water Meters

T-10 Meters

- Register
 - Magnetic drive, low torque registration
 - Impact-resistant register
 - High resolution, low flow leak detection
 - Bayonet style register mount
 - Tamperproof seal pin deters theft
- EnviroBrass™ II maincase
 - Lifetime guarantee
 - Resists internal pressure stresses & external damage
 - Handles in-line piping variations & stresses
 - Electrical grounding continuity
- Nutating disc measuring chamber
 - Positive displacement
 - Widest effective flow range for maximum revenue
 - Proprietary polymer materials
 - Floating chamber design is unaffected by meter position or in-line piping stresses



Water Works

Part #	Mfg #	Description	Price
007737	T-10	5/8" Pro-read Cu ft Meter 2bd	
007736	T-10	3/4" Pro-read Cu ft Meter 2bd	
007734	T-10	1" Pro-read Cu ft Meter 2bd	
007735	T-10	1-1/2" Pro-read Cu ft Meter 2bd	
047865	T-10	2" Pro Read Cu ft Meter 2bd	

T-10 Parts

Part #	Mfg #	Description	Price
053553	FLG200	2" Bronze Flange Set	



Water Meters

Meter Valves

Angle Plug Lockwing (Fir x Meter)



Part #	Mfg #	Size	Price
157388	74602	3/4"	
157389	74602	1"	
157390	74602	1" x 3/4"	

Angle Plug Lockwing (CTS xMeter)

Part #	Mfg #	Size	Price
158238	74602-22	1"	
160116	74602-22	1" x 3/4"	

Straight Meter Coupling with Hole (Swivel x MNPT)

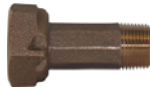

Part #	Mfg #	Size	Price
157385	74620	5/8"	
156330	74620	5/8" x 3/4"	
157386	74620	3/4"	
157387	74620	1"	

Rubber Meter Gasket



Part #	Mfg #	Size	Price
025319	18-G1	5/8"	
025320	18-G2	5/8" x 3/4" or 3/4"	
043554	18-G4	1"	

Water Works



Water Service Fittings

Water Works

Couplings for 3121 Corporation Valves 1/4 Bend - Increasing (FIP x Cpr Flr)

- With swivel nut & gasket included



Part #	Mfg #	Size	Price
156315	74783S	3/4"	

Couplings for Corporation Valves with MIP Outlets

MIP Outlets - Straight (IPS Comp - PVC x FIP)

- With 4700-44 compression nut



Part #	Mfg #	Size	Price
156394	74754-44	1"	

Couplings for 3121 Corporation Valves & Corporation Valves with MIP Outlets Straight Coupling (Cpr Flr x FNPT)

- With 4700 tube nut, no gasket



Part #	Mfg #	Size	Price
157374	74754	3/4"	
157379	74754	1" x 3/4"	
157380	74754	1"	
156319	74754	1-1/4"	

MIP Outlets - Straight (CTS Tube Comp x FIP)

- With 4700-22 compression nut



Part #	Mfg #	Size	Price
156371	74754-22	3/4"	
156380	74754-22	1"	
156384	74754-22	1-1/4"	
156387	74754-22	1-1/2"	
156390	74754-22	2"	

Couplings for Corporation Valves with Copper Flare Outlets

Cpr Flr Outlets - Straight Fixed Nut (Cpr Flr x Flr Nut Thrd)



Part #	Mfg #	Size	Price
156324	74755	1" x 3/4"	
156323	74755	1"x1-1/4"	

Cpr Flr Outlets - Fixed Nut - 1/4 Bend (Flr Nut Thrd x CTS Tube Comp)



Part #	Mfg #	Size	Price
156365	74776-22	3/4"	
156377	74776-22	1"	

Cpr Flr Outlets - Straight Fixed Nut (CTS Tube Comp x Flr Nut Thrd)



Part #	Mfg #	Size	Price
157409	74755-22	1"	

Cpr Flr Outlets - Straight Fixed Nut (FNPT x Fem Cpr Flr Thrd)



Part #	Mfg #	Size	Price
214238	74755F	3/4"	

Flare & Compression Nut Couplings Straight Coupling (Flr x MNPT)



Part #	Mfg #	Size	Price
157373	74753	3/4"	
157378	74753	1"	
156318	74753	1-1/4"	



Water Service Fittings

Flare & Compression Nut Couplings (Continued)

Straight Coupling (Flr x MNPT)

Part #	Mfg #	Size	Price
156325	74753	1-1/2"	
156326	74753	2"	

Straight Coupling (Tube Comp x MNPT)



Part #	Mfg #	Size	Price
156342	74753T	3/4"	

Straight Coupling (Q CTS Comp x MNPT)



Part #	Mfg #	Size	Price
156404	74753Q	3/4"	
156401	74753Q	1"	

Straight Coupling (CTS Comp x MNPT)



Part #	Mfg #	Size	Price
224542	74753-22	1/2"	
157403	74753-22	3/4"	
157407	74753-22	1"	
156382	74753-22	1" x 3/4"	
156386	74753-22	1-1/2"	
156389	74753-22	2"	

Straight Coupling (PVC x MNPT)



Part #	Mfg #	Size	Price
224543	74753-44	3/4"	

Three-Part Straight Coupling (Copper Flr x X-Strong Lead Comp)



Part #	Mfg #	Size	Price
156399	74758C-67	3/4"	

Three-Part Straight Coupling (CTS x X-Strong Lead Comp)

• Lead pak fitting



Part #	Mfg #	Size	Price
156397	74758-22-67	3/4"	
156398	74758-22-67	1"	
156396	74758-22-67	3/4" x 5/8"	

Water Works



Water Service Fittings

Water Works

Female Flare Couplings for Copper Flare Outlets

1/4 Bend - Swivel Nut
(Female Flare x Flare)



Part #	Mfg #	Size	Price
157377	74776S	1"	

1/4 Bend - Swivel Nut
(Female Flare x CTS Compression)



Part #	Mfg #	Size	Price
156316	74776S-22	1"	

No-Lead Elbows

1/4 Bend (Flr x MNPT)



Part #	Mfg #	Size	Price
157376	74779M	3/4"	
156322	74779M	1"	

1/4 Bend (CTS x MNPT)



Part #	Mfg #	Size	Price
156363	74779M-22	3/4"	
156376	74779M-22	1"	

1/4 Bend (CTS x CTS)



Part #	Mfg #	Size	Price
224545	74761-22	2"	



Water Service Tees

Tees

Flare Tees (Flr x Flr x Flr)

- Lead Free



Part #	Mfg #	Size	Price
156314	74760	3/4"	
156320	74760	1"	

Tee (Q CTS x Q CTS x MNPT)

- Lead Free



Part #	Mfg #	Size	Price
224546	74762Q	3/4"	



Water Service Unions

Water Works

Flare & Compression Nut Unions

Straight Coupling
(Q CTS Comp x Fem Cpr Flr Thrd)

- Lead free



Part #	Mfg #	Size	Price
156402	74755Q	3/4"	
156406	74755Q	1"	

Two-Part Union (Female Flr x Flr)

- Lead free



Part #	Mfg #	Size	Price
156407	74756	1"	

Three-Part Union (Coupling Flr x Flr)

- Lead free



Part #	Mfg #	Size	Price
157375	74758	3/4"	
157383	74758	3/4" x 1"	
157381	74758	1"	
157382	74758	1-1/4"	
157384	74758	2"	

Three-Part Union (Coupling-Q CTS x Q CTS)

- Lead free



Part #	Mfg #	Size	Price
157413	74758Q	3/4"	
156403	74758Q	3/4" x 1"	
157410	74758Q	1"	
157420	74758Q	1-1/4"	
157419	74758Q	1-1/2"	

Three-Part Union (Coupling CTS x CTS)

- Lead free



Part #	Mfg #	Size	Price
157404	74758-22	3/4"	
157408	74758-22	1"	

Flare & Compression Nut Unions (Continued)

Three-Part Union (Coupling CTS x CTS)

Part #	Mfg #	Size	Price
157405	74758-22	3/4" x 1"	
156385	74758-22	1-1/4"	
156388	74758-22	1-1/2"	
156391	74758-22	2"	

Three-Part Union (Coupling CTS x PVC)

- Lead free



Part #	Mfg #	Size	Price
156340	74758-22-44	1"	
224544	74758-22-44	2"	



Water Service Stops

Regular Pattern - Curb Stop Ball Valves

• 300 psig Water

Flathead (Flr x Flr)



Part #	Mfg #	Inlet x Ball Size x Outlet	Price
157396	76100	3/4"	
157397	76100	1"	
156332	76100	1-1/2"	
156334	76100	2"	

Flathead (CTS Tube Comp x CTS Tube Comp)



Part #	Mfg #	Inlet x Ball Size x Outlet	Price
156354	76100-22	1"	
156393	76100-22	1-1/4"	
156356	76100-22	1-1/2"	

Flathead (FIP x FIP)



Part #	Mfg #	Inlet x Ball Size x Outlet	Price
157398	76101	3/4"	
157399	76101	1"	

Flathead (Flr x FIP)



Part #	Mfg #	Inlet x Ball Size x Outlet	Price
156339	76102	3/4"	

Flathead (CTS x FNPT)

• Ball style- curb stop



Part #	Mfg #	Size	Price
224554	76102-22	1"	

Minneapolis Pattern - Curb Stop Ball Valves

• 300 psig Water

Flathead (Flr x Flr)



Part #	Mfg #	Inlet x Ball Size x Outlet	Price
157402	76104	3/4"	
156346	76104	1"	
156336	76104	2"	

Flathead (CTS Tube Comp x CTS Tube Comp)



Part #	Mfg #	Inlet x Ball Size x Outlet	Price
156353	76104-22	3/4"	
156355	76104-22	1"	

Flathead (FNPT x FNPT)



Part #	Mfg #	Inlet x Ball Size x Outlet	Price
157400	76105	3/4"	
157401	76105	1"	
157391	76105	2"	

Regular Pattern - Curb Stop Inverted Plug Stop with Check (FNPT x FNPT)

• Lead free



Part #	Mfg #	Size	Price
156308	73061	1"	

Water Works



Water Service Stops

Water Works

Inverted Stop with Check (Flr x Flr)



Part #	Mfg #	Size	Price
164329	74713	3/4"	
156310	74713	1"	

Inverted Curb Stop with Check (Q CTS x Q CTS)

- Lead free



Part #	Mfg #	Size	Price
156405	74713Q	3/4"	

Regular Pattern-Ball Valves-Thread

Ball Valve Stop & Drain (FNPT x FNPT)

- Lead free



Part #	Mfg #	Size	Price
156348	76001	3/4"	
156349	76001	1"	
224547	76001	1-1/2"	
224549	76001	2"	

Curb Boxes

Arch Style-Erie Pattern - 1" Upper Less Rod



Part #	Mfg #	Size	Description	Price
028959	5601LR	5"		
044727	5601LR	5-1/2"		
054762	5601LR	6"		

Arch Style Curb Box - Erie Pattern - 1" Upper with Rod



Part #	Mfg #	Size	Rod	Price
002214	5601	5'	5660 42"	

Curb Boxes (Continued)

Arch Style Curb Box - Erie Pattern - 1" Upper with Rod

Part #	Mfg #	Size	Rod	Price
002215	5601	6'	5660 54"	
002216	5603	5'	5674 42"	
002217	5603	6'	5674 54"	

Minneapolis Style Base Tapped 1-1/2"

- 1-1/4" Upper section (Less rod)



Part #	Mfg #	Size	Price
002221	5614	5'	
002222	5614	6'	

Minneapolis Style Base Tapped 2"

- 1-1/4" Upper section (Less rod)



Part #	Mfg #	Size	Price
002223	5615	5'	
002224	5615	6'	

Shut-Off Rod - Small Key - 5/8" Rod



Part #	Mfg #	Size	Price
002228	5660	54"	
002229	5660	60"	

SS Stationary Rod - Small Key - 1/2" Rod



Part #	Mfg #	Size	Price
095434	5660SS	36"	
108986	5660SS	42"	
024197	5660SS	48"	

SS Cotter Pin for Shut-Off



Part #	Mfg #	Size	Price
111797	5660SSCP	1-1/2" Long	

Curb Box Shut-Off Rod - 5/8" Large Key

Part #	Mfg #	Size	Price
029508	5674	42"	



Water Service Stops

Bottom Section Screw Style Arch Pattern Service Box



Part #	Mfg #	Size	Price
096310	5700B	40"	

Top Section Screw Style with Lid



Part #	Mfg #	Size	Price
097755	5700T	30"	

Stationary Rod

Part #	Mfg #	Size	For	Price
002226	4510-235	42"	5660 Curb Boxes	
002227	4510-238	48"	5660 Curb Boxes	

Curb Box Key

- Slotted key fits top of all shut-off rods
- Spanner wrench end fits 5601L lid
- Pentagon wrench fits 5607L, 5614L, 5623L, 5624L, 5627L lids



Part #	Mfg #	Size	Price
002148	304B	3'	
002149	304B	4'	
021276	AY304B72	6'	

Pentagon Key

- Fits 5607L, 5614L, 5623L, 5624L and 5627L lids



Part #	Mfg #	Description	Price
020689	304K	Ductile Iron Pentagon Key	
002212	5601L	1"	

1" Curb Box Plug Type Lid

- Includes pentagon plug



Part #	Mfg #	Size	Price
071805	5607L	1"	

1-1/4" Curb Box Plug Type Lid

- Includes pentagon plug



Part #	Mfg #	Size	Price
049280	5614L	1-1/4"	

Screw Top Lid

- For 2-1/2" service box



Part #	Mfg #	Description	Price
096311	5700L	Water	

Screw Style-Service Box Extension



Part #	Mfg #	Size	Price
096312	5700SE	9"	
096313	5700SE	16"	

Curb Box Repair Coupling

- Fits 1", 1-1/4", 1-1/2", & 2" iron pipe
- Stainless steel bolts
- Cast iron body



Part #	Mfg #	Size	Price
139618	5601TRS	1"	



Water Service Stops

Water Works

Curb Box-Anchor Bolt



Part #	Mfg #	Description	Price
130624	5627AB	Anchor Bolt	

Corporation Stops Plug Valve (AWWA x Cpr Flr)



Part #	Mfg #	Size	Price
156305	74701	5/8" x 3/4"	
156317	74701	3/4"	
157372	74701	1"	
156306	74701	1-1/4"	
156307	74701	2"	

Plug Style Corporation Stop (AWWA/CC x Q CTS Comp)



Part #	Mfg #	Size	Price
157418	74701Q	1"	

Plumbing/Water Valves Angle Stop & Waste Valve (Copper Flr x FIP)

- Lead Free



Part #	Mfg #	Size	Price
157496	5420-081	3/4" x 1/2"	
157495	5420-080	1" x 1"	

Series 72080C Quarter Turn Supply Stop

- Lead free
- Straight
- Comp x Comp



Part #	Mfg #	Size	Price
159854	5421-235	5/8" OD x 3/8" OD	

Quarter Turn Expansion PEX Supply

- Series 7208UP
- Lead Free
- Expansion PEX x COM



Straight

Part #	Mfg #	Size	Price
225745	72080UP	1/2" x 3/8"	

Angle

Part #	Mfg #	Size	Price
225746	72082UP	1/2" x 3/8"	

Whirlpools

Alcove Whirlpools

7236 Three-Wall Alcove Hourglass Shaped Whirlpool with Integral Flange

- *ExoCrylic*
- (6) *Individually adjustable ProFlex® hydro-massage jets*
- *Molded lumbar supports and armrests*
- *Pump with air switch and grounding-type plug-in cord*
- *3-Sided tile flange, less apron*
- *6-foot length*
- *UL Listed*
- *Faucet and drain sold separately*
- *(-H) Integral heater*



Part #	Mfg #	Description	Capacity	Color	Price
072446	K-1157-L-0	72" x 36" x 20-1/8", Left Hand Drain 3T	75 Gal	White	
072447	K-1157-L-96	72" x 36" x 20-1/8", Left Hand Drain 3T	75 Gal	Biscuit	
109253	K-1157-LH-0	72" x 36" x 20-1/8", Left Hand Drain 3T with Inline Heater	75 Gal	White	
072449	K-1157-R-0	72" x 36" x 20-1/8", Right Hand Drain 3T	75 Gal	White	
072450	K-1157-R-96	72" x 36" x 20-1/8", Right Hand Drain 3T	75 Gal	Biscuit	
167799	K-1157-RH-0	72" x 36" x 20-1/8", Right Hand Drain 3T with Inline Heater	75 Gal	White	

Archer® Three-Wall Alcove Whirlpool Bath

- *Acrylic*
- (8) *Color-matched Kohler® hydro-massage jets*
- *Integral tile flange and lumbar support & armrests*
- *Pump with air switch and grounding-type plug-in cord*
- *Comfort Depth®*
- *Slotted overflow*
- *(-A) Integral apron*
- *(-H) Integral heater*
- *(-W) Bask™ heated surface*
- *(-19) ExoCrylic™ material*



Whirlpools

Part #	Mfg #	Description	Capacity	Color	Price
125614	K-1122-HL-0	60" x 32" x 19", Left Hand Drain with Inline Heater	58 Gal	White	
125135	K-1122-HL-96	60" x 32" x 19", Left Hand Drain with Inline Heater	58 Gal	Biscuit	
126197	K-1122-HR-0	60" x 32" x 19", Right Hand Drain with Inline Heater	58 Gal	White	
111331	K-1122-LA-0	60" x 32" x 19", Left Hand Drain	58 Gal	White	
116507	K-1122-LA-96	60" x 32" x 19", Left Hand Drain	58 Gal	Biscuit	
168040	K-1122-LA-NY	60" x 32" x 19", Left Hand Drain	58 Gal	Dune	
110288	K-1122-RA-0	60" x 32" x 19", Right Hand Drain	58 Gal	White	
150553	K-1122-RA-47	60" x 32" x 19", Right Hand Drain	58 Gal	Almond	
136361	K-1122-RA-96	60" x 32" x 19", Right Hand Drain	58 Gal	Biscuit	
153627	K-1122-RA-G9	60" x 32" x 19", Right Hand Drain	58 Gal	Sandbar	
120935	K-1124-HL-0	72" x 36" x 19", Left Hand Drain with Inline Heater	72 Gal	White	
125718	K-1124-HR-0	72" x 36" x 19", Right Hand Drain with Inline Heater	72 Gal	White	
159646	K-1124-HR-96	72" x 36" x 19", Right Hand Drain with Inline Heater	72 Gal	Biscuit	
141884	K-1124-LA-0	72" x 36" x 19", Left Hand Drain	72 Gal	White	
223612	K-1124-LAW-96	72" x 36" x 19", Left Hand Drainw/ Bask	72 Gal	Biscuit	

Whirlpools

Alcove Whirlpools (Continued)

Archer® Three-Wall Alcove Whirlpool Bath

Part #	Mfg #	Description	Capacity	Color	Price
120903	K-1124-RA-0	72" x 36" x 19", Right Hand Drain	72 Gal	White	
130508	K-1124-RA-96	72" x 36" x 19", Right Hand Drain	72 Gal	Biscuit	
190188	K-1947-LA-96	60" x 30" x 19", Left Hand Drain, ExoCrylic	57 Gal	Biscuit	
166400	K-1947-RA-0	60" x 30" x 19", Right Hand Drain, ExoCrylic	57 Gal	White	
169880	K-1947-RA-G9	60" x 30" x 19", Right Hand Drain, ExoCrylic	57 Gal	Sandbar	
227162	K-1947-HLA-96	60" x 30" x 19", LH Drain with Inline Heater, ExyCrylic	66 Gal	Biscuit	
169279	K-1949-HLA-47	66" x 32" x 19", LH Drain with Inline Heater, ExyCrylic	66 Gal	Almond	
179478	K-1949-LA-0	66" x 32" x 19", Left Hand Drain, ExoCrylic	66 Gal	White	

Bancroft® Alcove Single Speed Whirlpool

- Acrylic
- Integral flange
- (8) Fully adjustable ProFlex® hydro-massage jets
- Pump with air switch
- Integral lumbar support.
- Textured bottom surface
- Integral apron with removable access panel
- Drain sold separately
- (-H) Built-in heater



Part #	Mfg #	Description	Capacity	Color	Price
132779	K-1151-HR-0	60" x 32" x 19", Right Hand Drain, Heater	White		
114683	K-1151-RA-0	60" x 32" x 19", Right Hand Drain	White		

Mariposa® Alcove Whirlpool Bath

- Acrylic
- Integral flange
- (5) Individually adjustable ProFlex® hydro-massage jets
- Pump with air switch and grounding-type plug-in cord
- Optional K-9695 metal finish 5 jet trim kit
- (-A) Integral apron with removable access panel (-HR models includes apron)
- (-H) Built-in heater
- (-W) Bask™ heated surface



Part #	Mfg #	Description	Capacity	Color	Price
125350	K-1239-LA-0	60" x 36" x 20", Left Hand Drain	63 Gal	White	
113666	K-1239-LA-96	60" x 36" x 20", Left Hand Drain	63 Gal	Biscuit	
116895	K-1239-LA-G9	60" x 36" x 20", Left Hand Drain	63 Gal	Sandbar	
137904	K-1239-HR-0	60" x 36" x 20", Right Hand Drain, Heater, Apron	63 Gal	White	
077870	K-1239-R-0	60" x 36" x 20", Right Hand Drain	63 Gal	White	
077601	K-1239-RA-0	60" x 36" x 20", Right Hand Drain	63 Gal	White	
110804	K-1239-RA-96	60" x 36" x 20", Right Hand Drain	63 Gal	Biscuit	
108791	K-1257-HR-0	72" x 36" x 20", Right Hand Drain, Heater, Apron	72 Gal	White	
072502	K-1257-LA-0	72" x 36" x 20", Left Hand Drain	72 Gal	White	
183461	K-1257-LAW-0	72" x 36" x 22", Left Hand Drain w/ Bask™	72 Gal	White	

Whirlpools

Alcove Whirlpools (Continued)

Mariposa® Alcove Whirlpool Bath

Part #	Mfg #	Description	Capacity	Color	Price
071235	K-1257-RA-0	72" x 36" x 20", Right Hand Drain	72 Gal	White	
231580	K-1257-RAW-47	72" x 36" x 20", Right Hand Drain w/ Bask™	72 Gal	White	

Mariposa® Alcove Single Speed Whirlpool Bath

- Acrylic
- Integral flange
- Textured bottom surface
- Pump with air switch
- Integral apron with removable access panel
- Integral lumbar support and armrests for comfort
- (5) Fully adjustable ProFlex® hydro-massage jets
- (-H) Built-in 1500W heater
- (-L) Left-hand drain
- (-RA) Right-hand drain
- (-W) Bask™ heated surface



Part #	Mfg #	Description	Capacity	Color	Price
095595	K-1224-HL-0	66" x 36" x 20", Left Hand Drain	67 Gal	White	
095736	K-1224-RA-0	66" x 36" x 20", Right Hand Drain	67 Gal	White	

Windward® Alcove Whirlpool Bath

- Acrylic
- (6) ProFlex® hydro-massage jets
- Integral tile flange
- Integral lumbar support
- (-A) Integral apron
- (-H) Integral heater



CB Models: Custom Pump Location HR/HL or LA/RA Models

Integral apron with removable access panel

Part #	Mfg #	Description	Capacity	Color	Price
178543	K-1112-HL-0	60" x 42" x 21", LH Drain with Apron & Inline Heater	57 Gal	White	
223416	K-1114-L-0	72" x 42" x 21", LH Drain w/ Integral Flange	78.5 Gal	White	
125751	K-1114-LA-0	72" x 42" x 21", LH Drain with Apron	78.5 Gal	White	
128882	K-1114-RA-0	72" x 42" x 21", RH Drain with Apron	78.5 Gal	White	
177049	K-1114-R-0	72" x 42" x 21", RH Drain w/ Integral Flange	78.5 Gal	White	
117881	K-1114-HR-0	72" x 42" x 21", RH Drain with Inline Heater	78.5 Gal	White	
165859	K-1114-HR-47	72" x 42" x 21", RH Drain with Inline Heater	78.5 Gal	Almond	
118947	K-1114-HR-96	72" x 42" x 21", RH Drain with Inline Heater	78.5 Gal	Biscuit	

Whirlpools

Drop-In Whirlpools

Archer® Drop-In Whirlpool

- (8) Fully adjustable jets
- Comfort Depth® design
- Molded lumbar supports and armrests
- Reversible drain
- Textured bottom surface
- (-H) Integral heater



Part #	Mfg #	Description	Capacity	Color	Price
183496	K-1949-0	66" x 32" x 19", Reversible Drain ExoCrylic™	66 Gal	White	
183495	K-1949-H-0	66" x 32" x 19", Reversible Drain with Heater	33 Gal	White	
187930	K-1949-H-58	66" x 32" x 19", Reversible Drain with Heater	33 Gal	Thunder Grey	

ProFlex® 6036 Drop-In Whirlpool

- ExoCrylic™ material
- (6) Individually adjustable ProFlex® hydro-massage jets
- Molded lumbar supports and armrests
- Pump with air switch and grounding-type plug-in cord
- Drop-in or alcove installations
- Reversible drain sold separately



Part #	Mfg #	Description	Capacity	Color	Price
067624	K-1139-0	60" x 36" x 18-1/8", Reversible Drain	57 Gal	White	
070100	K-1139-96	60" x 36" x 18-1/8", Reversible Drain	57 Gal	Biscuit	

ProFlex® 6040 Oval Drop-In Whirlpool

- ExoCrylic™ material
- (6) Individually adjustable ProFlex® hydro-massage jets
- Molded lumbar support and armrests
- Reversible end drain
- Drop-In installation only
- Drain sold separately



Part #	Mfg #	Description	Capacity	Color	Price
060850	K-1146-0	60" x 40" x 17-5/8", End Drain	54 Gal	White	
172687	K-1146-47	60" x 40" x 17-5/8", End Drain	54 Gal	Almond	
084752	K-1146-96	60" x 40" x 17-5/8", End Drain	54 Gal	Biscuit	
066549	K-1146-H-0	60" x 40" x 17-5/8", End Drain w/ Inline Heater	54 Gal	White	
066852	K-1146-H-96	60" x 40" x 17-5/8", End Drain w/ Inline Heater	54 Gal	Biscuit	

Whirlpools

Whirlpools

ProFlex® 7236 Drop-In Whirlpool

- (6) Factory-installed color-matched adjustable ProFlex® jets
- Molded lumbar supports and armrests
- Pump with air switch and grounding-type plug-in cord
- Drop-in or tile flange on (3) sides for alcove drop-in installations
- Drain sold separately



Part #	Mfg #	Description	Capacity	Color	Price
053323	K-1157-0	72" x 36" x 20-1/8", End Drain	72 Gal	White	
063709	K-1157-96	72" x 36" x 20-1/8", End Drain	72 Gal	Biscuit	
077293	K-1157-H-0	72" x 36" x 20-1/8", End Drain w/ Inline Heater	72 Gal	White	

ProFlex® 7242 Drop-In Whirlpool

- (6) Individually adjustable ProFlex® hydro-massage jets
- Molded lumbar supports and armrests
- Pump with air switch and grounding-type plug-in cord
- Drop-in or 3-wall alcove
- Center drain sold separately
- (-F) Integral flange



Part #	Mfg #	Description	Capacity	Color	Price
053324	K-1131-0	72" x 42" x 20-1/8", Center Drain	78 Gal	White	
088066	K-1131-47	72" x 42" x 20-1/8", Center Drain	78 Gal	Almond	
070089	K-1131-96	72" x 42" x 20-1/8", Center Drain	78 Gal	Biscuit	
071483	K-1131-F-0	72" x 42" x 20-1/8", Center Drain w/ Integral Flange	78 Gal	White	
070847	K-1131-H-0	72" x 42" x 20-1/8", Center Drain w/ Inline Heater	78 Gal	White	

ProFlex® 7242 Oval Drop-In Whirlpool'

- ExoCrylic™ material
- (6) Individually adjustable ProFlex® hydro-massage jets
- Molded lumbar support and armrests
- Reversible drain
- Drain sold separately
- (-H) Integral heater
- (-D) Custom pump location



Part #	Mfg #	Description	Capacity	Color	Price
071249	K-1148-0	72" x 42" x 19-3/4", Reversible Drain	78 Gal	White	
096238	K-1148-47	72" x 42" x 19-3/4", Reversible Drain	78 Gal	Almond	
076071	K-1148-96	72" x 42" x 19-3/4", Reversible Drain	78 Gal	Biscuit	
079810	K-1148-H-0	72" x 42" x 19-3/4", Reversible Drain w/ Inline Heater	78 Gal	White	
086002	K-1148-H-96	72" x 42" x 19-3/4", Reversible Drain w/ Inline Heater	78 Gal	Biscuit	
168532	K-1148-HD-47	72" x 42" x 19-3/4", Custom Pump w/ Inline Heater	78 Gal	Almond	

Whirlpools

Archer® Drop-In Whirlpool

- (8) Individually adjustable hydro-massage jets
- Single speed pump
- Comfort Depth®
- Integral lumbar and armrest support
- Textured bottom surface
- Reversible drain
- Slotted overflow allows for deep soaking
- (-H) Built-in heater
- (-L) Left-hand drain



Required: ClearFlo slotted overflow K-7271 or K-7272

Part #	Mfg #	Description	Capacity	Color	Price
114529	K-1122-0	60" x 32" x 19", Reversible Drain	58 Gal	White	
127749	K-1122-33	60" x 32" x 19", Reversible Drain	58 Gal	Mexican Sand	
121566	K-1122-47	60" x 32" x 19", Reversible Drain	58 Gal	Almond	
123249	K-1122-96	60" x 32" x 19", Reversible Drain	58 Gal	Biscuit	
166075	K-1122-H-0	60" x 32" x 19", Reversible Drain w/ Heater	58 Gal	White	
144342	K-1122-H-95	60" x 32" x 19", Reversible Drain w/ Heater	58 Gal	Ice Grey	
129530	K-1122-H-96	60" x 32" x 19", Reversible Drain w/ Heater	58 Gal	Biscuit	
108489	K-1124-0	72" x 36" x 19", Reversible Drain	72 Gal	White	
105604	K-1124-47	72" x 36" x 19", Reversible Drain	72 Gal	Almond	
126247	K-1124-96	72" x 36" x 19", Reversible Drain	72 Gal	Biscuit	
179977	K-1124-NY	72" x 36" x 19", Reversible Drain	72 Gal	Dune	

Whirlpools

Archer® Drop-In Whirlpool + BubbleMassage™ Air Bath

- Acrylic
- 118 BubbleMassage™ airjets, 8 Whirlpool jets
- Variable-speed blower with 18 levels
- Built-in heater
- Molded lumbar support
- Slotted overflow
- Textured bottom surface
- Reversible drain



Requires K-7271 or K-7272 Slotted overflow bath drain

Part #	Mfg #	Description	Capacity	Color	Price
228470	K-1124-XHG-0	72" x 36" x 19", Reversible Drain w/ Heater	72 Gal	White	
173700	K-1124-XHG-96	72" x 36" x 19", Reversible Drain w/ Heater	72 Gal	Biscuit	

Whirlpools

Bancroft® Drop-In Whirlpool

- Acrylic
- Variable speed pump with 1.5 kW heater, back-lit user keypad, and remote control
- Less all trim
- (8) Flexjet™ whirlpool jets
- Custom pump locations



Part #	Mfg #	Description	Capacity	Color	Price
127590	K-1158-H2-0	66" x 42" x 22", End Drain w/ Heater Less Trim	95 Gal	White	
159169	K-1158-HJ-96	66" x 42" x 22", End Drain	95 Gal	Biscuit	

Devonshire® Drop-In Whirlpool with Reversible Drain

- Acrylic
- Textured bottom surface
- (8) Fully adjustable jets
- Single-speed whirlpool offers performance and value
- Pump with air switch and grounding-type plug-in cord
- (-A) Integral apron model (K-1357-HL-0 includes apron and flange)
- (-H) Built-in heater
- (-L) Left-hand drain
- (-R) Right-hand drain



Part #	Mfg #	Description	Capacity	Color	Price
070107	K-1357-0	60" x 32" x 20", End Drain	60 Gal	White	
077206	K-1357-47	60" x 32" x 20", End Drain	60 Gal	Almond	
070111	K-1357-96	60" x 32" x 20", End Drain	60 Gal	Biscuit	
162280	K-1357-NY	60" x 32" x 20", End Drain	60 Gal	Dune	
100939	K-1357-HL-96	60" x 32" x 20", LH Drain, Apron, Flange, Heater	60 Gal	White	
070188	K-1357-LA-0	60" x 32" x 20", Left-Hand Drain, Apron	60 Gal	White	
070190	K-1357-LA-96	60" x 32" x 20", Left-Hand Drain, Apron	60 Gal	Biscuit	
064351	K-1357-RA-0	60" x 32" x 20", Right-Hand Drain, Apron	60 Gal	White	

Mariposa® Drop-In Whirlpool with ProFlex® Jets and Reversible Drain

- Acrylic
- Three-wall alcove installation
- Molded lumbar supports and armrests
- Textured bottom surface
- (-H) Built-in heater
- (-B) Custom pump location



Part #	Mfg #	Description	Capacity	Color	Price
053326	K-1239-0	60" x 36" x 20", Drop-In, (5) ProFlex® Jets	63 Gal	White	
110050	K-1239-47	60" x 36" x 20", Drop-In, (5) ProFlex® Jets	63 Gal	Almond	
070101	K-1239-96	60" x 36" x 20", Drop-In, (5) ProFlex® Jets	63 Gal	Biscuit	
146875	K-1239-G9	60" x 36" x 20", Drop-In, (5) ProFlex® Jets	63 Gal	Sandbar	
175903	K-1239-NY	60" x 36" x 20", Drop-In, (5) ProFlex® Jets	63 Gal	Dune	
118984	K-1239-CB-0	60" x 36" x 20", Drop-In, (5) ProFlex® Jets w/ Cust Pump	63 Gal	White	

Whirlpools

Drop-In Whirlpools (Continued)

Mariposa® Drop-In Whirlpool with ProFlex® Jets and Reversible Drain

Part #	Mfg #	Description	Capacity	Color	Price
084339	K-1239-H-0	60" x 36" x 20", Drop-In, (5) ProFlex® Jets w/ Heater	63 Gal	White	
132539	K-1239-H-47	60" x 36" x 20", Drop-In, (5) ProFlex® Jets w/ Heater	63 Gal	Almond	
064896	K-1224-0	66" x 35-7/8" x 20", Drop-In, (5) ProFlex® Jets	67 Gal	White	
152518	K-1224-47	66" x 35-7/8" x 20", Drop-In, (5) ProFlex® Jets	67 Gal	Almond	
082204	K-1224-96	66" x 35-7/8" x 20", Drop-In, (5) ProFlex® Jets	67 Gal	Biscuit	
076433	K-1224-H-0	66" x 35-7/8" x 20", Drop-In, (5) ProFlex® Jets & Heater	67 Gal	White	
109674	K-1224-H-47	66" x 35-7/8" x 20", Drop-In, (5) ProFlex® Jets & Heater	67 Gal	Almond	
075975	K-1224-H-96	66" x 35-7/8" x 20", Drop-In, (5) ProFlex® Jets & Heater	67 Gal	Biscuit	
063474	K-1257-0	72" x 36" x 20", Drop-In, (6) ProFlex® Jets	72 Gal	White	
171227	K-1257-47	72" x 36" x 20", Drop-In, (6) ProFlex® Jets	72 Gal	Almond	
059110	K-1257-96	72" x 36" x 20", Drop-In, (6) ProFlex® Jets	72 Gal	Biscuit	
064135	K-1257-G9	72" x 36" x 20", Drop-In, (6) ProFlex® Jets	72 Gal	Sandbar	
131246	K-1257-H-0	72" x 36" x 20", Drop-In, (6) ProFlex® Jets & Heater	72 Gal	White	
118950	K-1257-H-47	72" x 36" x 20", Drop-In, (6) ProFlex® Jets & Heater	72 Gal	Almond	
149777	K-1257-H-96	72" x 36" x 20", Drop-In, (6) ProFlex® Jets & Heater	72 Gal	Biscuit	
173824	K-1257-HB-96	72" x 36" x 20"(6) Jets w/ Heater & Custom Pump Loc	72 Gal	Biscuit	

Memoirs® Drop-In Whirlpool

- Acrylic
- (8) Hydromassage jets can be individually adjusted for water flow and direction
- Variable speed pump for adjusting massage intensity
- Electronic keypad
- Reversible drain
- LESS jet trim
- Custom pump location for models (K-1170-HN-96) & (K-1170-HH-96)



Part #	Mfg #	Description	Capacity	Color	Price
154561	K-1170-HN-96	66"x42"x22", Built-in Heater, Custom Pump Location	81 Gal	Biscuit	
131985	K-1170-H2-0	66"x42"x22", Built-in Heater	81 Gal	White	
095313	K-1170-H2-96	66"x42"x22", Built-in Heater	81 Gal	Biscuit	
124641	K-1170-HH-96	66"x42"x22", Built-in Heater, Custom Pump Location	81 Gal	Biscuit	

Whirlpools

Whirlpools

Memoirs® Drop-In Effervescence + Whirlpool with Spa/Massage Package

- Acrylic
- Variable speed pump with 1.5kW heater, back-lit user keypad and remote control
- (6) Flexjets™
- (10) Color-matched sequencing BodyMassage™ backjets
- (2) Pulsating neckjets with pillow
- (8) Effervescent ports
- (4) Chromatherapy lights
- 240 V, 20 A electrical service
- Color-matched jet trim included

Drilled for K-9653 grab bars (required)



Part #	Mfg #	Description	Capacity	Color	Price
072782	K-1418-V-0	72" x 42" x 22", Center Drain	86 Gal	White	
152534	K-1418-V-47	72" x 42" x 22", Center Drain	86 Gal	Almond	
074228	K-1418-V-96	72" x 42" x 22", Center Drain	86 Gal	Biscuit	

Purist® Drop-In Effervescence Tub

- Acrylic
- Variable speed pump for adjusting hydromassage intensity
- Chromatherapy lighting
- Includes: built-in heater, electronic keypad, & remote control
- Overflow channel
- (-V) Spa/massage package



Part #	Mfg #	Description	Capacity	Color	Price
225695	K-1110-CT-96	72" x 46" x 25-11/16", End Drain	115 Gal	Biscuit	
188517	K-1110-V-0	72" x 46" x 24", End Drain Spa + Massage Pckg	96 Gal	White	

RiverBath® Drop-In Whirlpool

- Acrylic
- Integral fill and valves
- Less all trim
- (2) Variable speed pumps with back-lit user control and remote control
- (8) Flexjets™ (4) Riverjets (4) Chromatherapy lights
- Air aspiration "on/off" feature
- (1) Large pillow and (3) small pillows
- 4 kW Heater (on separate electrical service)



Required: K-9398 Flexjet™ Trim, K-T9540-4 or T9540-7 transfer valve trim handshower, and faucet handles

Part #	Mfg #	Description	Capacity	Color	Price
069018	K-1397-H2-0	75" x 75" x 25"	215 Gal	White	
154099	K-1397-H2-96	75" x 75" x 25"	215 Gal	Biscuit	

Whirlpools

Winward® Drop-In Whirlpool

- Acrylic
- (6) Individual adjustable ProFlex® hydro-massage jets
- Molded lumbar supports and armrests
- Pump with air switch
- (-CB) Custom pump location



Part #	Mfg #	Description	Capacity	Color	Price
135160	K-1112-0	60" x 42" x 21", End Drain	57 Gal	White	
222599	K-1114-CB-0	72" x 42" x 21", Drop-In w/ Custom Pump Location	78.5 Gal	White	
114828	K-1114-H-96	72" x 42" x 21", End Drain w/ Heater	78.5 Gal	Biscuit	
119269	K-1114-H-G9	72" x 42" x 21", End Drain w/ Heater	78.5 Gal	Sandbar	

Dual-Mount Whirlpools

GreeK® Dual-Mount Whirlpool

- Acrylic
- (4) Hydromassage jets
- Variable-speed pump for adjusting massage intensity
- Built-in heater
- Electronic keypad
- Under-mountable
- Reversible drain
- Less jet trim



Part #	Mfg #	Description	Capacity	Color	Price
061905	K-1492-H2-0	48" x 32" x 23-3/8", Reversible Drain	103 lbs	White	
182812	K-1492-H2-96	48" x 32" x 23-3/8", Reversible Drain	103 lbs	Biscuit	

Sunward® Dual-Mount Whirlpool

- Acrylic
- Single-speed
- (6) Fully adjustable jets
- Molded lumbar support and armrests
- Reversible end drain
- Drop-in or under-mount
- (-B) Custom pump location
- (-H) Built-in heater
- (S1) ExoCrylic material



Part #	Mfg #	Description	Capacity	Color	Price
093668	K-1162-0	60" x 42" x 21", End Drain	57 Gal	White	
085085	K-1162-96	60" x 42" x 21", End Drain	57 Gal	Biscuit	
126998	K-1162-H-0	60" x 42" x 21", End Drain w/ Inline Heater	57 Gal	White	
087861	K-1162-H-96	60" x 42" x 21", End Drain w/ Inline Heater	57 Gal	Biscuit	
097240	K-1162-HB-96	60" x 42" x 21", End Drain w/ Heater w/ Custom Pump Loc.	57 Gal	Biscuit	
161464	K-1164-S1-0	72" x 42" x 20", End Drain - ExoCrylic	75 Gal	White	
225400	K-1164-S1H-0	72" x 42" x 20", End Drain w/ Heater - ExoCrylic	75 Gal	White	
227052	K-1164-S1HB-0	72" x 42" x 20", End Drain w/ Heater & Cust Pump Loc	75 Gal	White	

Whirlpools

Tea-for-Two® Dual-Mount Whirlpool

- Cast Iron
- Variable-speed pump for adjusting massage intensity
- (6) Hydromassage jets can be individually adjusted for water flow and direction
- Molded armrests
- Safeguard slip-resistant surface on bath floor
- End drain
- Drop-in or under-mount



Part #	Mfg #	Description	Capacity	Color	Price
224284	K-865-H2-0	72" x 36" x 20-7/8", End Drain	89 Gal	White	

Underscore® Dual-Mount Whirlpool

- Acyclic
- 8 Flexjet™ whirlpool jets
- Drop-in or undermount installation
- Molded lumbar support
- Less all trim
- Variable-speed pump with 1.5kW heater and back-lit user keypad
- Center drain included with (K-1174)



**Requires: K-7271 or K-7272 Slotted Overflow drain
K-9698 Jet Trim Kit**

Part #	Mfg #	Description	Capacity	Color	Price
183474	K-1822-H2-0	66" x 32" x 22", End Drain	85.8 Gal	White	
173256	K-1822-H2-7	66" x 32" x 22", End Drain	85.8 Gal	Black	
167393	K-1849-H2-0	60" x 36" x 21", End Drain	81.1 Gal	White	
154957	K-1173-H2-0	66" x 36" x 22", End Drain	102 Gal	White	
151428	K-1173-H2-47	66" x 36" x 22", End Drain	102 Gal	Almond	
162210	K-1173-H2-96	66" x 36" x 22", End Drain	102 Gal	Biscuit	
173085	K-1173-H2-7	66" x 36" x 22", End Drain	102 Gal	Black	
186662	K-1835-H2-0	72" x 36" x 23", End Drain, Inline Heater	112.9 Gal	White	
189419	K-1835-H2-58	72" x 36" x 23", End Drain, Inline Heater	112.9 Gal	Thunder Grey	
161738	K-1835-H2-96	72" x 36" x 23", End Drain, Inline Heater	112.9 Gal	Biscuit	
167205	K-1835-H2-G9	72" x 36" x 23", End Drain, Inline Heater	112.9 Gal	Sandbar	
168037	K-1174-H2-0	72" x 42" x 23", Center Drain	139 Gal	White	
158136	K-1174-H2-47	72" x 42" x 23", Center Drain	139 Gal	Almond	
167115	K-1174-H2-G9	72" x 42" x 23", Center Drain	139 Gal	Sandbar	

Whirlpools

Whirlpools

Underscore® Dual-Mount Oval Whirlpool

- *ExoCrylic*
- *8 Hydromassage jets*
- *Built-in heater*
- *Lighted keypad*
- *Dual lumbar supports two-person bathing*
- *BubbleMassage™ included with model (K-5718-XH2G-0)*



Requires: K-7271 or K-7272 Slotted Overflow drain
K-9698 Jet Trim Kit

Part #	Mfg #	Description	Capacity	Color	Price
181854	K-5714-H2-G9	60" x 36" x 21", Center Drain, Inline Heater	72 Gal	Sandbar	
228454	K-5718-XH2G-0	72" x 42" x 22", Center Drain w/ BubbleMassage™	112.2 Gal	White	

Underscore® Dual-Mount Whirlpool with Built-In Heater

- *Acrylic*
- *Drop-in or under-mount installation*
- *Two raised corner seats, at 6-3/4" and 11-7/8" from bath floor*
- *(8) Fully adjustable Flexjet™ whirlpool jets*
- *Variable speed pump with 1.5kW heater and back-lit user keypad and remote control*
- *Extra deep 27-1/2" soaking depth*



Requires: K-8150 Cable Drain, K-8134 Drain Trim

Part #	Mfg #	Description	Capacity	Color	Price
155728	K-1969-H2-0	48" x 48" x 34", Dual-Mount w/ Heater	171 Gal	White	

Corner Whirlpools Tercet™ Corner Whirlpool

- *Textured bottom*
- *Integral flange*
- *Molded lumbar supports and armrests*
- *Pump with air switch and grounding-type plug-in cord*
- *(6) Individually adjustable ProFlex® hydro-massage jets*
- *Center drain sold separately*
- *Integral apron included with K-1160-HL-0 and K-1160-LA-0*



Part #	Mfg #	Description	Capacity	Color	Price
086456	K-1160-0	60" x 60" x 21", Drop-In	96 Gal	White	
105166	K-1160-96	60" x 60" x 21", Drop-In	96 Gal	Biscuit	
096925	K-1160-F-0	60" x 60" x 21", Tile Flange	96 Gal	White	
088777	K-1160-FH-0	60" x 60" x 21", Tile Flange w/ Inline Heater	96 Gal	White	
105261	K-1160-H-0	60" x 60" x 21", Drop-In w/ Inline Heater	96 Gal	White	
084611	K-1160-HL-0	60" x 60" x 21", Tile Flange, Integral Apron & Heater	96 Gal	White	
083219	K-1160-LA-0	60" x 60" x 21", Tile Flange, Integral Apron	96 Gal	White	

Whirlpools

5454 Drop-In Single Speed Whirlpool

- (6) fully adjustable Proflex® hydro-massage jets
- Molded lumbar supports and armrests
- Pump with air switch
- Integral faucet deck
- (-CC) Custom pump location
- (-H) Built-in heater
- Faucet and center drain sold separately



Part #	Mfg #	Description	Capacity	Color	Price
073276	K-1154-0	54" x 54" x 20-1/2", Drop-In	76 Gal	White	
078463	K-1154-CC-0	54" x 54" x 20-1/2", Drop-In, Custom Pump	76 Gal	White	
101007	K-1154-H-0	54" x 54" x 20-1/2", Drop-In, Heater	76 Gal	White	

Whirlpool Trim Kits & Accessories

Flexjet® Whirlpool Trim Kit

- Plastic
- 4-1/8" x 29/32"
- includes matching suction cover (metal finish kits only)
- Easy-to-install design with O-ring
- Available in color-matched or faucet finished matched jets



Part #	Mfg #	Description	Capacity	Color	Price
189418	K-9698-58	(8) Jets		Thunder Grey	

Flexjet® Whirlpool Trim Kit

- Independently adjustable Flexjets™
- Silicone lubricant
- Jet removal tool
- Suction cover (metal finish kits only)
- Color-matched suction cover shipped with whirlpool



Part #	Mfg #	Description	Color	Price
085917	K-9695-BN	(5) Jets, Includes Suction Cover	*Brushed Nickel	
175904	K-9695-NY	(5) Jets, Includes Suction Cover	Dune	
055275	K-9696-0	(6) Jets, Includes Suction Cover	White	
183165	K-9696-BKB	(6) Jets, Includes Suction Cover	Brushed Black	
054118	K-9698-0	(8) Jets, Includes Suction Cover	White	
061990	K-9698-96	(8) Jets, Includes Suction Cover	Biscuit	
054811	K-9698-BN	(8) Jets, Includes Suction Cover	*Brushed Nickel	
062025	K-9698-CP	(8) Jets, Includes Suction Cover	Polished Chrome	

Whirlpools

Keypad Trim

- 2.5" Keypad trim
- Surrounds keypad in the finish of your choice
- For use with Experience whirlpools and select BubbleMassage™ air baths



Part #	Mfg #	Description	Capacity	Color	Price
161693	K-9497-CP	2.5" Diameter		Polished Chrome	
091304	K-9497-BV	2.5" Diameter		*Brushed Bronze	
107149	K-9497-G	2.5" Diameter		Brushed Chrome	
095103	K-9497-BN	2.5" Diameter		*Brushed Nickel	

Bath/Whirlpool Pillow

- Durable vinyl cover
- Suction cup keeps the pillow in place



Part #	Mfg #	Description	Capacity	Color	Price
058385	K-1491-0	13-5/16" X 5-11/32"		White	
098736	K-1491-7	13-5/16" X 5-11/32"		Black	
066596	K-1491-96	13-5/16" X 5-11/32"		Biscuit	

Whirlpools

Whirlpools

Vikrell® Bathtubs



- Solid Vikrell® material for strength and durability
- High-gloss finish

7727 Lawson™ 36" Drop-In Air Massage Bathtub

- Fits standard 5' opening
- (29) Air jets
- 3-Speed soothing to invigorating air options
- 360° Massaging coverage
- Complete unit rough in dimensions including nailing flange: 20-5/16" x 60-1/4" x 36"



Part #	Mfg #	Description	Drain	Finished Dimensions	Color	Price
139955	77271100-0	Air Massage Bathtub	End	20-5/16" x 60" x 36"	White	

Vikrell® Whirlpool Bathtubs



- Solid Vikrell® material for strength and durability
- High-gloss finish

7630 Lawson™ 36" XL Drop-In Whirlpool Bathtub

- 6' Length provides additional room and added comfort
- Contoured backrest with lumbar support
- Arched armrests
- Pump with air switch and grounding-type plug-in cord
- (6) Adjustable jets with independent variable control
- Complete unit rough-in dimensions including nailing flange: 20-5/16" x 72" x 36"



Part #	Mfg #	Description	Drain	Finished Dimensions	Color	Price
147375	76301100-0	Drop-In Whirlpool Bathtub	End	20-5/16" x 72" x 36"	White	
226567	76301100-H-0	Drop-In Whirlpool Bathtub, w/ Heater	End	20-5/16" x 72" x 36"	White	

Vikrell® Whirlpool Tub & Shower Modules



- Solid Vikrell® material for strength and durability
- High-gloss finish

7610 Ensemble™ 36" Whirlpool Tub & Shower Module

- 1-1/4 hp Pump with air switch and grounding-type plug-in cord
- 3-Piece wall set
- Lightly pebbled bottom surface
- Tongue and groove interlocking joints
- Fits standard 5' opening
- (6) Jets with independent variable control
- Complete unit rough-in dimensions including flange: 73-1/4" x 60-1/4" x 37-1/2"

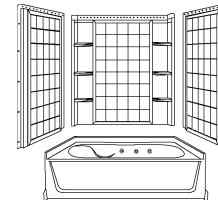

Part #	Mfg #	Description	Drain	Finished Dimensions	Color	Price
070318	76101110-0	Whirlpool Tub Only, 16" Apron	LH	16" x 60" x 36"	White	
061433	76101120-0	Whirlpool Tub Only, 16" Apron	RH	16" x 60" x 36"	White	

Whirlpools

Whirlpools

7612 Ensemble™ 32 Whirlpool Tile Tub & Shower Module

- 1-1/4 hp Pump with air switch and grounding-type plug-in cord
- 3-Piece wall set
- Lightly pebbled bottom surface
- Tongue and groove interlocking joints
- (8) Jets with independent variable control
- Complete unit rough-in dimensions including flanges: 75-1/4" x 60-1/4" x 33-1/4"



Part #	Mfg #	Description	Drain	Finished Dimensions	Color	Price
084519	76121110-0	Whirlpool Tub Only, 18" Apron	LH	18" x 60" x 32"	White	
078806	76121120-0	Whirlpool Tub Only, 18" Apron	RH	18" x 60" x 32"	White	

7632 Ensemble Medley™ Whirlpool Tub & Shower Module

- Caulk-free, making installation a snap and reducing the need for long-term maintenance
- Innovative Dry-Block™ seal and channeled water containment system form watertight seams
- (8) Fully adjustable hydro-massage jets, pre-mounted pump, and front access panel for easy access to system
- Tongued-and-grooved interlocking joints
- Durable high-gloss finish provides a smooth, shiny surface



Part #	Mfg #	Description	Drain	Finished Dimensions	Color	Price
226263	76320120-0	Whirlpool & Shower Complete	RH	75" x 60" x 32"	White	

7622 Ensemble™ 32" Whirlpool Curve Tub & Shower Module

- 1-1/4 hp Pump with air switch and grounding-type plug-in cord
- 3-Piece curve wall set
- 18" Integral apron with removable access panel
- Tongue and groove interlocking joints
- (8) Jets with independent variable control
- Complete unit rough-in dimensions including flanges: 75-1/4" x 60-1/4" x 33-1/4"



Part #	Mfg #	Description	Drain	Finished Dimensions	Color	Price
087430	76220110-0	Whirlpool & Shower Complete	LH	74" x 60" x 32"	White	
082516	76220120-0	Whirlpool & Shower Complete	RH	74" x 60" x 32"	White	

Whirlpools

Whirlpools

Whirlpools

- Pre-leveled block base system
- 2-1/2" Diameter overflow
- Balsa wood core floor structure
- Textured floor pattern

Geneva 3660 Acrylic Revive Air System Air tub

- Self-rimming
- Vacuum formed acrylic
- 2" Drain
- Twin, contoured arm rests
- Includes:
 - (48) Perimeter air ports
 - Electronic system control
 - 12.0 Amp, 600-watt blower with ceramic heater



Part #	Mfg #	Description	Drain	Finish	Price
132388	TR-B-240/AR2-WHT	21" x 60" x 36"	Universal	White	

Geneva 3660 Acrylic Builder System Whirlpool

- Self-rimming
- Vacuum formed acrylic
- 2" Drain
- Twin, contoured arm rests
- Includes:
 - (6) Adjustable jets
 - Twin air controls
 - Pneumatic system control
 - 5.50A Pump/motor



Part #	Mfg #	Description	Drain	Finish	Price
126198	TR-B-240/6P-WHT	21" x 60" x 36"	Universal	White	
145149	TR-B-240/6P-BSC	21" x 60" x 36"	Universal	Biscuit	

Geneva 3672 Acrylic Builder System Whirlpool

- Self-rimming
- Vacuum formed acrylic
- 2" Drain
- Twin, contoured arm rests
- Includes:
 - (6) Adjustable jets
 - Twin air controls
 - Pneumatic system control
 - 5.50A Pump/motor



Part #	Mfg #	Description	Drain	Finish	Price
129257	TR-B-270/6P-WHT	21" x 72" x 36-1/4"	Universal	White	
092486	TR-B-270/6P1-WHT	21" x 72" x 36-1/4", (1) Pump	Universal	White	
092489	TR-B-270/6P1-BSC	21" x 72" x 36-1/4", (1) Pump	Universal	Biscuit	

Whirlpools

Whirlpools

Whirlpools

Belmont I Builders' Choice Whirlpool

- (8) Hydrotherapy jets
- 3/4 hp Pump
- Advanced safety suction system
- Bath-side on/off button
- Sculpted armrests
- Slip resistant bottom
- Lucite cast acrylic surface



Part #	Mfg #	Finished Dimensions	Drain	Color	Price
039839	3960621	59-1/8" x 40-3/16" x 23-7/8"	Universal	White	

Cavalcade Builders' Choice Whirlpool

- (8) Hydrotherapy jets
- 3/4 hp Pump
- Advanced safety suction system
- Bath-side on/off button
- Sculpted armrests
- Slip resistant bottom
- Lucite cast acrylic surface



Part #	Mfg #	Finished Dimensions	Drain	Color	Price
039484	3860621	60" x 30" x 22"	Center Front	White	

Montrose I Builders' Choice Whirlpool

- (8) Hydrotherapy jets
- 3/4 hp Pump
- Advanced safety suction system
- Bath-side on/off button
- Acrylic grab bars
- Sculpted armrests
- Slip resistant bottom
- Lucite cast acrylic surface



Part #	Mfg #	Finished Dimensions	Drain	Color	Price
039837	4160621	60" x 36" x 21-1/2"	Universal	White	

Montrose II Builders' Choice Whirlpool

- (8) Hydrotherapy jets
- 3/4 hp Pump
- Advanced safety suction system
- Bath-side on/off button
- Sculpted armrests
- Slip resistant bottom
- Lucite cast acrylic surface



Part #	Mfg #	Finished Dimensions	Drain	Color	Price
039483	4272621	72" x 36" x 22"	Universal	White	
043995	4272621-BI	72" x 36" x 22"	Universal	Biscuit	

Whirlpools

Alcove or Drop-In Whirlpool

3660 Pro-Fit Whirlpool

- Rectangular whirlpool with integral armrests
- Simple, reliable air-switch turns the unit on and off
- Durable single-speed pump
- Six strategically positioned jets deliver a therapeutic massage: Four body jets and two foot jets
- Two air controls adjust the volume of air through the jets – creating mild to vigorous whirlpool action
- Optional removable apron provides easy access to the motor and plumbing
- Color-match trim, chrome and everbrass (PVD), brushed nickel and oil rubbed bronze upgrades available
- Optional cable operated drain in color-match, chrome, everbrass (PVD), brushed nickel or oil rubbed bronze



Part #	Mfg #	Description	Capacity	Color	Price
229859	MAN-6018-WH	6018 36 x 60 Whirlpool White	59-3/4" x 35-3/4" x 21-1/4"	White	

3672 Pro-Fit Whirlpool

- Rectangular whirlpool with integral armrests
- Simple, reliable air-switch turns the unit on and off
- Durable single-speed pump
- Six strategically positioned jets deliver a therapeutic massage: Four body jets and two foot jets
- Two air controls adjust the volume of air through the jets – creating mild to vigorous whirlpool action
- Optional removable apron provides easy access to the motor and plumbing
- Color-match trim, chrome and everbrass (PVD), brushed nickel and oil rubbed bronze upgrades available
- Optional cable operated drain in color-match, chrome, everbrass (PVD), brushed nickel or oil rubbed bronze



Part #	Mfg #	Description	Capacity	Color	Price
229860	MAN-6021-WH	6021 36 x 72 Whirlpool White	71-1/2" x 35-1/2" x 20"	White	

4260 Pro-Fit Whirlpool

- Rectangular shaped whirlpool with oval bathing well
- Simple, reliable air-switch turns the unit on and off
- Durable single-speed pump
- Six strategically positioned jets deliver a therapeutic massage: Four body jets and two foot jets
- Optional removable apron provides easy access to the motor and plumbing
- Two air controls adjust the volume of air through the jets – creating mild to vigorous whirlpool action
- Color-match trim, chrome and everbrass (PVD), brushed nickel and oil rubbed bronze upgrades available
- Optional cable operated drain in color-match, chrome, everbrass (PVD), brushed nickel or oil rubbed bronze



Part #	Mfg #	Description	Capacity	Color	Price
229861	MAN-6024-WH	6024 42 x 60 Whirlpool White	42" x 60" x 20-1/4"	White	

Whirlpools

4272 Pro-Fit Whirlpool

- Rectangular shaped whirlpool with oval bathing well
- Simple, reliable air-switch turns the unit on and off
- Durable single-speed pump
- Six strategically positioned jets deliver a therapeutic massage: Four body jets and two foot jets
- Two air controls adjust the volume of air through the jets – creating mild to vigorous whirlpool action
- Optional removable apron provides easy access to the motor and plumbing
- Color-match trim, chrome and everbrass (PVD), brushed nickel and oil rubbed bronze upgrades available
- Optional cable operated drain in color-match, chrome, everbrass (PVD), brushed nickel or oil rubbed bronze



Part #	Mfg #	Description	Capacity	Color	Price
229862	MAN-6027-WH	6027 42 x 72 Whirlpool White	42" x 71-1/2" x 19-3/4"	White	

Whirlpools

Work Gloves

Work Gloves

Demolition Gloves

- Built-in terry cloth sweat wipe
- Velcro Closure for a secure fit
- Breathable Lining - Moisture wicking lining provides all day comfort
- Molded Knuckle Protection - TPR pad provides ultimate knuckle protection
- Palms and Finger Tips reinforced with Armortex® for ultimate durability and grip
- Smartwipe™ Knuckle - Permits the use of touch screen devices without removing gloves or wiping dirty finger tips across the screen



Part #	Mfg #	Description	Price
229541	48-22-8735	Small	
186454	48-22-8731	Medium	
186456	48-22-8732	Large	
186457	48-22-8733	Extra Large	
186458	48-22-8734	2X Large	

Fingerless Work Gloves

- Fingerless design for ultimate dexterity
- Reinforced and padded palm
- Built-in terry cloth sweat wipe
- Hook & loop closure for a secure fit
- Breathable lining provides all day comfort



Part #	Mfg #	Description	Price
224333	48-22-8745	Small	
224334	48-22-8741	Medium	
224335	48-22-8742	Large	
224336	48-22-8743	Extra Large	
224337	48-22-8744	2X Large	

Free-Flex Work Gloves

- Built-in terry cloth sweat wipe
- Free-Flex cuff for all day comfort
- Breathable lining provides all day comfort reinforced thumb seam
- Smartwipe™ Fingertips, Knuckles and Palms - Permits the use of touch screen devices without removing gloves
- High dexterity finger tips provide dexterity when handling small objects



Part #	Mfg #	Description	Price
224343	48-22-8715	Small	
224346	48-22-8711	Medium	
224347	48-22-8712	Large	
224348	48-22-8713	Extra Large	
224349	48-22-8714	2X Large	

Performance Work Gloves

- Built-in terry cloth sweat wipe
- Breathable lining provides all day comfort
- Hook & loop closure for a secure fit
- High dexterity finger tips provide dexterity when handling small objects
- Smartwipe™ Fingertips, Knuckles and Palms - Permits the use of touch screen devices without removing gloves



Part #	Mfg #	Description	Price
224338	48-22-8725	Small	
224339	48-22-8721	Medium	
224340	48-22-8722	Large	
224341	48-22-8723	Extra Large	
224342	48-22-8724	2X Large	

Gloves, Ear Plugs, Goggles, ETC

Gloves

Journeyman Utility Gloves (K1)

- *Supple, breathable, durable synthetic leather palm*
- *2-Way stretch spandex padded top features form-fitting elasticity*
- *Reinforced thumb, index finger and fingertips add protection*
- *Concealed interior seam stitching prevents snagging*
- *Wide opening elastic cuff*
- *Contact points on index finger and thumb feature smooth surface for improved handling of objects*

JOURNEYMAN™



Part #	Mfg #	Size	Price
106850	40052	Medium	
106851	40053	Large	
106852	40054	X-Large	

Journeyman™ Heavy-Duty Protection Gloves (K3)

- *Streamlined high-density accordion knuckle panel reduces impact*
- *High profile, impact absorbing molded Thermal Plastic Rubber (TPR) finger protection*
- *Non-slip rubberized Zeus™ Carino® finger and thumb grippers and panel on heel of hand provide grip control and longer wear*
- *Synthetic leather with breathable mesh side insert finger panels*
- *2-Ply synthetic leather palm with anatomically die cut Ethylene Vinyl Acetate (EVA) foam padded impact zones*
- *Thermal Plastic Rubber (TRP) cuff strap with hook and loop closure*
- *Neoprene cuff allows easier access with additional wrist protection and comfort*

JOURNEYMAN™



Part #	Mfg #	Size	Price
106857	40063	Large	

Work Wear

Gloves, Ear Plugs, Goggles, ETC

Gloves

Disposable Latex Glove

- *Extra large*
- *Reversible*



Part #	Mfg #	Type	Size	Price
060105	390-50177	Heavy-Duty	XL	

Gloves, Ear Plugs, Goggles, ETC

Gloves

Disposable Nitrile Glove

- Textured fingertips
- Powder-free
- 5 - 6 Mil
- 100/Box

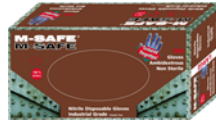

Part #	Mfg #	Description	Price
121772	3276L	Large	
133593	3276XL	Extra Large	

X10 Knucklehead Glove

- Synthetic leather palm
- Elastic wrist
- High visibility orange



Part #	Mfg #	Description	Price
148262	21242HOL	Large	
148263	21242HOXL	Extra Large	
148135	21242HOXXL	Extra Extra Large	

Split Cowhide Double Palm Glove

- Knuckle strap
- Wing thumb
- Polyethylene safety cuff



Part #	Mfg #	Description	Price
122046	4503CDPXL	Extra Large	

String Knit Cotton/Polyester Glove

- Ambidextrous
- PVC Dots on both sides
- Natural color



Part #	Mfg #	Description	Price
122623	3825L	Large	

A Grade Gold Deerskin Palm Glove

- Black stretch back
- Velcro closure
- Mechanics style
- Heatlok lined



Part #	Mfg #	Description	Price
129331	2150HM	Medium	
129332	2150HXL	Extra Large	
129346	2150HXXL	Extra Extra Large	

High Visibility Terry Lined Yellow Knit No Logo Glove

- Black rubber palm hides dirt
- Precurved design promotes easy flexing
- Rubber palm has excellent wear and resistance
- Super fit



Part #	Mfg #	Description	Price
144702	3396HYNL	Large	
144701	3396HYNXL	Extra Large	

High Visibility Yellow Knit Glove

- Summer version
- Black rubber palm hides dirt
- Precurved design promotes easy flexing
- Rubber palm has excellent wear and resistance
- Super fit



Part #	Mfg #	Description	Price
122621	3397HYL	Large	

High Visibility Yellow Knit No Logo Glove

- Rubber palm
- Excellent wear and resistance
- Super fit



Part #	Mfg #	Description	Price
140861	3397HYNM	Medium	
140863	3397HYNL	Large	
140858	3397HYNXL	Extra Large	

Work Wear

Gloves, Ear Plugs, Goggles, ETC

High Visibility Orange Knit Glove

- Summer version
- Black rubber palm hides dirt
- Precurved design promotes easy flexing
- Rubber palm has excellent wear and resistance
- Super fit



Part #	Mfg #	Description	Price
122620	3397HOL	Large	

High Visibility Orange Knit No Logo Glove

- Rubber palm
- Excellent wear and resistance
- Super fit

Part #	Mfg #	Description	Price
140860	3397HONM	Medium	
140862	3397HONL	Large	
140859	3397HONXL	Extra Large	

Gloves, Ear Plugs, Goggles, ETC

Gloves

Gloves



Part #	Mfg #	Description	Price
030870	G50-204	Leather Palm Low Safety Cuff	

Disposable Latex Gloves

- 50 per box
- Powder free
- Large



Part #	Mfg #	Description	Price
224077	G50212	Blue Latex	

Vinyl Disposable Gloves

- 8 Pack
- Powder free
- Heavy-duty, multi-purpose
- One size fits all



Part #	Mfg #	Description	Price
190128	G50302	Blue Vinyl	

Blue Nitrile Gloves

- Powdered
- (50) Pair per box
- Thickness: 3 mil



Part #	Mfg #	Description	Price
227056	G50230	Blue Nitrile, LG/XL	
226327	G50231	Blue Nitrile, M/LG	

Disposable Respirators

Dust Mask

- Disposable
- Non Toxic



Part #	Mfg #	Description	Price
175628	G30021	Box of Dust Masks	

Safety Hats

White Safety Hat

- Meets ANSI z89.1 requirements
- Short peak design creates greater upward visibility
- Comfortable 4-point suspension with terrycloth sweatbands



Part #	Mfg #	Description	Price
188732	H40002	Fits Sizes 6-1/2-8	
188735	H40004	Fits Sizes 6-1/2-8, Ratchet Suspension	

Gloves, Ear Plugs, Goggles, ETC

Cowhide Drivers Gloves

Elastic Back Rough Rider Gloves

- Made from top-grain leather
- Deep oil tanned
- Sewn with inset, keystone thumb
- Bound at cuff with leather
- Elastic back for an easy-on easy-off fit



Part #	Mfg #	Size	Qty	Price
051840	2500-L	Large	1 Pair	

Double Palm and Chore Cotton Gloves

Galeton Gold Cotton Chore Cotton Gloves

- 18 oz Quilted gold cotton chore
- Two layers of soft cotton
- Insulated against heat and cold
- Knit wrist



Part #	Mfg #	Size	Qty	Price
051838	3112-L	Large	1 Pair	

Side Split Leather Gloves

Premium Side Split Leather Palm Gloves

- Blue
- Side-split leather work gloves for longer wear and better protection
- Safety cuff



Part #	Mfg #	Size	Qty	Price
051839	2110-L	Large	1 Pair	

Latex and Vinyl Coated Gloves

Yellow Flock Lined Latex Cleaning Gloves

- 18 Mil natural latex
- Unsupported
- Soft flock lining absorbs moisture for easy off and on



Part #	Mfg #	Size	Qty	Price
051851	6000-L	Large	1 Pair	

Grain Leather Gloves

Rough Rider Grain Leather Palm Gloves

- Made from top-grain leather
- Deep oil tanned
- Lined with 100 grams 3M Thinsulate insulation
- Heavy yellow canvas
- Knit wrists



Part #	Mfg #	Size	Qty	Price
051841	2160-L	Large	1 Pair	

Hearing Protection

MAX Ear Plugs

- Preshaped foam
- NRR33 Rated



Part #	Mfg #	Description	Qty	Price
051843	9500	Uncorded	100/Pk	

Disposable Respirators

Nuisance Dust Mask

- Filters pollen, dust and other non-toxic particles from the air
- Withstands hot and humid conditions
- Double-shell construction resists collapse
- Easily adjustable nosepiece



Part #	Mfg #	Description	Qty	Price
051842	9700	Dust Mask	50/Box	

Jersey Gloves

Men's Brown Jersey Gloves



Part #	Mfg #	Size	Qty	Price
051837	1100-L	9 oz Large	1 Pair	

Work Wear

Work Gear

Work Wear

Hooded Jacket - Black

- GridIron™ Ripstop polyester
- FreeFlex™ Mobility
- Wind and water resistant
- 100g of High-loft insulation
- Fitted hood
- Rib knit cuffs and waist



Part #	Mfg #	Description	Price
224060	252B-S	Small	
224061	252B-M	Medium	
224062	252B-L	Large	
224063	252B-XL	Extra Large	
224065	252B-2X	2X Large	
224066	252B-3X	3X Large	

WorkSkin™ Cold Weather Base Layer - Gray

- Fast wicking sweat zones move moisture away from under arms and upper back
- Durable body fabric
- Drop tail extended back
- Seamless shoulders



Part #	Mfg #	Description	Price
224068	401G-S	Small	
224069	401G-M	Medium	
224070	401G-L	Large	
224071	401G-XL	Extra Large	
224072	401G-2X	2X Large	
224073	401G-3X	3X Large	

Heated Gear

Heated Jackets

All Kits Include

- (1) M12™ Heated Jacket
- (1) M12 REDLITHIUM™ 2.0 Compact Battery Pack (48-11-2420)
- (1) M12™ Lithium-ion Battery Charger (48-59-2401)
- (1) M12™ Battery Holder with 2.1A USB Charger

M12™ 3-in-1 Heated Jacket - Black

- Chest and back zones
- Up to 8 hours of run-time
- GridIron™ Ripstop polyester
- Low profile battery
- Washer and dryer safe
- FREEFLEX™ Mobility
- 3 Heat settings: High, Med, Low



Kits

Part #	Mfg #	Description	Price
224038	251B-21S	Small	
224039	251B-21M	Medium	
224041	251B-21L	Large	
224042	251B-21XL	Extra Large	
224043	251B-212X	2X Large	
224044	251B-213X	3X Large	

Jacket Only (Less Battery Pack)

Part #	Mfg #	Description	Price
224032	251B-20S	Small	
224033	251B-20M	Medium	
224034	251B-20L	Large	
224035	251B-20XL	Extra Large	
224036	251B-202X	2X Large	
224037	251B-203X	3X Large	

M12™ Heated Jacket - Black

- Chest and back zones
- Up to 8 hours of run-time
- TOUGHSHELL™ Stretch polyester
- Low profile battery
- Washer and dryer safe
- FREEFLEX™ Mobility
- 3 Heat settings: High, Med, Low



Kits

Part #	Mfg #	Description	Price
223832	201B-21S	Small	
223833	201B-21M	Medium	
223834	201B-21L	Large	
223835	201B-21XL	Extra Large	
223837	201B-212X	2X Large	
223838	201B-213X	3X Large	

Jacket Only (Less Battery Pack)

Part #	Mfg #	Description	Price
223817	201B-20S	Small	
223827	201B-20M	Medium	
223828	201B-20L	Large	
223829	201B-20XL	Extra Large	
223830	201B-202X	2X Large	
223831	201B-203X	3X Large	

M12™ Heated Jacket - Gray

- Chest and back zones
- Up to 8 hours of run-time
- TOUGHSHELL™ Stretch polyester
- Low profile battery
- Washer and dryer safe
- FREEFLEX™ Mobility
- 3 Heat settings: High, Med, Low



Kits

Part #	Mfg #	Description	Price
223852	201G-21S	Small	
223853	201G-21M	Medium	
223854	201G-21L	Large	
223855	201G-21XL	Extra Large	
223856	201G-212X	2X Large	
223857	201G-213X	3X Large	

Heated Gear

Jacket Only (Less Battery Pack)

Part #	Mfg #	Description	Price
223841	201G-20S	Small	
223842	201G-20M	Medium	
223848	201G-20L	Large	
223849	201G-20XL	Extra Large	
223850	201G-202X	2X Large	
223851	201G-203X	3X Large	

M12™ Heated Jacket - Red

- Chest and back zones
- Up to 8 hours of run-time
- TOUGHSHELL™ Stretch polyester
- Low profile battery
- Waster and dryer safe
- FREEFLEX™ Mobility
- 3 Heat settings: High, Med, Low



Kits

Part #	Mfg #	Description	Price
223865	201R-21S	Small	
223866	201R-21M	Medium	
223973	201R-21L	Large	
223974	201R-21XL	Extra Large	
223975	201R-212X	2X Large	
223976	201R-213X	3X Large	

Jacket Only (Less Battery Pack)

Part #	Mfg #	Description	Price
223858	201R-20S	Small	
223859	201R-20M	Medium	
223860	201R-20L	Large	
223861	201R-20XL	Extra Large	
223862	201R-202X	2X Large	
223864	201R-203X	3X Large	

M12™ Heated Jacket - Realtree Xtra® Camo

- Chest and back zones
- Up to 8 hours of run-time
- TOUGHSHELL™ Stretch polyester
- Low profile battery
- Waster and dryer safe
- FREEFLEX™ Mobility
- 3 Heat settings: High, Med, Low



Kits

Part #	Mfg #	Description	Price
223983	221C-21S	Small	
223984	221C-21M	Medium	
223985	221C-21L	Large	
223986	221C-21XL	Extra Large	
223988	221C-212X	2X Large	
223989	221C-213X	3X Large	

Jacket Only (Less Battery Pack)

Part #	Mfg #	Description	Price
223977	221C-20S	Small	
223978	221C-20M	Medium	
223979	221C-20L	Large	
223980	221C-20XL	Extra Large	
223981	221C-202X	2X Large	
223982	221C-203X	3X Large	

M12™ Women's Heated Jacket - Black

- Chest and back zones
- Up to 8 hours of run-time
- TOUGHSHELL™ Stretch polyester
- Low profile battery
- Waster and dryer safe
- FREEFLEX™ Mobility
- 3 Heat settings: High, Med, Low



Kits

Part #	Mfg #	Description	Price
223990	231B-21S	Small	
223992	231B-21M	Medium	
223993	231B-21L	Large	
223994	231B-21XL	Extra Large	

Heated Gear

Heated Jackets (Continued)

M12™ Women's Heated Jacket - Black Kits

Part #	Mfg #	Description	Price
223995	231B-212X	2X Large	

Heated Hoodies

All kits include

- (1) M12™ Heated Hoodie
- (1) M12™ REDLITHIUM™ Battery (48-11-2401)
- (1) M12™ Lithium-ion Battery Charger (48-59-2401)
- (1) M12™ Battery Holder

M12™ Heated Hoodie - Black

- Chest and back zones
- Up to 6 hours of run-time
- Waffle weave lining traps heat
- Waster and dryer safe
- Durable utility pockets
- 3 Heat settings: High, Med, Low



Kits

Part #	Mfg #	Description	Price
224014	301B-21S	Small	
224015	301B-21M	Medium	
224016	301B-21L	Large	
224017	301B-21XL	Extra Large	
224018	301B-212X	2X Large	
224019	301B-213X	3X Large	

Hoodie Only (Less Battery Pack)

Part #	Mfg #	Description	Price
224008	301B-20S	Small	
224009	301B-20M	Medium	
224010	301B-20L	Large	
224011	301B-20XL	Extra Large	
224012	301B-202X	2X Large	
227263	301B-203X	3X Large	

M12™ Heated Hoodie - Gray

- Chest and back zones
- Up to 6 hours of run-time
- Waffle weave lining traps heat
- Waster and dryer safe
- Durable utility pockets
- 3 Heat settings: High, Med, Low



Kits

Part #	Mfg #	Description	Price
224002	301G-21S	Small	
224003	301G-21M	Medium	
224004	301G-21L	Large	
224005	301G-21XL	Extra Large	
224006	301G-212X	2X Large	
224007	301G-213X	3X Large	

Hoodie Only (Less Battery Pack)

Part #	Mfg #	Description	Price
223996	301G-20S	Small	
223997	301G-20M	Medium	
223998	301G-20L	Large	
223999	301G-20XL	Extra Large	
224000	301G-202X	2X Large	
224001	301G-203X	3X Large	

M12™ Heated Hoodie - Red

- Chest and back zones
- Up to 6 hours of run-time
- Waffle weave lining traps heat
- Waster and dryer safe
- Durable utility pockets
- 3 Heat settings: High, Med, Low



Kits

Part #	Mfg #	Description	Price
224026	301R-21S	Small	
224027	301R-21M	Medium	
224028	301R-21L	Large	
224029	301R-21XL	Extra Large	
224030	301R-212X	2X Large	
224031	301R-213X	3X Large	

Hoodie Only (Less Battery Pack)

Part #	Mfg #	Description	Price
224022	301R-20L	Small	
224021	301R-20M	Medium	

Heated Gear

Heated Hoodies (Continued)

M12™ Heated Hoodie - Red Hoodie Only (Less Battery Pack)

Part #	Mfg #	Description	Price
224020	301R-20S	Large	
224023	301R-20XL	Extra Large	
224024	301R-202X	2X Large	
224025	301R-203X	3X Large	

M12™ Heated Vest - Black

- Up to 6 hours of run-time
- GridIron™ Ripstop polyester
- Thermal fleece lining
- 3 Heat settings: High, Med, Low



Kits

- (1) M12™ Heated Vest - Black (Vest Only) (271B-20)
- (1) M12™ REDLITHIUM™ Battery (48-11-2401)
- (1) M12™ Battery Holder

Part #	Mfg #	Description	Price
224054	271B-21S	Small	
224055	271B-21M	Medium	
224056	271B-21L	Large	
224057	271B-21XL	Extra Large	
224058	271B-212X	2X Large	
224059	271B-213X	3X Large	

Vest Only (Less Battery Pack)

Part #	Mfg #	Description	Price
224045	271B-20S	Small	
224046	271B-20M	Medium	
224049	271B-20L	Large	
224050	271B-20XL	Extra Large	
224051	271B-202X	2X Large	
224053	271B-203X	3X Large	

Heated Hand Warmers

Kits Include

- (1) M12™ Cordless heated hand warmer only
- (1) M12™ REDLITHIUM™ battery (48-11-2401)
- (1) M12™ Lithium-ion battery charger (48-59-2401)
- (1) M12™ Battery holder

M12™ Cordless Black Heated Hand Warmer



Part #	Mfg #	Description	Price
160200	2322-21	Black Hand Warmer Kit	
160199	2322-20	Black Hand Warmer Only	

M12™ Cordless Realtree Xtra® Camo Heated Hand Warmer



Part #	Mfg #	Description	Price
160198	2321-21	Camo Hand Warmer Kit	
160197	2321-20	Camo Hand Warmer Only	

Safety Glasses

**Safety Glasses
Dakura Safety Glasses**



Part #	Mfg #	Description	Price
160443	TSM21-G15-7	Safety Glasses Polarized Silver	
160444	TSM216	Safety Glasses Black Smoke Polarized	

Kazbek Safety Glasses



Part #	Mfg #	Description	Price
160442	TSKXL-111	Safety Glasses Black Clear	
160441	TSKAP218	Safety Glasses Polarized Blue	

Zorge Saftey Glasses



Part #	Mfg #	Description	Price
160436	DZ111	Saftey Glasses Clear	
160437	DZ111-2.0	Saftey Glasses Magnifier Clear	
160438	DZ112	Saftey Glasses Yellow	
160439	DZ116	Saftey Glasses Smoke	

Wolf Peak Safety Glasses



Part #	Mfg #	Description	Price
160445	TSRAP	Reclus Polarized Black/Aqua Precision Blue	

Work Wear

Safety Glasses

Nemesis® Safety Glasses

- Single lens wrap-around



Part #	Mfg #	Description	Price
146053	G30-011	Clear	
105548	G30-012	Smoke Mirror	
128696	G30-014	Camo/Bronze	

Hellraiser Safety Glasses



Part #	Mfg #	Description	Price
135022	G30-015	Clear	
135023	G30-016	Smoke	

Safety Glasses

Safety Glasses

Sportster Safety Glasses

- Curved, wrap-around lenses
- Super-light
- 99% UV-A & UV-B Protection



Part #	Mfg #	Description	Qty	Price
080260	9200042	Indoor/Outdoor	1 Pair	

Work Wear

Shoe Covers

Shoe Covers**Waterproof Shoe Cover**

- Skid-proof soles
- Waterproof
- Multiuse or disposable
- Dispenser box
- Designed to fit over a size 18 work boot
- Dark blue



Part #	Mfg #	Description	Price
138851	20361	Waterproof Shoe Covers, Box of 50	

Shoe Covers

Shoe Covers
Shoe Liner Booty



Part #	Mfg #	Description	Price
145266	SC-1	Bx/50 Pair Shoe Liner Bootie	



Shoe Covers

Shoe Covers

Disposable Shoe Cover

- Job pack
- Blue-spun polypropylene - non-waterproof



Part #	Mfg #	Size	Price
035439	390-50175	5-15	

Work Wear

Shoe Covers

Yaktrax® Ice Traction Devices

Yaktrax® Icewalker

- *Ultra lightweight ice traction*
- *Easy on/off*
- *Spikeless patented skid lock coil system*
- *Abrasion resistant 1.2mm steel coil*
- *Rust-resistant and crush-resistant*
- *100% Satisfaction guaranteed*



Part #	Mfg #	Size	Color	Fits Shoe Size:	Price
130634	08601	Small	Black	Men's 5 to 8-1/2, Women's 6-1/2 to 10	
128220	08603	Medium	Black	Men's 9 to 11, Women's 10-1/2 to 12-1/2	
128219	08605	Large/Extra-Large	Black	Men's 11-1/2 to 13-1/2, Women's 13 to 15	

American Standard Repair Parts

Repair Parts

Faucet Repair/Replacement Parts

Diaphragm Kit

Part #	Mfg #	Description	Price
001906	72940-0700	Aquaseal Diaphragm f/Heritage (Pr)	

Toilet Repair/Replacement Parts

Flapper

Part #	Mfg #	Description	Price
026083	47146-0070A	Am Std, Rubber Flapper	

Flush Valve

Part #	Mfg #	Description	Price
001827	66287-0070A	Am Std, Cadet Flush Valve Rebuild Kit	

Tank-to-Bowl Kit

Part #	Mfg #	Description	Price
001760	47060-07	Am Std, Tank-to-Bowl Kit	

Toilet Flush Actuator

Part #	Mfg #	Description	Price
001662	33642-0700	Am Std, Toilet Actuating Valve for #5 w/Disc, Chain, Clip & Grommet	

Toilet Installation

Part #	Mfg #	Description	Price
001663	33643-0700	Am Std, Snap-on Seat Disc for 2031.016 Heritage Toilet	

Trip Lever

Part #	Mfg #	Description	Price
001778	47242-0020A	Am Std, Chrome f/Cadet II	
001779	47242-0200A	Am Std, White f/Cadet II	



Basco Repair Parts

Tub & Shower Accessories Self-Adhesive Tape

Part #	Mfg #	Description	Price
048292	SC4248	Self Adhesive Tape	

Vinyl

Part #	Mfg #	Description	Price
048294	SCV284	Tapered Drip Vinyl, 37"	

Repair Parts



Bell & Gossett Repair Parts

Check-Trol™ Isolation Flow Control Flange Sets

- Packaged with an isolation flange of the same size as a pair
- For circulator installations, gives you features of flow control valve, isolation valve and companion flange
- Cap screws and nuts included
- Maximum working pressure: 150 psi
- Maximum operating temperature: 200°F



Flange for NRF/NBF/SSF Wet Rotors (Except NRF-45 & NBF-45),
Series PL-30, PL-36, PL-55, Series 100, PR & LR

Part #	Mfg #	Model	Size	Price
079000	101232	CTF-1	1" NPT x Flange	

Pump Motors and Accessories

Power Pack Motor

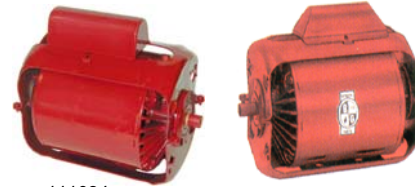

111034

111031

Part #	Mfg #	Phase	Voltage	HP	Price
002433	111034	Single	115V	1/2	
002432	111031	Single	115V	1/6	

Motor Coupler



Part #	Mfg #	Description	Price
002446	118473	For PD-35, PD-37, 60 "AA", 1522 (1/2" Shaft Frame)	
002452	118705	Pump Coupler for Series 100, HV, 2", PR	

Seal Kit

Part #	Mfg #	Description	Price
002457	186862	Seal Kit #1 1-1/4" ID Bronze Fit	

Bearing Assembly



118844

186863

Part #	Mfg #	Description	Price
002455	118844	For 100 Series NFI & BI	
048806	185332	For PD-35, PD-37, 60 "AA"; IB, BF or AB	
002462	189105	For Series PR, 2-1/2", LD-3, HD-3	
002465	189134	Series 100	

www.waterconcepts.net • Serving our Customers Since 1946 • www.plumbsupply.com



Bell & Gossett Repair Parts

Pump Motors and Accessories (Continued) Bearing Assembly

Part #	Mfg #	Description	Price
044637	189163	Obsolete 1-1/2", Obsolete 2", Obsolete HV	
044778	189165	For HV, 2", 1-1/2" Obsolete IB or BI	

Flange Gasket Set



118368

Part #	Mfg #	Description	Price
002442	118373	For 1-1/2", HV and All 1-1/2AA or 1-1/2A Models	
002441	118368	For LR, PL-30, PL-36, Series 100, PR, 60 1AA, 60 11/4AA, PL-55 and All 1AA or 1-1/4AA Models	

Parts & Accessories



Part #	Mfg #	Description	Price
002407	L23401	1.5 oz Oil Tube	

Repair Parts

Bradley Washfountain Repair Parts

Classic Washfountain Parts

Foot Valve Repair Kit

• Includes:

- S21-027 Needle assembly
- S64-006 Valve plunger assembly
- 125-001BW Gasket
- 117-016 Valve seat
- 125-001Y Diaphragm
- 124-001V Fibre washer
- 110-095 Body-needle valve
- 135-001P Spring
- 130-033 Key-valve seat

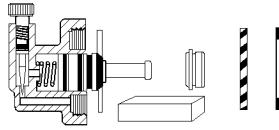

Repair Parts

Part #	Mfg #	Description	Price
002730	S65-001A	Foot Valve Repair Kit	

Chicago Faucet Repair Parts

Handles & Handle Parts



Part #	Mfg #	Description	Finish	Price
002876	369-PRJKCP	(2) 2-3/8" ADA Levers with Hot/Cold Index Buttons	CP	

Faucet Stem & Cartridge



1-099XTJKNF/1-100XTJKNF

377-XTRHJKNF/377-XTLHJK

Part #	Mfg #	Description	Finish	Price
016112	1-099XTJKNF	New Style RH Quatum™ Short Stem Unit for Exposed Valve (12/Box Only)	NF	
056563	1-099XKJKNF	RH Ceramic Short Stem Unit for Exposed Valve (12/Box Only)	NF	
016111	1-100XTJKNF	New Style LH Quatum™ Short Stem Unit for Exposed Valve (12/Box Only)	NF	
056562	1-100XKJKNF	LH Ceramic 1/4-Turn Short Stem Unit for Exposed Valve	NF	
099706	377-XKLHJKNF	LH Ceramic 1/4-Turn Long Stem Unit for Concealed Valve (Sold by box 12/Lot)	NF	
099700	377-XKRHJKNF	RH Ceramic 1/4-Turn Long Stem Unit for Concealed Valve (Sold by box 12/Lot)	NF	
002877	377-XTLHJKNF	LH Quatum™ Long Stem Cartridge for Concealed Valve (Sold by box 12/Lot)	NF	
002878	377-XTRHJKNF	RH Quatum™ Long Stem Cartridge for Concealed Valve	NF	
020910	386-XSLOJKNF	Urinal Push-Button Cartridge	NF	

Pre-Rinse Faucet Components Stainless Steel Hose/Handle Assembly

- Insulated handle
- 3/4"-14 UNS Female outlet, 3/8" MNPT inlet
- T&S & Fisher adapters supplied



Part #	Mfg #	Description	Finish	Price
068698	83-44NF	44" Stainless Steel Hose/Handle Assembly	NF	

Single Water Inlet Fittings Deck-Mount Fitting

- Solid brass body construction
- 5-1/4" Rigid/swing gooseneck spout
- 1/2" NPSM Coupling nut for 3/8" or 1/2" flexible riser
- Mounting hardware included



Part #	Mfg #	Description	Finish	Price
002897	626-E3CP	1-Hole, E3 Softflo Pressure Compensating Aerator	CP	

Chicago Faucet Repair Parts

Spouts

- Fits 1-1/16"-18 UNEF male body outlet



DJ13JKCP



L8JKCP

Part #	Mfg #	Description	Finish	Price
002797	DJ13JKCP	Double Jointed Swing Spout, 3-7/8"H, 13" Reach, E3 Softflo® Aerator	CP	
002798	DJ18JKCP	Double Jointed Swing Spout, 3-7/8"H, 17-3/4" Reach, E3 Softflo® Aerator	CP	
002811	L8JKCP	L-Type Swing Spout, 4-3/8"H, 8" Reach, E3 Softflo® Aerator	CP	
020853	L9JKCP	L-Type Swing Spout, 6-1/2"H, 9-1/2" Reach, E3 Softflo® Aerator	CP	
002810	L12JKCP	L-Type Swing Spout, 4-5/8"H, 12" Reach, E3 Softflo® Aerator	CP	
002812	S6JKCP	Swing Spout, 1-3/4"H, 6" Reach, E3 Softflo® Aerator	CP	

Gooseneck Spouts

- Available in numerous standard dimensions
- Heavy 1 1/16" OD chrome-plated brass tubing
- Inlet union nut for quick change out
- Allows for field conversion of gooseneck spouts from rigid to swing AND vice-versa

Type A Gooseneck Spout

- Designed to accept Group A spout ends
- Fits 1-1/16"-18 UNEF male body outlet



Part #	Mfg #	Description	Finish	Price
002804	GN1AE3JK	Rigid/Swing GN Spout w/13/16"-24 Male Outlet 8-3/8"H, 3-1/2" Reach	CP	
002805	GN2AE3JKCP	Rigid/Swing GN Spout, 9-3/4"H, 5-1/4" Reach, E3 Softflo® Aerator	CP	
002806	GN8AE3JKCP	Rigid/Swing Spout w/E3 Pressure Compensating Softflo® Aerator 2.2 gpm, 11-1/4"H, 8" Reach	CP	

Outlets & Adapters

- All flow rates up to 80 psi

E3 Pressure Compensating Softflo® Aerator

- Maximum flow rate: 2.2 gpm @ 60 psi
- 13/16"-24 Female inlet



Part #	Mfg #	Description	Finish	Price
002802	E3JKCP	Fits Spouts w/Group A Outlets	CP	

E12 Pressure Compensating Softflo® Aerator

- Maximum flow rate: 2.2 gpm @ 60 psi
- 13/16"-27 Male inlet



Part #	Mfg #	Description	Finish	Price
002799	E12JKCP	For Widespread & Centerset Lavatory Faucet	CP	

Chicago Faucet Repair Parts

Supply & Shank Connections/Inlets Shanks

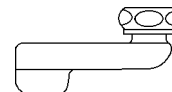

Part #	Mfg #	Description	Finish	Price
020958	HJKCP	2-1/2" Offset Inlet Supply Arm	CP	

Renewing Kits

Quatern™ & Slow Compression Unit Kit - New Style



Part #	Mfg #	Description	Price
002833	1277D	Jiffy Kit - Box of 12	

Replacement Parts



671-XJKNF

Part #	Mfg #	Description	Finish	Price
002818	1-006JKNF	Packing (50/Box Only)	NF	
002819	1-011JKNF	Rubber Washer (50/Box Only)		
002822	1-021JKNF	Rubber Seat Washer for X or XT	NF	
002823	1-022JKNF	Retainer for X or XT (100/Box Only)		
002825	1-027JKNF	Seat for X Style (100/Box Only)		
002826	1-031JKNF	Stem Washer for X Style (100/Box Only)		
002827	1-043JKNF	Cap Gasket for X Style (100/Box Only)		
134195	1-104JKNF	Spout Gland		
100595	1104-007JKNF	O-Ring		
144383	122-NF	Thermostatic Mixing Valve	NF	
139530	131-NF	Thermostatic Mixing Valve	NF	
026523	217-XTLHJKNF	LH Slo-Comp (12/Box)	NF	
002847	217-XTRHJK	RH Slo-Comp (12/Box)		
002848	244-006JKNF	Rubber Seat Washer for NAIAD Cartridges	NF	
133595	305-SVBJKCP	Rigid Atmospheric Vacuum Breaker Spout w/3/4" Hose Thread	CP	
028864	333-XSLOPSHJKNF	Pushbutton Unit with Slow-Closing Push Button Cartridge, Push Index & Adj Cycle Time Closure		
138699	420-XJKNF	Ceramic Volume & Temperature Control Cartridge	NF	
033135	671-XJKNF	Metering Valve Unit		
135738	734-CP	Vacuum Breaker Kit		
029908	734-005JKNF	Body Gasket		
134779	892-254KJKCP	Vacuum Breaker Cover & Screw Kit	CP	

Dearborn Brass Repair Parts

Repair Parts

Waste Repair Parts
Repair Part for Bath Waste

- -1 Polished chrome

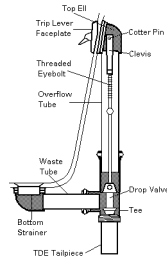

Part #	Mfg #	Description	Price
003327	4503-1	Faceplate, Trip Lever	

Cast Brass Fittings
90° Slip Joint Elbow

- Cast Brass



Part #	Mfg #	Size	Gauge	Price
175072	1675-2	1-1/2"		

Delta Faucet Repair Parts

Single-Handle Repair Parts Kit

Part #	Mfg #	Description	Price
157966	RP47270SS	Single Lever Handle Kit	
157967	RP47271	Button and Set Screw	
152794	RP52833	Single Metal Lever Handle Kit	
153001	RP60965	Single Lever Handle Kit w/ Button and Set Screw	
131775	RP63138	Single-Handle Repair Parts Kit	

Installation Aids

Quick-Connect Vegetable Spray Nipple Cap

- Converts "with spray" to "less spray"

Part #	Mfg #	Description	Price
074978	RP40301	Quick Connect Coupling, Vegetable Spray Cap	
181058	RP70613	Set Screw & Wrench	

Quick-Connect Hose

- For installing handle and spout farther apart

Part #	Mfg #	Description	Price
144185	RP50390	Hose Assembly & Clip	

Hose Assembly



Part #	Mfg #	Description	Price
055924	RP32527	Hose Assembly	

Lavatory Drains

Metal Lavatory Drain Assembly

- Metal pop-up drain
- Metal lift-rod



Part #	Mfg #	Description	Price
003641	RP5651	Chrome	
003643	RP5651PB	Polished Brass*	
093335	RP5651RB	Venetian Bronze®	
103471	RP5651SS	Stainless*	

Lavatory Drain Stopper



Part #	Mfg #	Description	Price
003637	RP5648	Chrome	
168193	RP5648CZ	Champagne Bronze™	
168478	RP5648NK	Luxe Nickel*	
159075	RP5648RB	Venetian Bronze®	
158887	RP5648SS	Stainless*	

RP51732 Lift Rod Assembly



Part #	Mfg #	Description	Price
167091	RP51732SS	Stainless*	

RP41588 Lift Rod

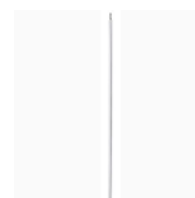

Part #	Mfg #	Description	Price
164015	RP41588	Chrome	

RP40267 Lift Rod

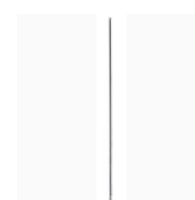

Part #	Mfg #	Description	Price
171467	RP40267	Chrome	

RP54095 Lift Rod and Finial

Part #	Mfg #	Description	Price
168032	RP26151	Chrome	
187287	RP51291	Chrome	
157901	RP54095RB	Venetian Bronze®	
153597	RP61992	Chrome	

* Brilliance® Anti-Tarnish Lifetime Finishes

www.plumbsupply.com • Serving our Customers Since 1946 • www.waterconcepts.net

Delta Faucet Repair Parts

Repair Parts

Final - Lavatory Lift Rod Top



Part #	Mfg #	Description	Price
171468	RP41574	Chrome	
173135	RP41574SS	Stainless*	

Lavatory Drain Flange



Part #	Mfg #	Description	Price
168192	RP23060CZ	Champagne Bronze™	
149920	RP23060SS	Stainless*	

Bath Installation Aids

Delta® Extension Kits

- Adds 1" to shanks



Part #	Mfg #	Description	Price
051857	RP10612	For 3530/3540/3543/3544/ 3555/3665/3567/3569/ 3577/3578/3583	

RP31845 Extension Kit



Part #	Mfg #	Description	Price
046440	RP31845	Extension Kit	

TempAssure® 17T Series Extension Kit

- Additional 1-3/4" installation



Part #	Mfg #	Description	Price
183263	RP75136	Extension Kit - 17T Series	

Monitor 14 Series MultiChoice Extension Kit



Part #	Mfg #	Description	Price
231280	RP77991	Extension Kit - 14 Series	

3 And 6-Setting Diverter Extension Kit



Part #	Mfg #	Description	Price
157035	RP75137	Extension Kit - Diverter	

Delta® Horizontal Rod



Part #	Mfg #	Description	Price
003436	RP12517	Chrome	

Conversion Ball

- Converts knob to lever handle
- Makes faucet ADA compliant



Part #	Mfg #	Description	Price
003587	RP20111	Conversion Ball	

6-Setting Diverter Cartridge



Part #	Mfg #	Description	Price
135236	RP51919	Diverter Cartridge	

3-Setting Non-Shared Diverter Cartridge



Part #	Mfg #	Description	Price
163268	RP71718	Diverter Cartridge	

* Brilliance® Anti-Tarnish Lifetime Finishes

www.waterconcepts.net • Serving our Customers Since 1946 • www.plumbsupply.com

Delta Faucet Repair Parts

2-Hdl DIAMOND™ Valve Assembly



Part #	Mfg #	Description	Price
148058	RP60400	Valve Assy	

Euro-Motion™ Valve Assembly



Part #	Mfg #	Description	Price
153040	RP60114	Valve Assy	

Euro-Motion™ Ceramic Valve



Part #	Mfg #	Description	Price
187321	RP75402	Ceramic Valve	

Multi-Choice® Universal Cartridge Assembly -13/14 Series

- Monitor® single-function pressure-balance cartridge
- Rotational limit stop easily adjusts via lift and turn
- For MultiChoice® universal 13/14 series tub and showers



Part #	Mfg #	Description	Price
095758	RP46074	Cartridge Assy	

Multi-Choice® Universal Cartridge Assembly -17 Series

- Monitor® dual-function pressure- balance control
- For MultiChoice® 17 series tub and showers
- Allows for separate volume and temperature control



Part #	Mfg #	Description	Price
102530	RP46463	Cartridge Assy	

Multi-Choice® Universal Cartridge Assembly -17T Series

- TempAssure® dual-function thermostatic cartridge
- For Multi-Choice® 17T series trim
- Allows for separate volume and temperature control



Part #	Mfg #	Description	Price
115704	RP47201	Cartridge Assy	

Diverter Assembly



Part #	Mfg #	Description	Price
003529	RP17730	Diverter Assembly	
035054	RP19653	Diverter Assembly	

Stem Cartridge Kit - (2)



Part #	Mfg #	Description	Price
170775	RP41701	Stem Cartridge Kit	

Two Handle Ceramic Stem Cartridge - (Pair)



Part #	Mfg #	Description	Price
167855	RP47422	Stem Cartridge - Pair	

Stem Unit Assembly

- Includes:
 - Seat
 - Spring
 - Bonnet Nut
 - Washer



Part #	Mfg #	Description	Price
171576	RP54801	Stem Unit Assy	

* Brilliance® Anti-Tarnish Lifetime Finishes

www.plumbsupply.com • Serving our Customers Since 1946 • www.waterconcepts.net

Delta Faucet Repair Parts

Repair Parts

Metering Valve



Part #	Mfg #	Description	Price
166640	RP72773	Metering Valve	

Valve Cartridge



Part #	Mfg #	Description	Price
164727	RP50265	Valve Cartridge	

Non-Shared Diverter Cartridge



Part #	Mfg #	Description	Price
166480	RP71717	2-Function Non-Shared Diverter Cartridge	

Cartridge Fluehs



Part #	Mfg #	Description	Price
155280	RP61824	Cartridge Fluehs - Cold	
154243	RP61825	Cartridge Fluehs - Hot	

RP42410 Cartridge Assembly



Part #	Mfg #	Description	Price
125499	RP42410	Diverter Cartridge	

Cer-Tek Cartridge

• RH

Part #	Mfg #	Description	Price
130298	063000A	RH Cer-Tek Cartridge	
130299	063001A	LH Cer-Tek Cartridge	

Thin Wall Installation Aid

• For MultiChoice® universal thin mount installation aid



Part #	Mfg #	Description	Price
094435	RP47202	Thin Mount Aid	

Shower Renovation Cover Plate

• Covers up 8" center holes



Part #	Mfg #	Finish	Price
040814	RP29827	Chrome	
130864	RP29827RB	Venetian Bronze®	
134118	RP29827SS	Stainless*	

Deep Escutcheon



Part #	Mfg #	Description	Price
222353	RP21633SS	Stainless*	

600 Series Escutcheon - Shallow



Part #	Mfg #	Description	Price
040905	RP6083	Chrome	

* Brilliance® Anti-Tarnish Lifetime Finishes

www.waterconcepts.net • Serving our Customers Since 1946 • www.plumbsupply.com

Delta Faucet Repair Parts

600 Series Tub and Shower Renovation Kit

- Includes:
 - RP17443RB - Lever handle
 - RP5883RB - Escutcheon
 - RP1050RB - Cap
 - RP5893RB - Sleeve
 - RP196RB - Escutcheon screws
 - RP20111 - Conversion ball
 - RP4993 - Seats and springs
 - RP188 = Cam and packing
- Order RP2865 plug for push button diverter
- Diverter tub spout may be required



Part #	Mfg #	Finish	Price
132394	RP54870	Chrome	
132395	RP54870RB	Venetian Bronze®	
129199	RP54870SS	Stainless*	

1900 Conversion Trim Kit



Part #	Mfg #	Description	Price
164080	RP54316	Chrome	
171340	RP54318	Chrome	
167369	RP54318RB	Venetian Bronze*	

6-Setting Diverter Escutcheon

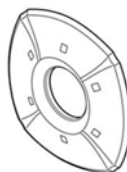

Part #	Mfg #	Description	Price
154615	RP61658SS	Stainless*	

Deep Escutcheon with Push Button Diverter



Part #	Mfg #	Description	Price
162814	RP21634	Escutcheon, Chrome	

Escutcheon

- Diagonal escape screw holes



Part #	Mfg #	Description	Price
032826	RP19809	Chrome	
157469	RP19809SS	Stainless*	

Escutcheon - Shallow



Part #	Mfg #	Description	Price
043944	RP7577	Chrome	

Escutcheon - Deep

- 1-13/16" Inside diameter



Part #	Mfg #	Description	Price
018419	RP6019	Chrome	

Tub & Shower Escutcheon

- Square



Part #	Mfg #	Description	Price
154796	RP52583RB	Venetian Bronze®	

Dryden™ 6-Setting Diverter Escutcheon

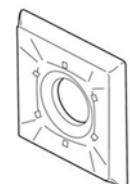

Part #	Mfg #	Description	Price
154795	RP52594RB	Venetian Bronze®	

* Brilliance® Anti-Tarnish Lifetime Finishes

www.plumbsupply.com • Serving our Customers Since 1946 • www.waterconcepts.net

Delta Faucet Repair Parts

Repair Parts

6-Setting Diverter Escutcheon



Part #	Mfg #	Description	Price
179525	RP42413RB	Venetian Bronze®	

Escutcheon - 14 Series



Part #	Mfg #	Description	Price
154524	RP48716	Chrome	

Escutcheon/Seal - 14 Series

Part #	Mfg #	Description	Price
167604	RP75436	Chrome	

Escutcheon Trim Screws

- Set of 2



Part #	Mfg #	Description	Price
087663	RP196SS	Stainless*	

Jetted Shower XO® Stem Extender

Part #	Mfg #	Description	Price
135242	RP37902	Stem Extender	
100606	RP37903	Stem Extender	

Handshower Assembly



Part #	Mfg #	Description	Price
159519	RP52589SS	Stainless*	

Kitchen Spray Assemblies

Victorian® Spray and Hose Assembly

- To be used for DIAMOND™ seal technology models



Part #	Mfg #	Description	Price
164086	RP37489SS	Stainless*	

Classic Spray & Hose Assembly

- To be used for non-DIAMOND™ seal technology models



Part #	Mfg #	Description	Price
074675	RP39360	White	

Signature® Waterfall® Spray & Hose Assembly

- To be used for non-DIAMOND™ seal technology models
- Includes nest



Part #	Mfg #	Finish	Price
098546	RP39345	Chrome	
091323	RP39345SS	Stainless*	

Pilar® Linden™ Spray, Hose and Diverter Assembly

- To be used for DIAMOND™ seal technology models
- Touch-Clean® spray holes
- Front trigger control
- Finished spray face



Part #	Mfg #	Description	Price
185590	RP53880	Chrome	
165648	RP53880AR	Arctic Stainless	
156781	RP53880RB	Venetian Bronze®	

* Brilliance® Anti-Tarnish Lifetime Finishes

www.waterconcepts.net • Serving our Customers Since 1946 • www.plumbsupply.com

Delta Faucet Repair Parts

Victorian® Spray, Hose, and Diverter Assembly

- To be used for DIAMOND™ seal technology models



Part #	Mfg #	Description	Price
170824	RP53881RB	Venetian Bronze®	

Collins™ Spray, Hose and Diverter Assembly

- To be used for DIAMOND™ seal technology models
- Touch-Clean® spray holes
- Finished spray face



Part #	Mfg #	Description	Price
130164	RP54235	Chrome	
144787	RP54235SS	Stainless*	

Cassidy™ Spray and Hose Assembly

- Touch-Clean® spray holes
- Front trigger control
- Finished spray face



Part #	Mfg #	Description	Price
167693	RP72751	Chrome	

Spray and Hose Assembly



Part #	Mfg #	Description	Price
179527	RP61013RB	Venetian Bronze*	

Classic and Signature® Spray & Hose Assembly

- To be used for single handle non-DIAMOND™ seal technology models
- Finished sprayer



Part #	Mfg #	Finish	Price
044116	RP31612	Chrome	

Spray & Hose Assembly



Part #	Mfg #	Finish	Price
058833	RP28900	Chrome	
059165	RP28900SS	Stainless*	
168533	RP32250BN	Brushed Nickel*	

Kitchen Spray Assembly



Part #	Mfg #	Description	Price
224779	RP43524SS	Stainless*	

Classic Spray, Hose and Diverter Assembly

- To be used for DIAMOND™ seal technology models



Part #	Mfg #	Finish	Price
134487	RP60097	Chrome	
180881	RP60097SS	Stainless*	

Foundations® Spray, Hose Assembly and Spray Support

- Lead free
- For single handle kitchen models



Part #	Mfg #	Description	Price
145981	RP54807	Chrome	
187325	RP54807SS	Stainless*	

* Brilliance® Anti-Tarnish Lifetime Finishes

www.plumbsupply.com • Serving our Customers Since 1946 • www.waterconcepts.net

Delta Faucet Repair Parts

Repair Parts

Spray Support Assembly



Part #	Mfg #	Description	Price
003664	RP6015	Chrome	

Quick-Connect Vegetable Spray Hose



Part #	Mfg #	Description	Price
103219	RP37034GR	White	

2-Hdl Kitchen or Lavatory 16" Hose



Part #	Mfg #	Description	Price
003676	RP6050	White	

Pull-Out Wand Assembly



Part #	Mfg #	Description	Price
154289	RP53102AR	Arctic Stainless™	
147391	RP53102SS	Stainless*	

Pull-Down Wand Assembly



Part #	Mfg #	Description	Price
160975	RP72680AR	Pull-Down Wand Assembly	

Wand Assembly



Part #	Mfg #	Description	Price
182191	RP51480	Chrome	
156754	RP51480RB	Venetian Bronze®	
152052	RP51480SS	Stainless*	

Spray Assembly



Part #	Mfg #	Description	Price
181927	RP46751SS	Stainless*	

Pull-Down Spray Assembly

- Includes aerator



Part #	Mfg #	Description	Price
159024	RP47269SS	Stainless*	

Fuse Pull-Down Wand Assembly

Part #	Mfg #	Description	Price
175890	RP70703SB	Stainless*/Cracked Pepper	

Sprayer Wand Assembly

- Pull-out faucets



Part #	Mfg #	Description	Price
152076	RP53438SS	Stainless*	

* Brilliance® Anti-Tarnish Lifetime Finishes

www.waterconcepts.net • Serving our Customers Since 1946 • www.plumbsupply.com

Delta Faucet Repair Parts

Wand Assembly with Hose

- Pull-out faucets



Part #	Mfg #	Description	Price
063196	RP32542	Chrome	
161322	RP32542AR	Arctic Stainless™	
162140	RP32542BL	Matte Black	
081006	RP32542SS	Stainless*	

Palo Wand Assembly



Part #	Mfg #	Description	Price
117444	RP44643	Chrome	
168840	RP44643SS	Stainless*	

RP44477 Pull-Out Wand Assembly



Part #	Mfg #	Description	Price
168481	RP44477SS	Stainless*	

Soap/Lotion Dispenser Accessories

Soap/Lotion Dispenser Nut

Part #	Mfg #	Description	Price
037864	RP21945	Dispenser Nut	

Soap/Lotion Dispenser Body Assembly



Part #	Mfg #	Description	Price
187739	RP21906SS	Stainless*	

Soap/Lotion Dispenser Pump Head



Part #	Mfg #	Description	Price
160946	RP21905SS	Stainless*	

Kitchen Accessories

Sliding Weight

- For use with Pull-Down/Out kitchen faucets



Part #	Mfg #	Description	Price
188349	RP49149	N/A	

Kitchen Diverter Assembly

- Diverter assembly kit 1-handle Delta® replacement

Part #	Mfg #	Description	Price
133121	RP63135	Kitchen Faucet Diverter Assembly	
136138	RP63135MBS	Diverter Assembly	
132777	RP63136	1-Handle Diverter Assembly	
133157	RP63136MBS	Kitchen Diverter Assembly	

* Brilliance® Anti-Tarnish Lifetime Finishes

www.plumbsupply.com • Serving our Customers Since 1946 • www.waterconcepts.net

Delta Faucet Repair Parts

Repair Parts

8" Escutcheon



Part #	Mfg #	Description	Price
149596	RP64070	Chrome	
146679	RP64070AR	Arctic Stainless™	
162388	RP64070CZ	Champagne Bronze™	

Escutcheon and Gasket



Part #	Mfg #	Description	Price
189018	RP77702	Chrome	

Escutcheon, Base, and Gasket



Part #	Mfg #	Description	Price
148562	RP64472AR	Arctic Stainless™	
168129	RP64472SS	Stainless*	

Square Escutcheon



Part #	Mfg #	Description	Price
153685	RP63970RB	Venetian Bronze®	
143753	RP63970SS	Stainless*	

Escutcheon - 3 Hole



Part #	Mfg #	Description	Price
170028	RP44645SS	Stainless*	

10" Escutcheon



Part #	Mfg #	Description	Price
158527	RP47274AR	Arctic Stainless™	
158533	RP47274RB	Venetian Bronze®	

Escutcheon, Gasket (3-Hole)



Part #	Mfg #	Description	Price
225247	RP72991SS	Stainless*	

Decorative Escutcheon

- 10" Long



Part #	Mfg #	Description	Price
158526	RP71545	Chrome	
154412	RP71545AR	Arctic Stainless™	
158563	RP71545CZ	Champagne Bronze™	
153577	RP71545RB	Venetian Bronze®	

Shallow Escutcheon

- Pressure balance diverter off indicator

Part #	Mfg #	Description	Price
076614	RP6107	Chrome	

* Brilliance® Anti-Tarnish Lifetime Finishes

www.waterconcepts.net • Serving our Customers Since 1946 • www.plumbsupply.com

Delta Faucet Repair Parts

Handle Base

- Square handle bases
- Sold in pairs
- Includes flange support, gasket and set screw



Part #	Mfg #	Description	Price
157758	RP52659SS	Stainless*	

Flow Control for Gooseneck Spout

Part #	Mfg #	Description	Price
170888	060873A	Flow Control	

Mounting Hardware



Part #	Mfg #	Description	Price
186978	RP52609	Mounting Hardware	

Pilar® Check Valves



Part #	Mfg #	Description	Price
138069	RP53468	Pilar® Check Valves	

Shower Parts

Single Lever Handle Kit - 17T Series



Part #	Mfg #	Description	Price
153179	RP51309SS	Stainless*	

17 Series Handle Assembly - Temp



Part #	Mfg #	Description	Price
184230	RP70641	Chrome	

13/14 Series Handle Assembly



Part #	Mfg #	Description	Price
132336	RP48717	Chrome	
143667	RP48717SS	Stainless*	

Handle Assembly



Part #	Mfg #	Description	Price
164895	RP73643	Chrome	
186959	RP72685RB	Venetian Bronze®	

Temperature Dial



Part #	Mfg #	Description	Price
163903	RP73642	Chrome	

Single Lever Handle Kit - 17 Series



Part #	Mfg #	Description	Price
067929	RP32103	Chrome	

* Brilliance® Anti-Tarnish Lifetime Finishes

www.plumbsupply.com • Serving our Customers Since 1946 • www.waterconcepts.net

Delta Faucet Repair Parts

Repair Parts

Trim Sleeve - Tub & Shower



- Clip only
- Quick-connect

Hose Clip



Part #	Mfg #	Description	Price
157460	RP50879RB	Venetian Bronze®	
166988	RP50879SS	Stainless*	

Part #	Mfg #	Description	Price
144186	RP60911	Hose Clip	

Trim Sleeve - 17 and 18 Series



Valve Sleeve Assembly



Part #	Mfg #	Description	Price
151398	RP50880RB	Venetian Bronze®	
151435	RP50880SS	Stainless*	

Part #	Mfg #	Description	Price
172344	RP51481RB	Venetian Bronze®	

Trim Sleeve - Tub & Shower



Bar Slide Knob



Part #	Mfg #	Description	Price
031006	RP5893	Chrome	

Part #	Mfg #	Description	Price
175920	4116BX	For Models 55024 & 55030, Clear	

Trim Sleeve - 13 and 14 Series



Bath Waste Parts

Bath Waste Assembly

- Toe-operated
- 13-1/2" Max vertical adjustment
- 7-3/4" max horizontal adjustment
- Brass construction



Part #	Mfg #	Description	Price
172685	RP22735SS	Stainless*	
096706	RP39407	14 Series Only, Chrome	

Part #	Mfg #	Description	Price
177578	RP293	Chrome	
143839	RP693CZ	Champagne Bronze™	

Copper Plug - Shower Only



Part #	Mfg #	Description	Price
021656	RP20032	Copper	

* Brilliance® Anti-Tarnish Lifetime Finishes

www.waterconcepts.net • Serving our Customers Since 1946 • www.plumbsupply.com

Delta Faucet Repair Parts

Tub Drain

- Toe-operated
- Stopper and waste plug
- Stopper screw threads are 5/16"-18



Part #	Mfg #	Description	Price
159165	RP31558CZ	Champagne Bronze™	

Overflow Plate Assembly

- Trip lever



Part #	Mfg #	Description	Price
078455	RP6403RB	Venetian Bronze®	

Waste Plug

- Toe operated
- 1-1/2"-11-1/2" NPSM



Part #	Mfg #	Description	Price
166059	RP16687	Chrome	

Bonnet Cap

- With adjusting ring



Part #	Mfg #	Finish	Price
003631	RP50	Chrome	

Stopper Assembly

- Toe operated
- 5/16" - 18" thread size



Part #	Mfg #	Description	Price
177577	RP16686PN	Polished Nickel	

Mini-Bulk Parts

Aerator

- 15/16" - 27 Male thread
- For most kitchen and lavatory faucets
- 2.2 gpm @ 60 psi



Part #	Mfg #	Description	Price
022154	RP330MBS	Chrome, 60 Per Case	

Cam and Packing-Knob

- For single knob handle faucets



Part #	Mfg #	Description	Price
003552	RP188	For Single Knob Handle	
017861	RP188MBS	64 Per Case	

Cam & Packing - Lever

- For single lever handle faucets



Part #	Mfg #	Description	Price
017522	RP61MBS	64 Per Case	

Seat

- For all 1-handle and 2-handle faucets



Part #	Mfg #	Description	Price
022156	RP1806MBS	240 Per Case	

Spring

- For all 1-handle and 2-handle faucets



Part #	Mfg #	Description	Price
022158	RP3427MBS	240 Per Case	

Seats, Springs, Quad Rings

- Qty. 2



Part #	Mfg #	Description	Price
063896	RP28603	Seats, Springs, Quad Rings	

Repair Parts

* Brilliance® Anti-Tarnish Lifetime Finishes

www.plumbsupply.com • Serving our Customers Since 1946 • www.waterconcepts.net

Delta Faucet Repair Parts

Repair Parts

Seats & Springs Boxed Assortment Kit



Stem Unit with Stainless Steel Plate

- For 2-handle and basin faucets



Part #	Mfg #	Description	Price
003740	RP4039	Seats & Springs 24-RP4993	

Part #	Mfg #	Description	Price
003515	RP1740	Stem Unit Assy	
022155	RP1740MBS	Stem Unit Assy, 60 Per Case	

Ceramic Seats and Seals

- Qty. 2



Delta® Plumber's Box of Parts



Part #	Mfg #	Description	Price
020357	RP10700	Ceramic Seats and Seals	

Part #	Mfg #	Description	Price
134141	RP63139	Plumber's Box of Parts	

Stainless Steel Ball - Knob

- For single knob handle faucets except 1300, 1400 & 1600 tub/shower series and pull-out spray models



Delta® Repair Kits/Parts

Ball Assemblies

Part #	Mfg #	Description	Price
022152	RP212MBS	60 Per Case	

Part #	Mfg #	Description	Price
003724	RP70	For 1-H Lever	
003592	RP212	For 1-H Knob	

Stainless Steel Ball - Lever

- For single lever handle faucets except 1300, 1400, 1500, 1600, 1700 & 1800 T/S series and pull-out spray models



O-Rings

Part #	Mfg #	Description	Price
022151	RP70MBS	60 Per Case	

Part #	Mfg #	Description	Price
114466	RP13938	O-Ring	
154097	RP18362	O-Ring	
003605	RP25	1-Hdl Kit Spout	
003589	RP2055	For 2-H Kitchen Spout	
019817	RP21535	For 462/466	
040285	RP22934	For 2-H Waterfall® Kitchen Deck	
061918	RP32520	Spout O-Rings for 470 & 472	
178227	RP50388	O-Ring	
170777	RP73984	Clip and O-Ring	
071330	RP14414	13/14 Series Qty. 2	
003585	RP20049	O-Ring	
043131	RP23336	O-Ring F/1400	

Stem Unit & Seat

- For 1600 tub/shower series

Part #	Mfg #	Description	Price
003582	RP1991	Stem Unit & Seat	
022157	RP1991MBS	Stem Unit & Seat, 12 Per Case	

* Brilliance® Anti-Tarnish Lifetime Finishes

www.waterconcepts.net • Serving our Customers Since 1946 • www.plumbsupply.com

Delta Faucet Repair Parts

O-Ring

- For 100/200/300/400 single-handle kitchen deck faucets manufactured since 1969 models



Part #	Mfg #	Description	Price
022150	RP25MBS	120 Per Case	

Screws

Part #	Mfg #	Description	Price
003437	RP12630	Escutcheon Trim Screws, Extra Long	
155211	RP12630RB	Escutcheon Trim Screws, Extra Long - Ven Bronze®	
003496	RP152	For Single Lever Handle	
003564	RP196	Chrome	
033496	RP25620	Set Screws for Small Handle Bases	
032801	RP26865	Set Screws for Large Handle Bases	
168960	RP40650	Set Screw	
157647	RP54170B	Escutcheon Screws (2)	
158261	RP61819	On Wall Screws 4 Lengths	

Delta® Repair Parts

Part #	Mfg #	Description	Price
111465	060683A	Hard Wire Converter	
188507	063093A	R3 Spout for 54T2402	
144039	060602A	Sngl Blade Hdl w/ Screw	
217207	4124CBG	Cap - GL Rail BG	
028507	4959BG	Rubber Gaskets - Bag of 5	
177587	EP73954	AP Power Supply	
178564	EP74852	Solenoid Assembly	
183919	EP74854	Solenoid Assembly	
109632	RP1050	Bonnet Nut	
188994	RP11768HDF	Commercial Lever Handles, Brass w/ Screws	
026356	RP12629	Screw Set	
099577	RP16213	Screwdriver Stop Assembly	
003512	RP16423	Reverse Ball	
019240	RP18090	Escutcheon	
025093	RP18276	Chrome Escutcheon	
025092	RP18136	Sleeve, Chrome	
003591	RP2090	Check Stop Stem Assembly	
029096	RP21463	Retainer - Spout	
033619	RP21469	1Hdl Lever Kit with Screw	
154634	RP21469SS	1Hdl Lever Kit with Screw	
086213	RP23094SS	Handle Base w/ Gasket	

Delta® Repair Parts (Continued)

Part #	Mfg #	Description	Price
003597	RP2389	Clear 1-Handle Lavatory w/Button & Screw	
003599	RP2391	Clear Knob w/Button & Screw	
003601	RP2393	1 Kitchen Lever Handle w/Set Screw	
003603	RP2411	Button, Clear	
003608	RP250	Adjusting Ring	
031329	RP250MBS	Adjusting Ring	
165820	RP26758	Screw On Sleeve	
044850	RP28595	Temp Knob and Cover	
054794	RP29569	Spacer	
059633	RP33805	10-1/8" Horizontal Rod	
003623	RP3614	Lever Repair Kit	
155976	RP37022SS	Bonnet, Washer and Clip	
161873	RP42168SS	Body Spray Escutcheon	
171342	RP42208	Wrench	
168961	RP46748SS	1-Hdl with Button and Screw	
164132	RP47030	Lavatory Wrench	
003630	RP4993	Deluxe Seats & Springs (2)	
122686	RP50366	Stem Assembly w/ O-Rings and Nuts	
144187	RP51503	Bonnet Nut	
132784	RP52834	Single Metal Lever Handle Kit	
131263	RP53997	Diverter Clip	
003639	RP5649	Diverter Assembly, Chrome	
003649	RP574	Balance Spool Assembly	
003657	RP5861	Coupling Nuts	
003662	RP6011	Hose & Spray, Black/CP	
003678	RP6060	Nut	
003681	RP6068	Plug Button	
037831	RP6079	Bonnet, Chrome	
040904	RP6081	Sleeve, Chrome	
003687	RP6092	Nuts & Washers	
003695	RP6130	Pivot Seat & Gasket	
153121	RP61820	Stem Assembly	
003705	RP6183	Locknuts	
224647	RP64240	Mounting Bracket	
227492	RP64288	Gasket for 400DST	
151297	RP64696	Spout Assembly - Locked	
003734	RP8230	Ceramic Stem, Seat, O-Ring, Spring	
003434	RP12491	(2) HDF Wrist Blade Handles w/Set Screw	
024497	RP12490	Screws - Red and Blue	
003520	RP17449	Clear Handle w/Button & Screw, for Single Handle Faucet	

* Brilliance® Anti-Tarnish Lifetime Finishes

www.plumbsupply.com • Serving our Customers Since 1946 • www.waterconcepts.net

Delta Faucet Repair Parts

Repair Parts

Delta® Repair Parts (Continued)

Part #	Mfg #	Description	Price
023197	RP17451	Clear Handle w/Button & Screw, for Tub & Shower	
024762	RP18627	Extender less Screws	
003568	RP19659	Button	
003572	RP19804	Cartridge Assembly	
022311	RP19807	Limit Stop	
049620	RP22734	Plated Bonnet	
187688	RP23094CZ	Handle Base & Gasket	
030260	RP23498	Clear Knob Handle w/Screws	
185875	RP23611RB	Base with Gasket	
024314	RP24096	Brass Stem Assy	
003604	RP2412	Two Handle Blade (2)	
050183	RP25513	Stem Unit w/Brass Stem	
137175	RP2865	Plug Push Button Diverter	
071395	RP28906	Red/Blue Indicator	
179884	RP30532	Battery Holder	
045840	RP32104	1700 Cartridge	
067930	RP32105	1700 Handle Screw	
048950	RP32522	Quick-Connect Clip	
120382	RP34359RB	Trim Ring - 14 Series	
151759	RP36203	Ext Nut and Washer for Electronic Fct	
187883	RP38367	End Valve Assembly	
184164	RP41702	2Hdl Kitchen Diverter	
181968	RP38644RB	Escutcheon and Gasket	
140695	RP40668	R4700 Diverter Valve Assembly	
101730	RP41478	Nut and Adapter	
174179	RP44118BN	Handle Kit, Brushed Nickel	
161938	RP44118OB	Handle Kit, Oil-Rubbed Brz	
172682	RP44123	Repair Kit	
184827	RP44493	Hose Assembly	
107694	RP44647	Pull-Out Hose Assembly	
144594	RP46079	Pressure Test Hot/Cold Plug	
186204	RP47029	Lavatory Mounting Bracket	
157015	RP48592	Single Lever Handle Kit	
169900	RP49835	Mounting Nut	
169899	RP50391	Gasket and Baseplate	
107655	RP51099	7' Leader Hose for Roman Tub	
160483	RP51290SS	Roman Tub Hand Shower Base Escutcheon	
223508	RP51306RB	17 Series Handle Kit	
187868	RP51306SS	17 Series Handle Kit	
151859	RP51307	1-Hdl Lever Handle Kit	
223509	RP51307RB	17 Series Handle Kit	

Delta® Repair Parts (Continued)

Part #	Mfg #	Description	Price
187869	RP51307SS	17 Series Handle Kit	
161418	RP51345	Aerator - 1.5 GPM	
187690	RP51424	Temperature Knob and Cover	
160738	RP51479RB	Valve Sleeve Assembly	
222638	RP51502AR	Bonnet Cap	
173807	RP51514SS	Sleeve Assembly	
157876	RP51628RB	Escutcheon & Gasket	
154211	RP51685	Mounting Bracket and Nut	
179559	RP52147SS	Temp Knob and Cover	
164030	RP53879	Handle Button	
166762	RP53879SS	Handle Button, Stainless*	
131262	RP54269	Spray Cap	
157044	RP54974	Hot/Cold Indicator	
137154	RP60923	Kitchen Repair Part	
135054	RP43233	D-Spacer 14 Series	
155781	RP50389	Escutcheon and Gasket	
122117	RP50587	Single Handle Valve Cartridge	
161889	RP51490	Escutcheon - Single Handle Kitchen Faucet	
154210	RP52610	Trim Ring, Base & Gasket	
164131	RP53217	Mounting Hardware - Valve	
176568	RP53531	Mounting Nuts	
173987	RP54232	Handle Kit, Chrome	
181486	RP54232SS	Handle Kit, Stainless	
166331	RP54687	Single Lever Elbow Handle	
153810	RP60962	Escutcheon and Gasket	
177033	RP60979	Trim Ring, Base and Gasket	
003688	RP61	Cam Assembly - Lever	
158729	RP6148	Escutcheon	
177305	RP61839RB	Escutcheon - Single Hole	
151718	RP6185	Stop Stem Assembly	
155272	RP62094SS	Handle Base w/ Gasket	
177217	RP62150SS	Handle Kit	
171385	RP62961	Bidet Base, Chrome	
164948	RP62961SS	Bidet Base, Stainless	
154459	RP63131	Spout Assembly	
175400	RP63265	1/2" Slip Joint Adapter	
187192	RP64150SS	Mounting Post	
187191	RP64152SS	Slide Mechanism	
158670	RP64706	Handle Kit - 2-Hdl	
158671	RP64760	Stem Unit Assembly	
173247	RP64851	Diverter Bonnet Nut	
181639	RP70635RB	Roman Tub 2-Hdl Handle Kit	
181640	RP70637RB	Handle Flange, Ven Brz	
185771	RP70638RB	Diverter Lift Rod	

* Brilliance® Anti-Tarnish Lifetime Finishes

www.waterconcepts.net • Serving our Customers Since 1946 • www.plumbsupply.com



Delta Faucet Repair Parts

Delta® Repair Parts (Continued)

Part #	Mfg #	Description	Price
168736	RP70639RB	Shower Handle Assembly, Ven Bronze	
178178	RP72289	Lift Rod Plug	
185650	RP72721SS	Handshower Base	
180482	RP73054	Gaskets	
155687	RP73192	Red/Blue Button	
168272	RP73837	Low Flow Regulator	
177576	RP7424PN	Overflow Plate	
156883	RP7424RB	Overflow Plate	
181717	RP74608	54" PO Hose (Small OD)	
181034	RP74812	O-Rings	
173787	RP75408	Rectangular Aerator, Set Screw	
187322	RP75409	Flow Regulator	
170776	RP76691	Centerset Extension Kit	
185305	RP77162	Escutcheon	
186205	RP77263SS	Escutcheon - 3 Hole	
186203	RP77457SS	Button - Lift Rod Hole Cover	
166060	RP7900	Gasket	
225577	RP81914	Mateo® Escutcheon	
186097	RP83888	Valve Bracket	

Repair Parts

* Brilliance® Anti-Tarnish Lifetime Finishes

www.plumbsupply.com • Serving our Customers Since 1946 • www.waterconcepts.net

Elkay Repair Parts

Elkay Sink Parts & Accessories
Mounting Clip



Repair Parts

Part #	Mfg #	Description	Price
006122	LK-363	Long Sink Clips	
104709	LK-463	Elkay Sink Clips for 1-5/8", 2", 2-1/2" Thick Tops	
162112	LKUCLIP8	Mounting Clip for Undermount Sinks	

Replacement Part

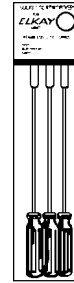

Part #	Mfg #	Description	Price
006120	LK-350	Socket Screwdriver	

Elkay Repair Parts



35981-C



50986-C

Water Cooler Parts



55996-C



61313-C



61314-C

Part #	Mfg #	Description	Price
023576	31513C	Elkay Cold Control	
086622	35981C	Elkay 1/4 Solenoid Valve	
022839	50985C	Holder Regulator	
060511	50986C	Holder Regulator	
045589	55996C	Cooler Y-Strainer	
006168	61313C	Cartridge for Water Cooler	
024551	61314C	Green Cartridge	

EZH2O™ Parts
WaterSentry® Filters

- CTO Filters
- Features:
 - Quick-disconnect
 - 1/4 Turn installation
 - Hand never touch the actual filter media
 - Outer protective wrap
- NSF/ANSI 42 and 53 certified

Part #	Mfg #	Flow Rate	Rated	Full Load	Ship Wt	Description	Price
162211	EWf3000					Complete Kit, 3000 Gallon Filtration System	
189544	WSF6000R2PK					6000 Gallon, 2-pack	
132220	51300C					3000 Gallon, 1-Pack	
164978	51300C12PK					3000 Gallon, 12-Pack	
132222	51300C3PK					3000 Gallon, 3-Pack	

Repair Parts



Empire Comfort Repair Parts

Replacement Parts

Blower

Part #	Mfg #	Description	Price
127041	FBB-4	Variable-Speed Blower	

Repair Parts

Fenner Drives Repair Parts

Belts

PowerTwist Plus® V-Belt

- *No tools required, assembles in minutes*
- *High strength and low elongation under load*
- *High performance polyurethane elastomer reinforced with multiple plies of polyester fabric*



Part #	Mfg #	Type	Length	Pack	Price
143772	0418010SL	3L	5'	Slv	
143792	0418030SL	A/4L	5'	Slv	
143793	0405030	A/4L	25'	Box	
143795	0418050SL	B/5L	6'	Slv	
143796	0405050	B/5L	25'	Box	

Franklin Electric Repair Parts

Capacitor Kits

Part #	Mfg #	HP	Volts	Price
098889	305-207-905	1/2	230V	
098890	305-207-918	3/4	230V	
118594	305-207-913	1	230V	
097608	305-218-976	1/2	230V	
096114	305-218-978	3/4	230V	

Relays Relay Kit

Part #	Mfg #	Volts	Price
096115	305-102-902	230V	

Repair Parts

General Filter Repair Parts

Manual Control Humidistats

- Senses variation in relative humidity levels
- Humidity range: 10% - 85%
- Duct cut-out dimensions: 2-1/4" x 1-3/4"
- Duct plate dimensions: 4" x 5-1/2"
- Mounting screws included



Wall-Mount Housing

- Allows for both wall and duct mount

Part #	Mfg #	Description	Price
146561	WMH3	Wall-Mount Housing for MHX3, MHX3C, or DHX3	

GeneralAire Replacement Parts

1042 Series Humidifier Replacement Parts

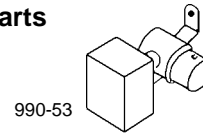

Part #	Mfg #	Description	Price
004874	990-53	Solenoid Valve Assembly - 24V for 1042/1137 (Includes Fittings)	

Replacement Evaporator Pad

- Aluminum evaporator material enclosed in heavy wire frame and channeling
- Pad has super absorbent coating



990-13



1099-20

Part #	Mfg #	Description	Price
004870	990-13	11-3/4"H x 9-3/4"W Evaporator Pad for Model SL-16, 1042, 1040, 1137	
125681	1099-20	12"H x 14-1/4"W Evaporator Pad for Model 1099, 950	



Gerber Repair Parts

Repair Parts

Gerber Replacement Parts

Cartridge Assembly



92-298

Part #	Mfg #	Description	Price
028493	92-298	Hardwater® Ceramic Cartridge with Limit Stop, Chrome	
088009	95-154	Replacement Cartridge for GS103/GS105	
029460	97-022	Safetemp™ Control Cartridge, Chrome	

Faceplate

Part #	Mfg #	Description	Price
004816	97-130	Faceplate Assembly, Chrome	
026255	97-171-KT	Faceplate Assembly, Chrome	

Handle

Part #	Mfg #	Description	Price
031332	86-986	Ceramaflo™ Disc Cartridge, Handle, Cold, Chrome	
031331	86-987	Ceramaflo™ Disc Cartridge, Handle, Hot, Chrome	

Shower Arm



Part #	Mfg #	Description	Price
004716	49-205	Lock Shower Arm Ell, Thin Wall Install, Less Spray Plate, Rough Brass	

Stem and Bonnet Assembly

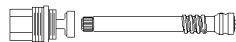

Part #	Mfg #	Description	Price
004827	98-673	Stem & Bonnet Assembly, Hot	

Unit Bag

Part #	Mfg #	Description	Price
004849	99-537	Unit Bag 298-290/590/790/794/795/796, White	
063774	99-538	UltraFlush Unit Bag, White	
105006	99-660	Gerber Unit Bag for Avalanche	

Parts

Part #	Mfg #	Description	Price
004776	90-161	Brass Seat 5/8"-20 NS-2 Thread	
026022	90-390	Fibre Follower	
004792	91-132	Middle Wire	
091418	92-294	Limit Stop for Safetemp	
023522	97-013	Complete Hardwater® Assembly, Less Control Cartridge	
023523	97-014	Complete Safetemp Assembly, Less Control Cartridge	
085928	97-305	Pop-Up Extension Assembly	
004843	99-161	Lav Hanger	
137907	99-788	Flapper	

*Physical Vapor Deposition (PVD) Limited Lifetime Finish

www.waterconcepts.net • Serving our Customers Since 1946 • www.plumbsupply.com

Hi-Velocity (Energy Savings Products) Repair Parts

Electrical Components



EPC Control Board

Part #	Mfg #	Part Name	Description	Price
107815	20120100111	EPC Control Board	Control Board for All HE/LV-E Fan Coils with EPC Motors	
127481	20120100001	EPC Circuit Board	Circuit Board for all HE/LV-E Fan Coils with EPC Motors	
127483	20120100030	EPC Transformer	Transformer for all HE/LV-E Fan Coils with EPC Motors	

Repair Parts

Hydron Module Repair Parts

Heat Pump Repair Parts

Repair Parts

Part #	Mfg #	Description	Price
131157	11470002001	ECM Board	
099573	01CB28	Time Delay Board	
131158	11470003001	Combo Board	
146360	47P002-01NN	47p002-01nn Hydron Combo Board	
131156	11470001001	Control Board	
102660	01CB30	Control Board	
104349	32EB20	15/20kW Elec Board	
158573	40M100-01NN	ECM Motor Hydron	
177055	85A006-02VN	ECM Blower Motor	
136798	35P002-04NN	35p002-01nn Low Pres Switch	
136799	35P003-01NN	High Pres Switch	
136926	11350001002	Low Pres Switch Thrd	
136800	50FL001	Drain Pan Switch	
136823	05P001-01NN	Flow Switch	
141084	18R006	Valve	
141085	33P001-01NN	Valve Hydron	
167466	31P004-01CN	Hydron Air Coil	
167465	18V004	Hydron 3-Way Valve	
141083	18R00C	Coil f/Valve	
111761	26C008	3-Pole Contactor	
136803	11430001001	2-Pole Contactor	
131727	11410000001	Wiring Harness ECM	
136801	11450000001	75VA Transformer	
135343	34P060-11B	H062 410A 2-Stage Comp	
176400	50CB10	Compressor Blanket	
176401	50CB40	Compressor Blanket	
172648	51P010-01HN	Blower Wheel	

Capacitors

Part #	Mfg #	Description	Price
136806	26C101	Capacitor H018 Rev A&B	
136807	26C103	Capacitor All 024 Rev A&B	
136808	26C104	Cap H030&36/w036 Rev A	
136809	26C111	Capacitor	
136810	26C112	Capacitor	

Honeywell Repair Parts

Fan Centers

R8239 Control Center

- Provides low voltage control of line voltage fan motors and auxiliary circuits in heating, cooling or heat-cooling circuits
- Includes NEMA D Transformer, relay enclosures
- Convenient connections for thermostat and heating-cooling equipment wiring
- Mounts on standard 4" x 4" junction box in any indoor location without additional enclosures
- Relay is easily replaced without disturbing wiring



Part #	Mfg #	Description	Price
112616	R8239B1076	120/208/240V, DPDT Switching, 50VA Transformer, Includes R8222D	

R8285 Control Center

- Transformer powers low voltage control systems and provides overload protection
- Low voltage terminal board provides convenient connections for thermostat and heating/cooling equipment wiring
- Mounts on standard 4" x 4" junction box
- Relay is easily replaced without disturbing wiring



Part #	Mfg #	Description	Price
006780	R8285A1048	120V, SPDT Switching, 40VA Transformer, 24V Secondary, Includes R8222B Plug-In Relay for 1 or 2 Speed Fans	

Humidifier Parts & Accessories

Humidifier Parts & Accessories
Humidifier Parts

Repair Parts

Part #	Mfg #	Description	Price
037355	32001615-001	Drain Fitting for HE220 and HE260 Humidifiers	
037357	32001639-002	Solenoid Valve Assembly for Honeywell Humidifiers, Includes Water Feed Tube & Nozzle	

Honeywell Repair Parts

Honeywell Accessories
Motors

Part #	Mfg #	Description	Price
006844	802360JA	24V Sealed Replacement Motor for V8043/V8044	
163574	802360LA	120V, 60 Hz Replacement Motor for V4043, V4044	

Replacement Head for V Series Zone Valves

Part #	Mfg #	Description	Price
006841	40003916-026	24VAC, 50/60 Hz Replacement Head with End Switch for V8044E	
031407	40003916-048	24VAC, 50/60 Hz Replacement Head with End Switch for V8043F	

Checkout Kit for Economizer Logic Modules

- Includes resistor and jumpers
- Used with W7459, W7210, W7212, and W7215



Part #	Mfg #	Description	Price
223324	4074EJM	Economizer Checkout Kit for W7459, W7210, W7212, and W7215	

Honeywell Parts

Part #	Mfg #	Description	Price
074665	32001754-001	Current Sensing Relay for Whole-House Humidification Units	
006842	40003918-006	Adapter Kit for V4043, V8043, 2-Way Hydronic Valves	
127196	50027997-001	Solenoid Valve for TrueSTEAM	
143930	50027998-002	True Steam Water Level Sensor	
152377	Y8427U9045	Universal Service Kit, Carton Consists of: (1) S8610U3009/U. (1) ST9120U1011/U. (1) Q3200U2002/U. (1) S9200U1000/U. (1) Multi tool.	

Repair Parts

Jones Stephens Repair Parts

Repair Parts

Nuts and Washers

Basin Nut



Part #	Mfg #	Description	Price
044429	B10-102	1/2"-14 x 1/2" Regular Zamak	

Basket Strainer Locknut

- Die cast zinc



Part #	Mfg #	Description	Price
093968	B10-094	Basket Strainer Rubber Washer	

Carrier Nut & Washer Set

- 5/8-11 Threads



Part #	Mfg #	Description	Price
125755	C56-100	4-Pk Nuts & Washers	

Hex Nut



Part #	Mfg #	Description	Price
191511	F33-082	3/8" - 16	

Zinz Plated Flat Washer

- 3/8" (1" OD)



Part #	Mfg #	Description	Price
191507	F33-094	3/8" (1" OD)	

O-Ring Kit

- Packed in re sealable plastic case with fitting chart on lid



Part #	Mfg #	Description	Price
093646	O25-200	200-Pc O-Ring Plumber's Pack	

Kohler Repair Parts

Kitchen Side Sprays

Standard Kitchen Side Spray & Hose



Part #	Mfg #	Description	Price
187506	1011130-VS	Sidespray Assy, *Stainless	
156774	1021724-VF	Sidespray w/Hose, Brass	
122911	GP1021724-7	Sidespray w/Hose, Black Black	

Spray & Hose



1041319

Part #	Mfg #	Description	Price
171513	1013838-BV	Spray Assy, *Br Brz	
153883	1014048-CP	Hose Secondary, Chrome	
155335	1036940-0	White Spray Head Kit	
153433	1037518-CP	Hose Kit, Polished Chrome	
098050	1041319-CP	Pull-Out Spry Head Chrome	
173755	1041319-G	Pull-Out Spry Head Chrome	
152453	1041320-CP	Hose Kit, Polished Chrome	
101298	1056336-CP	Hose Kit, Chrome	
151852	1074398-VS	Spray Kit, *Stainless	
153955	1109445-BN	Spray w/ Screen *Br Nickel	
134128	1114379-BC	Hose Kit, Bright Chrome	
164835	1148629-BC	Hose Kit, Bright Chrome	
166252	1155250-CP	Bellera Spray Head Chrome	
168641	1114111-BC	Hose Kit, Bright Chrome	
182429	1141915	Hose Kit	
183339	1153208	Hose Guide	
156335	1155250-VS	Spray Head, *Stainless	
172261	1155250-2BZ	Spray head, Oil-Rbd Bronze	
165112	1155355-CP	Spray Head, Pol Chrome	
155345	1155355-VS	Spray Head, *Stainless	
162203	1179931	Sprayhead Adapter	
159726	1186344	Hose Assembly	
222878	1218822-CP	Spray Assy, Chrome	
181715	1218823-CP	Spray Assy, Chrome	
170388	1218824-CP	Spray Assy, Chrome	
173920	1218824-VS	Spray Assy, *Stainless	
167009	1219935-BC	Hose Kit, Bright Chrome	

Kitchen Side Sprays (Continued)

Spray & Hose

Part #	Mfg #	Description	Price
167797	75167-D	Replacement Spray, White	
157802	GP1092201	Hose Kit	
055348	GP78825-CP	Hose Kit Chrome	

Side Spray Assembly



Part #	Mfg #	Description	Price
175894	1005010-CP	Hose Service Kit, Chrome	
153716	1005010-VF	Hose Service Kit, * Brass	
135248	1011130-G	Side Spray Assy Br Chrome	
152182	1011130-BN	Side spray Assy *Br Nickel	
155090	1085211-CP	Side Spray Assy, Chrome	
166253	1088395-VS	Side Spray Kit, *Stainless	

Shower Installation

Cartridge for Highflow 3/4" Pressure Balance Valve



Part #	Mfg #	Description	Price
134263	1144925	PBU for K-306-KS & K-2971-KS	

Urinal Installation

Part #	Mfg #	Description	Price
056119	21403	Urinal Cleanout Plug	

Urinal Spud Assembly



Part #	Mfg #	Size	Price
145344	18759	1-1/4"	

* Vibrant Limited Lifetime Warranty

www.plumbsupply.com • Serving our Customers Since 1946 • www.waterconcepts.net

Kohler Repair Parts

Repair Parts

Toilet/Urinal Installation & Accessories

Urinal Strainer



Part #	Mfg #	Description	Price
183714	53147-S	Urinal Strainer, Pol Stainless	
169956	GP1211759	Urinal Strainer	
173481	GP1217811	Urinal Strainer	

Tank Gasket



Part #	Mfg #	Description	Price
123062	GP1018165-F	Drylock Tank Gasket	

Balcock Retro Fit Valve

- For Rialto/
San Raphael3.5 toilets



Part #	Mfg #	Description	Price
055292	84499	Plastic	

Cap Assembly



Part #	Mfg #	Description	Price
072213	1013092-0	Bolt Cap Accy Pack, White	
153559	1013092-G9	Bolt Cap Accy Pack, Sndbr	
186397	1013092-NY	Bolt Cap Accy Pack, Dune	
108130	GP1013092-96	Bolt Cap Accy Pack, Biscuit	
223630	5420-0	Low-Profile, White	
223631	5420-96	Low-Profile, Biscuit	
226816	5420-K4	Low-Profile, Cashmere	

Flushometer Installation Extension Kit

- Solid brass construction
- Allows for 1/2" to 2-1/2" extension
- No need for flushometer disassembly
- Fits all standard flushometer inlets



Part #	Mfg #	Finish	Price
131937	10162-CP	Polished Chrome	

Faucet Valves

Complete Valve Assembly for Retrofitting Faucet

- 1/2" Valve

Part #	Mfg #	Description	Price
137033	1131481	Valve Body w/Hot Stem	
172151	1170273	Valve Replacement	

Valve Repair

Aerators

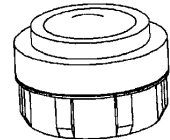

Part #	Mfg #	Description	Price
182884	41007-CP	2.2gpm 15/16 Male, Chrome	
182688	59619-0	Aerator Kit, White	
160583	59728-CP	Aerator, Polished Chrome	
182891	74405-BN	Aerator Assy, *Br Nickel	
151599	78868	Aerator	
091813	78250-CP	Aerator, Polished Chrome	
167560	79402-BN	Aerator Kit, *Br Nickekl	
153112	86125-BL	Aerator Assy, Black	
182746	1008772-CP	Aerator Assy, Chrome	
182873	1010751-CP	Aerator, Polished Chrome	
157663	1013354-CP	Aerator Kit, Chrome	
166360	1018320-VF	Aerator, *Polished Brass	
185614	1019975	Aerator Key	
152069	1021672-CP	Aerator Kit, Chrome	
156775	1031237-VF	Aerator Assy, *Pol Brass	
179683	1031237-VS	Aerator Assy, *Stainless	
164704	1049937	Aerator Insert	
183217	1054421	Aerator Kit	
154016	1061023	Aerator Kit	
183234	1089003	Aerator Kit	
159120	1097762-BN	Aerator Kit, *Brushed Nickel	
172609	1097762-CP	Aerator Kit, Pol Chrome	
151595	1098361-G	Aerator Kit, Br Chrome	
157799	1100416	Aerator Kit	
156817	1103116	1.5gpm Large Insert	
225412	1103470-VF	Aerator Kit, 1.5 GPM	
154664	1103459-BN	Aerator Kit, *Br Nickel	
168958	1103463-CP	Aerator Kit, Pol Chrome	
167835	1103464-BC	Aerator Kit, Bright Chrome	
183241	1103468-BV	Aerator Kit, *Br Bronze	
188297	1103468-SN	Aerator Kit, *Pol Nickel	
168114	1103470-CP	Aerator Kit, Pol Chrome	

* Vibrant Limited Lifetime Warranty

www.waterconcepts.net • Serving our Customers Since 1946 • www.plumbsupply.com

Kohler Repair Parts

Valve Repair (Continued)

Aerators

Part #	Mfg #	Description	Price
152180	1103470-BN	Aerator Kit *Brushed Nickel	
149773	1104546	1.5 gpm Medium Insert	
172748	1105050-BN	Aerator Kit, *Brushed Nickel	
159677	1105050-VF	Aerator Kit, *Polished Brass	
183242	1105674	Aerator Assy	
160675	1106716-CP	Aerator Kit, Pol Chrome	
183244	1108235-BC	Aerator Kit, Bright Chrome	
179514	1138478	Aerator Assy	
153618	1139282	Aerator	
187955	1139285	Laminar	
173751	1139286	Aerator	
173752	1139287	Laminar	
164808	1139289	Laminar	
162923	1160595	Aerator	
164064	1171998-BC	Aerator Assy, Bright Chr	
187011	1203940-BC	Aerator Assy, Bright Chr	

Seat

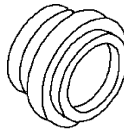

Part #	Mfg #	Description	Price
055320	20774-RP	Renewable Seat	

Vacuum Breaker

- For older one-piece 3.5+ gpf toilets
- Replaced black style



Part #	Mfg #	Description	Price
055422	GP49114	2" Ball Flapper	

Valve Repair Kit

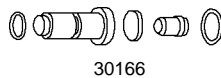

Part #	Mfg #	Description	Price
182594	30147	Valve Service Kit	
182596	30372	Valve Service Kit	
182627	40409	End Valve Assy	
182681	58076	Valve Assy	

Valve Repair (Continued)

Valve Repair Kit

Part #	Mfg #	Description	Price
171801	76567	Valve Assy	
056161	1000187	Valve Repair Kit	
162934	1178733	Valve Assy	
165027	1021121	Valve, Volume Control	
160355	GP1093674	Valve, Kitchen	
222832	GP1152350	Valve, Centerset Faucet	
222831	GP1192521	Valve, 25 MM White	
055381	GP78579	Valve Repair Kit	
055308	GP30166	3.5+GPF Fill Valve Repair Kit	

Washers, Nuts & Gaskets

Part #	Mfg #	Description	Price
182530	20496-BC	Lock Nut, Bright Chrome	
182532	20564	Washer	
182533	20565	Washer	
182536	20644	Gasket	
182569	21766	Nut	
182572	21779	Gasket	
182574	21844	Nut	
153386	23094	Nut	
182584	24003-CP	Nut, Polished Chrome	
153819	32008	Nut	
182601	32060	Washer	
163448	32313	Nut	
182603	32841	Gasket	
182604	33331	Washer	
182606	33504	Washer	
182607	33772	Washer	
182608	34037	Gasket	
182610	34074-CP	Nut, Polished Chrome	
154416	34274	Washer	
182618	36262	Washer	
182626	40295	Washer	
170645	41376	Gasket	
154513	50751	Nut	
112456	50752	Washer	
182646	50843	Washer	
182647	51250	Gasket	
113702	51531	Gasket	
169200	52705-CP	Nut, Polished Chrome	
055325	53410	Washer	
159433	55164	Nut	
182656	55413	Washer	

Repair Parts

* Vibrant Limited Lifetime Warranty

www.plumbsupply.com • Serving our Customers Since 1946 • www.waterconcepts.net

Kohler Repair Parts

Valve Repair (Continued) Washers, Nuts & Gaskets

Part #	Mfg #	Description	Price
182687	59606	Gasket	
181864	65157	Nut	
165926	65885	Gasket	
178854	71108	Nut	
177272	71813	Gasket	
166860	78058	Washer	
166861	78057	Washer	
166859	78087	Gasket	
182733	78913	FacePlate Gasket	
182745	1007995	Washer	
182740	1000949	Washer, Plastic	
154945	1009882	Gasket, Molded	
165460	1015190	Washer	
183181	1018336-RP	Nut, Rough Plate	
181866	1020677	Gasket	
183184	1025642	Washer	
166877	1037307	Gasket	
152641	1050048-B	Nut	
183214	1051504-RP	Nut, Rough Plate	
178035	1070291	Gasket Kit	
155661	1106733	Washer	
154740	1113583	Locknut & Gasket Kit	
183328	1128531	Washer	
180292	1222738	Gasket	
187471	1181517-RP	Nut, Rough Plate	

Sink Service Parts Rough-In Kit



GP1030932

Part #	Mfg #	Description	Price
166957	1066498	Rough-In Kit	
170792	1139260-CP	Rough-In Kit, Pol Chrome	
158598	1131486	Rough-In Kit	
168420	1187917	Rough-In Kit	
169472	1194630	Rough-In Kit	
127033	56373-CP	Rough-In Kit, Pol Chrome	
182707	73418-CP	Rough-In Kit, Pol Chrome	
098493	GP1007937-CP	Rough-In Kit Pol Chrome	
090369	GP1025388	Rough-In Kit Pol Chrome	
087416	GP1030932	Rough-In Kit Pol Chrome	

Parts

Part #	Mfg #	Description	Price
154944	1000193-BV	Escutcheon, *Br Bronze	
166994	1000282-CP	Handle Kit, Pol Chrome	
189946	1001384-47	Service Kit, Almond	
153127	1001384-96	Service Kit, Biscuit	
155078	1001384-89	Service Kit, Desert Bloom	
166039	1001726-G	Handle Service Kit	
185783	1001795-BN	Handle Kit, * Br Nickel	
190273	1001795-47	Handle Kit	
177854	1001978-CP	Escutcheon, Pol Chrome	
153385	1002856	Bracket-Hold Down	
182739	100315	Clicker-Drain Assy	
182018	1003594	Spout Seal	
166541	1004101-C-CP	Cold Plug Button, Chrome	
166540	1004101-H-CP	Hot Plug Button, Chrome	
151709	1005129	O-Ring	
166832	1006008	Lift Rod Kit	
182741	1006057-CP	Door Hinge, Pol Chrome	
182742	1006134-CP	Door Hinge, Pol Chrome	
177856	1006262	Stem Adapter Assy	
180497	1006269-CP	Escutcheon, Pol Chrome	
182744	1006396	Pin	
167396	1006784-CP	Escutcheon Assy, Chrome	
180037	1007376-CP	Handle Kit, Pol Chrome	
162642	1007718-CP	Handle, Pol Chrome	
156197	1007999	Stem Driver	
117857	1008205	Screw	
187098	1009781CP	Faceplate, Pol Chrome	
189790	1009814-CP	Escutcheon, Pol Chrome	
183175	1009872-AF	Bonnet, *French Gold	
154055	1009888-CP	Base Handle, Chrome	
165459	1010161-BN	Trim Ring, *Br Nickel	
188789	1010315-CP	Escutcheon, Pol Chrome	
181490	1010672	Air Pressure Switch	
182875	1011032-0	Whirlpool Trim Kit, White	
182874	1011031-96	Whirlpool Trim Kit, Biscuit	
165984	1012391-BN	Handle, *Br Nickel	
166803	1012916	Split Coupling	
170229	1012977	Adapter	
167478	1013452-0	Dial Trim Assy, White	
167477	1013453	Detent Spring	
181867	1013469-0	Trim Ring, White	
164795	1013489	Stem	
165835	1014065	Tank Plate	
182876	1014072-7	Toilet Seat, Black Black	
178298	1014086-08	31.875 Threshold Seal	

* Vibrant Limited Lifetime Warranty

www.waterconcepts.net • Serving our Customers Since 1946 • www.plumbsupply.com

Kohler Repair Parts

Parts (Continued)

Part #	Mfg #	Description	Price
165458	1014087-BN	Bonnet, *Br Nickel	
183178	1014554-SN	Spout & Hardware, *Nickel	
160891	1014555-CP	Spout & Hardware, Chrome	
182877	1014556-CP	Spout & Hardware, Chrome	
167744	1014917-G	Lift Rod Assy, Br Chrome	
175018	1015084-BN	Button, *Brushed Nickel	
167746	1015084-G	Button, Brushed Chrome	
172143	1015467-2BZ	Handle Assy Oil-Rbd Bronze	
165456	1015782	Screw	
153165	1016455-CP	Escutcheon Assy, Chrome	
183180	1017273	Screw	
181863	1018662	Control Assy	
182879	1020006-G	Shower Arm, Br Chrome	
182880	1020007-VF	Shower Arm, *Pol Brass	
182881	1020609	Tube	
183182	1020678-F-47	Cover Assembly, Almond	
167479	1023381	Service Tool	
190293	1022562-VF	Trip Lever Kit, Pol Brass	
173541	1024303-0	Button, White	
162318	1024303-2BZ	Button, Oil-Rubbed Bronze	
162335	1024303-BN	Button, *Brushed Nickel	
183183	1024303-VF	Button, Polished Brass	
170404	1024424-BN	Spout Kit, *Brushed Nickel	
183167	1025637-AF	Trim Ring, *French Gold	
154765	1025637-BN	Trim Ring, *Brushed Nickel	
153164	1030689-CP	Escutcheon, Pol Chrome	
183185	1031444	Glass Soap Dish	
176758	1031869-CP	Escutcheon, Pol Chrome	
183186	1031962	Bearing	
183187	1032126-VF	Drain Handle Assy, Brass	
175899	1032250	Seal	
187628	1032253-BC	Body Assy, Bright Chrome	
183188	1032267	Replacement Screw	
186677	1032493-0	Bubble bath Interface, White	
177257	1032546	Valve Stops	
223376	1032872-BC	Valve Stem Adapter	
190205	1033209	Tube, 10.50	
171281	1033743-BN	Escutcheon, *Br Nickel	
153729	1034578	Retainer	
184322	1035359-BN	Escutcheon, *Br Nickel	
166029	1035359-CP	Escutcheon, Chrome	
183191	1035359-VS	Escutcheon, *Stainless	
183192	1035564	Drain Link	
168072	1035605	Screw Set	

Parts (Continued)

Part #	Mfg #	Description	Price
170434	1035796-CP	Handle, Pol Chrome	
163159	1036044	Clamp	
182830	1036210	Blower Kit	
183193	1036218	Check Valve Assy Kit	
183194	1036221	Cover/CB Assy	
172555	1036453-CP	Handle Assembly, Chrome	
171280	1036906	Putty Plate	
187935	1036932-BN	TrimRing, *Brushed Nickel	
183195	1036994-AF	Plunger Assy, *French Gold	
159708	1036994-VF	Plunger Assy, Pol Brass	
154785	1037021-CP	Plunger Assy, Pol Chrome	
175689	1037021-BN	Plunger Assy *Br Nickel	
183197	1037021-G	Plunger Assy Br Chrome	
172528	1037022-BKB	Plunger Assembly, Br Black	
161237	1037023-BN	Drain Assy, *Br Nickel	
183198	1037023-G	Drain Assy, Br Chrome	
175333	1037334	Plunger Arm Assy	
170632	1037431-BV	Spray Holder Assy, *Br Brz	
225585	1037431-G	Spray Holder Assy, Brushed Chrome	
173129	1038326	Bearing	
153316	1039475	Mounting Kit	
184794	1039714-BN	Lever Handle, *Br Nickel	
163161	1039745	Set Screw	
189802	1039896-58	Button, Thunder Grey	
166289	1040484-CP	Spout Kit, Pol Chrome	
183200	1041109-G	Escutcheon, Br Chrome	
174324	1041180-BN	Lift Rod, *Brushed Nickel	
185607	1041321-CP	Handle Kit, Br Chrome	
165318	1041573-G	Spray Face, Br Chrome	
177167	1041840	Drain Rod	
160745	1041995-96	Air Switch Kit, Biscuit	
183201	1042007	Check Valve Kit	
177074	1042634	Wall Sleeve Assy	
163145	1044060	O-Ring	
168711	1044616	Retainer	
163427	1045251	Cable Assembly	
163158	1045768	Relaxing Sprayhead Kit	
165316	1045769	Invigorating Sprayhead Kit	
177258	1046101	Seal Kit	
183203	1046153	Weight	
183204	1048208-B	Screw	
183205	1048208-C	Screw	
183206	1048656-P	Sealing Liquid	
183695	1049146	Floor Mounted Fixing Pack	

Repair Parts

* Vibrant Limited Lifetime Warranty

www.plumbsupply.com • Serving our Customers Since 1946 • www.waterconcepts.net

Kohler Repair Parts

Parts (Continued)

Part #	Mfg #	Description	Price
163160	1051487	54 Nozzle Membrane	
183207	1051503-BN	Bonnet, *Brushed Nickel	
165317	1051682	22 Nozzle Membrane	
185403	1052086	Power Supply Kit	
183215	1052857	Reduce Bushing	
183216	1054165-SN	Lift Rod Assy, *Pol Nickel	
183218	1055628	Solenoid Assembly	
135539	1055666	Solenoid	
187554	1055800-BN	Handle Kit, *Br Nickel	
153186	105770401-CP	Towel Bar Assy, Chrome	
169720	1060438-CP	Escutcheon, Pol Chrome	
176650	1060800	Spacer Kit	
180607	1063058-BV	Hanshower, *Br Bronze	
179610	1063058-VF	Handshower, Pol Brass	
169793	1067372-96	Toilet Seat, Biscuit	
183220	1068202-BN	Stopper, *Brushed Nickel	
163642	1068202-BV	Stopper, *Brushed Bronze	
177685	1068525-BN	Assembly Cover, *Br Nickel	
163641	1068525-BV	Assembly Cover, *Br Brz	
187234	1068945	Retainer	
183221	1069315	Spring	
183222	1069723-0	Trip Lever, White	
183223	1070844	Hardware Bag	
183224	1071000	Storage Locker Parts Kit	
169116	1071652	Hex Bit	
171261	1074034	Tool Assy	
183225	1074721-BN	Handle Bonnet, *Br Nickel	
183226	1074724-BN	Handle Adapter, *Br Nickel	
183227	1075614	O-Ring	
183228	1075615	O-Ring	
178585	1077791-96	Plug Buttons, Biscuit	
171786	1077792-BN	Plug Buttons, *Br Nickel	
183229	1077813	Solenoid Valve Kit	
183230	1077815	Valve Cover Kit	
183231	1077816	Diaphragm Kit	
128818	1078578	Flush Valve Assembly Kit	
155319	10813650-0	Floor Mounting Kit Assy	
183232	1081873-BN	Handle, *Brushed Nickel	
222456	1081873-CP	Handle, Chrome	
114111	1083980	Canister Valve Assy Kit	
156362	1086408-CP	Handle, Pol Chrome	
156410	1086409-58	Ring, Thunder Grey	
222940	1085211-VS	Side Spray Assembly	
155113	1086972	Hinge Mount	
163815	1088996	Valve Kit	

Parts (Continued)

Part #	Mfg #	Description	Price
163124	1089635	Cable Kit	
181309	1090621-2BZ	Lift Rod Assy, ORB	
183235	1093029	Assembly Body	
161131	1093053-BV	Spout & Diverter *Br Bronze	
160252	1094550-CP	Straight Stop, Pol Chrome	
183236	1094562	Bonnet	
170190	1094612-CP	Valve, Polished Chrome	
166887	1094631-CP	Spout Assembly, Chrome	
154678	1094633	Seat & Sleeve Assembly	
166611	1094724	Side Body	
175893	1096037-CP	Handshower Kit, Chrome	
183240	1098124	O-Ring	
153739	1010210-BN	Adapter, *Brushed Nickel	
183176	1010343-CP	Handle, Polished Chrome	
182747	1010376	Flapper	
155669	1011059-58	Ring, Thunder Grey	
165461	1011530-BN	Handle, *Brushed Nickel	
157984	1013457-E-96	Flagship Assy, Biscuit	
159535	1013970	Screw	
152457	1013975	Adapter	
154533	1014049	Steam Adapter	
183179	1014923-CP	Showerhead Assy, Chrome	
157985	1015009	Plug Assy	
169377	1016310	Plate	
156133	1016953	Pump Assy	
167700	1017813-01-MX	Assy, Matte Nickel	
156195	1018651-CP	Handle Polished Chrome	
159106	1018651-BN	Handle *Brushed Nickel	
157818	1018651-BRZ	Handle, Oil-Rubbed Bronze	
165985	1019021-BN	Waste Plug, *Br Nickel	
151743	1020678-E-96	Cover/CB Assy, Biscuit	
156951	1020679-A	Cover/CB Assembly	
159540	1024303-47	Plug Button, Almond	
160135	1024303-96	Plug Button, Biscuit	
157926	1024303-CP	Plug Button, Pol Chrome	
111678	1024419	Mixer Trim Housing Hub	
159622	1025210-BN	Escutcheon Assy, *Br Nkl	
154531	1025639-BC	Drain, Bright Chrome	
159534	1032871-BC	Adapter, Bright Chrome	
151597	1033731	Plug Assembly	
151598	1033732	Mixer Valve	
158221	1034484	Retaining Clip	
154831	1035023-CP	Handle Assy, Pol Chrome	
152485	1035783	Front Plate Seal Assy	
152917	1036160	Push Rod Kit	

* Vibrant Limited Lifetime Warranty

www.waterconcepts.net • Serving our Customers Since 1946 • www.plumbsupply.com

Kohler Repair Parts

Parts (Continued)

Part #	Mfg #	Description	Price
152344	1036212	Kit, Blower-International	
172556	1036452-CP	Handle Assy, Pol Chrome	
153655	1036994-CP	Plunger Assy, Pol Chrome	
183196	1036994-G	Plunger Assy, Br Chrome	
152915	1037044-CP	Handle Assembly, Chrome	
183199	1038690	Vent Assembly	
159505	1039095-CP	Assy, Polished Chrome	
173128	1041321-BN	Handle Kit, *Brushed Nickel	
155666	1041321-G	Handle Kit, Br Chrome	
190209	1042831	Flush Valve Kit	
153884	1043004	Screw Set	
152643	1044585	Exclusives Roller	
223269	1045770	Adapter Kit	
120496	1046987-CP	Handle Kit, Pol Chrome	
223375	1048476	Screw, M4 x 60MM Long	
164017	1049316-CP	Showerhead Assy, Chrome	
152637	1051142-A	Screw	
152456	1051609-BN	Lift Rod, *Br Nickel	
152435	1054623-BN	Diverter Assy, *Br Nickel	
152212	1055637	Diaphragm Assembly	
162256	1055650-CP	Push Button Assy, Chrome	
153605	1055715	1.5 gpm Pullout Service Kit	
152639	1059792	.330 O.D. X .210 Bushing	
186964	1062356-33	Drain Cover, Mexican Sand	
157607	1065219	1.6 Electronic Unit Assy	
155414	1068204	Cartridge Assy	
171397	1068380-0	Access Panel, White	
152838	1072961-CP	Button Assy, Pol Chrome	
152644	1077763-A	8-32 X .250 SEX Bolt	
165893	1077792-BV	Plug Buttons, *Br Bronze	
159625	1077792-47	Plug Buttons, Almond	
152717	1080774	Union Assy	
157870	1081349	Adapter Assy	
222933	1088956	Aerator Kit	
152040	1093052-VF	9" Kit, Polished Brass	
183173	1100507-0	Hinge Cover, White	
155987	1100590	Flexible Hose	
148638	1102542	Solenoid Assy	
157194	1104111-BV	Nozzle Assy, *Br Bronze	
185157	1104111-CP	Nozzle Assy, Pol Chrome	
164048	1104111-VF	Nozzle Assy, Pol Brass	
164773	1104235	Solenoid Kit	
168064	1104270	0.125 gpf Flow Assy	
170369	1104271	Electronic Unit Assy	
168063	1104272	Piston Cover Kit	

Parts (Continued)

Part #	Mfg #	Description	Price
154930	1104617	Crank Assy	
172129	1104957	Laminar Insert	
125323	1105656	1.549" x .103" #129 O-Ring	
189739	1105685-BN	Overflow Cover, *Br Nickel	
183243	1105706	Tool Kit	
188100	1105900	Spout Extension Assy	
165033	1106015	DC Sensor Assy w/Batteries	
155660	1106729-BN	Handle, *Brushed Nickel	
168062	1111139	Solenoid Kit	
183322	1114256	Rising Wall Controller	
183324	1115286	Threaded Ring	
160683	1119112	Slip-Fit Clamp Kit	
183325	1120992-BN	Antique Small Hndl, *Br Nkl	
183329	1131838-58	Bumper, Thunder Grey	
152557	1133024	Toilet Seat Hardware Pack	
177252	1133070	Bumper Service Kit	
155662	1138476-BN	Escutcheon Assy *Br Nickel	
158967	1139558	Collect-Push-In	
183696	1139526-CP	Elbow Assy, Pol Chrome	
168212	1139600	Plastic Trapway Service Kit	
155640	1140164-BN	Flange, *Brushed Nickel	
141416	1140858-CP	Slidebar Assy, Chrome	
183331	1140867-BN	WM Bracket Cover, *Br Nkl	
183697	1141213-B	Cartridge, Transfer Valve	
222069	1142457-BN	Spout Assembly	
165853	1142457-CP	Assy Spout, Pol Chrome	
153674	1142457-2BZ	Assembly, Spout ORB	
177423	1142538	Filter Block	
175509	1143165-CP	Showerhead Assy, Chrome	
169560	1143284	Assy, Drain Clicker	
153321	1144142	Seals, PBU Kit	
183336	1145563	Kit, SPR Valve Assembly	
172730	1145638-HW1	Toe Tap Assy	
169192	1146417	120V USA Pump	
183337	1146802-0	Air Jet Service Assy, White	
152316	1147742-0	Air Switch Kit, White	
157788	1147742-47	Air Switch Kit, Almond	
166779	114847-VS	Spray, *Stainless	
183338	1150464-0	EB Hinge Kit, White	
160674	1151429-CP	Retaining Collar, Chrome	
180822	1151441-CP	Shower Arm, Pol Chrome	
163200	1151968-BN	Service Kit, *Brushed Nickel	
163170	1151968-CP	Service Kit, Pol Chrome	
171450	1152299-BN	Spray/Screen Kit, *Br Nickel	

Repair Parts

* Vibrant Limited Lifetime Warranty

www.plumbsupply.com • Serving our Customers Since 1946 • www.waterconcepts.net

Kohler Repair Parts

Parts (Continued)

Part #	Mfg #	Description	Price
166599	1153944-BN	Handle Kit, *Br Nickel	
164798	1153944-CP	Handle Kit, Pol Chrome	
187838	1153944-G	Handle Kit, Br Chrome	
167699	1154757-58	Screw Cover Service Kit	
188368	1154836	Hose Assy	
170194	1155520	Pipe System	
177056	1156410-BN	Plug Button, *Br Nickel	
183698	1156410-CP	Plug Button, Pol Chrome	
183555	1161770	Rotary Assy	
183702	1160753	Adapter	
190321	1166635	3/4" Volume Control Insert	
166308	1166879-BN	Tube, *Brushed Nickel	
223932	1166879-CP	Tube, Pol Chrome	
176945	1173678	Cartridge Assy	
183703	1175994-BN	Showerhead Assy, *Br Nckl	
180261	1175870-BN	Lift Rod Assy, *Br Nickel	
181980	1177160	12 Sink Clips	
183704	1177161	12 Installation Clip Kit	
173008	1178736	PCB Board & Cover Assy	
183706	1179957-BN	Drain Strainer, *Br. Nickel	
069038	1179-NA	Tiling-In Bead, 180" Length	
167166	1180445-VF	Escutcheon, Polished Brass	
056792	1181-NA	Tiling-In Bead, 132" Length	
161065	1185540-BN	Assy Slider, *Br Nickel	
188413	1187796-SH	Handle Kit, Bright Silver	
172092	1187796-SHP	Handle Kit, Bright Pol Silver	
158906	1190050-K-CP	Assy, Polished Chrome	
188463	1191575-CP	Shower Arm, Pol Chrome	
171043	1194302-CP	Large Escutcheon, Pol Chr	
182831	1194940	Cable	
170376	1197170	Vacuum Breaker	
183710	1200948	Chain Kit	
172093	1201773-BN	Loure Spout Assy, *Br Nkl	
188554	1202708	Mirrored Door Assy	
169231	1202077	Supply Hose SS	
224199	1202709	Mirrored Door Assembly	
186691	1204788-2BZ	Cold Handle Assy, ORB	
186251	1207169	Supply Hose	
183711	1207943	Diverter Spout Cap	
165035	1209172-VS	Sensate Escutcheon,* Stnls	
222939	1209172-CP	Escutcheon, Oil-Rbbed Brz	
179937	1217618-BL	Strainer Cup, Matte Black	
224985	1218071	Supply Adapter	
186669	1218822-VS	Spray Assy, *Stainless	
176606	1218922-CP	Button, Polished Chrome	

Parts (Continued)

Part #	Mfg #	Description	Price
181868	1219654	T-Style 240V 1.5KW Heater	
179983	1219693	1/4 NPT Pipe Plug	
180294	1222736	1" Heater Adapter	
188461	1224550-CP	Escutcheon, Pol Chrome	
187872	1229031	Supply Adapter	
171581	1229524	Basin Rack Wheels	
183712	1232221-BN	Handle Assy, *Br Nickel	
177253	1239016	Hardware Pack	
188369	1239557-BNK	Bracket Kit, Anod Br Nickel	
178416	1240529	Overflow Shell Service Kit	
185308	1256315	OEM Touchless Assy	
189976	1262603-CP	Steam Head Kit, Pol Chr	
158897	13602-NA	6" Cable Assy	
155785	14511-CP	Escutcheon Plate, Chrome	
054451	201-NA	High-Flow Refill Cartridge	
054452	202-NA	Premium Refill Filter Cartridge	
182526	20345-BN	Flange & Set Screw Assy,*Br Nickel	
156847	20345-CP	Flange & Set Screw Assy, Chrome	
165097	20345-VF	Flange & Set Screw Assy, Pol Brass	
162187	20363-VF	Flange Assy, Pol Brass	
162188	20364-VF	Knob Assy,Pol Brass	
182529	20413-CP	Left Hand Valve Stem, Chr	
182527	20401	Stopper Post	
222959	70442	Stem Extension Kit	
182531	20536-CP	Lift Rod, Pol Chrome	
182534	20615-BN	Screw, *Brushed Nickel	
182535	20617-CP	SA Overflow Hood, Chrome	
182537	20650-CP	Stopper Assy, Chrome	
182538	20652-CP	8-32 x 1.25 Screw, Chrome	
182539	20654-RP	LH Valvet, Rough Plate	
182540	20851-CP	Escutcheon, Pol Chrome	
182558	21072-BN	Stopper Assy, * Br Nickel	
182560	21098-CP	Escutcheon, Chrome	
223383	21694	Lift Toggle Assembly	
182570	21775	1/4-20 x .625 Screw	
182571	21777	3/8 Niedecken Detail	
182573	21843-BC	Screw, Bright Chrome	
182575	21845	Packing	
164410	21152	6-20 x .5 Screw	
164411	21153	Adjusting Block	
164409	21155	Lift Rod	
158316	21166-BKB	Strainer Body, Br Black	

* Vibrant Limited Lifetime Warranty

www.waterconcepts.net • Serving our Customers Since 1946 • www.plumbsupply.com

Kohler Repair Parts

Parts (Continued)

Part #	Mfg #	Description	Price
173074	21166-CP	Strainer Body, Chrome	
182561	21166-VF	Strainer Body, Pol Brass	
182562	21281-CP	2"D Shroud Cover, Chrome	
182882	21318-AF	Tub Drain Stopper Assy, * French Gold	
158315	21318-BKB	Stopper Assy, Br Black	
182563	21318-VF	Stopper Assy, Pol Brass	
182564	21354	Lift Rod	
182565	21496	O-Ring Assy	
182567	21712-BC	Stem, Bright Chrome	
182568	21745-CP	Cover, Pol Chrome	
172647	22125	Cold Plunger	
172649	22126	Hot Plunger	
172650	22211	Cold Disc Holder	
172651	22212	Hot Disc Holder	
182576	22325	Spline Insert	
182577	22511	Short Adj. Sleeve Valve	
182578	22692	Diverter Seat for FTG	
182579	22859	8-32 x .5 Screw	
182580	22862-BC	Diverter Stem, Bright Chr	
162949	22910-CP	Dial Plate Sleeve, Chrome	
182581	22916-BN	Overflow Plate, * Br Nickel	
182582	22916-CP	Overflow Plate, Chrome	
182583	22942	Seat	
153611	23023-BC	Valve Stem, Bright Chrome	
153119	23058-BC	Valve Stem, Bright Chrome	
182585	24015	Union Joint	
174497	28518	3/32 DIA x 3/4 Pin	
182586	29037-BC	Drain Crank, Bright Chrome	
182587	29039-BC	Drain Crank w/ Adj. Link, Bright Chrome	
182588	29060-BN	Strainer Body Lever Lift, * Brushed Nickel	
182589	29077-BN	3/8-24 x 7/32 Screw, *Brushed Nickel	
182590	29643	Lift Toggle	
182591	30040	Valve Stem Ledge	
182592	30042	Valve Stem	
182593	30139	Sleeve & Diverter Kit	
175179	30152	Plunger Assy	
182595	30154	Lift Rod Assy	
151344	30253-RP	Rebuilding Kit, Rough Plate	
154165	30297-CP	Rebuilding Kit, Chrome	
166211	30299	Rebuilding Kit	
177747	30332-RP	Hardware Kit, Rough Plate	

Parts (Continued)

Part #	Mfg #	Description	Price
167058	30394-RP	CCW Close Valve, Rough Plate	
182597	30419	Tank Accessory Pack	
182598	30467	Diverter	
165924	30739	Dir. Ball Removal Tool	
160203	30775	W/P STD Switch Kit	
163455	31537	Ball & Frame Assy	
182600	31584-BC	Left Hand Valve Stem Assy, Bright Chrome	
157639	31689-CG-CP	Cold Push Handle, Chrome	
182599	31439-BC	Diverter Assy, Chrome	
153818	32005	7/16" ID X 3/4" OD Packing	
182602	32657	O-Ring	
182605	33357-BN	8-32NC-2A x .562 Screw, *Brushed Nickel	
189795	33625	10-24 x .438 Screw	
173081	33681-CP	Strainer Body, Chrome	
182609	34064-BN	Lever Handle, * Br Nickel	
182611	34117	O-Ring	
153817	34190	Valve Spacer	
154166	34230	Spring	
168123	34294	Packing	
182612	34532	Post For Soap Dish	
182613	34533-CP	1/8-27 NPSM Nut, Chrome	
160251	34777	Pressure Regulator Assy	
170189	34902-G	Condensate Plate Assy, Brushed Chrome	
182614	35103	3/8" IP Angle Stop Assy	
182615	35285	10-24 x .313 Screw	
161208	35296-CP	Bubbler Shank, Chrome	
159530	35311-CP	Lever Handle Assy, Chrome	
170191	35314-CP	1-1/4" SEM Fountain Trap, Polished Chrome	
175962	35594	3/8 Union Conn	
182616	36258	Push Button	
182617	36261	Valve Stem	
182619	36263	Spring	
182620	36415	Spout Bearing	
182621	36417-RP	Swing Spout Post, RP	
182622	39881	Valve Stem Packing	
182623	40004	End Valve Body Assy	
182624	40235	Ball Lvr Seat Seal Washer	
136388	40236	Ball-Rod Assembly	
182625	40282	Diverter Bushing	
170179	40343-CP	LG Handle Assy, Chrome	
182883	40479-BN	Bonnet, *Br Nickel	

* Vibrant Limited Lifetime Warranty

www.plumbsupply.com • Serving our Customers Since 1946 • www.waterconcepts.net

Kohler Repair Parts

Parts (Continued)

Part #	Mfg #	Description	Price
182628	40966	Packing	
169521	41240-VF	SA Insert, Pol Brass	
182629	41489	SA Stand Pipe	
182630	42036	Hot Plunger	
182631	42038	Cold Plunger	
182632	42052-CP	OBS Mixer Sleeve, Chrome	
182633	42160	O-Ring	
182634	42258	Sleeve	
182635	42271	Bonnet	
171282	42414	10-24 x .375 Screw	
182636	42451	O-Ring	
165399	42674-CP	Handle, Polished Chrome	
182637	42675	Plug, Handle, Shower	
182638	42676-CP	Plug Button, Chrome	
179506	43040	Trap	
153582	43070BV	Strainer Plate, *Br Bronze	
172119	48096-CP	Strainer SA, Chrome	
189793	48250-CP	Wall Saddle, Pol Chrome	
189796	48251-CP	Rod, Pol Chrome	
165964	48609-BGD	DA Bidet Spray, *Moderne Brushed Gold	
182639	48686	O-Ring	
182640	500180	Bumper Kit	
168997	500306-G3-B11	TouchUp Paint Kit DOE, Ice	
179745	500452	Rebuild Kit, Diverter	
182641	500455-CP	Stem Extension Kit, Pol Chr	
182642	50338	Detent	
177748	50340-VF	Escutcheon, Pol brass	
182643	50344-CP	Bonnet, Chrome	
154845	50355-VF	Bonnet, Pol Brass	
182644	50588-BN	Diverter Body Assy, *Brushed Nickel	
182648	51261	Clip	
182649	51419	Seat	
189794	51967-CP	8 x 1.25 Screw, Chrome	
170192	52054	Access Pack Wall Screw	
182650	52156	5.50 LG Tube	
154844	52478	O-Ring	
164797	52588	Screw	
182651	52703	Overflow Tube	
182888	52865-BN	8-32 x 1.87 Screw, * Br Nkl	
182652	52936-CP	Hndl & Btnn Assy, Pol Chr	
182653	53448-CP	Screw, Chrome	
159108	534-NA	UM 1848/1849 Install Kit	
173257	550-NA	UM 1821/1822 Install Kit	
182655	55108	O-Ring	

Parts (Continued)

Part #	Mfg #	Description	Price
182659	56318-RP	Seat Replacement Kit, RP	
165965	56702	Shank	
225354	57081-CP	Centerpiece Handle, Chrme	
182676	57386	O-Ring & Diaphragm	
222659	57411-BN	Lift Rod, Br Nickel	
183342	57411-G	Lift Rod, Br Chrome	
182677	57711	O-Ring	
161416	577-NA	UM 1164/1165 Install Kit	
182679	57745-CP	Trend Blade Handle, Chrme	
182680	57751	Spray Diverter	
173294	57930-VF	Threaded Escutcheon, Polished Brass	
162186	58015-VF	Sleeve, Pol Brass	
168631	58180-CP	Escutcheon, Chrome	
182682	58249	1/4" IPS Pipe Cap	
182683	58307-VF	OBS Shower Head Assy, Polished Brass	
182685	58895-CP	Pair Handle Kit, Chrome	
162749	591-NA	UM 1136/1173 Install Kit	
156756	592-NA	UM 1134/1174 Install Kit	
161743	593-NA	UM 1834/1835 Install Kit	
182689	59636-G	Mixer Sleeve, Br Chrome	
182690	59637-G	Handle Base, Br Chrome	
182691	59637-VF	Handle Base, Pol Brass	
182686	59418	Lower Bushing	
182692	60380	10-24 x 1.5 Screw	
182693	64503	Hanger	
182694	65054-S	10-24 x 3.25 Screw, Pol SS	
182889	65061-BV	Suction Cover, *Br Bronze	
182695	65156-0	Switch Flange, White	
182522	65156-47	Switch Flange, Almond	
182696	65226-96	Suction Cover Plug, Biscuit	
182697	65879	.395 Retaining Ring	
165925	67429	Flange	
165927	67889	PVC Jet Housing Assy	
182699	70504	SA Cold Plug Button	
182700	70505	Plug Button	
182701	70539	Threaded Sleeve	
180038	70593-CP	SA Brass Inserts, Chrome	
156915	71015	1.174 x 1.03 O-Ring	
182702	71016	O-Ring	
181966	7117-NA	Test Seal Kit	
055352	71906	Stem Adapter	
177273	71908	Acrylic Handle For Mixer	
182703	71911	Mixer Face Plate	
166030	71940	Bulk O-Ring	

* Vibrant Limited Lifetime Warranty

www.waterconcepts.net • Serving our Customers Since 1946 • www.plumbsupply.com

Kohler Repair Parts

Parts (Continued)

Part #	Mfg #	Description	Price
172588	71947-CP	Lever Handle, Chrome	
190311	71973-CP	Handle Lever	
182890	722901	Silver 3600A Top Bracket	
182704	73065	Medium Stem Adapter	
182705	73066	Large Stem Adapter	
153331	73094	Adapter	
158723	73175	Flexible Shaft	
158724	73177	Drain Rod	
158720	73179	Sleeve	
164075	73203-G	Bezel IR Sensor, Chrome	
172152	73330	Spacer	
178094	73326-BN	Nozzle Assy, *Br Nickel	
158722	73404-CP	Tube Assy, Pol Chrome	
158718	73439-CP	Lift Rod, Chrome	
172755	73455-CP	Escutcheon, Chrome	
182198	73703	Side Valve	
182708	73719-BC	Stem Extension, Chrome	
165687	73744-BN	Spout Kit, *Br Nickel	
182709	73860	Tee Assy	
172068	74385-G	Escutcheon, Br Chrome	
158314	74675-2BZ	Overflow Hood Assy, ORB	
182716	75059	Diaphragm Assy	
182717	7511-58	Shank, Thunder Grey	
182718	75462	Graphic Cover	
162495	75564	Retaining Ring	
177491	75601-BN	Lav Short Bonnet, *Br Nckl	
153434	75610-CP	Bonnet, Pol Chrome	
182719	75740	Adjustment Collar Assy	
158239	75771-CP	Transfer Valve Cap, Chrome	
225355	42669-CP	Stem/Skirt Handle	
168741	76602-CP	Escutcheon Assy, Chrome	
182720	76704-0	Bonnet Cap, White	
073775	76704-CP	Bonnet Cap, Pol Chrome	
152934	76713	1/4-28 X .25 Screw	
182722	76755-VF	Handle Skirt, Pol Brass	
182724	77012-VF	Lav Handle Skirt, Pol Brass	
182727	77099	Bearing	
182729	77148	Stop Stem Kit	
182932	77172-BN	Lav Escutcheon, *Br Nickel	
164796	77642	O-Ring	
157465	77887-VF	Lever Handle Assy, Brass	
159624	77971-47	Graphic Cover, Almond	
160137	77971-96	Graphic Cover, Biscuit	
162319	78042-2BZ	Plug Button, ORB	
161850	78042-96	Plug Button, Biscuit	

Parts (Continued)

Part #	Mfg #	Description	Price
182933	78050-BN	Escutcheon, *Br Nickel	
181411	78139-BV	Lav Handle Assy, *Br Brnz	
159432	78139-2BZ	Handle Assy, ORB	
182934	78139-CP	Handle Assy, Chrome	
182730	78148-CP	Handle Assy, Chrome	
182731	78155	10-24 x .625 Screw	
182935	78172-BN	Stopper Assy, *Br Nickel	
160987	78205-47	Plug Button, Almond	
156226	78205-96	Plug Button, Biscuit	
163179	78205-BV	Plug Button, *Br Bronze	
156120	78205-2bz	Plug Button, ORB	
183343	78205-G	Plug Button, Br Chrome	
182732	78205-VF	Plug Button, Pol Brass	
158237	78562-58	Grip Ring, Thunder Grey	
131130	78797	Rubber Seal	
184161	78923-BN	Collar, *Brushed Nickel	
153015	78925	Hose Guide Assy	
152208	78969-58	Adapter, Thunder Grey	
165028	79150-58	Adapter Kit, Thunder Grey	
182734	800065-CP	Lever Handle, Chrome	
157839	83143	Seal Diaphragm	
183344	834404	M6 Screw	
185858	83451	Cap Assy	
183345	836664	Mounting Hardware	
152205	84100	O-Ring	
182737	84786	Hardware Pack Seat	
081376	85500	High Flow PBU Shower 3/4" Mixer Cap Kit	
167088	85516	Set Screw Spout Assy	
182940	85698-CP	ABS Escutcheon, Chrome	
167086	86036	O-Ring/Bearing Kit	
166292	86633	Bath Stem	
166482	86861-CP	Lift Rod, Polished Chrome	
182944	87117	Backing Plate	
164794	87118-CP	Collar, Chrome	
181643	87390	SP Filter Head	
187099	87448-CP	Sleeve, Pol Chrome	
166995	87536	8-32 x 1.87 Screw	
176620	88057-BN	Plug Button Assy, *Br Nckl	
182945	88093-G	10-24 x 2.63 Screw, Br. Chr	
182946	88227-AF	Shower Escutcheon, *French Gold	
175356	88532-96	Trim Ring Kit, Biscuit	
182948	89279	Hold Down Plate	
158886	91915	Hardware Kit	

* Vibrant Limited Lifetime Warranty

www.plumbsupply.com • Serving our Customers Since 1946 • www.waterconcepts.net

Kohler Repair Parts

Parts (Continued)

Part #	Mfg #	Description	Price
186467	93766-0	1-Button Switch Cover, White	
166427	93838	1" PVC Tube Repair Kit	
182950	94497	Flat Pillow Kit	
180291	94853	Flex 1-1/2" Service Kit	
182738	95045	8 x 8 .75 Screw	
186466	97740	Mode Switch Assy	
176680	99272-CP	Escutcheon, Chrome	
186260	99272-SN	Escutcheon, *Pol Nickel	
056035	B2100	Rod Parts	
170699	CB-DXCLC10F S	Mirrored Cabinet Door	
188928	CB-DXCLC20B AN	Mirrored Cabinet Door	
183171	CB-DXCLC20F S	Mirrored Cabinet Door	
183347	CB-SHLFCLC20	Inner Shelf Pack for CLC20	
183348	CB-SHLFCLC30	Inner Shelf Pack for CLC30	
167063	CB-XSS131-8	8 Repl Shelf Clips	
087887	GP1003736-0	Sprayhead, White	
105414	GP1016515	Kitchen Valve	
120573	GP1035350-CP	Premier Drain Chrome	
086238	GP1036940-CP	Spray Head Kit Pol Chrome	
122914	GP1037021-CP	Std. Plunger Assy, Chrome	
122915	GP1037022-CP	Plunger Brass Assy, Chr	
151936	GP1043211-VS	Simplice Sprayhead, *Stnls	
135542	GP1056873	Piston .5/1.0/1.28/1.6 GPF	
185451	GP1059515	Manual Flush Vacuum Breaker	
117018	GP1074231	Spline Adapters	
122905	GP1077791-0	4"cc Plug Buttons, White	
122906	GP1077792-0	8"cc Plug Buttons, White	
121407	GP1083167	Fill Valve Kit	
152038	GP1092203	Cold Valve Cartridge Assy	
152039	GP1092204	Hot Valve Cartridge Assy	
183237	GP1095915	Handle for Elec Faucets	
183172	GP1105825	Flapper w/ Float Kit	
055368	GP30000	Plug Button Kit	
005943	GP30002	Clockwise Close Valvet	
005944	GP30004	Counter Clockwise Valvet	
055128	GP30090	Niedecken Repair Kit	
055316	GP30100	Plunger Service Kit	
056078	GP30320	Pressure Balance Adapter Kit - Plastic	
055311	GP30413	Lav and Shower Valve	
055353	GP30416	Knob Handle Kit	
072769	GP30420	O-Ring Seal Kit	

Parts (Continued)

Part #	Mfg #	Description	Price
101598	GP41398-CP	Strainer Cup Assy, Chrome	
055340	GP43146	Flair Handle, Clear Acrylic	
055302	GP500520	Pressure Balancing Unit	
055305	GP51487	Tank Gasket w/Bolts	
055338	GP71969	Valve Mixer Kit	
056122	GP75878	Diverter Assembly	
055332	GP76671	Coralais Valve, CCW Close	
055339	GP76672	Coralais Valve, CW Close	
055319	GP76851	Rite-Temp Mixer & PBU SP Kit	
055293	GP77005-RP	1/2" Close CW Hot Ceramic Valve	
055294	GP77006-RP	1/2" Close CCW Cold Ceramic Valve	
055301	GP77548	Coralais & Fairfax Valve	
121052	GP77759	Shower Mixer Cap Kit	
055351	GP77886	SP Mixer Cap Kit	
056127	GP78205-0	Fairfax 1Hdl Plug Button White	
070270	GP78500	Plunger Kit	
180982	GP83996	Gasket for Select Flush Vlv	
055367	GP85061	Beehive Strainer	
055303	GP88921	Flush Ball Kit	
190060	RGP64512	Hanger (2)	

* Vibrant Limited Lifetime Warranty

www.waterconcepts.net • Serving our Customers Since 1946 • www.plumbsupply.com

Malco Repair Parts

Hole Cutter Parts

Hole Cutter Replacement Part

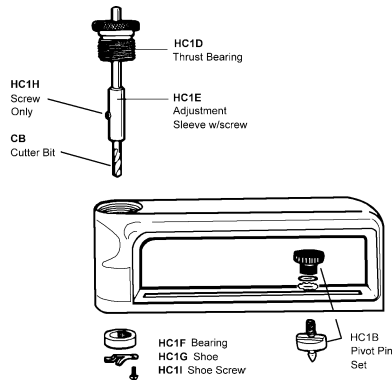

Part #	Mfg #	Description	Price
006379	CB	Malco Bit for HC1 and HC2	
006409	HC1B	Pivot Pinset for HC1	
034909	HC1D	Thrust Bearing w/Adapter	
006410	HC1E	Adjustable Sleeve for HC1	
006411	HC1F	Ball Bearing for HC1	
006412	HC1G	Guide for HC1	
054345	HC1I	Shoe Screw	

McDonnell & Miller Repair Parts

Repair Parts

Replacement Parts

Gasket



Part #	Mfg #	Model #	Used With:	Price
007100	302600	CO-12	42,61,63,64, 65,42S	

Strainer Basket Assembly

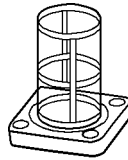

Part #	Mfg #	Model #	Used With:	Price
007104	347100	SA101-38	47, 51, 101	

Moen Repair Parts

Handle Adapters



Part #	Mfg #	Description	Price
058893	100429	Handle Adapter Kit	

Chateau Knob Handle Kit

- 1-Hdl Tub/Shower



Part #	Mfg #	Description	Price
007370	96797	Clear w/ White & Chrome Insert	

Traditional Handle Kit



Part #	Mfg #	Description	Price
016904	94514	Single-Handle	

Faucet Cartridges

1255 Duralast™ Cartridge



Part #	Mfg #	Description	Price
140023	1255	Duralast™	

1-Hdl Faucet Cartridge

- Brass
- Hot/cold operation
- Includes:
 - Cartridge
 - Retainer Clips
 - Installation tool
 - Installation instructions



Part #	Mfg #	Description	Price
007169	1200B	For 1200 Faucet, Bulk (12/Pk)	
007173	1225B	For All Moen 1-Hdl Faucets Bulk (12/Pk)	

Duralast™ 2-Hdl Faucet Cartridge



Part #	Mfg #	Description	Price
189508	1234	2-Hdl, Duralast™	

2-Hdl Faucet Cartridge

- Brass
- Hot/cold operation



Part #	Mfg #	Description	Price
007172	1224B	For 2-Hdl Moen® Faucets, Bulk (12/Pk)	

Posi-Temp 1-Hdl Faucet Cartridge

- Brass
- Hot/cold operation



Part #	Mfg #	Description	Price
007171	1222B	For 1-Hdl Posi-Temp Faucets, Bulk (12/Pk)	

*Lifeshine® Anti-Tarnish Lifetime Finish

www.plumbsupply.com • Serving our Customers Since 1946 • www.waterconcepts.net

Moen Repair Parts

Repair Parts

Commercial Heavy-Duty Posi-Temp Cartridge



Part #	Mfg #	Description	Price
226819	1222HD	Brass Shell	

Commercial Cartridge



Part #	Mfg #	Description	Price
218673	52100	Metering Cartridge	

Commercial 2-Hdl Ceramic Disc Cartridge



Part #	Mfg #	Description	Price
147672	52001	Cold	
147671	52000	Hot	

Commercial 2-Hdl Cartridge



Part #	Mfg #	Description	Price
198775	121550	Hot	
198776	121551	Cold	

Cartridge



Part #	Mfg #	Description	Price
209555	4000	Replacement	

Commercial 1-Hdl Cartridge

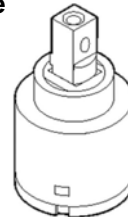

Part #	Mfg #	Description	Price
174468	121620	For Model 8701	

Replacement Cartridge

- For 4999 Roman Tub Valve



Part #	Mfg #	Description	Price
007174	1248	For 4999 Roman Tub Valve	
103661	116719	Replacement Cartridge	

Cartridge Removal Tool

- For 1200, 1225, or 1222 cartridges



Part #	Mfg #	Description	Price
046820	104421	Cartridge Removal Tool	

Cartridge Removal Tool



Part #	Mfg #	Description	Price
020117	14272	Cartridge Retainer Removal Tool	

*Lifeshine® Anti-Tarnish Lifetime Finish

www.waterconcepts.net • Serving our Customers Since 1946 • www.plumbsupply.com



Moen Repair Parts

Service Parts

Part #	Mfg #	Description	Price
036804	93980	Handle Mechanism Kit f/7400/7600 Kitchen Faucet	
212816	179104	Handle Adapter Kit	
226712	116711	Flow Restrictor Kit	
018319	11985	50/50 Drain Assembly	
019922	12689	Pivot Rod & Clip	
163701	131381	Want Kit	
020119	96365	Retainer Clips	
007353	883	Retainer Clip	
021710	96914	Posi-Temp Retainer Clip	
113430	140780	Metal Pop-Up Lav Drain, Chrome	
103739	140780BN	Metal Pop-Up Lav Drain, Brushed Nickel	
103122	140780ORB	Metal Pop-Up Lav Drain, Oil Rubbed Bronze	
226575	131553BN	Pop-Up Lav Drain, Brushed Nickel	
021437	96497	Waste Assembly, Chrome	
023012	12314	Plug & Cap	
007200	1920	Valve Cover Plate, Chrome	
131700	1920BN	Valve Cover Plate, Brushed Nickel	
078637	101663BN	Drain Cover, Brushed Nickel	
101250	101663ORB	Drain Cover, Oil Rubbed Bronze	
035758	1423	Balancing Spool	
201600	52012	Commercial Vacuum Breaker	
140881	588	Donner Commercial C-Clamp	
007391	97557	Monticello Handle Inserts, Chrome	
007382	97462	Monticello Handle Insert, Chrome	
007362	91751	Knob Insert Kit, Chateau	
044029	96782	Chateau Handle Kit	
007369	96791	Chateau Handle Kit	
007360	91192	Diverter Kit for 1Hdl Kit Fct	
007368	96790	Handle Kit, Chrome	
091499	116653	Handle Adapter Kit	
020189	98039	Handle Kit, Acrylic	
118478	136103C	Kitchen Spray and Hose	
144317	106378	Asceri Stem Extension Kit	
019330	97556	Monticello Handle Adapter Kit	
020032	95606	Monticello Handle Hub Kit	
032729	95602	Monticello Handle Hub Kit	
007389	97479	Monticello Stem Extension Kit	
007372	97344	Monticello Stem Extension Kit	
124051	145058	Adapter Kit	
026035	14732	Handle Kit, Chrome	
103271	100818	Extension Kit	
097867	114299	Hose Kit	
045742	12318	Check Stop	

Service Parts (Continued)

Part #	Mfg #	Description	Price
196066	94770	Plug Button & Set Screw	
124741	100112	Monticello aerator, 2.2 gpm	
007201	20200	Aerator	
179477	150259	Hose Kit	
114856	A750	Slide Bars	
162734	104524	Manual Override Button - Flush Valve	
031502	101099	Handle Connector, Spacer, Screw & Washer for Loop Hdl Kitchens	
043598	101310	Chateau Lever Handle Kit	
165290	104401	Multi-Unit AC Power Adapter	
109518	9601	Choiceflo Replacement Filter 9600/9602/9500/9502	
071412	100021	Chateau Handle Cap, Chrome	
071756	100710	Posi-Temp T&S Acrylic Handle	
017776	14699	Retainer Pivot Nut, 1Hdl Kit Fct	
022554	15528	Escutcheon Screws	
007163	10089	Legend & Chateau 1Hd T&S Knob Handle Stop Tube	
031100	96987	Stop Tube, PosiTemp 1-Hd TS Trim	
089374	100657	Handle Kit, Chrome	
186665	221672	Weymouth Hot & Cold Handle Caps, Chrome	
225625	221672BN	Weymouth Hot & Cold Handle Caps, Brushed Nickel	
017751	13463	Chateau Tub Fct Stem Extension	
007371	96884	Handle Insert Kit	
215829	155655	Screen Filter	
224150	155658	Hardware Kit	
146281	10116	Plug Button Kit, Chrome	
216901	104444	Commercial Supply Line	
007168	1198	Push Button Diverter	
032769	13462	Handle Adapter Kit	
224151	155651	Hardware Kit	
025797	13769	Chateau Escutcheon, Chrome	
017752	13774	Wall Tube, Chrome	
121811	163WR	Escutcheon Screws, Wrought Iron	
105725	128284	Twin Elbow	
216105	131109	Handle Kit, Chrome	
212814	179103	Handle Adapter Kit	
185665	AT2099ORB	T/S Accent Kit, Oil Rubbed Bronze	
201230	143530	Diverter Plug	
195900	A714	Vacuum Breaker, Chrome	
121669	96945	Handle Extension Kit	
211430	140710	Cartridge Nut	
221963	130153BN	Handle Escutcheon, Brushed Nickel	
124535	129102BN	Trim Ring, Brushed Nickel	

Repair Parts

*Lifeshine® Anti-Tarnish Lifetime Finish

www.plumbsupply.com • Serving our Customers Since 1946 • www.waterconcepts.net

Moen Repair Parts

Repair Parts

Spout O-Ring Kit



Part #	Mfg #	Description	Price
007167	117	Bulk	
215830	155654	O-Ring Kit	
201190	146789	O-Ring Kit	
020120	96778	O-Ring Kit	

Aerator

- 2.2 gpm
- Male thread



Part #	Mfg #	Description	Price
007264	3919	2.2gpm Male Thread	

3924 Aerator



Part #	Mfg #	Description	Price
007265	3924	Chrome	

*Lifeshine® Anti-Tarnish Lifetime Finish

www.waterconcepts.net • Serving our Customers Since 1946 • www.plumbsupply.com

EL Mustee Repair Parts

Shower Stall Parts



80.400

Part #	Mfg #	Description	Price
007562	80.438	Handle Screw	
007563	80.440	Stem & Bonnet Assembly	
007564	80.441	Renu Seat - Brass	
034313	80.449	Crystal Handle	
034311	80.450	Hot Index Plug	
034312	80.451	Cold Index Plug	
034544	80.454	Stem for 80-400 Shower Valve	
034545	80.455	Renu Seat - Brass	
007569	82.400	1-1/2" PVC Shower Drain	

Repair Parts

Navien Repair Parts

Parts & Accessories



O-Ring



Packing O-Ring

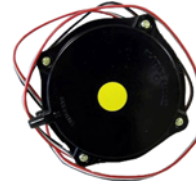

Pressure Flow Sensor

Repair Parts

Part #	Mfg #	Description	Price
149791	2505401A	CPVC Vent Collar	
127478	30000663A	Air Pressure Sensor, NASS9EX00009	
135435	30000669A	Air Pressure Sensor, NASS9EXOS001	
126626	30004802C	Water Flow Sensor, AASS9EXFS003C	
136813	BH0914002B	Motorized 2-Way Valve	
126593	BH2507399A	3-Way Valve, A-Type Copper	
136814	BH1201041D	Ignition Transformer with Wire	
126589	BH1205008A	Transformer	
126623	BH1303013A	Inlet Filter	
126630	BH1403081A	Thermostat (Black Wire)	
134822	BH2101273B	Remote Wire	
126587	BH2124012A	Fuse, 125V, 5A	
126586	BH2203001A	Black Tube	
126628	BH2406032A	Packing O-Ring, 20"Dia x 2.5"T	
126599	BH2421008A	O-Ring, Gas Black, 19.8"Dia x 2.4"T	
126653	BH2421997A	Black O-Ring	
126602	BH2423052A	O-Ring, White or Blue, 15.8"Dia x 2.4"T	
126600	BH2423053A	O-Ring, Red, 17.8"Dia x 2.4"T	
126654	BH2423055A	O-Ring, Black, 17.5"Dia x 2.7"T	
126603	BH2423064A	O-Ring, Red Water, 15.8"Dia x 2.7"T	
126597	PH1062017A	Back-Up O-Ring	
126588	BH2501679A	NG Flame Rod	
136815	BH2507507A	Water Pipe Adapter, Black	
127841	BCRA1129	Ready-Link Connection Cable	
136820	NAPU9GLPCT01	NP Series Circulation Pump	
136821	NARC1GSNR007	Remote Control	
126591	NASS9EXGPS01	Gas Pressure Flow Sensor	
126625	NCVM9EX00005	Flow Adjustment Valve	
126595	PAPCT1W0725	058 Pump	
126632	PH1799013A	Pipe Adapter	

Reznor Repair Parts

Limit Controls

Part #	Mfg #	Description	Price
008477	45602	(180°F) White Auto Limit Control	
008480	50417	(125°F) White Auto Limit Control	
008481	50418	(145°F) Blue Auto Limit Control	
008497	82091	(160°F) Red Auto Limit Control	
008498	82414	(306°F) ECO Energy Cut-Out Limit Control	
008500	85449	(200°F) Yellow Auto Limit Control	
008524	96512	(220°F) High Temperature Limit Control	
008458	123974	(135°F) Fan Control	
008459	123976	(135°F) Fan Control	
027171	131449	(228°F) ECO Energy Cut-Out Limit Control	
030936	147676	(150°F) Fan Control w/Bracket for XL/CXL/EEXL/CEEXL 30 - 400	
066266	196950	Flame Rollout Manual Reset Limit Switch	
083879	209184	Fan Control Replacement Kit	

Repair Parts

Gas Conversion Kits



Part #	Mfg #	Description	Price
008536	99244	LP Conversion Kit for F/FE-50	
153551	269835	LP Conversion Kit for Model UDAP/UDAS Size 30, 45	
153552	269836	LP Conversion Kit for Model UDAP/UDAS Size 60, 75	
153554	269838	LP Conversion Kit for Model UDAP/UDAS Size 150, 175	
153553	269839	LP Conversion Kit for Model UDAP/UDAS Size 200, 250	
066004	201732	LP Conversion Kit for Model UDAP/UDAS Size 300, 400	
073497	205515	LP Conversion Kit	
073498	205516	LP Conversion Kit	
127038	257472	Ignition Conversion Kit (Replaces 97782)	
127637	257473	LP Conversion Kit, Old #G77	

Gas Valves

Part #	Mfg #	Description	Price
008518	96300	1/2" Natural Gas Valve (W/R #36C03-211) Replacement	
008519	96307	1/2" Natural Gas Valve Replacement	
022074	121599	1/2" Single Stage Valve (VR8304M2816)	
027313	147830	1/2" Single Stage Natural Gas Valve (VR8205M1130)	
082010	204301	1/2" Single Stage Natural Gas Valve (VR8205M2955)	
091161	208920	1/2" Single Stage Natural Gas Valve w/Standing Pilot (VR8200M7005)	

Reznor Repair Parts

Motors

Repair Parts

Part #	Mfg #	Description	Price
008476	45331	1/40 hp Motor	
027821	102380	1/8 hp Motor	
008485	61069	1/20 hp Motor	
008508	95547	1/20 hp Motor for Model F 130 & 200	
008509	95548	1/30 hp Motor	
008502	88781	1/6 hp Motor	
066238	196241	Fan Motor for UDAP 45 - 60	
066252	196242	Fan Motor for UDAP 75	
066267	196243	Fan Motor for UDAP 100	
066314	196247	115V Fan Motor for UDAP and UDAS 300 - 400	
008507	95546	Fan Motor	
008515	96287	Fan Motor	
008516	96288	1/15 hp Fan Motor	
102121	147571	Fan Motor	
008514	96018	Venter Motor Assembly	
027692	97727	Venter Motor and Wheel Assembly	
037534	97730	115V Venter Motor and Wheel Assembly	
100298	131410	115V Venter Motor with Capacitor	
170634	214067	115V Venter Motor less Capacitor	
033127	148055	115V Venter Blower Motor	
066281	196036	115V Venter Motor for UDAP and UDAS 150 - 175	
130576	196037	115V Venter Motor for UDAP and UDAS 200 - 250	
109924	214066	115V Venter Motor for VR 175/200 with Capacitor	
144784	217032	120V, 60Hz Venter Motor for UDAP (Replaces 175273)	
139008	260422	115V Venter Motor	

Pilots & Components

Part #	Mfg #	Description	Price
008486	61145	Natural Gas Pilot Assy w/ Orifice, High Tension Lead & Flame Probe; less Pilot Tubing & Flame Sensor	
008523	96360	Natural Gas Pilot Assembly with Orifice, Pilot Tubing, & Thermocouple; (for All F Models)	
020439	110853	Natural Gas Spark Pilot Assembly	
066224	175272	DSI Electrode Assembly	

Pressure Switches

Part #	Mfg #	Description	Price
066242	196388	High Altitude Pressure Switch for UDAP-CV, UDAS 100	
062419	196653	Pressure Switch	
091540	205442	0.20"wc Low Speed White Label Pressure Switch	
091216	205443	Low Speed Yellow Label Pressure Switch	
066288	201158	1.10"wc Pressure Switch	

Reznor Repair Parts

Transformers

Part #	Mfg #	Description	Price
008461	131988	120/24V Transformer	
008462	132204	120/24V, 20VA Transformer	
091211	175265	115V, 30VA Control Transformer	
066225	194808	Transformer, 40VA	

Vent Caps



Part #	Mfg #	Description	Price
067827	111849	5" Vent Cap for UDAP 150 - 250	

Parts

Part #	Mfg #	Description	Price
022890	43425	Inducer Blower Wheel (AD326-215-101-2)	
008527	97534	Natural Gas Pilot Assembly	
020436	97535	LP Pilot Assembly with Flame Sensor	
020437	97572	Compression Nut	
020449	97724	Venter Wheel FE130-400	
021456	97725	Venter Wheel FE25-100	
021538	18549	RBM Relay All FE Models	
008534	98697	Flame Rod	
021502	116019	37-1/8" Tubular Section for TR & TR-H Models	
060039	116045	Burner On Light	
091538	120545	Venter Wheel	
020765	121275	Block Vent Switch	
026634	132007	Venter Wheel	
061819	135979	Venter Wheel	
027310	147165	Flame Sensor	
027317	148085	18" Ignition Cable	
066231	195036	Venter Wheel Assembly	
066222	195265	Control Board	
066223	195292	Flame Sensor	
066237	196949	Flame Rollout	
084139	197205	High Altitude Conversion Kit	
067749	201685	3 amp Fuse	
086607	204611	DSI Electrode Assembly for Model VR	
073531	204955	DSI Ignition Control	
123105	257531	UDAP Circuit Board	
133894	259521	Time Delay Relay Kit	
139262	262971	Time Delay Relay Kit	
036781	CC2	Vertical Vent Terminal/Combustion Air Inlet Assembly through Roof for UEAS Model	

Repair Parts

Rinnai Repair Parts

Tankless Water Heater Parts & Accessories

PC Board

Part #	Mfg #	Description	Price
074884	U245-500	PC Board for 2532FFU	
141779	U245-500F	PC Board for REU-2532-FFU	

Water Filter Assembly

- O-Ring, plug & filter

Part #	Mfg #	For Use with	Price
098970	H98-510-S	Continuum 2424	

Parts

Replacement Parts



Pipe Clamp



80400013, 80400014

Part #	Mfg #	Description	Price
114108	104000021	Gas Valve Kit for R75LS & R94LS	
136286	806000019	Gas Valve	
136284	808000020	Draft Inducer	
142945	104000181	Heat Exchanger	
135781	804000013	3-Way Diverter Valve for Q85S & Q130S	
135777	804000014	3-Way Diverter Valve for Q175S & Q205S	
113465	104000011	Electrode Rod Kit	
114110	104000023	Electrode Kit for R75LS & R94LS	
104584	EI-189	Igniter/Sparker	
108019	REU-EZC-1US	EZ Connect Cable (for the R94LS, R75LS, R50LSi, and R98/3237FFU/W Units Only)	
139993	REU-MSB-M	Multi Unit Tankless Water Heater Manifold Electronic Control Kit	
139994	REU-MSB-C1	Cable Connect Ultra/Condensing and Luxury Series	
139995	REU-MSB-C2	Cable for Connecting MSB-M Control Units	
135488	105000068	Igniter/Sparker	
136287	805000026	5 Amp Fuse, 3-Pk	
114112	104000022	Flame Rod Kit for R75LS & R94LS	
136285	805000036	Ignition Electrode and Gasket	
108197	AH66-398-2	Electrode Gasket	
145426	805000033	High Limit Switch	
120655	104000017	Water Flow Servo and Sensor	
145430	805000032	Return & DHW Sensor	
145429	805000034	Water Pressure Sensor	
145428	805000035	Supply Sensor	
145423	805000040	Flue Gas Sensor with Cable	
145427	805000047	Outdoor Reset Sensor	
115221	104000018	Water Flow Control Assembly Kit for V2532	
114107	104000028	Water Flow Control Assembly Kit for R94LSi & R94LSe	
114116	104000029	Water Flow Control Assembly Kit for R75LSi & R75LSe	

Rinnai Repair Parts

Parts (Continued)
Replacement Parts

Part #	Mfg #	Description	Price
150390	104000163	Water Servo Valve	
115250	104000019	Fan Assembly Kit for V2532FFU, V2520	
142946	104000198	Bypass-Servo Assembly	
065656	169044	Pipe Clamp 2402	
136282	805000024	MCBA Control Unit	
143828	805000028	MCBA Display	
145424	807000040	120V Pump For Q85 & Q130	
145425	807000041	120V Pump For Q175 & Q205	
114472	AU183-562	Fan Connecting Packing	

Repair Parts

Ruud Water Heater Repair Parts

Repair Parts

Water Heater Parts



RTG-20040

Part #	Mfg #	Description	Price
109636	RTG-20040	Ez-Link Cable Connects (2) Tankless Gas Water Heaters to Operate As One Unit	
074314	AP12938	42" Aluminum Anode Rod	
063009	SP11309C	44" Resistor Magnesium Anode Rod	
091619	SP8371B	52" Anode Rod w/Resistor Flex	
063007	SP11248R	Dip Tube	
113598	SP6830	Adapt-O-Flange	

Blower Assembly

Part #	Mfg #	Description	Price
100247	AP13416	Blower Assembly for 40/50 gal PowerVent Units	
133976	SP13605	Blower Assembly for 40/50 gal PowerVent Units	

Control

Part #	Mfg #	Description	Price
073493	AP12419	199,000 BTUH Main Control PC Board	
137362	AP14672	LP Electronic Gas Control	
113853	SP20161A	Natural Gas Wiper Control & Gas Valve Assembly for PowerVent 2	
113854	SP20162A	LP Gas Wiper Control & Gas Valve Assembly for PowerVent 2	
120504	SP20170A	Natural Gas FV Wiper Control & Gas Valve Assembly	
120505	SP20170B	Natural Gas FV Wiper Control & Gas Valve Assembly	
101157	SP20123B	FV Wiper Electronics	

OEM Screw-In Elements - 1-1/2" Copper

- Specifically designed for Marathon and Eclipse Water Heaters
- Includes gasket
- Low Watt Density



Part #	Mfg #	Description	Price
116994	SP10698MH	240V/4500W, 12.33" Length	

OEM Screw-In Elements - 1-1/2" Titanium

- Specifically designed for Marathon and Eclipse Water Heaters
- Includes gasket
- Low Watt Density



Part #	Mfg #	Description	Price
141163	SP213790	240V/4500W, 14" Length	
132919	SP213670	240V/4500W, 16.5" Length	

Electric Water Heater Elements Copper - R-Tech

- Screw-in elements - 1 Inch
-Fits most water heaters with 1" NPSM threads
- R-Tech - Features a patented restored design that increased the life of both the element and water heater tank
- Watt Density Guide - lower watt density means the element stays cooler and will last longer
-LWD: low watt density (100 watts/in² or less)
-MWD: medium watt density (101-150 watts/in²)
-HWD: high watt density (over 150 watts/in²)



Part #	Mfg #	Description	Price
126122	SP10552JH	240V/3000W, 10-5/8" HWD	
063001	SP10552KL	240V/3500W, 13-3/8" LWD	
078390	SP10552ML	240V/4500W, 13-3/4" LWD	
063002	SP10552MH	240V/4500W, 13-5/8" HWD	
063000	SP10552PH	240V/5500W, 13-1/2" HWD	
076289	SP10552QH	240V/6000W, 11-3/4" HWD	
062998	SP10874FH	120V/1500W, 7-11/16" HWD	
062997	SP10874GH	120V/2000W, 7-11/16" HWD	
062996	SP10874HH	120V/2500W, 9-7/16" HWD	

Ruud Water Heater Repair Parts

Electric Water Heater Elements Stainless Steel - R-Tech

- *Screw-in elements - 1 Inch*
-Fits most water heaters with 1" NPSM threads
- *R-Tech - Features a patented restored design that increased the life of both the element and water heater tank*
- *Watt Density Guide - lower watt density means the element stays cooler and will last longer*
-LWD: low watt density (100 watts/in² or less)
-MWD: medium watt density (101-150 watts/in²)
-HWD: high watt density (over 150 watts/in²)



Part #	Mfg #	Description	Price
063479	SP10867LL	208V/4000W, 10.08", LWD	
063481	SP10867NL	208V/5000W, 19.25", LWD	
063486	SP10869ML	240V/4500W, 15-1/2" LWD	
073434	SP10869MM	240V/4500W, 13-1/2" MWD	
063480	SP10867ML	208V/4500W, 17.58" LWD	
063482	SP10867QL	208V/6000W, 19-1/4" LWD	
063488	SP10869QL	240V/6000W, 19-1/8" LWD	
063494	SP10870NL	480V/5000W 19.28", LWD	
063493	SP10870ML	480V/4500W 17.63" LWD	
063495	SP10870QL	480V/6000W 19.21" LWD	

Heating Element Wrench

- *Allows use of screwdriver for additional leverage*



Part #	Mfg #	Description	Price
063006	SP35871AB	Fits 1-1/2" Hex	
169225	PT49057	Fits 1-1/2" & 1-7/8" Hex	

Igniter

Part #	Mfg #	Description	Price
063860	SP10972	Hot Surface Igniter	
108321	SP12143	Igniter for Advantage Plus Comm Water Heaters	
064395	SP12560B	Spark Igniter & Pilot Assembly (LP) for PowerVent 2	
064396	SP12560C	Spark Igniter & Pilot Assembly (LP) for PowerVent 2	
064393	SP12562	High Performance Blower Assembly for PowerVent 2	
100162	SP13447B	Flammable Vapor Sensor/FV Wiper Replacement Kit	
129324	SP14218A	Igniter for PowerVent Units	

Water Heater Parts (Continued)

Igniter

Part #	Mfg #	Description	Price
109619	SP14218B	Igniter for PowerVent Units	
146883	SP20307	Piezo Igniter	

Pilot Assembly

Part #	Mfg #	Description	Price
104045	SP13418	Pilot Assembly - Natural Gas	
117788	SP13422	Pilot Assembly - Natural Gas	
177859	SP13884A	Pilot Tube Assembly Kit	
170382	SP20305A	Pilot Assembly - Natural Gas	

Switch

Part #	Mfg #	Description	Price
128923	AP12767	On/Off Switch	
063577	SP11875	Vacuum Switch	
065175	SP12766	Pressure Switch for PowerVent 2	
101155	SP20116	Vacuum Switch for PowerVent	
140234	SP20312	Pressure Switch for PowerVent	

Thermostat

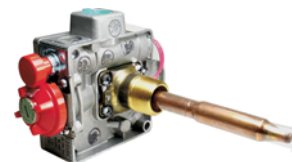

Part #	Mfg #	Description	Price
063014	SP12258P	Thermostat for 40 & 50 gal VR Models - LP Gas	
063576	SP12390	PowerVent Therm-O-Disc Thermostat	
131662	SP20164	Gas Control Thermostat, Natural Gas for Use with 2LAC9	

Gas Control (Thermostat) - LP



Part #	Mfg #	Description	Price
156423	SP20304B	LP Gas Control	

Repair Parts

Ruud Water Heater Repair Parts

Repair Parts

Gas Control Assembly

- Rheem/Ruud replacement gas control thermostat
- For PowerVent Models only



Part #	Mfg #	Description	Price
159000	SP20231	6"x6"x4" Replacement Gas Control for PowerVent Models	

Gas Control (Thermostat) - NG



Part #	Mfg #	Description	Price
180874	AP14270C	Natural Gas Control	

2-Pole High Limit - Normally closed Thermostat Contacts (TOD)

- Upper Thermostat in residential electric water heaters
- With Simultaneous design:
-Both elements are on at the same time



Part #	Mfg #	Description	Price
063011	SP11699	240V Single Element Thermostat	

2-Pole High Limit - Normally Open & Normally Closed Thermostat Contacts (TOD)

- Upper thermostat for residential electric water heaters
- Non-Simultaneous element operation
- 59T/66T Series



Part #	Mfg #	Description	Price
063013	SP11698	Upper Thermostat, 90° to 150° Adjustment Range	
135205	SP210245	Upper Thermostat, 80° to 140° Adjustment Range	

1-Pole High Limit - Normal Closed Thermostat Contacts (TOD)

- Commonly used for 120V residential water heaters with only one element
- 59T/66T Series



Part #	Mfg #	Description	Price
063004	SP11700	Upper Thermostat, 90° to 150° Adjustment Range	

Electric Thermostats w/o High Limit Control (TOD)

- Used as the lower Thermostat in residential electric water heaters
- 59T Series



Part #	Mfg #	Description	Price
063012	SP11695	Lower Thermostat, 90° to 150° Adjustment Range	
141066	SP210239	Lower Thermostat, 90° to 150° Adjustment Range	
111142	SP310020	Lower Thermostat, 110° to 170° Adjustment Range	

Robertshaw Thermostat

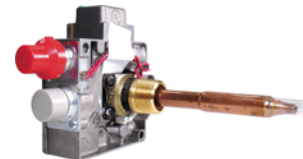

Part #	Mfg #	Description	Price
063016	SP12258B	LP Gas, 57° - 160° Control Valve with LHMain Burner	

Thermostat Shank



Part #	Mfg #	Description	Price
147598	AP14696A	Thermostat Shank - 1.926	
139027	AP14696B	Thermostat Shank - 2.870 PV	



Ruud Water Heater Repair Parts

Thermocouple



Part #	Mfg #	Description	Price
063005	SP6379R	24" Thermocouple	

Valve

Part #	Mfg #	Description	Price
076815	AP12575B-1	3/4" T&P Valve for FVIR Long Shaft	
063423	SP11652B	Natural Gas Valve	
109615	SP13845A	Natural Gas Intelli-Vent Valve for PowerVent Units	
109616	SP13845B	Natural Gas Intelli-Vent Valve for PowerVent Units	
109617	SP13846A	LP Gas Intelli-Vent Valve for PowerVent Units	
109618	SP13846B	LP Gas Intelli-Vent Valve for PowerVent Units	
127436	SP20167C	LP Gas Valve and Thermostat	
129691	SP623336	Vacuum Relief Valve Assembly for Marathon Water Heaters	
133902	SP20171A	Gas Control Thermostat Kit	
159270	SP20303A	Nat Gas Control Thermostat Kit	

Vent Damper

Part #	Mfg #	Description	Price
108929	AP13142	Vent Hood Damper Assembly	
065184	AP13143-1	Vent Hood Damper Assembly	

Warranty Upgrade

Part #	Mfg #	Description	Price
078740	SP20079	Protection Plus 4-Year Kit	

Flammable Vapor Ignition Resistant (FVIR) Parts

Robertshaw Part

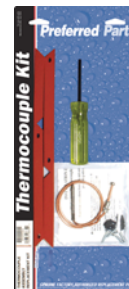

SP20064

Part #	Mfg #	Description	Price
073471	SP20064	Thermocouple Kit	
073470	SP20065	Pilot Assembly - Natural Gas	
082616	SP20075	Pilot Assembly - Natural Gas	
097155	SP20055	Piezo & Pilot Assembly Kit	

White-Rodgers Part

Part #	Mfg #	Description	Price
109602	SP14270G	Gas Valve - Natural Gas	
109603	SP14270H	Gas Valve - Natural Gas	
109607	SP14269A	Gas Valve - LP Gas	
109609	SP14269E	Gas Valve - LP Gas	
109611	SP20127	Pilot Assembly Kit - Natural Gas	
109612	SP20128	Pilot Assembly Kit - LP Gas	

Common Service Part

Part #	Mfg #	Description	Price
082082	SP12112G	Electric Drain Valve	
073962	SP12112S	Brass Drain Valve	
082825	SP8346	Watts 100XL, 3/4", 150 psi, 100,000 BTU Temperature & Pressure Relief Valve	
073469	SP20063	Gasket Kit	

Commercial Water Heater Parts

Part #	Mfg #	Description	Price
069329	AP12231B-1	3/4" NPT Brass Drain Valve	
144116	AP9013D	130 to 199K Temperature and Pressure Relief Valve	
144117	AP9012B	250 to 400K Temperature and Pressure Relief Valve	
065179	SP10963D	Natural Gas Valve	
073487	SP12145	Gas Valve	
073418	AP12015-1	Thermostat and High Limit	

Repair Parts



Ruud Water Heater Repair Parts

Commercial Water Heater Parts (Continued)

Repair Parts

Part #	Mfg #	Description	Price
082771	AP12841	3-Pole Contractor	
144111	AP14074-3	Temperature Sensor	
144119	AP14092-2	GHE Main Control Harness	
144120	AP14157-3	GHE Blower Control Harness	
144121	AP14158-6	GHE Main Power Harness	
145841	AP14159-5	GHE Gas Valve Harness	
144112	AP14280-1	Exhaust Temperature Flue Sensor	
144115	AP14685-2	Condensate Trap	
144118	AP14758	Display Jumper Harness	
144128	AP14859	Diffuser Nipple	
144124	AP15261	Ground Wire Harness	
144123	AP15294-4	GHE Igniter Cable Harness	
143193	RTG20224A	Commercial Upgrade Chip for RTGH-95DVN Natural Gas	
131528	RTG20216A	Commercial Conversion Kit for RTG-84DVN	
075285	SP12142	ECO/Temperature Probe	
073486	SP12144	Flame Rectification Probe	
073495	SP12189	Combustion Blower	
148468	SP15138	Burner Mounting Flange Gasket	
144109	SP20259	Flame Sensor Rod Kit	
063119	SP5886	Hand Hole Gasket	
073485	SP12140	Pressure Switch	
065181	SP10764B	Pilot Assembly for Natural Gas Units	
073488	SP12136	130,000 BTUH Main Control PC Board	
073489	SP12137	160,000 BTUH Main Control PC Board	
073490	SP12186	199,000 BTUH Main Control PC Board	
065180	SP11798B	High Limit Thermostat	
065178	SP12234B	Commercial Light Duty Gas Thermostat	
084096	SP8293	Therm-O-Disc Upper Thermostat	
073160	SP8295	Therm-O-Disc Lower Thermostat	
065182	SP10763B(C)	Ignition Control	
093329	SP8828D	Ignition Cable	
131606	RTG20210	Horizontal Vent Termination Kit	

Schwank Repair Parts

Tube Heater Parts

Part #	Mfg #	Description	Price
129015	JA-0528-XX	4" Horizontal Flue Vent Terminal	
130962	JA-0568-XX	24VAC DSI Control	
134135	JA-0571-KT	DSI Tube Heater Igniter & Gasket	
129442	JA-0775-XX	120/24V, 20VA Transformer	
129441	JL-0703-AA	LP Gas Valve	
147558	JL-0771-XX	1/2" x 24" SS Flexible Gas Connector	
147560	JL-0771-YY	3/4" x 36" SS Flexible Gas Connector	
129016	JL-0772-XX	Dual Scale Line Voltage Thermostat	
129010	JL-0798-SH	1-7/8" 'S' Hook - 25/Pk	
136512	JL-0800-SH	2" Safety Snap Hook - 24/Pk	
129009	JL-0798-JC	50' Box of #8 Jack Chain	
136510	JL-0800-XX	200' Roll of #2 Lion Chain	
130761	JM-0303-KT	24V Transformer/Relay Kit	
129018	JS-0508-SM	90° Aluminum Steel Elbow Kit	
129962	JS-0532-SE	4" Fresh Air Intake Adapter	
129012	JS-0532-VC	4" Outside Air Intake Wall Vent Hood with Birdscreen	
129452	JS-0568-KT	24V Thermostat Control Relay Kit	
129447	JS-0576-AA	Air Proving Switch - .85" WC	
129444	JS-0576-XX	Air Proving Switch - .48" WC	
129445	JS-0576-YY	Air Proving Switch - .30" WC	
129450	JS-0577-SS	Blocked Flue Switch - .58" WC	
129448	JS-0577-ZZ	Blocked Flue Switch - 1.41" WC	
129449	JS-0577-YY	Blocked Flue Switch - .90" WC	
134136	JS-0518-XX	24" High Voltage Ignition Cable	

Sloan Repair Parts

Manual Flushometer Parts
Royal Flushometer Parts

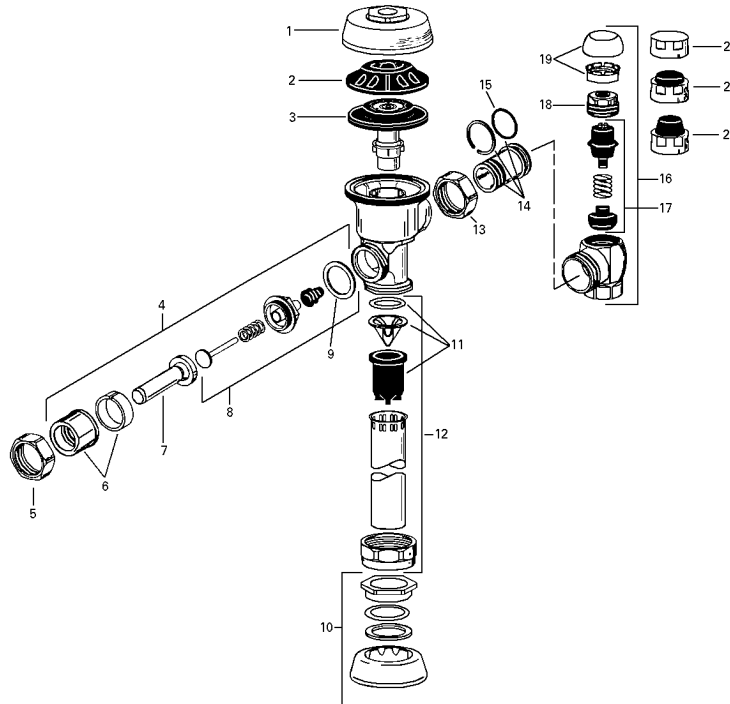

Repair Parts

Part #	Mfg #	Model	Ref	Description	Price
083761	3301503	A-1042-A		Repair Kit Royal 1.0 gpf Dual Filter Diaphragm Kit	
010089	0301075	A-11	2	Inside Cover	
036284	3301070	A-1101-A	3-5	Rebuild Kit 1.6 gpf - Closet Exposed	
036283	3301071	A-1102-A	3-6	Rebuild Kit 3.5 gpf - Closet Exposed	
036282	3301074	A-1107-A	3-9	Rebuild Kit 1.0 gpf - Urinal Exposed	
036291	3301075	A-1108-A	3-10	Rebuild Kit 1.5 gpf - Urinal Exposed	
010092	5301188	A-156-A	5	Diaphragm	
010097	5301139	A-31	9	Handle Gasket	
021329	0301082	A-6	5	Handle Coupling, CP	
010107	0301168	A-71	2	Inside Cover	
010108	0301172	A-72	1	Outside Cover, CP	
010112	5302279	B-32-A	4-2	Handle Assembly	
036285	3302306	B-51-A	8	Handle Repair Kit	
010119	0302390	B-73-A	4-1	Handle Assembly	
010137	0306146	F-5-AT	10-3	1-1/2" Spud Coupling, CP	
010138	0306140	F-5-AU	10-2	1-1/4" Spud Coupling, CP	
010136	0306125	F-5-AW	10-1	3/4" Spud Coupling, CP	
020801	3308790	H-1009-A	19-2	3/4" Vandal Resistant Stop Cap For H-700-A	
010148	3308853	H-541-ASD	17-1	1" Screwdriver Stop Repair Kit	
010149	3308856	H-543-ASD	17-2	3/4" Screwdriver Stop Repair Kit	
010150	0308801	H-551-A	14	2-1/16" Tail Assembly, CP	
010152	5308696	H-553	15	O-Ring	
010154	0308848	H-582	20-2	3/4" Cap, CP	

Sloan Repair Parts

Manual Flushometer Parts (Continued)
Royal Flushometer Parts

Part #	Mfg #	Model	Ref	Description	Price
028922	3308386	H-700-A	16-2	1" Adjustable Screwdriver Stop w/Vandal Resistant Cap #19-2	
036290	3393004	V-600-AA	12-1	3/4" x 9" Vacuum Breaker, CP	
036288	3393006	V-600-AA	12-1	1-1/4" x 9" Vacuum Breaker, CP	
036287	3393007	V-600-AA	12-3	1-1/2" x 9" Vacuum Breaker, CP	
036286	3323182	V-651-A	11	Vacuum Breaker Repair Kit	

Regal Flushometer Parts

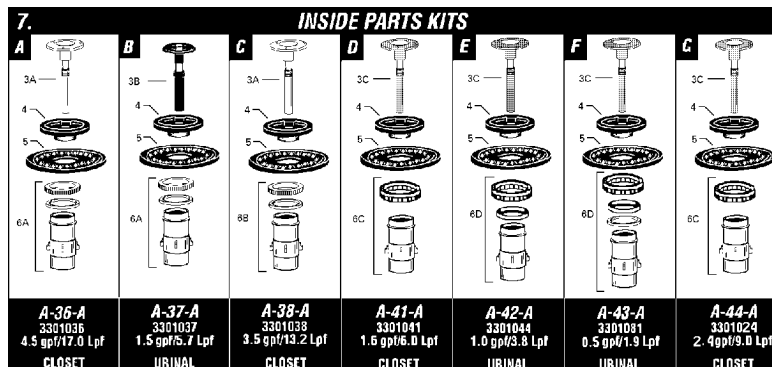
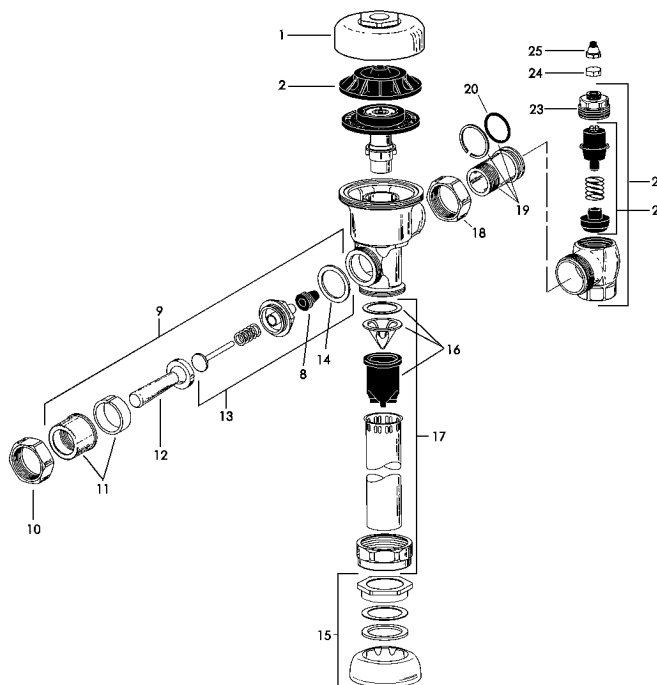

Part #	Mfg #	Model	Ref	Description	Price
010091	5301111	A-15-A	4	Molded Disc	
010093	5301189	A-156-AA	4,5,8,14	Diaphragm Repair	
010094	5301236	A-163-A	6A	Guide Assembly for 4.5 gpf Closet & 1.5 gpf Urinal	

Sloan Repair Parts

Manual Flushometer Parts (Continued)

Regal Flushometer Parts

Repair Parts

Part #	Mfg #	Model	Ref	Description	Price
010095	5301058	A-19-AC	3A	Relief Valve Closet	
010096	5301059	A-19-AU	3B	Relief Valve Urinal	
010098	3301036	A-36-A	7A	4.5 gpf Closet Repair Kit	
010099	3301037	A-37-A	7B	1.5 gpf Urinal Repair Kit	
010100	3301038	A-38-A	7C	3.5 gpf Water Saver Repair Kit	
010101	3301041	A-41-A	7D	1.6 gpf Closet Repair Kit LC	
010102	3301044	A-42-A	7E	1.0 gpf Urinal Kit LC	
010113	5302297	B-39	8	Seal	
010115	5302305	B-50-A	13	Handle Repair Kit	
010141	5308156	H-37	24	Cap CP	
010176	5323005	V-500-AA	17-1	3/4" x 9" Vacuum Breaker CP	
010182	5323006	V-500-AA	17-2	1-1/4" x 9" Vacuum Breaker CP	
010178	5323007	V-500-AA	17-3	1-1/2" x 9" Vacuum Breaker CP	

Piston Operated Flushometers

GEM 2® Piston Operated Flushometers

- Fixed volume piston with filtered O-ring by-pass
- ADA Compliant metal oscillating handle
- Vandal-resistant stop cap
- Adjustable tailpiece
- Vacuum breaker flush connection
- High copper, low zinc brass castings for dezincification resistance
- Non-hold-open handle and no external volume adjustment to ensure water conservation
- Handle packing, stop seat and vacuum breaker molded from PERMEX™ rubber compound for chloramine resistance



GEM 2 Repair Kit

Part #	Mfg #	Model	Description	Price
112656	5307074	G-50-A	Handle Repair Kit, 6/Pk	

Sloan Repair Parts

**Sensor Operated Flushometer Parts
OptimaPlus® Flushometer Parts**

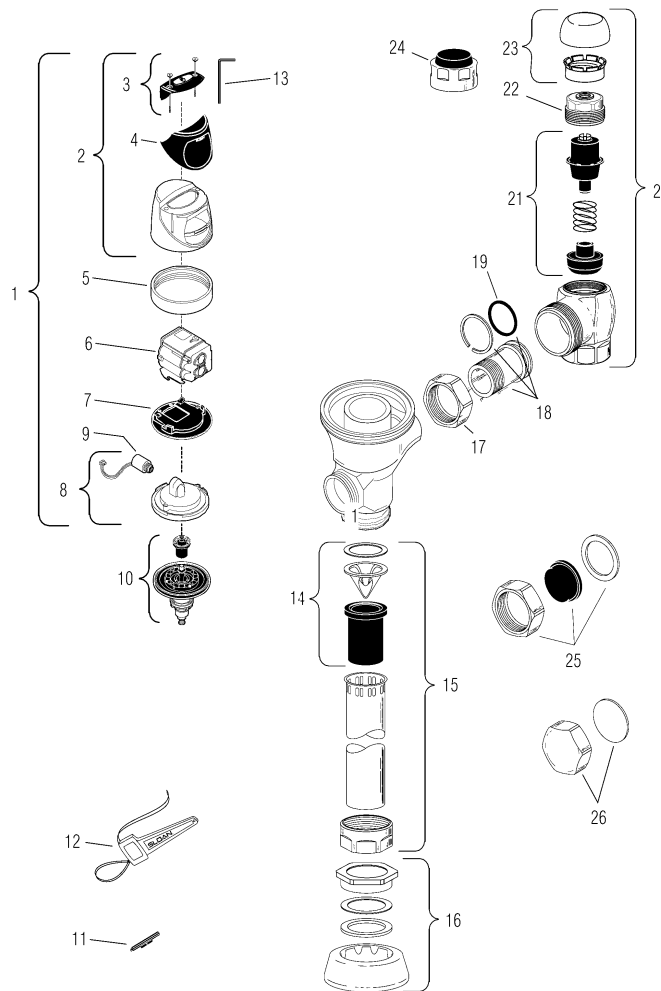

Repair Parts

Part #	Mfg #	Model	Ref	Description	Price
057970	3301500	EAF-12		Diaphragm Only Kit	
043726	3325815	EBV-1018-A	26	Handle Cap - Decorative	
066898	3325001	EBV-1020-A	10	1.6 Flex Tube Diaphragm Inside Part Kit	
066899	3325000	EBV-1022-A	10	OptimaPlus Repair Kit, 1.0, 1.5 Urinal	
093722	3325450	EBV-129-A-C	6	G2 Electronic Module - Water Closet	
084024	3325451	EBV-129-A-U	6	G2 Electronic Module - Urinal	
100551	0325172	EBV-130-A	3	G2 Override Button Assembly	
080085	3325453	EBV-136-A	9	Isolated Solenoid	
130178	0325160	EBV-138-A	1	G2 Cover/Ring/Sensor Assembly - Water Closet	
085884	3325462	EBV-144-A	9	Isolated Solenoid Operator	
071385	0325176	EBV-146-A-C		G2 Electronic Module Optima 1.6 - Closet	
071242	0325177	EBV-146-A-U		G2 Sensor Module Urinal	
028637	5325813	EBV-18		Quad Ring	

Sloan Repair Parts

Sensor Operated Flushometer Parts (Continued)

OptimaPlus® Flushometer Parts

Part #	Mfg #	Model	Ref	Description	Price
022200	3325013	EBV-60-A		Metal Cover Assembly with Override Button - Water Closet	
057264	0305118	EL-165-2		Solenoid Coil, 24VAC	
049083	0305165	EL-163-A		Sloan Solenoid Assembly	
010216	3308855	H-541-AA	21	1" Screwdriver Angle Stop Repair Kit	

Flush Valve Transformer



Part #	Mfg #	Model	Description	Price
010126	0345154	EL-154	120VAC/24VAC, 50/60Hz (50VA), Box-Mount	

Optima® Flushometer Parts

110/111/115/116/140/152/153 ES-S

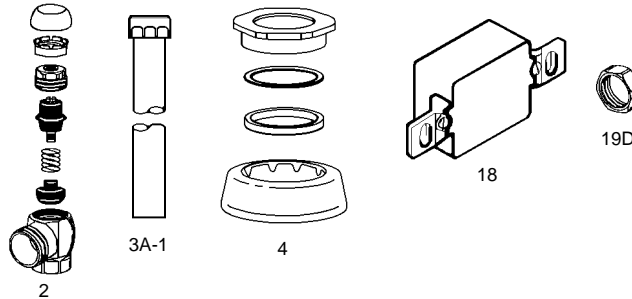

Part #	Mfg #	Model	Ref	Description	Price
010125	3305621	EL-1500-L	18	Sensor Repair Kit - Closet	

Optima® Systems Solenoid/Sensor Parts and Assemblies List

Part #	Mfg #	Model	Description	Price
010123	0337086	DO-22	O-Ring	

Showerheads

Act-O-Matic



Part #	Mfg #	Model	Description	Price
010088	4020100	AC-11	2.5 gpm Std Self-Cleaning Showerhead, CP	

Sloan Repair Parts

Replacement Parts and Accessories

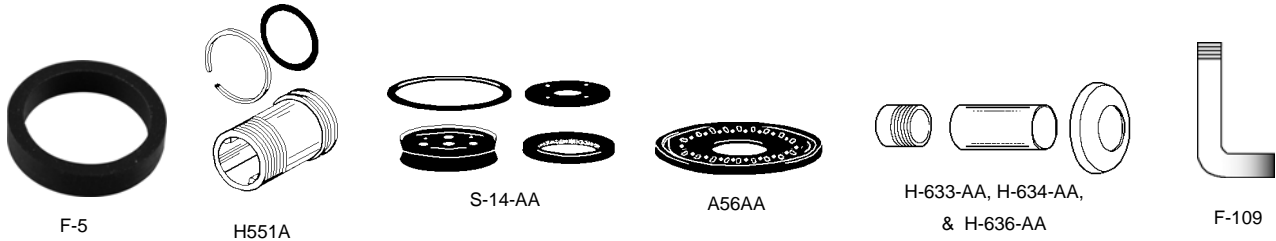

Repair Parts

Part #	Mfg #	Model	Description	Price
023238	3301077	A-1008-A	3/4" Spud Coupling Kit	
029505	3301079	A-1010-A	1-1/2" Spud Coupling Kit	
057971	3301501	A-1038-A	Closet Repair Kit	
032380	0301104	A-175-A	Low Pressure Guide Repair Kit (P-600-EGL)	
045723	0301178	A-19-ALCM	Closet Relief Valve, Brass LC	
010103	0301255	A-50	Super Wrench	
010104	5301170	A-56-A	Segment Diaphragm w/A-29 Copper Gasket	
010105	5301176	A-56-AA	Diaphragm Repair	
010122	3303398	C-70-A	Push Button For Concealed Royal & Crown - Contains #7-11	
032633	3305043	EL-128-A	Actuator Cartridge	
019381	3305620	EL-1500	Urinal Sensor Repair Kit	
028928	0396322	F-109	1-1/2" x 21" x 5" Tubular Bend, CP	
010134	5306055	F-3	3/4" Red Friction Ring	
010133	5306058	F-3	1-1/2" Red Friction Ring	
010135	5306113	F-5	3/4" Slip Joint Gasket	
020802	3308772	H-1010-A	1" Vandal Resistant Stop Cap	
010143	3308277	H-47-AA	Stop Repair Kit	
010146	3308780	H-533-AS	Sweat Solder Kit For 1" Supply Closet & Urinal	
010147	3308786	H-536-A	3/4" Sweat Adapter Kit	
010151	0308803	H-551-A	3-1/16" Long Adjustable Tailpiece, CP	
034119	0308805	H-551-A	4-1/16" Long Adjustable Tailpiece, CP	
016687	5308850	H-584	Screwdriver Control Stop Seat Only For 1" H-540, H-600 & H-700 Series Stop	
043117	3308782	H-633-AA	Sweat Solder Kit 1" w/Cast Set Screw Flange (YBYC)	
111258	3308785	H-634-AA	Sweat Solder Kit 1", CP	
084384	3308788	H-636-AA	Sweat Solder Kit 3/4" w/Cast Set Screw Flange (YBYC)	
010159	0310083	J-212-A	1-1/2" Solid Ring Pipe Support - 5 C/E Complete, CP	
010166	5319046	S-14-A	Molded Cup	
010170	5319086	S-30	1-1/2" Gasket	
010175	3322079	V-101-A	Vacuum Breaker Repair Kit	
010174	5322001	VBF-5	1-1/2" Gasket	

Sloan Repair Parts

Vacuum Breaker



Repair Parts

Part #	Mfg #	Model	Description	Price
010185	5323010	V-500-A	1-1/2" x 11-1/2", RB (140 ES-S & 152 ES-S)	
010179	0323014	V-500-AA	1-1/2" x 13-1/2", CP	
010180	0323015	V-500-AA	1-1/2" x 21-1/2", CP	
010181	0323016	V-500-AA	1-1/2" x 24-1/2"	
010183	0323020	V-500-AA	1-1/4" x 21-1/2"	
021735	0323057	V-500-AA	1-1/2" x 32-1/2"	
010184	0323210	V-500-AA	3/4" x 15", CP	

Sloan Repair Parts

FLUSHMATE® Replacement Parts



BU100505-K



C-100500-K

Part #	Mfg #	Description	Price
080376	B-108288	Duckbill Valve (Air Inducer) Allows Air Into Tank but Not Out	
046465	BL100504-3-K	Lower Supply Kit for 503 & 504 Series	
046464	BU100505-K	Upper Supply Kit for Flushmate Pressurized Tank	
010120	C-100500-K	Flush Cartridge for All Flushmate Series	
046467	RK100100	Replacement Supply System for All Series Except 503 & 504	

Repair Parts

Speakman Repair Parts

Speakman® Parts

Part #	Mfg #	Description	Price
068748	RPG05-0520	Vacuum Breaker Hub Repair Kit	

Repair Parts

T & S Brass Repair Parts

Handles



- Chrome-plated zinc handle
- B-WH models come with screw, all others, screw is sold separately

Part #	Mfg #	Description	Price
010415	001636-45	Lever Handle Cold Index	
010416	001637-45	Lever Handle Hot Index	

Swing Nozzles



Part #	Mfg #	Description	Price
044168	062X	12" Swing Nozzle	

Repair Kits



B-9K



B-10K

Part #	Mfg #	Description	Price
061402	B-9K	Lever Handle Kit	
010405	B-10K	Repair Kit for B-0107	
046499	B-21K	Eterna Cartridge Replacement	
107843	B-39K	Brass Rotary Waste Valve Parts Kit	

T&S Brass Parts

Bonnet Assembly



Part #	Mfg #	Description	Price
030182	002856-40	B502 Bonnet Assembly	

Spindle



002711-40



002712-40

Part #	Mfg #	Description	Price
010419	002711-40	Cold Spindle 174A	
010420	002712-40	Hot Spindle 175A	
028123	002713-40	Eterna LH Spindle Assembly	
028124	002714-40	Eterna RH Spindle Assembly	
085560	005960-40	Eterna Spindle Assembly, Hot	
110659	005959-40	Eterna Spindle Assembly, Cold	

Supply Nipple

- Brass

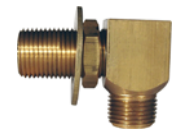

Part #	Mfg #	Description	Price
110214	B-0230-K	Angle Supply Nipple	

Waste Valve with Drain Adapter - Twist



Part #	Mfg #	Description	Price
107844	B-3940	3.0" Sink Opening, 1.5" or 2.0" Drain Outlet	

Washer



Part #	Mfg #	Description	Price
010411	001041-45	Spreader Washer	

Parts & Accessories

Part #	Mfg #	Description	Price
010417	018L	Stem	
010427	067L	Stem	
010426	066L	Removable Insert	
010425	064L	Removable Insert	

Repair Parts



Taco Repair Parts

Pro-Fit™ Replacement Parts

- For Bell & Gossett and Armstrong pumps

Coupler

- Rugged, cast zinc w/steel reinforced eyelets
- Heavy-duty spring
- Fits all 1/2" motor shafts
- Std Woods 3-J for all 5/8" motor shafts (opt 1/2" inserts included)



Repair Parts

Part #	Mfg #	B&G Part #	Armstrong Part #	Price
079914	COU-ABC-100	118705,189110,118712,118723	806026-001	
079915	COU-D100	118473,118709	810120-003/006,806137-000,807436-000	

Thermolec Repair Parts

Parts & Accessories

Part #	Mfg #	Description	Price
130137	10-02-005	Magnetic B/U, 50A Spade Style Contactor	
130139	10-02-006	CCT-140 SPDT Diverting Valve Pump Relay	
128230	17-02-102	CBLR055 Incoloy Element 5kW, 240V	
121185	17-02-103	CBLR060 Incoloy Element 5.75kW 240V	
130133	17-02-107	CBLR130 Electronic Temperature. Sensor - Supply Water	
110489	17-02-110	CBLR025 Mono Energy Control Board TH-600-M	
130131	17-02-115	CSR113 Solid State Relay SSR-20-DC	
130130	17-02-116	CTR040 Control Transformer 30VA 240/24V	

Repair Parts

Triangle Tube Repair Parts

Prestige Parts

Part #	Mfg #	Description	For:	Price
115737	PSSSENS01	Outdoor Sensor Kit		
093308	PSSTND01	Floor Stand	PS110, PS175, PS250	
107252	PSSTND02	Wall Kit, Recommended f/Hanging on Anything Other Than a Masonry Wall		
107253	PSSTND03	Floor Stand Kit Use w/PSSTND02 Wall Kit	PE110 & PS399	

Electronic Components

Part #	Mfg #	Description	For:	Price
091015	PSRKIT04	NTC Sensor	PS110, PS175 & PS250	
091016	PSRKIT13	Blower Kit w/Gasket	PS110 & PS175	
091019	PSRKIT19	Transformer with Surge Protection	SOLO 110	
114363	PSRKIT20	Control Module Display	SOLO 110	
118949	PSRKIT50	Control Module	SOLO 110	
120439	PSRKIT55	Blower Kit w/Gasket	PS110	
117640	PSRKIT58	MCBA Control Module Replacement Kit	PE110	
138226	PSRKIT63	NTC3 Domestic Hot Water Sensor	PE110	

Burner Components

Part #	Mfg #	Description	For:	Price
091021	PGRKIT01	Gas Valve Kit	PS110	
091017	PSRKIT15	Igniter w/Gasket	SOLO 110	
120440	PSRKIT41	Gas Valve	SOLO 399	

Internal Components

Part #	Mfg #	Description	For:	Price
091020	PGRKIT20	Lwco Pressure Device	SOLO 110	
118581	PSRKIT40	399 Blower with Gasket	SOLO 399	

Repair Parts

Union Brass Repair Parts

Parts
Valve Assemblies

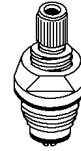

80038



80080

Part #	Mfg #	Description	Price
010503	80038	1837AC Cold Valve Assembly	
051376	80080	1839A-C Cold Valve Assembly	

Repair Parts

Ruud Heating & AC Repair Parts

Blower Wheels

Blower Wheel

- CW Rotating



Repair Parts

Part #	Mfg #	Rotation	Nom Size	Overall Dia x Overall W	Hub	Disc Shape (Hub Side)	# of Blades	Price
009619	70-18631-01	CW	9" x 7"	9-1/2" x 7-1/8"	1/2"	Convex	43	
024572	70-20218-02	CW	10" x 7"	10-5/8" x 7-3/16"	1/2"	Convex	48	
016858	70-18629-01	CW	10" x 10"	10-5/8" x 10-5/8"	1/2"	Concave	48	
051174	70-23110-30	CCW	10" x 10"	10-5/8" x 10-3/4"	1/2"	Concave	48	
030369	70-23111-05	CW	11" x 7"	11-15/16" x 7-1/8"	1/2"	Concave	54	
074404	70-23111-43	CW	11" x 7"	11-15/16" x 7-1/8"	1/2"	Concave	54	
049454	70-24254-02	CW	11" x 7"	11-15/16" x 7-1/8"	1/2"	Convex	54	
009622	70-20602-01	CW	11" x 10"	11-7/8" x 10-11/16"	1/2"	Concave	54	
125744	70-103207-01	CW	12" x 7"	12-7/8" x 7"	1/2"	Convex	43	
050595	70-24119-01	CW	12" x 7"	12-3/4" x 7"	1/2"	Concave	43	
086470	70-24179-01	CW	12" x 11"	12-25/32" x 11-1/8"	1/2"	Convex	43	
019546	70-24041-01	CW	12" x 11"	12-3/4" x 11-1/8"	1/2"	Concave	43	
051179	70-42540-02	Reversible	15" x 15"	15" x 15"	1"	Double Convex	51	

Compressors

R-410 Scroll Compressor

Copeland R-410A Air Conditioning Scroll Compressor - 208/230-1-60

- Crankcase heater not included



Part #	Mfg #	Vendor #	Capacity MBTUH	Run Capacitor	Start Capacitor	Start Kit	Kick Start	Crankcase Heater	Price
113737	55-102045-14S	ZP16K5E-PFV	15.5	30/370	88-106/330	SK-A1	42-TO5	44-17402-44	
113736	55-102045-01S	ZP21K5E-PFV	21.3	40/370	88-106/330	SK-A1	42-TO5	44-17402-44	
113735	55-102045-02S	ZP21K5E-PFV	21.3	40/370	88-106/330	SK-A1	42-TO5	44-17402-44	
113903	55-102045-31S	ZP24K5E-PFV	24.0	40/370	88-106/330	SK-A1	42-TO5	44-17402-44	
113901	55-102045-03S	ZP31K5E-PFV	31.0	45/370	88-106/330	SK-A1	42-TO5	44-17402-44	
131585	55-102045-17S	ZP38K5E-PFV	37.5	45/370	175-216/330	SK-A3	42-KS1	44-17402-45	
113730	55-102045-09S	ZP42K5E-PFV	42.0	70/370	88-106/330	SK-A1	42-KS1	44-17402-45	
113734	55-102045-15S	ZP34K5E-PFV	34.0	45/370	88-106/330	SK-A1	42-TO5	44-17402-45	
113900	55-102045-26S	ZP51K5E-PFV	51.0	70/370	175-216/330	SK-A3	42-KS1	44-17402-45	
113729	55-102045-13S	ZP54K5E-PFV	54.0	80/370	175-216/330	SK-A3	42-KS1	44-17402-45	

Ruud Heating & AC Repair Parts

R-22 Scroll Compressor

Copeland R-22 Air Conditioning Scroll Compressor - 208/230-1

Copeland
small products



Repair Parts

Part #	Mfg #	MBTUH*	Electrical	RLA	Max Dimensions H x W x L	Stub Tube Conn(ID") Dischg, Suc	Mnt Dim W x L	Price
133280	ZR16K5E-PFV-800	20.3	208/230-1-60	9.3	15.86" x 9.50" x 9.50"	1/2", 3/4"	7.5" x 7.5"	
222707	ZR21K5E-PFV-800	27.5	208/230-1-60	32.9	18.75" x 11.23" x 10.38"	22/25", 1-1/8"	7.5" x 7.5"	
133217	ZR25K5E-PFV-800	32.8	208/230-1-60	15	15.86" x 9.50" x 9.50"	1/2", 3/4"	7.5" x 7.5"	
133806	ZR28K5E-PFV-800	36.9	208/230-1-60	15.7	15.86" x 9.50" x 9.50"	1/2", 3/4"	7.5" x 7.5"	
222708	ZR32K5E-PFV-800	42.6	208/230-1-60	17.1	15.86" x 9.50" x 9.50"	1/2", 3/4"	7.5" x 7.5"	
180171	ZR42K5E-PFV-800	54.8	208/230-1-60	22.1	16.94" x 9.56" x 9.59"	1/2", 7/8"	7.5" x 7.5"	
141164	ZR54K5E-PFV-800	69.7	208/230-1-60	28.2	16.94" x 9.56" x 9.59"	1/2", 7/8"	7.5" x 7.5"	

Expansion Valves

Thermal Expansion Valve

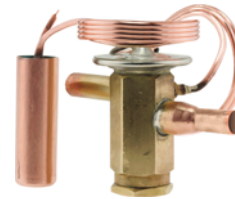

Part #	Mfg #	Description	Price
140730	611006	2T R-22 Expansion Valve	
140731	611007	3T R-22 Expansion Valve	
140732	611008	4T R-22 Expansion Valve	
140733	611009	5TR-22 Expansion Valve	
140734	611011	2T R-410A Expansion Valve	
140735	611012	3T R-410A Expansion Valve	
140736	611013	4T R-410A Expansion Valve	
134296	611064	3T R-410A To R-22 Conversion, Thermal Expansion Valve	
141976	61-103652-05	2T R-410A TX Expansion Valve	
131854	61-21922-46	1.5T R-22 TXV Expansion Valve	
105705	61-21922-47	2T R-22 TXV Expansion Valve	
106949	61-21922-48	2.5T R-22 TXV Expansion Valve	
131857	61-21922-50	4T R-22 TXV Expansion Valve	
116721	61-21922-51	5T R-22 TXV Expansion Valve	
105707	61-21922-82	2.5T R-22 TXV Expansion Valve	
105708	61-21922-83	3T R-22 TXV Expansion Valve	
105709	61-21922-84	4T R-22 TXV Expansion Valve	
105710	61-21922-85	5T R-22 TXV Expansion Valve	

Ruud Heating & AC Repair Parts

Fan Blades

Fan Blade with Integral Hub

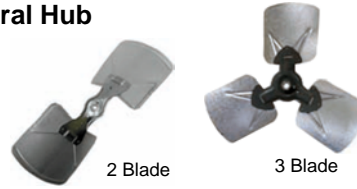

Repair Parts

Part #	Mfg #	Diameter	Pitch	Rotation	# of Blades	Price
079832	70-21859-05	18"	28°	CCW	2	
123681	70-102033-05	18"	30°	CCW	3	
071438	70-20607-04	20"	27°	CCW	2	
107473	70-102011-06	20"	29°	CCW	3	
084834	70-21858-06	22"	21°	CCW	2	
009623	70-20608-01	22"	27°	CCW	2	
105796	70-102011-07	22"	35°	CCW	2	
107476	70-102011-09	24"	22°	CCW	2	
024245	70-19897-01	24"	22°	CCW	3	
103769	70-100580-03	24"	22°	CCW	3	
123680	70-102011-03	24"	24°	CCW	2	
084787	70-26166-01	24"	24°	CCW	2	
096139	70-100580-04	24"	28°	CCW	3	
086771	70-23137-01	24"	19°	CCW	2	
117441	70-21858-17	24"	22°	CCW	3	

Fan Center

- Terminals: W, G, Y, R, C
- 120V Primary voltage
- 24V Secondary voltage
- Transformer frequency: 50,60Hz
- Relay not included, SPDT configuration
- Relay coil voltage: 24V



Part #	Mfg #	Description	Price
009344	47-19807-04	Fan Center, 4-1/4" x 4-1/4"	

Gas Valves



Part #	Mfg #	Description	Price
009499	60-22174-02	Natural Gas Valve, 150,000 BTU/HR @ 1" WC Pressure Drop	
009501	60-22447-01	Natural Gas Valve, 150,000 BTU/HR @ 1" WC Pressure Drop	
067321	60-24215-03	Modulating Natural Gas Valve	
127859	60-24394-01	Natural Gas Valve, 150,000 BTU/HR @ 1" WC Pressure Drop	

Ruud Heating & AC Repair Parts

Gas Control



Part #	Mfg #	Description	Price
132343	SP20166A	Gas Valve - Natural Gas	
129359	SP20166B	Gas Valve - Natural Gas	
128611	SP20166C	Gas Valve - Natural Gas	

White-Rodgers 36G Gas Valve

- 140,000 BTUH Capacity @ 1"wc pressure drop
- Slow opening
- Hot Surface/ Direct Spark

60-24180-81



Part #	Mfg #	Description	Price
125567	60-24180-81	36G23-202E91 1/2" NG Hot Surface/Direct Spark 1-Stg 140,000	
143224	60-101921-81	36G55-521 1/2" NG Hot Surface/Direct Spark 2-Stg 140,000 BTUH Capacity	

White-Rodgers 36J Gas Valve

- Natural gas
- 140,000 BTUH Capacity @ 1"wc pressure drop
- 4-3/4"L x 2-3/8"W x 4-1/4"H



Part #	Mfg #	Description	Price
179394	60-103901-01	36J23-502 1/2" NG Hot Surface/Direct Spark 1-Stg 140,000 BTUH Capacity	

Honeywell VR8215S1313 Gas Valve

- Natural gas
- 150,000 BTU/HR Capacity @ 1"wc pressure drop
- 4-7/16"L x 2-3/4"W x 4-1/8"H
- Hot Surface/Direct Spark



Part #	Mfg #	Description	Price
172007	60-105055-01	VR8215S1313 1/2" NG Hot Surface/Direct Spark 1-Stg 150,000 BTU/HR Capacity	

Repair Parts

Ruud Heating & AC Repair Parts

Repair Parts

Honeywell VR8304 Intermittent Pilot Dual Automatic Valve Combo Gas Control

- For use in 24VAC gas-fired, intermittent pilot with capacities from 30-415 cfh
- Includes all standard features plus:
 - Controls include 100% safety shut-off, manual valve, two automatic operators, pressure regulator & pilot adjustment
 - Standard & slow opening natural gas models include natural to LP gas conversion kits; LP to natural gas conversion kits are also available
 - All adjustments, wiring connections & pilot outlets are accessible from the top of control
 - Adjustable servo regulator
 - Compatible with ECO connector
 - On-Off lighting sequence
 - Use with S86F,H; S860D; S8600F,H; S8610 & S90A,B Control Modules
 - Single stage unless otherwise noted
 - Capacities based on 1" p.d. 30,000 BTUH minimum, 300,000 BTUH maximum

Honeywell

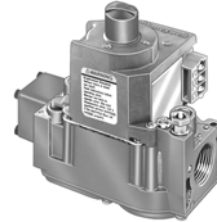

Part #	Mfg #	Description	Price
009498	60-21621-81	VR8304M3101 3/4" NG Pilot 1-Stg 270,000 BTUH Capacity	

Gas Valve Spring Kit

Part #	Mfg #	Description	Price
009490	60-18759-07	Gas Valve Spring Kit	

Heat Cell

Part #	Mfg #	Description	Price
008940	AS-61164-83	Heat Cell - Aluminum	

**Inducer Motors
Induced Draft Blower with Gasket**



Part #	Mfg #	Description	Price
090631	70-101087-81	120V 1-Stg Sheet Metal Inducer Housing Right Side Discharge	
160013	70-104157-82	Induced Draft Blower Assembly with Gasket	
009627	70-21496-83	120V 1-Stg Polymeric Inducer Housing Left Side Discharge	
009632	70-22436-02	120V Induced Draft Blower w/ Gasket	
024248	70-23641-81	208-230V 1-Stg Sheet Metal Inducer Housing Right Side Discharge	
072199	70-23641-82	380-415V, 460V, 50-60Hz 1-Stg Induced Draft Blower w/Gasket	
009635	70-24033-01	120V 1-Stg Polymeric Inducer Housing Right Side Discharge	
041979	70-24157-03	120V 1-Stg Cast Metal Inducer Housing Right Side Discharge	
027297	70-24206-01	120V 2-Stg Polymeric Inducer Housing Right Side Discharge	

Ruud Heating & AC Repair Parts

1-Stage Draft Inducer Blower

- 115V 1-Speed
- For use with Rheem/Ruud gas furnaces models RGRK-07EMAES and UGRK-07EAMES



Part #	Mfg #	Description	Price
120707	703020	Draft Inducer Blower	
131722	70-24071-94	Draft Inducer Blower	

2-Stage Draft Inducer Blower

- 115V 2-Speed
- For use with Rheem/Ruud gas furnaces models RGRK-07EMAES and UGRK-07EAMES



Part #	Mfg #	Description	Price
136280	70-100612-03	Draft Inducer Blower	
139895	70-100612-81	Draft Inducer Blower	
139892	70-102691-81	Draft Inducer Blower	
139896	70-102814-81	Draft Inducer Blower	
139894	70-103086-01	Draft Inducer Blower	
145465	70-103597-01	Draft Inducer Blower	

Blower Assembly



Part #	Mfg #	Description	Price
015970	70-22165-81	Blower Assembly	
009631	70-22436-01	Blower Assembly	
137367	AP15109-1	Blower Assembly	

Vent Motor with Blades

- 208/230V, Nominal 3,000 rpm
- Includes centrifugal proving switch
- Mounting bolt pattern 4-1/4" x 4-1/4"
- Includes (3) fan blades (3", 3-1/2" and 4" diameter)



Part #	Mfg #	Description	Price
009414	51-21964-11	Vent Motor with Blades, 208/230V Nominal 3000 rpm	

Repair Parts

Ruud Heating & AC Repair Parts

Motor Mount



Part #	Mfg #	Description	Price
022307	562300109	Blower Motor Mount Kit For 48 Frame	
093274	AE-58384-81	Screw Mounting Kit, 5-5/8" 48 Frame Motors, 16" Nom Blower Mounting Bolt Circle Dia, (4) Arms	
041165	AE-61698-82	Screw Mntg Kit, 5-5/8" 48 Frame Motors, 14-13/16" Nom Blower Mntg Bolt Circle Dia, (4) Arms	
008936	AS-55306-02	Condenser Motor Plate Mount Kit	
223191	AS-55306-82	Cendenser Motor Plate Kit	

Limit Controls

Therm-O-Disc Temperature Limit Control Switch

36T Small Flanged Airstream - Manual Reset

- 120/230V maximum rating, 15/10A maximum current rating
- Enclosed disc face
- SPST Switching
- Normally closed
- 300° Open temperature



Part #	Mfg #	Temp Open	Tolerance Open	Color Code	Mounting Tube	Price
009391	47-22861-02	300°F	+/-14°F	Blue	5/32"	

36T Special Small Flanged Airstream - Manual Reset

- 120/230V Max rating, 15/10A Max current rating
- Enclosed disc face
- SPST Switching
- Normally closed
- 250° Open temperature



Part #	Mfg #	Temp Open	Tolerance Open	Color Code	Mounting Tube	Price
103688	47-22861-03	250°F	+/-12°F	--	3/16"	

74T Large Flanged Airstream - Auto Reset

- 230V Max rating, 25A Max current rating
- Enclosed disc face
- SPST Switching
- 3/8" Maximum mounting insertion depth



Part #	Mfg #	Description	Price
141499	47-25115-02	Open Temp: 135°F - 175°F; Close Temp: Open Temp Minus 40°F, 40° Nom Temp Difference	
141500	47-25115-03	Open Temp: 175°F - 215°F; Close Temp: Open Temp Minus 40°F, 40° Nom Temp Difference	

Repair Parts

Ruud Heating & AC Repair Parts

Limit Control Switch - Auto Reset - 69T Heat Assisted

- Normally closed
- Exposed disc face
- SPST Switch type



Part #	Mfg #	Description	Price
009388	47-22860-01	95°F Close Temperature Red	
009389	47-22860-02	100°F Close Temperature Blue	

Limit Switch - Auto Reset 60T Series

- Normal closed
- Flanged airstream
- 1-Pole
- SPST Switch type
- Normal closed



Part #	Mfg #	Description	Price
160015	47-104465-01	95°F Close Temperature Yellow	

Limit Control Switch - Manual Reset - 36T

- Flanged Airstream



Part #	Mfg #	Description	Price
009375	47-22453-01	Normally Closed Enclosed Disc Face SPST	
009376	47-22453-02	Normally Closed Enclosed Disc Face SPST	
009390	47-22861-01	Normally Closed Exposed Disc Face SPST	
009393	47-22862-02	Normally Closed Blue Exposed Disc Face SPST	
009395	47-22862-04	Normally Closed Orange Enclosed Disc Face SPST	

Limit Control/Switch



Part #	Mfg #	Description	Price
009351	47-21663-01	Limit Switch	
009367	47-21900-05	Limit Control	
009368	47-21900-06	Limit Control	
009371	47-22383-13	Limit Switch	
026839	47-22383-33	Limit Control	

Repair Parts

Ruud Heating & AC Repair Parts

Repair Parts

Limit Control Switch - Auto Reset - 36T

- Enclosed disc face
- SPST Switch type
- Normally closed
- Board mount 90° strap angle



Part #	Mfg #	Description	Price
009356	47-21711-06	150°F Close Temperature	
009360	47-21711-10	150°F Close Temperature	
034226	47-25349-02	150°F Close Temperature Blue/Blue	
036843	47-25349-03	150°F Close Temperature Yellow/Yellow	
009361	47-21711-11	160°F Close Temperature	
038081	47-25349-01	160°F Close Temperature Red/Red	
038093	47-25349-05	180°F Close Temperature Orange/Orange	
038095	47-25350-07	180°F Close Temperature Green/Green	
034120	47-25350-01	190°F Close Temperature Red/Red	
009354	47-21711-04	200°F Close Temperature	
036657	47-25350-09	200°F Close Temperature Tan/Tan	
040953	47-25350-06	150°F Clos Temperature Brown/Brown	
009403	47-24006-08	Limit Switch	
059560	47-25350-02	Limit Control	
050264	47-25350-04	Limit Control	
085327	47-25350-05	Limit Control	
145464	47-25350-12	Limit Control, 195°F Open	

Motors
ECM Motor



Part #	Mfg #	Description	Price
142897	51-102728-05	ECM Outdoor CA330R Motor	
169001	51-104304-28	1/2 hp Variable Speed ECM Motor	
166659	51-104306-01	Variable-Speed 1 hp Direct Drive ECM 48 Frame	
166281	51-104306-24	1 hp ECM Motor	
166321	51-104306-25	1 hp ECM Motor	
137902	51-42534-24	1/3 hp Fan Motor	
145469	51-102602-01	1/2 hp Communicating Motor	

Ruud Heating & AC Repair Parts

OEM Condenser Motor (208/230V)

- These motors are OEM replacements for Rheem, Ruud, and WeatherKing models; additionally they may be suitable for after market retrofit in many other applications
- Single speed, single phase



Part #	Mfg #	Description	Price
086497	51-100999-02	1/10 hp 825 rpm 208/230V Condenser Motor	
085274	51-100999-03	1/6 hp 1075 rpm 208/230V Condenser Motor	
086548	51-100999-04	1/5 hp 1075 rpm 208/230V Condenser Motor	
086549	51-100998-05	1/3 hp Condenser Motor	
113859	51-100998-13	1/3 hp 1075 rpm 208/230V Condenser Motor	
123683	51-102500-02	Sgl Speed, 1/6 hp 1075 rpm 208/230V CCW 3/370 Capacitor	
105405	51-102500-03	1/6 hp 825 rpm 208/230V Condenser Motor	
105406	51-102500-04	1/5 hp 825 rpm 208/230V Condenser Motor	
113905	51-102500-05	1/10 hp 825 rpm 208/230V Condenser Motor	
099184	51-42179-01	Sgl Speed, 1/3 hp 1075 rpm 208/230-1-60 CCW 10/370 Run Capacitor	
052997	51-42534-01	Sgl Speed, 1/3 hp 1075 rpm 208/220/230-1-50/60 CCW 10/370 Run Capacitor	

Ruud Wholesale Condenser Motor (208/230V)



Part #	Mfg #	Description	Price
009426	51-23055-12	1/5 hp Direct Drive 230V 825 rpm	
009425	51-23055-11	1/5 hp Direct Drive 230V 1075 rpm	

Ruud Wholesale Condenser Motor (460V)



Part #	Mfg #	Description	Price
086789	51-23063-11	Sgl Speed, 1/3 hp 1075 rpm 460-1-60 Reversible 7.5/370 Capacitor	

Condenser Motor



Part #	Mfg #	Description	Price
132537	51-100998-08	1/8 hp Condenser Motor	

Ruud Heating & AC Repair Parts

**Motors (Continued)
Condenser Motor**

Part #	Mfg #	Description	Price
125111	51-102728-11	ECM Condenser	
125103	51-102728-12	ECM Condenser Fan Motor	
125112	51-102728-13	ECM Condenser	
125432	51-102870-01	ECM Condenser (Outdoor)	
125110	51-102870-03	Condenser Fan Motor	
140687	5464	1/6 - 1/3 hp 825 rpm 208/230V Emerson RESCUE Condenser Motor	
061734	51-21853-15	Condenser Motor - 1/3 hp 460/1/60	

TripSaver Condenser Motor



Part #	Mfg #	Description	Price
009424	51-23053-21	1/3 / 1/5 hp Direct Drive 230V 1,075 rpm	
143484	51-103823-01	1 hp 230V X13 Motor	

OEM Indoor Blower Motor



Part #	Mfg #	Capacitor	HP	Volts	Amps	RPM/Speed	Rotation	Price
128889	51-103243-01	15mfd/370V	1/2 hp	120-1-60	8.00A	1,075/4	CCW	
042374	51-23679-01	10mfd/370V	1/2 hp	208/230	2.70A	1,075/3	CW	

Trip Saver Indoor Blower Motor



Part #	Mfg #	Description	Price
009422	51-23022-41	4-Speed 1/6-1/2 hp 1,075 rpm 208/230-1-60 REV 5/370, 7.5/370 or 10.370 Capacitor	

Repair Parts

Ruud Heating & AC Repair Parts

Blower Motor



Part #	Mfg #	Description	Price
100478	51-101879-01	1/3 hp 240V X-13 Blower Motor	
094848	51-101880-01	1/2 hp 208/230V 1-Phase X-13 Blower Motor	
113814	51-102497-01	3/4 hp 230V Variable Speed X-13 Blower Motor with Resilient Rotor	
113813	51-102497-02	3/4 hp 230V Variable Speed X-13 Blower Motor	
009418	51-23012-41	1/6 - 1/2 hp 1,075 rpm 120V 4-Speed Reversible Rotation Tripsaver™ Blower Motor	
028318	51-23017-42	1/4 - 3/4 hp 1,075 rpm 120V Indoor Blower Motor	
016108	51-24070-02	1/2 hp Indoor Blower Motor 120V 1,075 rpm	
024237	51-23555-02	Blower Motor - 3/4 hp 208/230/1/60	
124801	51-21898-01	3/4 hp 208-230/1 V 1075 rpm	
038103	51-23102-08	1/2hp Dir Dr 208-230V 825 rpm	

Motor

Part #	Mfg #	Description	Price
009420	51-23015-91	1/5 hp 120/1/60 1075 rpm 3-Speed	
141494	51-23027-31	Blower Motor 3-Speed 230V 3/4 hp	
145470	51-102605-01	1 hp 120/230V ECM Motor	
127336	51-24374-27	1/2 hp ECM Blower Motor	
125741	51-24374-28	1/2 hp ECM Blower Motor	
052874	51-24376-03	Motor w/ICM Module (Modulating Furnace)	
078007	51-24382-81	1/2 hp ECM Module	
134008	51-102008-08	Condenser Fan Motor	

Motor Mounting Kit

Part #	Mfg #	Description	Price
125546	70-24104-82	Motor Mounting Kit	

Relay's

Control Relay

Sealed Case (SPDT) Control Relay



Part #	Mfg #	Contact Bias	Coil Volts	FLA @120V	FLA @230V	LRA @120V	LRA @230V	Price
009290	42-25104-06	NO/NC	24V	14	8	84	48	

Ruud Heating & AC Repair Parts

Relay - DPTD



Part #	Mfg #	Contact Bias	Coil Volts	FLA @120V	FLA @230V	LRA @120V	LRA @230V	Price
009222	42-18287-12	NO/NC (2)	24V	12	6	60	35	

Open Coil (DPDT) Control Relay

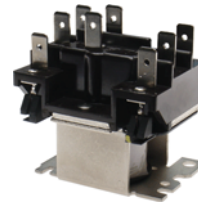

Part #	Mfg #	Contact Bias	Coil Volts	FLA @120V	FLA @230V	LRA @120V	LRA @230V	Price
027431	42-25106-01	NO/NC (2)	24V	13.8	6.9	82.8	41.4	

Control Relay - Small Sealed Case (SPDT)



Part #	Mfg #	Contact Bias	Coil Volts	FLA @277V	LRA @230V	LRA @277V	Price
117427	42-23114-06	NO/NC	24V	20NO, 10NC	60NO, 33NC	60NO, 33NC	

Start Relays - Potential Type



Part #	Mfg #	Hot Pickup (V)	Cold Pickup (V)	Dropout (V)	Max Cont Coil Volt (V)	Start Kit Relay Code	Price
041054	42-25105-01	170-180V	162-175V	40-90V	336V	A	

Time Delay Relay



Part #	Mfg #	Time Delay Adj.	Make Time Delay	Voltage Rating	Current Rating Steady State	Current Rating Inrush	Price
042350	42-ICM102	Variable	.03 - 10 Min	18-230 VAC	1.5	15	

Repair Parts

Ruud Heating & AC Repair Parts

Time Delay Relay



Part #	Mfg #	Time Delay Adj.	Break Time Delay	Voltage Rating	Current Rating Steady State	Current Rating Inrush	Price
121707	47-23433-93	Fixed	.17 Min	18-30 VAC	1	10	

Timer Delay



Part #	Mfg #	Time Delay Adj.	Break Time Delay	Voltage Rating	Current Rating Steady State	Current Rating Inrush	Price
092118	42-ICM	Variable	.17 -16.6 Min	18-230 VAC	1	10	
042351	42-ICM203	Variable	.03 - 10 Min	18-230 VAC	1.5	15	

Time Delay Relay - On Delay On Break (Anti-Short Cycle)



42-22655-02

Part #	Mfg #	Time Delay Adj.	Break Time Delay	Voltage Rating	Current Rating Steady State	Current Rating Inrush	Price
044912	42-22655-02	Fixed	5 Min	18-30 VAC	1.5	-	
047231	42-22655-03	Fixed	.5 Min	18-30 VAC	1.5	-	

Sequencers

Sequencer

24V Angle Bracket with (2) Mounting Holes Sequencer

- DPST-NO

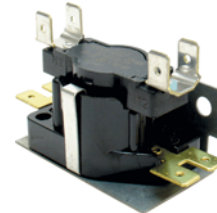

Part #	Mfg #	Poles	Sequencing Off	Sequencing On	Switching	Price
050196	42-23116-08	2	10 - 30	30 - 60	DPST NO	
034057	42-23116-06	2	10 - 40/30 - 160	90 - 160/30 - 60	DPST-NO	
052164	42-23116-09	3	10 - 30	90 - 150/30 - 60	TPST NO	

Ruud Heating & AC Repair Parts

Sequencing Relay

- Flush mount plate w/ mounting hole & tab
- 1/4" Quick connects
- Heater Wattage/ Power Consumption:
24 VAC/.10A-.18A steady state/.35 - 1.0 amps peak for 0.8 sec



Part #	Mfg #	Poles	Sequencing Off	Sequencing On	Switching	Price
137087	PD425078	2	30 - 60	1 - 30	DPST-NO	
185861	425079	2	1 - 30	30 - 60	DPST-NO	

Service Valves

Service Valve

- Front seating valves, isolate sections of a system for servicing and provide a means for refrigerant charging
- All brass corrosion resistant body and solid copper fittings
- Includes 1/4 Flare SAE charge port; communicates with lower fitting when in closed position
- Suitable for R-22 and R-410A, 600 psig maximum working pressure



Part #	Mfg #	Connect	OPP Connect	OAL	Charge Port Location	Price
085196	61-21368-13	3/8" Sweat ODF	3/8" Sweat ODF	4-5/8"	Side	
101321	61-21368-07	3/4" Sweat ODF	3/4" Sweat ODF	5"	Bottom	
096123	61-21368-15	7/8" Sweat ODF	7/8" Sweat ODF	5"	Side	
083261	61-21368-16	7/8" Sweat ODF	3/4" Sweat ODF	5-1/8"	Side	

Service Valve



Part #	Mfg #	Description	Price
092122	803003	1/4" OD Service Valve	
143354	83-CD8403-6PK	3/16" OD Service Valve	

Miscellaneous

Remote Sensor for 90 Series®

- Digital signal output provides superior temperature control, even over long wire runs
- No temperature variance caused by wire resistance
- Choice of styling, indoor models are interchangeable
- Perfect for securing the thermostat in one area or room while sensing temperature in the conditioned space



Part #	Mfg #	Color	Dimensions	Model	Range	Price
102316	F145-1328	Classic White	2-1/8" x 3-1/2" x 3/4"	Indoor	40° to 99°F All Indoor Remote	
101726	F145-1378	Classic White	2-1/8" x 3-1/2" x 3/4"	Outdoor	-40° to 140°F	

Repair Parts

Ruud Heating & AC Repair Parts

Mixed Air Sensor

Part #	Mfg #	Description	Price
076571	470010	Mixed Air Sensor	

Logic Module

Part #	Mfg #	Description	Price
143968	PD470009	Demand Control Ventilation Economizer Logic Module with Heat Pump Input	

Start Kit

- 330 VAC
- 60Hz



Part #	Mfg #	Description	Price
173840	SK-A1	Compatible with with RA13, RA14, RA16, RP14, RP15, UA17, & RJMA Units	

Repair Parts

Ruud Heating & AC Repair Parts

Repair Parts

Pressure Switches

Pressure Control

Low Pressure Control - Auto Reset (Sweat w/o Cap Tube)



Part #	Mfg #	Description	Price
150872	47-101529-09	50 psig Open Pressure 5/16" Sweat Connection, 90° Elbow End	

High Pressure Control - Auto Reset (Sweat w/o Cap Tube)



Part #	Mfg #	Description	Price
113929	47-26184-01	610 psig Open Pressure 420 psig Close, 1/4" Swt Connection, Straight Fitting	

Pressure Control Switch



Part #	Mfg #	Description	Price
161588	42-101225-81	Pressure Switch	
091197	42-101233-81	Pressure Control	
091198	42-101443-89	Pressure Control, 0.45" WC	
091200	42-101443-91	Pressure Control, 0.60" WC	
091311	42-101444-83	Pressure Control, 1.00" WC	
091438	42-101445-83	Pressure Control, 0.40" WC	
083509	42-101447-07	Pressure Control	
098938	42-101447-86	Pressure Control, 1.80" WC	
107479	42-101447-89	Pressure Control, 1.95" WC	
091542	42-101511-84	Pressure Control	
128891	42-101955-02	Pressure Switch for RGRC034T 074T 105T	
137097	42-101955-08	Pressure Switch for RGRC Drain	
109677	42-101956-09	Pressure Switch for RGRC RGTC Vent	
109679	42-101956-10	Pressure Control, 1.20" WC	
128890	42-101956-12	Pressure Switch for RGRC Vent	
107812	42-102056-01	Dual Pressure Control, -0.80" & -1.30" WC	
112161	42-102056-02	Dual Pressure Control, -0.60" & -1.08" WC	
107814	42-102056-03	Dual Pressure Control, -0.86" & -1.20" WC	

Pressure Switches (Continued)

Pressure Control

Pressure Control Switch

Part #	Mfg #	Description	Price
125747	42-102056-05	Dual Pressure Control, -0.40" & -0.60" WC	
107813	42-102056-06	Dual Pressure Control, -0.66" & -1.30" WC	
123676	42-102056-13	Dual Pressure Control, -0.30" & -0.50" WC	
136527	42-102056-22	Dual Pressure Control, -0.40" & -0.30" WC	
145463	42-102056-25	Dual Pressure Control	
145462	42-102056-26	Dual Pressure Control	
145461	42-102056-27	Dual Pressure Control	
145460	42-102056-28	Dual Pressure Control	
160008	42-102069-01	Pressure Switch Assembly	
162413	42-102070-14	Pressure Switch Assembly	
127334	42-103193-01	Dual Pressure Control	
089690	42-24194-01	Pressure Switch	
091194	42-24194-82	Pressure Control	
080580	42-24195-03	Pressure Control, for UGRA UGFD 90RS 90RT	
135420	42-24195-81	Pressure Control, 0.50" WC	
080915	42-24196-81	Pressure Control, For UGRA UGFD 90RS	
083251	42-24196-82	Pressure Control	
083259	42-24196-83	Pressure Control	
081061	42-24196-84	Pressure Control	
082670	42-24197-01	Dual Pressure Control, -0.80" & -1.30" WC	
141506	47-103670-06	Low Pressure Control	
031417	47-21604-03	Pressure Switch	
138441	SP20313	Pressure Switch	

Ignition Controls & Other Boards

Control Boards

Part #	Mfg #	Description	Price
129524	47-100436-02	Control Board for X-13 Motor	
115784	47-102090-82	Control Board for UARL	
163875	47-102090-93	Control Board Kit - Communicating	
186557	47-102077-03	Control Board - ECM	
129219	62-102635-81	Control Board	
110554	62-102636-01	Integrated Furnace Control Board	
133313	62-102860-01	Integrated Control Board	
127527	62-103189-01	Integrated Furnace Control Board	
145473	62-103565-01	Integrated Furnace Control Board	

Ruud Heating & AC Repair Parts

**Ignition Controls & Other Boards
(Continued)
Control Boards**

Part #	Mfg #	Description	Price
145475	62-103578-01	Inducer Control Board	
160036	62-104058-02	Integrated Furnace Control Board	
162408	62-104059-01	Integrated Furnace Control Board	
173548	62-104061-03	Integrated Furnace Control Board	
150560	62-23599-05	Integrated Furnace Control Board	
081759	62-24140-04	Integrated Furnace Control Board Direct Spark	
093116	62-24174-02	Modulating Control Board	
082900	62-24268-03	Hot Surface Igniter and Integrated Furnace Control	
115091	62-25338-01	Control Board	
071437	62-42506-02	Integrated Furnace Control Board	
033177	62-25341-81	Integrated Furnace Control Board	

Fan Control Board



47-22827-83

Part #	Mfg #	Description	Price
009374	47-22445-01	Fan Control Board	
009386	47-22827-83	Fan Control Board	
009378	47-22481-81	Fan Control Board	

Ignition Module



Part #	Mfg #	Description	Price
127446	620044	5059-134 Ignition Module White-Rodgers 24V Intermittent Pilot Ignition	

Ignition Control



Part #	Mfg #	Description	Price
086472	62-24181-01	Ignition Control/Direct Spark Ignition	

**Ignition Controls & Other Boards
(Continued)
Ignition Control**

Part #	Mfg #	Description	Price
053123	62-25078-02	Ignition Control	

Igniters & Flame Sensors

Igniters



Part #	Mfg #	Description	Price
145476	62-103541-01	Hot Surface Igniter	
009550	62-21747-02	Igniter	
009563	62-22669-92	Igniter	
009574	62-22868-93	Igniter	
051183	62-23556-03	Igniter	
137901	62-23556-08	Direct Spark Igniter	
137712	62-23556-10	Igniter	
119752	62-23556-82	Igniter	
051711	62-24141-04	Direct Spark Ignition (DSI)	
160039	62-24141-05	Direct Spark Ignition (DSI)	
042260	62-24164-01	Direct Spark Ignition (DSI)	
166512	SP20794	NG Igniter with Gasket and Mounting Screws	

Flame Sensor



Part #	Mfg #	Description	Price
009582	62-23543-01	Flame Sensor Rod, 2-1/2"L Mnt Flg to Sensor Tip 1-9/16"L Sensor Offset 90° Angle Sensor Offset	
051177	62-23543-02	Flame Sensor Rod, 2-1/16"L Mnt Flg to Sensor Tip 1-13/16"L Sensor Offset 90° Angle Sensor	
128886	62-23543-06	Flame Sensor	
036437	62-24044-71	Non-Integrated w/ Mnt Brackets for Ribbon & Inshot Style Burners & 62-23543-01 Igniter	
141681	SP15129	Flame Sensor with Gasket and Mounting Screw	
144183	SP20172	Flammable Vapor Sensor Kit with Cap Plug	

Repair Parts

Ruud Heating & AC Repair Parts

Repair Parts

Heat Exchangers

Heat Exchanger

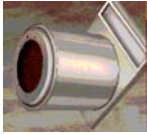

Primary

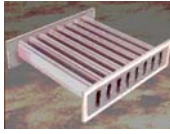

Secondary



Turbulex

Part #	Mfg #	Description	Price
142996	AS-59066-89	Heat Exchanger	
092267	AS-61805-16	Heat Exchanger Assembly	
083242	AS-61805-17	Heat Exchanger Assembly	
110398	AS-61805-20	Heat Exchanger Assembly	
093422	AS-61849-16	Heat Exchanger	

Traps & Connectors

Vent Transition

Part #	Mfg #	Description	Price
080464	68-24047-10	Vent Transition	

Condensate Trap Assembly



Part #	Mfg #	Description	Price
009615	68-24048-01	Condensate Trap Assembly	
080873	68-100651-01	Trap Assembly for UGRK	
021617	68-24021-01	Pipe-Outlet Air	
160002	68-104346-01	Condensate Drain	

Vent Termination Kit

• For gas furnace



Part #	Mfg #	Description	Price
135776	SP20245	Concentric Vent Termination Kit for 3" PVC	

Connection/Transition

Part #	Mfg #	Description	Price
025662	68-24047-08	Connection/Transition	
125740	68-103061-01	Connection/Transition Assy	

Trap



Part #	Mfg #	Description	Price
009603	68-22732-01	PVC Trap	
020322	68-24120-01	Horizontal Trap	

Trap Assembly Connector

Part #	Mfg #	Description	Price
022339	68-24047-07	Trap Assembly Connector	
022340	68-24047-09	Trap Assembly Connector	

Furnace Accessories

Gas Valve Conversion Kit

Part #	Mfg #	Description	Price
031644	60-21193-02	White Rodgers 36E Series LP to Natural Gas Kit	
166053	60-22513-04	Honeywell VR8205 Series Natural Gas to LP	
031639	60-23430-03	Robertshaw 7200 Series LP to Natural Gas Kit	
058453	FP-15	Conversion Kit NAT/LPG	
151024	FP-31	HK LP Conversion Kit	
158962	FP-33	JC LP Conversion Kit for 1-Stage	
158963	FP-34	LP Conversion Kit for 2-Stage	
177590	FP-36	JR LP Conversion Kit for 1-Stage	
185112	FP-37	LP Conversion Kit	
158961	RXGY-ZK	Zero Clearance Downflow Conversion Kit	

Filter Cores

Filter Core

Part #	Mfg #	Description	Price
149940	83-F48	Filter Core	
149943	83-H48	Filter Core	
149941	83-W48	Filter Core	
149942	83-W100	Filter Core	

Ruud Heating & AC Repair Parts

Solid Furnace Bottoms



Part #	Mfg #	Description	Price
073627	AE-61874-01	AE-61874-01 Solid Bottom 14"	
022627	AE-61874-02	AE-61874-02 Solid Bottom 17"	
022628	AE-61874-03	AE-61874-03 Solid Bottom 21"	
073628	AE-61874-04	AE-61874-04 Solid Bottom 24"	

Pilots & Orifices

Orifice



Part #	Mfg #	Description	Price
049438	62-22175-50	Orifice	

Pilot



Part #	Mfg #	Description	Price
009572	62-22864-82	Pilot	

Pilot Burner



Part #	Mfg #	Description	Price
038148	62-21609-01	Pilot Burner	

Pilot Orifice



Part #	Mfg #	Description	Price
009543	62-21489-01	Pilot Orifice	
009545	62-21612-02	Pilot Orifice	
009548	62-21743-05	Pilot Orifice	
009552	62-21883-01	Pilot Orifice	

Pilot Safety



Part #	Mfg #	Description	Price
009540	62-21426-02	Pilot Safety	

Pilot Sensor



Part #	Mfg #	Description	Price
009549	62-21744-01	Pilot Sensor	
160037	62-23543-08	Flame Sensor	

Drain Pans

Drain Pan

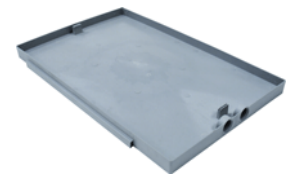

Part #	Mfg #	Description	Price
229624	68-101805-81	14" 4-Row Drain Pan	
159621	68-101805-82	17" Drain Pan Vertical 6 Row	

Door Switches

Door Switch



42-21268-04

Part #	Mfg #	Description	Price
050499	42-21268-04	Door Switch	
123748	42-22692-06	Push Button Door Switch	
125543	42-22692-09	Door Switch	
160012	42-22692-10	Door Switch	

Repair Parts

Ruud Heating & AC Repair Parts

Repair Parts

Burners

Part #	Mfg #	Description	Price
035443	75-22840-02	Burner Tube - Inshot	
028110	75-24001-01	Burner Head Kit	
061420	AS-60993-03	Burner Halves Assembly	
103698	AS-60993-06	Burner	
043357	AS-61984-04	UGRA 1-Pc Burner	
043358	AS-61984-05	UGRA 1-Pc Burner	
043359	AS-61984-06	UGRA 1-Pc Burner	
043360	AS-61984-07	UGRA 1-Pc Burner	
043361	AS-61984-08	UGRA 1-Pc Burner	

Burner Support

Part #	Mfg #	Description	Price
111992	AE-61809-15	Burner Support	
109627	AE-61809-12	Burner Support	

Anti-Vibration Pads

EVA Anti-Vibration Pad

- 2"x2"x7/8"



Part #	Mfg #	Description	Price
156821	864011	2"x2" Anti-Vibration Pad	
156822	864013	4"x4" Anti-Vibration Pad	

Miscellaneous

Blower Parts

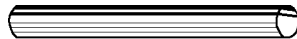

Part #	Mfg #	Description	Price
102437	70-42540-04	1" Shaft	

Choke



Part #	Mfg #	Description	Price
053006	46-23585-01	Power Factor Choke	
052335	46-24256-02	Power Factor Choke	

Tubing



Part #	Mfg #	Description	Price
020713	79-21491-83	Silicone Tubing	
162989	79-24182-83	Santoprene Tubing, 31-1/2"L, 2 Hose Clamps	

Sheath Heater Kit

Part #	Mfg #	Description	Price
037996	AS-58386-92	Sheath Heater Kit 3.5kW	

Solenoid Assembly

Part #	Mfg #	Description	Price
044160	61-25055-08	24V Solenoid Assembly	

Bearing



Part #	Mfg #	Description	Price
097430	70-41854-02	Ball Bearing With Lock	

OEM Neoprene Gasket

- Suitable for temperature range of -70° to 250°F
- Meets UL94HFI and UL94HBF flammability tests



Part #	Mfg #	Description	Price
059148	68-22079-81	1-1/8"W 25'L 5/16" Thick	

Replacement Parts and Accessories

Part #	Mfg #	Description	Price
111991	AE-61913-02	Overtemperature Switch Bracket	
145536	SP14410	Piezo Igniter with Bracket	
160006	68-104446-01	Parts Bag	
162200	45-22980-05	Button Plug	
107681	1000	FAST-STAT Wire Extender	
161388	AS-58922-01	Turbulator	

Ruud Heating & AC Repair Parts

**Replacement Parts and Accessories
(Continued)**

Part #	Mfg #	Description	Price
168203	6231	Cold Weather Kit - GEN15ADC-E, GEN16AD-E, GEN20AD-E	

Repair Parts

Ruud Heating & AC Repair Parts

Ruud Accessories

RXCT - Expansion Valve Conversion Kit

- Use to convert RCBA indoor coils to RCGA/RCGJ/RCHA and RCHJ coils



Part #	Mfg #	Description	Price
132107	RXCT-FBA	R410 Universal TXV Repl Kit	
133834	RXCT-EBA	TXV R22 Universal 2 Ton	
132108	RXCT-FBB	R410 Univ TXV Repl Kit	
132109	RXCT-FBC	Expansion Valve Kit	
132110	RXCT-FBD	TXV Universal Kit	

Controls

Part #	Mfg #	Description	Price
173851	RXAB-A07	High Pressure Control	
173850	RXAC-A07	Low Pressure Control	
130488	RXRZ-C02	Low Ambient Control	

RXGF - Media Air Cleaner



Part #	Mfg #	Outside Dimensions	Price
132422	RXGF-CB	Bottom Mount 24-1/4"W x 28-1/4"L x 3-1/2"H	
020727	RXGF-CC	Top Mount Filter Rack - Gas Downflow	
158964	RXGF-CD	Side Return Filter Rack - Gas Upflow	

External Filter Rack

- Upflow - Electric
- Duct configuration: Through
- Air opening inlet/outlet: 15-3/4" x 19-1/2"
- Housing overall: 17-1/2" x 21" x 3-5/8"
- Hinged door - opening on 17-1/2" side
- Replacement media dimensions: 16" x 20"



Part #	Mfg #	Description	Price
147301	RXHF-17	External Filter Rack - Electric Upflow	

RXMG - Label Kit

Part #	Mfg #	Description	Price
105390	RXMG-AU	Ruud Label Kit	
127216	RXMG-AY	WeatherKing Label Kit	

RXBH - Heater Kit



Part #	Mfg #	Description	Price
133645	RXBH-1724A18J	18kW 208-230/1/60	

Repair & Replacement Parts

Drain Trap

Part #	Mfg #	Description	Price
125544	791000	Tubing Drain Trap	
125548	791001	Tubing Drain Trap	

Fan Blade Puller

Part #	Mfg #	Description	Price
149962	UP-1	Fan Blade Blower Wheel Puller	

Gas Valve



Part #	Mfg #	Description	Price
009506	60-22525-03	Gas Valve	
009507	60-22525-04	Gas Valve	
145471	60-102787-01	Gas Valve	
009508	60-22525-05	Gas Valve	

Ignition Control



Part #	Mfg #	Description	Price
034342	62-24084-82	Ignition Control Board	



Ruud Heating & AC Repair Parts

Igniter



Part #	Mfg #	Description	Price
137361	AP14698B	NG Igniter Assembly	
137360	AP14700B	LP Igniter Assembly	

Vent Damper



Part #	Mfg #	Description	Price
145411	AP15561	Vent Damper	

Repair Parts



Furnace Accessories

Ruud Furnaces Accessories RXGP - Twinning Kit

Part #	Mfg #	Description	Price
138545	RXGP-F03	For Use w/Gas Furnaces for Parallel Operations	

ERV/HRV - Vent Termination Kit

Part #	Mfg #	Description	Price
155994	84-ERVHRV	HEPA Vent Termination	

RXGY - Vent Termination Kit

- For gas furnace

Part #	Mfg #	Description	Price
087666	RXGY-G01	Horizontal Vent Termination for 3" PVC	
097398	RXGY-G02	Horizontal Vent Termination for 2" PVC	
158960	RXGY-CK	Downflow/Horizontal Conversion Kit	
155961	RXGY-ZK	Zero Clearance Downflow Conversion Kit	

RXPF - Fossil Fuel Kit

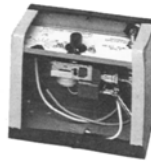

Part #	Mfg #	Description	Price
032692	RXPF-F01	Fossil Fuel Kit - Standard	

RXRY - Filter Kit

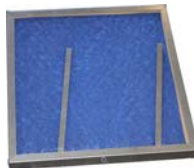

Part #	Mfg #	Description	Price
085898	RXRY-B01	For Vertical or Horizontal Discharge in RQKA & RQMA	

Furnace Repair & Replacement Parts Conversion Kit - NG - LPG

Part #	Mfg #	Description	Price
025489	FP-02	Nat-LP Conversion Kit	
058453	FP-15	Nat-LP Conversion Kit	

Furnace Repair & Replacement Parts (Continued)

Conversion Kit - NG - LPG

Part #	Mfg #	Description	Price
100705	FP-21	Nat-LP Conversion Kit	
121685	FP-26	Nat-LP Conversion Kit	
129578	FP-27	Nat-LP Conversion Kit	
074120	60-21193-01	Nat-LP Conversion Kit	
083260	60-22513-03	Nat-LP Conversion Kit	
031641	60-23430-01	Nat-LP Conversion Kit	

Repair Parts

Ruud Heating & AC Repair Parts

Motors

Motor Mount - Flex Bracket

- Torsion flex bracket



Part #	Mfg #	Description	Price
139342	DMB-3	Fits 5-1/2" Diameter Motors	

Multiple Horsepower Blower Motor

- Reversing plugs
- Extended thru bolts
- 36 inch leads
- Designed for 370 volt capacitors.
- Installs with all 48 mounting brackets.



Part #	Mfg #	Description	Price
198034	WG840463	1/6-1/2 HP-FLA 115V Blower Motor	
198035	WG840464	1/6-1/2 HP-FLA 208-230V Blower Motor	
198036	WG840466	1/5-3/4 HP-FLA 115V Blower Motor	
198037	WG840467	1/5-3/4 HP-FLA 208-230V Blower Motor	

Multiple Horsepower Condenser Fan Motors

- Reversing plugs
- Extended thru bolts
- 36 inch leads
- Designed for 370 volt capacitors
- Installs with all 48 frame mounting brackets.



Part #	Mfg #	Description	Price
198038	WG840465	1/6-1/3 HP-FLA 208-230V Condenser Fan Motor	
198039	WG840468	1/5-1/2 HP-FLA 208-230V Condenser Fan Motor	
198040	WG840469	1/6-1/2 HP-FLA 208-230V Condenser Fan Motor	

Direct Drive Furnace Blower Motors

- Installed with standard 48 frame mounting brackets
- Quiet operator and electrically reversible
- Automatic Thermal Overload Protector
- Class B insulation
- 30in. leads and 60 HZ with low power consumption
- Standard 48 frame motor casing size
- Drain holes with plugs on both end plates
- Continuous air over
- 60 C Ambient Design with Extended Studs.



Part #	Mfg #	Description	Price
198021	WG840583	1/4 HP 4.6 FLA 115V Blower Motor	
198022	WG840584	1/4 HP 2.2FLA 208/230V Blower Motor	
198023	WG840585	1/3 HP 6.7 FLA 115V Blower Motor	
198024	WG840586	1/3 HP 2.9 FLA 208/230V Blower Motor	
198025	WG840587	1/2 HP 10.2 FLA 115V Blower Motor	
198026	WG840588	1/2 HP 5.0 FLA 208/230V Blower Motor	
198027	WG840589	3/4 HP 11.3 FLA 115V Blower Motor	
198028	WG840590	3/4 HP 5.4 FLA 208/230V Blower Motor	
206600	WG840595	1HP 12.6 FLA 115V Blower Motor	

Single Speed Condenser Fan Motors

- Installs with all standard 48 frame mounting brackets
- Quiet operator and electrically reversible
- Includes Automatic Thermal Overload Protector
- Class B insulation
- 370V Capacitor
- Standard 48 frame motor casing size
- 2.5in. diameter hub rings included.



Part #	Mfg #	Description	Price
198029	WG840727	1/6 HP 1.3 FLA 208/230V Condenser Fan Motor	



Ruud Heating & AC Repair Parts

Motors (Continued)

Single Speed Condenser Fan Motors

Part #	Mfg #	Description	Price
198030	WG840728	1/4 HP 2.2 FLA 208/230V Condenser Fan Motor	
198031	WG840729	1/3 HP 2.8 FLA 208/230V Condenser Fan Motor	
198032	WG840730	1/2 HP 4.2 FLA 208/230V Condenser Fan Motor	
198033	WG840731	3/4 HP 4.5 FLA 208/230V Condenser Fan Motor	

Repair Parts

Water Right Repair Parts

Installation Fittings

Part #	Mfg #	Description	Price
126558	CV-3007	1" PVC Male NPT 90° Assembly	
066030	CV-3007-02	1" Brass Sweat Assembly	
066031	CV-3007-03	3/4" Brass Sweat Assembly	
134871	CV-3007-12	3/4" Shark Bite Assembly	
129386	CV-3150	Split Ring	

Replacement Parts

Part #	Mfg #	Description	Price
075129	CH1072-01	18" dia Salt Grid with 4" Hole	
073577	FP-60049	Plastic Bypass Assembly	
074255	CS-1448-RS	35 gal Replacement Membrane for WRO035	

Accessories

Part #	Mfg #	Description	Price
101608	HT-5B	Water-Right Hardness Kit	
113671	FP60066	Brine Valve Water-Right	
148693	CU7002	Water Sample Bottle	
150670	RO12N	1.5# Softener Rust Out	
099934	VA-2	Better Air Gap	

Watts Regulator Repair Parts

Dielectric Union Kits

3000 Series Dielectric Union Gasket Kit

Part #	Mfg #	Model	Size	Price
030973	0881401	GAB KIT	3/4"	
030972	0881402	GAC KIT	1"	
030971	0881403	GAD KIT	1-1/4"	
030970	0881404	GAE KIT	1-1/2"	
030969	0881405	GAF KIT	2"	

Repair Parts

Weil McLain Repair Parts

Weil-McLain Boiler Parts & Components

Part #	Mfg.#	Description	For	Price
110792	382-200-449	Conversion Kit, NG, from Cycle Pilot System to Gold control HSI		
011885	382-930-216	10C523 Igniter Kit	VHE, HE II	
076751	383-500-345	Repair Plug Kit		
128037	383-500-603	(5) Ultra U-Control Module Fuses, 3A, Fast-Blow AG	F1	
145731	383-500-604	(5) Ultra U-Control Module Fuses, 12A, Slow-Blow AG	F2	
129778	383-500-622	Heat Exchanger Replacement Kit	230	
129779	383-500-623	Heat Exchanger Replacement Kit	310	
128030	383-600-069	Low Water Cut-Off		
076395	389-900-203	WMCR-3 3 Zone Circulator Control		
045038	389-900-205	6 Zone Circulator Control		
138955	389-900-206	WMZV-4 4 Zone Valve Control		
136985	389-900-220	BCP-3 Hydronic Multi-Stage Boiler Control Panel		
011893	510-218-099	10C034 Tridicator Gauge, 2-1/2" Short Shank	GV, GO, CG Prior to Jan 2000	
101982	510-300-014	210°C Spill Switch with Reset	CG Sect/Base Series 1-12	
127719	510-312-015	High Limit Temperature Control	HE II, HE, VHE	
011899	510-312-166	10C053 Combination 120/24V Transformer-Relay Receptacle	CG, AHE, EGH, HE II, HE, PFG	
116334	510-312-218	Outdoor Temp Sensor		
038133	510-312-250	10C055 Limit Control & 1/2" Well	CG, CGm, EGH, PFG	
021051	510-312-312	10C567 Blower Motor Assembly	HE II, HE	
011904	510-312-317	10C579 Motor Repl Kit	VHE	
011909	510-350-223	10C072 Control Relay, DPST 24V	AHE, CG, EG, EGH, HEII, PFG	
032886	510-811-221	Pilot Assembly NG		
032887	510-811-222	Pilot Assembly Propane		
011913	510-811-362	NG-LP Conversion Kit	CG 25 - 6	
107651	510-811-502	24V Combination Ignition-Sensing Control Module		
022497	510-811-644	Pilot Assembly Kit		
011922	510-811-655	10C528 NG Valve	HE, HEII, VHE	
011923	510-811-656	10C529 Step Open LP Gas Valve	HE, HEII, VHE	
044138	511-044-382	Gas Valve 3/4" x 3/4" NG 10C489		
078890	511-114-479	63m Low Water Cut-off		
078891	511-114-526	w/McLain LWCO 150smd M&M 17180 672619142831		
059929	511-330-081	LP Pilot Burner Assembly		
011934	511-330-095	Ignition Module 10C486	CG, EG, EGH, PFG	
019926	511-330-184	Igniter Only 10C455	HE/VHE	
011943	511-330-186	Pilot Burner Assembly		
011944	511-330-192	Flame Sensor 10C188	HE, VHE	
011945	511-330-197	Pilot Burner	E38-2 24V	
073640	511-330-218	Pin Pilot Burner 10C481	CG	
064739	511-330-221	Pilot Burner Assembly with Ignition Lead and Orifice PSE-NA16		
011947	511-624-510	Switch .95 Pressure Switch 3-5 2, 000'-4, 000' 10C213	HE	
011948	511-624-514	Pressure Switch 51.2 Pressure Switch VHE 2000'-4000' 10C215		
074480	511-724-259	Thermopile for EG-75		
038426	511-724-274	Main Flame Sensor		
011956	512-050-230	Thermal Fuse 10C257	CG, EG, HE, PFG, VHE	
056344	512-200-000	Steel Burner Tube		

Repair Parts

Weil McLain Repair Parts

Weil-McLain Boiler Parts & Components (Continued)

Repair Parts

Part #	Mfg.#	Description	For	Price
056346	512-200-001	Steel Burner Tube with Bracket		
118676	512-200-035	Burner	HE VHE CGI	
011958	512-200-045	Pilot Burner 10B867		
127431	540-131-052	X100 Sentinel Corrosion Inhibitor Kit		
127432	540-131-053	X100 Sentinel Corrosion Inhibitor Kit		
127433	540-131-054	X100 Sentinel Corrosion Inhibitor Kit		
011968	560-742-860	Pilot Tubing		
020911	590-317-610	Blower Gasket		
015274	590-735-140	1/2" x 100" Glass Rope 10B985		
086820	591-200-000	Cover Plate Gasket/Insulation		
114285	591-706-200	Heat Exchanger Cleaning Tool		
011981	591-706-214	Flue Brush 11B146		
011985	592-800-011	2" Square Cut Seal		
127434	592-900-002	Sentinel X-100 Corrosion Inhibitor Concentrate		
127632	592-900-003	X400 Cleaner		
059875	633-900-102	Thermostat with Cover Plate Kit for Plus Water Heaters		
094665	633-900-130	Gold Plus Thermostat Kit		
011986	635-100-010	Kit Thermostat Plus		

Vent Damper

Part #	Mfg.#	Description	Price
019945	381-800-474	4" Vent Damper	
019946	381-800-475	10C081 5" Vent Damper for EG30/35	
019944	381-800-476	6" Damper Assembly CGM,EG	
019947	381-800-477	7" Damper Assembly CGM,EG,PFG	
030770	381-800-478	10C478 8" Vent Damper for EG65/75	

CGa Series Accessories

Part #	Mfg.#	Description	For	Price
146736	381-357-313	Pilot less Ignition for Natural Gas Boilers	CGa-8	
049683	450-021-245	CGa-7 Draft Hood Vertical		
032392	450-021-246	CGa-8 Draft Hood Vertical		
050610	512-200-077	CGa Main Stainless Steel Burner Tube		
065995	512-200-079	CGa Stainless Steel Burner with Pilot Bracket LP		

CGi Series Accessories

Part #	Mfg.#	Description	For	Price
058742	511-330-090	Control Module with 10 Second Pre-purge		
064887	510-312-167	Transformer		
059928	511-330-080	Pilot Assembly Kit NG		

Weil McLain Repair Parts

CGm Series Accessories

Part #	Mfg.#	Description	For	Price
041152	511-044-256	NG Valve	CGm 7-8	

CGs Series Accessories

Part #	Mfg.#	Description	For	Price
017582	311-103-818	Intermediate Section Assembly		
059940	381-356-499	Inducer Fan Assembly Kit		

CGt Series Accessories

Part #	Mfg.#	Description	For	Price
112055	380-000-000	Combination Pressure-Temperature Gauge Kit, 60° - 360°F	CGt Series	

PFG Series Accessories

Part #	Mfg.#	Description	For	Price
011912	510-512-337	Vent Damper Motor Operator		
024710	511-044-287	NG Control Valve, 1" x 1" NPT	PFG	

Ultra Series Accessories

Part #	Mfg.#	Description	For	Price
109058	383-500-021	Time Delay/Relay Box		
066027	383-500-025	Gas Valve Kit	Ultra 155	
066028	383-500-030	Gas Valve/Venturi Kit	Ultra 230	
066022	383-500-035	Blower Assembly	Ultra 155	
066024	383-500-040	Blower Assembly	Ultra 230	
066039	383-500-045	Ignition Electrode Kit	Ultra 80 & 105	
066042	383-500-055	Flue Temperature Sensor Replacement Kit		
066040	383-500-085	Burner Replacement Kit	Ultra 155	
130501	383-500-095	Watts #330 300 psi Pressure Relief Valve, ASME		
120566	383-500-105	3" Vent Termination Bird Screen	Ultra 80, 105, & 155	
105545	383-500-110	4" Vent Termination Bird Screen	Ultra 230 & 310	
066021	383-500-125	Outdoor Temperature Sensor		
066016	383-500-190	Ultra Control Module	Ultra 80, 105, 155, & 233	
066017	383-500-195	115VAC / 24VAC, 50-60Hz, 50 VA Honeywell Transformer		
066020	383-500-200	Honeywell Display Board & Bracket Assembly		
093857	383-500-210	Pressure/Temperature Gauge Assembly		
143606	383-500-235	5 Amp Fast-Blow Fuses	Circulator Circuit 5/Pk	
143607	383-500-240	4 Amp Slow-Blow Fuses	24-Volt Circuit 5/Pk	
086818	383-500-250	Cover Plate Gasket/Insulation	Ultra 155, 230, & 310	
086819	383-500-255	Cover Plate Gasket	Ultra 155, 230, & 310	
074417	383-500-360	Blower Assembly Kit	Ultra 310	
074418	383-500-390	Gas Valve/Venturi Kit	Ultra 310	
133205	383-500-395	Cover Plate Replacement Kit	Ultra 155 & 230	
116337	383-500-408	Display Board/Bracket Assembly	Ultra 155/230	
121565	383-500-600	Flue Temperature Sensor Replacement Kit		
116333	383-500-601	System Temperature Sensors		

Weil McLain Repair Parts

Weil-McLain Boiler Parts & Components (Continued) Ultra Series Accessories

Repair Parts

Part #	Mfg.#	Description	For	Price
116331	383-500-602	Return/Supply Sensor Kit, (1) Sensor		
120435	383-500-605	Maintenance Kit	Ultra 80 and 105	
120436	383-500-620	Maintenance Kit	Ultra 155, 230, 299, & 399	
129776	383-500-621	Heat Exchanger Kit	Ultra 155	
120152	383-500-628	120V/24V Transformer		
133206	383-500-630	Pressure/Temperature Gauge Assembly		
130577	383-500-649	Ultra Easy-Up Manifold Kit, 1-1/4" Piping	UG 80 & 105	
133204	383-500-650	Blower Assembly Kit	Ultra 399	
133203	383-500-652	Gas Valve Kit	Ultra 399	
127630	383-500-658	Control Module		
127885	383-500-659	Display Board Assembly		
130578	383-500-661	Ultra Easy-Up Manifold Kit, 1-1/2" Piping	UG 155-399	
074410	383-501-027	Blower Assembly Kit	Ultra 80 & 105	
074411	383-501-029	Gas Valve/Venturi Kit	Ultra 80	
074413	383-501-030	Gas Valve/Venturi Kit	Ultra 105	
125176	511-100-005	LWCO with Harness & Test Button		
090744	511-405-133	Taco 0014 Boiler Circulator, less Flanges	Ultra 155, 230, & 310	
107709	590-317-310	Gasket Cork		

Ultra Commercial Series Accessories

Part #	Mfg.#	Description	For	Price
127629	383-600-065	Watts 174A 80 psi Relief Valve, 3/4" x 3/4", 1,400 mbh Capacity		
143176	383-600-079	Maintenance Kit		

WM97+ Series Accessories

Part #	Mfg.#	Description	For	Price
146863	383-700-113	Igniter, Gasket and Screw	WM97+ 70 & 110	
146859	383-700-139	Ignition Control	WM97+ 70 & 110	
146870	383-700-157	Piping Assembly Blower & Clip	WM97+ 70 & 110	
146871	383-700-159	Piping Assembly Gas Valve	WM97+ 70	
146872	383-700-160	Piping Assembly Gas Valve	WM97+ 110	
146860	511-724-292	Flue Sensor	WM97+ 70 & 110	
146861	511-724-296	Water Temperature Sensor	WM97+ 70 & 110	
146864	511-802-015	50VA Transformer	WM97+ 70 & 110	

GV Series Accessories

Part #	Mfg.#	Description	For	Price
011874	382-200-325	Burner Replacement Kit	GV4 & GV90+4	
011875	382-200-330	Burner Replacement Kit	GV5 & GV90+5	
011877	382-200-340	Blower Assembly		
011878	382-200-345	Blower Motor Kit 10C380		
011879	382-200-350	Vent 90 10C387		
011881	382-200-375	Switch Kit 10C403	GV90	

Weil McLain Repair Parts

Weil-McLain Boiler Parts & Components (Continued) GV Series Accessories

Part #	Mfg.#	Description	For	Price
011882	382-200-385	Hose Trap Kit		
030451	382-200-410	Boiler Gas Valve 10C399		
065429	382-200-411	Gas Valve Kit GV Series 4		
043582	382-200-448	Ignition Control Module (GV Series 1,2&3) 10C400		
011896	510-312-019	10C411 Limit Control		
050453	510-312-021	Limit Control w/1/2" Well	GV Ser 1, 2, 3 Sect Assy	
011941	511-330-148	Ignition Kit 10C402		
011949	511-624-520	Pressure Switch 10C382	GV	
011955	511-842-370	Transformer 10C401	GV	

EG/EGH Series Accessories

Part #	Mfg.#	Description	For	Price
035079	381-800-677	EG75 SPDN Boiler Water Trim No Tankless Option		
035078	381-800-675	EGH-30 to 65 Water Trim		
011892	510-218-097	10C526 Tridicator, 2-1/2" Long Shank	EG Series 1-4 Section Base Assy	
074482	511-724-255	36" Thermocouple with Spade Terminal Block	EG 75, EGH 85 & 95	
011966	560-528-985	LP Gas Pilot Orifice		
074479	590-850-561	5" Lead Wire	EG 75	

Sentinel Series Accessories

Part #	Mfg #	Description	Price
127435	592-900-005	Sentinel X100 Quik Test Kit	

Ultra Oil Accessories

Part #	Mfg #	Description	Price
066035	383-500-300	Water Temperature Sensor Kit	
066012	389-900-180	Wall Mount Kit	

Repair Parts

Westinghouse/Philco Repair Parts

Repair Parts

Blower Wheels

Part #	Mfg #	Description	Price
119974	667207	10-3/4" x 10", CW	
119975	667251	10" x 6", CW	
119976	667258R	11" x 8", CCWLE	
119977	667280	11" x 10", CCW	
119979	667374	11" x 8", CW	

Burners

Part #	Mfg #	Description	Price
134174	660921	Burner L1	
134173	661128	Inshot Burner G7T	

Capacitors

Part #	Mfg #	Description	Price
146433	01-0024	10mfd, 370V Round Capacitor	
119928	622135	15mfd, 370V Round Motor Capacitor	
136994	622545	10mfd, 370V Round Capacitor	

Contactors

Part #	Mfg #	Description	Price
139778	621661	25A, 1-Pole	
139779	621662	35A, 1-Pole	

Control Boards

Part #	Mfg #	Description	Price
133371	904531	Board All Units	
129223	920915	Control Board G7	
130336	920916	Control Board G7	
128774	920920	Board Direct Torque	

Control Modules

Part #	Mfg #	Description	Price
139792	624651	Comfort Alert Module New	
120743	903106	Control Module for G4 G5 G6 Models	

Defrost Boards

Part #	Mfg #	Description	Price
147380	920338	Defrost Board Adaptive	

Door Switches

Part #	Mfg #	Description	Price
119950	632125	Door Switch	

Fan Blades

Part #	Mfg #	Description	Price
139796	667261	Fan Blade	
139797	667318	Fan Blade f/S3QC Series 3 Ton Only	
139784	667319	Fan Blade 2 Blade 24 OD 27p CW 1/2 1200	
139783	667351	Fan Blade 2 Blade 24 OD 25p CW 1/2	
139798	667383	24" CW 3W 20° Fan Blade	

Flame Sensors

Part #	Mfg #	Description	Price
120728	903600	Flame Sensor (old #632396)	

Igniters

Part #	Mfg #	Description	Price
120726	903758	Replacement Igniter Kit	
134164	921074	Igniter Replacement Kit G7/GC2	
119987	904839	Igniter Assembly for G7 (New# Is 921074)	

Limit Controls

Part #	Mfg #	Description	Price
120741	626350	Vent Limit 260°F	
120733	626418	Limit 150/20°F	
120735	626419	Limit 195/20°F	
120736	626425	Limit 210/20°F	
120734	626434	3" Limit 180/20°F	
120749	626435	Limit 220/20°F	
120737	626449	3" Limit 250/20°F	
120744	626461	Vent Limit 160°F	
136184	626522	Main Limit Switch	
119934	626541	Switch Blower Limit G7	
119941	626561	Main Air Limit G7	
119945	626563	Main Air Limit G7	
145504	626598	Main Air Limit SD054, 072	
144772	626599	Limit Switch 1/2d,1s, or 16	
145498	626611	Blower Limit KG7SD	

Westinghouse/Philco Repair Parts

Lineset Fittings

Part #	Mfg #	Description	Price
131551	664378	Liquid Lineset Fitting	

Motors

Part #	Mfg #	Description	Price
139793	621952	A/C Fan Motor	
139795	621917	Fan Motor for FS3BA048	
139794	621919	PSC K 1/10 6p 1-Spd CWLE Fan Motor	
139788	622018	PSC 1/4 hp CWLE Fan Motor for 15 SEER	
139782	622066	PSC K 1/4 hp CWLE 6p 1-Spd Fan Motor	
139781	622080	1/4 hp CWLE Fan Motor	
139780	622171	.05 hp CWLE 2 Ton Motor	
130637	622264	Blower Motor 1/2hp 3-Spd	
143885	904502	Motor 1/3 3-Spd 115V	
120723	903111	Venter Motor 80% With Gasket	
134163	903962	Venter Motor w/Gasket	
134161	904085	Venter Motor GL1RC	
135437	903404	Inducer Motor	
119983	904796	Inducer Motor G7	
119985	904798	Inducer Motor G7	
119991	904857	Blower Motor G7	
119992	904858	Blower Motor G7	
119993	904859	Blower Motor G7	
119994	904860	Blower Motor G7	
141161	921651	3/4 hp High Efficiency Blower	

Orifices

Part #	Mfg #	Description	Price
149071	664067	Orifice #67	
149073	664071	Orifice #71	

Pressure Switches

Part #	Mfg #	Description	Price
120746	632302	Pressure Switch Vent for G6D	
139791	632393	Low Pressure Switch 39" (5CO-20CI) 632393	
120780	632444	Pressure Switch NO 1.75 Close 1.55 Open	
139785	632473	High Pressure Switch	
119953	632484	Sensor Flame G7	
119954	632487	Pressure Switch	
119955	632489	Pressure Switch G7	

Pressure Switches (Continued)

Part #	Mfg #	Description	Price
119956	632491	Pressure Switch Condensate G7	
119958	632493	Pressure Switch Inducer G7	
119960	632499	Pressure Switch G7	
119961	632514	Pressure Switch G7 Variable Speed Downflow	
119962	632515	Pressure Switch G7 Variable Speed Downflow	
119963	632516	Pressure Switch	
119966	632521	Pressure Switch G7	
134165	632546	Pressure Switch Inducer 1.0 for FG7TC	
134168	632547	Pressure Switch G7 Fixed Condensate	
134166	632548	Pressure Switch	
134167	632550	Pressure Switch G7	
134169	632554	Pressure Switch	
130948	632561	Pressure Switch for Fg7	
130950	632563	Pressure Switch for Fg7	
130951	632565	Pressure Switch for Fg7	
130952	632567	Pressure Switch for Fg7	
130953	632594	Pressure Switch 40 Close .20 Open Long Run for iQ Furnace	
122723	632571	Pressure Switch G7	
134010	632585	Pressure Switch	
145499	632622	Pressure Switch for M7	
145500	632624	Pressure Switch for M7	

Relays

Part #	Mfg #	Description	Price
139790	621931	Relay Blower	

Restrictors

Part #	Mfg #	Description	Price
149069	664048	1.5T Restrictor .048	
149070	664056	2T Restrictor .056	
149072	664061	2.5T Restrictor .061	
149074	664076	4T Restrictor .076	

Roll-out Switches

Part #	Mfg #	Description	Price
120731	626343	Switch Roll-out 300f	
119938	626558	Roll-out Switch G7	
119939	626559	Roll-out Switch G7	
119940	626560	Roll-out Switch G7	

Repair Parts

Westinghouse/Philco Repair Parts

Repair Parts

Roll-out Switches (Continued)

Part #	Mfg #	Description	Price
145497	626609	Roll-out Switch SD038	
145505	626610	Roll-out Switch SD054,072	

Transformers

Part #	Mfg #	Description	Price
134170	622341	Transformer 40VA/120/24	
134175	622396	Transformer 60 VA for 23 SEER Coil	

Tubing

Part #	Mfg #	Description	Price
119925	263967	High Temperature Tubing 3/16 36" Long	

Valves

Gas Valve

Part #	Mfg #	Description	Price
119930	624652	Gas Valve 2-Stage for TC TI G7	
130954	624703	Gas Valve for iQ Furnace	
143845	624787	Gas Valve 2-Stage for Fg7	
143844	904081	Gas Valve	
144173	921691	Gas Valve Kit with Harness	

Service Valves

Part #	Mfg #	Description	Price
139777	663862	Valve Liquid 3/8"	
139786	663864	Valve Suction 3/4" for FS5BD18-36	
133428	663963	Valve Ball 7/8" for FS4BD48-60, FT4B42-6	

TXV Valves

Part #	Mfg #	Description	Price
134244	669681	TXV for C6BAX24	
134245	669682	TXV for C6BAX30	
134246	669683	TXV for C6BAX35 And 36	
134247	669684	TXV for C6BAX42	
134250	669686	TXV for C6BAX60	
134249	669852	TXV R-410A 4.0 Ton	

Parts & Repair

Part #	Mfg #	Description	Price
119951	632261	3 Amp Fuse	

Parts & Repair (Continued)

Part #	Mfg #	Description	Price
119952	632269	5 Amp Fuse	
119981	664435	Drain Assy Upflow/Inline	
145506	664659	PVC Trap KG7SD	
134162	904573	Inducer for 95% With Gasket	
119986	904799	Blower Kit Inducer G7 Var Sp Downflow	
134073	904945	Repair Kit for G7 2-Stage 90%	
143415	904986	Replacement Parts Kit	
130955	904800	Induced Draft Blower FG7MQ	
131416	920994	Blower Control, Cons CFM, Vs Downflow	



Woodford Repair Parts

Yard Hydrant Repair Parts

Part #	Mfg #	Description	Price
011648	10009	Upper Link for Y34/Y1/Y2	
011649	10011	Reducing Coupling for Y1/Y2/Y34/W34	
011658	10100	Packing Nut for Y1/Y2/Y34/W34	
011659	10101	Packing for Y1/Y2/Y34/W34	
011660	10102	Packing Support Washer for Y1/Y2/Y34/W34	
011662	10104	Brass Rod Stem for Y1/Y2/Y34/W34	
011678	15003	3/4 Head Assembly	

Nozzle

Part #	Mfg #	Description	Price
011646	10004	3/4" Brass Hose Nozzle for Y34/Y1/W34/X34/R34	
098547	55437	Nozzle for 70/71/B71/81	

Plunger

Part #	Mfg #	Description	Price
011663	10105	Plunger for Y30/Y34/Y70/Y95/W34	
011664	10106	Plunger for Y1/Y2	

Thermaline® Repair Parts

Thermaline® Parts

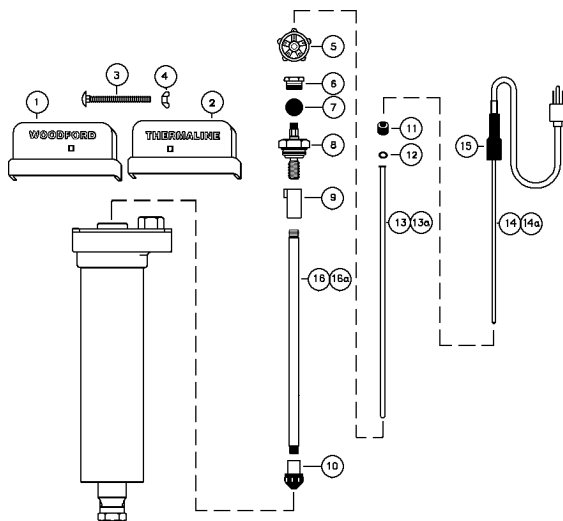

Part #	Mfg #	Description	Price
011747	85015	10 - Combination Valve Ass'y	

Thermaline® Repair Parts (Continued)

Thermaline® Parts

Part #	Mfg #	Description	Price
011748	85062	14 - 2' Heater Assembly (Includes Item 15)	

Repair Kits

Repair Kit for 14/18 Wall Faucet

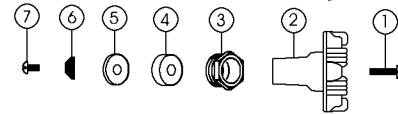
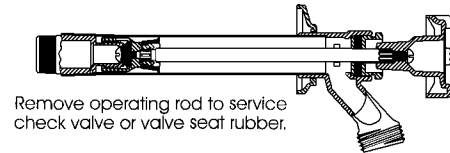

Part #	Mfg #	Description	Price
034143	RK14-MH	Repair Kit for 14/18 Includes 1-7, Metal Hdl	

Repair Kit for 17 Wall Faucet

- | | | | |
|----------|--------------|-----------|-------------------|
| 1. 35301 | VB Float Kit | 6. 30421 | Packing Washer |
| 2. 30002 | Handle Screw | 7. 30418 | Check Valve |
| 3. 30099 | Handle | 8. 30008 | Valve Seat Rubber |
| 4. 30059 | Packing Nut | 9. 30009 | Retainer Screw |
| 5. 30005 | Packing | 10. 30459 | Bevel Check Valve |

Remove operating rod to service check valve or valve seat rubber.

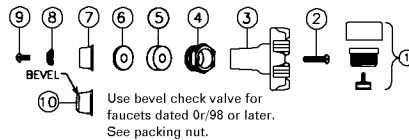

Part #	Mfg #	Description	Price
039455	RK-17	Repair Kit for 17 Includes 1-2, 4-10, 30099 Metal Hdl	

Woodford Repair Parts

Repair Parts

Repair Kit for 22 Wall Faucet

1. 30566 Hot Plug Button
2. 30002 Handle Screw (2)
3. 30096 Round, Die Cast Alum. Wheel Handle (2)
4. 30497 Deep Packing Nut
5. 30560 EPDM Packing (2)
6. 30006 Packing Washer (2)
7. 30565 Cold Plug Button
8. 30059 Packing Nut
9. 30459 Check Valve (2)
10. 30008 Valve Seat Rubber (2)
11. 30009 Retainer Screw (2)

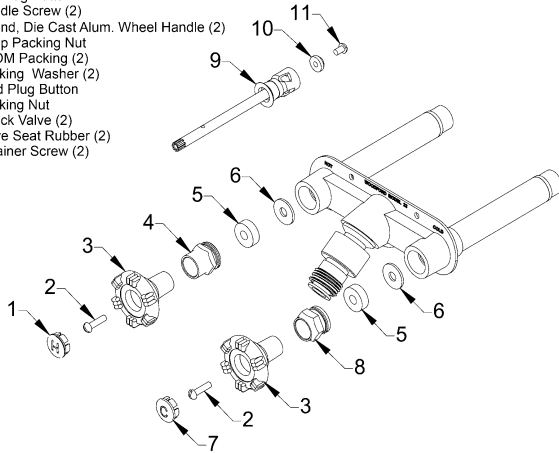

Part #	Mfg #	Description	Price
100876	RK-22MH	Repair Kit for 22 w/Metal Handle	

Repair Kit for 25/27H Wall Faucet

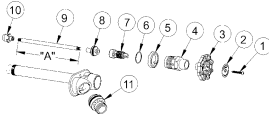

Part #	Mfg #	Description	Price
032340	RK-25	Wheel Handle Repair 5/16" Square Shank	

Repair Kit for 65 Wall Hydrant

- | | |
|----------------------|---------------------|
| 1. 50009 Tee Key | 5. 50251 "C" Washer |
| 2. 50264 Head Nut | 6. 51014 Yoke Nut |
| 3. 50252 Stem Washer | 7. 50250 Plunger |
| 4. 55062 Stem Screw | |

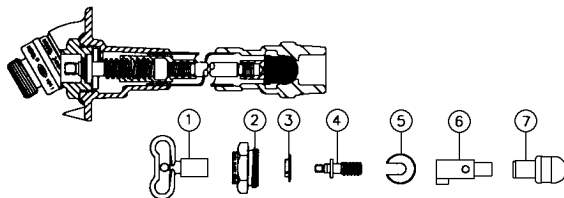

Part #	Mfg #	Description	Price
043118	RK-65	Chrome Repair Kit for 60/65/67 Includes 1-7	

Repair Kit for 70 Wall Hydrant

- | | |
|-------------------------|----------------------------|
| 1. 50009 Tee key | 6. 50027 Support Washer |
| 2. 30109 Packing Nut | 7. 51013 Ball Valve Rubber |
| 3. 30247 Packing | 8. 50028 Round Brass Nut |
| 4. 55177 Head Nut Assy. | |
| 5. 51014 Yoke Nut | |

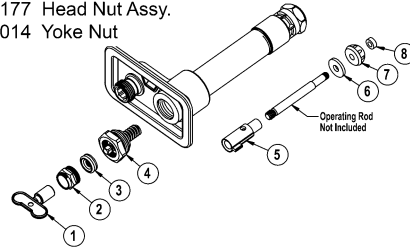

Part #	Mfg #	Description	Price
055079	RK-70	Repair Kit for 70 & Obsolete Models 7/8/80/85/90/95	

Repair Kit for Y34 Yard Hydrant

- | | |
|----------------------|-------------------------|
| 1. 10104 Rod Stem | 4. 10102 Support Washer |
| 2. 10100 Packing Nut | 5. 10105 Plunger |
| 3. 10101 Packing | |

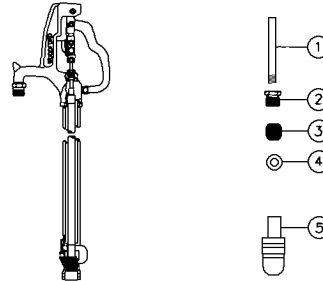

Part #	Mfg #	Description	Price
046472	RK-Y34	Includes 1-5	

Individual Parts



WF-MS

Part #	Mfg #	Description	Price
025782	30008	Rubber Valve Seat	
025786	30109	Chrome Packing Nut	
011710	30230	Plunger Assembly for 25	
011712	30238	Stem Screw Delrin for 25	
011716	35280	Drain Valve Assembly for 20/25/27	
011723	50250	Plunger for All Auto Drain Hydrants	
019019	50251	"C" Washer All Auto Drain Hydrants	
024447	50252	Stem Washer for All Auto Drain Hydrants	
011726	51014	Yoke Nut for All Freezeless Wall Hydrants	



Woodford Repair Parts

Individual Parts (Continued)

Part #	Mfg #	Description	Price
011725	51013	Ball Valve Rubber	
112487	RH-MS	Roof Hydrant Mounting System	
116915	WF-MS	Mounting Sleeve for Models: 14, 16, 17 & 19	

Handle



30096

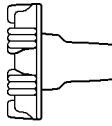

30099

Part #	Mfg #	Description	Price
054339	30096	14/17 Metal Wheel Handle	
011708	30099	14/17/22 Metal Wheel Handle	
095886	30106	24 Unplated Metal Handle	
011711	30233	24 Brown Lexan Wheel Handle	
022301	30239	25 2" Metal Wheel Handle	

Operating Rod Assembly

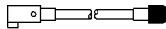

Part #	Mfg #	Description	Price
019023	55412	12" Operating Rod Assembly for Auto Drain (14-5/16" OAL)	

Packing



Part #	Mfg #	Description	Price
072390	30512	Packing Nut with Stem Gd for 14/17	
080502	30560	EPDM Packing for 14/17/22	

Rod Assembly

Part #	Mfg #	Description	Price
043133	35722	8" Wall Rod Assembly for 14/ 17/22/V22	
043888	WH35724	12" Wall Rod Assembly for 14/17/22/V22	

Tee Key



RK-STK

Part #	Mfg #	Description	Price
011719	RK-STK	Tee Key, 1-3/4" Short for 5/16" Square Stem (50009)	
011720	RK-LTK	3-1/4" Long Tee Key for Square Stem (50010)	

Repair Parts

Zoeller Repair Parts

Repair Parts

Parts & Accessories

Gasket



Part #	Mfg #	Description	Price
052983	267007	Gasket - Case/Cover	

Switch Assembly



004705

Part #	Mfg #	Description	Price
028971	004705	M53/98/72 Switch Assembly "50"	
052675	004892	ASM Rack Pk "50/90"AH	



W A T E R

C O N C E P T S

Professional Plumbing Showroom

11 Locations Across Iowa

Ames Des Moines Iowa City
Cedar Rapids Fort Dodge Ottumwa
Waterloo Davenport Mason City
Spirit Lake Waukee

Consultations by Appointment

For more information please visit
www.waterconcepts.net

“Two Great Traditions Combined”



www.plumbsupply.com
www.facebook.com/PlumbSupplyCompany

Corporate Office
515-262-9511
1622 NE 51st Ave
Des Moines, IA 50313